



Aalborg Universitet

AALBORG UNIVERSITY
DENMARK

Low frequency sound field enhancement system for rectangular rooms, using multiple loudspeakers

Celestinos, Adrian

Publication date:
2007

Document Version
Publisher's PDF, also known as Version of record

[Link to publication from Aalborg University](#)

Citation for published version (APA):
Celestinos, A. (2007). *Low frequency sound field enhancement system for rectangular rooms, using multiple loudspeakers.*

General rights

Copyright and moral rights for the publications made accessible in the public portal are retained by the authors and/or other copyright owners and it is a condition of accessing publications that users recognise and abide by the legal requirements associated with these rights.

- Users may download and print one copy of any publication from the public portal for the purpose of private study or research.
- You may not further distribute the material or use it for any profit-making activity or commercial gain
- You may freely distribute the URL identifying the publication in the public portal -

Take down policy

If you believe that this document breaches copyright please contact us at vbn@aub.aau.dk providing details, and we will remove access to the work immediately and investigate your claim.

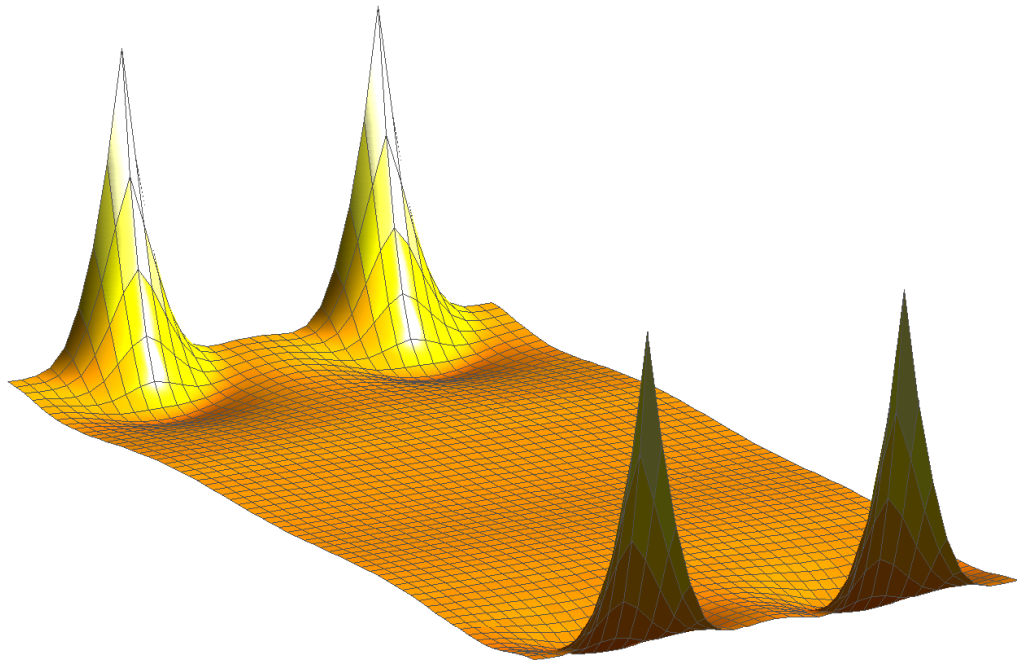

**Low frequency sound field enhancement
system for rectangular rooms,
using multiple loudspeakers**

Ph.D. thesis by

Adrian Celestinos

**Low frequency sound field enhancement
system for rectangular rooms,
using multiple loudspeakers**

by

Adrian Celestinos

Ph.D. thesis

Acoustics, Department of Electronic Systems

Aalborg University
DK-9220 Aalborg East, Denmark

Aalborg, December 2006

Preface

This thesis is submitted to the Faculty of Engineering and Science, Aalborg University in partial fulfillment of the requirements for the Ph.D. degree. This thesis is based on the work conducted at Acoustics, Department of Electronic Systems, Aalborg University during the period of September 2003 – December 2006, under the supervision of Assoc. Prof. Sofus Birkedal Nielsen. The thesis is conformed as a plurality of three convention preprints and a manuscript submitted to the *Journal of the Audio Engineering Society*. The papers are referred in the text in bold letters as **Paper A**, **Paper B**, **Paper C** and **Paper D**. In addition to the papers, the thesis consists of a general introduction, an overview of the work performed, an extra **Chapter E** and two appendixes.

During this period I was appointed as a full-time Ph.D. fellowship holder financed by the The Faculty of Engineering, Science and Medicine, at Aalborg University.

I wish to thank all the people who supported my work at Acoustics, in particular to my supervisor Sofus Birkedal Nielsen for his endless patience and his fruitful guidance. I wish to thank all my colleagues at Acoustics for the valuable comments and rich discussions. I wish to thank all the staff for maintaining an extraordinary work place, to the secretariat for their invaluable help and to the technical staff, Claus Vestergaard Skipper and Peter Dissing for their professional assistance.

Finally I wish to thank my parents for their unyielding support no matter the distance.

Adrian Celestinos
Aalborg, December 2006

Contents

Preface	i
Contents	iii
Abstract	ix
Resumé (abstract in Danish)	xi
Introduction	1
1.1 Overview	3
1.1.1 Room simulation model	3
1.1.2 Low frequency analysis in rooms	4
1.1.3 Low frequency room equalization	6
1.1.4 Uniform sound field at low frequencies	7
1.1.5 Controlled Acoustically Bass System (CABS)	8
1.2 General Results	8
1.3 Discussion	9
1.4 Summary of the Papers	12
1.5 List of Publications	14

Paper A: Multi-source low frequency room simulation using finite difference time domain approximations	15
1 INTRODUCTION	17
2 SIMULATION OF SOUND SOURCES IN A ROOM USING FDTD	18
2.1 Method	18
2.2 Boundary Conditions	19
2.3 Sound Source Model	19
3 EVALUATION OF THE SOUND FIELD IN A ROOM	20
3.1 Sound Pressure Level Distribution	20
3.2 Optimization of Used Memory	21
3.3 Visualization in Time Domain	21
3.4 Acquisition of Impulse Response	21
4 RESULTS AND VALIDATION	24
4.1 Measurements	24
4.2 Simulation	25
4.3 Comparison of simulations and real measurements	26
5 DISCUSSION	26
6 CONCLUSION	27
7 ACKNOWLEDGEMENTS	27
References	27

Paper B: Optimizing placement and equalization of multiple low frequency loudspeakers in rooms	29
1 INTRODUCTION	31
2 SIMULATION PROGRAM	32
3 QUANTITATIVE PARAMETERS	32
3.1 Magnitude Deviation	33

3.2	Spatial Deviation	33
4	ANALYSIS	33
4.1	Room Modes	34
4.2	Evaluation of Loudspeaker Configurations	34
4.3	Positioning	37
5	OPTIMIZATION STRATEGIES	37
5.1	Multiple Point Equalization	37
5.2	Equalization of Acoustic Radiation Power	38
5.3	Optimization by Modifying Delay and Phase	40
6	RESULTS	41
7	MEASUREMENTS	41
8	DISCUSSIONS	42
9	CONCLUSIONS	44
	References	44

Paper C: Low frequency sound field enhancement system for rectangular rooms using multiple low frequency loudspeakers **49**

1	INTRODUCTION	51
2	ANALYSIS OF THE SOUND FIELD ON THREE RECTANGULAR ROOMS	52
2.1	Room description	52
2.2	Sound Field Room Simulations	53
2.3	Measurements	55
3	THE EQUALIZATION SYSTEM	56
3.1	Creation of a Plane Wave	58
3.2	Removing the Reflection from the Back Wall	59
3.3	Optimal Equalization	63

4	RESULTS	63
4.1	Simulation of the Equalization System	63
4.2	Measurement of the Equalization System	63
4.3	Evaluation of the Equalization System	64
5	DISCUSSION	65
6	CONCLUSION	67
	References	68

Paper D: Controlled Acoustically Bass System (CABS), A method to achieve uniform sound field distribution at low frequencies in rectangular rooms **69**

1	INTRODUCTION	71
2	LOW FREQUENCY SOUND IN RECTANGULAR ROOMS	72
2.1	The building up of a standing wave in the time domain	72
2.2	Simulations on a three dimensional Virtual Room	74
2.3	Time and frequency analysis	75
2.4	Quantification Parameters	76
2.5	Traditional one point equalization	80
3	UNIFORM SOUND PRESSURE DISTRIBUTION IN THE ROOM	81
3.1	Construction of a Plane Wave	82
3.2	Removing the Reflection from the Back Wall	83
3.3	Controlled Acoustically Bass System (CABS)	83
3.4	Simulation of CABS in the Virtual Room	84
4	IMPLEMENTATION AND MEASUREMENT OF CABS IN REAL ROOMS	87
5	RESULTS	88
6	DISCUSSIONS	90
7	CONCLUSIONS	93

References	93
Chapter E: CABS .2.2 In An Irregular Room	95
E.1 Low Frequency Sound Fields in An Irregular Room	97
E.1.1 Partitioning of the room	97
E.1.2 Simulation of loudspeakers in an irregular room	99
E.1.3 Simulation of CABS .2.2 in an irregular room	103
E.1.4 Summary and conclusions	105
Bibliography	107
Appendix I	109
I.1 Sound Field Room Simulator	111
I.1.1 Discretization of the wave equation	111
I.1.2 Boundary conditions	114
I.1.3 Sound source	117
I.2 Implementation	119
I.2.1 Wave dispersion errors	120
I.2.2 Transfer function measurement	120
I.2.3 The walls	122
I.3 Graphical User Interface (GUI) of The Sound Field Room Simulator	122
Appendix II	129
II.1 Normal Modes of Vibration in Rooms	131

Abstract

Loudspeakers are the last link in the sound reproduction chain, and they are typically placed in small or medium size rooms. When low frequency sound is radiated by a loudspeaker the sound distribution along the room presents large deviations. This is due to the multiple reflection of sound at the rigid walls of the room. The reflected waves from the rigid walls might meet the propagating waves from the loudspeaker itself at some places in constructive phase and at some places in opposite phase. This may cause level differences of up to 20 dB in the output level of the loudspeaker at the listener position. These deviations change depending of the listener position and the loudspeaker placement. Some of these deviations are associated with the standing waves, resonances or anti resonances of the room.

The thesis contains an introduction and overview of the work done, four papers and one additional chapter. The first paper is concentrated on a simulation model based on the finite-difference time-domain method (FDTD) to predict the low frequency behavior of loudspeakers in rectangular rooms. The second paper includes the simulation of different configurations of subwoofers in a standard listening room and some equalization techniques are revised. The third paper includes simulations and measurements of the typical low frequency sound reproduction systems in rooms. Here a new method later named Controlled Acoustically Bass System (CABS) is introduced. In the last two papers of the thesis, the CABS system is simulated and implemented in two standard listening rooms. The performance of the system is evaluated by measurements both in an IEC and a ITU standard listening room. In the last paper the analysis in the time domain and frequency domain of the low frequency sound in rooms is presented. The typical one subwoofer .1 vs CABS are compared in simulations. The extra **Chapter E** concentrates on simulations of an irregular room with the FDTD method and the performance of CABS in that room. Two appendixes are added to the thesis; a more detailed description of the room simulation program is presented in appendix I, and a brief description of the room modes of vibration theory is outlined in appendix II.

The scope of the thesis and the research concerns itself with the performance of loudspeakers in rooms at low frequencies. The research concentrates on the improvement of the sound distribution in the room produced by loudspeakers at low frequencies. The

work focuses on seeing the problem as an acoustic problem in the time domain. The result of this work is the introduction of the CABS system as a novel and effective solution. The thesis discusses the implementation and the performance of CABS in two standard listening rooms and the simulations and implementation of working setups with CABS.

The methodology employed in this investigation was first to have a deep understanding of the problem. This was accomplished by analyzing the behavior of low frequency sound in rooms in the time domain. This could not be accomplished without investigating a room simulation model based in the time domain. The outcome of this work is a intuitive and effective system solution named Controlled Acoustically Bass System (CABS) that utilizes loudspeakers equidistantly placed at the front wall of the room and extra loudspeakers in anti phase at the rear wall. By using the acoustic cancellation principle, a digital pure delay and the proper gain in the rear loudspeakers, the rear reflection is canceled, giving a uniform sound distribution in the whole room approx. below 120 Hz. The working range depends on the room size and the number of loudspeakers used. The smaller the room the best CABS performs. The novelty of this solution is that differently from the advanced room correction systems that only work at a restricted listening position, CABS acquires even sound level distribution at low frequencies in the whole room with simple signal processing. The CABS system works in the time domain therefore it performs as well for transient signals as for steady signals.

By using CABS more even sound level distribution is obtained along the room. The effect of the room resonances in the reproduced sound has been decreased remarkably. Compared to the traditional one subwoofer setup that has typically standard deviations close to ± 6 dB and differences in spectral magnitude up to more than 20 dB. By using CABS in an IEC standard listening room the spatial standard deviations are reduced to ± 1.6 dB and the spectral standard deviations to ± 2.1 dB. In a ITU standard listening room the spatial standard deviations were reduced to ± 1.3 dB and the spectral standard deviations to ± 2.1 dB. CABS can be integrated to stereo or multichannel systems. Preliminary results of simulations of CABS in an irregular room have shown promising results however measurements need to be carried out to arrive at objective conclusions.

Resumé (abstract in Danish)

Højtalere anvendes til reproduktion af lyd i rum, der er her ofte tale om små og mellemstore rum. Især ved lave frekvenser vil der være meget store hørbare variationer i det frembragte lydtryk. Disse variationer skyldes i det væsentlige refleksioner fra rummets flader (vægge, gulv og loft). Reflekterede lydbølger vil blande sig med den oprindelig udsendte lydbølge fra højtaleren og vil nogle steder i rummet være i fase med hinanden og i andre steder i modfase, resulterende i variationer i lydtryk på op til 20 dB i forskellige lyttepositioner. Disse store variationer i lydtryk afhænger af såvel lyttepositionen som højtalerens placering i rummet. Nogle af variationerne skyldes stående bølger, resonansfrekvenser eller anti-resonansfrekvenser, men der vil være store variationer ved alle frekvenser.

Denne PhD afhandling består af en introduktion der tjener til at give et overblik over det udførte arbejde, der i det væsentlige er dokumenteret i 4 publikationer, bestående af 3 afholdte konference indlæg og 1 tidsskriftartikel (indleveret, men endnu ikke publiceret). Det første konferenceindlæg koncentrerer sig om konstruktionen af et simuleringsværktøj, et program baseret på finite difference time domain method (FDTD). Dette simuleringsværktøj har været nødvendigt for at skaffe viden om, hvorledes lave frekvenser fra højtalere opfører sig i rektangulære rum, der er de mest normale lytterum. Det andet konferenceindlæg indeholder simuleringer af forskellige konfigurationer af subwoofere (lavfrekvente højtalere) i et standard lytterum og nogle equaliserings teknikker er afprøvet. Det tredje konferenceindlæg inkluderer simuleringer og målinger af lavfrekvent lydgenngivelse i rum, og ny metode kaldet: Controlled Acoustically Bass System (CABS) er introduceret. I det tredje konferenceindlæg og tidsskriftartiklen er CABS verificeret ved simulering og målinger i 2 standard lytterum, henholdsvis i et IEC standard lytterum og et IUT multikanals lytterum ved Akustik på Aalborg Universitet. Resultaterne ved lave frekvenser er dokumenteret i såvel tidsdomæne som frekvensdomæne i de 2 rum. Den typiske anvendelse at n subwoofer (.1) er sammenlignet med CABS, der anvender flere højtalere. Afhandlingen indeholder 3 appendikser, hvor en mere detaljeret præsentation af det konstruerede rumsimulerings program er beskrevet i appendiks I. Simuleringen af CABS i ikke regulære rum er præsenteret i appendiks II, og en kort beskrivelse af rummodes og vibrationsteori er beskrevet i appendiks III.

Formålet og omfanget af dette PhD projekt har været at udføre forskning, der kan tjene til en bedre forståelse af hvorledes samspelet er mellem højttalere og rum ved lave frekvenser, hvor der er fundamentale problemer. Udgangspunktet for analysen og løsningen er anderledes end mere traditionelle metoder idet der her er set på problemet som et akustisk problem i tidsdomæne. Resultatet af denne analyse har ført til en effektiv løsning, der introduceres som et nyt system, af nemheds grunde kaldet CABS. Afhandlingen belyser implementeringen og anvendelsen af CABS i to lytterum, først ved simuleringer med det til formålet udviklede værktøj, og efterfølgende ved målinger i de to rum.

Den metodik, der er anvendt i dette arbejde, har været først at få en dyb forståelse for selve problemets art. Dette er sket ved at analysere hvorledes lavfrekvent lyd fordeles i rum i tidsdomæne. For at kunne foretage disse komplekse analyser har det været nødvendigt først at udvikle en rumsimulerings- model baseret på tidsdomæne analyse. En intuitiv løsning (CABS) opstod, som anvender en ækvidistant placering af højttalere ved frontvæggen og som det nye anvender ekstra højttalere i modfase ved bagvæggen. Med denne metode sker der en akustisk minimering af refleksionen fra bagvæggen når baghøjttalerne fødes med det oprindelige signal og med den rigtige forsinkelse og amplitude. Denne metode giver en ensartet fordeling af lydtrykket i hele rummet under ca. 120 Hz, afhængig af rummets størrelse, antallet af højttaler og deres placering.

Ved at anvende CABS får man et mere ensartet lydtryk i rummet. Sammenlignet med den traditionelle anvendelse af en subwoofer, der har en typisk spatial standardafvigelse tæt på ± 6 dB og en spektral standardafvigelse på ± 7.5 dB, men med udsving på over 20 dB. Ved at anvende CABS i samme IEC lytterum er den spatiale standardafvigelse reduceret til ± 1.6 dB og den spektrale standardafvigelse til ± 2.1 dB. I et ITU standard lytterum er den spatiale standardafvigelse reduceret til ± 1.3 dB og den spektrale standardafvigelse reduceret til ± 2.1 dB.

Resultatet af dette PhD-arbejde er bl.a. introduktionen af et nyt og effektivt system kaldet CABS, der i modsætning til traditionelle løsninger giver et ensartet lydtryk i et rektangulært rum ved lave frekvenser, vel og mærke i hele rummet. Effekten af rummets resonansfrekvenser i den reproducerede lyd er reduceret væsentligt. I modsætning til andre avancerede rumkorrektions-systemer, anvender CABS simple former for signalbehandling. CABS fungerer i tidsdomæne og er derfor virksom for såvel transiente signaler som for stationære signaler. Systemet kan integreres med traditionel Stereo systemer såvel som multikanals systemer. Foreløbige simuleringer af CABS i ikke rektangulære rum har vist lovende resultater, men bør udforskes nærmere.

Introduction

Since the advent of stereophony the production of music signals in high fidelity has gained the interest of researchers, professionals and a great amount of enthusiasts. With the arrival of the digital signal processing technology the popularity of new reproduction formats as multichannel surround sound has increased reasonably. From home theaters to concert hall arenas it is possible to experience sound through full-range loudspeakers or subwoofers dedicated to play back frequencies from 30 Hz to 100 Hz. The main quality of these reproduction formats is that they give to the listener a sense of space. Formats such as the traditional stereo or the multichannel surround sound are often called spatial sound reproduction systems. They are based on more than one loudspeaker which are typically placed in a living room. Other solutions that make use of Binaural technologies (also known as 3D sound) are utilized to give the correct spatial sensation to the listener¹⁶. The restriction of these solutions is the need of headphones and that the reproduction of binaural signals by loudspeakers can be achieved only for a restricted listening position and in very damped rooms. In music sound reproduction there are commonly two scenarios, in the first of which the music material is produced by acoustical instruments and voice, the second situation may be one in which the acoustic program is converted to electrical signals, recorded or mixed, amplified and reproduced through loudspeakers. This work will consider the second scenario where the program is already recorded and produced into an audio reproduction format.

In an ideal situation, for example in stereo sound reproduction, only a person positioned at the “sweet spot” will benefit by the qualities of this reproduction format, if the loudspeakers are set correctly in the room. A more realistic situation is that the loudspeakers are placed “more or less” symmetrically in the room and there will normally be more listeners sitting in different positions. This situation is common for example in movie theaters where a large listening area has to be covered. In these cases stereo reproduction may not be sufficient and another kind of format as for example the surround sound 5.1 or wave field synthesis⁶ that make use of more channels and loudspeakers might be suitable. As shown by Blauert⁴, Wightman and Kistler²⁷ and other authors the predominant cue for human sound localization at low frequencies is the inter-aural time difference (ITD) therefore localization at those frequencies is quite poor. Human sound localization in listening rooms worsens at frequencies where the wavelength is much longer than the distance be-

tween the ears. This has been the foundation to be able to mix the low frequency content of all the channels in the surround sound formats or in the stereo format to the extra .1 subwoofer when the loudspeakers are not capable of reproducing very low frequencies^{1,9}.

In the situation with the regular stereo setup with two full range loudspeakers in a room, especially at low frequencies the perceived sound will be different depending on the position of the listener in the room. These problems appear typically to loudspeakers placed in small or medium size rooms and in some cases medium size halls. Modification of the output level of the loudspeaker at the listeners ears occurs due to the multiple reflections of the sound at the walls and different objects in the sound path, as for example furniture, openings etc. These variations change depending on the position of the listener and the loudspeaker in the room. This is often problematic to control by acoustic means due to the long wavelengths involved. Mid and high frequencies involving relatively small wavelengths can be attenuated by absorptive materials but when producing wavelengths in the range of 10 to 3 meters (34 Hz – 114 Hz) the acoustic solutions become impractical. These reflections will normally produce variations from 20 dB to 30 dB in the sound distribution level along the room. Some of these variations at certain frequencies are caused by the standing waves or resonance frequencies in the room. If these resonances are strongly excited they will cause large differences in the sound pressure distribution in the room and also structural vibration of the enclosure. What can be done acoustically is to build the room with the best possible room-mode distribution, that can be achieved by choosing the right dimensions ratio. Nevertheless the room, with its physical properties and the placement of the loudspeaker, will highly influence the output level of the loudspeaker measured at the different listening positions^{11,2,3,20}.

In these cases there are two main identified problems. The first problem is for example if a bass tone is played back through the loudspeakers it might be perceived very loud at a determined listening position in the room, yet exactly the same sound would be barely heard by another listener sitting in another position in the room. The second problem is related to the variations in level at different frequencies also known as “Spectral Coloration”. For example, in a fixed listening position, some notes of a scale or a chord included in the recording, typically performed by instruments like an electric bass or an pipe organ will not be heard as loud as some other notes that will be perceived louder, or “booming”.

The strategy followed in this work was to get a deep understanding of the problem and assimilate it as a physical phenomenon. To do that it was decided to investigate and implement a room simulation model based on an element method. This approach led to the use of the acoustic cancellation principle. Differently from other solutions, results have shown that the sound pressure level distribution along the room can be improved significantly from having deviations in the sound field below 100 Hz of typically ± 12 dB to ± 3 dB.

1.1 Overview

In the following sections an overview of the project is outlined. Relevant aspects of the work are presented, the room simulation model, the low frequency analysis in rooms, room equalization systems, how to achieve uniform sound field distribution at low frequencies, and finally a brief description of the outcome of this research.

1.1.1 Room simulation model

Generally the problem of low frequency sound in rooms has been widely analyzed by solving the linear lossless wave equation for the propagation of sound in fluids (Kinsler et al.¹²). In this fashion a rectangular room with rigid walls is assumed where the normal component of the particle velocity gets very close to zero. These well-known formulations called *modal decomposition techniques* are mainly based on the complex sound pressure in steady-state (Morse and Ingard¹⁷).

Differently in this research work it was decided to inspect the problem by a model in which it was possible to track down the sound pressure in the room as a function of time. Other methods based on geometrical acoustics such as the Mirror Image model or Ray Tracing, are no longer sufficient when the wavelength is comparable with the dimensions of the room⁵. In this work a computer simulation program based on an element method was developed and described in the **Paper A** of this thesis. The simulation program is based on the finite-difference time-domain method (FDTD)^{24,7,23,22,13}. This model also begins by solving the linear lossless wave equation but in addition it applies the relation between the particle velocity and the acoustic pressure. This second equation is known as the linear inviscid force equation valid for acoustic processes of small amplitude¹². The main difference with other methods is that both equations (lossless wave equation and force equation) calculate particle velocity and pressure as a function of time. In this fashion these two equations are utilized to compute the acoustic pressure produced by a number of sound sources in the entire enclosure (see Appendix I.1 for more details about the discretization processes and solution of the mathematical expressions of the method). With this program written in MATLAB the sound field produced by multiple loudspeakers in a rectangular room can be simulated. Moreover irregular rooms can also be modeled as presented in **Chapter E** of this thesis.

The advantage of the FDTD method is that it works in the time domain and therefore the pressure amplitude and the particle velocity is always available for analysis or visualization purposes. Besides that the impulse response of the transfer function at desired positions in the room can be obtained. With other methods like the finite element method (FEM) or the boundary element method (BEM) it is possible to obtain the complex sound pressure level at the boundaries or within defined regions in the room but the time history not always is available. Typically in these methods each discrete frequency has to be calculated

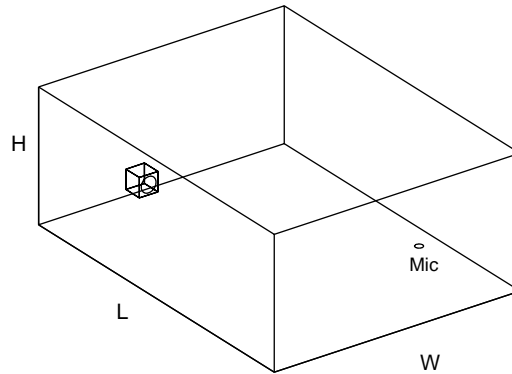

Figure 1.1: A room of 100 m^3 volume with dimensions $W=5.3\text{ m}$, $L=7\text{ m}$ and $H=2.7\text{ m}$ suggested by the standard BS.6840-13⁸, loudspeaker and microphone position.

separately. If the analysis is needed in a wide range of frequencies the simulation time increases considerably.

The main disadvantage of the FDTD method is the limited frequency range where accurate results can be achieved. It is well known that, at frequencies where the number of cells per wavelength is lower than ten, wave dispersion errors occur. This limitation implies the use of a huge amount of memory for simulating large spaces (see Fig.I.14 in Appendix I.1). Another limitation is that in reality the wall reflections are frequency dependent and this is difficult to implement on a FDTD scheme (Botteldooren⁷). However as shown by Olesen¹⁸ assumptions can be made and good results can be achieved in simulations of relatively small spaces at low frequencies. Although the FDTD method is a “brute force” approach and has a limited frequency range for accurate simulations, it has been decided to make use of it after the results obtained in **Paper A**. Simulations show good agreement with measurements in an IEC standard listening room.

1.1.2 Low frequency analysis in rooms

In this work the understanding of the physical phenomena at low frequencies when a room is excited by sound sources is presented. When acoustic energy is confined in an enclosed space, as for example a room, a number of phenomena occur. If the wavelength of the radiated sound is much longer than the largest dimension of the room, there is a frequency below which the only propagating wave form that can exist is a plane wave¹².

As explained in the introduction the multiple reflections with the walls of these front waves produced by the loudspeaker will form large deviations in sound pressure level within the room. Some of these patterns are very distinct and well-known as *standing waves*, *reso-*

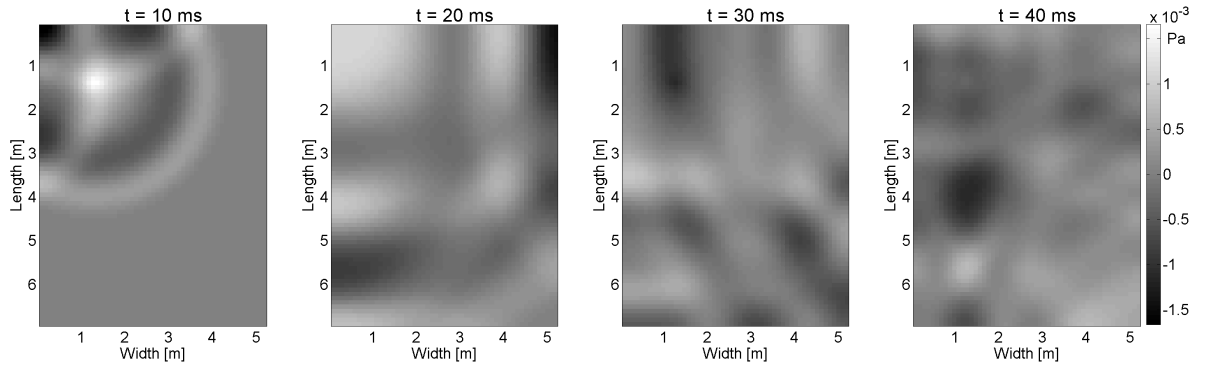

Figure 1.2: Sequence of snapshots in time from left to right of the instantaneous pressure produced by the loudspeaker in the room shown in Fig. 1.1.

nance frequencies or the *normal modes* of vibration of the enclosure when the dimensions correspond to multiples of half of the wavelength, and when the dimensions correspond to an odd multiple of one quarter of the wavelength the associated frequencies are called *anti-resonances* or *anti-modal frequencies*. In **Paper D**, with the use of the simulation program described in **Paper A**, the analysis in the time domain of the formation of these patterns is given (see Fig. 1 and Fig. 2 in **Paper D**). In addition, the derivation of the normal modes of vibration in an enclosure from the conventional solution to the wave equation is presented in Appendix II.1.

The deviations in the sound pressure level distribution within the room will appear not only at the modal or anti-modal frequencies but also at frequencies where the wavelengths are long enough to be comparable to the dimensions of the room. Generally, for example, there will always be a minimum in sound pressure level at a distance corresponding to one quarter of a wavelength from a reflecting wall, since the reflected wave and the arriving wave will always be in opposite phase.

To give an idea of the problem simulations of a loudspeaker placed in the room sketched in Figure 1.1 are presented in Figure 1.2. In this sequence of pictures of the pressure amplitude at discrete times, the interaction of the waves with the walls can be observed forming the deviations in the sound field distribution. The building up of these deviations can be originated even with quite short transients sounds. This can be inferred by observing the Cumulative Spectral Decay (CSD) introduced in **Paper C** and **Paper D** and shown in Figure 1.3. The CSD performs a joint analysis in frequency and time. The CSD is calculated over an impulse response. From this observation it is clear that in small and medium size rooms the resonance frequencies keep ringing in time longer than the others. In more damped rooms those frequencies do not necessarily keep ringing in time. However there are still spectral deviations in the early part of the impulse response (see Fig. 4 and Fig. 7 in **Paper C**).

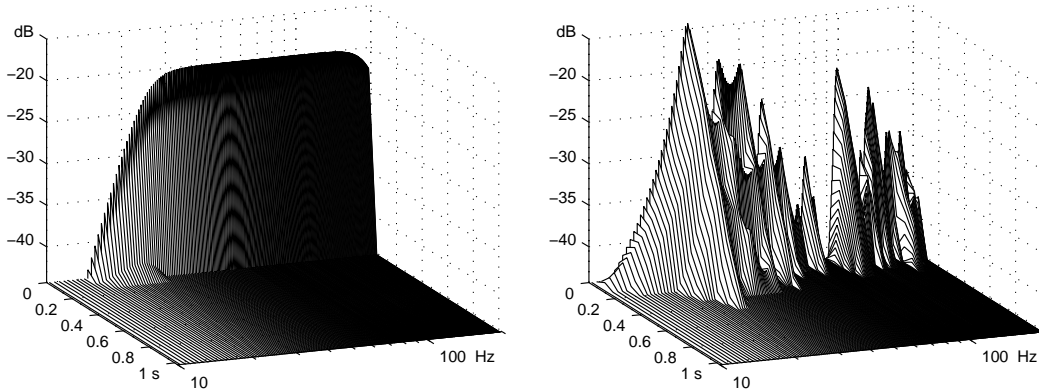

Figure 1.3: Cumulative spectral decay (CSD). Left, Loudspeaker measured in anechoic conditions. Right, The same loudspeaker measured at the “Mic” position in the room shown in Figure 1.1.

When low frequency sound is produced by a loudspeaker in a room there are two main problems. The first is related to the deviations in sound pressure level as a function of listening position and the second is related to the spectral deviations at a specific listening position in the room. In **Paper D** a new parameter named the *Mean Sound Field Deviation (MSFD)* is introduced. With the *MSFD* the two main problems are quantified. The first problem associated with the deviations in sound level at one specific frequency at different places of the room is represented by the Spatial Deviation *SD*. The second problem, represented by the Magnitude Deviation *MD*, is identified at individual listening positions and describes the deviations in sound level within a range of frequencies between 20 Hz to 100 Hz. In this fashion the *MSFD* is calculated along a listening area defined by microphone positions equally spaced in the room.

In **Paper D** another quantifier that operates in the time domain is presented. The parameter originally called in German “Deutlichkeit” *D* (translated to english as *Definition*) mainly used in Room Acoustics is utilized to quantify the influence of the room at a number of microphone positions. *Definition* gives a criterion of the ratio of energy between the early part of the impulse response (0 – 50 ms) and the remaining part²⁵.

1.1.3 Low frequency room equalization

After having written a reliable simulation program a number of approaches have been studied. As learned from the literature in order to deal with this problem several approaches have been investigated by a number of authors. Over the last three decades Groh¹¹, Allison², Ballagh³ (among others) have based their approaches on finding the optimum placement of the loudspeakers in the room. More recently Welti and Devantier²⁶

have based their investigation on the use of multiple subwoofers with different configurations in the room. Another approach by Abildgaard¹⁹ is based on the control of the acoustic radiation power of the loudspeaker in a room. Large amount of research has been carried out with the approach of designing the correct electrical filters commonly called *Room Correction* systems to compensate for the negative effect of the room. Mäkivirta et al.¹⁵ has conducted research on the approach called *Modal Equalization* and Elliott and Wilson¹⁰ have worked on the technique named *Multiple Point Equalization*. These filters are called “electrical filters” because they are included in a dedicated digital signal processor (DSP) or apparatus connected before the loudspeaker and the amplifier. These systems need a microphone to measure the output level of the loudspeaker in the room or what is often called the “response” of the loudspeaker at a listening position. This transfer function includes the effects of the loudspeaker and the room at this specific position. Then by means of adaptive digital techniques the effects are compensated for at this specific listening position in the room.

As shown by Welti and Devantier²⁶ the addition of more loudspeakers carrying the same signal and positioned at the mid points of each wall improves the problem related with the spatial variations in sound pressure level. But on the other hand the deviations in level along frequency increase considerably (see Fig. 4 in **Paper B**). This was verified in the **Paper B** of this work where six configurations of subwoofers are simulated utilizing the simulation program described in the **Paper A**. In fact in one of these configurations of four subwoofers at the mid points of the walls a decrement of the overall power is observed (see configuration LP4 in Fig. 4 in **Paper B**). After these results the configuration with less spatial deviations was chosen in order to implement three different methods for optimizing the low frequency sound field. The multiple point equalization and the equalization of the acoustic radiation power near the loudspeakers are simulated. After implementing these two types of equalization one can summarize that these methods partially alleviate the problem. In a study conducted by Santillán et al.²¹ an equalization system based on the simulation of a plane wave traveling in a small room as in a free field is presented. In this approach 20 loudspeakers baffled in one of the walls and another 20 in the opposite wall were utilized. In order to acquire the correct filter for each loudspeaker the transfer function from each loudspeaker to each of the number of points at the listening planes are needed (about 2880 impulse response measurements).

1.1.4 Uniform sound field at low frequencies

The main goal in this work is to improve the low frequency sound field produced by a loudspeaker in a rectangular room. As explained before the cause of the large deviations in sound pressure level is the reflections at the walls, and therefore to avoid the problem one should cancel those reflections. But as shown in Figure 1.2 there are multiple reflections, hence an elegant way of simplifying the problem is to cancel only the first reflection because then only the direct sound would exist. This can be done by forming plane waves in one

end of the room traveling in only one direction towards the opposite wall. Where the sound will be canceled by using extra loudspeakers with a delayed version of the signal in anti-phase and with the correct gain. This is verified in **Paper D** by the simulation of two loudspeakers in a rectangular room, positioned equidistantly in the front wall (see Fig. 26. in **Paper D**). Then the rear wall is rendered as an opening instead of a rigid wall. One can verify that the sound pressure level distribution is even over a large part of the room and that this can be achieved up to frequencies where the distribution of the front loudspeakers enables a plane wave front to be built. In the case where the loudspeakers are not able to build a plane wave more loudspeakers would be needed. However at those frequencies it is possible to attenuate these interferences by optimizing the placement of the loudspeakers (see Sections 3.1 and 3.4 in **Paper D**).

1.1.5 Controlled Acoustically Bass System (CABS)

In contrast to the traditional equalization methods a different approach is presented in this work. The name Controlled Acoustically Bass System (CABS) is first introduced in **Paper D**. The system consists of the use of loudspeakers at the front wall of the room and extra loudspeakers at the opposite wall in order to cancel the back wall reflection. These extra loudspeakers are fed with the same signal as the front loudspeakers including a delay according to the traveling distance in the direction of the plane wave to the back wall, see the block diagram in Fig. 28 of **Paper D**. In addition to the delay the gain of the extra loudspeakers has to be adjusted due to the traveling distance and the damping characteristics of the room. Together with CABS the following notation is introduced:

.F.B

F stands for the number of low frequency loudspeakers (e.g. subwoofers) positioned at the front wall.

B stands for the number of low frequency loudspeakers (e.g. subwoofers) positioned at the back wall.

1.2 General Results

The system CABS .2.2 was implemented in a PC using a real-time signal-processing software and an AD/DA multichannel converter. The parameters of the system were adjusted empirically to achieve the best performance. The system was measured in two standard listening rooms, the IEC Room and the ITU Room both at the Acoustics Laboratory at

Aalborg University. The general results are presented in Table 1.1 and Table 1.2 respectively. In the IEC Room the spatial deviations of the sound field at 25 positions improved by 6 dB, and the spectral deviations were enhanced by 8.6 dB. In the ITU Room the spatial deviations improved 5.8 dB and the spectral deviations have shown an improvement of 6.4 dB. For more details of the outcome refer to Section 4.3 in **Paper C** and Section 5 in **Paper D**.

Table 1.1: Results of improvement in measurements of CABS .2.2 at the listening area in the IEC Room from 20 Hz to 100 Hz.

	<i>MSFD</i>		<i>Definition</i>
	<i>SD</i> (dB)	<i>MD</i> (dB)	<i>D</i>
IEC Room	± 4.6	± 6.4	66.8 %
.2.0	± 4.6	± 6.4	66.8 %
CABS .2.2	± 1.6	± 2.1	92.4 %
Improvement	6 dB	8.6 dB	25.6 %

Table 1.2: Results of improvement in measurements of CABS .2.2 at the listening area in the ITU Room from 20 Hz to 90 Hz.

	<i>MSFD</i>		<i>Definition</i>
	<i>SD</i> (dB)	<i>MD</i> (dB)	<i>D</i>
ITU Room	± 4.2	± 5.3	64.3 %
.2.0	± 4.2	± 5.3	64.3 %
CABS .2.2	± 1.3	± 2.1	89.4 %
Improvement	5.8 dB	6.4 dB	25.1 %

1.3 Discussion

To summarize, in this work a deep understanding of the behavior of low frequency sound in rooms has been acquired. First the investigation of a room simulation model based on the wave equation in the time domain has been conducted. Some of the well known equalization methods have been simulated. Finally, the outcome of this work is an effective system solution named CABS that, independently from the traditional solutions, tackles the problem in an effective manner.

The advantages of CABS are:

- More even sound level distribution below 100 Hz is achieved throughout the room.
- The effect of the room resonances in the reproduced sound is decreased considerably.
- Only simple signal processing is needed.

- The system works in the time domain and therefore is sufficient for transient signals and for steady signals.
- Once adjusted, it works independently of the program material that is reproduced.
- The system can be integrated into stereo or multichannel systems. Informal listening of music signals with CABS .2.2 integrated into full-range loudspeakers in a stereo setup have shown remarkable results.
- Preliminary results of simulations of CABS .2.2 in irregular rooms have shown promising results however measurements need to be carried out to get to objective conclusions (see **Chapter E**).
- The working frequency range of the system extends as the room size decreases. The smaller the room the fewer loudspeakers needed. CABS .2.2 could be applied to sound reproduction systems in small enclosures (e.g. automobiles, small music studios).

The main drawbacks are:

- More loudspeakers and power amplifiers are needed. All the loudspeakers have to have the same phase and frequency response, or individual equalization is needed.
- The optimal placement of the loudspeakers might not be ideal for commercial applications of the system.
- A detriment of 3 dB in the output power exists as a consequence of the acoustic removal of one of the walls.
- Wide rooms might need more loudspeakers. Nevertheless the working frequency range can be improved by optimizing the placement of the loudspeakers (see Fig. 39 in Section 3.4 of **Paper D**).
- In a stereo setup or a multichannel setup the low frequency content of all channels has to be collected to only one channel, the CABS .2.2.
- If the temperature changes drastically in the room the delay must be re-adjusted.
- The system must include a low-pass filter to attenuate frequencies above the working range.
- The system has been simulated and measured in empty rooms and no furniture has been included. Furniture might decrease the effectiveness of the system.

Further investigations:

Further investigations may be conducted on the implementation of CABS on dedicated signal processing hardware that could automatically adjust the parameters to give the best performance. Measurements of CABS in existing living rooms with furniture, openings and listeners could be conducted as further research on this project. In this work only informal listening tests have been performed using CABS .2.2 integrated into a stereo setup. Further investigations may be directed towards conducting listening experiments in order to subjectively compare CABS with the standard formats. Another subject of interest is the feasibility of integrating CABS into other spatial reproduction formats as for example 3D sound.

1.4 Summary of the Papers

Paper A

Multi-source low frequency room simulation using finite difference time domain approximations

In this paper a simulation model written in MATLAB for the study of low frequencies in audio reproduction such as ordinary stereo to multi-channel surround setups is described. Simulations of multiple loudspeakers in a rectangular room are carried out to evaluate and visualize their coupling with the room. Three kind of transfer functions are described. First by using a Gaussian Pulse, second by using the MLS method and third by using a near field impulse response of an existing loudspeaker. Two cases are simulated, first a closed-box loudspeaker and second, two closed-box loudspeakers positioned in a stereo setup. The simulations are compared to measurements in the existing room showing good agreement.

Paper B

Optimizing placement and equalization of multiple low frequency loudspeakers in rooms

A brief analysis of the characteristics of the room modes in rectangular rooms is given. Six configurations of subwoofers are simulated utilizing the simulation program described in **Paper A**. Three methods of equalization are simulated utilizing one of the configurations with four subwoofers: The so-called multiple point equalization, the equalization of the acoustic radiation power near the loudspeakers and the new method later named CABS. The last method is implemented and measured in the IEC standard listening room at Aalborg University.

Paper C

Low frequency sound field enhancement system for rectangular rooms using multiple low frequency loudspeakers

Simulations of common sound-reproduction systems utilized in three different rooms are presented. The chosen rooms are an IEC standard listening room, a ITU multichannel listening room and a small concert hall. The description of the new method later called CABS is given as well as results of simulations of the system on individual frequencies. The

new method is simulated in the three rooms. Results of the performance of CABS after measurements in the actual rooms are presented. A discussion about the performance in the three rooms is given.

Paper D

Controlled Acoustically Bass System (CABS), A Method to Achieve Uniform Sound Field Distribution at Low Frequencies inside Rectangular Rooms

A detailed analysis in the time domain of low frequency sound in rooms is presented. Simulations of a typical subwoofer in a rectangular room are given. A new parameter called the mean sound field deviation (*MSFD*), utilized to quantify the deviations of the sound field in a defined area, is introduced. Simulations of a room with an opening instead of the back wall and two loudspeakers positioned at the front wall are presented. The new method, Controlled Acoustically Bass System or CABS is formally introduced and explained thoroughly. Results of the performance in simulations and measurements of CABS both in an IEC and a ITU standard listening room are presented as well as discussions and conclusion.

1.5 List of Publications

Paper A

“Multi-source low frequency room simulation using finite difference time domain approximations,” A. Celestinos and S. B. Nielsen, presented at the 117th Convention of the Audio Engineering Society, *Journal of the Audio Engineering Society (Abstracts)*, vol. 53 pp. 105–106 (January/February 2005), convention preprint 6264.

Paper B

“Optimizing placement and equalization of multiple low frequency loudspeakers in rooms,” A. Celestinos and S. B. Nielsen, presented at the 119th Convention of the Audio Engineering Society, *Journal of the Audio Engineering Society (Abstracts)*, vol. 53 p. 1206 (December 2005), convention preprint 6545.

Paper C

“Low frequency sound field enhancement system for rectangular rooms using multiple low frequency loudspeakers,” A. Celestinos and S. B. Nielsen, presented at the 120th Convention of the Audio Engineering Society, *Journal of the Audio Engineering Society (Abstracts)*, vol. 54 p. 1206 (July/August 2006), convention preprint 6688.

Paper D

“Controlled Acoustically Bass System (CABS), A Method to Achieve Uniform Sound Field Distribution at Low Frequencies inside Rectangular Rooms,” A. Celestinos and S. B. Nielsen, submitted to the *Journal of the Audio Engineering Society*, (December 2006).

Paper A

Multi-source low frequency room simulation using finite difference time domain approximations

Adrian Celestinos^a Sofus Birkedal Nielsen^a

^a*Acoustics, Department of Electronic Systems, Aalborg University, DK-9220 Aalborg East, Denmark*

Abstract

The sound level distribution generated by loudspeakers placed in a room can be simulated using numerical methods. The purpose of this paper is to present an application based on finite-difference time-domain approximations (FDTD) for the study of low frequencies in audio reproduction such as ordinary stereo to multi-channel surround setups. A rectangular room is simulated by using a discrete model in time and space. This technique has been used extensively and gives good performance at low frequencies. The impulse response can be obtained in addition to the sound level distribution. Simulation of multiple loudspeakers in a room can be achieved to evaluate and visualize their coupling with the room. A high frequency resolution can be obtained for auralization purpose.

1. INTRODUCTION

When a loudspeaker is placed in a rectangular room a number of problems arise. Modification of the response of the loudspeaker at the listening position occurs due to the strong influence of the room and the position of the loudspeaker. The combination loudspeaker-room acts as a coupled system where the room typically dominates by its distinct normal modes. When placing more than one loudspeaker in the room some of the attenuation produced by the room is less severe but still the room has a strong influence at the different listening positions. In order to deal with this problem equalization techniques have been investigated by several authors as in [1],[2] or [3]. In connection to that a robust tool to simulate the low frequency behavior of multiple sound sources placed in rectangular rooms is needed. During the last years two main approximations using numerical methods have been developed which are the Ray tracing and the Image source method found in [4] and [5]. Such methods are no longer adequate to simulate frequencies below 100 Hz because they are based on geometri-

cal acoustic approximations where the wavelength is smaller than the room dimensions. The finite-difference time-domain (FDTD) method has been used with great success to model electromagnetic problems. In acoustics FDTD has shown good performance to approximate the low frequency room behavior. This method has been well described in early studies by Botteldooren in [6]. By using this approximations the calculations are made directly in the time domain. The sound wave equation is discretized both in time and space and the inclusion of multiple sound sources in the room is possible since the finite time and space are always available. Recently other methods as the finite-element method (FEM) and the boundary-element method (BEM) have been used extensively to simulate enclosures. These approximations work only in the frequency domain, direct translation to a direct time domain formulation can be seen in [7] or [8].

In this paper the FDTD method has been chosen to simulate a rectangular room excited by multiple sound sources. The estimation of the sound level distribution at low frequencies is calculated. The inclusion of loudspeakers assuming omni-directional

compact sources is implemented inside the room. Since the particle velocity is always available, sound power and intensity can be estimated for equalization purposes. Moreover a band limited impulse response of the room can be acquired.

2. SIMULATION OF SOUND SOURCES IN A ROOM USING FDTD

In this section a description of the FDTD method is presented as well as important aspects for the simulation process which are, stability, the boundary conditions and the modeling of the sound sources.

2.1. Method

Typically the FDTD method utilizes two coupled first order differential equations. Since this method works in the time domain it computes the derivative and linearized form of these two equations in the time domain. This is done by means of the central finite difference [9].

2.1.1. Discretization of The Wave Equation

The first equation is the linear inviscid force equation valid for acoustic processes of small amplitude where the acoustical pressure p and the particle velocity u are related as:

$$\nabla p = -\rho_0 \frac{\partial \vec{u}}{\partial t} \quad (1)$$

where ρ_0 is the density of the transmission media in kg/m^3 . The second equation is the linear continuity equation

$$\nabla \cdot \vec{u} = -\frac{1}{c^2 \rho_0} \frac{\partial p}{\partial t} \quad (2)$$

where c is the wave propagation speed in the media [10].

The typical formulation of the FDTD approximation uses a Cartesian staggered grid [11], in which pressure and particle velocity are the unknown quantities. The acoustical pressure is determined at the grid points $(x\delta x, y\delta y, z\delta z)$, at time $t = \delta t$. In this paper $\delta x = \delta y = \delta z = h$ that is the spatial discretization step and $\delta t = k$ that is the time step. Both equations can be sampled in time and space using the sampling rates $\frac{1}{k}$ Hz and $\frac{1}{h} \text{m}^{-1}$. The discretization is done by means of finding the central

point between two neighbour time/space points [12].

After the derivation in time and space of Eq. (1) (force equation), the three components of the particle velocity are determined at positions:

$$\begin{aligned} u_{(x \pm \frac{h}{2}, y, z)}^x \\ u_{(x, y \pm \frac{h}{2}, z)}^y \\ u_{(x, y, z \pm \frac{h}{2})}^z \end{aligned} \quad (3)$$

and at intermediate time $t = (t + \frac{1}{2})k$ by the following equations:

$$\begin{aligned} u_{x+\frac{h}{2}, y, z}^x(t + \frac{k}{2}) &= u_{x+\frac{h}{2}, y, z}^x(t - \frac{k}{2}) - \frac{k}{h\rho_0} \\ &\quad \times [p_{x+h, y, z}(t) - p_{x, y, z}(t)], \\ u_{x, y+\frac{h}{2}, z}^y(t + \frac{k}{2}) &= u_{x, y+\frac{h}{2}, z}^y(t - \frac{k}{2}) - \frac{k}{h\rho_0} \\ &\quad \times [p_{x, y+h, z}(t) - p_{x, y, z}(t)], \\ u_{x, y, z+\frac{h}{2}}^z(t + \frac{k}{2}) &= u_{x, y, z+\frac{h}{2}}^z(t - \frac{k}{2}) - \frac{k}{h\rho_0} \\ &\quad \times [p_{x, y, z+h}(t) - p_{x, y, z}(t)], \end{aligned} \quad (4)$$

Similarly, from Eq. (2) (continuity equation), the acoustic pressure can be derived in time and space by:

$$\begin{aligned} p_{x, y, z}(t + k) &= p_{x, y, z}(t) \\ &\quad - \frac{c^2 \rho_0 k}{h} [u_{x+\frac{h}{2}, y, z}^x(t + \frac{k}{2}) - u_{x-\frac{h}{2}, y, z}^x(t + \frac{k}{2})] \\ &\quad - \frac{c^2 \rho_0 k}{h} [u_{x, y+\frac{h}{2}, z}^y(t + \frac{k}{2}) - u_{x, y-\frac{h}{2}, z}^y(t + \frac{k}{2})] \\ &\quad - \frac{c^2 \rho_0 k}{h} [u_{x, y, z+\frac{h}{2}}^z(t + \frac{k}{2}) - u_{x, y, z-\frac{h}{2}}^z(t + \frac{k}{2})], \end{aligned} \quad (5)$$

These are the set of equations that are used to calculate particle velocity and acoustical pressure in an alternate manner.

In Fig. 1 an example of an enclosure can be seen where the layout of the grid for the calculation of the components of the particle velocity and acoustic pressure points in two dimensions is shown. The circular points represent acoustical pressure while squares are particle velocity component points in x direction and stars are particle velocity components in y direction. As it can be observed there are no

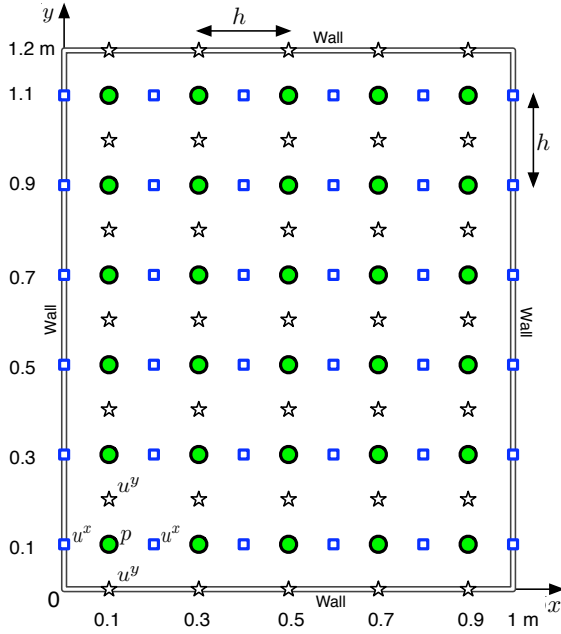

Fig. 1. Example of a 1m×1.20m enclosure. Circles are pressure points, stars are particle velocity in the y direction, and squares are particle velocity in the x direction.

pressure points at the boundaries. In this manner the components of the particle velocity in for example the x direction are calculated at intermediate pressure points as well as at intermediate time steps. The advantage of using this grid is that is easy to define the boundaries and it only requires two values of the acoustic pressure and particle velocity to be stored in each grid cell.

2.1.2. Cell Size

A fundamental constraint for the simulation method is the choice of the size cell. The frequency range of interest before aliasing and the accurate wave propagation is given by the cell size. The cell size must be much less than the smallest wave length for which accurate results are needed. Reasonable results can be achieved by using from five to ten cells per wavelength [9]. In this paper a cell size of 10 cm has been chosen since this cell size corresponds to $\frac{1}{5}$ of a wavelength therefore it is expected to have accurate results below 600Hz.

2.1.3. Stability

After the cell size has been chosen, the time step has to be set. In order to have accurate wave propagation and to minimized grid dispersion errors the relation

expressed in Eq. (6) has to be held, more generally for a three dimensional rectangular grid [9].

$$c\delta t \leq 1/\sqrt{\frac{1}{\delta x^2} + \frac{1}{\delta y^2} + \frac{1}{\delta z^2}} \quad (6)$$

In this paper the sampling frequency f_s was decided to be 8 kHz, and the time step $k = 1/f_s$. Nevertheless the program can be set to find the minimum time step before it gets unstable.

2.2. Boundary Conditions

Taking the example of Fig. 1 and assuming a right hand rigid wall at the boundary of the room the component of the particle velocity in the x direction can not be calculated with Eq. (4) because the term $p_{x+h,y,z}(t)$ is unknown. To solve this problem an asymmetric finite-difference approximation for the space derivative is implemented as in [11].

Since the component of the particle velocity in the x direction u^x represents the perpendicular part of the particle velocity to the wall, it is assumed that the acoustic pressure p at the wall can be expressed by the product of the component of the particle velocity in the x direction u^x and the impedance Z of that wall [12]. This manner an estimate of the absorption coefficient of the walls α can be introduced to calculate Z as

$$Z = \rho_0 c \frac{1 + \sqrt{1 - \alpha}}{1 - \sqrt{1 - \alpha}}. \quad (7)$$

After these assumptions the new version of Eq. (4) for the component of the particle velocity at the walls is introduced and for example for $u^x_{[0.9+\frac{h}{2},y,z]}$ in Fig. 1 the boundary equation is defined as:

$$u^x_{[0.9+\frac{h}{2},y,z]}(t + \frac{k}{2}) = \frac{\frac{\rho_0 h}{k} - Z}{\frac{\rho_0 h}{k} + Z} u^x_{[0.9+\frac{h}{2},y,z]}(t - \frac{k}{2}) + \frac{2}{\frac{\rho_0 h}{k} + Z} p_{[0.9,y,z]}(t) \quad (8)$$

2.3. Sound Source Model

The loudspeakers are modeled as typical closed-box loudspeakers with volume velocity function of time occupying a small volume ($h \times h \times h$) inside the room. At low frequencies, where the wavelength of sound in the air is much longer than the physical

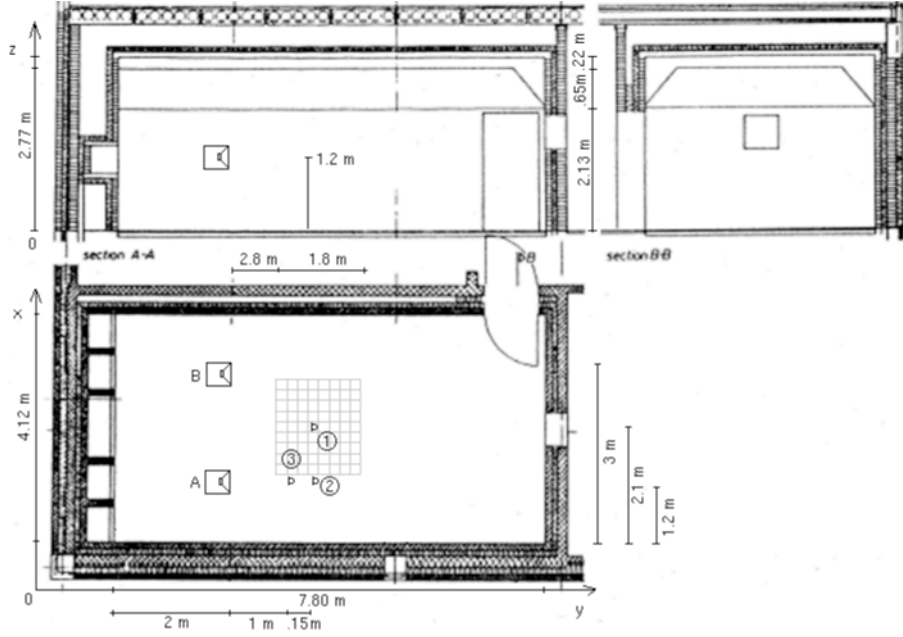

Fig. 2. Listening test room, dimensions shape and measurement setup, adapted from [14].

dimensions of the loudspeaker, it propagates the sound in spherical waves radiating outwards uniformly in all directions [13].

When the loudspeaker is driven by a sinusoidal signal it is modelled according to

$$p_{x_s, y_s, z_s}(t) = A \cdot \sin(\omega(t)) \quad (9)$$

$$A = S_D \omega u \quad (10)$$

where A is the volume acceleration, u is the particle velocity, S_D is the effective area of the radiating surface and ω is the angular frequency. In this manner one or more than one compact sources can be included in the model either in a pressure point or particle velocity using the volume velocity of the desired loudspeaker. In addition the loudspeaker can be modelled as a membrane moving in a desired direction using some of the points of the components of the particle velocity.

3. EVALUATION OF THE SOUND FIELD IN A ROOM

3.0.1. The Test Room

For the purpose of this paper the standard listening room at Acoustics, Aalborg University has been chosen to be simulated since this room has been well studied. The room has the following dimen-

sions, length 7.80 m; width 4.12 m; height 2.77 m; the mean reverberation time T_{60} is 0.47 s. The floor is wooden and the walls are covered with special panels that can be removed or moved to different positions. The ceiling is curved in the corners covered with special plaster panels (see Fig. 2). The panels from the walls have been removed as well as the carpet that normally covers most of the floor. The test room has been measured and simulated early by Cherek and Langvad in [15] as well as by Krarup in [12].

An horizontal layer of the room at a height of 1.2 m has been chosen to calculate the sound pressure level (SPL) distribution. The simulation time was set to 1 second taking in to account that the reverberation time of the test room simulated is less than 1 second. In case of a simulation of a more reverberant room the simulation time should be greater than the mean reverberation time.

3.1. Sound Pressure Level Distribution

Since the root mean square (RMS) value of any signal is proportional to its energy content and therefore is one of the most important and most often used measures of amplitude it has been decided to calculate this value over the area of interest in the room. As it is mention in section 2.1.1 two time

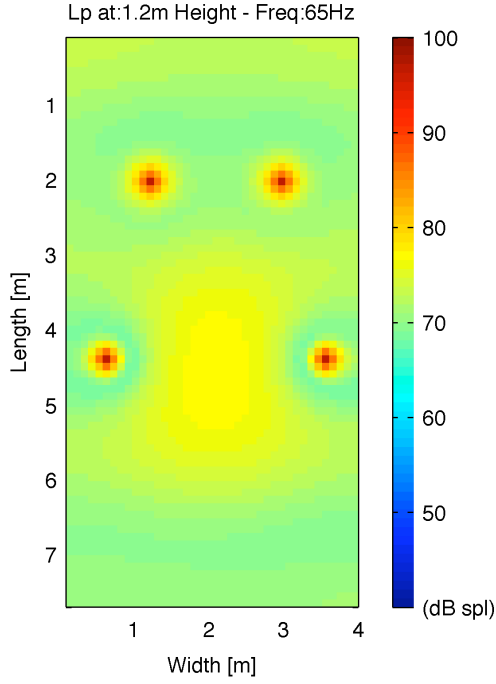

Fig. 3. Sound pressure level distribution resulting from the simulation of four loudspeakers reproducing a sinusoidal frequency of 65 Hz.

steps of the pressure points and particle velocity of the whole room are needed to determine the acoustic pressure in the grid positions. Eq. (11) is used to calculate the RMS value of the pressure over the area of interest where T is the relevant period over which the averaging takes place and p is the instantaneous pressure [16].

$$p_{rms} = \sqrt{\frac{1}{T} \int_0^T p^2(t) \cdot dt} \quad (11)$$

For this calculation an extra matrix is loaded to be used as an accumulator of the result of the squared summation of the sound pressures for each time step. From this pressure matrix the SPL distribution over the chosen layer in the room can be obtained (see Fig. 3). The SPL distribution is calculated in the room according to:

$$Lp_{SPL} = 20 \text{Log}_{10} \frac{p}{p_o} \quad (12)$$

where p is the sound pressure being computed and p_o is the reference sound pressure being $20 \mu \text{ Pa}$.

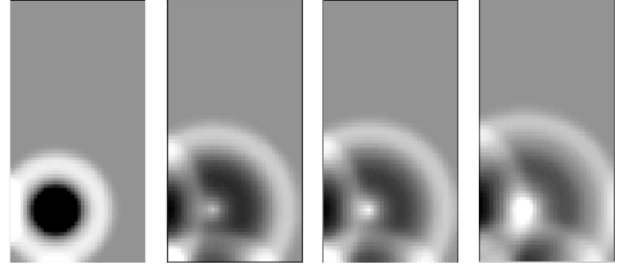

Fig. 4. Sequence of images at ascending times (from left to right) of the computed pressure amplitude produced by a loudspeaker close to the walls of the test room.

3.2. Optimization of Used Memory

A huge amount of memory is needed if one wants to keep the pressure amplitude at all discrete times all over the room. To optimize the use of memory only two time steps of pressure amplitude and particle velocity all over the room are stored together with one extra matrix for the average sound pressure level. The averaged sound pressure level will only be calculated in the horizontal plane of interest. Nevertheless some other (virtual) microphones can be set up all over the room in order to pick up the calculated pressure amplitude at the discrete times at any desired position in the enclosure.

3.3. Visualization in Time Domain

A very useful advantage of the FDTD method is the visualization aspect. Since it runs in the time domain the pressure amplitude in a desired area of the room can be observed at any discrete time. An animation movie composed by indexed images of the pressure amplitude along the discrete simulation times can be obtained by the simulation program (see Fig. 4).

3.4. Acquisition of Impulse Response

Two methods are considered to obtain a band limited transfer function impulse response from a number of sound sources to specific locations in the room. The first one is performed by reproducing a finite length Gaussian pulse and picking up the impulse in the room at the desired position. The second method is implemented by reproducing a maximum length sequence (MLS) and record the signal at the desired position in the room. In the next two sections both methods will be described.

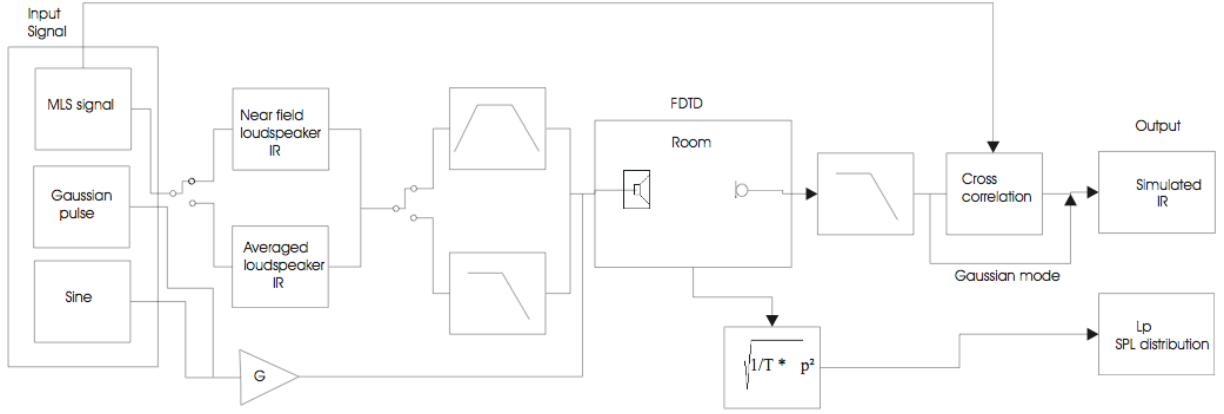

Fig. 5. Block diagram of the simulation program.

3.4.1. Gaussian Pulse

The Gaussian pulse used in the simulation is defined by Eq. (13) and it is shown in Fig. 6. This kind of pulse has the characteristic of having a limited flat frequency response. The cut off frequency is defined by σ in Eq. (14) where $\omega = 2\pi f$ and f is the -3 dB cut off frequency of the sound source.

$$p_{x_s, y_s, z_s}(t) = \frac{1}{\sigma^2} \sin(t - t_0) e^{-\frac{(t-t_0)^2}{\sigma^2}} \quad (13)$$

$$\sigma = \frac{2}{\omega} \quad (14)$$

In Fig. 7 the recorded impulse response at position 1 together with the frequency response is presented. The test room was exited by one source at position (1.2 m, 2.0 m, 1.2 m) refer to Fig. 2 to see the microphone and loudspeaker position in the test room. As it can be observed the influence of the room is severe and some of the room modes are revealed.

3.4.2. MLS method

As well as the Gaussian pulse method an MLS sequence is reproduced by the sound source. An MLS signal is very useful because it has high energy content and it is very suitable for different impulse lengths. It generates uniform probability density, its spectrum is absolutely flat, and the most important is that its periodic auto correlation is a unit sample sequence. The motivation to use the MLS method is that the MLS method unlike the Gaussian excitation has high energy content in all frequencies.

The signal is implemented by generation of pseudo random numbers. The sampling frequency is set to 8 kHz. The length of the impulse response was set

to $2^N - 1$ being chosen according to how reverberant is the room to simulate. The length of the input signal is two times the length of the MLS signal in order to stabilize the filter. The input signal is low pass filtered to avoid aliasing from the simulation itself. The cut off frequency is chosen according to the frequency range of interest. The MLS method has been extensively studied, details of the theory can be found in [17], [18] and other authors. An anti aliasing filter at 2 kHz is implemented to filter the recorded signal. The cross correlation between the MLS input signal and the recorded sequence is calculated in order to obtain the impulse response. In Fig. 8 the recorded impulse response and frequency

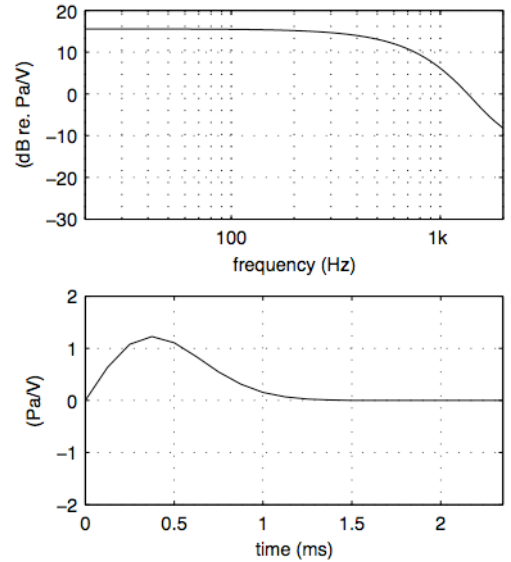

Fig. 6. Upper plot shows the frequency response of the Gaussian pulse, lower plot shows the Gaussian pulse in the time domain. The cut off frequency has been set to 600 Hz.

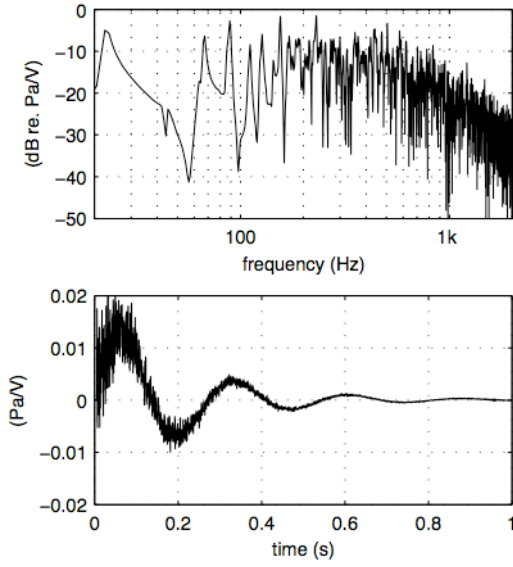

Fig. 7. Upper curve is the transfer function of the room plus the loudspeaker calculated at microphone position 1, lower plot is the impulse response, method: Gaussian pulse.

response of the simulated room is shown. The room was exited by one sound source located at coordinates (1.2 m, 2.0 m, 1.2 m) (see Fig. 2).

3.4.3. Including a real loudspeaker impulse response

In order to get a more accurate result in the simulation the transfer function of a real loudspeaker can be introduced in the model. This procedure is valid just when the frequency range of interest is below 500 Hz since a loudspeaker behaves almost omnidirectional within that range. The test loudspeaker (A) is a closed-box type with a volume of 12 litre and 35 cm height 23 cm width and 23.5 cm depth, it has a woofer of 16.5 cm diameter, and a 1.9 cm dome tweeter. The test loudspeaker (A) has been measured in anechoic conditions in order to obtain two impulse responses to be tested in the simulation program.

For the first measurement it has been decided to measure the near field impulse response as close as possible to the cone of the test loudspeaker (see Fig. 9), more details about near field measurements can be found in [19].

The second impulse response is an average in the frequency domain of measurements of the response of the loudspeaker in the horizontal plane and vertical plane at 1 m from the membrane with a reso-

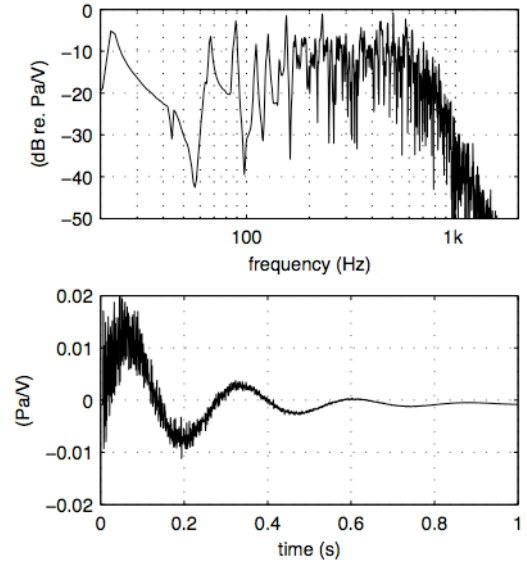

Fig. 8. Upper curve is the transfer function from the loudspeaker to the the room calculated at virtual microphone position 1. Lower curve is the impulse response, method: MLS.

lution of 30 degrees. The magnitude of the averaged impulse response has been normalized with the near field measurement in the frequency domain in order to have the same gain as the near field measurement (see Fig. 9).

After obtaining the transfer functions of the loudspeaker they have been convolved with the MLS input signal, then low pass filtered and reproduced at the sound source position. The same procedure explained in section 3.4.2 has been applied to obtain the impulse response with an MLS signal (see Fig. 5). The lower graph in Fig. 10 shows the impulse response recorded at position 1. The test room is exited by one sound source located at position (1.2 m, 2.0 m, 1.2 m) including the loudspeaker transfer function of the near field measurement, at the upper graph in the same figure the frequency response is presented, at the same graph the dotted line includes the averaged transfer function of the loudspeaker instead of the near field measurement.

3.4.4. Implementation of a fine grid for auralization

By reducing the size of the cell the frequency range of interest is increased. In order to obtain a fair frequency range for auralization purposes a fine grid of 4 cm has been implemented. At the sound source position a finite length signal of music (speech) can be used as an input signal. The signal could be recorded

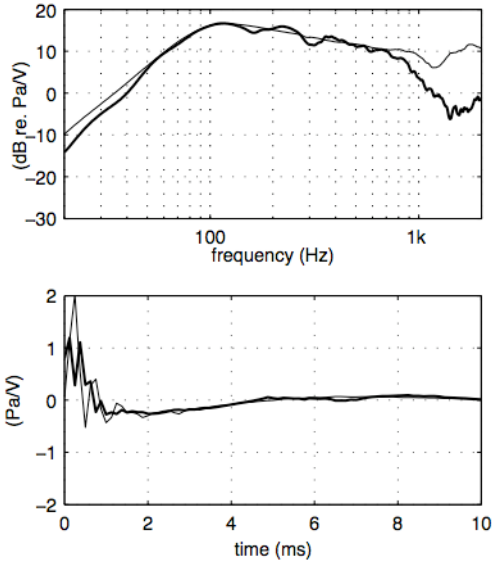

Fig. 9. Frequency response and time response of test loudspeaker (A), thin line is the near field measurement, thick line averaged in horizontal and vertical planes.

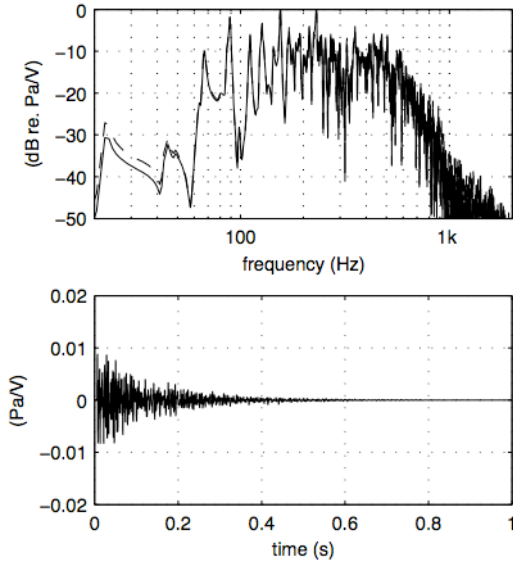

Fig. 10. Transfer function of the room and loudspeaker (A) calculated at position 1, continuous line near field impulse response is included, dashed line the averaged impulse response of the real loudspeaker is included. In the time response only the averaged impulse response is included, method: MLS.

at two microphone positions spaced by 16 cm. Since the computation is done in the time domain it would take so much time to compute even one minute of music. Instead the auralization has been performed by using direct convolution with the obtained impulse responses from the simulation program.

4. RESULTS AND VALIDATION

4.1. Measurements

In order to validate the results of the simulations two set of measurements have been carried out in the test room.

4.1.1. Sound Pressure Distribution Measurement

To validate the sound pressure distribution a rectangular area has been delimited in the test room. A rectangular grid of 10x9 points separated each other by 20 cm at a height of 1.20 m in the test room has been set up (see Fig. 2). The panels that cover the walls and the carpet from the floor were removed. The test loudspeaker (A) was set in the room at position (1.2 m, 2.0 m, 1.2 m). The sound pressure level has been measured at each grid point. The measurement was carried out driving the test loudspeaker with 65 Hz by a sine generator with 1.0 V RMS amplified by a reference stereo amplifier. As mention before the test loudspeaker is a closed box type with a volume of 12 litre and 35 cm height, 23 cm width and 23.5 cm depth it has a 16.5 cm diameter bass driver unit and a 1.9 cm, polyamide dome tweeter. The test loudspeaker (A) was pointing to the grid area (as seen in Fig. 2).

At each point in the grid a pressure microphone connected to a pre-amplifier was located with a precision of ± 1.5 cm. The output from the pre-amplifier was connected to a measuring amplifier. The average time from the measuring amplifier was set to 1 second to obtain an RMS voltage value. The system was calibrated by a piston-phone to 124 dB SPL at 250 Hz.

4.1.2. Impulse Response Measurement

To validate the acquisition of the impulse response by the MLS method the impulse response at three microphone positions in the room were measured. The microphones were located at 1.20 m height. The room was excited first by the test loudspeaker (A) afterwards by both test loudspeaker (A) and test loudspeaker (B), the test loudspeaker (B) was also a closed box the same type, model and dimensions. In Fig. 2 the three microphone positions and the loudspeaker positions are shown. At each microphone position a pressure microphone connected to a pre-amplifier was placed. The output from the pre-amplifier was connected to a measur-

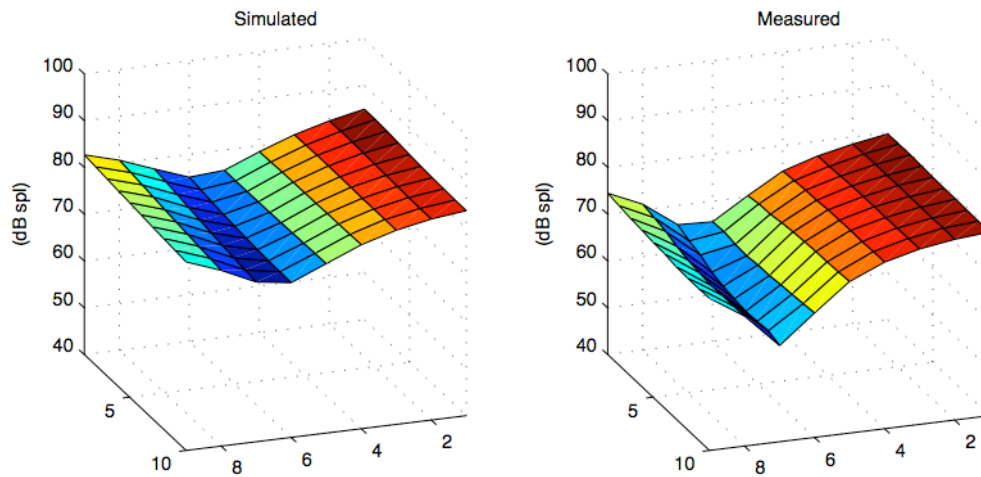

Fig. 11. Comparison of sound pressure level distribution in the rectangular grid area and measurements, the grid has 9x11 points separated by 20 cm from each other.

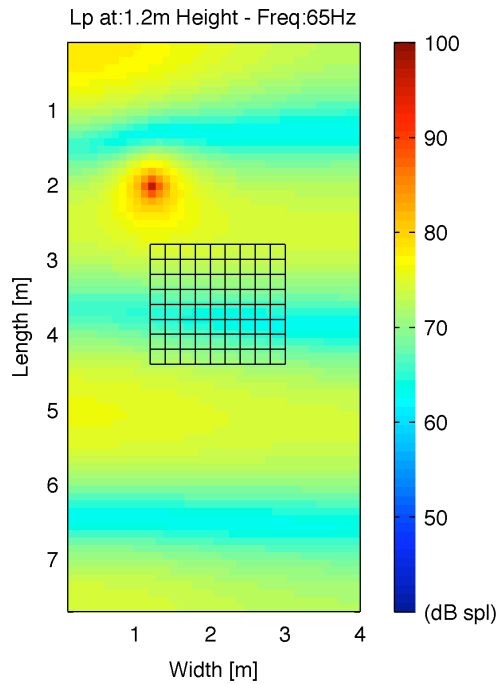

Fig. 12. Sound pressure level distribution resulting from the simulation of one loudspeaker reproducing a sinusoidal frequency of 65 Hz, the measuring grid can be observed.

ing amplifier and sent to a MLS measuring system board in a PC. The system was calibrated with a piston-phone producing a sound pressure level of 124 dB at 250 Hz.

It was decided to band-pass filter the excitation signal since the result of the simulation is a band

limited impulse response. From the MLS measuring system the output was connected to an analog band pass filter set to 10 Hz and 600 Hz as cut off frequencies. From the band pass filter the signal was sent to a reference stereo amplifier and from there to the test loudspeaker. The length of the impulse response was set to 8191 samples with a sampling frequency of 8 kHz. The bandwidth was set to 2 kHz with a Butterworth 8th order low pass filter as an anti aliasing filter.

The first measurement was done measuring at the three microphone positions placing test loudspeaker (A) and the second one was measuring again the three microphone positions with test loudspeaker (A) and test loudspeaker (B) included both. The excitation signal was the same for both loudspeakers.

4.2. Simulation

Two main scenarios were simulated following the measurements. The sound pressure level distribution over the selected grid area and the computation of the impulse response of the room by the excitation of first test loudspeaker (A) and secondly adding test loudspeaker (B). The averaged impulse response of the real loudspeaker was included in the model. In both cases the simulation time was 1 second at a sampling frequency of 8 kHz. The space grid was set to 10 cm for both cases. For the impulse response simulation the impulse response of the analog band pass filter and the anti aliasing filter from the MLS system were included in the model. The boundary

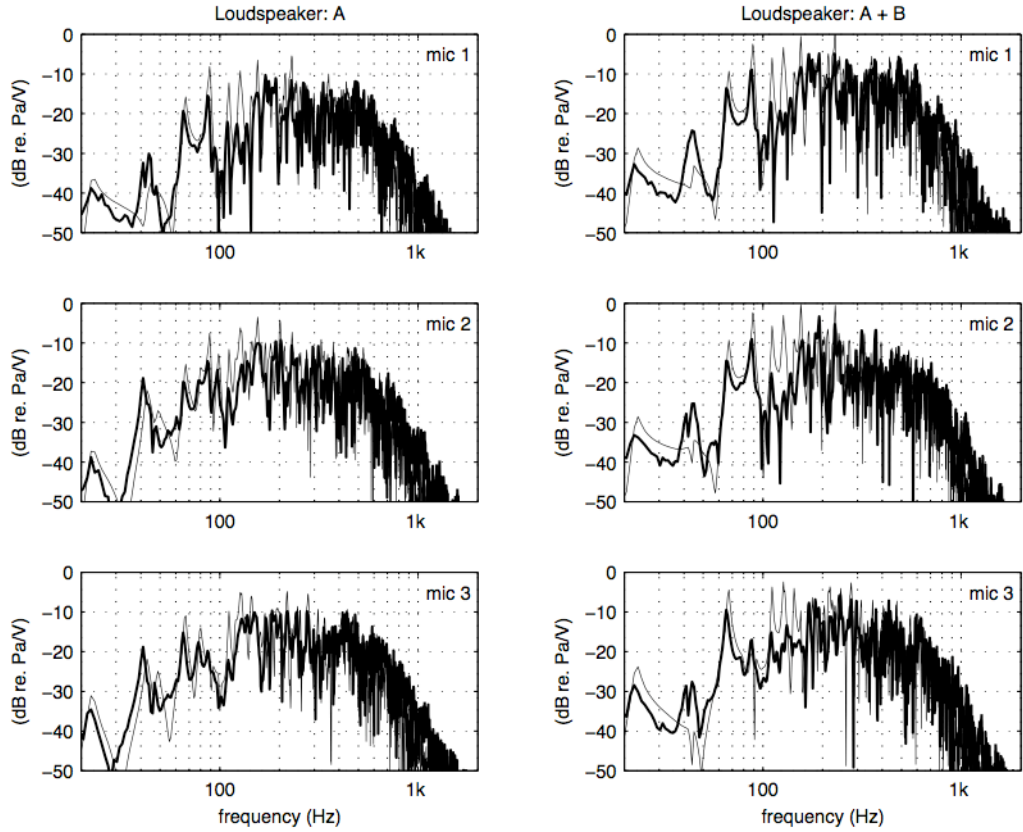

Fig. 13. Thick lines are frequency responses from measured impulse responses at microphone positions 1, 2 and 3; Thin lines are the simulations. Left column only loudspeaker (A) is included while in right column test loudspeaker (B) is also included.

conditions for the walls were set as follows, for the wooden floor the bulk characteristic impedance was used as an approximation to the impedance of that surface being $1.575 \times 10^6 \frac{\text{kg}}{\text{m}^2 \text{s}}$, equivalent to an absorption coefficient $\alpha = 0.0011$. The absorption coefficient of the walls was set to $\alpha = 0.1000$. Two absorption coefficients were used for the ceiling, $\alpha = 0.0797$ and $\alpha = 0.1530$ for the most absorptive sections.

4.3. Comparison of simulations and real measurements

In Fig. 12 the sound pressure distribution can be observed after simulation at a height of 1.2 m. It is noticeable the influence of the room forming the nodes and antinodes by the stationary waves. In Fig. 11 two surface plots are shown, these graphs represent the sound pressure level simulated and secondly measured along the chosen surface area, in Fig. 12 the same simulation is shown along the complete

surface layer of the room. In Fig. 13 the frequency response from the measured and simulated response are shown. In the left column the room was excited by test loudspeaker A while in the right column both test loudspeakers were used. The excitation signal was the same for both. In Fig. 14 the measured impulse responses derived by the simulation program are shown. It can be observed that the impulse responses calculated in the simulation have more energy content than the real ones. Nevertheless as it is shown in Fig. 13 they do not differ so much in the frequency domain.

5. DISCUSSION

As it is shown in Fig. 12 and in Fig. 11 the simulation program present good agreement with the measurements. The main room resonances are revealed by the simulation. It can be said that at very low frequency there is some divergence. Nevertheless the simulation program can be used as a predictor tool

in order to know beforehand what would happen when a loudspeaker is placed in a rectangular room. It has to be added that the ceiling of the room is quite complex to model since it is not regular and some parts are covered with very absorptive material like rock wool but in some other areas the ceiling is quite reflective. In connection to that it was quite difficult to find absorption coefficients for the materials at very low frequencies. It was a good approximation to model the boundary condition using the characteristic impedance of the materials.

6. CONCLUSION

A simulation tool has been developed. The finite-difference time-domain FDTD method has been used to approximate the sound pressure and particle velocity produced by multiple loudspeakers in a rectangular room. The simulation program has been tested with good results according to measurements. The developed application can be used as a reliable tool for equalization purposes on multi-channel sound reproduction systems in conjunction with other approximations as Ray Tracing or Image Source. The solution gives the possibility to evaluate and visualize the interaction of multiple loudspeakers in a room by an animation of pictures of the pressure amplitude at discrete times. Moreover the possibility of direct auralization of multichannel signals is possible by convolution of the calculated impulse response and anechoic recordings.

7. ACKNOWLEDGEMENTS

The authors thank Søren Krarup Olesen Associate Professor at Acoustics, Aalborg University for his helpful advice and since part of this paper has been motivated by his early work in low frequency room simulations.

References

- [1] S. J. Elliott and P. A. Nelson, "Multiple-Point Equalization in a Room Using Adaptive Digital Filters," *J. Audio Eng. Soc.*, **37**, pp. 899-907. (November 1989)
- [2] P. A. Nelson, F. Orduña-Bustamante and H. Hamada, "Inverse Filter Design and Equalization Zones in Multichannel Sound Reproduction," *IEEE Trans. Speech Audio Process*, **3**, pp. 185-192. (1995)
- [3] R. Walker, "Equalization of Room Acoustics and Adaptive Systems in the Equalization of Small Room Acoustics," *Proceedings of AES 15th International Conference, Audio, Acoustics & Small Spaces*, pp. 32-47. (November 1998)
- [4] A. Krokstad, "Calculating the Acoustical Room Response by the Use of a Ray Tracing Technique," *J. of Sound and Vibration*, **8**, pp. 118-125. (1968)
- [5] J. B. Allen and Berkley, "Image Method for Efficiently Simulating small-room acoustics," *J. Acoust. Soc. Am.*, **65**, pp. 943-950. (1979)
- [6] D. Botteldooren, "Acoustical Finite-Difference Time-Domain Simulation in Quasi-Cartesian Grid," *J. Acoust. Soc. Am.*, **95**, pp. 2313-2319. (May 1994)
- [7] M. M. Boone and G. Janssen, "Modal superposition in the time domain: Theory and experimental results," *J. Audio Eng. Soc.*, **97**, pp. 92-97. (January 1995)
- [8] J. P. Coyette, "Transient Acoustics: Evaluation of Finite Element and Boundary Element Methods," *Proc. of ISMA 19*, pp. 223-234. (1994)
- [9] K. S. Kunz, *Finite Difference Time Domain Method for Electromagnetics*, CRC. (1993)
- [10] L. E. Kinsler, *Fundamentals of Acoustics*, 4th. Ed. John Wiley & Sons, Inc. (2000)
- [11] D. Botteldooren, "Finite-Difference Time Domain Simulation of Low-Frequency Room Acoustic Problems," *J. Acoust. Soc. Am.*, **98**, pp. 3302-3309. (December 1994)
- [12] S. K. Olesen, "Low Frequency Room Simulation using Finite Difference Equations," *Proc. AES 102nd Convention*, Preprint 4422 (D2). (March 1997)
- [13] J. Borwick, *Loudspeaker and Headphone Handbook*, Butterworth & Co. (1988)
- [14] B. Langvad, H. Møller and G. Budzynski "Testing a New Listening-Room," *Archives of Acoustics*, **14**, 1-2, pp. 45-60. (1989)
- [15] B. Chereck and B. Langvad, "Low Frequency Simulation of a Listening Room," *Proc. of Nordic Acoustical Meeting*, pp. 265-270. (1990)
- [16] J.R. Hassall and K. Zaveri, *Acoustic Noise Measurements*, 5th Ed. 1st Print. B & K. (1988)
- [17] D. D. Rife and J. Vanderkooy, "Transfer function Measurement with Maximum-Length Sequences," *J. Audio Eng. Soc.*, **37**, pp. 419-444. (June 1989)
- [18] J. Vanderkooy, "Aspects of MLS Measuring Systems," *J. Audio Eng. Soc.*, **42**, pp. 219-231. (April 1994)
- [19] D.B. Keele Jr., "Low-Frequency Loudspeaker Assessment by Nearfield Sound-Pressure Measurement," *J. Audio. Eng. Soc.*, Vol.22, pp.154-162. (April 1974)

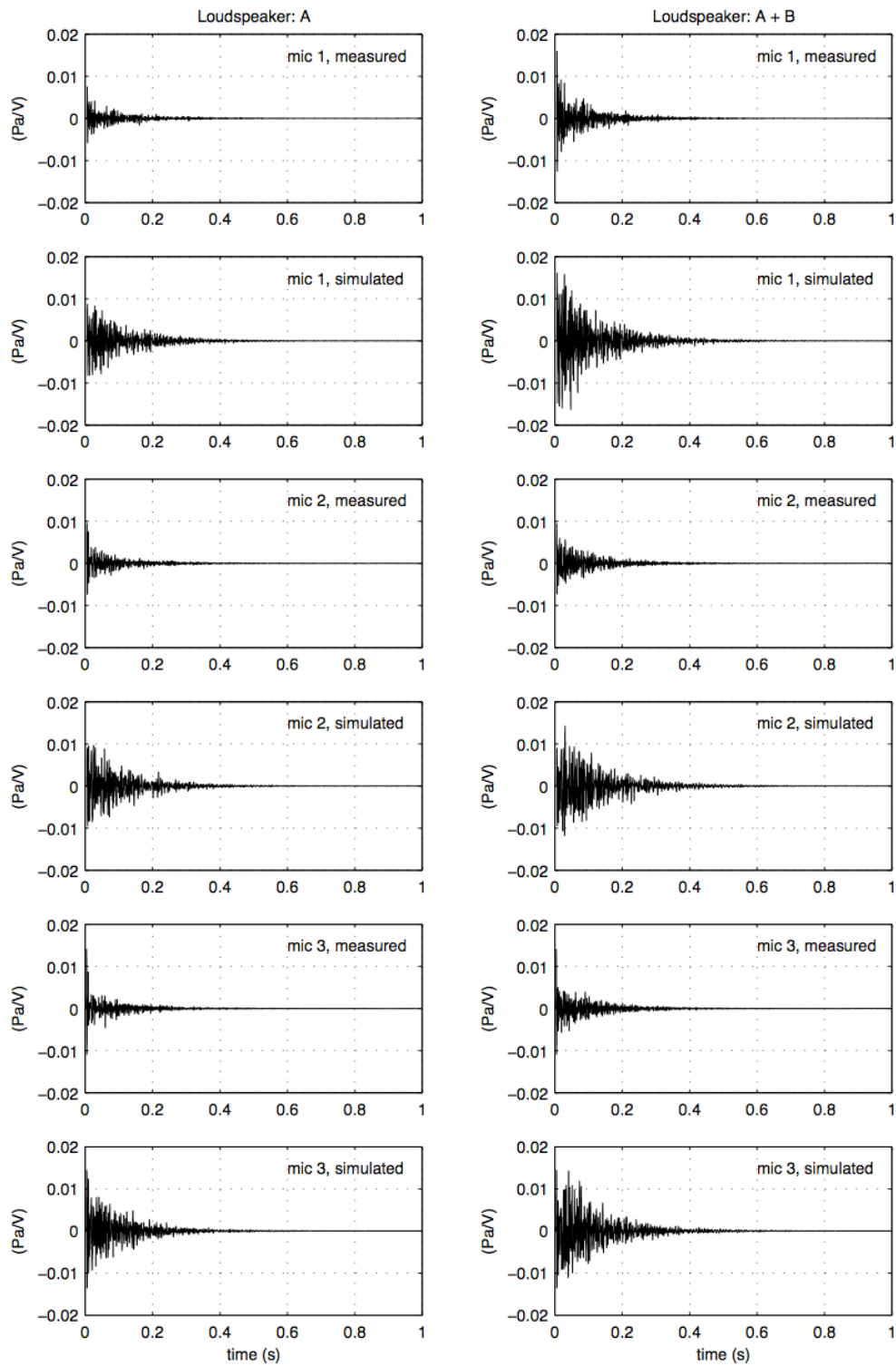

Fig. 14. Impulse responses measured and simulated by FDTD correspondent to the three microphone positions in the test room.

Paper B

Optimizing placement and equalization of multiple low frequency loudspeakers in rooms

Adrian Celestinos^a, and Sofus Birkedal Nielsen^a

^a*Acoustics, Department of Electronic Systems, Aalborg University, DK-9220 Aalborg East, Denmark*

Abstract

Every room has strong influence on the low frequency performance of a loudspeaker. This is often problematic to control and to predict. The modal resonances modify the response of the loudspeaker depending on placement and listening position. In order to anticipate the behavior of low frequency loudspeakers in rooms a simulation tool based on finite-difference time-domain approximations (FDTD) has been developed. Simulations have shown that by increasing the number of loudspeakers and modifying their placement a significant improvement is achieved. A more even sound pressure level distribution along a listening area is obtained. The placement of loudspeakers has been optimized. Furthermore an equalization strategy can be implemented for optimization purpose. This solution can be combined with multi channel sound systems.

1. INTRODUCTION

When a loudspeaker is placed in a rectangular room a number of problems arise. Modification of the response of the loudspeaker at the listening position occurs due to the strong influence of the room and the position of the loudspeaker. The combination loudspeaker-room acts as a coupled system where the room typically dominates by its distinct normal modes. When placing more than one loudspeaker in the room some of the attenuation produced by the room is less severe but still the room has a strong influence at the different listening positions. In order to deal with this problem equalization techniques have been investigated by several authors in [1],[2] and [3]. In connection to that a robust tool to simulate the low frequency behavior of multiple sound sources placed in rectangular rooms is needed. During the last years two main approximations using numerical methods has been developed which are Ray

tracing and Image source method [4],[5]. Such methods are no longer adequate to simulate frequencies below 100 Hz because they are based on geometrical acoustic approximations where the wavelength is smaller than the room dimensions.

The finite-difference time-domain (FDTD) method has been used with great success to model electromagnetic problems. In acoustics FDTD has shown good performance to approximate the low frequency room behavior. This method has been well described in early studies by Botteldooren [6]. By using this approximations the calculations are made directly in the time domain. The sound wave equation is discretized both in time and space and the inclusion of multiple sound sources in the room is possible since the finite time and space is always available. In this paper the FDTD method has been chosen to simulate a rectangular room excited by multiple sound sources. The estimation of the sound level distribution at low frequencies is calculated. The inclusion

of loudspeakers assuming omnidirectional compact sources is implemented inside the room. Since the particle velocity is always available, sound power and intensity can be estimated for equalization purposes. Moreover a band limited impulse response of the room can be derived.

Sound reproduction systems are typically placed in small or medium size rectangular rooms. Every room has strong influence on the low frequency performance of a loudspeaker. The combination loudspeaker-room acts as a coupled system where the room properties typically dominate due to the parallel walls. This is often problematic to control and to predict since the modal resonances modify the magnitude response of the sound source depending on the listening position and loudspeaker placement. In order to predict the behavior of low frequency loudspeakers in small and medium size rooms a robust simulation tool has been developed.

By using the developed program different configurations of loudspeakers are analyzed from one to four loudspeakers at low frequencies on different locations in the room. Comparison of these configurations has been carried out by using quantitative parameters.

Three optimization strategies are proposed and simulated. First the equalization of the sound field at a limited listening area using Multiple point equalization is performed. Secondly the acoustic radiation power close to the loudspeaker is equalized and finally the modification of phase and delay of some of the loudspeakers is performed. The implementation of a selected configuration as well as an optimization method is performed in a real setup. The setup includes multiple loudspeakers placed in a standard listening room. Measurements have been carried out in one of the configuration in order to verify the performance of the selected optimization strategy.

2. SIMULATION PROGRAM

A numerical method based on finite-difference time-domain approximations (FDTD) has been created in Matlab to simulate multiple loudspeakers in a room. By the developed application a rectangular room is simulated using a discrete model in time and space of the sound wave equation. In this fashion the room space can be represented by a three dimen-

sional Cartesian staggered grid where particle velocity and pressure points are computed. By using this method the impulse response with a number of virtual microphones in the room can be obtained. The impulse response is the instantaneous sound pressure at a point in the room including the transfer function of one or more loudspeakers and eventually signal processing and reflections of the room. These virtual microphones can be set along a defined listening area or wherever is desired in the room. In addition to that the sound level distribution on a specified section of the room can be obtained.

The loudspeakers are implemented as point sources occupying one or more pressure or particle velocity points in the room. The simulated loudspeakers can be sealed boxes modeled as a 2nd order band pass filtered version of a Gaussian asymmetric pulse. Moreover it is possible to include a real loudspeaker impulse response of a near field measurement. The absorption coefficient of the walls can be modified as well as some of the sections of the room for example an open window or a door can be added in the simulated room.

A very useful advantage of the developed simulation is the visualization aspect. Since the method is based in the time domain an animation composed by indexed images of the instantaneous sound pressure in a desired area of the room can be rendered. These images are saved as a video file for further analysis and visualization. Moreover a graphical user interface (GUI) (seen in Fig. 17) has been developed for an easy use of the simulation program where some of the parameters can be modified as the number and location of loudspeakers, dimensions of the room, virtual microphones, delays, and gains of each loudspeaker. The developed simulation program is well described and it was tested by the authors in [7] and the theory behind it can be found in [6], [8] and [9].

3. QUANTITATIVE PARAMETERS

In order to assess the performance of the different configurations of loudspeakers a quantitative metric is needed. On a defined listening area in the room the sound field will consist on the addition of the contribution of the loudspeaker and the modal characteristics of the room. This steady state sound field will vary in amplitude according to position and frequency. In order to assess this variation two param-

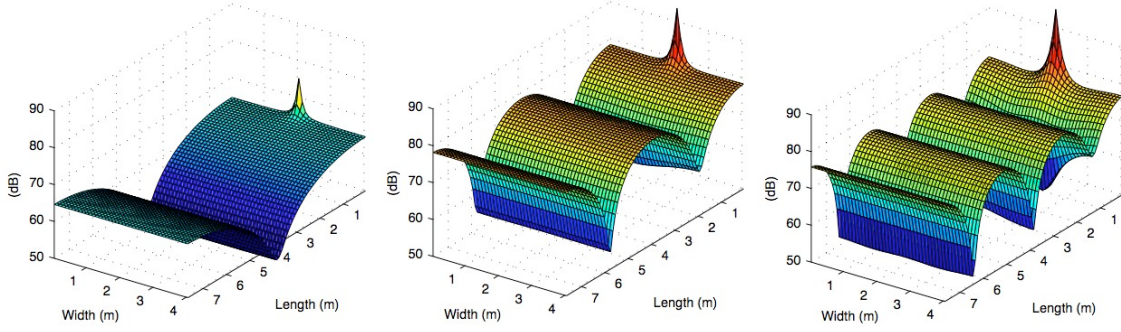

Fig. 1. Simulation of the sound pressure level (SPL) distribution averaged along 1.02 seconds in a rectangular room using the loudspeaker shown in Fig.3. Left, driven frequency 22 Hz, room mode (1 0 0). Middle 44.6 Hz, room mode (2 0 0). Right 67 Hz, room mode (3 0 0).

ters were chosen, Magnitude Deviation and Spatial Deviation.

3.1. Magnitude Deviation

If the main goal is to achieve an even sound pressure distribution along a listening area a flat frequency response should be obtained on each microphone position. To quantify how much the magnitude on each microphone position deviates from an ideal flat response the parameter *Magnitude Deviation* is used which is the standard deviation from this ideal flat response calculated across the given responses as

$$MD_{std} = \sqrt{\frac{1}{n_f - 1} \sum_{i=f_{low}}^{f_{high}} (x_i - \bar{x}_i)^2} \quad (1)$$

where n_f is the number of frequencies in the frequency range of interest from $f_{low} = 30Hz$ to $f_{high} = 150Hz$ and x_i is the i^{th} frequency and \bar{x}_i is the mean of x_i , MD_{std} is given in dB. A MD_{std} equal to 0 dB represents an ideal flat magnitude response. If the whole listening area is analyzed an average of all individual MD_{std} of positions is done to give a single descriptor.

3.2. Spatial Deviation

In order to quantify how much the magnitude varies along the listening area the parameter *Spatial Deviation* is used and it consists on the standard deviation of every single frequency from the mean level calcu-

lated across positions. The lower the value the less variation exists between positions along the listening area. The standard deviation from the responses at the microphone positions is calculated as

$$SV_{std} = \frac{1}{n_f} \sum_{i=f_{low}}^{f_{high}} \sqrt{\frac{1}{n_p - 1} \sum_{p=1}^{n_p} (x_{p,i} - \bar{x}_i)^2} \quad (2)$$

where n_f is the number of frequencies in the frequency range of interest from $f_{low} = 30Hz$ to $f_{high} = 150Hz$ and n_p is the number of microphone positions, and $x_{p,i}$ is the i^{th} frequency at position p . A SV_{std} equal to 0 dB will indicate that all magnitude responses are identical along the whole listening area.

This parameters are obtained from the N point discrete Fourier transforms (DFT) of the impulse responses generated by the simulation program. The Length of the impulse responses is $N = 2^{13}$ being 8192 samples with a sampling frequency $f_s = 8$ kHz. No smoothing was applied.

4. ANALYSIS

In the following section a briefly insight to the theory behind the sound fields in rectangular rooms is presented followed by an analysis of different loudspeaker configurations using up to four low frequency loudspeakers. Finally the effect of loudspeaker placement is illustrated on two loudspeaker configurations.

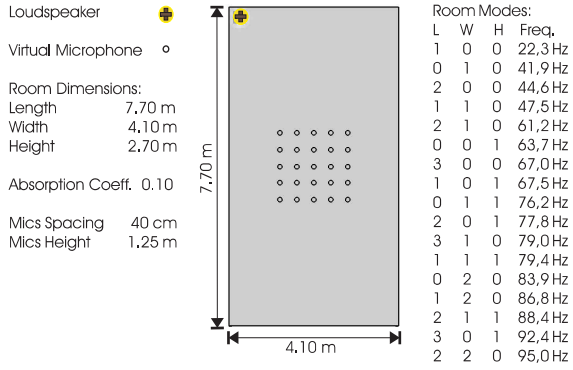

Fig. 2. Virtual room to be simulated seen from above, dimensions, shape, loudspeaker position and calculation of the first 17th room modes are presented.

4.1. Room Modes

The purpose of this paper is not to analyze in deep the modal theory. Nevertheless the sufficient background is presented here to support the further analysis. When low frequency sound is confined in a rectangular environment it will experience certain changes. Assuming a rectangular room with rigid walls and if a loudspeaker is placed at the end wall of the longest dimension of the room, reproducing continuously a pure tone of frequency where half of the wavelength corresponds to that dimension, the sound wave will reflect at the opposite wall and meet at the middle of the room in opposite phase with the wave traveling directly from the loudspeaker. This will cause destructive interference in the middle of the room at this particular frequency and the traveling wave will again hit the wall with the loudspeaker in phase with the loudspeaker. It will also occur at frequencies where an integer multiple of half of the wavelength corresponds to one or more of the dimensions of the room (see Fig. 1). This phenomena it is often called standing wave, or *Mode* each mode is related to a certain *natural frequency* given by

$$f_n = \frac{c}{2} \sqrt{\left(\frac{n_x}{l_x}\right)^2 + \left(\frac{n_y}{l_y}\right)^2 + \left(\frac{n_z}{l_z}\right)^2} \quad (3)$$

Where c is the speed of sound in the air, n_x , n_y and n_z are integers starting with 0, 1, 2, ... and l_y , l_x , l_z are the dimensions of the room. The room modes can be grouped in *Axial Modes* where only one of the integers n_x , n_y , n_z is > 0 , *Tangential Modes* which are two dimensional and two of the integers n_x , n_y , n_z are > 0 and the *Oblique Modes* that are three dimensional, where all three integers n_x , n_y ,

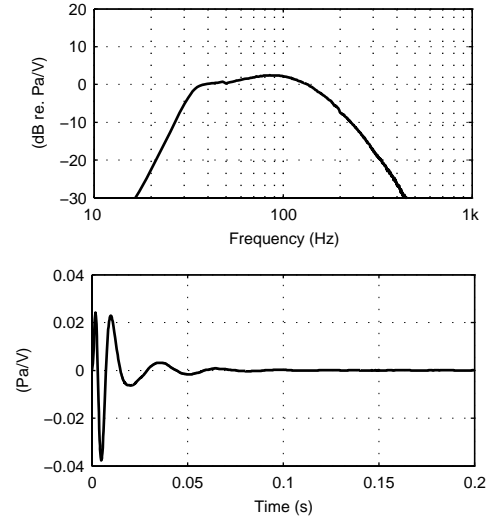

Fig. 3. Frequency response (upper) and time response (lower) of the real loudspeaker included in the simulations.

n_z are > 0 . The zones where there will be minimum sound pressure level are called *nodes* and the points where exists a maximum of sound pressure are called *anti nodes* [10]. In Fig. 2 the first room modes of a rectangular room are calculated using Eq. (3).

4.2. Evaluation of Loudspeaker Configurations

Extensive experimental investigation has been done by Welti in [11] where up to 16 subwoofers have been used on different configurations in a rectangular room. Results in this investigation have shown that by increasing the number of loudspeakers a significant improvement is achieved on a centered listening area. Moreover those results shown that symmetrical configurations give better results than non-symmetrical ones.

On this paper up to six configurations are chosen to be simulated in a virtual room. The reason of choosing this configurations is that they present special characteristics that could be used for sound reproduction systems. Since human sound localization is quite poor at low frequencies then it is possible to add more loudspeakers with out destroying the perceived sound image.

A rectangular room with an absorption coefficient of 0.10 in all walls is rendered with the created simulation program in Matlab. The virtual room is slightly similar to a standard listening room at the Acous-

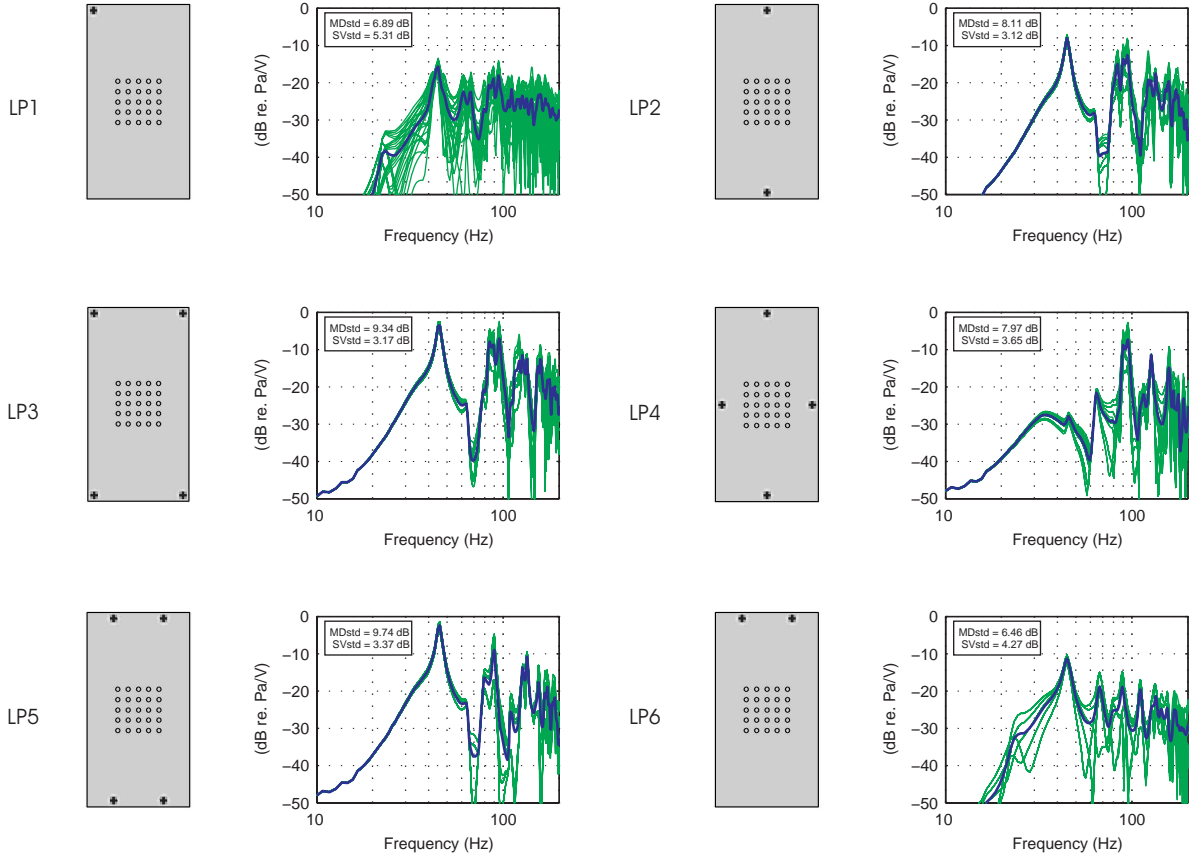

Fig. 4. Frequency responses from the simulated configurations are shown together with the room and the position of the loudspeaker seen from above. Green lines are the responses at each virtual microphone on the listening area. Blue lines are the mean. The averaged MD_{std} of all responses and the SV_{std} values are presented in every configuration.

tic department at Aalborg University. In Fig. 2 the simulated room is presented seen from above as well as the calculation of its room modes. A centered listening area in the room at a height of 1.25 m is defined by 25 virtual microphone positions spaced by 40 cm from each other. A cell size grid of 10 cm has been used to discretize the room. The magnitude deviation MD_{std} and the Spatial Deviation SV_{std} are calculated on each configuration of loudspeakers. An impulse response of a real loudspeaker has been used in the simulations which can be seen in Fig. 3 together with its frequency response. All the loudspeakers are fed with the same signal and positioned 25 cm above the floor and 25 cm from the walls or at centered positions.

As it can be observed in Fig. 4 configuration LP2 with two loudspeakers at mid points on opposite

walls along the longest dimension of the room has the lower Spatial Deviation with an SV_{std} value of 3.12 dB but in the other hand it has a high magnitude deviation value being MD_{std} 8.11 dB, similarly configuration LP3 has a low SV_{std} value being 3.17 dB and a high MD_{std} of 9.34 dB. Although configuration LP5 has the highest MD_{std} it presents a quite low variation across positions. Configuration LP4 is the one that presents a fair compromise between variation across positions and magnitude deviation. Even though configuration LP1 with one loudspeaker in the corner has the lower MD_{std} value it has the highest variation across positions having a SV_{std} value of 5.31 dB nevertheless it is the one that seems to excite all room modes more evenly, a similar behavior shows configuration LP6 improving the MD_{std} and SV_{std} compared to LP1.

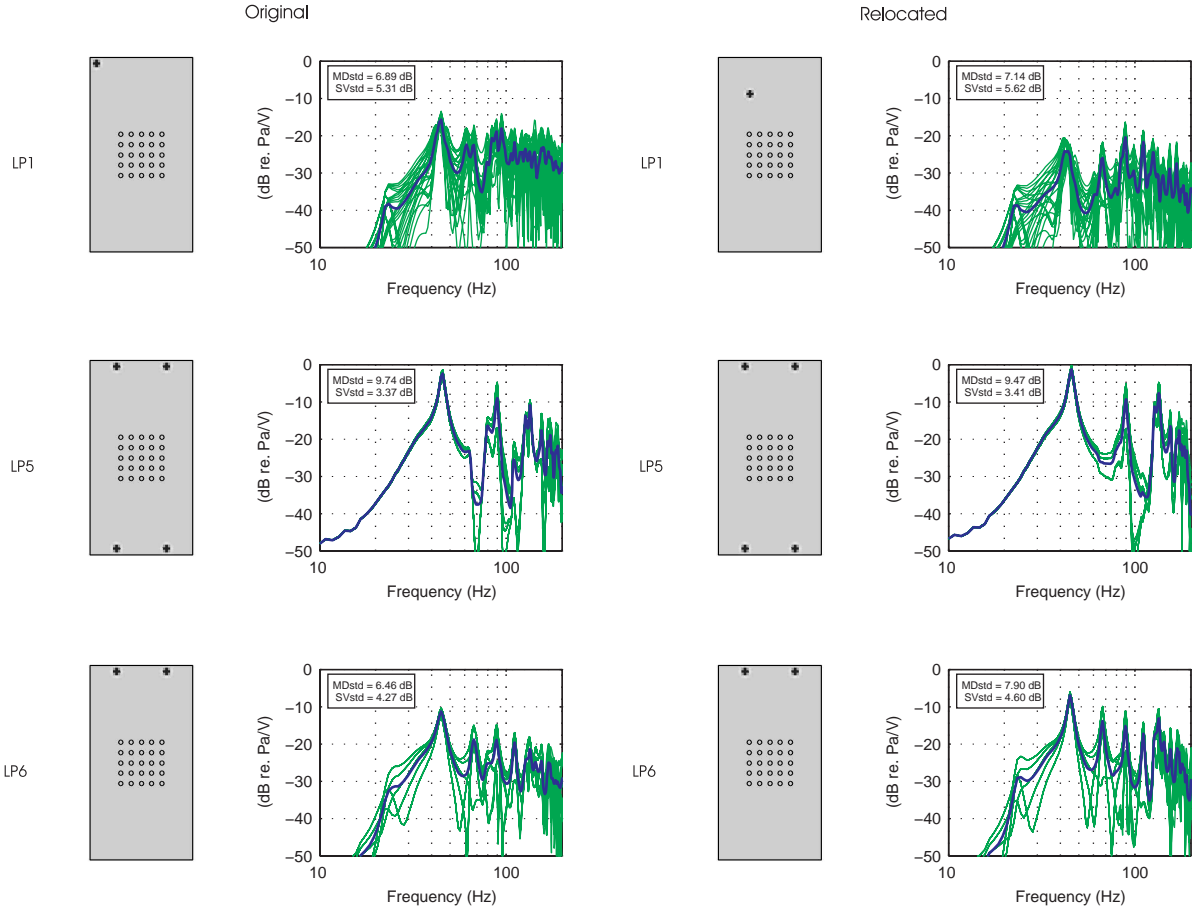

Fig. 5. Green lines are the frequency responses at each virtual microphone in the listening area. Blue lines are the mean. Left plots are the frequency responses of original configurations LP1, LP5 and LP6. Right plots are the relocated configurations. In LP1 (relocated) the loudspeaker is 1.25 m off the lateral wall, 1.65 m from the front wall and at a height of 0.75 m. In LP5 and LP6 both (relocated) the loudspeakers are raised at a height of 1.25 m.

What it can be observed in Fig. 4 is that on configurations LP2, LP4 and LP5 where the loudspeakers are on opposite walls and particularly in LP2 and LP4 where the loudspeakers are located at mid points they cancel out the room modes with odd n_x , n_y , n_z integers and excite strongly the room modes corresponding to even integers (see Eq. (3)). The axial room modes that have odd integers are those that present a node or minimum pressure at centered positions in the room. On the contrary the axial room modes that have even integers are those which present an anti node or maximum pressure at centered positions in the room. For example seen Fig. 4 in configuration LP2 and LP5 the room mode (3 0 0) corresponding to 67 Hz is heavily suppressed and from LP2 to LP4 the room mode (1 1 0) corre-

sponding to 47.5 Hz it is canceled out as well.

After this analysis one can verify that by increasing the number of loudspeakers the variation across positions is improved at expenses of an increment on the magnitude deviation at every position. If the loudspeakers are located at opposite walls and at mid points they can cancel out some of the room modes but in the other hand increasing others. After this observations one can propose that if the system in question will be equalized, increasing the number of loudspeakers at mid positions will be favorable. This is because less microphone positions need be used to have a knowledge of the sound field to implement some kind of equalization. Besides that a single equalization filter can work for all loudspeakers and more listening positions will benefited. If the

system will not be equalized the configuration LP6 with two loudspeakers on the front wall and LP2 with one loudspeaker in the corner can work up to some extension. It should be pointed out that this two loudspeaker configurations can be improved by for example optimizing its placement. In the next section the effect of repositioning the loudspeakers will be presented.

4.3. Positioning

In case of having just one low frequency loudspeaker it is well known that if it is placed within the room at a anti node that resonance will be strongly excited, and if the loudspeaker is located in a node that particularly mode will be weakly excited, this is often referred as if the sound source is well coupled to the room or not. The only position that ensure that all room modes are strongly excited it is in a corner position, since all room modes have an anti node at the corners. Moreover a loudspeaker in the corner will experience an increment in power of 8 times that means approximately + 9 dB. If the room in question it is a middle size room with a reverberation time T60 at 500 Hz of approx. 0.5 seconds it is recommended that the sound source will be well coupled to the room in order to have a good balance between mid frequencies and low frequencies although some coloration at low frequencies will be inevitable [12]. A well coupled room loudspeaker will mean an amplification on the power output of the loudspeaker. This might be beneficial for a loudspeaker with a poor frequency response at low frequencies.

From Fig. 5 in configuration LP1 it can be observed that the loudspeaker excites evenly all room modes, moreover if some improvement is required one could relocate the loudspeaker moving it close to a node correspondingly to every axial dimension. That situation can be for example to move the loudspeaker in configuration LP1 25 % off from the walls on each dimension. Care should be taken to avoid that the reflection coming from every corner wall cancel out the loudspeaker itself. When ever a loudspeaker is close to a corner it experiences seven reflections, 3 coming from the walls, 3 coming from bi corners and one from a tri corner. In order to avoid this situation one should keep the distances of the three walls as different as possible but also keep the bi corner

reflection away from overlap a wall reflection.

The effect of relocating the loudspeaker in LP1 is shown in Fig. 5 at upper plots, where the loudspeaker has been moved from the corner to 1.25 m away from the lateral wall, 1.65 m beneath the front wall and raised to a height of 0.75 m. From this plots it can be observed that an overall reduction in power has been obtained. Besides that a reduction on the excited resonances is experienced, specially on the axial room modes (0 0 1) and (3 0 0) corresponding to 63.7 Hz and 67 Hz respectively. Interestingly the averaged magnitude deviation at all positions and the spatial deviation have been slightly increased.

In Fig. 5, the effect of moving the loudspeakers in the symmetrical configuration LP5 at a height of 1.25 m can be seen. As it can be observed only a few modes are excited and since that height corresponds to almost the mid point of that dimension the mode (1 1 1) corresponding to 79.4 Hz has been suppressed. Nearly only three room resonances are being strongly excited which are the ones with even integers, (see Eq. (3)). It should be pointed out that this configuration may not be pleasant to listen with out some kind of control or equalization since the resulting room modes excited will be excessively boosted. Nevertheless this setup will simplify the equalization process.

5. OPTIMIZATION STRATEGIES

In the next section three optimization strategies are proposed and simulated, first a multiple point equalization is presented followed by the equalization of the radiated power of the loudspeakers and finally the modification of delay and phase of loudspeakers. The three approaches are applied to the loudspeaker configuration LP5 (relocated). Along this section the absorptions coefficients of the simulated virtual room have been changed to a more realistic room environment being, walls 0.12, floor 0.15 and ceiling 0.2. The virtual room dimensions have been kept the same as in section 4.

5.1. Multiple Point Equalization

Different approaches have been developed in the last years to overcome a solution of equalizing a loud-

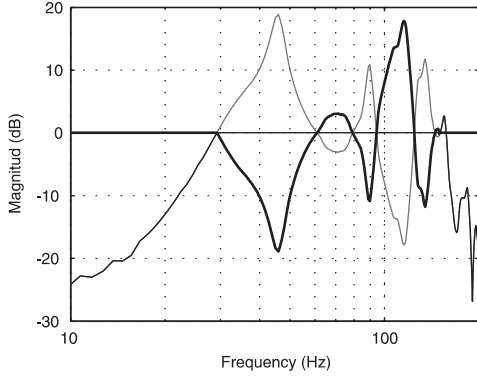

Fig. 6. Resulting filters for the multiple point equalization technique. Thin (gray) curve is the normalized average. Thick (black) curve is the equalization filter. Thin (black) curve is the equalized average.

speaker in a room [1], [2], [3]. This approach called multiple point equalization can achieve perfect equalization at multiple points when the number of sources is more than the number of equalization points. In the case of loudspeaker configuration LP5 (relocated) perfect equalization would be achieved for only four microphone positions if these approaches are applied. After seeing Fig. 5 in LP5 (relocated) one can observe that within the working range of the loudspeakers the frequency response is more or less similar at all positions in the listening area, since this configuration shows a low value SV_{std} . After these observations one would suggest that an inverse filter obtained from the averaged frequency responses can work for an extended listening area.

After obtaining the impulse responses at the 25 listening positions an average in the frequency domain has been performed. Since the filtering is done offline the sampling frequency has been kept the same as in the simulation program being $f_s = 8$ kHz. Subsequently the average has been normalized to the corresponding level of 30 Hz which is the cut-off frequency of the loudspeakers. The frequency bins from 0 to 30 Hz and from 150 Hz to the Nyquist frequency have been set to 0 gain. In order to be sure that the system is causal and stable the minimum-phase has been calculated using homomorphic filtering [13], this assures that all poles and zeros are inside the unity circle so a stable inverse exists. Next the filter has been inverted and a direct finite impulse response (FIR) is acquired, in Fig. 6 the resulting FIR filter can be seen in the frequency domain. After this process the resulting filter is loaded into the simulation program and applied to the loudspeakers in

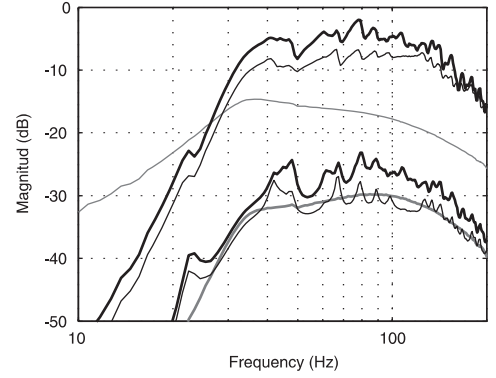

Fig. 7. Upper (thick black) curve is the pressure at 10 cm close to the loudspeaker located in the corner of the room. Upper (thin black) curve is the pressure at 10 cm close to the loudspeaker in an arbitrary position in the room. Upper (thin gray) curve is the volume velocity. Lower curves are the radiated sound power, in the corner (thick black) and in an arbitrary position in the room (thin black). Lower (thick gray) curve is the radiated power in anechoic conditions.

LP5(relocated) configuration.

5.2. Equalization of Acoustic Radiation Power

In order to improve the coupled system loudspeaker-room it is necessary to know how the loudspeaker will interact with the room. This means in what degree the loudspeaker will excite the room resonances or not excite them at all. This will depend on a number of factors such as the placement of the loudspeaker, its own characteristics, the reverberation time of the room at different frequencies and so on. At low frequencies where the room dimensions are comparable with those wavelengths loudspeakers are not constant power generators. Below the Schroeder frequency which is where three overlapping room modes occur the statistical theory of sound fields in rooms can not be applied [14]. Since at low frequencies a closed box loudspeaker acts as a point source radiating sound equally in all directions the radiated acoustic power can be calculated from its volume velocity and its radiation resistance. The acoustic load of a loudspeaker placed in different environments will be reflected directly on the sound power radiated by the source.

The total power radiated by the source can be written as:

$$W = \frac{1}{2} U \cdot U^* \operatorname{Re}(Z_r) \quad (4)$$

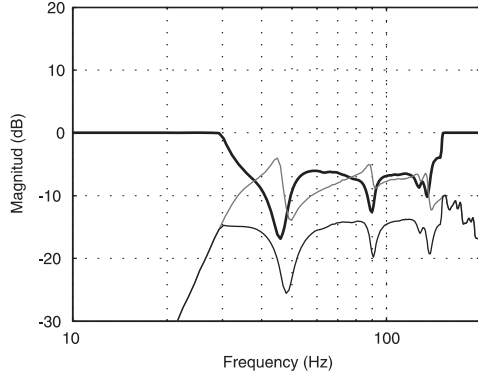

Fig. 8. Upper plot (thick) curve is the resulted FIR filter from the radiated power, (thin gray) curve is the pressure before equalization, (thin dark) is the pressure near the membrane after equalization.

where W is the average radiated power, U is peak volume velocity generated by the loudspeaker ($*$ indicates the complex conjugate), $Re(Z_r)$ is the radiation resistance (Re indicates the real part), and Z_r is the radiation impedance. Considering the diaphragm of the loudspeaker of area S moving with a normal velocity component u then the radiation impedance is expressed as

$$Z_r = R_r + jX_r \quad (5)$$

where X_r is the radiation reactance and R_r is the radiation resistance. Since the acoustical impedance of the loudspeaker radiator is higher than the radiation impedance, changes in the radiation impedance have small effect on the volume velocity. Thus it can be said that a loudspeaker is a constant volume velocity source [12], [14], [15].

If the response of the loudspeaker in free field is known, the volume velocity can be estimated. Assuming the loudspeaker to be a baffled simple source and for $ka \ll 1$, being k the wave number and a the radius of the membrane, the radiation resistance can be calculated from

$$R_r = \frac{1}{2\pi} \rho c (kS)^2 \quad (6)$$

and the radiation reactance become $X_r = j\rho c Ska$ therefore from the radiation impedance

$$Z_r = \frac{p}{U} = R_r + jX_r \quad (7)$$

where R_r is the real part of $\frac{p}{U}$ the volume velocity U can be obtained using the known pressure in free

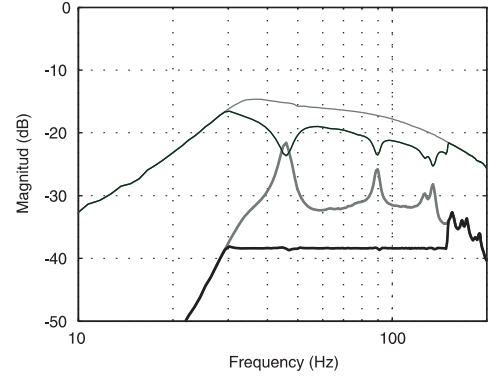

Fig. 9. Upper (thin gray) curve is the volume velocity before equalization of the radiated power, (thin dark) is the volume velocity after the equalization. Lower curve (thick gray) is the radiation power before equalization and (thick dark) is the radiation power after being equalized.

field conditions from

$$U = \frac{p}{Z_r} \quad (8)$$

having U then the radiated power by the loudspeaker can be obtained by substitution of $\frac{p}{U}$ in

$$W = \frac{1}{2} \cdot U \cdot U^* Re\left(\frac{p}{U}\right) \quad (9)$$

where p is the pressure close to the membrane and U is the peak volume velocity.

In Fig. 7 the acoustic power radiated by a loudspeaker in the corner and in an arbitrary position within the room can be seen. Although the sound pressure will variate according to the position of the listener it is clear that by this curves one can predict which room modes this loudspeaker will excite.

After this theoretical background the proposed method is to measure the acoustic radiation power close to the loudspeaker and obtain a filter to attenuate the room influence. A similar approach has been used in [16] where the radiation resistance is equalized or replaced by one measured in a reference room. Indeed the room modes will not be suppressed, they will be there any way but they will not be excited as strong as the other frequencies.

After being measured the acoustic pressure at 10 cm near the loudspeakers on configuration LP5 (relocated) the radiated power is calculated as explained before. Since both the room and the setup LP5 are symmetric it is sufficient to used just one measurement in front of one of the loudspeakers. From this

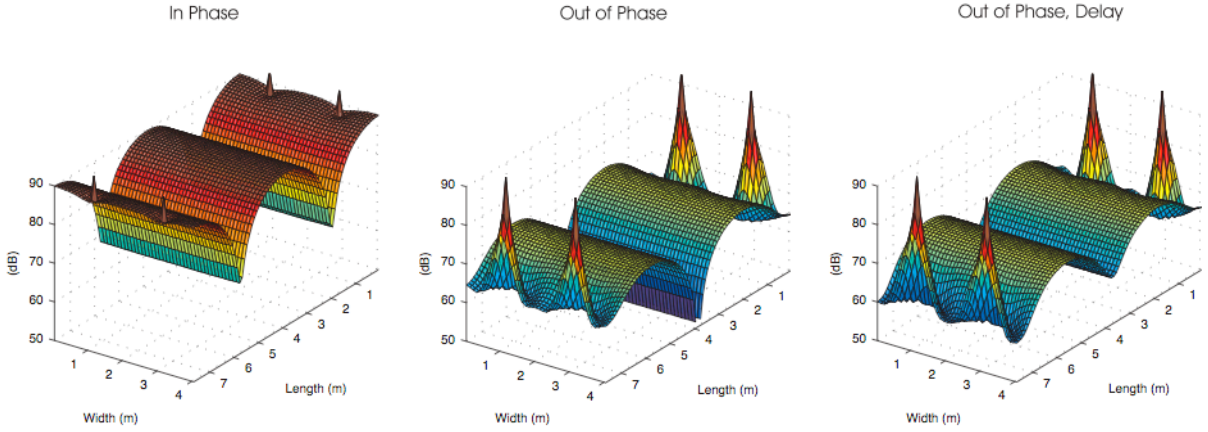

Fig. 11. Sound pressure level distribution in the Virtual Room at 1.25 m height. Frequency reproduced: 46 Hz. Left, all the loudspeakers are in phase. Middle, rear loudspeakers are out of phase. Right, rear loudspeakers are delayed and out of phase.

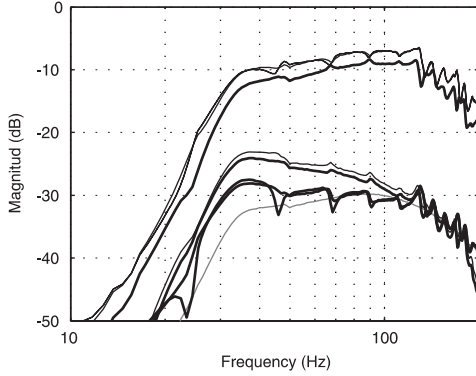

Fig. 10. Upper (thin dark) curves are the acoustic pressure both front and rear loudspeakers before the adjusting of amplitude. Upper (thick dark) curve is the acoustic pressure of rear loudspeakers after the adjusting. Middle (thin dark) curve is the radiated power at the rear loudspeakers before the adjusting. Middle (thick dark) curve is the radiated power at the rear loudspeakers after the adjusting. Lower (thick dark) curves are the radiated power of front loudspeakers before and after the adjusting. Lower (thin gray) is the radiated power in anechoic conditions.

measure a target filter is prepared in the frequency domain by normalizing the curve to 0 gain at the level of 30 Hz. Then the target filter is squared and inverted. The frequency bins from 0 to 30 Hz and from 150 Hz to the Nyquist frequency have been set to 0 gain. Having shaped the target filter a digital FIR filter is acquired as it is shown in Fig. 8. This procedure is done by using the frequency sampling-based design [17]. Afterwards the minimum-phase of the FIR filter has been calculated the same manner as in section 5.1 and loaded into the simulation pro-

gram. In Fig. 9 the radiation power before and after the equalization is presented as well as the volume velocity.

5.3. Optimization by Modifying Delay and Phase

A very intuitive approach is used to minimize the effect of the excited room modes. Since by this loudspeaker configuration LP5 (relocated) mainly the axial modes corresponding to the longest dimension of the room are excited one can use the principle of absorption by using the rear loudspeakers as acoustic absorbers.

A pure delay of 21.7 ms corresponding to the distance from the front loudspeakers and the back wall has been applied to the rear loudspeakers. Apart of the delay they have been inverted in phase so they will cancel out the wave front coming from the front loudspeakers. In Fig. 11 the effect of this procedure can be seen, in the left plot all the loudspeakers are reproducing 46 Hz as a result the room mode (2 0 0) is hardly excited and a very high sound pressure is measured in the center of the room. Differently in the middle plot when the rear loudspeakers are out of phase an attenuation of more than 50 dB occurs at the center of the room and in the right plot when the rear loudspeakers are delayed and inverted in phase the sound pressure level in the center of the room has been decreased by just 27 dB.

A similar approach has been proposed before by El-

liot and Johnson for noise control in [18] and [19] where a method of adjusting a secondary source to minimize the total power output of both primary and secondary sound sources is achieved. In this method the volume velocity of the secondary source is adjusted to be inverted in phase and gradual increment in amplitude to absorb power from the primary source is performed.

In this paper it has been found that if the rear loudspeakers are adjusted to be out of phase an almost complete cancellation of sound is achieved in the center of the room. Since the listening area is at centered position therefore the pure delay is applied obtaining a reasonable reduction in sound pressure and not a complete cancellation. This effect is illustrated in Fig. 11 as it is noted the room mode is effectively suppressed by inverting the phase of the rear loudspeakers. By adjusting the amplitude of the rear loudspeakers it is possible to achieved a more even sound pressure level distribution.

In order to adjust the amplitude of the rear loudspeakers the radiated sound power has been measured as explained in section 5.2. The rear loudspeakers have been set to -6 dB and the radiated power has been measured and stored. Next the rear loudspeakers have been set to -5 dB and so on up to +3 dB in increments of 1 dB. After this procedure it has been found that the rear loudspeakers have to have -2 dB gain compared to the front ones in order to absorb enough power from the front loudspeakers and minimize the total radiated power. This can be observed in Fig. 10 where the radiated power from both front and rear loudspeakers is shown before and after the adjusting in amplitude of the rear loudspeakers. This adjustment is just good enough for this room the situation may change in another room with for example different composite walls.

6. RESULTS

The results of the three optimization methods for this particular loudspeaker configuration LP5 (relocated) are shown in Fig. 13 and Fig. 15 as surface plots arranged as rows of the listening area in the room. As it is observed in Fig. 13 the three methods removed the peaks and particularly the method of adding delay and inverting the phase showed a better performance than the others. After this results a validation measurement is presented in the next

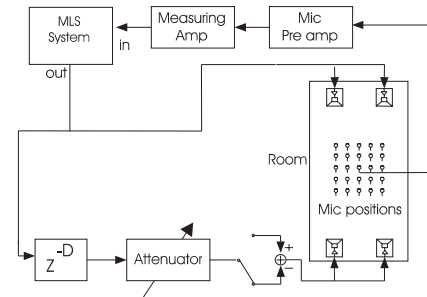

Fig. 12. Measurement setup used to calibrate the system and for acquisition of the impulse responses at the listening area.

section followed by discussions on the results and measurements.

7. MEASUREMENTS

After simulating the three optimization strategies it has been decided to test the last optimization method on configuration LP5 (relocated) in a real room. Four closed box active loudspeakers have been used as in Fig. 5, LP5 (relocated) at a height of 1.20 m and 1 m from the lateral walls. The frequency response of the loudspeakers can be seen in Fig. 3. The standard listening room of the Department of Acoustics at Aalborg University has been used to carry out the measurements, it has the following dimensions, Length 7.80 m, Width 4.12 m and a height of 2.77 m. The room has an averaged reverberation time T60 of 0.47 s. The floor has a carpet and it is wooden, the walls are covered with special panels that can be removed or moved to different positions. The ceiling is curved in the corners covered with special plaster panels [20]. The phase on the rear loudspeakers has been inverted. A digital delay and an attenuator have been connected before the rear loudspeakers (see Fig. 12). The system has been calibrated to have the same input level to all the active loudspeakers. The delay for the rear loudspeakers has been adjusted so the sound pressure at 44.1 Hz (the room mode frequency) is minimum at a centered position within the listening area in the room. Afterwards the rear loudspeakers have been adjusted increasing the gain in the attenuator from -4 dB to + 4 in steps of 1 dB. It has been found that a gain of + 2 dB was the optimum to attenuate the room mode at 44.1 Hz so it has the same amplitude as neighbor frequencies. After the calibration of the system the impulse response has been measured at the 25 microphone positions in the listen-

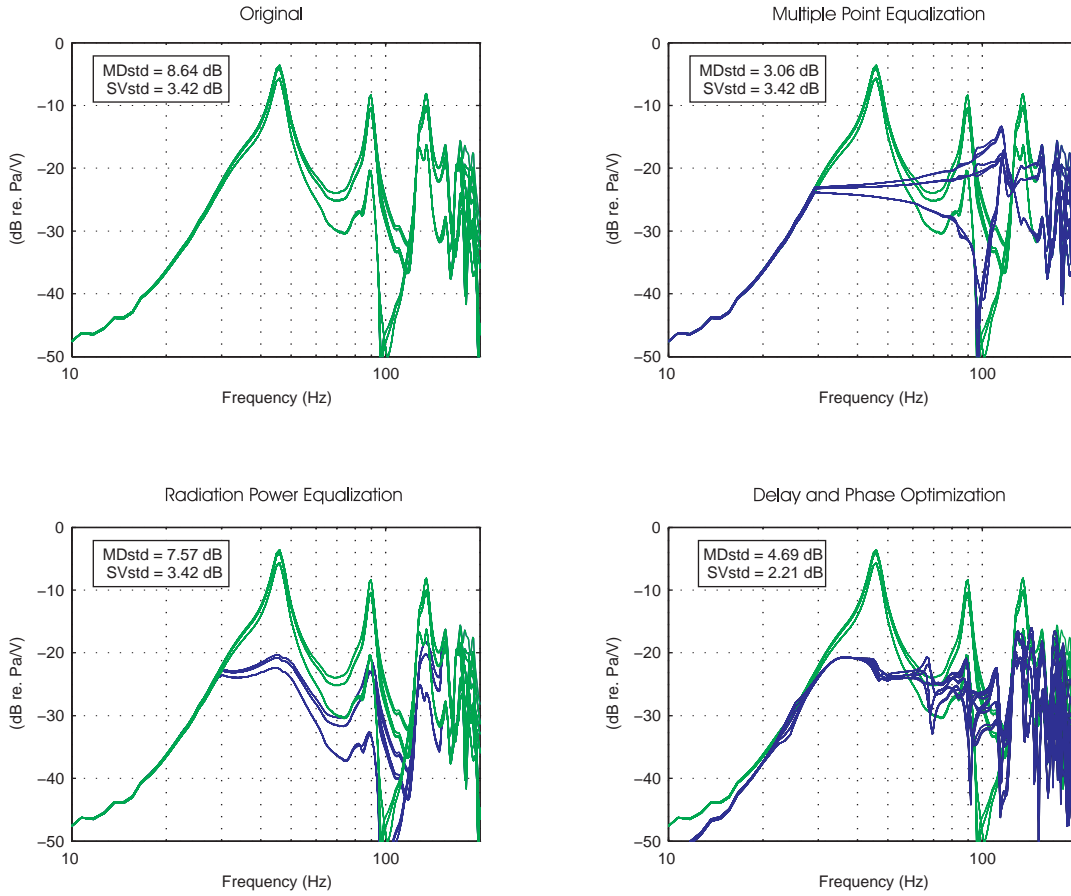

Fig. 13. Upper left are the frequency responses at the 25 virtual microphones positions in the listening area of configuration LP5 (relocated). Upper right are the equalized responses by Multiple point equalization (blue), not equalized (green). Lower left are the equalized responses by radiated power equalization (blue), not equalized (green). Lower right are the equalized responses by Modification of delay and phase (blue), not equalized (green)

ing area. the results of the measurement can be seen in Fig. 14 where the simulations are compared with the measurements and in Fig. 16 they are presented as surface plots.

As it can be seen in lower right plot in Fig. 14 Although some variations in amplitude exists the system has removed the peak corresponding to the room mode by 10 dB. The next room mode corresponding to 67 Hz has also been attenuated by almost 7 dB. It can also be observed that some of the notches are removed or minimize. Even though the system did not performed as perfect as the simulation a significant improvement has been achieved. The variations may be happen due to small variations on the adjustment of the system to its optimal performance. It has to be mentioned that the metric MD_{std} of the magnitude deviation do not really reflect the improvement, since a reduction of more

than 6 dB in sound pressure level would be very noticeable. As for the spatial deviation the number SV_{std} shows a very small improvement. This may be due to some asymmetries in the room.

8. DISCUSSIONS

After observed the simulations in Fig. 13 and Fig. 15 it can be said that the second method of equalization of radiated power removes only the peaks on the responses and interestingly the spatial variation did not change being SV_{std} 3.42 before and after the equalization. In this method the magnitude deviation it is improved by only 1.05 dB. This method can be used to remove part of the influence of the room, and if the system is completely symmetric it does not need many measurements.

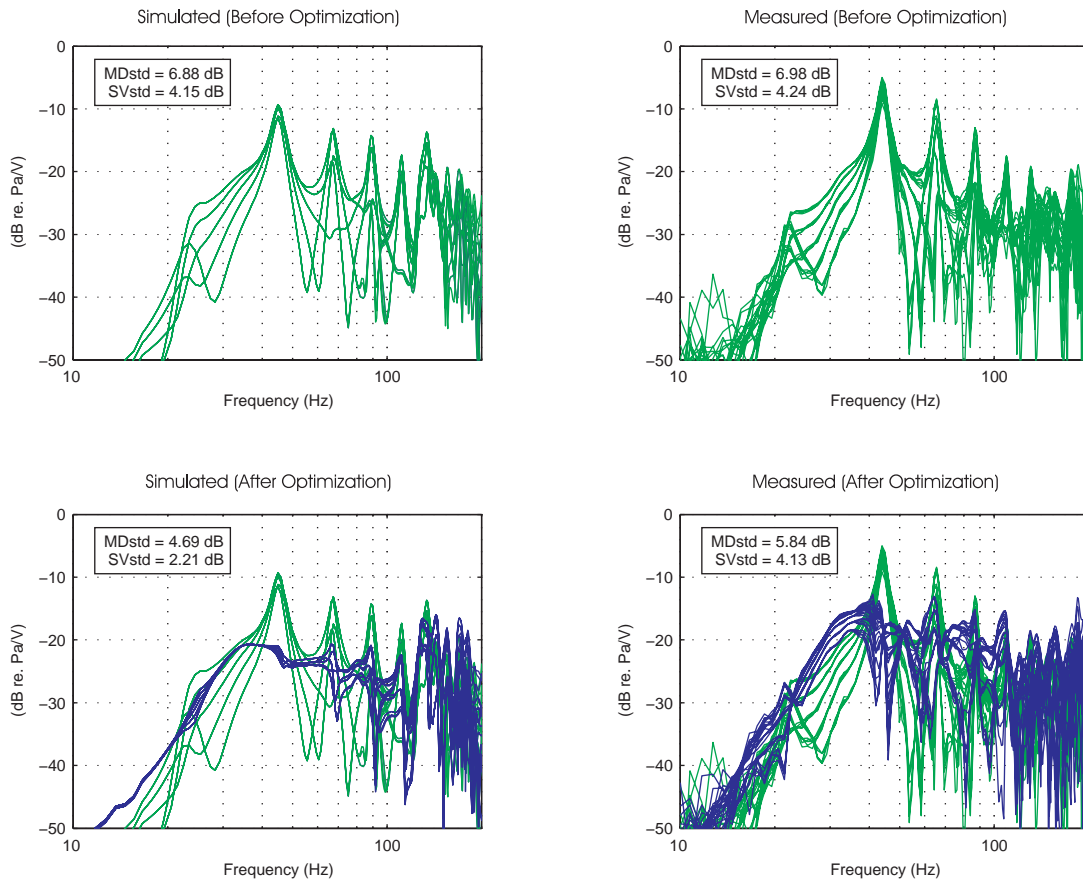

Fig. 14. Left column are simulations of front loudspeakers with out the optimization (upper green). Left (lower blue) are simulations of front and rear loudspeakers with the optimization system, (background green) the same as upper with out optimization. Right (upper green) column are the measurements with only front loudspeakers and no optimization. Right (lower blue) are the measurements with the rear loudspeakers and the delay and phase inversion, (background green) the same as upper with out optimization.

The method of multiple point equalization can achieved a quite good equalization from 30 Hz up to 70 Hz and the average of the magnitude deviation at the microphone positions has been improved from a MD_{std} value of 8.64 dB to 3.06 dB. It can be seen that although this method produces quite flat responses it does not improve the spatial deviation. Besides that after seen the shape of the filter applied to the loudspeaker in this method on Fig. 6 a high boost from 90 Hz to around 120 Hz it is applied to the loudspeaker, that may cause non linear distortion. In this approach the room mode frequencies are heavily attenuated so it can be said that so much energy has been wasted.

In comparison with the other two methods by modifying the phase and applying a delay to the rear loudspeakers a very interesting improvement is achieved, as seen in Fig. 13 the two room modes have been

effectively removed and the spatial deviation has been improved from a SV_{std} value of 3.42 dB to a SV_{std} value of 2.21 dB. A quite good equalization is achieved from 30 Hz to 70 Hz starting to deteriorate as the frequency is increased. This method can be used using the rear loudspeaker on a limited range from 30 Hz to 60 Hz by for example low pass filtering the rear signals. Contrasting to the other two methods one can say that this method has a better performance since no filtering is included, only a pure delay and phase inversion is used so no increment in power is delivered to the loudspeaker at certain frequencies. Actually the rear loudspeakers are used as absorbers of energy to remove reflections from the back wall and thereby reducing the room modes.

In a real setup it has been confirmed that the system with the delay and phase inversion works sufficiently to removed the room modes and improve

also the notches situation. The other two methods will also take care of the peaks by applying heavy filtering. Nevertheless in the delay and phase inversion method a more precise procedure to adjust the rear loudspeakers should be found out in order to calibrate the system to its optimum performance. In connection to the evaluation parameters we should find a more realistic parameter since the magnitude deviation MD_{std} does not really reflect what it is perceived. Since it is well known that the notches are less audible than the peaks therefore by smoothing the frequency curves the notches will be some how hidden and a better descriptor may be obtained. A similar approach has been used in [11] where the metric descriptors are obtained from smoothed frequency responses.

9. CONCLUSIONS

In this paper a robust simulation program has been developed to simulate and predict the behavior of multiple low frequency loudspeakers in rectangular rooms. A graphical user interface has been made for an easy use of the simulation program. An animation composed by indexed images of the instantaneous sound pressure in the room can be obtained for analysis purpose. Simulations have been performed placing from one to four loudspeakers in the room at different locations. By using more than one loudspeaker a significant improvement has been observed on the sound pressure level distribution along a listening area. It is confirmed that symmetrical configurations remove the room modes of odd integers and improve the spatial variation at centered positions. After the evaluation of 6 configurations with up to 4 loudspeakers, three methods of optimization have been proposed and simulated on one of the configurations. Four loudspeakers in a virtual room have been simulated, two on the front wall and two on the rear wall at a height of 1.25 m. The proposed optimization methods are, first the multiple point equalization secondly the equalization of the radiated power closed to the membrane of the loudspeakers and finally the addition of a delay and inversion of phase on the rear loudspeakers. Among the three methods the method of adding delay and phase inversion shown a better performance in terms of simplicity and efficient use of energy, since the rear loudspeakers act as acoustical absorbers therefore a significant improvement on the sound field

in the room is achieved. This system removes effectively the room modes and it diminishes some of the notches at a centered listening area in the room. The system of adding delay and phase inversion has been tested in a real room. Although the adjustment of the system has to be quite precise it shows an acceptable performance. Further investigation should be carried out on finding an effective procedure on the adjustment of the system and on the compatibility with standard sound reproduction systems from stereo to 5.1 multichannel setups.

References

- [1] S. J. Elliott and P. A. Nelson, "Multiple-Point Equalization in a Room Using Adaptive Digital Filters," *J. Audio Eng. Soc.*, vol. 37, pp. 899-907. (November 1989)
- [2] P. A. Nelson, F. Orduña-Bustamante and H. Hamada, "Inverse Filter Design and Equalization Zones in Multichannel Sound Reproduction," *IEEE Trans. Speech Audio Process.* vol. 3, pp. 185-192. (1995)
- [3] R. Walker, "Equalization of Room Acoustics and Adaptive Systems in the Equalization of Small Room Acoustics," *Proceedings of AES 15th International Conference, Audio, Acoustics & Small Spaces*, pp. 32-47. (November 1998)
- [4] J. B. Allen and Berkley, "Image Method for Efficiently Simulating small-room acoustics," *J. Acoust. Soc. Am.*, vol. 65, pp. 943-950. (1979)
- [5] A. Krokstad, "Calculating the Acoustical Room Response by the Use of a Ray Tracing Technique," *J. of Sound and Vibration*, vol. 8, pp. 118-125. (1968)
- [6] D. Botteldooren, "Acoustical Finite-Difference Time-Domain Simulation in Quasi-Cartesian Grid," *J. Acoust. Soc. Am.*, vol. 95, pp. 2313-2319. (May 1994)
- [7] A. Celestinos, "Multi-source low frequency room simulation using finite difference time domain approximations," *Proc. AES 117th Convention*, Convention Paper 6264. (October 2004)
- [8] D. Botteldooren, "Finite-Difference Time Domain Simulation of Low-Frequency Room Acoustic Problems," *J. Acoust. Soc. Am.*, vol. 98, pp. 3302-3309. (December 1995)
- [9] S. K. Olesen, "Low Frequency Room Simulation using Finite Difference Equations," *Proc. AES 102nd Convention*, Preprint 4422 (D2). (March 1997)
- [10] L. E. Kinsler, *Fundamentals of Acoustics*, 4th. Ed. John Wiley & Sons, Inc. (2000)
- [11] T. Welti, "How Many Subwoofers are Enough," *Proc. AES 112th Convention*, Convention Paper 5602. (May 2002)

- [12] J. Borwick, *Loudspeaker and Headphone Handbook*, Butterworth & Co. (1988)
- [13] A. V. Oppenheim, *Discrete-Time Signal Processing*, Second Ed. Prentice Hall. (1998), pp. 788-792
- [14] T. Salava, "Acoustic Load and Transfer Functions in Rooms at Low Frequencies", *J. Audio Eng. Soc.*, vol. 36, pp. 763-775 (1988 October).
- [15] K. O. Ballagh, "Optimum Loudspeaker Placement Near Reflecting Planes", *J. Acoust. Soc. Am.*, vol. 31, pp. 931-935 (1983 December).
- [16] J. Abildgaard Pedersen, "Adjusting a loudspeaker to its acoustic environment", *Proc. AES 115th Convention*, New York, convention paper 5880, (2003 October).
- [17] S.K. Mitra, *Digital Signal Processing A Computer Based Approach*, First Ed. McGraw-Hill. (1998), pp. 462-468
- [18] S. J. Elliot, P. Joseph, P.A. Nelson, and M. E. Johnson, "Power output minimization and power absorption in the active control of sound," *J. Acoust. Soc. Am.*, vol. 90, pp. 2501-2512. (November 1991)
- [19] M. E. Johnson and S. J. Elliot, "Measurement of acoustic power output in the active control of sound," *J. Acoust. Soc. Am.*, vol. 93, pp. 1453-1459. (March 1993)
- [20] B. Langvad, H. Møller and G. Budzynski "Testing a New Listening-Room," *Archives of Acoustics*, vol. 14, 1-2, pp. 45-60. (1989)

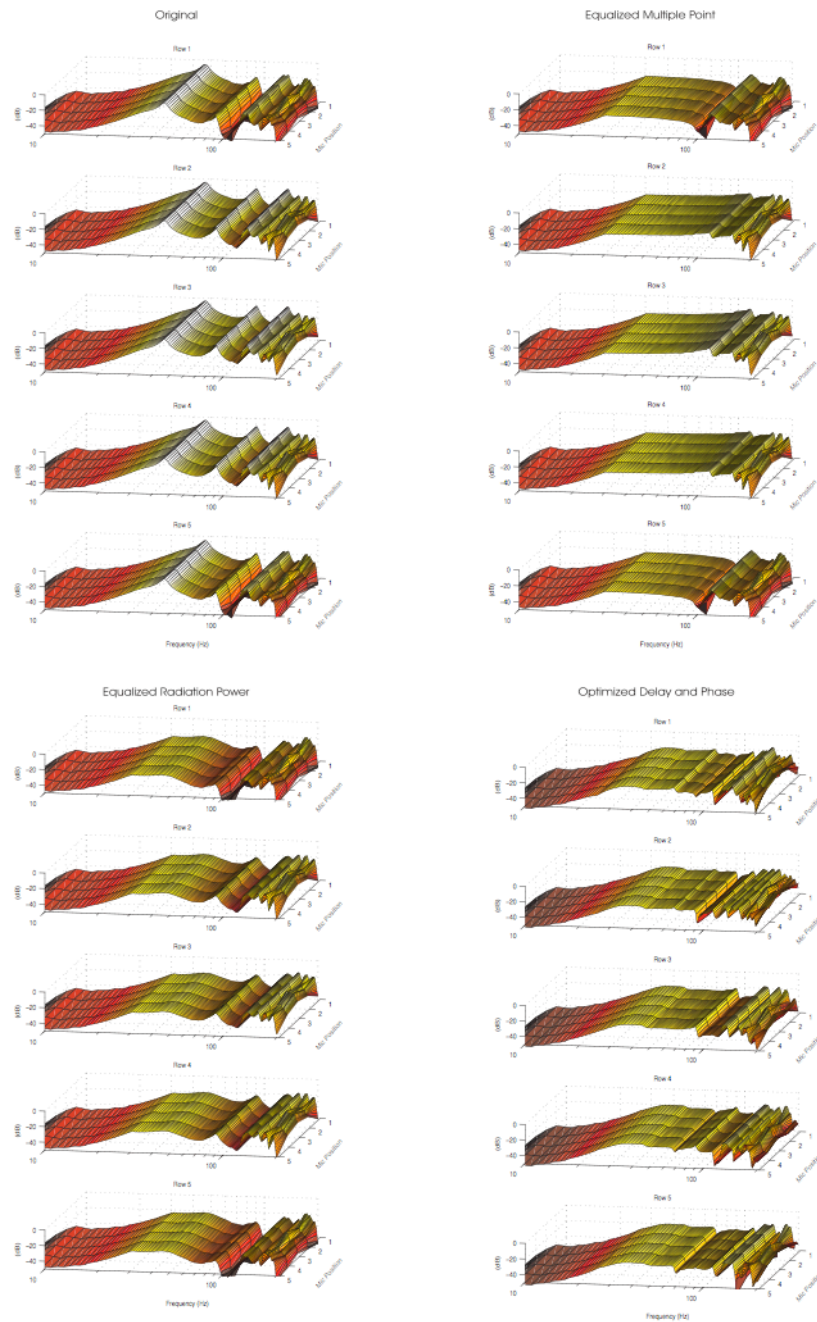

Fig. 15. Upper left are the frequency responses at the 25 virtual microphones positions in the listening area of configuration LP5 (relocated) plotted by rows and microphone position, the first row are the microphone positions closer to front loudspeakers. Upper right are the equalized responses by multiple point equalization. Lower left are the equalized responses by radiated power equalization. Lower right are the optimized responses by modification of delay and phase of rear loudspeakers.

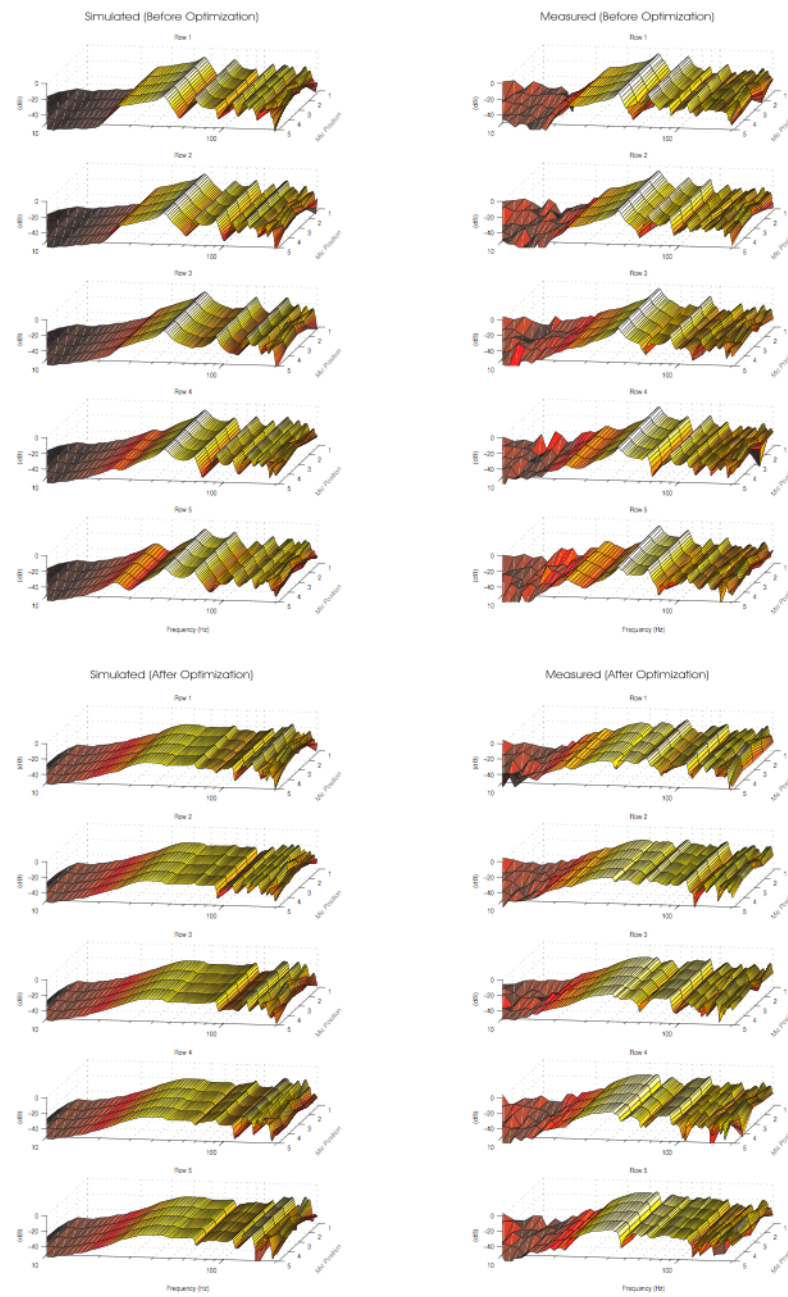

Fig. 16. Frequency responses at the 25 virtual microphones positions in the listening area plotted by rows and microphone position. Left (upper) column are simulations of front loudspeakers on with out optimization. Left column (lower) are simulations with front loudspeakers and rear ones with delay and phase inversion. Right (upper) column measurements of only front loudspeakers, with out optimization. Right (lower) are measurements with front loudspeakers and rear ones with delay and phase inversion.

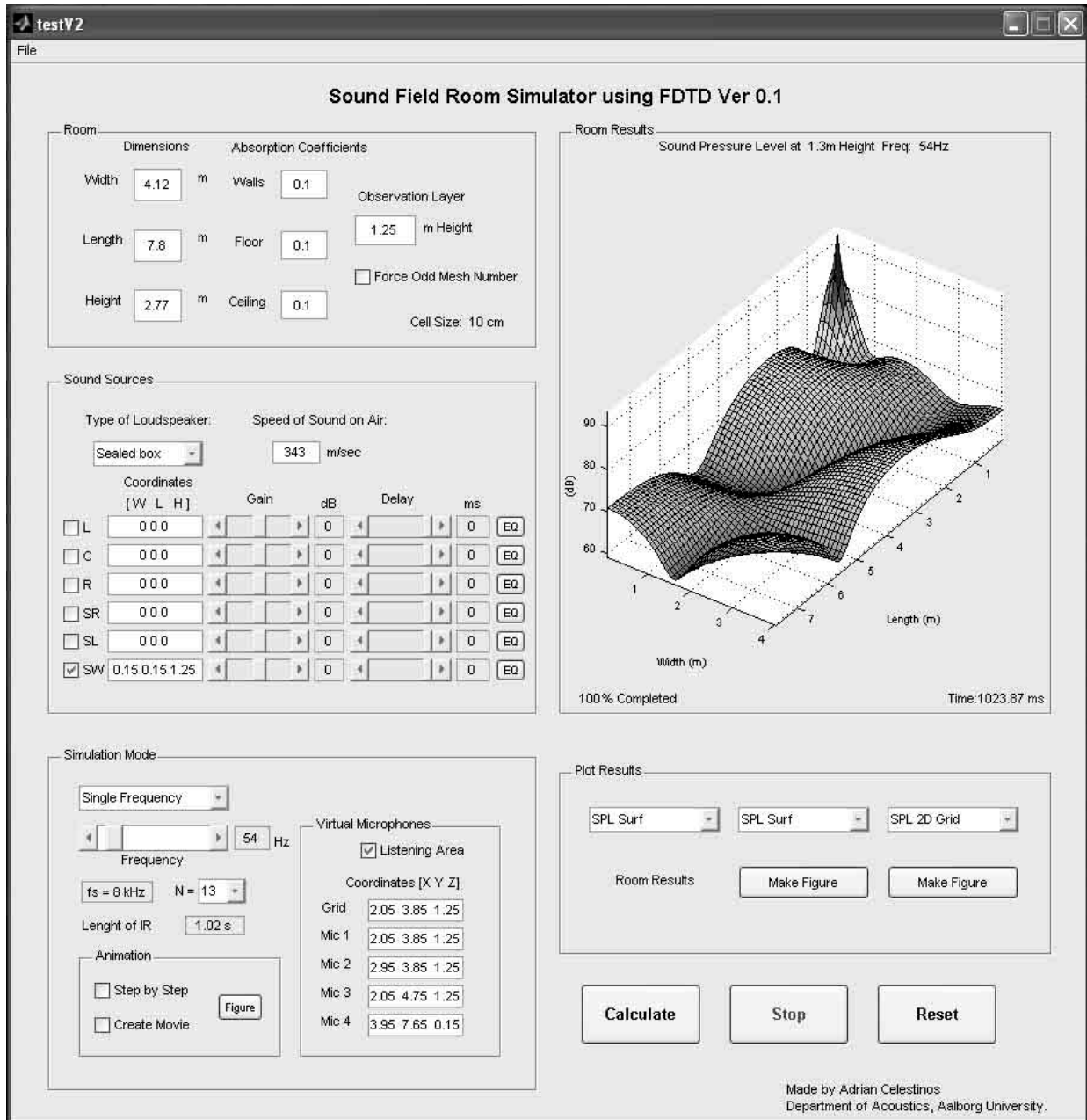

Fig. 17. Graphical user interface of the room simulator used in this paper.

Paper C

Low frequency sound field enhancement system for rectangular rooms using multiple low frequency loudspeakers

Adrian Celestinos^a, and Sofus Birkedal Nielsen^a

^a*Acoustics, Department of Electronic Systems, Aalborg University, DK-9220 Aalborg East, Denmark*

Abstract

Rectangular rooms have strong influence on the low frequency performance of loudspeakers. Simulations of three different room sizes have been carried out using finite-difference time-domain method (FDTD) in order to predict the behavior of the sound field at low frequencies. By using an enhancement system with extra loudspeakers the sound pressure level distribution along the listening area presents a significant improvement in the subwoofer frequency range. The system is simulated and implemented on the three different rooms and finally verified by measurements on the real rooms.

1. INTRODUCTION

In recent years and since the advent of the stereophony the reproduction in high fidelity of music signals has drawn the attention of many researchers, professionals of the audio industry and a large amount of enthusiasts. More recently with the arrival of the digital signal processing technology the popularity of sound reproduction formats like the multichannel surround systems has increased reasonably. From home theaters to concert hall arenas it is possible to experience sound through powerful loudspeakers. When a loudspeaker is placed in a room a number of problems arise. Modification of the response of the loudspeaker at the listening position occurs due to the reflection of sound at the walls of the enclosure and the position of the loudspeaker. Sound reproduction systems are typically placed in small or medium size rectangular rooms and in some cases large halls. Every room has

strong influence on the low frequency sound field and thereby also on the performance of the loudspeaker. The combination loudspeaker-room acts as a coupled system where the room properties typically dominate. This is often problematic to control since the magnitude response of the loudspeaker is modified depending on the listening position and loudspeaker placement.

To deal with this problem several approaches have been investigated by a number of authors, over the last three decades among others in [1] and [2] the solutions are based on finding the optimum placement of the loudspeakers in the room and in [3] the approach is based in the use of multiple subwoofers on different configurations. Other approaches are based on the control of the acoustic radiation power as in [4], and a large amount of research has been done on the approach of modeling the correct electrical filters some times called modal equalization in [5], or as in [6] that by means of adaptive filtering tech-

niques an specific listening position in the room or an extended listening area is equalized (multiple point equalization). An interesting work done in [7] where an equalization system based on the simulation of a plane wave in a small room seems to be a suitable approach to come about to a solution to this complex problem even though this solution needs a large amount of loudspeakers and a large amount of measurements before the system is working.

In this paper the main goal is to improved the low frequency sound field in an extended listening area of three rectangular rooms by using multiple loudspeakers. The idea is to excite only certain room modes by using constructive an destructive phase interference and to create traveling sound in one end of the room and cancel the sound in the opposite wall by using extra loudspeakers delayed and in anti phase. This approach was described before in [9] by the authors.

In this paper the analysis at low frequencies of the three rectangular rooms is performed. Simulations are performed using a program based on finite difference time domain approximations (FDTD) and finally measurements in the real rooms are presented testing the proposed equalization system.

2. ANALYSIS OF THE SOUND FIELD ON THREE RECTANGULAR ROOMS

In this section the description of the three rooms is given and the analysis of the sound field at low frequencies produced by typical sound reproduction systems placed in the three different room sizes is presented.

2.1. Room description

The three different rooms have been simulated using a program based on the finite-difference time-domain method (FDTD) presented by the authors in [8] and [9]. The room A is a standard listening room of approx. 90 m³ that fulfill the IEC 268-13 standard, which describes an average living room. This room has been well studied in [10] and [11]. The ceiling is a false ceiling tilted in the corners and covered with special plaster panels with three different sections of absorptive materials. The floor is

wooden and the walls are quite reflective. The room has a double metal door in one of the side walls. The room B is a multichannel listening room of approx. 172 m³ that conforms to the recommendation ITU-R BS 775-1 for multichannel surround setups. The walls of this room are quite damped except the back wall that has large windows that cover most of the wall. The ceiling is covered with special plaster panels. The floor is wooden and it has two metal doors placed symmetrically on the side walls. The room C is a hall of approx. 1200 m³ used as a concert hall for live performances of pop music. The floor is wooden and the ceiling has three section levels with the last section of the ceiling resting on four columns. All three rooms have a general characteristic of being rectangular and are used with sound reproduction systems. In Table 1 the room dimensions and the estimation of room parameters such as reverberation time T60 are shown. The reverberation time is calculated from the measurements described in Section 2.3 and using the loudspeaker setup 0.2.0. see Section 2.2. The T60 is estimated as described in [13] from the 10 dB energy drop using the Schroeder backward integration method [14]. Also in Table 1 the Schroeder frequency (f_g) is calculated according to

$$f_g = 2000 \sqrt{\frac{T60}{V}} \quad (1)$$

where T60 is the reverberation time in seconds and V is the volume of the room, this frequency can be taken as the upper limit where the discrete standing waves predominate and the simplifications of the statistical theory of sound field in enclosures can not be applied [12], [13].

Following on the analysis of the rooms the first 25 room modes of the three enclosures are shown in Table 2 according to

$$f_n = \frac{c}{2} \sqrt{\left(\frac{n_x}{L_x}\right)^2 + \left(\frac{n_y}{L_y}\right)^2 + \left(\frac{n_z}{L_z}\right)^2} \quad (2)$$

where c is the speed of sound in the air, n_x , n_y and n_z are integers starting with 0, 1, 2, ... and L_y , L_x , L_z are the dimensions of the room [13].

The number of modal frequencies per 1 Hz and the number of room modes both below the frequency f are computed according to equations

Table 1

Room dimensions, reverberation time (T60) in seconds, Schroeder frequency (f_g), number of room modes (N) below Schroeder frequency and below 100 Hz, number of modal frequencies per 1 Hz (ΔN_f) below the Schroeder frequency and below 100 Hz.

Room	L×W×H (m)	V (m ³)	T60 (s)	f_g (Hz)	N		ΔN_f (Hz)	
					$\rightarrow f_g$	$\rightarrow 100$ Hz	$\rightarrow f_g$	$\rightarrow 100$ Hz
A	7.80×4.12×2.78	89.34	0.47	145	49.72	0.81	20.13	0.45
B	8.12×7.39×2.88	172.82	0.31	85	23.20	0.65	34.60	0.84
C	25.00×12.25×3.90	1194.40	0.89	55	42.16	1.83	190.26	4.95

$$\Delta N_f = 4\pi V \frac{f^2}{c^3} + \frac{\pi}{2} S \frac{f}{c^2} + \frac{L}{8c} \quad (3)$$

and

$$N = \frac{4\pi}{3} V \left(\frac{f}{c}\right)^3 + \frac{\pi}{4} S \left(\frac{f}{c}\right)^2 + \frac{L}{8c} f \quad (4)$$

where S is the area of all walls $2(L_x L_y + L_x L_z + L_y L_z)$, V is the volume of the enclosure and $L = 4(L_x + L_y + L_z)$ the sum of all edge lengths of the room [13].

2.2. Sound Field Room Simulations

A typical setup of loudspeakers is simulated in each of the rooms. Some of the details of each room like the different ceilings, windows, columns and metal doors are included in the simulation model. For simplicity in the next sections the following notation is introduced

Nr. of front . Nr. of front wall . Nr. of back wall
 full range subwoofers subwoofers

to indicate for example a stereo setup of two full range loudspeakers the notation 2.0.0 is used. For a stereo setup of two full range loudspeakers plus a subwoofer the notation 2.1.0 is used. For example the notation 0.2.2 indicates a configuration with two subwoofers in the front wall of the room and two subwoofers on the back wall feed with a different signal.

The configuration 2.0.0 has been simulated in the room A, the two loudspeakers are located at $y=1.74$ m from the front wall at a height of $z=1.26$ m, they were simulated as two full range type loudspeakers with a cut off frequency of 40 Hz. The sound field is sampled in a listening area of 1.92×1.92 m centered in the room delimited by

25 virtual microphones equally spaced by 48 cm at a height of $z=1.26$ m. The configuration 2.1.0 was tested in room B using the same full range loudspeakers as in room A and a subwoofer which has a cut off frequency of 28 Hz. The subwoofer is located

Table 2

The first 25 room modes of rooms A, B and C.

Room A		Room B		Room C	
$n_y n_x n_z$	f_n Hz	$n_y n_x n_z$	f_n Hz	$n_y n_x n_z$	f_n Hz
1 0 0	22	1 0 0	21	1 0 0	7
0 1 0	41	0 1 0	23	2 0 0	14
2 0 0	44	1 1 0	31	0 1 0	14
1 1 0	47	2 0 0	42	1 1 0	16
2 1 0	61	0 2 0	46	2 1 0	20
0 0 1	63	2 1 0	48	3 0 0	21
3 0 0	66	1 2 0	51	3 1 0	25
1 0 1	66	0 0 1	60	4 0 0	28
0 1 1	75	2 2 0	63	0 2 0	28
2 0 1	77	1 0 1	63	1 2 0	29
3 1 0	78	3 0 0	64	4 1 0	31
1 1 1	78	0 1 1	64	2 2 0	31
0 2 0	82	1 1 1	67	5 0 0	34
1 2 0	85	3 1 0	68	3 2 0	35
2 1 1	87	0 3 0	70	5 1 0	37
4 0 0	88	1 3 0	73	4 2 0	39
3 0 1	91	2 0 1	73	6 0 0	41
2 2 0	93	0 2 1	76	0 3 0	42
4 1 0	97	2 1 1	77	1 3 0	42
3 1 1	100	1 2 1	78	0 0 1	44
0 2 1	103	3 2 0	79	6 1 0	44
3 2 0	105	2 3 0	82	5 2 0	44
1 2 1	105	4 0 0	85	2 3 0	44
4 0 1	108	3 0 1	87	1 0 1	45
5 0 0	110	2 2 1	87	2 0 1	46

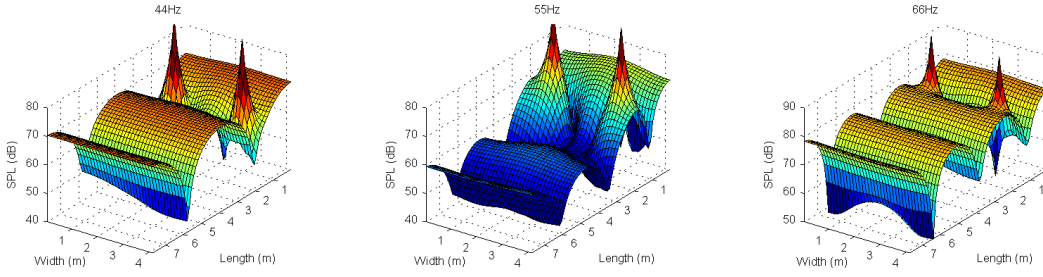

Fig. 1. Simulation of sound pressure distribution of room A using setup 2.0.0. Left, SPL distribution produced by 44 Hz (modal frequency). Middle, SPL distribution produced by 55 Hz (anti modal frequency). Right, SPL distribution produced by 66 Hz (modal frequency).

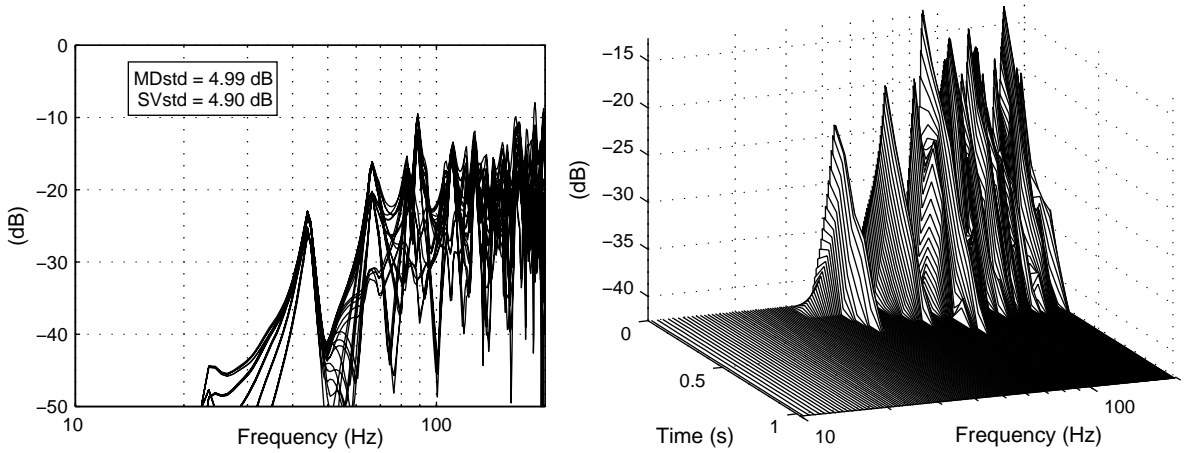

Fig. 2. Simulation of room A. Left, frequency response at the 25 virtual microphone positions produced by the setup 2.0.0. Right, cumulative spectral decay (CSD) at one of the virtual microphone position.

on the floor at $y=0$ and $x=Lx/2$. The full range loudspeakers were placed at $y=1.89$ m from the front wall at a height of $z=1.17$ m. The sound field is sampled in a listening area of 2.88×2.88 m centered in the room delimited by 25 virtual microphones equally spaced by 72cm at a height of $z=1.17$ m. In this case the crossover frequency was set to 85 Hz using second order IIR Butterworth filters. As for the room C which is a concert hall the setup 0.2.0 was simulated using two subwoofers as this is the normal setup to reproduce the low frequency content on live concerts at this venue. The sound field is sampled in a listening area of 4.8×4.8 m in the room from $y=8.85$ m to $y=13.65$ m in the y direction and from $x=3.75$ m to $x=8.55$ m in the x direction delimited by 25 virtual microphones equally spaced by 1.20 m. The location of the listening area is where most of the audience stay during the concerts.

In Figs. 2, 4 and 6 the frequency and time analysis of the three rooms is presented. The frequency response of the 25 virtual microphone positions along the listening area in rooms A, B and C is shown respectively. The indicator *Magnitude Deviation* (MD_{std}) is an average of the 25 standard deviations in the frequency range from 30 Hz to 150 Hz from the ideal desired signal that in this paper is the anechoic response of the loudspeaker, a value of $MD_{std} = 0$ dB represents an ideal anechoic response. The indicator *Spatial Deviation* (SV_{std}) is the standard deviation per single frequency from the mean value across all positions, a value of $SV_{std} = 0$ dB indicates that all magnitude responses are identical along the whole listening area. The SV_{std} is the mean of the deviations SV_{std} in the range from 30 Hz to 150 Hz. Additionally on the waterfall plots from one of the impulse responses in the listening area the cumulative spectral decay (CSD) is

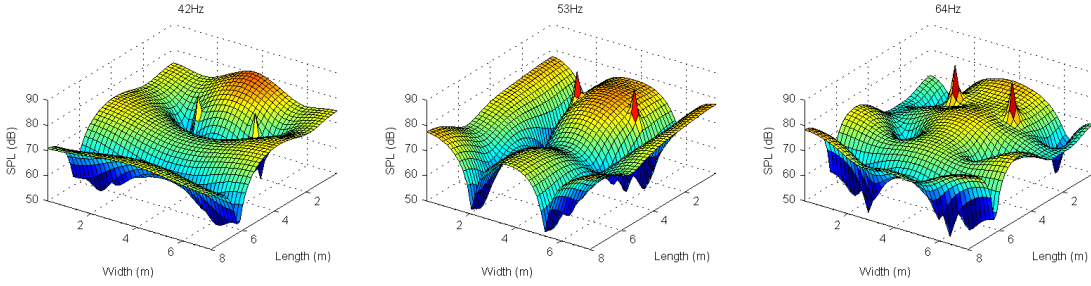

Fig. 3. Simulation of sound pressure distribution of room B using setup 2.1.0. Left, SPL distribution produced by 42 Hz (modal frequency). Middle, SPL distribution produced by 53 Hz (anti modal frequency). Right, SPL distribution produced by 64 Hz (modal frequency).

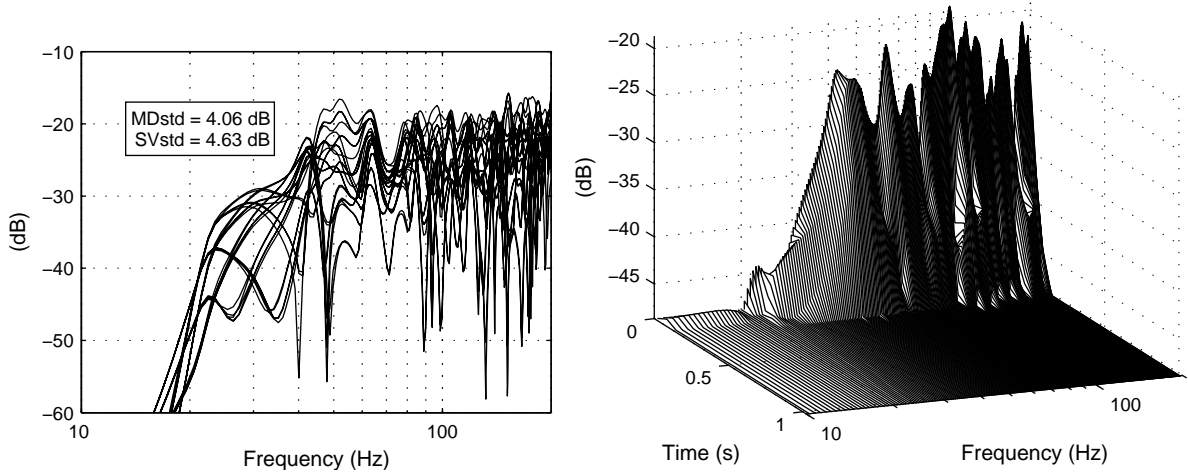

Fig. 4. Simulation of room B. Left, frequency response of the 25 virtual microphone positions produced by the setup 2.1.0. Right, cumulative spectral decay (CSD) at one of the virtual microphone position.

calculated. This is done by applying a sliding rectangular window of 1s and calculating the discrete Fourier transform (DFT) on the impulse response to be analyzed [5], [15].

The analysis of the sound pressure distribution can be done by observing figures 1, 3 and 5 where the sound pressure level (SPL) distribution along the room is plotted as surface plots. The frequencies chosen corresponds to two modal frequencies and one anti modal frequency.

2.3. Measurements

In order to verify the simulations measurements have been carried out on the three real rooms including only the 25 microphone positions equally distributed in the listening area. The measurements were done by using maximum length sequences

(MLS) of order $N=14$ with sampling frequency $f_s=8k$ Hz and analyzed by the discrete Fourier transform (DFT). The measurements of rooms A, B and C are presented in Fig. 7, where also the cumulative spectral decay (CSD) on one of the impulse responses in each room is calculated.

As it can be seen from the simulations and measurements the sound field at low frequencies presents high variations in magnitude, in some cases more than ± 20 dB. The response of the loudspeaker varies from one position to another due to the standing waves and parallel walls. These variations are dependent of the size of the room and both the loudspeaker and the listener position. It is also noticeable that the room modes have stronger influence in the smallest room. That can be explained because the separation between modes become smaller as the room size increases. However when looking at the temporal responses one can observe in Figs. 4

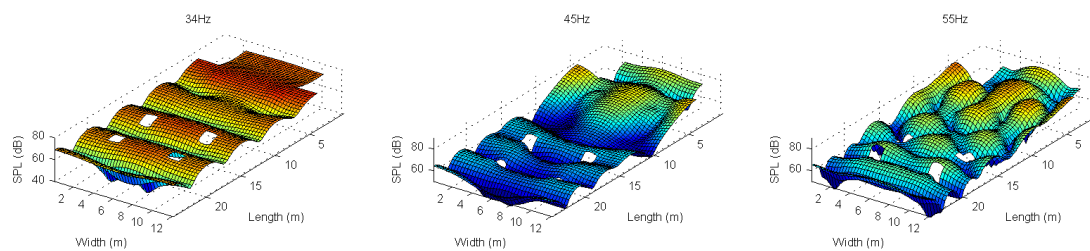

Fig. 5. Simulation of the sound pressure level distribution of room C using setup 0.2.0. Left, produced by 34 Hz (modal frequency). Middle, produced by 45 Hz (anti modal frequency). Right, produced by 55 Hz (modal frequency).

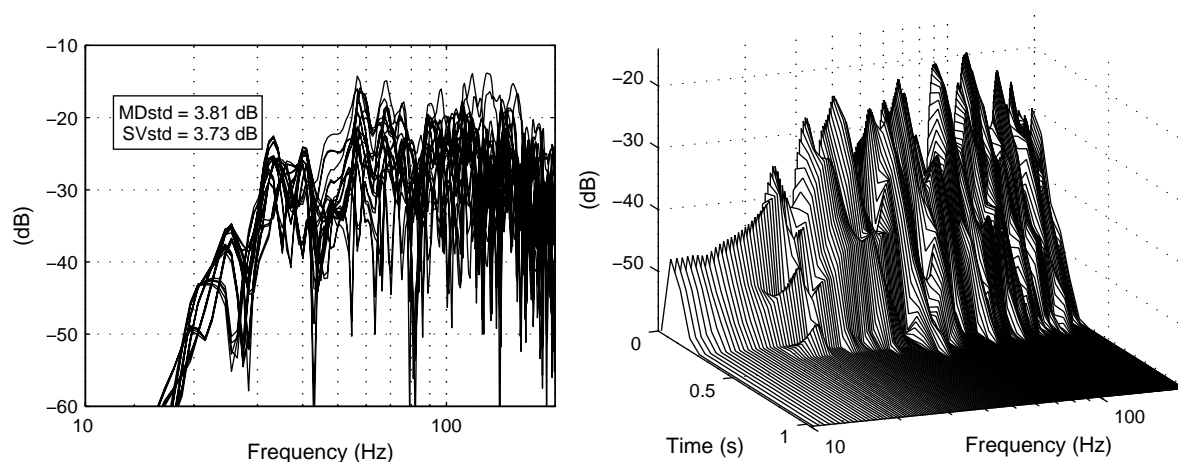

Fig. 6. Simulation of room C. Left, frequency response of the 25 virtual microphone positions produced by the setup 0.2.0. Right, cumulative spectral decay (CSD) at one of the virtual microphone position.

and 6 that in room B and C the resonances are not as noticeable as in room A. Nevertheless the modal resonances are still there and that can be confirmed in Fig. 3 and Fig. 5. From the three rooms the one that has more problems is room A since it presents the highest magnitude and spatial variations. In this case some of the low frequencies will sound boomy and others would be highly attenuated. In the three cases the spatial variations and magnitude deviations become less problematic as the frequency increases.

3. THE EQUALIZATION SYSTEM

During the last years several attempts have been carried out in order to tackle the problem of loudspeakers in rooms at low frequencies. As learned in section 2 the response of a loudspeaker in an enclosure would give peaks and notches of more than 20 dB in magnitude difference, in these cases elec-

tronic equalization would not be the best solution since the range of most equalizers would not be sufficient to compensate for example a notch of -20 dB at 50 Hz. Even if it was possible to compensate a notch of -20 dB the loudspeaker would not handle the high boost and it will introduce large amount of distortion. In some cases electronic equalization may work at one single position but it will make it worse at some other positions. In [1] the optimum loudspeaker placement relative to the listener position in the room has been investigated as well as in [3] by using more than two subwoofers. Other solutions are the so called multiple point equalization in [6] where the sound field has to be sampled by a distribution of microphones in order to find the best suitable filters before the loudspeaker in the reproduction chain. Other approach in [4] attempts to control the acoustic radiation power of the loudspeakers and adjusting it to its environment, in this approach the volume velocity of the loudspeaker has to be known in order to calculate the acoustic radi-

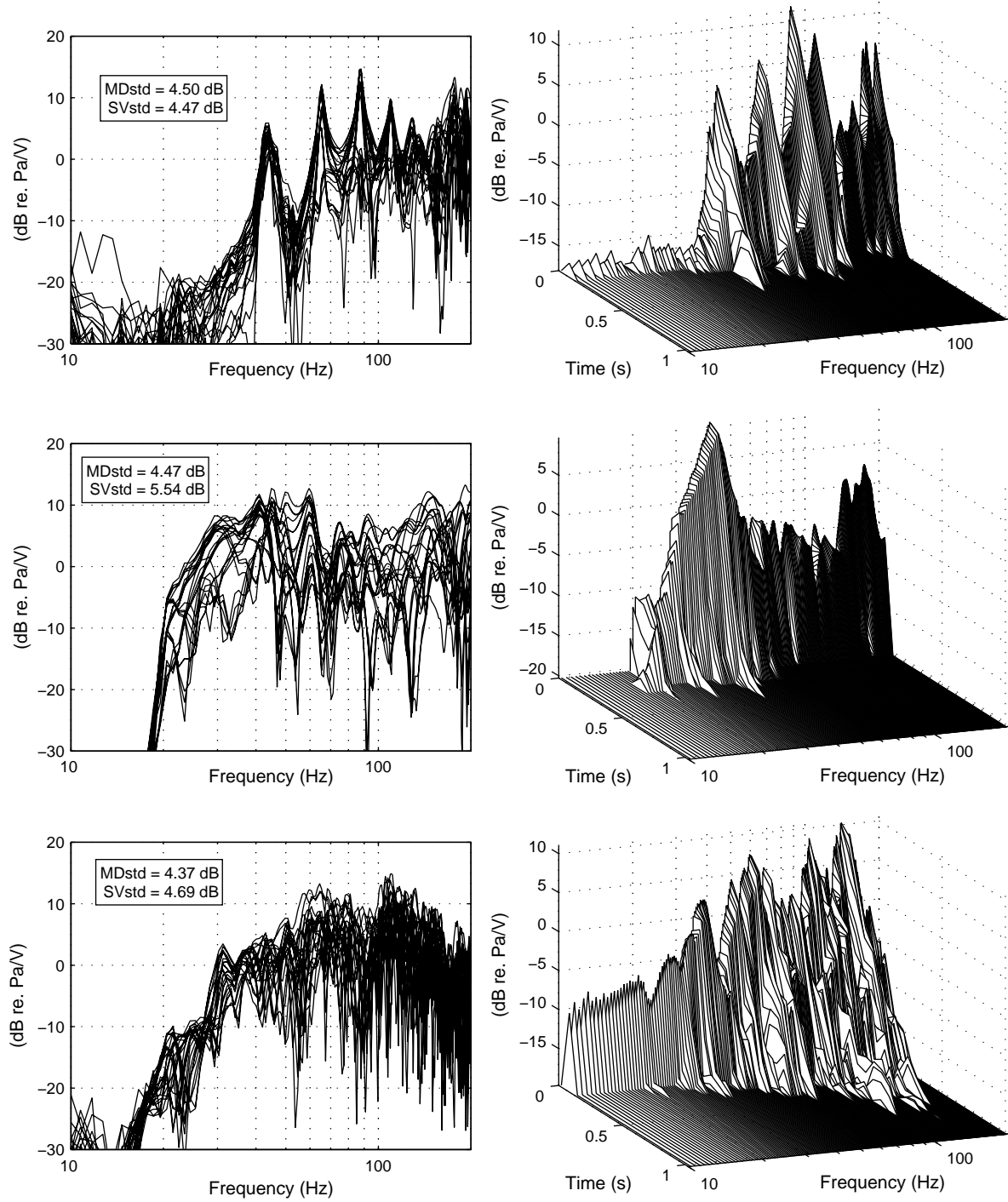

Fig. 7. Upper, measurements on room A, setup 2.0.0. Middle, measurements on room B, setup 2.1.0. Lower, measurements on room C, setup 0.2.0. Left column, frequency response of the 25 virtual microphone positions. Right column, cumulative spectral decay (CSD) at one of the virtual microphone position.

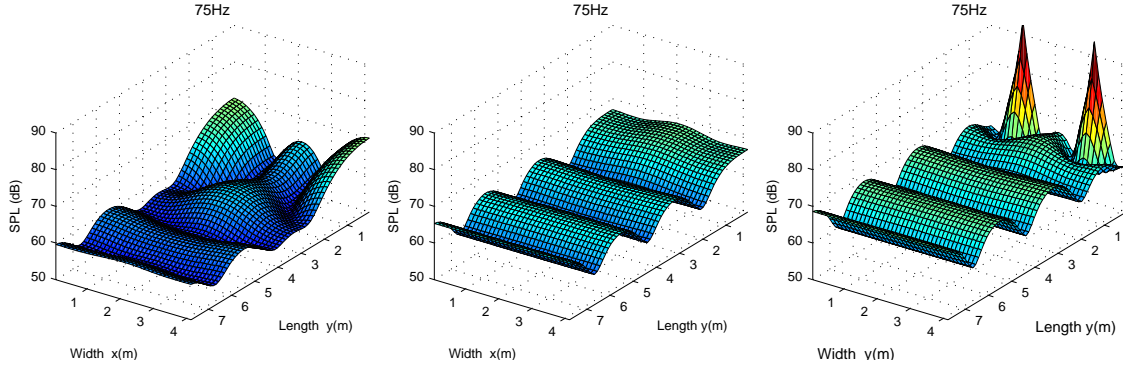

Fig. 8. Simulation of sound pressure distribution in a rectangular room measured at a height of $z=1.38$ m, driven frequency 75 Hz, room mode (0 1 1). Left plot, setup 0.1.0 the loudspeaker is located at $z=0.06$ m and $x=L_x/2$ and $y=0$. Middle plot, setup 0.2.0 loudspeakers at $z=0.06$ m. Right plot, loudspeakers at $z=1.38$ m.

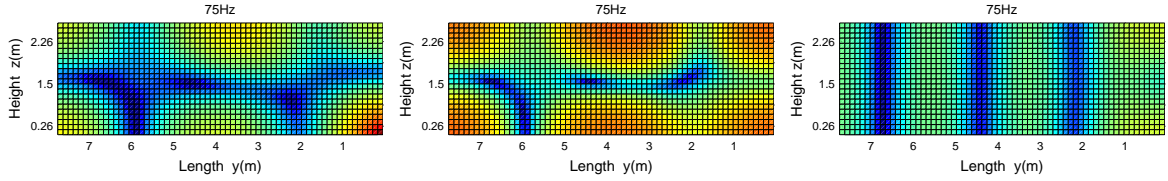

Fig. 9. Simulation of sound pressure distribution in the same room as Fig. 8 measured at the vertical plane $x=2.10$ m, driven frequency 75 Hz, room mode (0 1 1). Left plot, setup 0.1.0 the loudspeaker is located at $z=0.06$ m. Middle plot, setup 0.2.0 loudspeakers at $z=0.06$ m. Right plot, loudspeakers at $z=1.38$ m.

ation power.

3.1. Creation of a Plane Wave

To achieve optimum sound pressure level distribution within an extended listening area inside a rectangular enclosure of volume $V = L_x L_y L_z$ and assuming a number of sound sources on the wall at $y=0$ and a number of sound sources at the wall $y = L_y$, a traveling plane wave in the y direction has to be simulated and only the axial modes corresponding to this direction should be excited.

By placing the loudspeakers equidistantly in the x and z directions mostly the axial modes in the y direction will be excited and the amplitude of the other modes will be reduced significantly [7]. It has been found that actually with a total of two sound sources placed at $y=0$, $x = L_x/4$ and $x = 3L_x/4$ respectively and at a height $z = L_z/2$ a plane wave can be created reducing the amplitude of the room modes corresponding to (0 2 0) and (0 0 1) and their combinations see Table 2 in Section 2.

A room of dimensions $L_x=4.20$ m, $L_y=7.8$ m and

$L_z=2.76$ m similar to room A has been considered as an example but assuming an absorption coefficient of $\alpha=0.12$ in all walls instead. On the left plot of Fig. 8 the sound pressure level distribution at $z=1.38$ m is been simulated, one loudspeaker driven by 75 Hz is located at $y=0.06$ m, $x=L_x/2$ and $z=0.06$. It can be observed that the reflection of the side walls and the ceiling produce destructive interference and it has not been able to create a plane wave traveling in the y direction (notice that 75 Hz corresponds to the room mode (0 1 1)). In the middle plot of Fig. 8 two loudspeakers have been replaced instead at $y=0.06$ m, $x=L_x/4$ and $x=3L_x/4$ respectively and at $z=0.06$ m driven by the same frequency (75 Hz). One can observe that the interference caused by the side walls and both loudspeakers is been used to attenuate the room mode corresponding to the x direction and a traveling wave along the y direction exists, still the attenuation caused by the standing wave corresponding to the z direction is present see middle plot in Fig. 9. That is alleviated by relocating the loudspeakers at $z=L_z/2$ which can be seen in the right plots in Figs. 8 and 9. This configuration should ideally create a traveling plane waves in the y direction at all frequencies below the modal frequency 103 Hz (0 2 1). In [7] it has been found

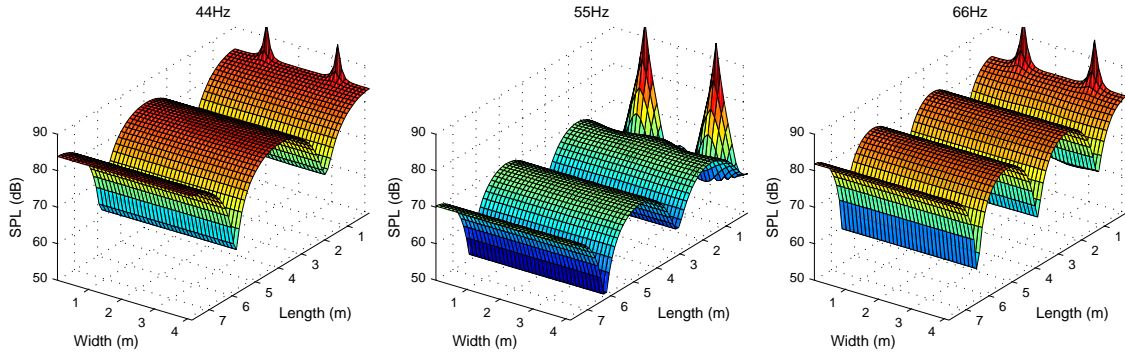

Fig. 10. Simulation of sound pressure distribution measured at a height of $z = 1.38\text{m}$ produced by setup 0.2.0 before equalization, Left plot, driven frequency 44 Hz. Middle plot, driven frequency 55 Hz. Right plot driven frequency is 66 Hz.

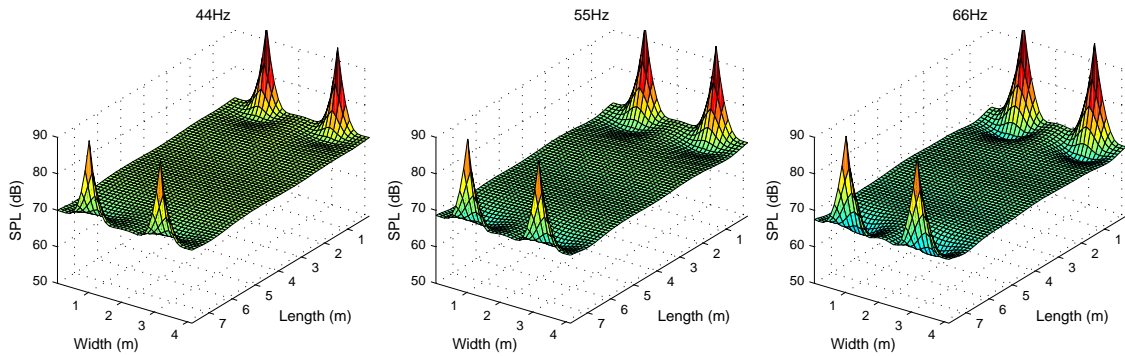

Fig. 11. Simulation of sound pressure distribution measured at a height of $z = 1.38\text{m}$ after equalization produced by setup 0.2.2, Left plot, driven frequency 44 Hz. Middle plot, driven frequency 55 Hz. Right plot driven frequency is 66 Hz.

that an approximation of the maximum frequency that can be equalized is given by $f_{max} = c/d - \Delta_\epsilon$ where c is the speed of sound and d is the distance in the x direction between two adjacent loudspeakers, and Δ_ϵ is a constant that depends on the damping of the room.

3.2. Removing the Reflection from the Back Wall

As room modes or modal resonances are caused by reflections and standing waves the obvious way to reducing or removing these modes is to remove the reflection which has to be made in the time domain and it will ideally work for all frequencies. In order to create a traveling plane wave in the y direction the reflection of sound on the back wall has to be minimized. This is achieved by placing the same number of extra loudspeakers in antiphase with the sound pressure at the back wall.

These loudspeakers are fed with the same signal as

N including a delay according to the traveling distance in the y direction of the plane wave. In addition the gain G of the extra loudspeakers has to be adjusted due to the attenuation of sound by the traveling distance and the damping characteristics of the room. In Fig. 12 the block diagram of the equalization system is shown.

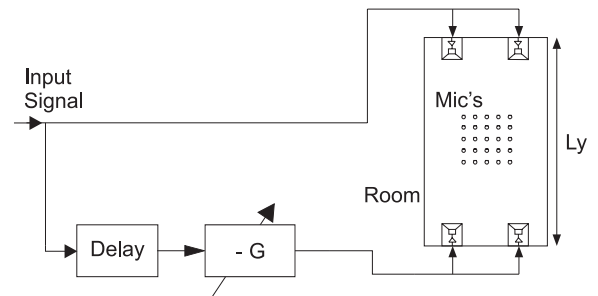

Fig. 12. Block diagram of the equalization system to minimize the reflection of the back wall, G its a factor according to the damping characteristics of the room and the attenuation of sound by the air.

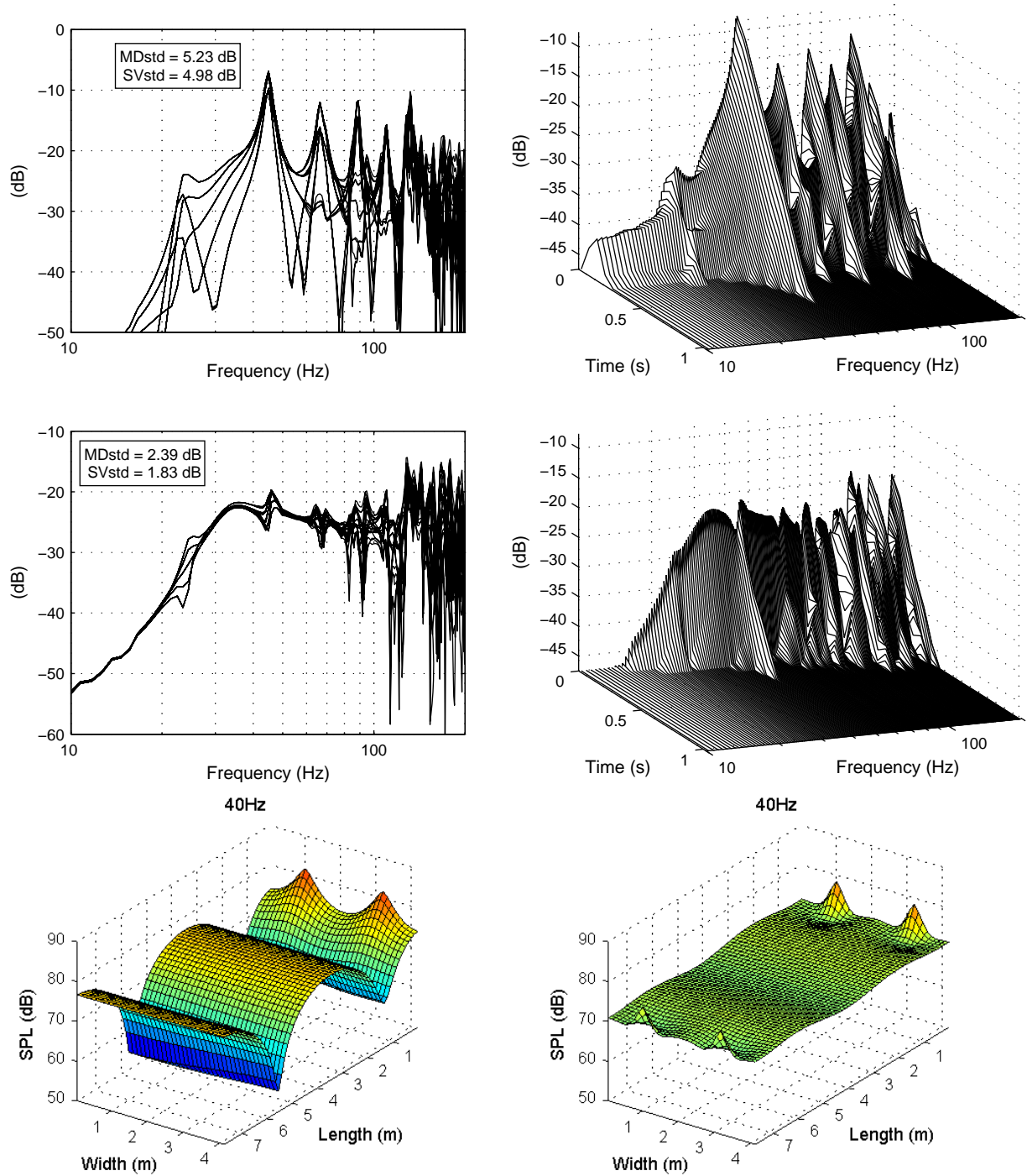

Fig. 13. Simulation of the equalization system in room A setups 0.2.0 and 0.2.2. Left (upper, middle), frequency responses at the 25 positions, (upper) before equalization (middle) after equalization. Right (upper, middle), cumulative spectral decay (CSD) at one position, (upper) before equalization, (middle) after equalization. Lower, SPL distribution at $z=1.26$ m, driven frequency 40 Hz, (left) before equalization, (right) after equalization.

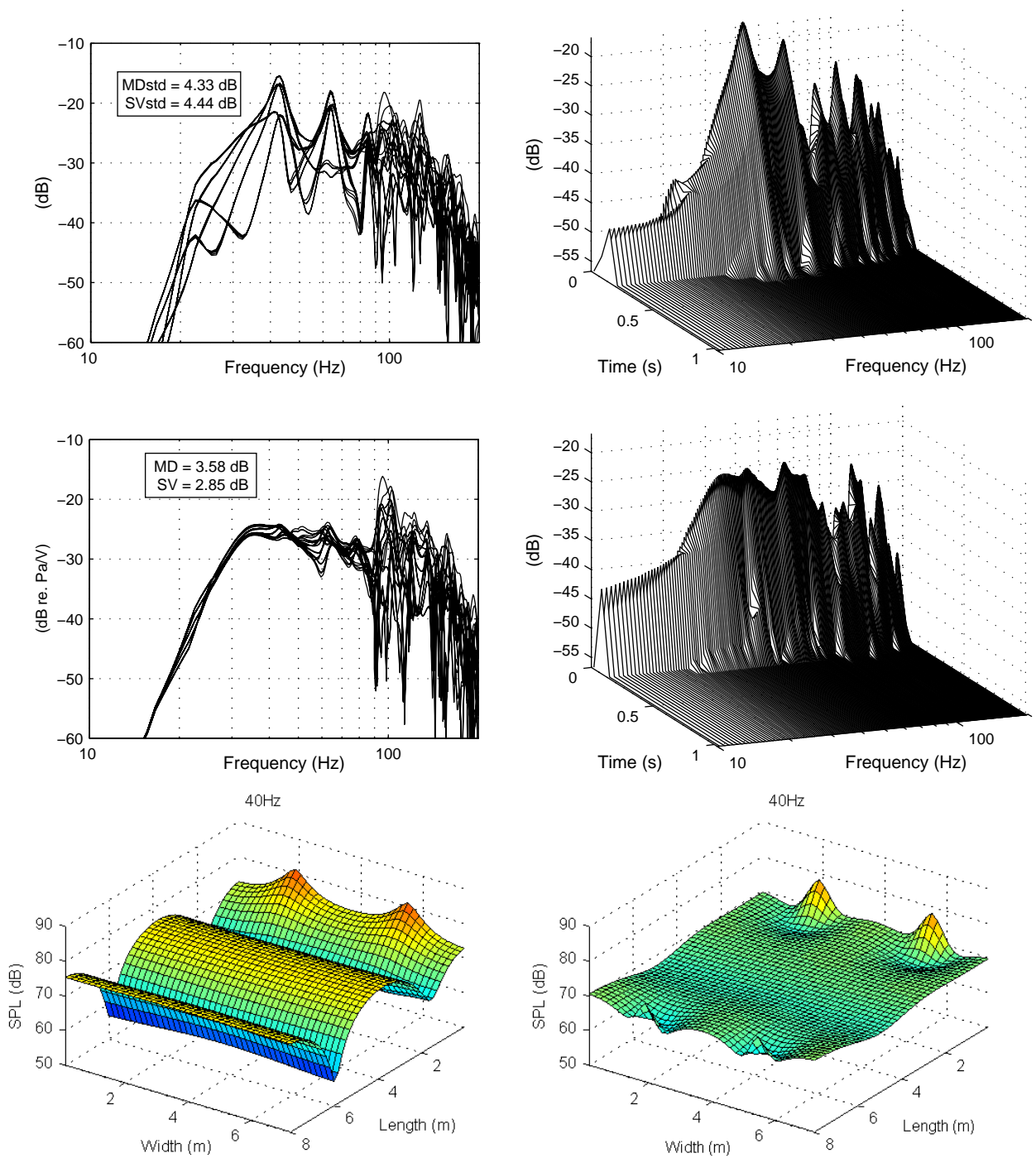

Fig. 14. Simulation of the equalization system in room B setups 0.2.0 and 0.2.2. Left (upper, middle), frequency responses at the 25 positions, (upper) before equalization (middle) after equalization. Right (upper, middle), cumulative spectral decay (CSD) at one position, (upper) before equalization, (middle) after equalization. Lower, SPL distribution at $z=1.20$ m, driven frequency 40 Hz, (left) before equalization, (right) after equalization.

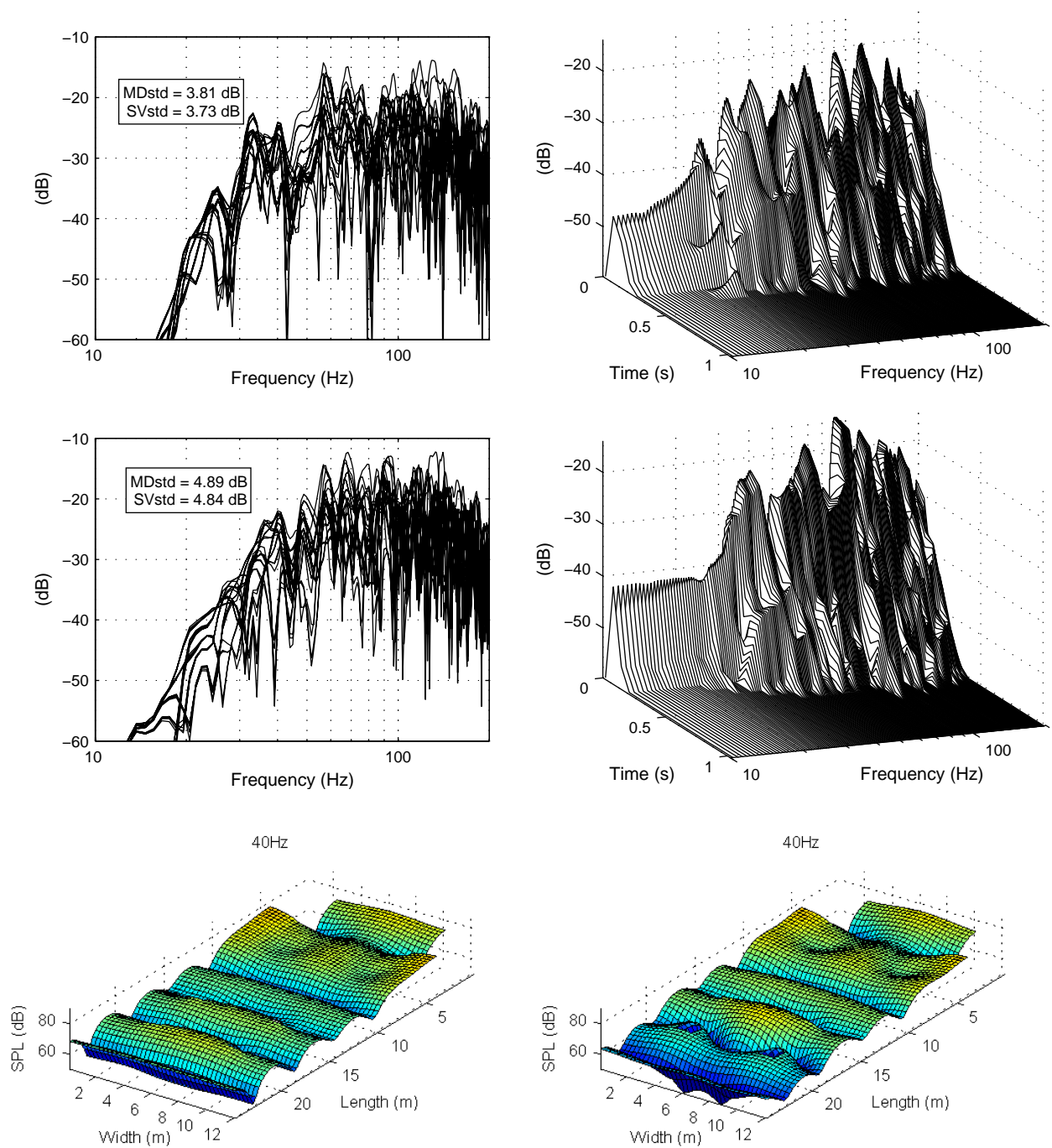

Fig. 15. Simulation of the equalization system in room C setups 0.2.0 and 0.2.2. Left (upper, middle), frequency responses at the 25 positions, (upper) before equalization (middle) after equalization. Right (upper, middle), cumulative spectral decay (CSD) at one position, (upper) before equalization, (middle) after equalization. Lower, SPL distribution at $z=1.65$ m, driven frequency 40 Hz, (left) before equalization, (right) after equalization.

3.3. Optimal Equalization

The same room used in section 3.1 is used here to demonstrate the optimal equalization system on individual frequencies. The setup 0.2.0 is placed at $x = L_x/4$, $x = 3L_x/4$, $y=0.06$ m and at $z = L_z/2$. In Fig. 10 the sound pressure distribution at a height $z = L_z/2$ is measured using 44 Hz, 55 Hz and 66 Hz as driven frequencies before equalization. In Fig. 11 the result of the equalization system is plotted with the extra loudspeakers. As it can be observed the back wall reflection has been minimized and a traveling wave in the y direction has been created. Notice that the sound level distribution is even in almost all the room.

4. RESULTS

In this section first the equalization system is simulated on rooms A, B and C and secondly the measurements of the equalization system in the real rooms are presented.

4.1. Simulation of the Equalization System

In room A the listening height has been chosen $z=1.26$ m and the height of the loudspeaker setup 0.2.2 was chosen to be $z=1.50$ m the same as in the measurements in the real room. The details of the ceiling, door and floor are included in the simulation program. In room B the listening height is $z=1.17$ m and the loudspeakers 0.2.2 are located at a height of $z=1.53$ m. In room C the listening height is $z=1.65$ m and the loudspeakers are placed on the floor at $z=0.15$ m. This room presents an special difficulty since in the real room the loudspeakers can not be placed at the very end walls. The 0.2.0 loudspeakers are located as the typical subwoofer placement in live concerts at $y=5.80$ m from the front wall, and the loudspeakers 0.0.2 where placed at $y=19.20$ m, 5.80 meters from the back wall respectively. The delay was adjusted according to the distance from the front loudspeakers to the rear loudspeakers.

In Figs. 13, 14 and 15 simulation of setup 0.2.2 is presented before and after equalization on rooms A, B and C respectively.

4.2. Measurement of the Equalization System

First the equalization system is simulated and next measured in the real rooms A, B and C. The measurements are presented on Fig. 16, 17 and 18, where before equalization plots (upper) and after equalization plots (lower) are shown, left plots are frequency response curves and right plots are CSD waterfall plots. The impulse responses were acquired by using MLS sequences of order $N=14$ with a sampling frequency $f_s=8$ k Hz and processed by the discrete Fourier transform (DFT) in Matlab. The loudspeakers employed were four 35 cm \times 29 cm \times 35 cm close box type active loudspeakers with a 8 in driver unit each.

In room A the sound field was measured at 1.26 m height with 25 microphone positions equally spaced by 48 cm within an area of 1.92×1.92 m centered in the room. The loudspeakers on setup 0.2.2 were placed at 1.50 m height and 6cm from the front and back wall respectively. As illustrated in Section 3.1 the loudspeakers should be placed at 1.38 m height but because of the complexity of the ceiling this height (1.50 m) was assumed to be a better approximation of $L_z/2$ since the concrete ceiling is at $L_z=3.10$ m in the room. The gain of the back wall loudspeakers was $G=-0.95$ dB and the delay $\Delta t=22.44$ ms

In room B the sound field was measured at 1.20 m height on 25 microphone positions equally spaced by 72cm within an area of $2.88 \text{ m} \times 2.88 \text{ m}$ centered in the room. The loudspeakers on setup 0.2.2 were placed at 1.44 m height and 9cm from the front and back wall respectively. The gain of the back wall loudspeakers was $G=-3.7$ dB and the delay $\Delta t=24.6$ ms

In room C the sound field was measured at 1.65 m height on 25 microphone positions equally spaced by 1.20 m within an area of 4.8×4.8 m from $y=8.85$ m to $y=13.65$ m in the y direction and from $x=3.75$ m to $x=8.55$ m in the x direction. The loudspeakers on setup 0.2.2 were placed on the floor and the 0.2.0 loudspeakers were placed at $y=5.80$ m from the front wall and the 0.0.2 loudspeakers were placed at $y=19.20$ m, 5.80 m from the back wall respectively. The gain of the back wall loudspeakers was $G=-8.5$ dB and the delay $\Delta t=47.40$ ms. The result of the measurements is shown in Figs. 16, 17 and 18.

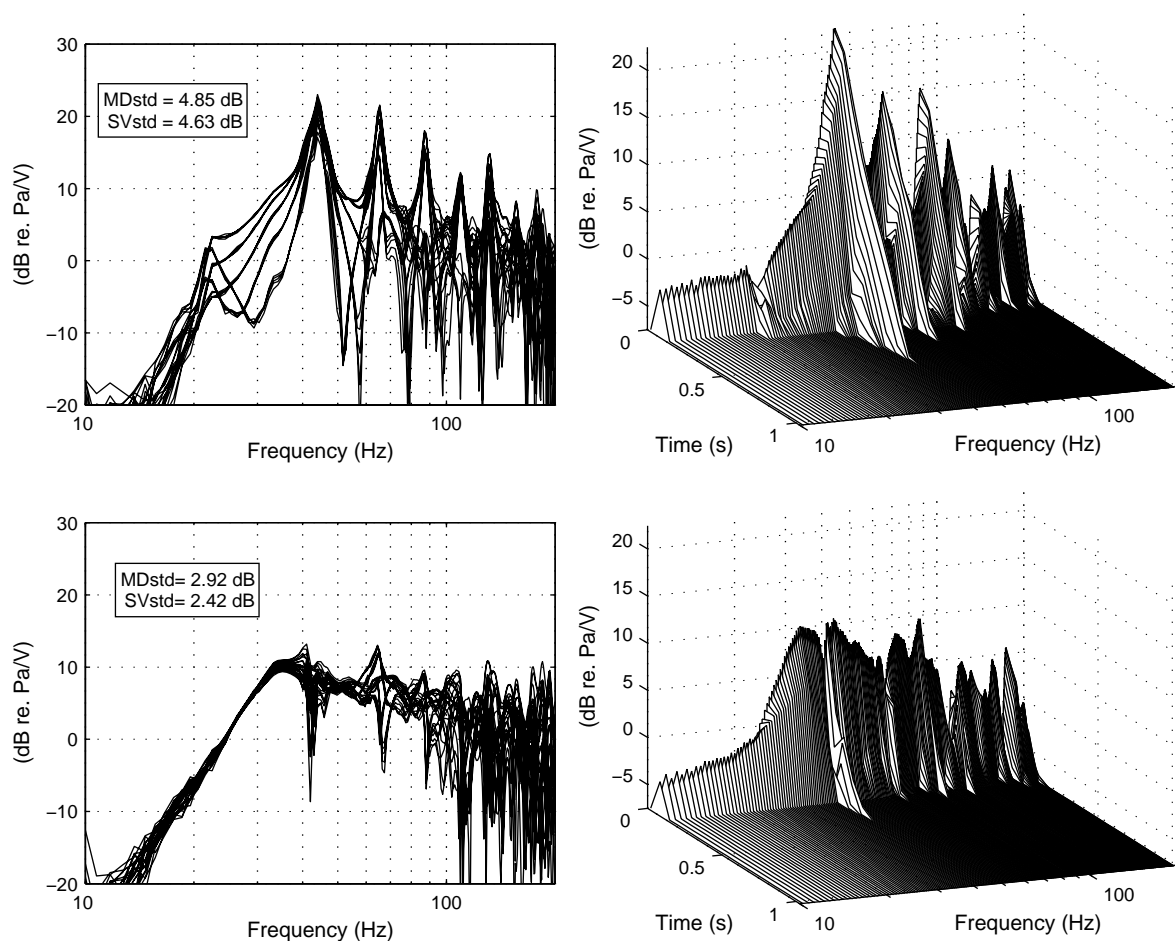

Fig. 16. Measurements of the equalization system in room A, setups 0.2.0 and 0.2.2. Left, frequency responses at the 25 positions, (upper) before equalization (lower) after equalization. Right, cumulative spectral decay (CSD) at one position, (upper) before equalization, (lower) after equalization.

4.3. Evaluation of the Equalization System

As it is clearly seen from the simulations and measurements the equalization system performed very well in room A and B. The magnitude deviation improved drastically from 20 Hz to 100 Hz being differences in magnitude from ± 15 dB to ± 6 dB see Figs. 13 and 16, these deviations are fixed at the modal frequencies specially in room A. However by observing Figs. 13 and 16 the system performed better than the simulations at higher frequencies, one can notice that at the simulations from 100 Hz to 200 Hz the system did not correct for those peaks but in the real room those peaks were attenuated see Fig. 16. One should notice that at that range of frequencies the equalized system added more interference resulting in more overlapped notches. In room

B the system performed better than room A, this can be seen in Fig. 17, notice that the modal frequencies are less noticeable. Concerning the spatial variations the system improved from having variations from one position to the nearest from around 6 dB to 3 dB in the worse cases. By observing the simulations on lower plots in Figs. 13 and 14 the system removed the standing wave not as perfect as in Fig. 11 in Section 3.1 but the sound pressure distribution improved from ± 15 dB to ± 6 dB in the range from 10 Hz to 100 Hz the distribution is more even not only in the listening area but also along the room. Unfortunately a measurement of the whole listening plane in the room was not performed nevertheless informal listening tests have been performed verifying the effectiveness of the system. In room B the system did worse in frequencies from 90 to 100 Hz

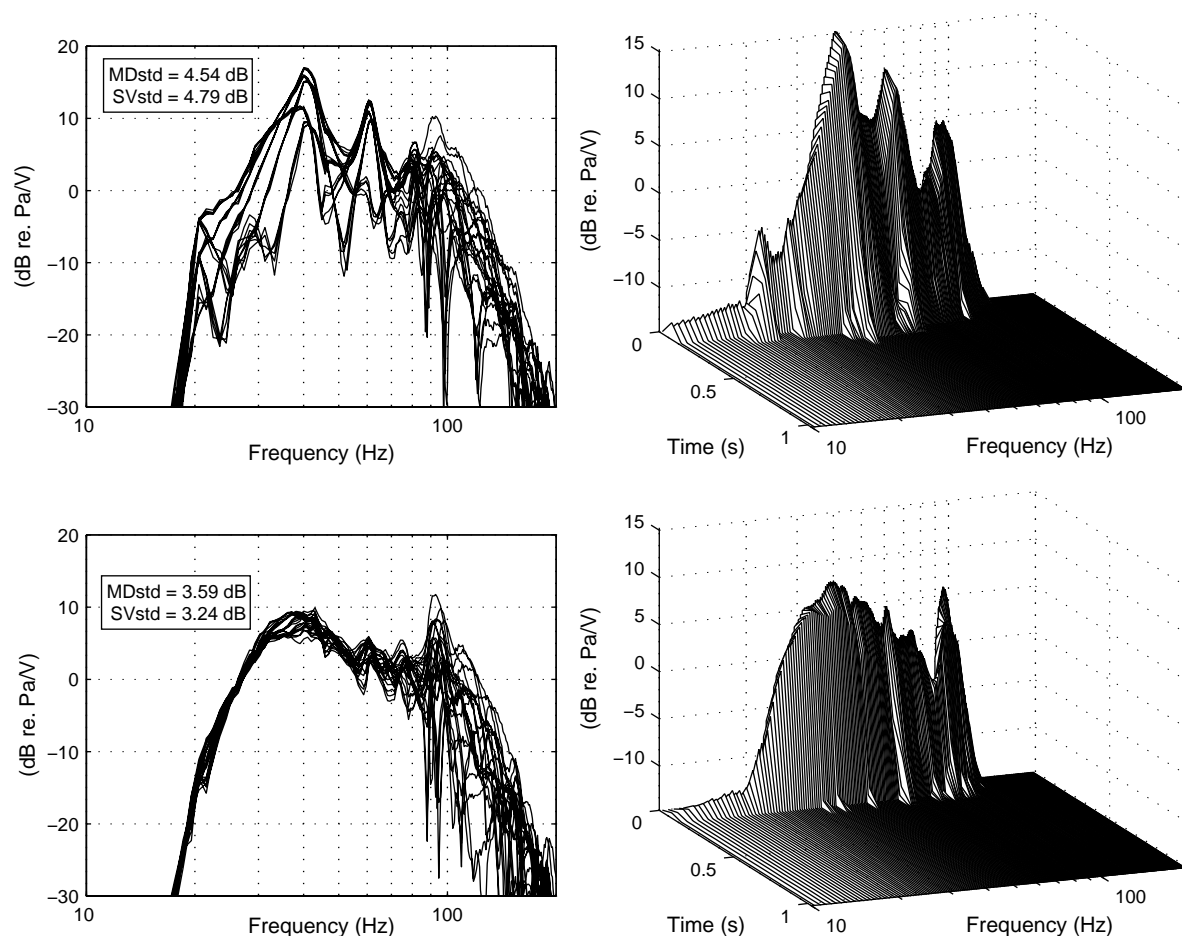

Fig. 17. Measurements of the equalization system in room B, setups 0.2.0 and 0.2.2. Left, frequency responses at the 25 positions, (upper) before equalization (lower) after equalization. Right, cumulative spectral decay (CSD) at one position, (upper) before equalization, (lower) after equalization.

see Fig. 17 since it increased a peak corresponding to the room mode (4 2 0). In room C the system did not work neither in the simulations nor in the real room. Very small improvement is seen from 15 Hz to 27 Hz in the measurements but in the other hand it makes it worse from 30 Hz to 50 Hz.

As it is clearly seen room A presents more problems than room B since the modal resonances are less overlapped than in room B. Nevertheless the equalization system performed well up to 132 Hz. In room B the equalization system performed well up to 87 Hz and in room C very small improvement is shown.

In order to have an overview of the equalization system in a general manner the mean of the 25 frequency responses before and after the equalization

on each room has been plotted in Figs. 19, 21 and 20.

5. DISCUSSION

As seen from the analysis in Section 2 when loudspeakers are placed in an enclosure a number of problems appear, magnitude deviations from ± 10 dB to ± 20 dB occur on the worse cases depending on the size and damping of the room. The deviations in magnitude from one position to another varies at some frequencies from ± 6 dB to cases where there is almost not sound at all. By first creating a plane wave in only one direction of the room which implies exiting only the axial modes of that direction and secondly canceling that plane wave using loudspeakers

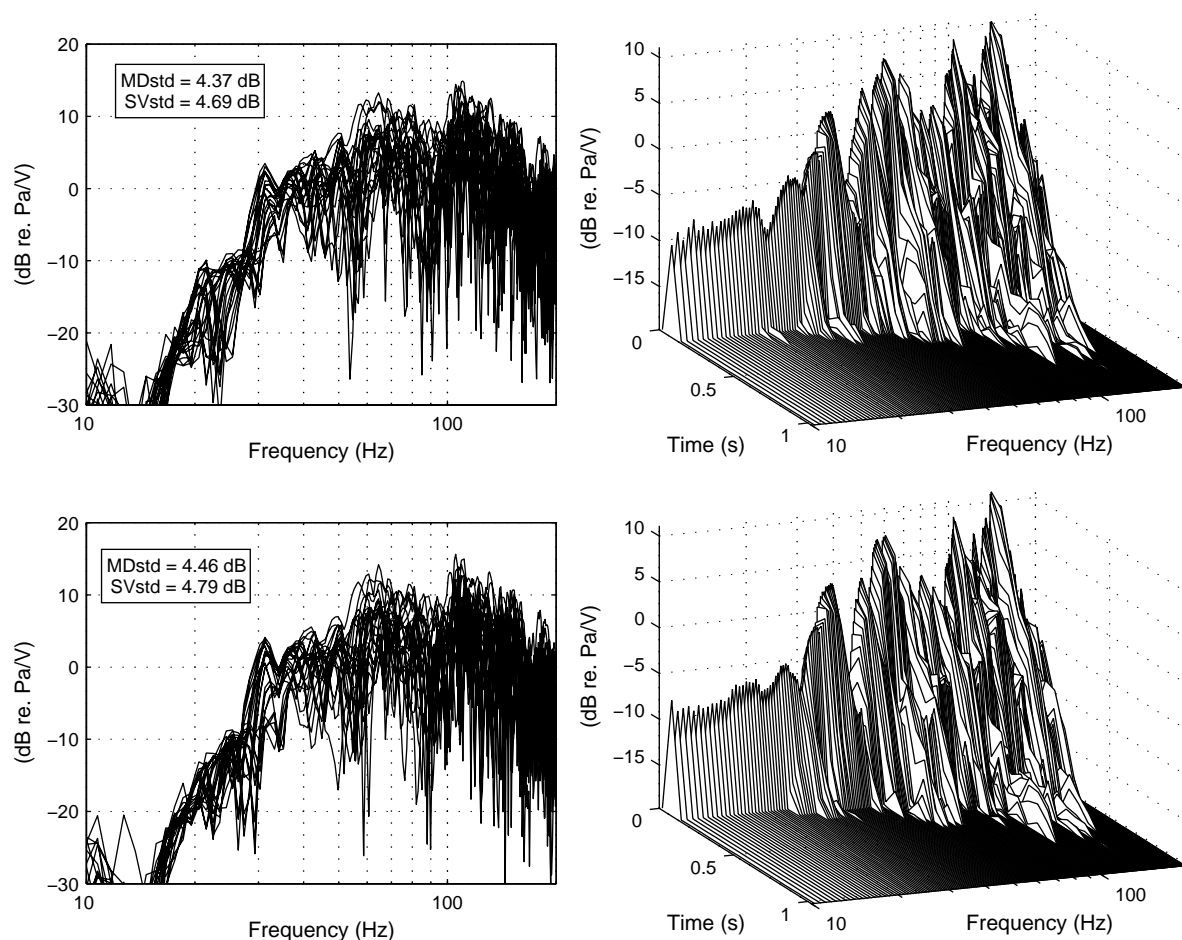

Fig. 18. Measurements of the equalization system in room C, setups 0.2.0 and 0.2.2. Left, frequency responses at the 25 positions, (upper) before equalization (lower) after equalization. Right, cumulative spectral decay (CSD) at one position, (upper) before equalization, (lower) after equalization.

ers delayed at the end wall in opposite phase with the traveling sound, optimal sound level distribution can be obtained. First the equalization system was tested on a simulation model and afterwards validated by measurements in real rooms. After having been simulated and measured the equalization system for low frequencies it can be said that the system performed well in room A and B improving both magnitude deviations and spatial variations. Generally it worked not only in the listening area but also in the whole room.

The system presents some variations at the modal frequencies, this variations are due to asymmetries in the room and the complexity of the ceiling in room A for example, and in room B because of the different impedance of the front wall and back wall. Interestingly seen from the right waterfall plots in Figs.

16 and 17 the modal frequencies are much more noticeable in room A than in room B so the improvement is worth in room A reducing the effect of the modal resonances but not completely, in room B instead the modal frequency do not ring as much as in room A therefore the room modes in room B decay faster than in room A in this case the improvement is not as obvious than in room A. As it was observed in the results the equalization system did not performed well in room C actually the problems in room C are not as bad as they are in room A or B before the equalization. One could obviously see that the improvement is not needed in room C since the room modes are very overlapped in the region from 30 Hz to 100 Hz. Furthermore a slightly improvement is observed at very low frequencies from 10 Hz to 27 Hz where in order to perceive those fre-

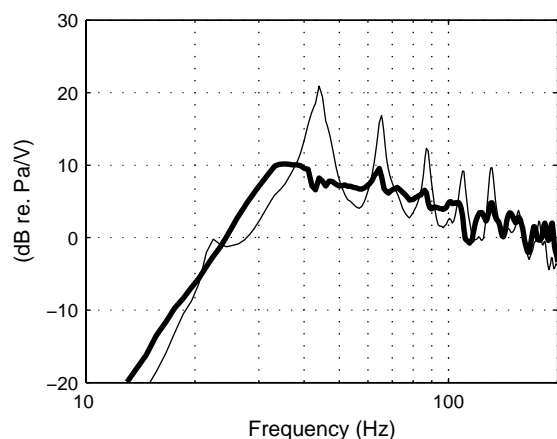

Fig. 19. Room A. Thin line mean of the frequency responses of the measurements at the 25 microphone positions before equalization. Thick line after equalization, setup 0.2.2.

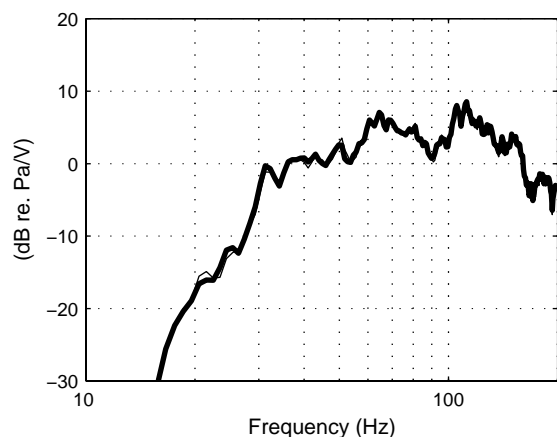

Fig. 20. Room C. Thin line mean of the frequency responses of the measurements at the 25 microphone positions before equalization. Thick line after equalization, setup 0.2.2.

quencies high acoustic power is needed, in fact most of the subwoofers are able to reproduce efficiently above 30 Hz. More loudspeakers at the front and at the back walls might be needed to create a plane wave with a back wall cancellation.

To summarize the system works depending on the size of the room, the smaller the room the more controllable the system will be. It can be said that if the equalization system is well implemented it should work up to the frequencies where a plane wave is formed at the front wall. A subject for discussion is if a complete flat response is wanted. This may depend on personal preference but the advantages of this equalization system is that it could be adjusted parametrically to certain degree of enhance-

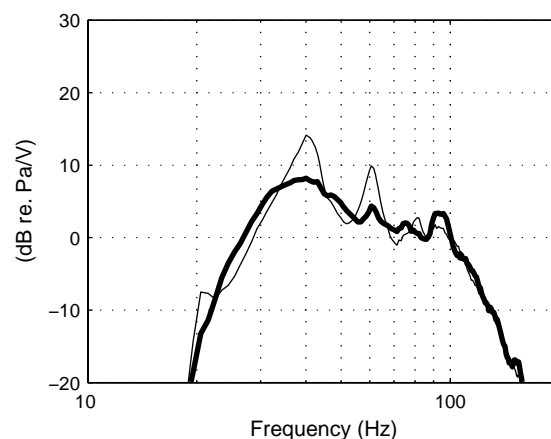

Fig. 21. Room B. Thin line mean of the frequency responses of the measurements at the 25 microphone positions before equalization. Thick line after equalization, setup 0.2.2.

ment depending on preference. Nevertheless as it is observed on Figs. 19 and 21 when the equalization system is on still there is a considerable effect of the room, that can be seen as a boost at low frequencies from 30 Hz to 50 Hz. One of the drawbacks of this approach is that extra loudspeakers, power amplifiers and simple signal processing equipment has to be added in order to cancel the sound at the back wall. A further research can be addressed to investigate the adequate amount of equalization that is really needed in terms of human preference.

6. CONCLUSION

The analysis of the low frequency performance of sound reproduction systems in three rectangular rooms of different size has been done. A simulation program based in FDTD has been used to render the sound field produced by typical sound reproduction systems in rectangular rooms. The three rooms are a standard listening room, a standard multichannel listening room and a concert hall for live performances. An effective method to equalize low frequencies in rectangular rooms has been simulated and implemented in these three rooms. The system uses two loudspeakers in the front wall of the room to create a traveling plane wave and an extra two low frequency loudspeakers in the back wall delayed and in opposite phase to remove the reflection of that wall. After measurements of the implemented system in the three rooms one can conclude that the system can work effectively in

small and middle size rectangular rooms. The system can achieve fairly good responses not only in a single listening position but also within a listening area and at very low frequencies in the whole room.

References

- [1] A. R. Groh, "High-Fidelity Sound System Equalization by Analysis of Standing Waves", *J. Audio Eng. Soc.*, vol. 22, pp. 795-799 (December 1974).
- [2] K. O. Ballagh, "Optimum Loudspeaker Placement Near Reflecting Planes", *J. Acoust. Soc. Am.*, vol. 31, pp. 931-935 (1983 December).
- [3] T. Welti, "How Many Subwoofers are Enough," *Proc. AES 112th Convention*, Convention Paper 5602. (May 2002)
- [4] J. Abildgaard Pedersen, "Adjusting a loudspeaker to its acoustic environment", *Proc. AES 115th Convention*, New York, convention paper 5880, (October 2003).
- [5] A. Mäkitvirta and P. Antsalo, "Modal Equalization of LoudspeakerRoom Responses at Low Frequencies" *J. Audio Eng. Soc.*, **51**, pp. 324-353. (May 2003)
- [6] S. J. Elliott and P. A. Nelson, "Multiple-Point Equalization in a Room Using Adaptive Digital Filters," *J. Audio Eng. Soc.*, **37**, pp. 899-907. (November 1989)
- [7] A. O. Santillan, "Spatially extended sound equalization in rectangular rooms," *J. Acoust. Soc. Am.*, **110**, pp. 1989-1997. (October 2001)
- [8] A. Celestinos and S. B. Nielsen, "Multi-source low frequency room simulation using finite difference time domain approximations," *Proc. AES 117th Convention*, Convention Paper 6264. (October 2004)
- [9] A. Celestinos and S. B. Nielsen, "Optimizing placement and equalization of multiple low frequency loudspeakers in rooms," *Proc. AES 119th Convention*, Convention Paper 6545. (October 2005)
- [10] B. Langvad, H. Møller and G. Budzynski "Testing a New Listening-Room," *Archives of Acoustics*, **14**, 1-2, pp. 45-60. (1989)
- [11] B. Chereck and B. Langvad, "Low Frequency Simulation of a Listening Room," *Proc. of Nordic Acoustical Meeting*, pp. 265-270. (1990)
- [12] T. Salava, "Acoustic Load and Transfer Functions in Rooms at Low Frequencies", *J. Audio Eng. Soc.*, vol. 36, pp. 763-775 (October 1988).
- [13] H. Kuttruff, *Room Acoustics*, 3th. Ed. E & FN Spon. (1999)
- [14] M. R. Schroder, "New Method of Measuring Reverberation Time," *J. Acoust. Soc. Am.*, **37**, pp. 409-412. (March 1965)
- [15] J. D. Bunton and R. H Small, "Cumulative Spectra, Tone Bursts and Applications" *J. Audio Eng. Soc.*, **30**, pp. 386-395. (June 1982)

Contents

1	INTRODUCTION	51
2	ANALYSIS OF THE SOUND FIELD ON THREE RECTANGULAR ROOMS	52
2.1	Room description	52
2.2	Sound Field Room Simulations	53
2.3	Measurements	55
3	THE EQUALIZATION SYSTEM	56
3.1	Creation of a Plane Wave	58
3.2	Removing the Reflection from the Back Wall	59
3.3	Optimal Equalization	63
4	RESULTS	63
4.1	Simulation of the Equalization System	63
4.2	Measurement of the Equalization System	63
4.3	Evaluation of the Equalization System	64
5	DISCUSSION	65
6	CONCLUSION	67
	References	68

Paper D

Controlled Acoustically Bass System (CABS), A method to achieve uniform sound field distribution at low frequencies in rectangular rooms

Adrian Celestinos^a, and Sofus Birkedal Nielsen^a

^a*Acoustics, Department of Electronic Systems, Aalborg University, DK-9220 Aalborg East, Denmark*

Abstract

Rectangular rooms have strong influence on the low frequency performance of loudspeakers. A simulation program based on the finite-difference time domain method (FDTD) has been used to analyse the sound field produced by loudspeakers in rectangular rooms at low frequencies. A new method called Controlled Acoustically Bass System (CABS) is introduced. The system utilizes front loudspeakers and extra loudspeakers at the opposite wall of the room processed to remove the back-wall reflection, which will give a more uniform sound field. The system works in the time domain and presents good performance in the low frequency range. CABS is simulated and measured on two different standard listening rooms.

1. INTRODUCTION

In recent years and since the advent of the stereophony the reproduction in high fidelity of music signals has drawn the attention of many researchers, professionals of the audio industry and a large amount of enthusiasts. More recently with the arrival of the digital technology and the new sound reproduction formats like multichannel surround sound the popularity of these systems has increased reasonably. From home theaters to concert hall arenas it is possible to experience low frequency sound through full range loudspeakers or powerful subwoofers dedicated to playback frequencies from 30 to 100 Hz. When a loudspeaker is placed in a room a number of problems arise. Modification of the response of the loudspeaker at the listening position occurs due to the strong reflections in the enclosure and the position of the loudspeaker. Sound repro-

duction systems are typically placed in small or medium size rectangular rooms and in some cases large halls. Every room has strong influence on the low frequency sound field and thereby also on the performance of the loudspeaker. The response of a loudspeaker will be highly influenced by its position in the room and the room properties. This is often problematic to control since the modal resonances modify the magnitude response of the sound source depending on the listening position and loudspeaker placement.

To deal with this problem several approaches have been investigated by a number of authors, over the last three decades among others Groh in [1], Allison in [2] and Ballagh in [3] have based their solutions on finding the optimum placement of the loudspeakers in the room. More recently Welti in [4] has based his approach on the use of multiple subwoofers on different configurations in the room. Another ap-

proach by Abildgaard in [5] is based on the control of the acoustic radiation power of the loudspeaker in a room. Large amount of research has been carried out on the approach of modeling the correct electrical filters often called modal equalization in [6] by Mäkivirta and Antsalo, or the so-called multiple point equalization technique by Elliot in [7], that by means of adaptive filtering techniques compensate a specific listening position in the room or an extended listening area. An interesting work done by Santillán *et al.* in [8] and [9] where the equalization system is based on the simulation of a plane wave traveling as in free field in a small room seems to be a suitable approach to come about to a solution to this complex problem even though this solution needs a large amount of loudspeakers and a large amount of measurements before the system is working properly.

The main goal of this paper is to improved the low frequency sound field in an extended listening area of a rectangular room by using multiple loudspeakers. The idea is to built a plane wave traveling towards the opposite wall where it will be canceled. This is done by using extra loudspeakers at the back wall with a delayed version of the signal but in anti phase. This approach was described before in [10] and [11] by the authors. In this paper the analysis in the time and frequency domains at low frequencies in rectangular rooms is presented. Simulations are performed using a program based on the finite-difference time domain method (FDTD) and finally measurements in two standard listening rooms are presented testing the performance of the enhancement system.

2. LOW FREQUENCY SOUND IN RECTANGULAR ROOMS

In this section the analysis of the sound field at low frequencies produced by typical sound reproduction systems placed in rooms is presented. The analysis is divided in three parts, first the physical problem is observed in the time domain secondly the problem is analysed in the joint time-frequency domains by the cumulative spectral decay (CSD) and finally in the frequency domain by the digital Fourier transformation (DFT). The impulse responses for the analysis are produced by the program based on FDTD implemented in MATLAB and presented by the authors in [10] and [12].

2.1. The building up of a standing wave in the time domain

Traditionally the problem of low frequency sound in rooms is analysed by the modal theory which parts from the solution of the wave equation in lossless, rigid-walled, rectangular enclosures as described in [13] pp. 349. It assumes a steady state situation produced by the sound source driven by pure frequency tones. In order to clearly understand the physical problem it is of great importance to perform the analysis in the time domain. Assuming a room of only rigid walls in both ends and a loudspeaker in one end of the room. If the dimension corresponds to multiples of half of the wavelength of the produced sound by the loudspeaker the reflection with the opposite wall will meet the sound coming from the loudspeaker in some places with constructive phase and in some places with destructive phase. The reflection will return to the wall at the loudspeaker exactly in phase with the sound radiating from the loudspeaker. The resulting addition of these waves coming from reflections of the walls and the loudspeaker itself will form sections in the room where there is almost no sound pressure and zones where there is a high sound pressure level. This frequencies are commonly known as *resonance frequencies*, *modal frequencies* or *natural frequencies* of the room given by

$$f_{rn} = \frac{c}{2L}(n) \quad (1)$$

where L is the length of the room, c is the speed of sound in the air and n is an integer starting with 1, 2, 3,... In the cases where the dimension corresponds to an odd integer times one quarter of the wavelength there will always be a minimum sound pressure level at the proximity of the loudspeaker and a maximum at the opposite wall, those frequencies are known as *anti-resonances* or *anti-modal frequencies* of the room given by

$$f_{an} = \frac{c}{4L}(2n - 1). \quad (2)$$

This examples can be observed in the sequence of plots in Fig. 1 for a resonance frequency and in Fig. 2 for an anti-resonance frequency where sequences of snapshots in the time domain of the instantaneous pressure along the room are presented.

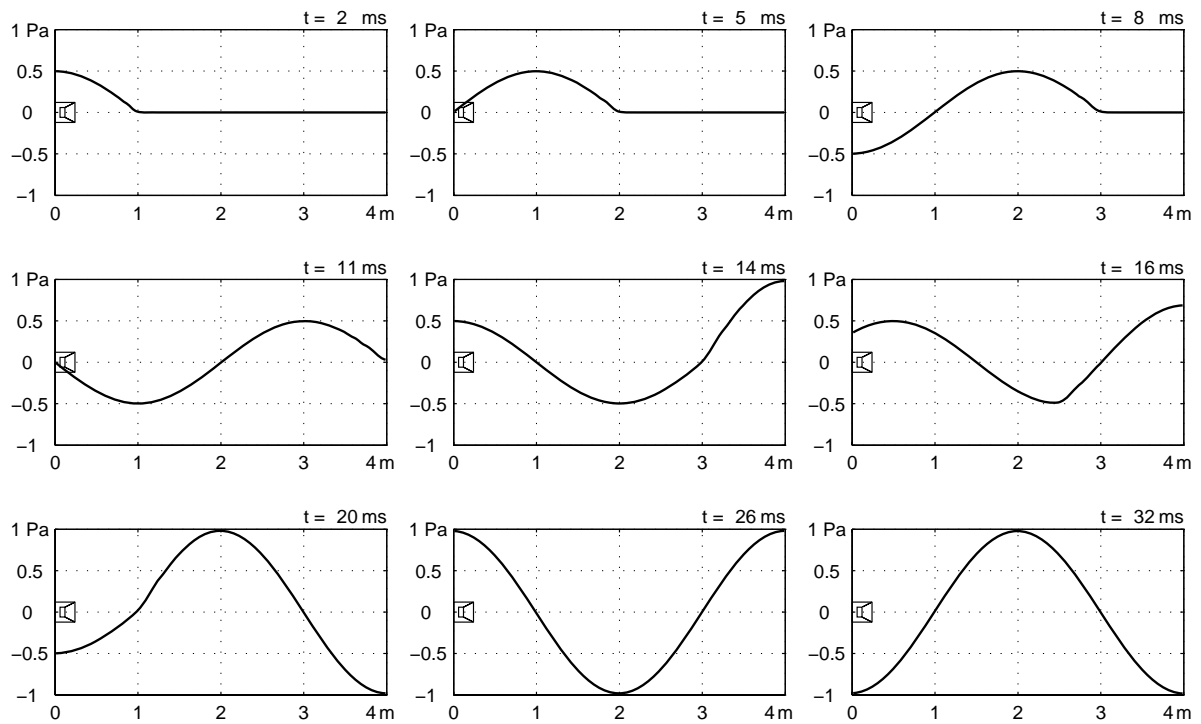

Fig. 1. Analysis in the time domain of a resonance frequency.

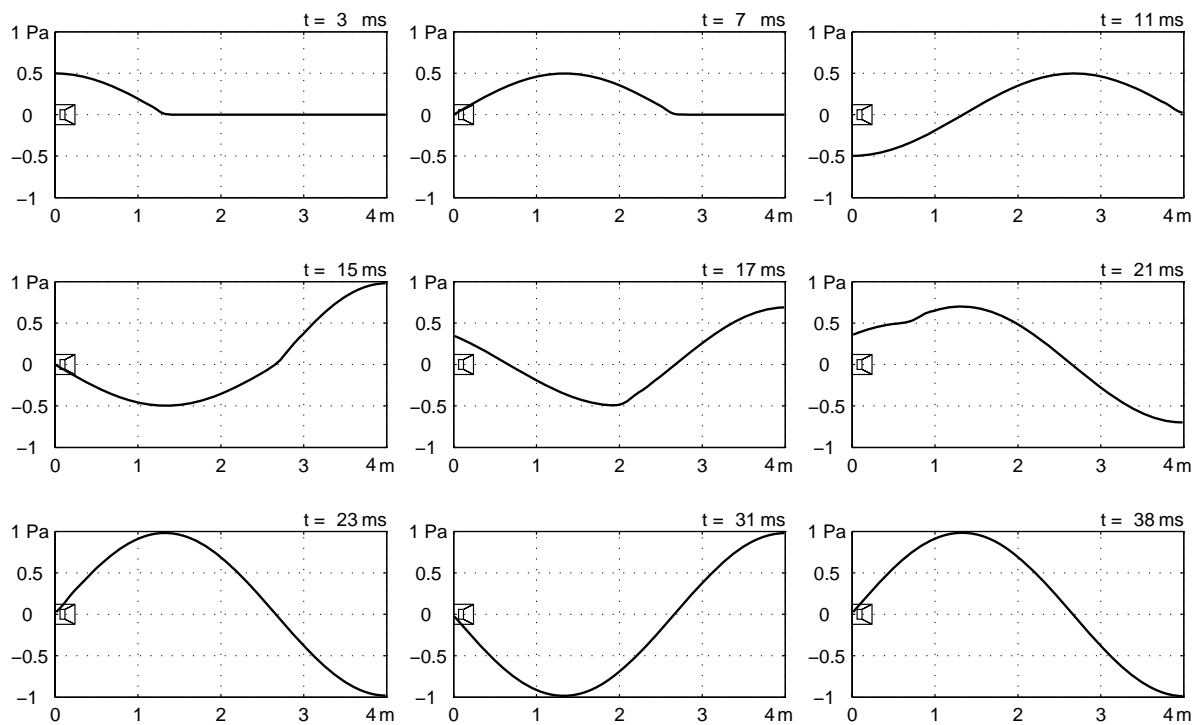

Fig. 2. Analysis in the time domain of an anti-resonance frequency.

In the case of a three-dimensional room the *natural frequencies* are given by

$$f_n = \frac{c}{2} \sqrt{\left(\frac{n_x}{L_x}\right)^2 + \left(\frac{n_y}{L_y}\right)^2 + \left(\frac{n_z}{L_z}\right)^2} \quad (3)$$

where c is the speed of sound in the air, n_x, n_y and n_z are integers starting with 0, 1, 2, ... and L_x, L_y, L_z are the dimensions of the room [14].

The zones where there will be minimum sound pressure level are called *nodes* and the points where there exists a maximum of sound pressure are called *anti nodes* [13]. The number of modal frequencies per 1 Hz and the number of room modes both below f are computed according to equations

$$\Delta N_f = 4\pi V \frac{f^2}{c^3} + \frac{\pi}{2} S \frac{f}{c^2} + \frac{L}{8c} \quad (4)$$

and

$$N = \frac{4\pi}{3} V \left(\frac{f}{c}\right)^3 + \frac{\pi}{4} S \left(\frac{f}{c}\right)^2 + \frac{L}{8c} f \quad (5)$$

where S is the area of all walls $2(L_x L_y + L_x L_z + L_y L_z)$, V is the volume of the enclosure and $L = 4(L_x + L_y + L_z)$ the sum of all edge lengths of the room [14]. This is often called modal density which are descriptors that can give an estimate of the spread of the room modes below certain frequency knowing just the dimensions of the room.

Another descriptor called the Schroeder frequency fg is calculated according to

$$fg = 2000 \sqrt{\frac{T60}{V}} \quad (6)$$

where $T60$ is the reverberation time in seconds and V is the volume of the room, this frequency can be taken as the upper limit where the discrete standing waves predominate and the simplifications of the statistical theory of sound field in enclosures can not be applied [14], [15].

The irregularities in the sound pressure level distribution within the room will appear not only at the modal or anti-modal frequencies but also on the rest of the frequencies where the wavelengths are long enough comparable to the dimensions of the room. It is important to say that Generally for example there will always be a node in sound pressure level at a distance corresponding to one quarter of a wavelength

from a reflecting wall. As the reflected wave and the arriving wave will always be in opposite phase.

2.2. Simulations on a three dimensional Virtual Room

So far the analysis has been done in Fig. 1 and Fig. 2 carrying on simulations of a room of one dimension now assuming a three-dimensional room from now named the "Virtual Room" with rigid walls and width $L_x = 4.20$ m, length $L_y = 7.8$ m and height $L_z = 2.76$ m which is similar to the IEC standard listening room at Aalborg University. The sound field produced by a typical subwoofer shown in Fig. 3 positioned in one of the corners on the floor as shown in Fig. 5 is simulated. For simplicity the following notation is introduced

.	F	.	B
Nr. of front wall full range	Nr. of front wall subwoofers	Nr. of back wall subwoofers	

to indicate for example a stereo setup of two full range loudspeakers the notation 2.0.0 is used. For a stereo setup of two full range loudspeakers plus a subwoofer the notation 2.1.0 is used. For example the notation .2.2 indicates a configuration with two subwoofers in the front wall of the room and two subwoofers on the back wall with a different signal.

To have an overview on how the magnitude deviations are in more than one position within the room

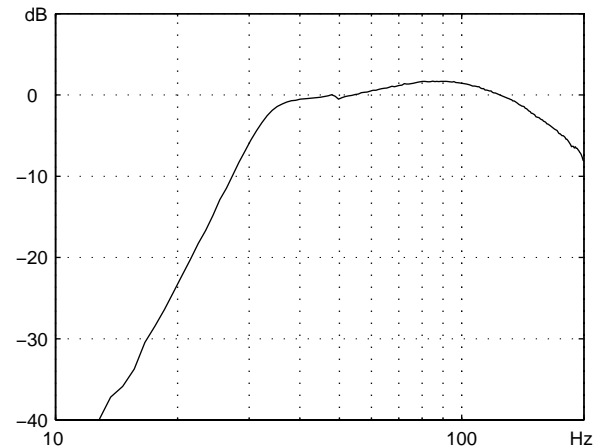

Fig. 3. Anechoic response of a typical subwoofer measured near the membrane.

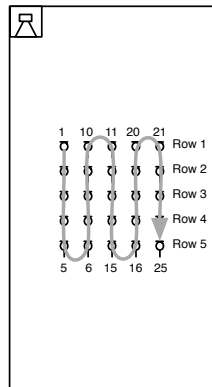

Fig. 4. The 25 virtual microphone positions in the listening area of the Virtual Room, loudspeaker setup .1.0 .

the sound field is sampled in a listening area of $(1.92 \times 1.92 \text{ m})$ centered in the room delimited by 25 virtual microphones equally spaced by 48 cm at a height of $z = 1.38 \text{ m}$ as seen in Figs. 4 and 5. The frequency response at the 25 positions are presented all in one plot in Fig. 6 where it is clear how severe the deviations are and how they change according to position. In some cases the differences in magnitude exceed more than 25 dB along the frequency range from 20 to 200 Hz. In Fig. 8 the sound field produced by the same subwoofer now positioned off the corner as in Fig. 7 at $x = 1.26 \text{ m}$, $y = 1.62 \text{ m}$ and $z = 0.18 \text{ m}$ on the floor is presented.

Continuing with the analysis the setup .2.0 as shown in Fig. 13 at one end of the Virtual Room at a height $z = 1.38 \text{ m}$ is simulated. Assuming that the loudspeakers at low frequencies behave as omnidirectional sound sources and both producing the same signal, in this case the low pass filtered impulse shown in Fig. 9 and Fig. 10 which output has a frequency range from 1 Hz to 100 Hz is used as the input for the sound source in the simulation. Then the instantaneous sound pressure has been obtained by the simulation model in an horizontal slice of the room at a height of $z = 1.26 \text{ m}$. This is shown in Fig. 11 where a sequence of snap shots in the time domain of the instantaneous pressure are presented. As it can be observed the combination of both loudspeakers produces a plane wave traveling along the length of the room towards the opposite wall. After reflecting to the back wall it continues back and forward until it dies out.

In Fig. 12 three graphs are presented, the sound pressure level distribution produced by a modal fre-

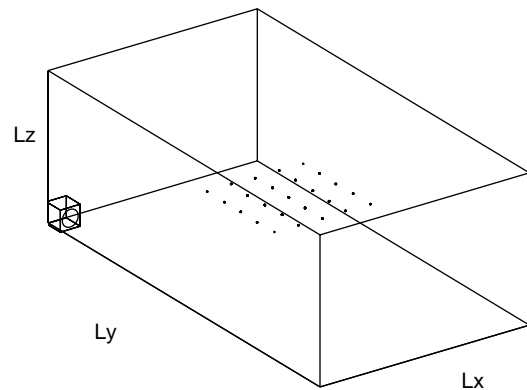

Fig. 5. The three dimensional Virtual Room model and loudspeaker setup .1.0 in the corner of the room.

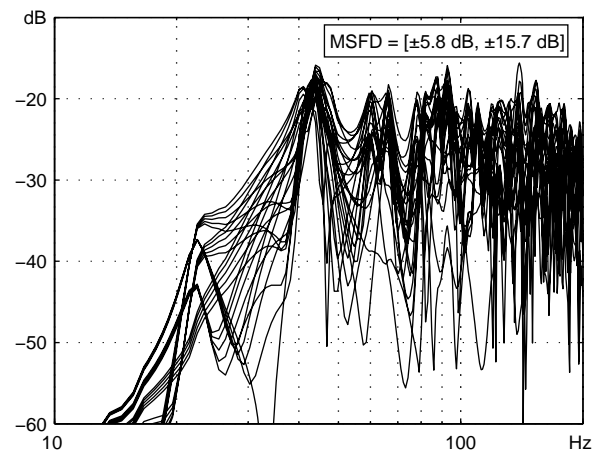

Fig. 6. Frequency responses at the 25 virtual microphone positions in the listening area of the Virtual Room, setup .1.0 the loudspeaker is in the corner of the room.

quency, an anti modal frequency and 60 Hz this is computed by the simulation program at the listening height $z = 1.26 \text{ m}$. It is clearly seen the sections where there is high sound pressure level and where there is a minimum level. This differences can be more than 20 dB in the extreme points depending on the damping of the room.

2.3. Time and frequency analysis

After analysing the problem in the time domain it is of interest to know how severe is the problem in both time and frequency domains. A way to do this analysis is by calculating the Cumulative Spectral Decay (CSD) on one of the listening positions in the Virtual Room. The same setup .2.0 shown in Fig. 13

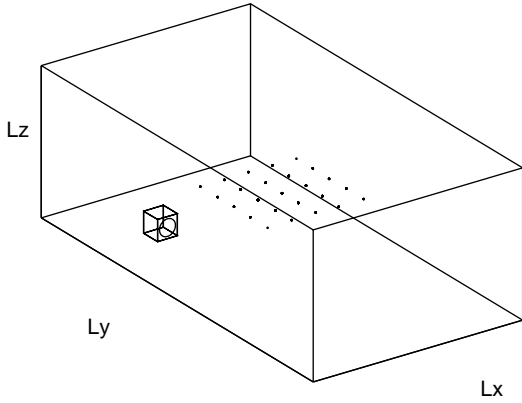

Fig. 7. The three dimensional Virtual Room model and loud-speaker setup .1.0 off the corner of the room.

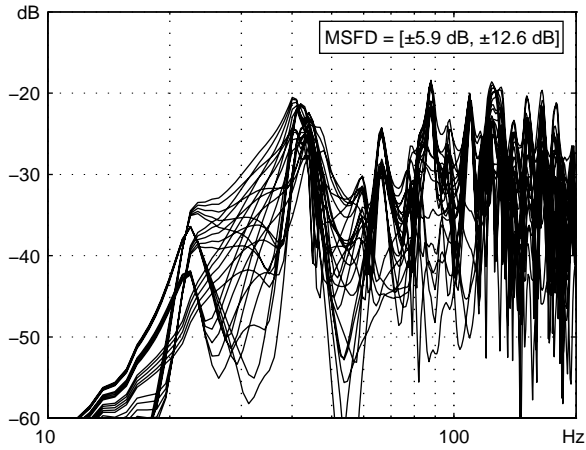

Fig. 8. Frequency responses at the 25 virtual microphone positions in the listening area of the Virtual Room, setup .1.0 the loudspeaker is off the corner of the room.

has been simulated and utilizing the two subwoofers which anechoic response is presented in Fig. 3 . The CSD is performed by applying a sliding “apodized rectangular window” and calculating the discrete Fourier transform (DFT) to the impulse response as in [6] and [16]. The first part of this window is built by the raising half of a gaussian window corresponding to 32 ms long applied each 64 ms from $t = 0$ s to the end of the impulse response at the virtual microphone position. The impulse response is 1024 ms long. The result of this is presented in Fig. 15 on a waterfall plot where it is clearly seen how the modal frequencies keep going in time longer than the others and how severe the amplitude deviations are along the frequency axes.

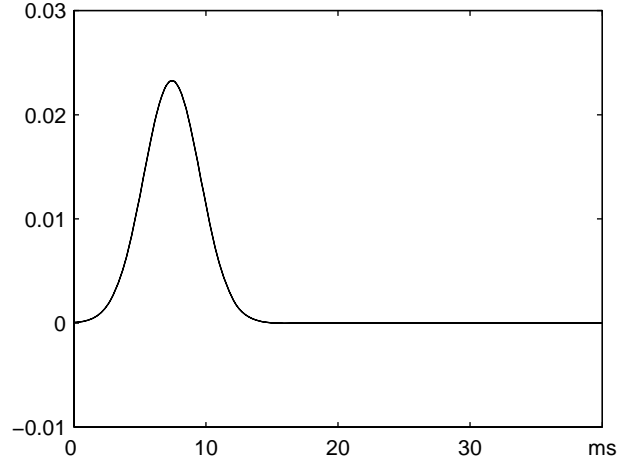

Fig. 9. Impulse response of the loudspeaker used as the input for the simulation in the time domain of Virtual Room on Section 2.2.

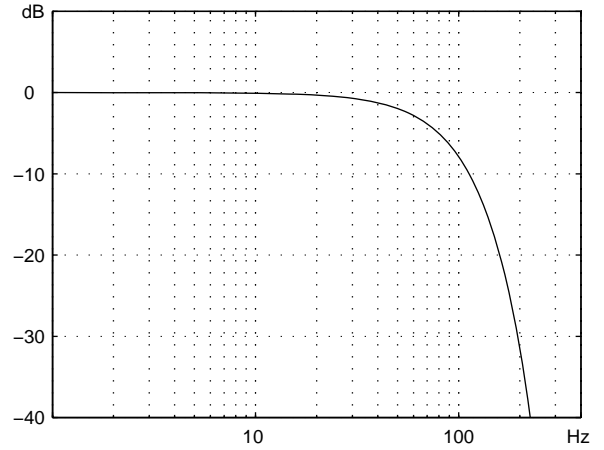

Fig. 10. Frequency response of the loudspeaker used as the input for the simulation in the time domain of Virtual Room on Section 2.2.

2.4. Quantification Parameters

In Fig. 14 the frequency response at the 25 positions using the setup .2.0 with two subwoofers are presented all in one plot. Although only 5 curves can be seen there are 25 measurements but as the sound distributes as a plane wave the five microphones in one row will give the same results. It is clear that in some cases the differences in magnitude exceed more than 20 dB along the frequency range from 20 to 200 Hz.

In order to quantify the deviations of the sound field distribution along the listening area a new pa-

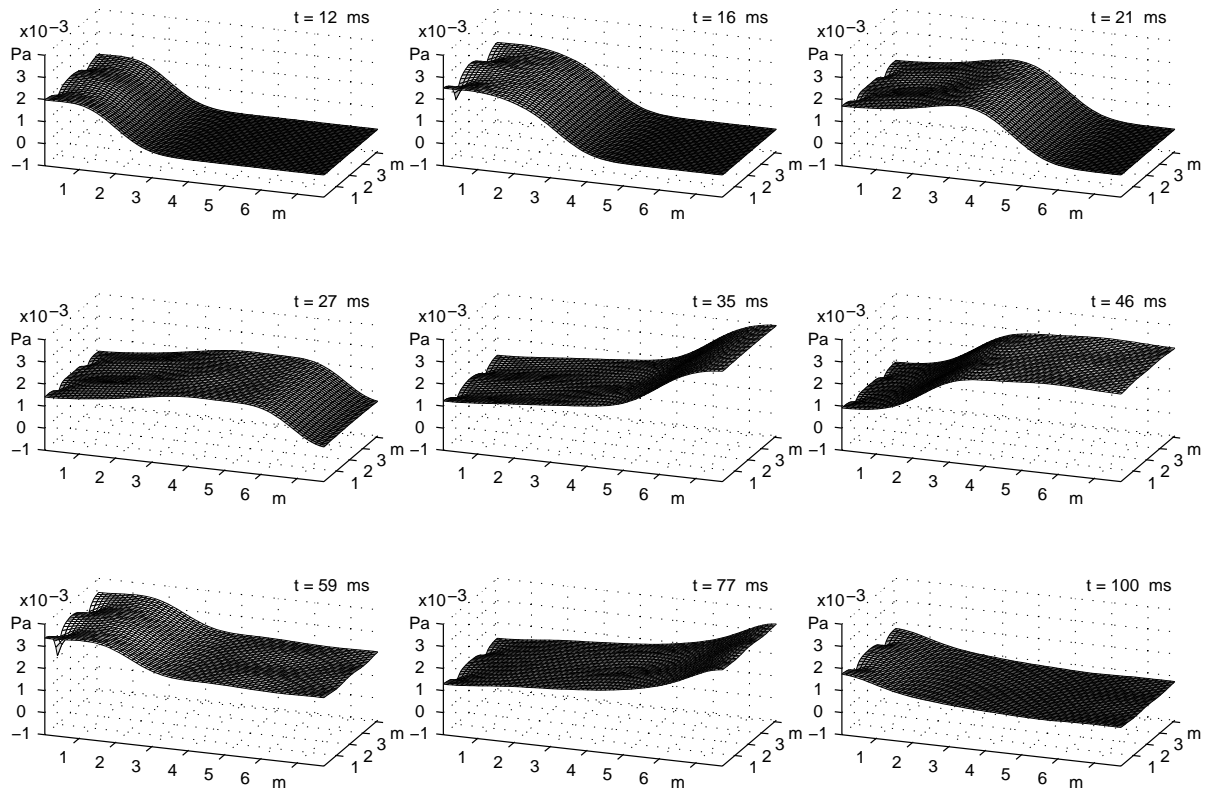

Fig. 11. Sequence of snap shots in the time domain of the instantaneous sound pressure using setup of loudspeakers .2.0 in the Virtual Room.

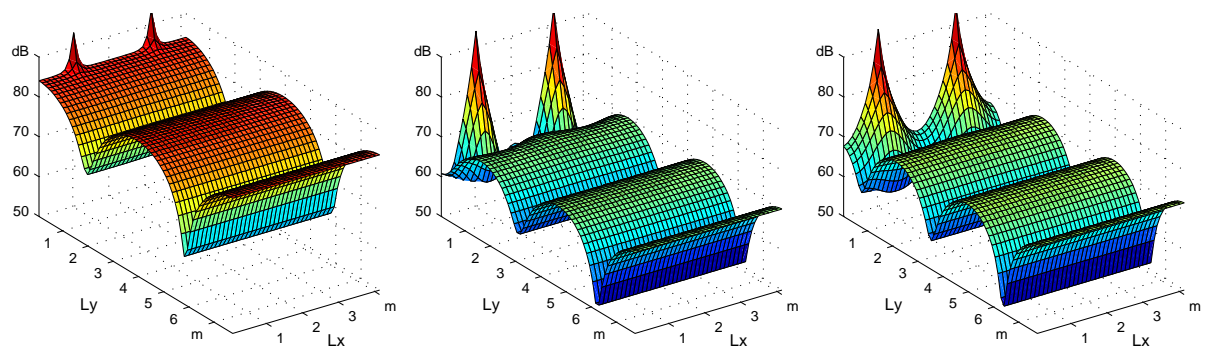

Fig. 12. Sound pressure level distribution resulting from the simulation of the Virtual Room measured on a plane at a height of $z = 1.38$ m using setup .2.0. Left produced by 44 Hz (modal frequency). Middle, produced by 55 Hz (anti modal frequency). Right, produced by 60 Hz.

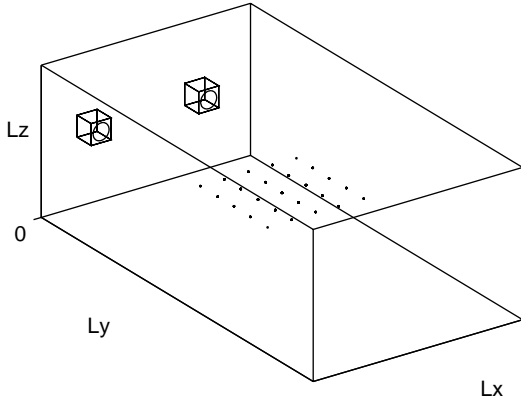

Fig. 13. The three dimensional Virtual Room model and loudspeaker setup .2.0 .

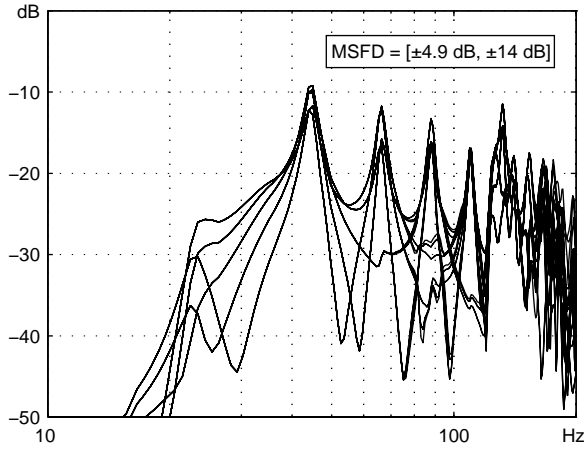

Fig. 14. Frequency responses at the 25 virtual microphone positions in the listening area of the Virtual Room, setup .2.0 .

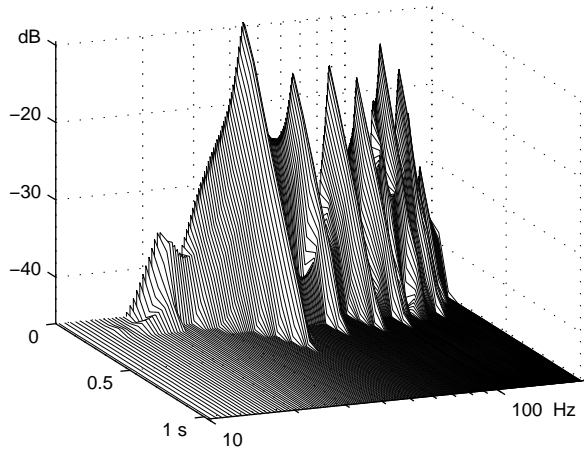

Fig. 15. Cumulative spectral decay at the labeled 17 listening position in the Virtual Room, setup .2.0 .

parameter is introduced the *Mean Sound Field Deviation (MSFD)*. This measure is calculated from the frequency response of the 25 impulse responses in the listening zone. The *MSFD* expressed in Eq. (9) is conformed by two numbers, the *Spatial Deviation (SD)* which expresses the deviations within the space in \pm dB and the *Magnitude Deviation (MD)* which reveals the magnitude spectral deviations also in \pm dB.

To calculate this parameter the magnitude of the frequency responses of all microphone positions are arranged in a table following the pad sketched in Fig. 4, this is done for presentation purposes since the arrangement will not change the result of the calculation. Then the whole listening area is represented in this table where the rows are the listening positions and the columns are the frequencies from $f_{low} = 20$ to $f_{high} = 100$ Hz this can be seen in Table 1 where an example of the first five positions and five frequencies is presented. Next the standard deviation on each frequency column is calculated so that the *Spatial Deviation SD* is the mean of all standard deviations of individual frequencies along positions as it is expressed in Eq. (7). The same manner the standard deviation is calculated on each row position so that the *Magnitude Deviation MD* is the mean of all standard deviations on individual positions along frequencies as it is expressed in Eq. (8).

$$SD = \frac{1}{n_f} \sum_{i=f_{low}}^{f_{high}} \sqrt{\frac{1}{n_p - 1} \sum_{p=1}^{n_p} (x_{p,i} - \bar{x}_i)^2} \quad (7)$$

$$MD = \frac{1}{n_p} \sum_{p=1}^{n_p} \sqrt{\frac{1}{n_f - 1} \sum_{i=f_{low}}^{f_{high}} (x_{p,i} - \bar{x}_p)^2} \quad (8)$$

$$MSFD = [SD \pm dB, MD \pm dB] \quad (9)$$

To illustrate this parameters an example of the deviations of sound pressure along all positions in the listening area at 55 Hz is presented in Fig. 16. As it can be observed the parameter *SD* reveals deviations within ± 6.9 dB. In Fig. 17 an example of the *Magnitude Deviation MD* is shown where there are deviations of more than ± 9 dB at one of the positions. In Fig. 18 the complete Table 1 is plotted as a surface plot to visualize the deviations of the sound field in the complete listening area.

So far the *MSFD* has been calculated from a frequency domain transformation but it is of interest

Table 1
Example of table for calculations of Mean Sound Field Deviation (*MSFD*).

<i>Mic.Position</i>	<i>Frequency (Hz)</i>								<i>MD ± (dB)</i>
	<i>20</i>	<i>21</i>	<i>22</i>	<i>23</i>	<i>24</i>	<i>25</i>	<i>...</i>	<i>100</i>	
1	-53.56	-47.27	-41.00	-34.81	-28.95	-26.00	...	-29.77	14.55
2	-54.30	-52.55	-47.20	-40.20	-33.47	-29.85	...	-43.52	14.68
3	-48.81	-47.72	-46.70	-45.00	-40.71	-36.63	...	-28.91	13.87
4	-45.00	-42.89	-40.67	-38.32	-36.28	-37.27	...	-27.23	13.90
5	-42.42	-39.80	-36.91	-33.71	-30.58	-30.23	...	-33.12	13.08
⋮	⋮	⋮	⋮	⋮	⋮	⋮	⋮	⋮	⋮
25	-42.42	-39.80	-36.91	-33.71	-30.58	-30.23	...	-33.12	13.08
<i>SD ± (dB)</i>	4.75	4.46	3.99	4.13	4.27	4.40	...	5.42	

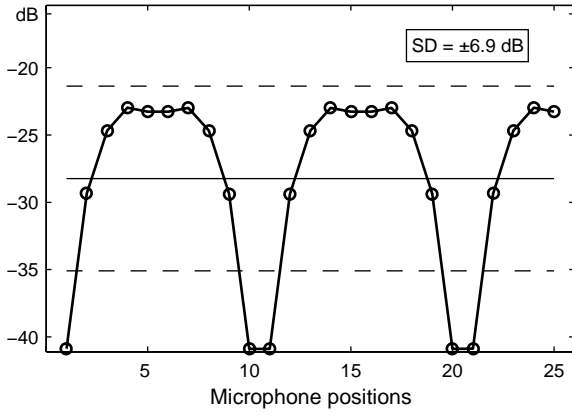

Fig. 16. Example of the spatial deviations along the listening area at 55 Hz. Dashed lines show the range of the standard deviation, the horizontal line is the mean. The parameter *SD* reveals deviations up to ± 6.9 dB, loudspeaker setup .20 in the Virtual Room.

to have also a measure that can give information from the time responses. An interesting parameter in room acoustics named *Definition* used by Thiele in [17] and originally called in German “Deutlichkeit” was chosen to give a criterion of the ratio of energy between the early part of the impulse response and the remaining part. The *Definition (D)* is obtained by

$$D = \frac{\int_0^{50ms} [g(t)]^2 dt}{\int_0^{\infty} [g(t)]^2 dt} 100\% \quad (10)$$

where $[g(t)]$ is the impulse response and the lower

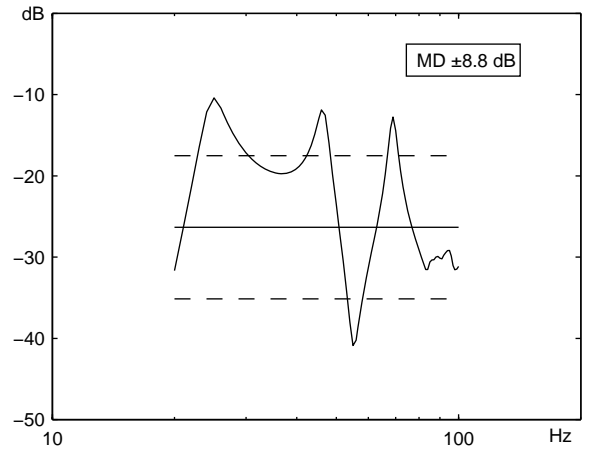

Fig. 17. Example of the frequency response at position 11 in the listening area, the parameter *MD* reveals spectral deviations up to ± 8.8 dB, loudspeaker setup .20 in the Virtual Room.

limit of integration 0 is the arrival of the direct sound. An anechoic impulse response of a loudspeaker would give about 99% of *D*. On the other hand a loudspeaker measured in a normal living room would give lower percentages of *D*. The same manner as the *MSFD* the frequency range of the analysis was from 20 Hz to 100 Hz therefore to extract this number the impulse responses were low pass filtered before the calculation. In Fig. 19 the first 500 ms of the 25 impulse responses align in time are shown after the calculation of *D*. As expected the parameter $D = 56.4\%$ revealed a high influence of the room on the time responses. It is also obvious just by inspection of the impulse responses to see how the sound highly interacts with the room.

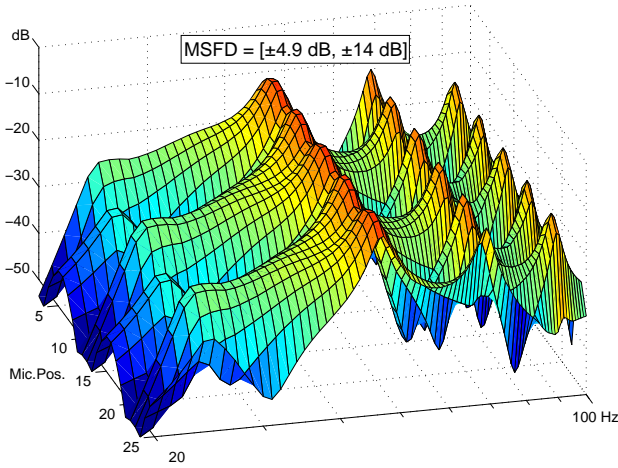

Fig. 18. Mean Sound Field Deviation (*MSFD*) table presented as a surface plot, setup .2.0 .

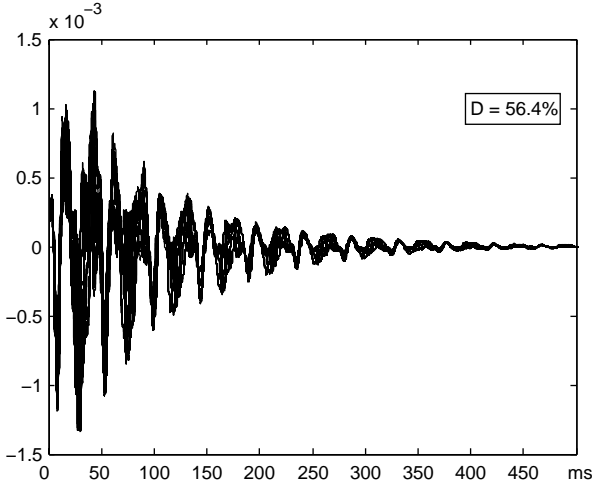

Fig. 19. The 25 impulse responses of the listening area in the Virtual Room, loudspeaker setup .2.0 after the calculation of Definition *D*.

2.5. Traditional one point equalization

As learned in this section the response of loudspeakers in small or middle size rooms would give peaks and notches of more than 20 dB in magnitude difference, in these cases electronic equalization would not be the best solution since the range of most equalizers would not be sufficient to compensate for example a deep of -20 dB at 50 Hz. Even if it was possible to compensate a deep of -20 dB the loudspeaker would not handle the high boost and it will introduce large amount of distortion. In some cases the traditional electronic equalization implemented

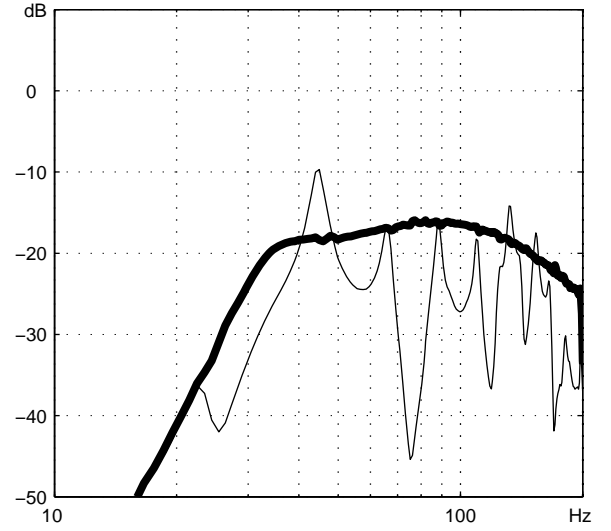

Fig. 20. Thin curve, frequency response at the microphone position before one point equalization. Thick curve same microphone position after equalization, Virtual Room, loudspeaker setup .2.0 .

typically by sampling the sound field with a microphone at a listening position and designing a filter with the different known adaptive techniques it may work at one single position but it will make it worse at some of the other positions.

This is illustrated in Fig. 20 where the frequency responses at the listening position before and after equalization are shown. The equalization filter design is performed in MATLAB by the method of frequency sampling-based digital Finite Impulse Response (FIR) filters with arbitrarily shaped frequency response [18] [19].

The target filter response is the anechoic response of the loudspeaker. It can be seen that the response has been corrected in that particular position and some other positions but in contrast the remaining positions got worse now having boosted 20 dB a peak at 76 Hz, that can be seen in Fig. 21 and Fig. 22. Comparing with Fig. 14 and Fig. 18 the *MSFD* does not present a clear improvement in the complete listening area. The only improvement is in the listening position where the parameter *D* went from 57.0 % to 94.8 % shown in Fig. 23. However by looking at the 25 impulse responses before and after the equalization in Fig. 24 it is clear that the responses did not get any improvement going from a $D = 59.0\%$ to a $D = 56.8\%$. Here the parameter *D* was calculated up to 200 Hz in both situations (before and after equalization) since the equalization filter was

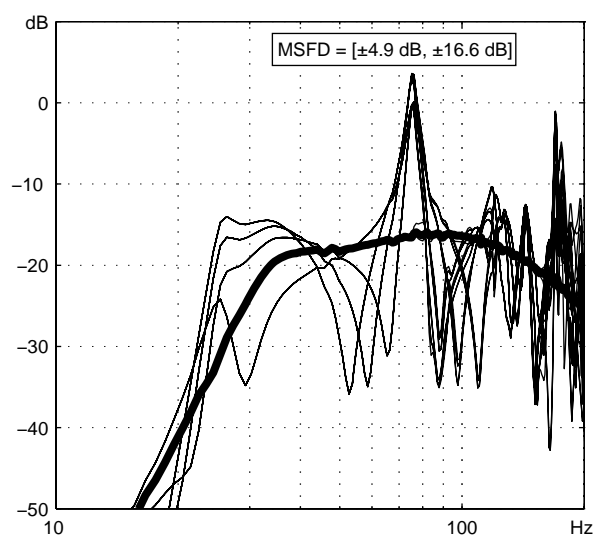

Fig. 21. Thin curves frequency responses of the 25 virtual microphone positions in the listening area of the Virtual Room after the traditional one point equalization. Thick curve is the microphone position equalized, loudspeaker setup .2.0 .

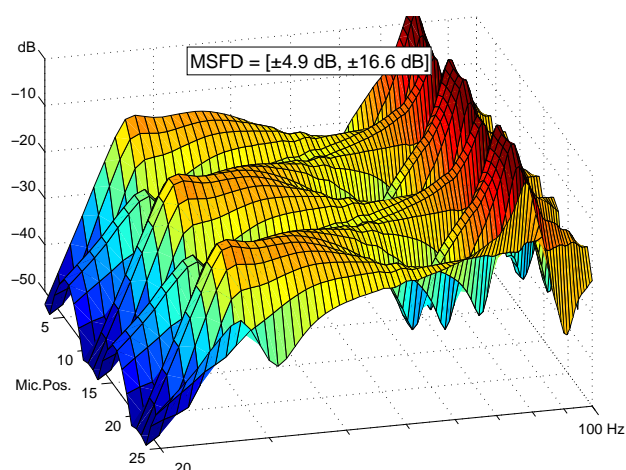

Fig. 22. Mean Sound Field Deviation (*MSFD*) after the traditional one point equalization, Virtual Room, loudspeaker setup .2.0 .

design to compensate to this frequency limit.

3. UNIFORM SOUND PRESSURE DISTRIBUTION IN THE ROOM

As learned in Section 2 the response of a loudspeaker placed in an enclosure will give irregular sound pressure level distribution in the room due to the multiple reflections of the sound to the walls. Electronic

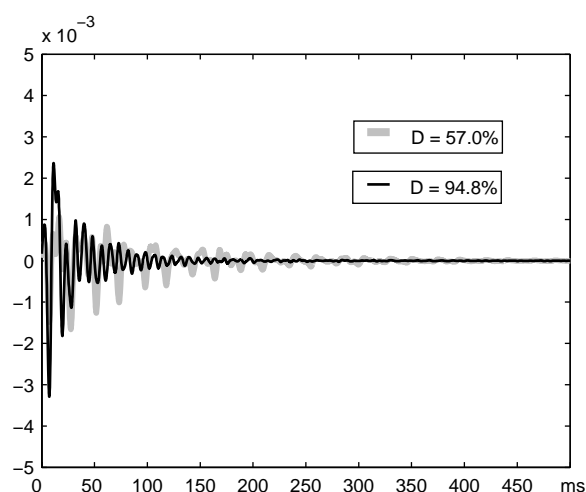

Fig. 23. Gray curve, impulse response of the listening position before equalization. Black curve the same position after the equalization resulting of simulations of Virtual Room, loudspeaker setup .2.0 .

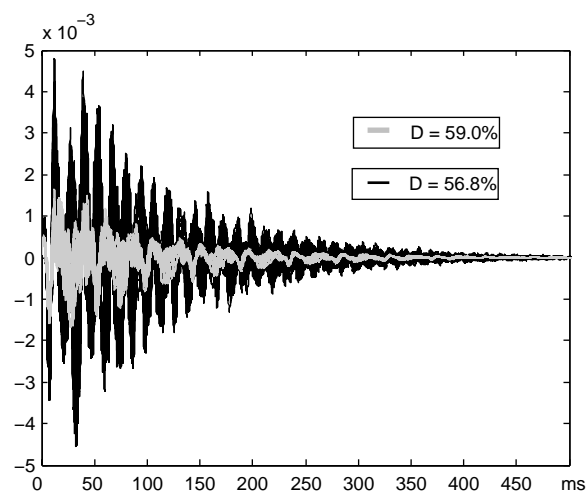

Fig. 24. Gray curves, the 25 impulse responses at the listening area in the Virtual Room before equalization. Black curves, after one point equalization. Loudspeaker setup .2.0

equalization may work in a limited listening position while worsening the responses elsewhere in the room.

A way to improve the sound pressure distribution in the whole room is to remove the reflection from the back wall. This can be inferred after simulating the setup .2.0 in the Virtual Room but in this case removing the back wall. This is done by setting the impedance of that boundary to the impedance of the air. The results of this simulation are shown in Fig. 25 and Fig. 26. It is clear that the sound field is

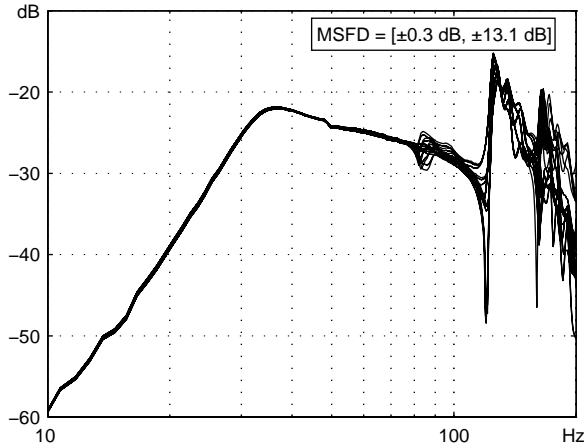

Fig. 25. Frequency response at the 25 positions resulting from the simulation of the Virtual Room removing the back wall by setting the impedance of that boundary to the impedance of the air, loudspeaker setup .2.0 .

uniform in the whole room and very small spectral deviations exists up to 110 Hz. However one must be sure to create a plane wave traveling along the room, in this manner the problem becomes unidimensional since the room will only be exited in one direction. Instead of removing physically the back wall or having a full absorbing back wall which is unpractical and almost impossible to achieve, this front wave can be canceled out exactly at this point by producing the frontal sound delayed at the back wall but in opposite phase and with proper amplitude.

3.1. Construction of a Plane Wave

To achieve optimum sound pressure level distribution inside a rectangular room of volume $V = L_x L_y L_z$ and assuming N number of sound sources on the wall at $y = 0$ a traveling plane wave in the y direction has to be constructed.

By placing the loudspeakers equidistantly in the x and z directions mostly the axial modes in the y direction will be excited and the amplitude of the other modes will be reduced significantly [9]. It has been found that actually with a total of two sound sources placed at $y = 0$, $x = L_x/4$ and $x = L_x 3/4$ respectively and at a height $z = L_z/2$ a plane wave can be constructed reducing the amplitude of the room modes corresponding to (0 2 0) and (0 0 1) of Table 6 and their combinations.

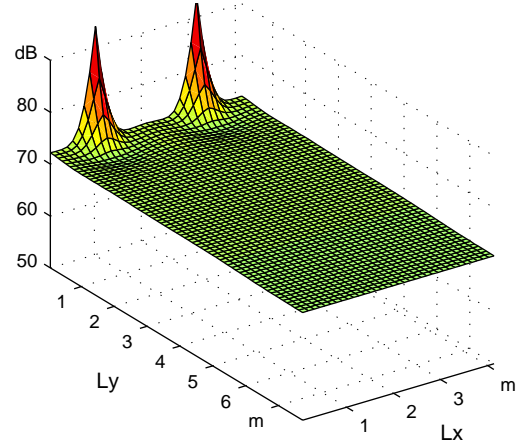

Fig. 26. Sound pressure level distribution resulting from the simulation of the Virtual Room removing the back wall by setting the impedance of that boundary to the impedance of the air. Sound pressure measured on a plane at a height of $z=1.38$ m using loudspeaker setup .2.0 and driven frequency of 44 Hz.

Considering the Virtual Room used in Section 2 as an example simulations have been carried out using an absorption coefficient of $\alpha = 0.12$ in all walls. On the upper left plot of Fig. 27 the sound pressure level distribution is measured at a height of $z = 1.38$ m, one loudspeaker driven by 75 Hz is located on the floor at $z = 0.06$ m in one end of the room at $y = 0.06$ m and $x = L_x/2$. It can be observed that the reflection of the side walls and the ceiling produce destructive interference and it has been unable to create a plane wave traveling in the y direction notice that 75 Hz corresponds to the room mode (0 1 1) see Table 6. In the upper middle graph of Fig. 27 two simulated loudspeakers have been replaced instead at $y = 0.06$ m, $x = L_x/4$ and $x = L_x 3/4$ respectively and at $z = 0.06$ m on the floor with the same driven frequency of 75 Hz. One can observe that the interference caused by the side walls and both loudspeakers has attenuated the room mode corresponding to the x direction and a traveling wave along the y direction exists, still the attenuation caused by the standing wave corresponding to the z direction is present see lower middle graph in Fig. 27. That is alleviated by relocating the loudspeakers at a height of $z = L_z/2$ which can be seen in the upper and lower right graphs on Fig. 27. This configuration should ideally create a traveling plane wave in the y direction at all frequencies below the modal frequency 103 Hz (0 2 1) see Table 6.

In [9] it has been found that an approximation of the

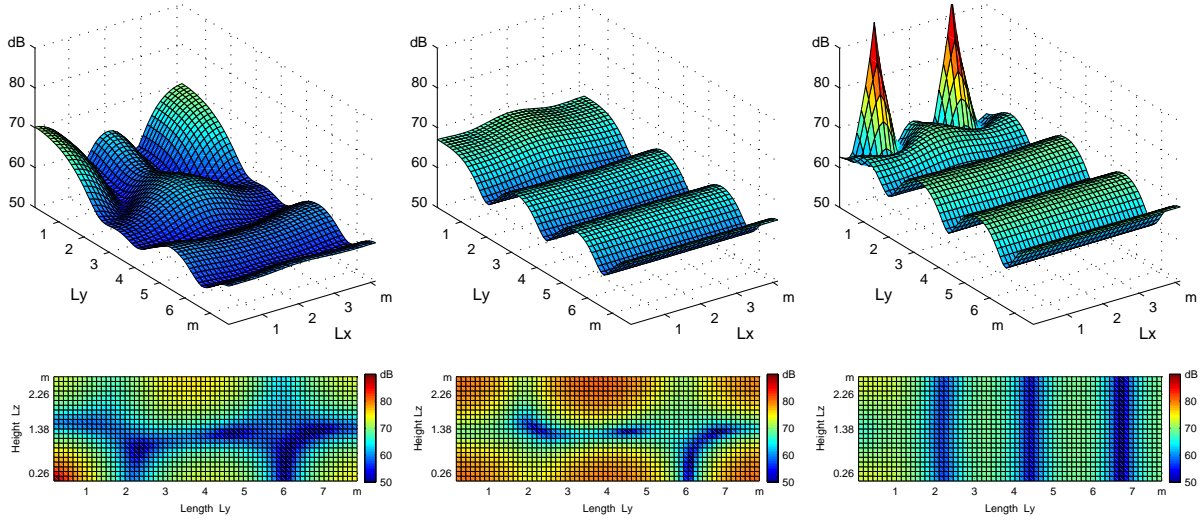

Fig. 27. Sound pressure level distribution resulting from the simulation of the Virtual Room, driven frequency 75 Hz. Upper left, setup .1.0 measured at a height of $z = 1.38$ m the loudspeaker is located at $z = 0.06$ m and $x = L_x/2$ and $y = 0.06$ m. Upper middle, setup .2.0 measured at a height of $z = 1.38$ m the loudspeakers are on the floor at $z = 0.06$ m and $x = L_x/4$ and $x = L_x/3/4$ respectively. Upper right, setup .2.0 measured at a height of $z = 1.38$ m the loudspeakers are at $z = 1.38$ m and $x = L_x/4$ and $x = L_x/3/4$ respectively. Lower plots are the same setups as upper plots but measured at the vertical plane $x = 2.10$ m in the Virtual Room, the driven frequency is the same as upper plots.

maximum frequency where it is possible to create a plane wave in a room is given by $f_{max} = c/d - \Delta_\varepsilon$ where c is the speed of sound and d is the distance in the x direction between two adjacent loudspeakers, and Δ_ε is a constant that depends on the damping of the room.

3.2. Removing the Reflection from the Back Wall

As room modes or modal resonances are caused by reflections the obvious way to reducing or removing these modes is to remove the reflection which has to be made in the time domain and it will ideally work for all frequencies. In order to create a traveling plane wave in the y direction the reflection of sound on the back wall has to be minimized. This is achieved by placing a number of extra loudspeakers $L = N$ in anti phase with the sound pressure at the back wall including a delay according to the traveling distance in the y direction.

In order to minimize the reflection of sound on the wall at $y = L_y$, the same number of loudspeakers should be used in each of the walls. In Fig. 30 an example of the cancellation of the reflection of the back wall is shown using the setup .2.2 in the Virtual Room as shown in Fig. 29 with the extra loudspeak-

ers in opposite phase and the appropriate delay according to the traveling distance from the front wall to the back wall.

The loudspeakers used in this simulation are the same as the example in Fig. 9 and Fig. 10 in Section 2. As it can be observed the front wave travels towards the back wall until it is canceled at the very end of the room by the back loudspeakers. Therefore the reflection of the back wall has been removed and from the time $t = 27$ ms to time $t = 100$ ms the sound pressure has been reduced significantly.

3.3. Controlled Acoustically Bass System (CABS)

In order to canceled out the reflection of the back wall a system called CABS .2.2 (Controlled Acoustically Bass System) is introduced. This system consists on the addition of extra loudspeakers to the .2.0 setup. This extra loudspeakers are fed with the same signal as the front loudspeakers N including a delay $\Delta t \approx L_y/c$ according to the traveling distance in the y direction of the plane wave, see Fig. 28. In addition to the delay the gain G of the extra loudspeakers has to be adjusted due to the attenuation of sound by the traveling distance and the damping characteristics of the room.

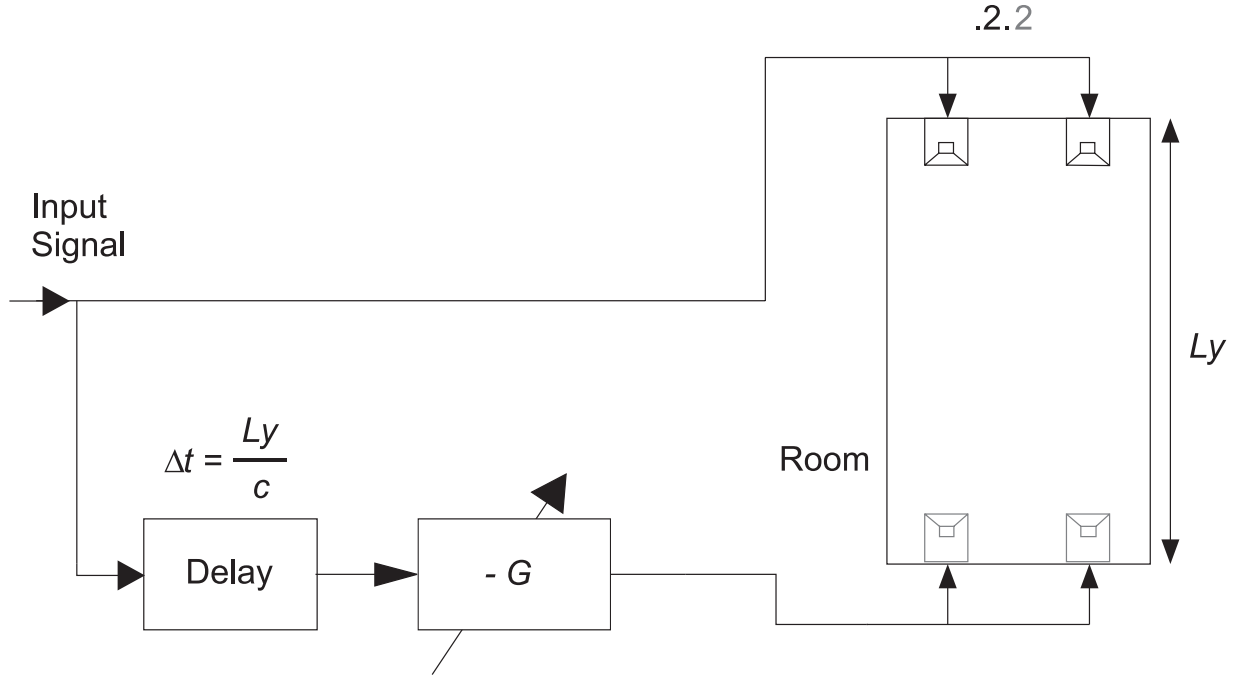

Fig. 28. Block diagram of equalization system to minimize the reflection of the back wall, G its a factor according to the damping characteristics of the room and the attenuation of sound by the air.

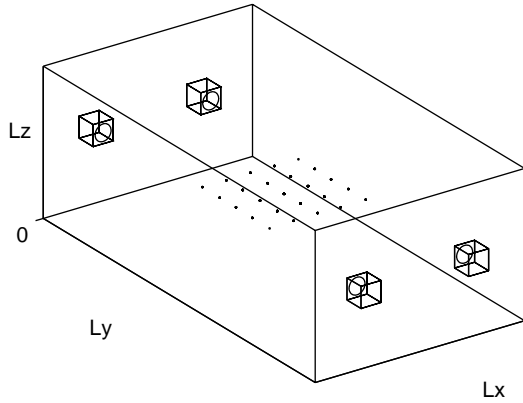

Fig. 29. Virtual Room model and loudspeaker setup .2.2 .

3.4. Simulation of CABS in the Virtual Room

The CABS .2.2 system (2 front and 2 back subwoofers) has been simulated in the Virtual Room to demonstrate the optimal performance on individual frequencies. The front loudspeakers .2.B are placed at $x = L_x/4$, $x = L_x 3/4$, $y = 0.06$ m and at $z = L_z/2$ and the back loudspeakers .F.2 are placed at $x = L_x/4$, $x = L_x 3/4$ respectively and at $y = 7.74$ m and $z = L_z/2$. The sound pressure distribu-

tion at a height $z = L_z/2$ is measured using 44 Hz, 55 Hz and 60 Hz as driven frequencies. In Fig. 31 the result of the CABS .2.2 system with the extra loudspeakers is presented. As it can be observed the back wall reflection has been removed and because a traveling wave in the y direction has been physically synthesized the sound field is even in almost all of the room and just very close to the loudspeakers a higher sound pressure level exists.

In order to verify the performance of CABS .2.2 the Cumulative Spectral Decay (CSD) is computed at one position and presented in Fig. 33 and the frequency response at the 25 positions in the listening area are presented in Fig. 34. By inspecting the CSD and the impulse responses after using CABS it is noticeable how the impulse responses have been shortened and the parameter D has reached 88.7%, this can be seen in Fig. 32. In addition the $MSFD$ is calculated and presented in Fig. 35. As shown a clear improvement has been achieved going from a SD of ± 4.9 dB in Fig. 18 to a SD of ± 0.7 dB. Nevertheless the MD still kept high, it improved from ± 14 dB to ± 11.8 dB. This can be attributed first to the frequency response of the loudspeaker and secondly to the amplification caused by the room itself at very low frequencies. As it can be observed in

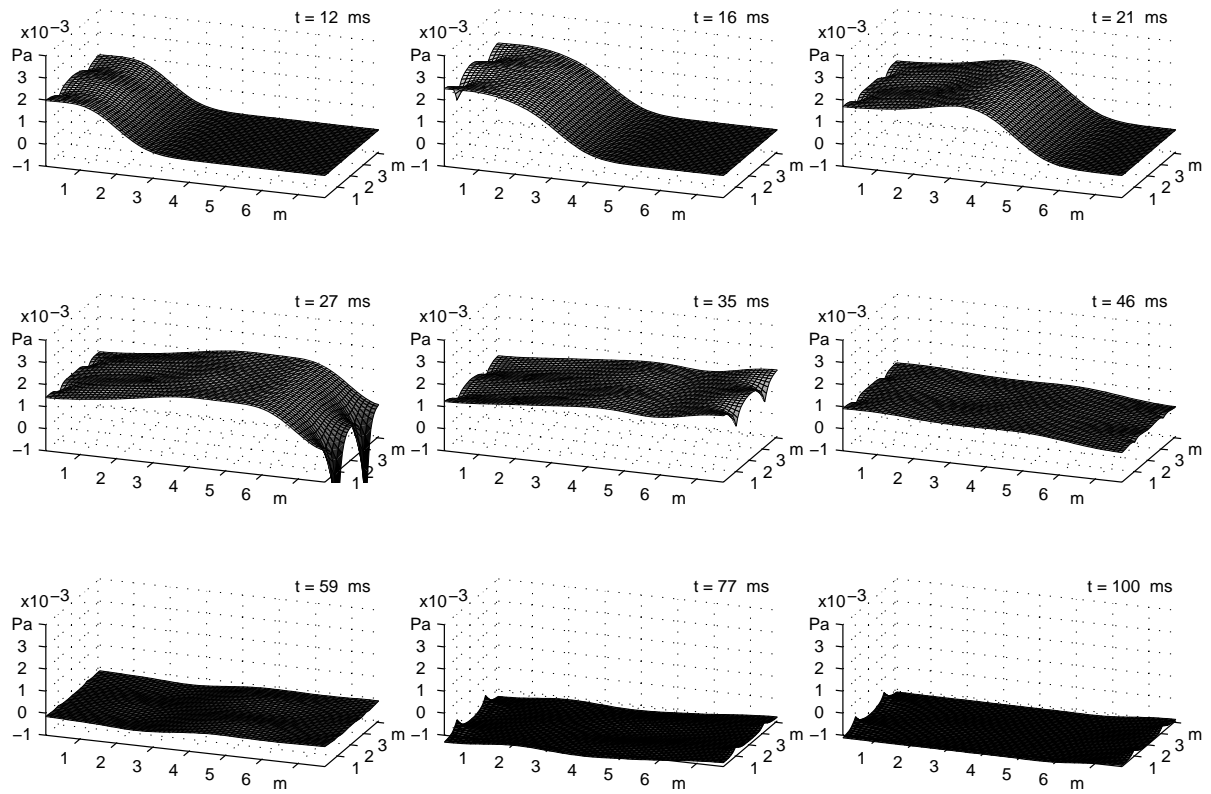

Fig. 30. Sequence of snap shots in the time domain of the instantaneous sound pressure in the Virtual Room removing the reflection from the back wall by adding the extra F.2 loudspeakers in anti phase with the sound at the wall and with the appropriate delay.

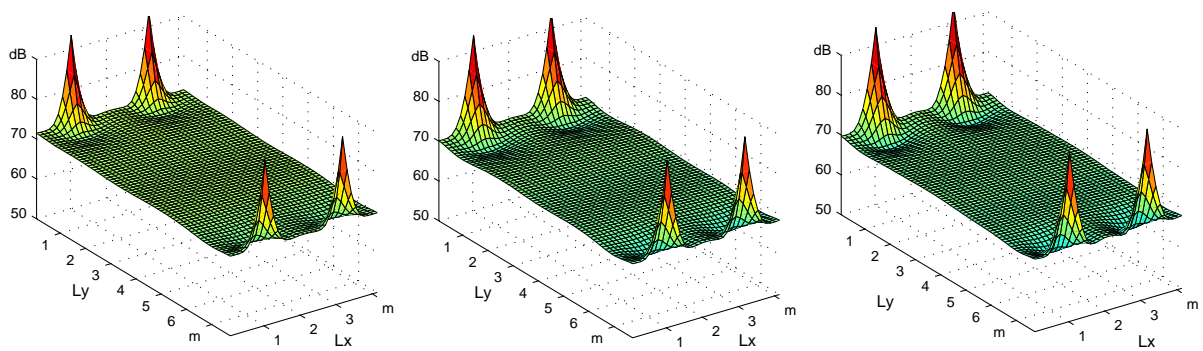

Fig. 31. Sound pressure level distribution resulting from the simulation of the Virtual Room measured on a plane at a height of $z = 1.38$ m after using CABS .2.2. Left produced by 44 Hz (modal frequency). Middle, produced by 55 Hz (anti modal frequency). Right, produced by 60 Hz.

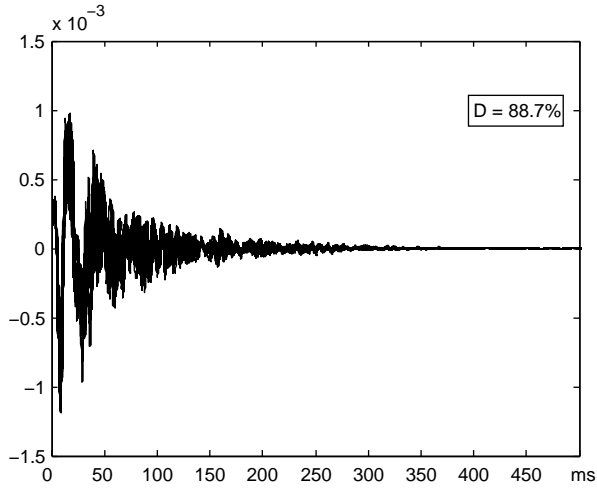

Fig. 32. The 25 impulse responses of the listening area in the Virtual Room after applying CABS .2.2. and the Definition D calculated.

Fig. 36 the $MSFD$ has been computed using just the transfer functions from both sound sources to the listening positions by deconvolving the loudspeaker response, then the MD improved by 4.2 dB. A slope of -20 dB/decade is observed which corresponds to a 1st order low pass response. This amplification is also shown in Fig. 14 and Fig. 18 with the loudspeaker setup .2.0 before applying CABS and it can be explained because of the reflections from floor and ceiling and the side walls at very low frequencies where the wavelength is much longer than the dimensions. In this situation the differences in phase are more or less always constructive so they only add positively to the direct sound. In Fig. 37 the $MSFD$ has been computed after been high pass filtered the transfer functions by a 1st order high pass filter with cut off frequency at 200 Hz. The MD is then ± 2 dB and the SD is kept the same in ± 0.7 dB.

In Figs. 40, 41, 38 and 39 results of the simulation of CABS .2.2 now positioned at a height $z = 0.66$ m from the floor are presented. As it can be observed the peaks from 124 Hz to 150 Hz have been attenuated corresponding to the reflections from the floor and ceiling, room modes ($n_y = 0$ $n_x = 0$ $n_z = 2$), ($n_y = 0$ $n_x = 2$ $n_z = 2$) and the combination with the reflections corresponding to the width of the room. An improvement is detected also in the parameter D been now of 95.9 % and in the MD moved just to ± 1.9 dB. To summarize the results of the simulated setups compared with CABS .2.2. are shown in Table 2.

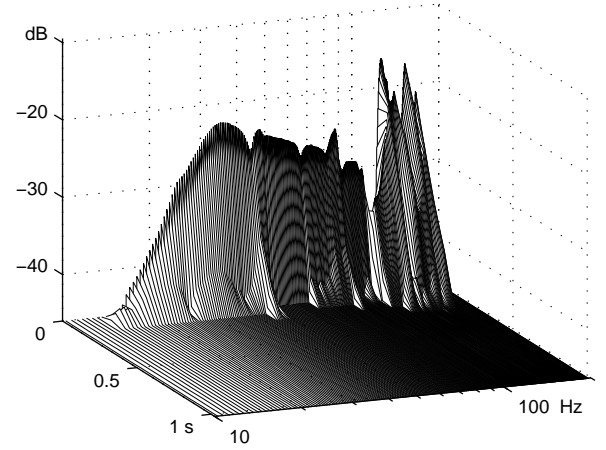

Fig. 33. Cumulative spectral decay (CSD) at the labeled 17 listening position in the Virtual Room after applying CABS .2.2 .

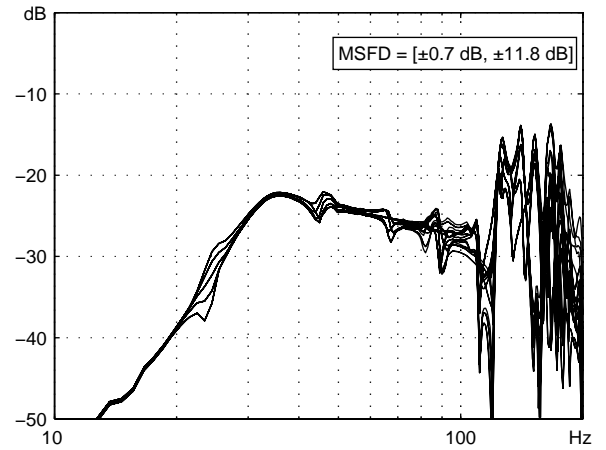

Fig. 34. Frequency responses of the 25 virtual microphone positions in the listening area of the Virtual Room after applying CABS .2.2 .

Table 2
Comparison of the results of simulation of CABS .2.2 at the listening area in the Virtual Room from 20 to 100 Hz.

	$MSFD$		$Definition$
	SD (dB)	MD (dB)	D
corner	.1.0 \pm 5.8	\pm 7.5	68.1 %
off corner	.1.0 \pm 5.9	\pm 7.2	58.9 %
	.2.0 \pm 4.9	\pm 6.6	56.4 %
$h = Lz/2$ CABS .2.2	\pm 0.7	\pm 2.0	88.7 %
$h \approx Lz/4$ CABS .2.2	\pm 0.7	\pm 1.9	95.9 %

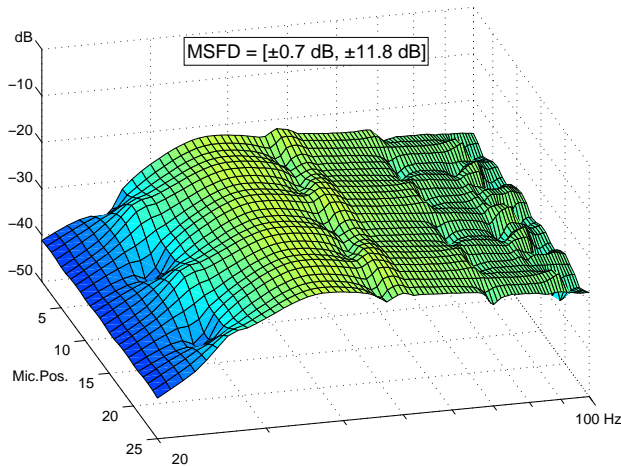

Fig. 35. Mean Sound Field Deviation (*MSFD*) at the listening area in the Virtual room after applying CABS .2.2 .

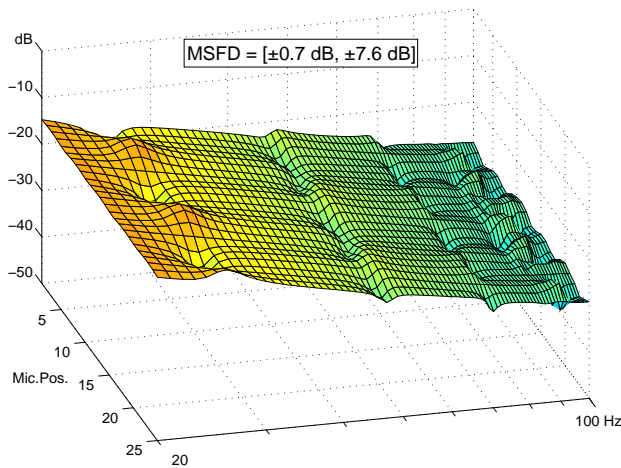

Fig. 36. Mean Sound Field Deviation (*MSFD*) of transfer functions at the listening area in the Virtual room after applying CABS .2.2. The loudspeaker has been deconvolved.

4. IMPLEMENTATION AND MEASUREMENT OF CABS IN REAL ROOMS

After simulating the CABS .2.2 system in a Virtual Room the system has been implemented in a PC using a real time signal processing software and an AD/DA multichannel converter. The parameters of the system were adjusted empirically to achieve best performance. First the system has been measured in the IEC Room at Aalborg University which is a standard listening room of approx. 90 m³ that fulfills the IEC 268-13 standard, which describes an average living room [20]. This room has been stud-

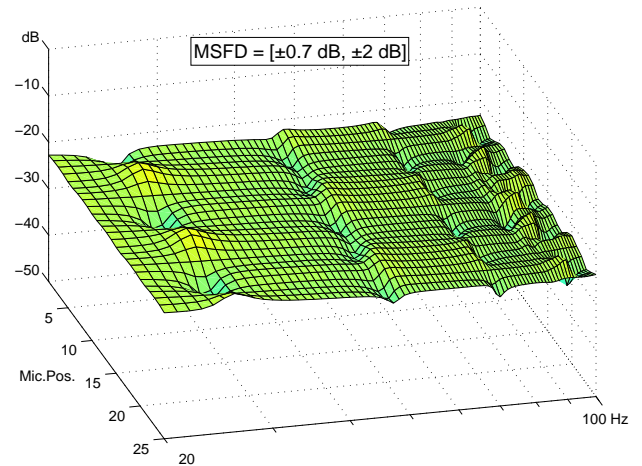

Fig. 37. Mean Sound Field Deviation (*MSFD*) of high pass filtered transfer functions at the listening area in the Virtual room after applying CABS .2.2. The loudspeaker response has been deconvolved.

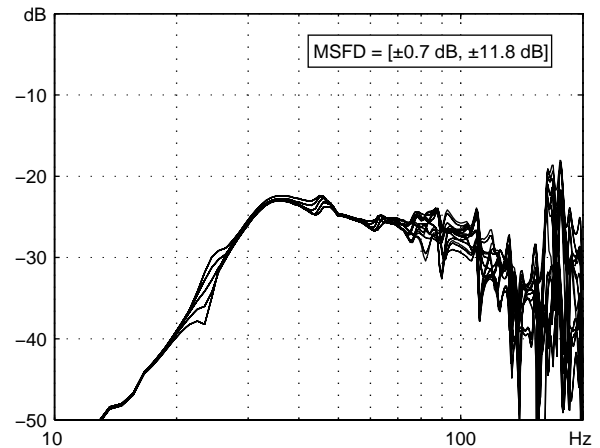

Fig. 38. Frequency responses of the 25 virtual microphone positions in the listening area of the Virtual Room after applying CABS .2.2 the loudspeakers are positioned at a height $z = 0.66$ m.

ied in [21] by Chereck and Langvad. The ceiling is a false ceiling tilted in the corners and covered with special plaster panels with three different sections of absorptive materials. The floor is wooden and the walls are brick made covered with plaster. The room has a double metal door in one of the side walls. Secondly the system has been measured in the ITU Room at Aalborg University which is a multichannel listening room of approx. 172 m³ that conforms to the recommendation ITU-R BS 775-1 for multichannel surround setups [22]. The walls of this room are quite damped except the back wall that has large windows that cover most of the wall. The ceiling

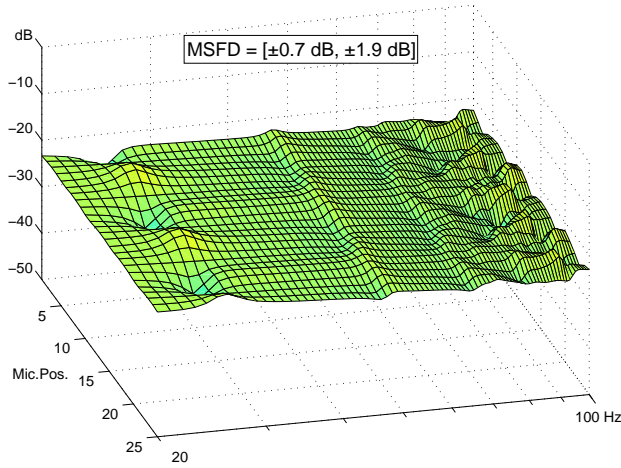

Fig. 39. Mean Sound Field Deviation (*MSFD*) of high pass filtered transfer functions at the listening area in the Virtual room after applying CABS .2.2 the loudspeakers are positioned at a height $z = 0.66$ m.

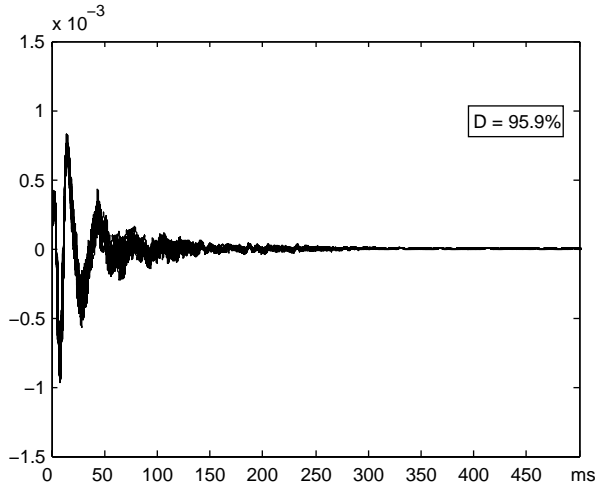

Fig. 40. The 25 impulse responses of the listening area in the Virtual Room after applying CABS .2.2. the loudspeakers are positioned at a height $z = 0.66$ m and the Definition D calculated.

is covered with special plaster panels. The floor is wooden and it has two metal doors placed symmetrically on the side walls. In Table 6 the first 25 room modes of both rooms are presented and in Table 5 the room dimensions and some room parameters such as reverberation time T_{60} and Schroeder frequency f_g are shown. The impulse responses were acquired by measurements using maximum length sequences (MLS) [23] of order $N = 14$ with a sampling frequency $f_s = 8$ kHz and processed by the discrete Fourier transform (DFT) in MATLAB. The loudspeakers employed were four ($35 \times 29 \times 35$ cm) close

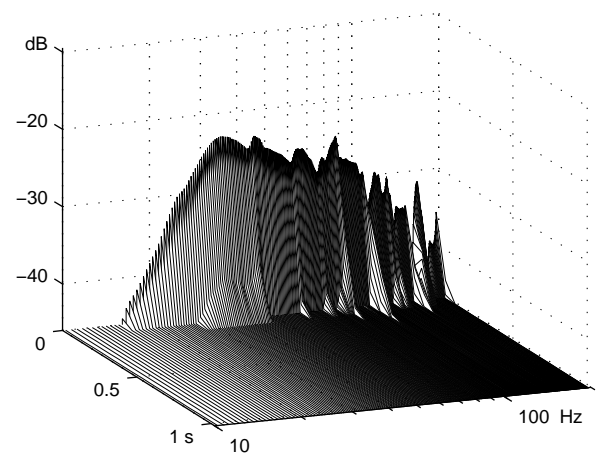

Fig. 41. Cumulative spectral decay (CSD) at the labeled 17 listening position in the Virtual Room after applying CABS .2.2 the loudspeakers are positioned at a height $z = 0.66$ m.

box type active loudspeakers with a 8 inch driver unit each.

In the IEC Room the sound field was measured at 1.26 m height with 25 microphone positions equally spaced by 48 cm within an area of (1.92×1.92 m) centered in the room. The loudspeakers of the setup .2.2 were placed at 1.50 m height and 6 cm from the front and back wall respectively. As illustrated in Section 3.1 the loudspeakers should be placed at 1.38 m height or at 0.69 m from the floor but because of the complexity of the ceiling this height (1.50 m) was assumed to be a better approximation of $L_z/2$ since the concrete ceiling is at $L_z = 3.10$ m in the room.

In the ITU Room the sound field was measured at 1.20 m height on 25 microphone positions equally spaced by 72 cm within an area of (2.88×2.88 m) centered in the room. The loudspeakers of setup .2.2 were placed at 1.44 m height and 9 cm from the front and back wall respectively.

5. RESULTS

Results of the measurements of CABS .2.2 in the two real rooms, the IEC Room and the ITU Room respectively are presented from Figs. 42 to 47. First in Fig. 42 and 43 the 25 impulse responses aligned in time before and after CABS are presented. In the IEC Room it is clear how the resonances are minimized by canceling the back reflection quite effec-

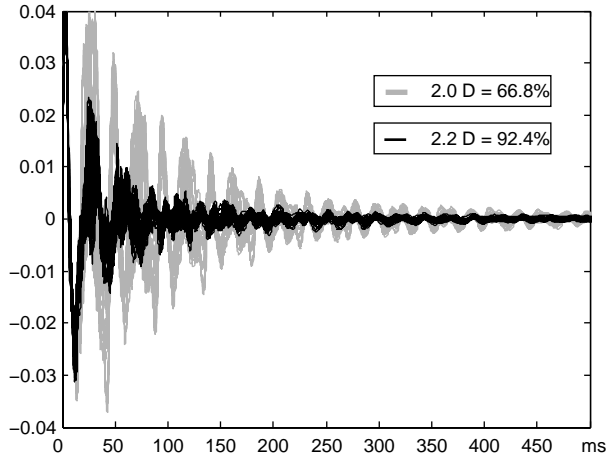

Fig. 42. The 25 impulse responses at the listening area resulting from measurements in the IEC Room and calculation of *Definition D*. Gray lines setup .2.0. Black lines after applying CABS .2.2 .

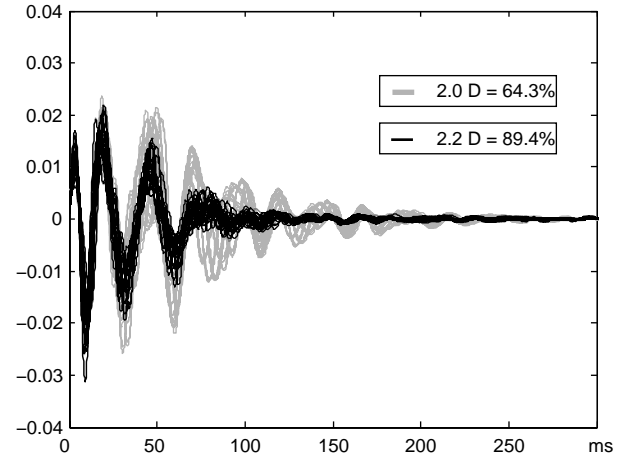

Fig. 43. The 25 impulse responses at the listening area resulting from measurements in the ITU Room and calculation of *Definition D*. Gray lines setup .2.0. Black lines after applying CABS .2.2 .

tively. This is expressed on the parameter *Definition D* that went from 66.8% to 92.4%. In the ITU Room is not readily seen as in the IEC Room because the reflections are not as strong as in the IEC Room but still there is an effective improvement going from a $D = 64.3\%$ to a $D=89.4\%$.

By observing Figs. 44 and 45 one can verify that the magnitude deviation improved drastically from 20 to 100 Hz being differences in magnitude from ± 15 dB to ± 6 dB, these deviations are fixed at the modal frequencies specially in the IEC Room. However the system performed better than the simulations at higher frequencies, one can notice that in the simulations on Fig. 34 from 100 Hz to 200 Hz the system did not correct for those peaks but in the real room those peaks were attenuated. This is attributed to wave dispersion errors inherent in the simulation method as the frequency increases, these small errors make the pure delay of the back loudspeakers inaccurate for those frequencies. Although in the ITU Room the CABS .2.2 did worse on frequencies from 90 Hz to 100 Hz the system performed generally better than in the IEC Room. This is because the ITU Room is a bigger room and the walls are quite damped already.

Concerning the spatial deviations the system improved from having a $SD = \pm 4.6$ dB to a $SD = \pm 1.6$ dB in the IEC Room and from a $SD = \pm 4.4$ dB to $SD = \pm 2$ dB in the ITU Room. Concerning the

spectral deviations the MD went from ± 7.7 dB to ± 4.1 dB in the IEC Room and from ± 6.5 dB to ± 4.5 dB in the ITU Room from 20 to 100 Hz in both rooms.

As explained in Section 3.4 the $MSFD$ on Figs. 46 and 47 has been calculated for both rooms by using the high pass filtered transfer functions at the listening area. This is done to observe just the improvement of the system and not the effect of the boost at very low frequencies neither the effect of the loudspeakers response. The result of this is shown in the spectral deviations that went from a $MD = \pm 6.4$ dB to a $MD = \pm 2.1$ dB in the $MSFD$ parameter for the IEC Room calculated from 20 to 100 Hz. As for the ITU Room the MD improved from ± 5.3 dB to ± 2.1 dB in the range from 20 Hz to 90 Hz.

The results of the $MSFD$, *Definition* and the improvements in dB in rooms IEC and ITU are presented on Tables 3 and 4 respectively. As it is clearly seen the IEC Room presents more problems than the ITU Room since the modal resonances are less overlapped than in the ITU Room. Nevertheless the CABS performed well up to 132 Hz in the IEC Room and in the ITU room the system performed well up to 87 Hz. It is remarkable that in both rooms the parameter *Definition* is close to anechoic response being 92.4 % in the IEC Room and 89.4 % in the ITU Room by using CABS.

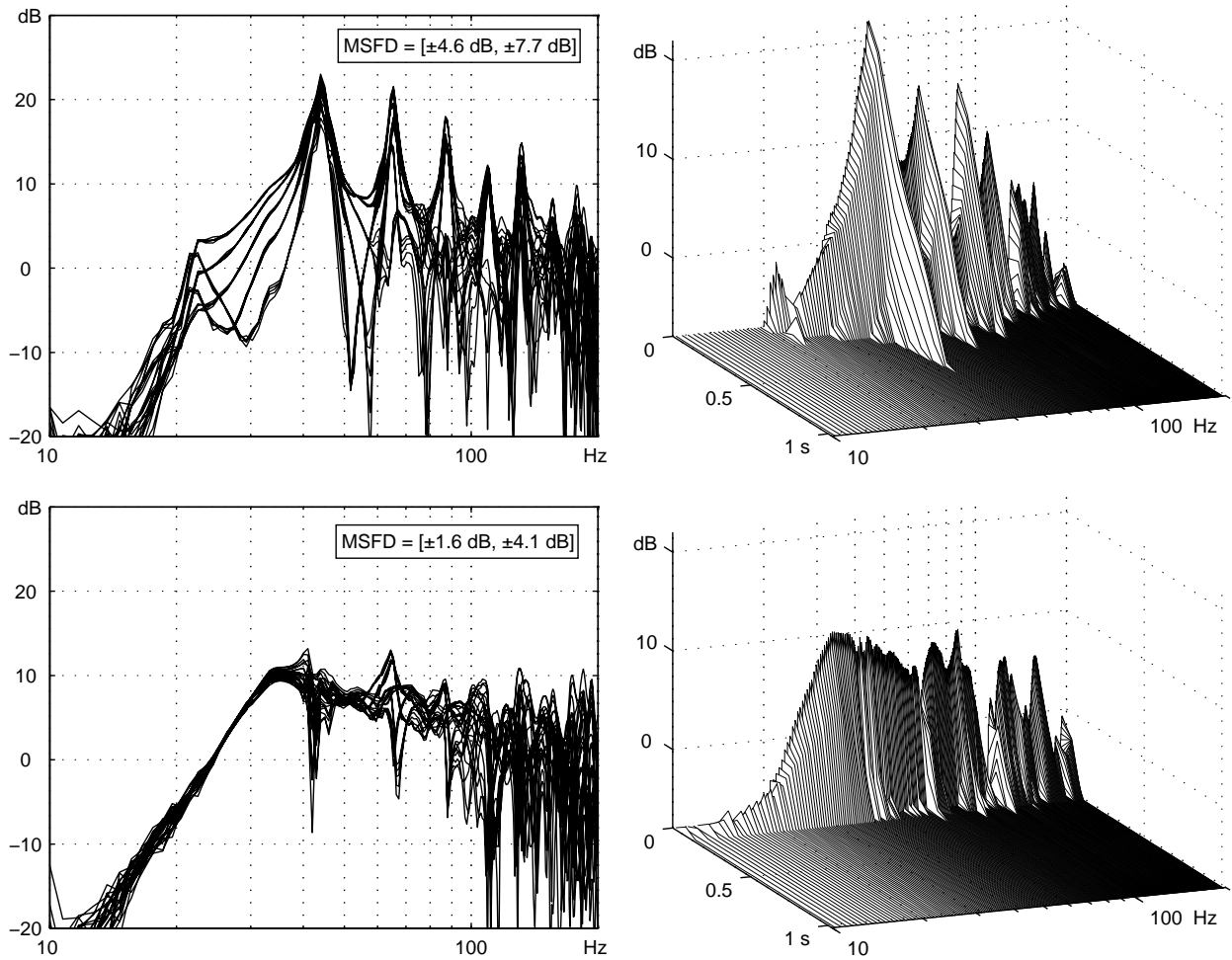

Fig. 44. Measurements in the IEC Room. Left column, frequency responses at the 25 positions (upper) setup .2.0 (lower) with CABS setup .2.2 . Right column, cumulative spectral decay (CSD) at position 17, (upper) setup .2.0 (lower) the same position with CABS .2.2 .

Table 3
Results of measurements and improvement of CABS .2.2 at the listening area in the IEC Room from 20 to 100 Hz.

	<i>MSFD</i>		<i>Definition</i>
IEC Room	<i>SD</i> (dB)	<i>MD</i> (dB)	<i>D</i>
.2.0	± 4.6	± 6.4	66.8 %
CABS .2.2	± 1.6	± 2.1	92.4 %
Improvement	6 dB	8.6 dB	25.6 %

6. DISCUSSIONS

As seen from the analysis in Section 2 when loudspeakers are placed in an enclosure a number of problems appear, magnitude deviations from ± 10 dB to ± 20 dB occur on the worse cases de-

pending on the size and damping of the room and the loudspeaker placement or listening position. The deviations in magnitude from one position to another varies at some frequencies from ± 6 dB to cases where there is almost not sound at all. By first creating a plane wave in only one direction of the room and secondly canceling that plane wave using loudspeakers delayed at the end wall in opposite phase with the traveling sound, optimal sound pressure level distribution in the room can be obtained.

The CABS is a system that works in the time domain and once it is adjusted it works independently of the program material that is reproduced. If the temperature changes drastically in the room the delay must be re-adjusted. As seen in the results CABS .2.2 worked fine in the IEC Room up to 100 Hz and

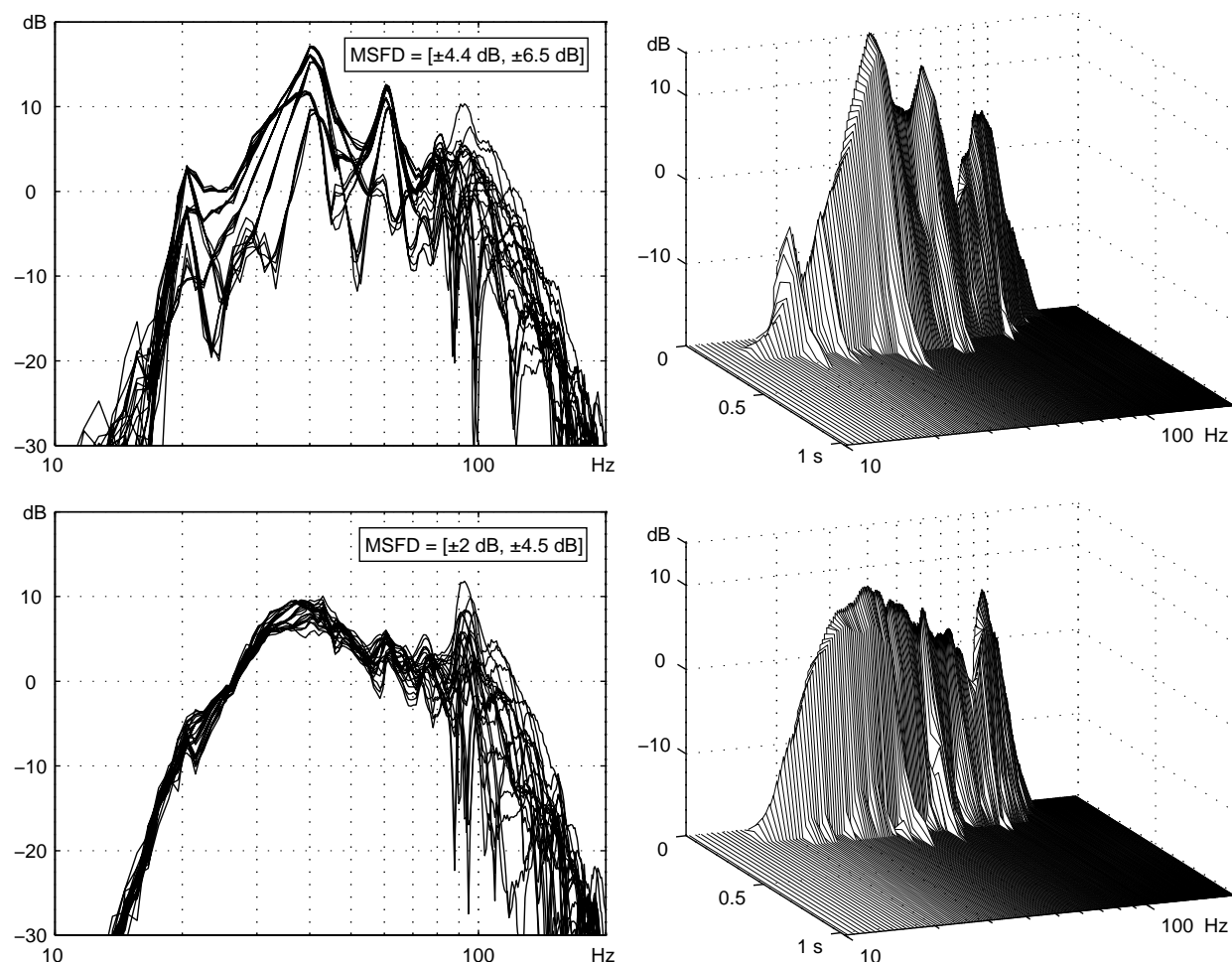

Fig. 45. Measurements in the ITU Room. Left column, frequency responses at the 25 positions (upper) setup .2.0 (lower) with CABS setup .2.2 . Right column, cumulative spectral decay (CSD) at position 17, (upper) setup .2.0 (lower) the same position with CABS .2.2 .

Table 4
Results of measurements and improvement of CABS .2.2 at the listening area in the ITU Room from 20 to 90 Hz.

	<i>MSFD</i>		<i>Definition</i>
ITU Room <i>SD</i> (dB)	<i>MD</i> (dB)		<i>D</i>
.2.0	± 4.2	± 5.3	64.3 %
CABS .2.2	± 1.3	± 2.1	89.4 %
Improvement	5.8 dB	6.4 dB	25.1 %

in the ITU Room up to 90 Hz. Indeed if the system is integrated to a full range reproduction system it must include a low pass filter to attenuate frequencies above these limits. Any how most subwoofers work within this range. In this paper the low pass filter was not included in the setup in order to know up to which frequency the system can work accept-

able. The working range of the subwoofer used was from 30 Hz to 150 Hz.

After having been simulated and measured the CABS .2.2 system for low frequencies can be said to perform well in both rooms improving both spectral deviations and spatial deviations. Generally it worked not only in the listening area but also in the whole room. The system presents some variations at the modal frequencies, this variations are due to asymmetries in the room and the complexity of the ceiling in the IEC Room for example, and in the ITU Room because of the different impedance of the front wall and back wall. Interestingly seen from the right waterfall plots in Figs. 44 and 45 the modal frequencies are much more noticeable in the IEC Room than in the ITU Room so the improve-

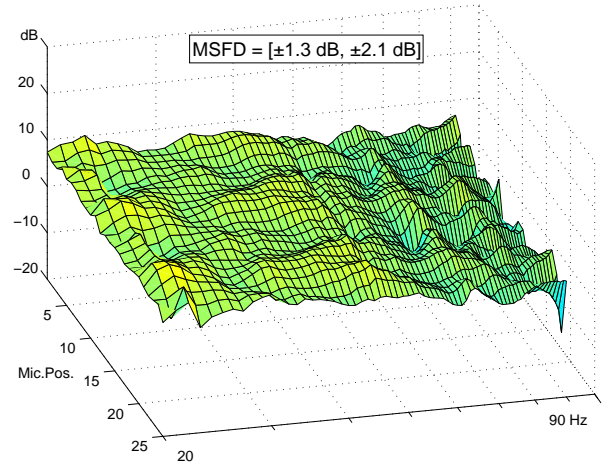
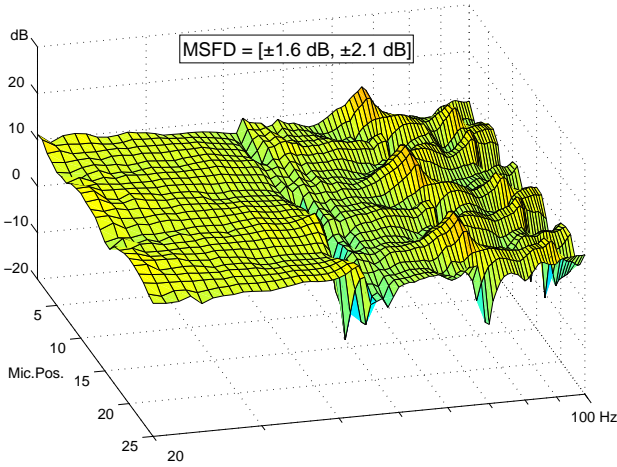
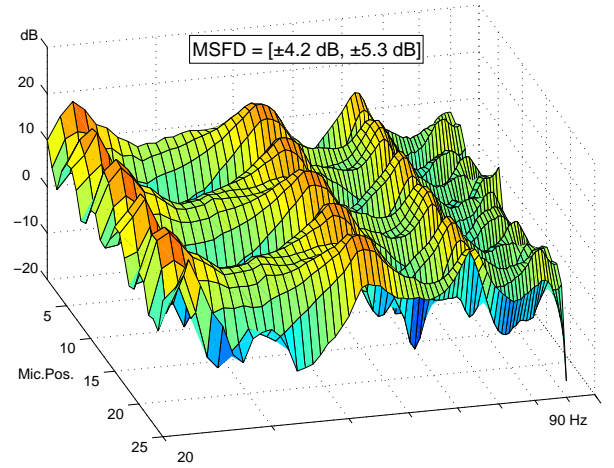
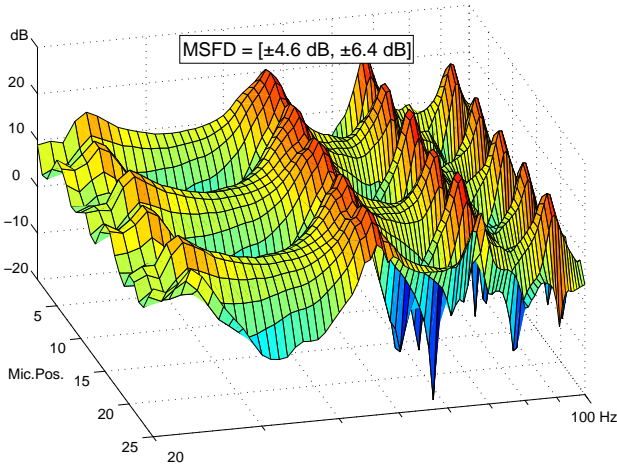

Fig. 46. Mean Sound Field Deviation (*MSFD*) of high pass filtered transfer functions at the listening area measured in the IEC Room. Upper setup .2.0. Lower after applying CABS .2.2. The loudspeaker response has been deconvolved.

Fig. 47. Mean Sound Field Deviation (*MSFD*) of high pass filtered transfer functions at the listening area measured in the ITU Room. Upper setup .2.0. Lower after applying CABS .2.2. The loudspeaker response has been deconvolved.

ment is best in the first room. In the ITU room instead the modal frequencies do not keep going in time as much as in the first room therefore the room modes in the ITU Room decay faster than in the IEC room in this case the improvement is not as obvious as in the IEC Room.

To summarize the system works depending on the size of the room, the smaller the room the more controllable the system will be. It can be said that if CABS .2.2 is well implemented it should work up to frequencies corresponding to the room modes ($n_y = 0$ $n_x = 2$ $n_z = 1$) or ($n_y = 0$ $n_x = 2$ $n_z = 2$) depending of the height where the loudspeakers are positioned and when this room modes are below the Schroeder frequency. Above this frequency as seen in Section 2 in small rooms the room modes become

more overlapped and the front waves are less plane. Moreover in bigger rooms this limit ($n_y = 0$ $n_x = 2$ $n_z = 1$) can be already over the Schroeder frequency. This frequency limit could be used as the crossover frequency if one wants to integrate the system with the full range loudspeakers. Although CABS .2.2 works fine with four loudspeakers within the typical subwoofer frequency range in small and middle size rooms. For wider rooms there may be needed more loudspeakers in the front wall and back wall for example on positions corresponding to the *nodes* of room mode ($n_y = 0$ $n_x = 4$ $n_z = 1$). To extend the frequency range in the IEC Room there may be needed more loudspeakers on positions corresponding to the *nodes* of mode ($n_y = 0$ $n_x = 2$ $n_z = 2$) being two loudspeakers at a height $L_z = L_z(1/4)$ and two at $L_z = L_z(3/4)$ or to the mode ($n_y = 0$

$nx = 3$ $nz = 2$) being three loudspeakers equally spaced along the width Lx at a height $Lz = Lz(1/4)$ and three more at a height $Lz = Lz(3/4)$.

A subject to discussion is if a complete flat response is wanted where the room is completely removed. As it was observed the fact that the front loudspeakers are at the very wall and the side reflections from floor and ceiling are used to built a plane wave by utilizing a restricted number of loudspeakers it implies that there is an amplification at very low frequencies that falls as the frequency increases. This slope was observed to be approx. 20 dB/decade in the case of the two rooms examined. The correction of this boost may depend on personal preference if it is necessary to correct for this amplification a 1st order high pass filter can be connected before CABS to compensate that boost. On the other hand this amplification may be an advantage for loudspeakers with poor power output at the low end frequency limit and also because we as humans are less sensitive at low frequencies.

The advantages of this system is that it works in the time domain and it could be adjusted parametrically to certain degree of enhancement depending on personal taste. One of the drawbacks of this approach is that extra loudspeakers and power amplifiers are needed although simple signal processing equipment has to be added in order to cancel the sound at the back wall. A further research can be addressed to investigate the amount of spectral deviations at low frequencies that are tolerable in terms of human preferences.

7. CONCLUSIONS

The analysis in time and frequency domains of sound fields at low frequencies produced by typical sound reproduction systems placed in rooms was presented. A simulation program based in FDTD has been utilized to render the sound field produced by low frequency loudspeakers in rectangular rooms.

A novel and effective method named Controlled Acoustically Bass System (CABS) to achieve optimum sound pressure level distribution inside a rectangular room at low frequencies has been introduced. The CABS .2.2 has been simulated and implemented in two standard listening rooms. The system utilizes two loudspeakers in the front wall

of the room to create a traveling plane wave and two extra low frequency loudspeakers in the back wall delayed and in opposite phase to remove the reflection of that wall giving a uniform sound field. After measurements of the implemented system in the two rooms one can conclude that the system works effectively in small and middle size rectangular rooms. The system can achieve good responses not only in a single listening position but also in the whole room from 20 Hz to 100 Hz having spatial deviations in a large listening area of only ± 1.3 dB in the ITU Room and ± 1.6 dB in the IEC Room, contrary to the advanced room correction systems that typically optimize to a single listening position. Informal listening with music signals integrating CABS with full range stereo loudspeakers has shown evident improvement by removing the booming sound which is always present in small or middle size rooms. It presents a clear front sound image to the listeners and the back loudspeakers were not heard at all. Since the system works in the time domain it works effectively with transient sounds as well as with long durations tones.

References

- [1] A. R. Groh, "High-Fidelity Sound System Equalization by Analysis of Standing Waves," *J. Audio Eng. Soc.*, vol. 22, pp. 795–799 (December 1974).
- [2] R. F. Allison, "The Sound Field in Home Listening Rooms II," *J. Audio Eng. Soc.*, vol. 24, pp. 14-19 (January/February 1976).
- [3] K. O. Ballagh, "Optimum Loudspeaker Placement Near Reflecting Planes," *J. Audio Eng. Soc.*, vol. 31, pp. 931–935 (1983 December).
- [4] T. Welte, "How Many Subwoofers are Enough," presented at the 112th Convention of the Audio Engineering Society, *J. Audio Eng. Soc. (Abstracts)*, vol. 50 p. 523 (June 2002), convention preprint 5602.
- [5] J. A. Pedersen, "Adjusting a loudspeaker to its acoustic environment," presented at the 115th Convention of the Audio Engineering Society, *J. Audio Eng. Soc. (Abstracts)*, vol. 51 p. 1223 (December 2003), convention preprint 5880.
- [6] A. Mäkivirta and P. Antsallo, "Modal Equalization of LoudspeakerRoom Responses at Low Frequencies," *J. Audio Eng. Soc.*, vol. 51, pp. 324–353. (May 2003)
- [7] S. J. Elliott and P. A. Nelson, "Multiple-Point Equalization in a Room Using Adaptive Digital Filters," *J. Audio Eng. Soc.*, vol. 37, pp. 899–907. (November 1989)

- [8] A. O. Santillán, C. S. Pedersen and M. Lydolf, “Experimental implementation of a low-frequency global sound equalization method based on free field propagation,” *Applied Acoustics*, in Press, accepted in (May 2006).
- [9] A. O. Santillán, “Spatially extended sound equalization in rectangular rooms,” *J. Acoust. Soc. Am.*, vol. 110, pp. 1989–1997. (October 2001)
- [10] A. Celestinos and S. B. Nielsen, “Optimizing placement and equalization of multiple low frequency loudspeakers in rooms,” presented at the 119th Convention of the Audio Engineering Society, *J. Audio Eng. Soc. (Abstracts)*, vol. 53 p. 1206 (December 2005), convention preprint 6545.
- [11] A. Celestinos and S. B. Nielsen, “Low frequency sound field enhancement system for rectangular rooms using multiple low frequency loudspeakers,” presented at the 120th Convention of the Audio Engineering Society, *J. Audio Eng. Soc. (Abstracts)*, vol. 54 p. 1206 (July/August 2006), convention preprint 6688.
- [12] A. Celestinos and S. B. Nielsen, “Multi-source low frequency room simulation using finite difference time domain approximations,” presented at the 117th Convention of the Audio Engineering Society, *J. Audio Eng. Soc. (Abstracts)*, vol. 53 pp. 105–106 (January/February 2005), convention preprint 6264.
- [13] L. E. Kinsler, *Fundamentals of Acoustics*, 4th. Ed. John Wiley & Sons, Inc. (2000)
- [14] H. Kuttruff, *Room Acoustics*, 3th. Ed. E & FN Spon. (1999)
- [15] T. Salava, “Acoustic Load and Transfer Functions in Rooms at Low Frequencies,” *J. Audio Eng. Soc.*, vol. 36, pp. 763–775 (October 1988)
- [16] J. D. Bunton and R. H. Small, “Cumulative Spectra, Tone Bursts and Applications,” *J. Audio Eng. Soc.*, vol. 30, pp. 386–395. (June 1982)
- [17] R. Thiele, “Richtungsverteilung und Zeitfolge der Schallrückwürfe in Räumen,” *Acustica*, vol. 3, pp. 291–302 (1953).
- [18] S.K. Mitra, *Digital Signal Processing A Computer Based Approach*, 1st Ed. McGraw-Hill, pp. 462–468 (1998).
- [19] L.B. Jackson, *Digital Filters and Signal Processing*, 3rd Ed. Kluwer Academic Publishers, pp. 301–307 (1996).
- [20] IEC 60268-13 BS.6840 13, “Sound System Equipment–Part13:Listening Tests on Loudspeakers,” International Electrotechnical Commission, Geneva, Switzerland, (1988).
- [21] B. Chereck and B. Langvad, “Low Frequency Simulation of a Listening Room,” *Proc. of Nordic Acoustical Meeting*, pp. 265–270. (1990)
- [22] ITU-R BS.775-1, “Multichannel stereophonic sound system with and without accompanying picture,” International Telecommunications Union, Geneva, Switzerland (1992–1994).
- [23] J. Vanderkooy, “Aspects of MLS Measuring Systems,” *J. Audio Eng. Soc.*, vol. 42, pp. 219–231. (April 1994)

Table 5

Room dimensions, T60, Schroeder frequency (f_g) and the room mode density below f_g and below 100Hz.

Room	LxWxH (m)	V (m ³)	T60 (s)	f_g (Hz)	N			
					$\overrightarrow{f_g}$	$\overrightarrow{100\text{Hz}}$	$\overrightarrow{f_g}$	$\overrightarrow{100\text{Hz}}$
IEC	7.80x4.12x2.78	89.34	0.47	145	49.72	20.13	0.81	0.45
ITU	8.12x7.39x2.88	172.82	0.31	85	23.20	34.60	0.65	0.84

Table 6

The first 25 room modes of IEC and ITU Rooms.

IEC Room		ITU Room	
$n_y n_x n_z$	f_n (Hz)	$n_y n_x n_z$	f_n (Hz)
1 0 0	22	1 0 0	21
0 1 0	41	0 1 0	23
2 0 0	44	1 1 0	31
1 1 0	47	2 0 0	42
2 1 0	61	0 2 0	46
0 0 1	63	2 1 0	48
3 0 0	66	1 2 0	51
1 0 1	66	0 0 1	60
0 1 1	75	2 2 0	63
2 0 1	77	1 0 1	63
3 1 0	78	3 0 0	64
1 1 1	78	0 1 1	64
0 2 0	82	1 1 1	67
1 2 0	85	3 1 0	68
2 1 1	87	0 3 0	70
4 0 0	88	1 3 0	73
3 0 1	91	2 0 1	73
2 2 0	93	0 2 1	76
4 1 0	97	2 1 1	77
3 1 1	100	1 2 1	78
0 2 1	103	3 2 0	79
3 2 0	105	2 3 0	82
1 2 1	105	4 0 0	85
4 0 1	108	3 0 1	87
5 0 0	110	2 2 1	87

Chapter E

CABS .2.2 In An Irregular Room

E.1 Low Frequency Sound Fields in An Irregular Room

Rooms with irregular shapes are more close to the typical listening environments where sound reproduction systems are utilized therefore it is of interest to simulate them. By using the Finite Differences in the Time Domain (FDTD) method basic room shapes can be simulated. The boundaries of the enclosure can be defined by the normal component of the particle velocity at the wall (see Appendix I). This is done by the calculation of the impedance at the boundary either using an estimate of the absorption coefficient or by the characteristic impedance of the wall. By using a staggered grid the room can be divided in two sections by setting the components of the particle velocity at the desired walls of the room.

E.1.1 Partitioning of the room

For example in the small enclosure seen from above in Figure E.4. The original room is partitioned by the walls A and B forming an “L” shape room. The wall A corresponds to the particle velocity points $u_{[0.6,0.7:1.1,z]}^x$ represented by small squares. The wall B corresponds to the particle velocity points $u_{[0.7:0.9,0,z]}^y$. Care should be taken in order to completely close the room hence the smaller section is isolated. All boundaries are treated the same manner as the regular rooms, first the original walls C, D, E and F are defined, and finally the boundaries A and B that close the room. The boundary equation for wall C is:

$$u_{[Lx,y,z]}^x\left(t + \frac{k}{2}\right) = \frac{\frac{\rho_0 h}{k} - Z}{\frac{\rho_0 h}{k} + Z} u_{[Lx,y,z]}^x\left(t - \frac{k}{2}\right) + \frac{2}{\frac{\rho_0 h}{k} + Z} p_{[Lx-\frac{h}{2},y,z]}(t), \quad (\text{E.1})$$

for wall D:

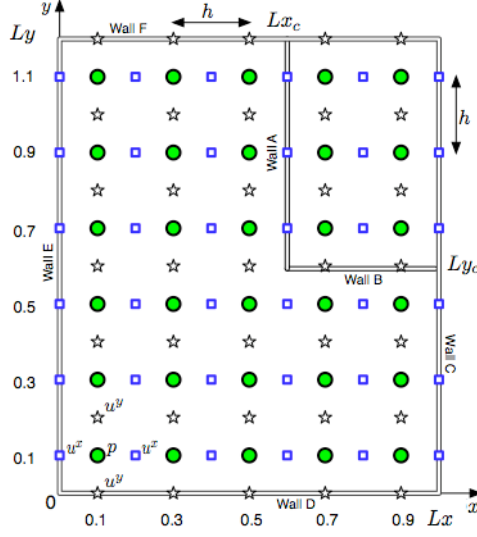

Figure E.4: Example of a calculation grid in a 1 m x 1.20 m irregular enclosure seen from above. The circles are the pressure p points, stars are particle velocity points u^y in the y direction and the squares are the particle velocity points u^x in the x direction.

$$u_{[x,0,z]}^x\left(t + \frac{k}{2}\right) = \frac{\frac{\rho_0 h}{k} - Z}{\frac{\rho_0 h}{k} + Z} u_{[x,0,z]}^x\left(t - \frac{k}{2}\right) + \frac{2}{\frac{\rho_0 h}{k} + Z} p_{[x,0+\frac{h}{2},z]}(t), \quad (\text{E.2})$$

for wall E:

$$u_{[0,y,z]}^x\left(t + \frac{k}{2}\right) = \frac{\frac{\rho_0 h}{k} - Z}{\frac{\rho_0 h}{k} + Z} u_{[0,y,z]}^x\left(t - \frac{k}{2}\right) - \frac{2}{\frac{\rho_0 h}{k} + Z} p_{[0+\frac{h}{2},y,z]}(t), \quad (\text{E.3})$$

for wall F:

$$u_{[x,Ly,z]}^x\left(t + \frac{k}{2}\right) = \frac{\frac{\rho_0 h}{k} - Z}{\frac{\rho_0 h}{k} + Z} u_{[x,Ly,z]}^x\left(t - \frac{k}{2}\right) + \frac{2}{\frac{\rho_0 h}{k} + Z} p_{[x,Ly-\frac{h}{2},z]}(t). \quad (\text{E.4})$$

The boundary equation for wall A is as follows:

$$\begin{aligned}
 u_{[Lx_c, Ly_c: Ly, z]}^x(t + \frac{k}{2}) &= \frac{\frac{\rho_0 h}{k} - Z}{\frac{\rho_0 h}{k} + Z} u_{[Lx_c, Ly_c: Ly, z]}^x(t - \frac{k}{2}) \\
 &+ \frac{2}{\frac{\rho_0 h}{k} + Z} p_{[Lx_c - \frac{h}{2}, Ly_c: Ly, z]}(t),
 \end{aligned}
 \tag{E.5}$$

and for wall B is written as

$$\begin{aligned}
 u_{[Lx_c: Lx, Ly_c, z]}^x(t + \frac{k}{2}) &= \frac{\frac{\rho_0 h}{k} - Z}{\frac{\rho_0 h}{k} + Z} u_{[Lx_c: Lx, Ly_c, z]}^x(t - \frac{k}{2}) \\
 &+ \frac{2}{\frac{\rho_0 h}{k} + Z} p_{[Lx_c: Lx, Ly_c - \frac{h}{2}, z]}(t).
 \end{aligned}
 \tag{E.6}$$

E.1.2 Simulation of loudspeakers in an irregular room

The irregular room shown in Figure E.5 of dimensions $Lx=7.08\text{m}, Ly=7.8\text{m}, Lz=2.76\text{m}$ and $Lx_c=2.88\text{m}, Ly_c=4.5\text{m}$ has been simulated. The estimated absorption coefficient used for the walls an floor was 0.12 and 0.13 and 0.15 for the ceiling. The loudspeakers are modeled as $(12 \times 12 \times 12)$ cm cubic sound sources.

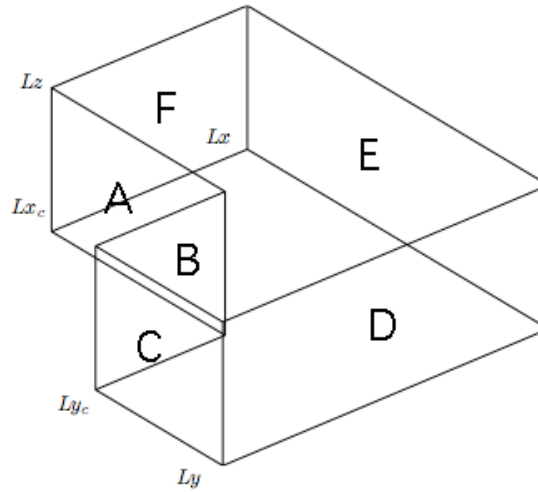

Figure E.5: Irregular room model

On this room shape one can expect that the predominant resonance frequencies would be the ones related to the length Ly , width $Lx - Lx_c$ and Lx but also the frequency which wavelength relates to the pad $Ly + Lx$. This would depend on where the loudspeakers are placed in the room. By having the loudspeakers equidistantly spaced at the front wall F they will construct a plane wave traveling along the room towards wall D but at the abrupt

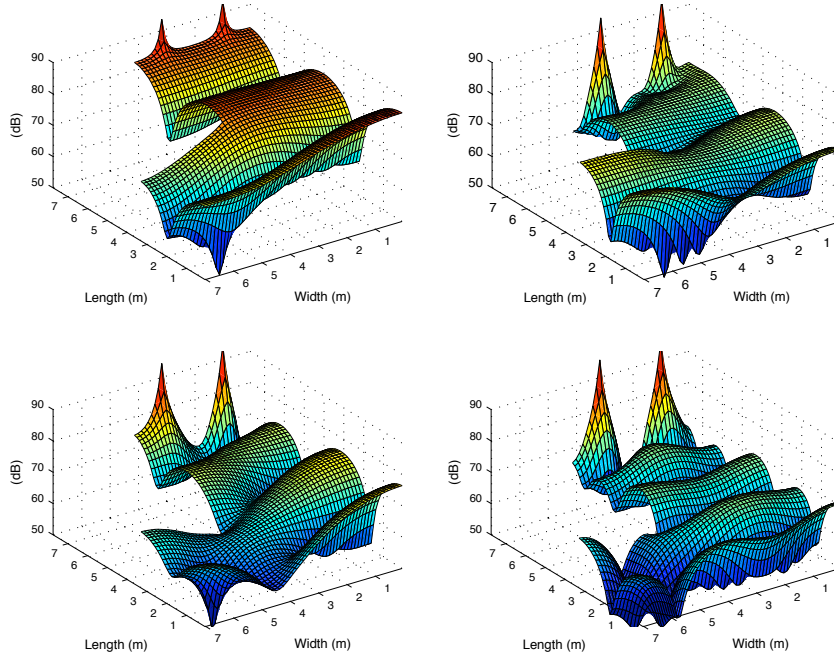

Figure E.6: Sound pressure level distribution calculated at a height of 1.38 m in the irregular room. Upper left driven frequency 44. Upper right 55 Hz. Lower left 60 Hz. Lower right 80Hz.

corner formed by wall A and B the front wave would diffract itself forming a curved edge towards the wall C. The main front wave will reflect to wall D with less amplitude on one side due to the diffraction caused by the corner and then it will come back towards wall F. The diffracted edge of the front wave will hit wall C and reflect towards wall E and so on. These will be the main pads that will construct the patterns of the sound pressure level distribution along the room. On Figure E.6 the results of the calculated sound pressure level distribution in the irregular room are presented with 44Hz, 55Hz, 60Hz and 80Hz as driven frequencies to both loudspeakers. As it can be observed the structures of the sound level distribution are some how bended and not so regular along the width of the room due to the diffracted wave reflected to wall C.

Three setups (A,B and C) are simulated in the irregular room with two common scenarios each. First a typical subwoofer (.1.0) on the floor near one corner and secondly two loudspeakers (2.0.0 or .2.0) as in a stereo setup both producing the same signal. In setups A and B these loudspeakers are separated from the wall about 1.4 m and 1 m respectively, and in the setup C the loudspeakers are placed at the wall. In all cases the sound field has been sampled on a listening area of 1.92 m \times 1.92 m situated at a listening height of $z = 1.38\text{m}$, delimited by 25 virtual microphones equally spaced by 48 cm. The results of

the simulations are presented in the following sections. The *MSFD* has been calculated as explained in **Paper D** Section 2.4.

Setup A

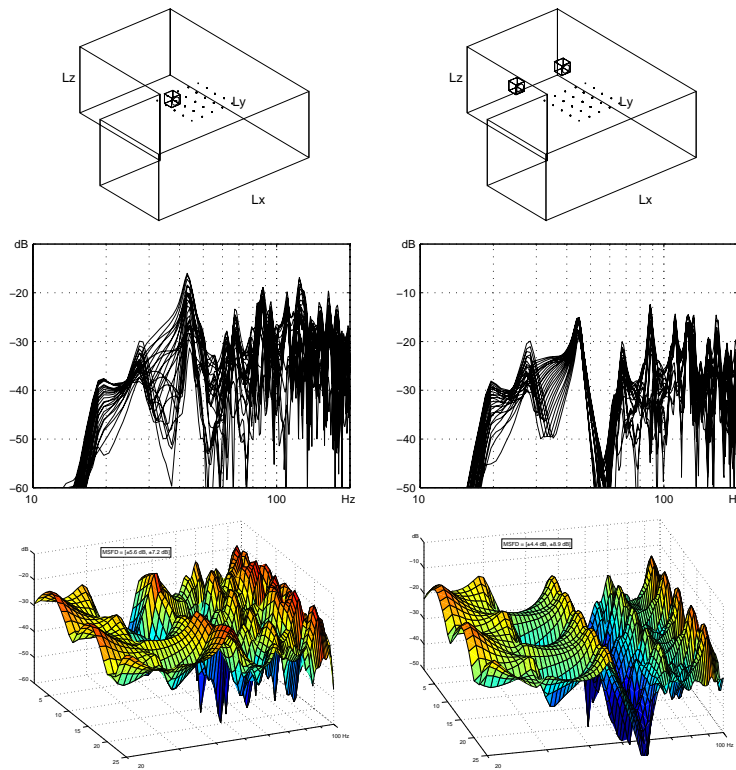

Figure E.7: Left column, Setup A .1.0 . Right column, Setup A 2.0.0 . Upper row, room model and loudspeakers. Middle row, 25 frequency responses at the listening area. Lower row, Mean Sound Field Deviation.

Setup B

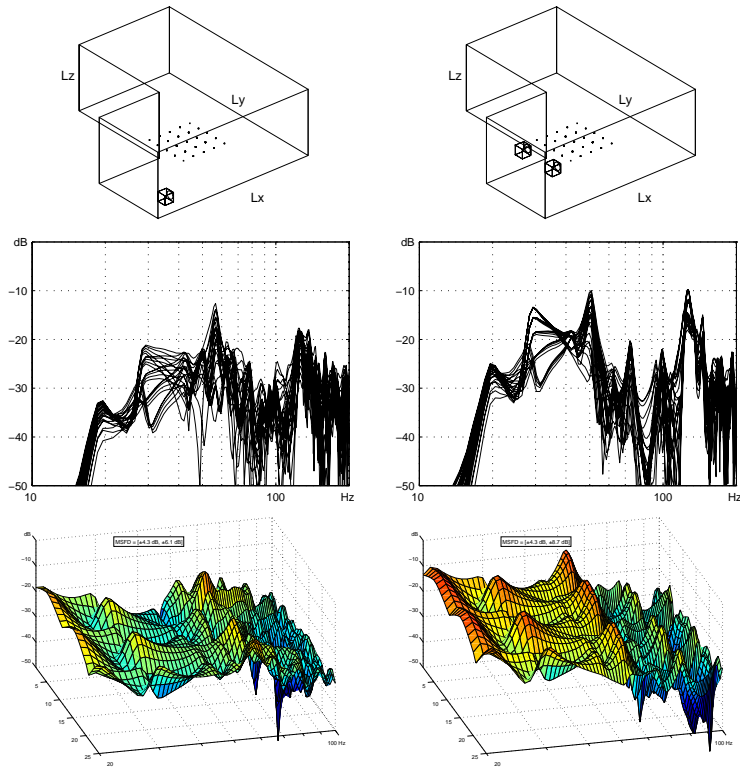

Figure E.8: Left column, Setup B .1.0 . Right column, Setup B 2.0.0 . Upper row, room model and loudspeakers. Middle row, 25 frequency responses at the listening area. Lower row, Mean Sound Field Deviation.

Setup C

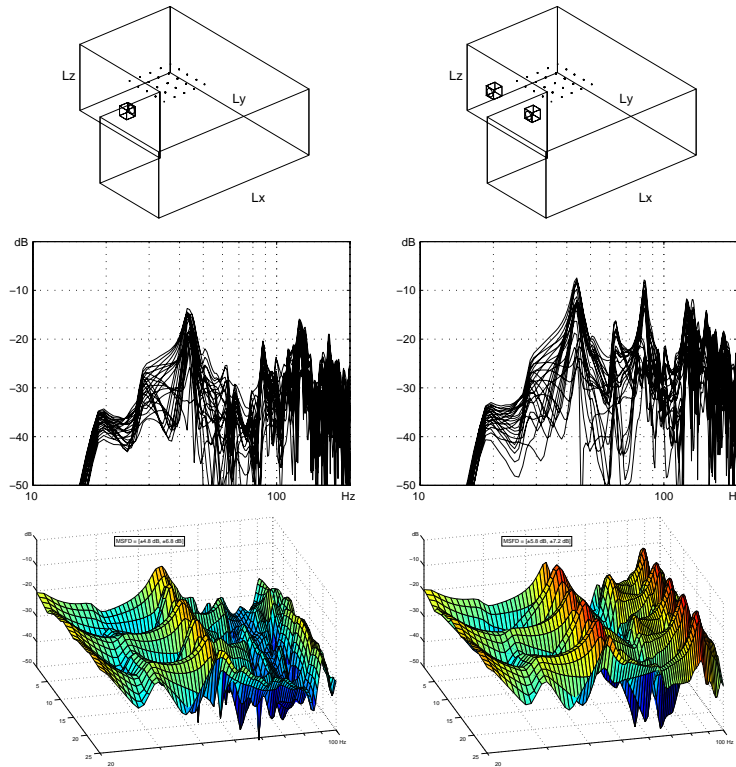

Figure E.9: Left column, Setup C .1.0 . Right column, Setup C .2.0 . Upper row, room model and loudspeakers. Middle row, 25 frequency responses at the listening area. Lower row, Mean Sound Field Deviation.

E.2 Simulation of CABS .2.2 in the Irregular Room

As mention early in this work the optimal placement of the loudspeakers in the room is of great importance for the performance of CABS. This to suppress as much as possible the room modes caused by the side walls, floor and ceiling and with the action of CABS have only propagating plane waves traveling in one direction. Now it is interesting to know how CABS would perform in an irregular room where the conditions are not as optimal as in a perfect rectangular room. In Figure E.10 the result of simulations of CABS .2.2 is presented using the .2.0 loudspeakers at wall F and the rear loudspeakers .0.2 at wall D. As it can be observed the reflection from the rear wall has not been completely removed. At 44Hz the reflection of the diffracted wave from walls C and part of wall D had disturbed

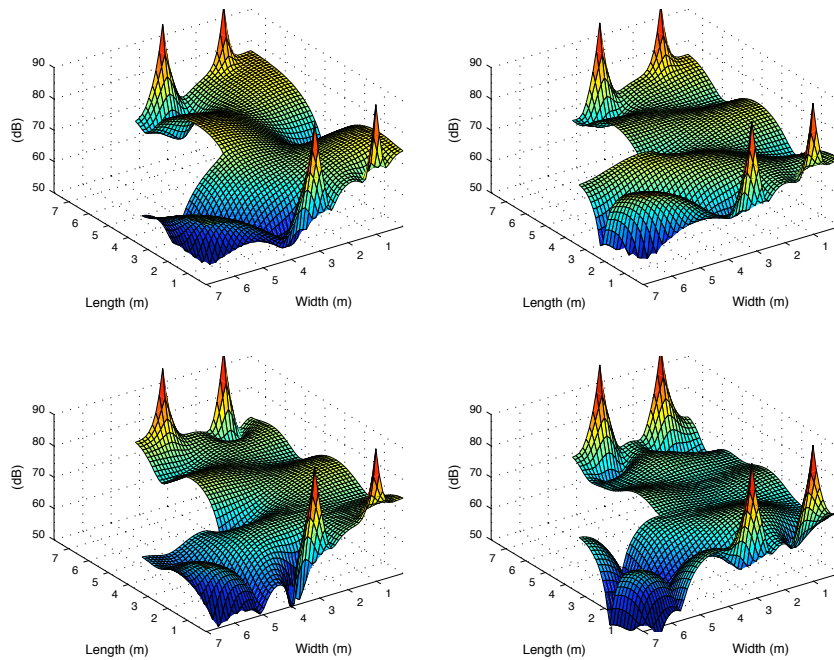

Figure E.10: Sound pressure level distribution calculated at a height of 1.38 m using CABS .2.2 in the irregular room. Upper left driven frequency 44Hz. Upper right 55 Hz. Lower left 60 Hz. Lower right 80 Hz.

the pressure distribution at the listening area. Nevertheless the sound pressure level distribution is more even than by using just the 2.0 loudspeakers. One would suggest that the position of the rear loudspeakers might be optimized as well as the individual gain and delay of the rear loudspeakers to cancel as much as possible the reflection of the back wall.

To know how the performance of CABS .2.2 differs from the optimal condition the system has been simulated as it was originally implemented with the same gain and delay in both rear loudspeakers on the three scenarios A B C presented in Section E.1.2. Results of the simulations are shown in Figures E.11 and E.12.

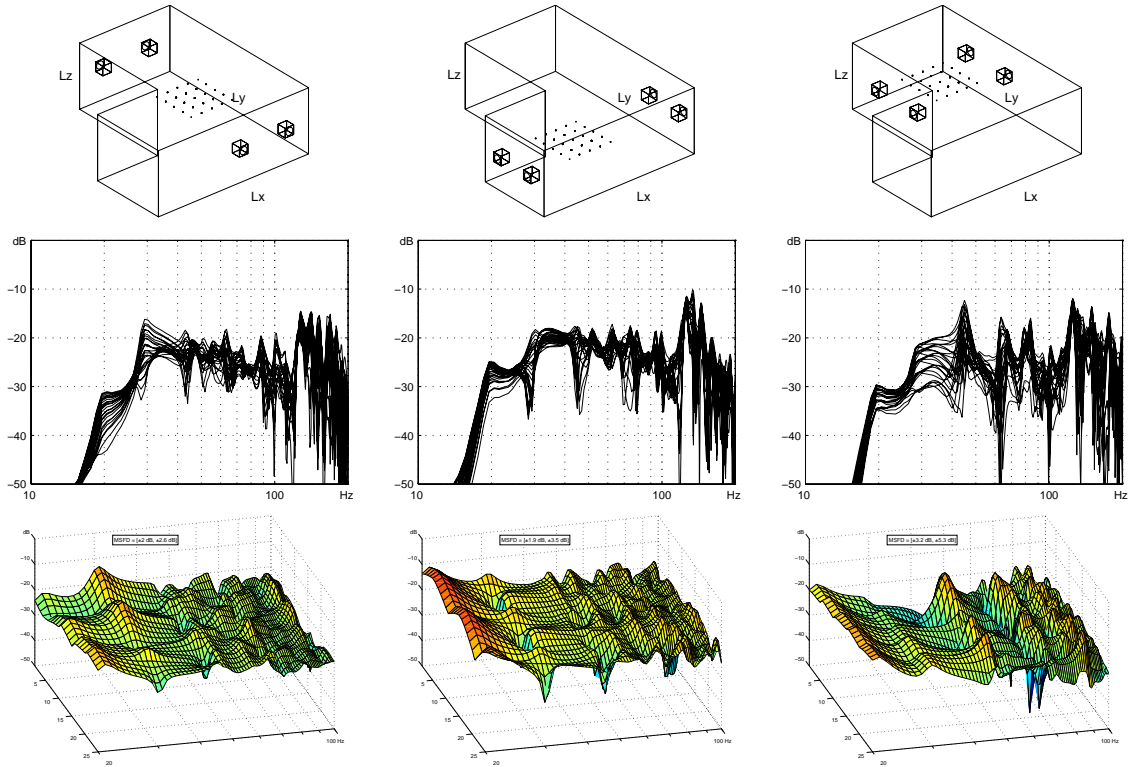

Figure E.11: Left column, CABS .2.2 in Setup A. Middle column, CABS .2.2 in Setup B. Right column, CABS .2.2 in Setup B. Upper row, room model and loudspeakers. Middle row, 25 frequency responses at the listening area. Lower row, Mean Sound Field Deviation.

E.3 Summary and Conclusions

In this chapter the simulation model using the FDTD method of an irregular room has been presented. Simulations of different setups of low frequency loudspeakers in the virtual irregular room have been computed. The setup that had the worse spatial deviation was Setup C .2.0 having a $SD = \pm 5.8$ dB and the setup with the worse magnitude deviation was Setup A 2.0.0 with $MD = \pm 8.4$ dB. The setup that had slightly better performance was Setup B .1.0 with one subwoofer having spatial deviations of $SD = \pm 4.3$ dB and magnitude deviations of $MD = \pm 6.1$ dB.

The performance of CABS .2.2 was affected by the irregular shape of the room mainly because of the abrupt corner that breaks the front wave diffracting it towards not only the back wall but also to other walls of the room. Nevertheless CABS .2.2 improved the spatial and magnitude deviations having less magnitude deviations in Setup A and less spatial deviations in Setup B. In general it was observed that the symmetrical place of the rear loudspeakers was not necessary the best placement. The deviations at frequencies in

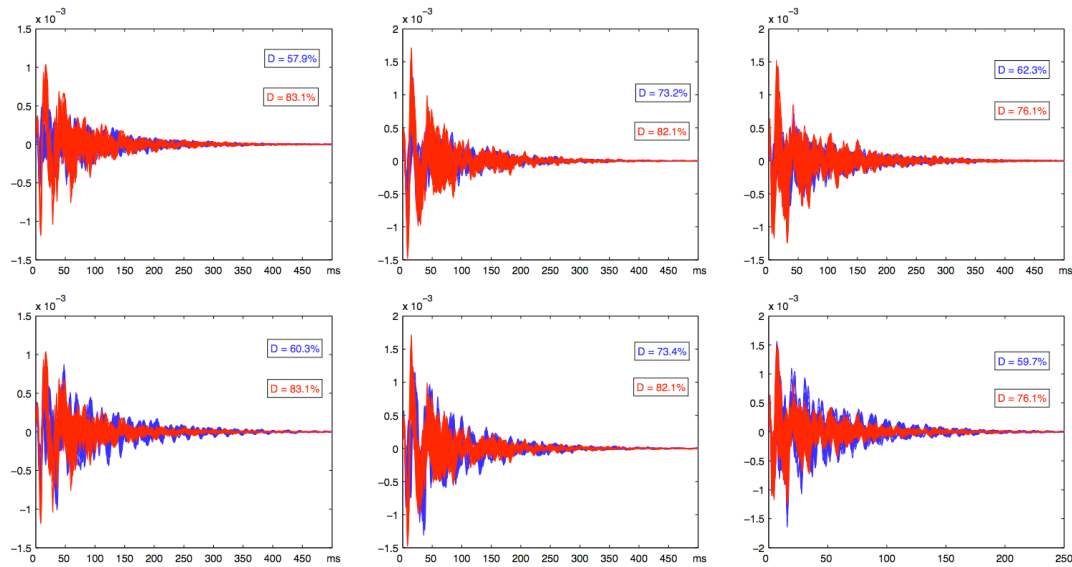

Figure E.12: Comparison between configurations 0.1.0 , 2.0.0 , 0.2.0 (Blue curves) and CABS .2.2 (Red curves). The figure shows the impulse responses curves at the listening area and the computed “Deutlichkeit” number. Left column Setup A. Middle column Setup B. Right column Setup C.

the range of 20 to 50 Hz suggests that the amplitude and the delay to each of the rear loudspeakers need to be slightly different. In setups A and B it seems that CABS .2.2 was able to suppress the back wall reflection but not the diffracted waves by the corner and the reflection of the side wall C. In Setup C the reflection of the rear wall is suppressed but the curved edge of the front wave produced by the front loudspeakers would travel towards wall D and C and come back to wall F forming a standing wave around 44 Hz. The precise adjustment of CABS .2.2 (delay and gain) and optimal placement of the loudspeakers on this kind of rooms may be a subject for future investigations. It would be also interesting to test CABS .2.2 in real irregular rooms including furniture since only simulations have been carried out.

Bibliography

- [1] AESTD1001.0.01-05. *Multichannel surround sound systems and operations*. Audio Engineering Society, Technical Council, New York, NY, 2001.
- [2] R. F. Allison. The sound field in home listening rooms ii. *J. Audio Eng. Soc.*, 24: 14–19, 1976.
- [3] K. O. Ballagh. Optimum loudspeaker placement near reflecting planes. *J. Audio Eng. Soc.*, 31:931–935, 1983.
- [4] J. Blauert. *Spatial Hearing: The Psychophysics of Human Sound Localization*. MIT Press, 1997.
- [5] R. H. Bolt. Normal modes of vibration in room acoustics: Angular distribution theory. *J. Acoust. Soc. Am.*, 11:74–79, 1939.
- [6] M. M. Boone, E. Verheijen, and P. V. Tol. Spatial sound-field reproduction by wave-field synthesis. *J. Audio Eng. Soc.*, 43:1003–1012, 1995.
- [7] D. Botteldooren. Finite-difference time-domain simulation of low-frequency room acoustic problems. *J. Acoust. Soc. Am.*, 98(6):3302–3308, 1995.
- [8] IEC 60268–13 BS.6840 13. *Sound System Equipment–Part13:Listening Tests on Loudspeakers*. International Electrotechnical Commission, Geneva, Switzerland, 1988.
- [9] ITU–R BS.775–1. *Multichannel stereophonic sound system with and without accompanying picture*. Rec., International Telecommunications Union, Geneva, Switzerland, 1994.
- [10] S. J. Elliott and D. Wilson. Practical implementation of low-frequency equalization using adaptive digital filters. *J. Audio Eng. Soc.*, 42:988–998, 1994.
- [11] A. R. Groh. High-fidelity sound system equalization by analysis of standing waves. *J. Audio Eng. Soc.*, 22:795–799, 1974.
- [12] L. Kinsler, A. Frey, A. Coppens, and J. Sanders. *Fundamentals of Acoustics*. John Wiley & Sons, Inc., NY, 2000.

-
- [13] K. S. Kunz and R. J. Luebbers. *Finite Difference Time Domain Method for Electromagnetics*. CRC Press LLC, N W, FL, 1993.
- [14] H. Kuttruff. *Room Acoustics*. 3th. Ed. E & FN Spon., London, NY, 1999.
- [15] A. Mäkivirta, P. Antsaló, M. Karjalainen, and V. Välimäki. Modal equalization of loudspeakerroom responses at low frequencies. *J. Audio Eng. Soc.*, 51:324–353, 2003.
- [16] H. Møller. Reproduction of artificial-head recordings through loudspeakers. *J. Audio Eng. Soc.*, 43:30–33, 1989.
- [17] P. Morse and K. Ingard. *Theoretical Acoustics*. McGraw–Hill, NY, 1968.
- [18] S. K. Olesen. Low frequency room simulation using finite difference equations. In *102nd Audio Eng. Soc. Conv.*, 1997. preprint 4422.
- [19] J. A. Pedersen. Adjusting a loudspeaker to its acoustic environment. In *115th Audio Eng. Soc. Conv.*, 2003. preprint 5880.
- [20] T. Salava. Acoustic load and transfer functions in rooms at low frequencies. *J. Audio Eng. Soc.*, 36:763–775, 1988.
- [21] A. O. Santillán, C. Pedersen, and M. Lydolf. Experimental implementation of a low-frequency global sound equalization method based on free field propagation. *Applied Acoustics*, 2006. to be published.
- [22] L. Savioja and V. Valimäki. Reducing the dispersion error in the digital waveguide mesh using interpolation and frequency-warping techniques. *IEEE Trans. Speech Audio Processing*, 8:184–194, 2000.
- [23] L. Savioja, J. Backman, A. Jarvinen, and T. Takala. Waveguide mesh method for low-frequency simulation of room acoustics, 1995.
- [24] U. P. Svensson and U. R. Kristiansen. Computational modelling and simulation of acoustic spaces. In *Proc. of AES 22nd International Conference on Virtual, Synthetic and Entertainment Audio*, 2002. paper 266.
- [25] R. Thiele. Richtungsverteilung und zeitfolge der schallrückwürfe in räumen. *Acustica*, 3:291–302, 1953.
- [26] T. Welti and A. Devantier. Low-frequency optimization using multiple subwoofers. *J. Audio Eng. Soc.*, 54:347–364, 2006.
- [27] F. L. Wightman and D. J. Kistler. The dominant role of low–frequency interaural time differences in sound localization. *J. Acoust. Soc. Am.*, 91:1649–1661, 1992.

I

Appendix I

I.1 Sound Field Room Simulator

In this Appendix a detailed description of the room simulation program is presented. First the analytical description of the finite-difference time-domain (FDTD) method is derived, second the technical implementation is outlined and finally the description of the graphical user interface (GUI) is presented.

I.1.1 Discretization of the wave equation

Typically the FDTD method utilizes two coupled first order differential equations, in acoustics this equations are the simple force linear Euler's equation where the pressure p and the particle velocity u are related as

$$\nabla p = -\rho_0 \frac{\partial \vec{u}}{\partial t} \quad (\text{I.7})$$

where ρ_0 is the density of the transmission media in kg/m^3 . The second equation is the linear continuity equation

$$\nabla \cdot \vec{u} = -\frac{1}{c^2 \rho_0} \frac{\partial p}{\partial t} \quad (\text{I.8})$$

where c is the wave propagation speed in the media¹². Since the acoustic pressure ∇p and the particle velocity $\nabla \cdot \vec{u}$ can be expressed as

$$\nabla p = \hat{x} \frac{\partial p}{\partial x} + \hat{y} \frac{\partial p}{\partial y} + \hat{z} \frac{\partial p}{\partial z} \quad (\text{I.9})$$

and

$$\nabla \cdot \vec{u} = \frac{\partial u^x}{\partial x} + \frac{\partial u^y}{\partial y} + \frac{\partial u^z}{\partial z} \quad (\text{I.10})$$

the equations (I.7) and (I.8) can be rewritten as

$$\hat{x} \frac{\partial p}{\partial x} + \hat{y} \frac{\partial p}{\partial y} + \hat{z} \frac{\partial p}{\partial z} = -\rho_0 \frac{\partial \vec{u}}{\partial t} \quad (\text{I.11})$$

$$\frac{\partial u^x}{\partial x} + \frac{\partial u^y}{\partial y} + \frac{\partial u^z}{\partial z} = -\frac{1}{c^2 \rho_0} \frac{\partial p}{\partial t} \quad (\text{I.12})$$

then from (5) Eq. (I.7) yields to

$$\frac{\partial u^x}{\partial t} + \frac{\partial u^y}{\partial t} + \frac{\partial u^z}{\partial t} = -\frac{1}{\rho_0} \left[\hat{x} \frac{\partial p}{\partial x} + \hat{y} \frac{\partial p}{\partial y} + \hat{z} \frac{\partial p}{\partial z} \right] \quad (\text{I.13})$$

and from (6) Eq. (I.8) yields to

$$\frac{\partial p}{\partial t} = -c^2 \rho_0 \left[\frac{\partial u^x}{\partial x} + \frac{\partial u^y}{\partial y} + \frac{\partial u^z}{\partial z} \right]. \quad (\text{I.14})$$

After the derivation and linearization in the time domain both equations are sampled in time and space using the sampling rates $\frac{1}{k}$ Hz and $\frac{1}{h} m^{-1}$. From Eq.(7) the resulting set of equations for the components of the particle velocity are written as

$$\begin{aligned} u_{x+\frac{h}{2},y,z}^x(t+\frac{k}{2}) &= u_{x+\frac{h}{2},y,z}^x(t-\frac{k}{2}) - \frac{k}{h\rho_0} \times [p_{x+h,y,z}(t) - p_{x,y,z}(t)], \\ u_{x,y+\frac{h}{2},z}^y(t+\frac{k}{2}) &= u_{x,y+\frac{h}{2},z}^y(t-\frac{k}{2}) - \frac{k}{h\rho_0} \times [p_{x,y+h,z}(t) - p_{x,y,z}(t)], \\ u_{x,y,z+\frac{h}{2}}^z(t+\frac{k}{2}) &= u_{x,y,z+\frac{h}{2}}^z(t-\frac{k}{2}) - \frac{k}{h\rho_0} \times [p_{x,y,z+h}(t) - p_{x,y,z}(t)], \end{aligned} \quad (\text{I.15})$$

and from Eq. (8) the acoustical pressure is derived with

$$\begin{aligned}
p_{x,y,z}(t+k) = p_{x,y,z}(t) &- \frac{c^2 \rho_0 k}{h} \left[u_{x+\frac{h}{2},y,z}^x(t+\frac{k}{2}) - u_{x-\frac{h}{2},y,z}^x(t+\frac{k}{2}) \right] \\
&- \frac{c^2 \rho_0 k}{h} \left[u_{x,y+\frac{h}{2},z}^y(t+\frac{k}{2}) - u_{x,y-\frac{h}{2},z}^y(t+\frac{k}{2}) \right] \\
&- \frac{c^2 \rho_0 k}{h} \left[u_{x,y,z+\frac{h}{2}}^z(t+\frac{k}{2}) - u_{x,y,z-\frac{h}{2}}^z(t+\frac{k}{2}) \right]
\end{aligned} \tag{I.16}$$

where the acoustical pressure is determined at the grid points $(x\delta x, y\delta y, z\delta z)$ at time $t = \delta t$ and $\delta x = \delta y = \delta z = h$ that is the spatial discretization step and $\delta t = k$ that is the time step.

In Eq. (I.15) The three components of the particle velocity are determined at times $t = (t + \frac{1}{2})k$ and positions

$$u_{(x\pm\frac{h}{2},yh,zh)}^x, \quad u_{(xh,y\pm\frac{h}{2},zh)}^y, \quad u_{(xh,yh,z\pm\frac{h}{2})}^z. \tag{I.17}$$

I.1.2 Boundary conditions

Assuming the following enclosure of volume $V = L_x L_y L_z$

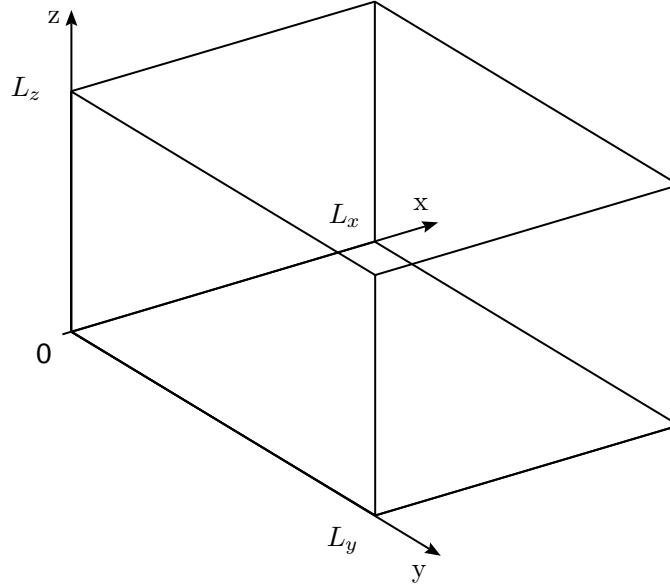

the boundaries of the enclosure are defined by the components of the particle velocity at positions

$$\begin{array}{ll}
 u_{[0,y,z]}^x & u_{[L_x,y,z]}^x \\
 u_{[x,0,z]}^y & u_{[x,L_y,z]}^y \\
 u_{[x,y,0]}^z & u_{[x,y,L_z]}^z
 \end{array} \quad (\text{I.18})$$

and from the set of equations (I.15) in the x direction the equation

$$u_{x+\frac{h}{2},y,z}^x(t + \frac{k}{2}) = u_{x+\frac{h}{2},y,z}^x(t - \frac{k}{2}) - \frac{k}{h\rho_0} \times [p_{x+h,y,z}(t) - p_{x,y,z}(t)], \quad (\text{I.19})$$

for the wall at $[L_x, y, z]$ can be rewritten as

$$u_{[L_x, y, z]}^x(t + \frac{k}{2}) = u_{[L_x, y, z]}^x(t - \frac{k}{2}) - \frac{k}{h\rho_0} \times [p_{[L_x + \frac{h}{2}, y, z]}(t) - p_{[L_x - \frac{h}{2}, y, z]}(t)], \quad (\text{I.20})$$

but since the term $p_{[L_x + \frac{h}{2}, y, z]}(t)$ is unknown the asymmetric finite-difference approximation for the space derivative can be introduced⁷

$$p_{[L_x + \frac{h}{2}, y, z]}(t) - p_{[L_x - \frac{h}{2}, y, z]}(t) \approx 2 [p_{[L_x, y, z]}(t) - p_{[L_x - \frac{h}{2}, y, z]}(t)] \quad (\text{I.21})$$

and substituted in (I.20) yields to

$$u_{[L_x, y, z]}^x(t + \frac{k}{2}) = u_{[L_x, y, z]}^x(t - \frac{k}{2}) - 2 \frac{k}{h\rho_0} \times [p_{[L_x, y, z]}(t) - p_{[L_x - \frac{h}{2}, y, z]}(t)]. \quad (\text{I.22})$$

To simplify the simulation model the complex part of the impedance of the wall has been neglected. The acoustic pressure at the wall can be expressed by the product of the component of the particle velocity u^x at the wall and the characteristic impedance of the wall

$$p_{[L_x, y, z]}(t) = Z u_{[L_x, y, z]}^x(t) \quad (\text{I.23})$$

where the impedance is expressed as

$$Z = \rho_0 c \frac{1 + \sqrt{1 - \alpha}}{1 - \sqrt{1 - \alpha}} \quad (\text{I.24})$$

and α is the absorption coefficient of the wall. Replacing $Z u_{[L_x, y, z]}^x(t)$ from (I.23) in (I.22) yields to

$$u_{[L_x, y, z]}^x(t + \frac{k}{2}) = u_{[L_x, y, z]}^x(t - \frac{k}{2}) - 2 \frac{k}{h\rho_0} \times [Z u_{[L_x, y, z]}^x(t) - p_{[L_x - \frac{h}{2}, y, z]}(t)]. \quad (\text{I.25})$$

The term $u_{[Lx,y,z]}^x(t)$ can be approximated by the first order (symmetric) estimation of the first derivative of a function¹⁸

$$u_{[Lx,y,z]}^x(t) \approx \frac{u_{[Lx,y,z]}^x(t + \frac{k}{2}) + u_{[Lx,y,z]}^x(t - \frac{k}{2})}{2}. \quad (\text{I.26})$$

Inserting the right term of (I.26) in (I.25) yields to

$$\begin{aligned} u_{[Lx,y,z]}^x(t + \frac{k}{2}) &= u_{[Lx,y,z]}^x(t - \frac{k}{2}) \\ &- 2 \frac{k}{h\rho_0} \times \left[Z \left(\frac{u_{[Lx,y,z]}^x(t + \frac{k}{2}) + u_{[Lx,y,z]}^x(t - \frac{k}{2})}{2} \right) - p_{[Lx - \frac{h}{2}, y, z]}(t) \right]. \end{aligned} \quad (\text{I.27})$$

After re-arranging terms and simplification, the component of the particle velocity in the x direction at the boundary becomes

$$u_{[Lx,y,z]}^x(t + \frac{k}{2}) = \frac{\frac{\rho_0 h}{k} - Z}{\frac{\rho_0 h}{k} + Z} u_{[Lx,y,z]}^x(t - \frac{k}{2}) - \frac{2}{\frac{\rho_0 h}{k} + Z} p_{[Lx - \frac{h}{2}, y, z]}(t). \quad (\text{I.28})$$

Since Eq.(I.20) assumes that the particle velocity has a positive sign going outwards from a lower index to a higher index thus the appropriate change in sign in Eq.(I.28) has to be done. Then the equations for the boundaries at $x = 0$ and $x = Lx$ are

$$u_{[0,y,z]}^x(t + \frac{k}{2}) = \frac{\frac{\rho_0 h}{k} - Z}{\frac{\rho_0 h}{k} + Z} u_{[0,y,z]}^x(t - \frac{k}{2}) - \frac{2}{\frac{\rho_0 h}{k} + Z} p_{[0 + \frac{h}{2}, y, z]}(t) \quad (\text{I.29})$$

and

$$u_{[Lx,y,z]}^x(t + \frac{k}{2}) = \frac{\frac{\rho_0 h}{k} - Z}{\frac{\rho_0 h}{k} + Z} u_{[Lx,y,z]}^x(t - \frac{k}{2}) + \frac{2}{\frac{\rho_0 h}{k} + Z} p_{[Lx - \frac{h}{2}, y, z]}(t). \quad (\text{I.30})$$

The equations for the boundaries at $y = 0$ and $y = Ly$ are

$$u_{[x,0,z]}^y(t + \frac{k}{2}) = \frac{\frac{\rho_0 h}{k} - Z}{\frac{\rho_0 h}{k} + Z} u_{[x,0,z]}^y(t - \frac{k}{2}) - \frac{2}{\frac{\rho_0 h}{k} + Z} p_{[x,0+\frac{h}{2},z]}(t) \quad (\text{I.31})$$

and

$$u_{[x,Ly,z]}^y(t + \frac{k}{2}) = \frac{\frac{\rho_0 h}{k} - Z}{\frac{\rho_0 h}{k} + Z} u_{[x,Ly,z]}^y(t - \frac{k}{2}) + \frac{2}{\frac{\rho_0 h}{k} + Z} p_{[x,Ly-\frac{h}{2},z]}(t). \quad (\text{I.32})$$

The equations for the boundaries at $z = 0$ and $z = Lz$ are

$$u_{[x,y,0]}^z(t + \frac{k}{2}) = \frac{\frac{\rho_0 h}{k} - Z}{\frac{\rho_0 h}{k} + Z} u_{[x,y,0]}^z(t - \frac{k}{2}) - \frac{2}{\frac{\rho_0 h}{k} + Z} p_{[x,y,0+\frac{h}{2}]}(t) \quad (\text{I.33})$$

and

$$u_{[x,y,Lz]}^z(t + \frac{k}{2}) = \frac{\frac{\rho_0 h}{k} - Z}{\frac{\rho_0 h}{k} + Z} u_{[x,y,Lz]}^z(t - \frac{k}{2}) + \frac{2}{\frac{\rho_0 h}{k} + Z} p_{[x,y,Lz-\frac{h}{2}]}(t). \quad (\text{I.34})$$

I.1.3 Sound source

At frequencies where the wavelength is too large compared to the dimensions of the loudspeaker they behave as omnidirectional compact sources. Therefore the loudspeakers are defined in the model as small volumes occupying points in the discretized space representing compact sound sources. For example if a cell size of 12 cm is used the sound source is defined by a cube of volume $V=12\text{cm}^3$. Additionally the sound sources can be modeled as membranes moving in different directions. This can be done by using the components of the particle velocity u^x , u^y or u^z . Two types of gaussian functions were used to describe the sound source for visualization purposes. The first presented also in⁷ is an asymmetric gaussian function defined by

$$p_{x_s,y_s,z_s}(t) = \frac{1}{\sigma^2} \sin(t - t_0) e^{-\frac{(t-t_0)^2}{\sigma^2}} \quad (\text{I.35})$$

and

where the -3 dB cut off frequency is given by

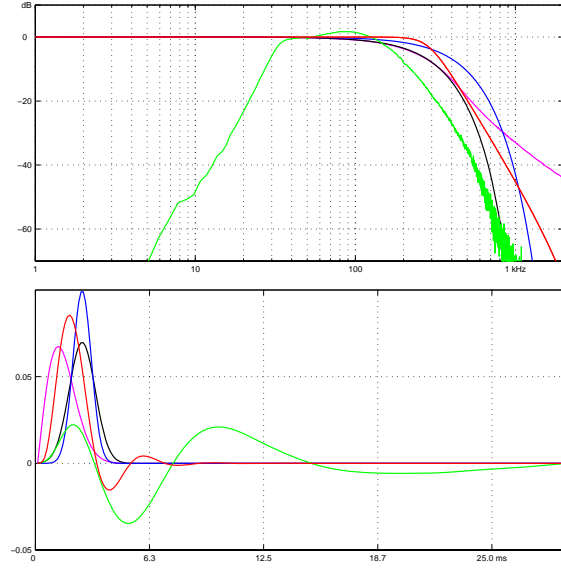

Figure I.13: Impulse response of the different sound sources. Upper, Frequency responses. Lower impulse responses. Magenta, asymmetric gaussian pulse. Black, gaussian pulse with $N = \frac{1}{200Hz}$ and $alpha = 3.5$. Blue, gaussian pulse with $N = \frac{1}{200Hz}$ and $alpha = 5.0$. Red, 4th order Butterworth impulse response. Green, real subwoofer impulse response measured at a few millimeters from the membrane.

$$\sigma = \frac{2}{\omega} \quad (I.36)$$

The second function is defined by the gaussian pulse

$$p_{x_s, y_s, z_s}(t) = e^{-\frac{1}{2} \left[\alpha \frac{(t-t_0) - \frac{\sigma}{2}}{\frac{\sigma}{2}} \right]^2} \quad (I.37)$$

where the -3 dB cut off frequency is given by

$$\sigma = \frac{2\pi}{\omega}, \quad (I.38)$$

and $\alpha \geq 2$ is the reciprocal of the standard deviation of the function. The width of the pulse is inversely related to the value of α , a larger value of α produces a more narrow pulse.

To obtain plain transfer functions of the room a different function was used. A dirac function low pass filtered by a 4th order Butterworth digital filter was used. The cut off frequency is given by the frequency limit of the simulation method which is given by the cell size. It was decided to let 10 cells per wavelength therefore with a cell size of 10 cm the simulation model is valid up to 343 Hz. In Figure I.13 the time responses and the frequency response of the sound sources used are presented.

I.2 Implementation

The simulation program was written in MATLAB. The cell size was chosen between 10 or 12 cm. The sampling frequency fs was chosen to be 8000 Hz. The simulation time was set to approx. 1 s being $t = 2^N$ and $N = 13$. The initial state of the media at $t=0$ is assumed to be homogeneous therefore the acoustic pressure has to be set to zero. Only two time steps of the acoustic pressure and the particle velocity of the entire room are needed for the simulation. Therefore to simulate a room of dimensions $L_x=4.2$ m, $L_y=7.8$ m and $L_z=2.76$ m in principle only 4 matrixes should be initialized:

1. the acoustic pressure $p_{x,y,z}(t)$ of size 35 x 65 x 23 x 2
2. the component of the particle velocity u^x of size 36 x 65 x 23 x 2
3. the component of the particle velocity u^y of size 35 x 66 x 23 x 2
4. the component of the particle velocity u^z of size 35 x 65 x 24 x 2

In addition the following matrixes can be initialized:

1. the particle velocity $u_{x,y,z}(t)$ of size 35 x 65 x 23 x 2
2. the differences Dx in the x direction of either pressure p or particle velocities u^x of size 35 x 65 x 23
3. the differences Dy in the y direction of either pressure p or particle velocities u^y of size 35 x 65 x 23
4. the differences Dz in the z direction of either pressure p or particle velocities u^z of size 35 x 65 x 23
5. the sound pressure level of size 35 x 65 x 1 x 3

This is done if the particle velocity $u(t)$ is needed for special calculations as for example the acoustic radiation power. The extra matrixes Dx, Dy and Dz are initialized to store the result of the built-in function of MATLAB `diff` which differentiates between adjacent elements. For the calculation of the sound pressure level an extra matrix is needed in order to store the result of the squared summation of the acoustic pressures for each time step (see **Paper A** Section 3.1).

Two more matrixes are initialized including a Listening Area defined by 25 virtual microphones and four extra virtual microphones to record the instantaneous acoustic pressure $p_{x,y,z}(t)$ at the desired positions in the room;

1. Listening Area of virtual microphones of size 5 x 5 x 8192
2. Extra virtual microphones 4 x 8192

Only in these matrixes the entire simulation time is stored therefore the memory in use is optimized. With these numbers and this room size no more than 200 MB of memory in RAM are used by MATLAB.

In Figure I.14 the relation between the room volume, number of cells and size cell for the simulation program is presented. For example if a room of 100 m^3 of volume has to be simulated, and the limit of frequency interest is 500 Hz, about 463000 cells are needed. This is by assuming acceptable results up to 10 cells per wavelength.

I.2.1 Wave dispersion errors

At frequencies where the number of cells per wavelength is less than 10 dispersion error exists. In most of this work the limit of the frequency interest was below 200 Hz therefore by choosing a cell size from 10-12 cm the wave dispersion errors were assumed negligible. In the literature advanced methods to correct those errors can be found for example in²². The correction of these errors was not in the scope of this work.

I.2.2 Transfer function measurement

To obtain the transfer function at low frequencies of the room from a loudspeaker to the complete listening area or a virtual microphone an impulse response of an existing closed box loudspeaker was utilized along most of this work. This impulse response was measured at 5 mm from the membrane in anechoic conditions. Alternatively to obtain the transfer function from an omnidirectional compact source the Gaussian pulse or the low passed dirac impulse was utilized.

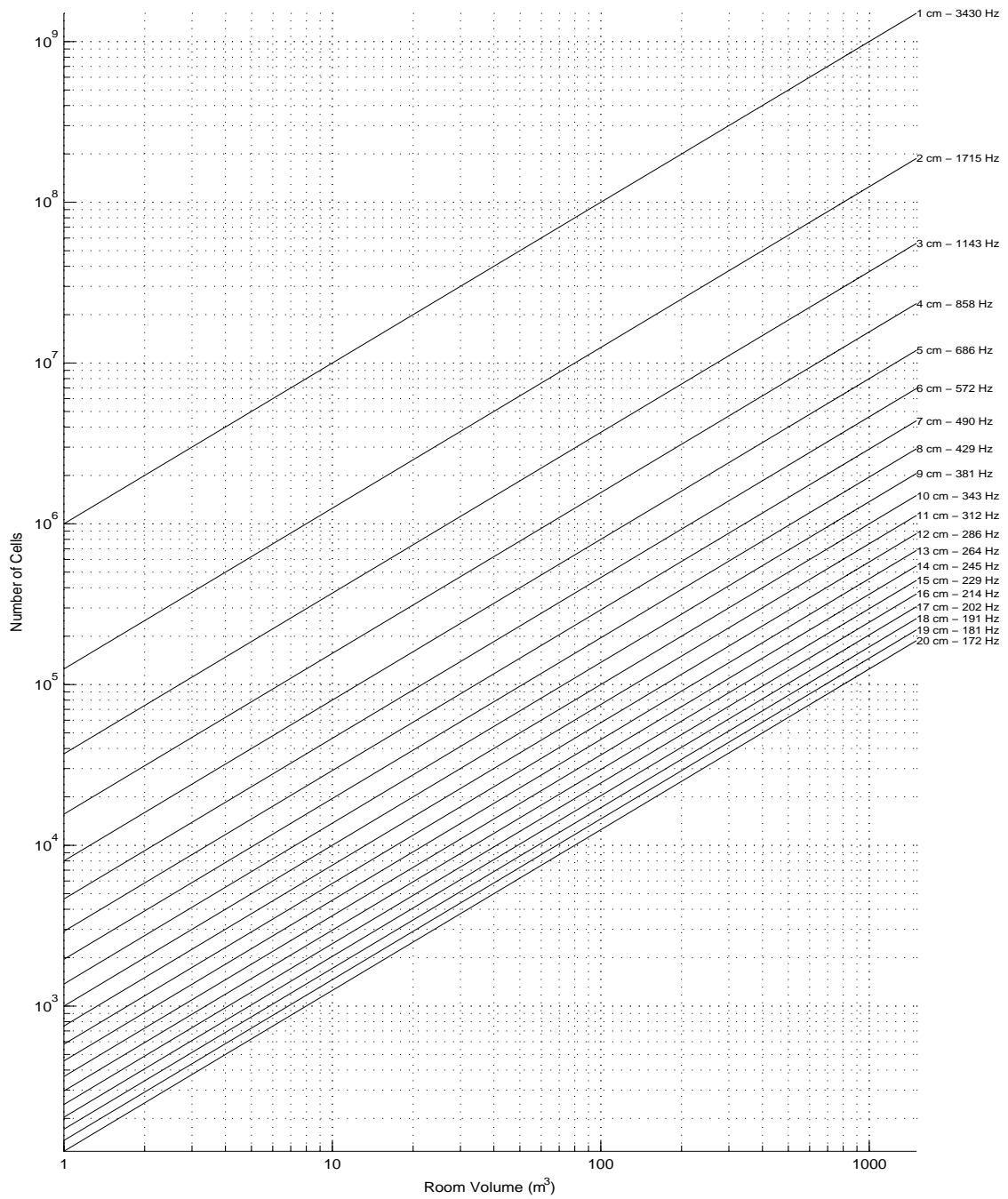

Figure I.14: Relation between room volume and number of cells necessary for the simulation. The inclined lines indicate the frequency limit of the simulation program per cell size. Ten cells per wavelength are assumed for the calculation.

I.2.3 The walls

The absorption coefficient of each wall can be defined by setting α in Eq. (I.24). Alternatively since it is assumed that the absorbing characteristics of the wall are determined by the normal specific acoustic impedance.

I.3 Graphical user interface (GUI) of The Sound Field Room Simulator

A graphical user interface shown in Figure I.15 has been developed in order to introduce the different parameters for the room simulation. This user interface works under MATLAB Ver 7.0.4 and can be launched from the command window by typing `SIMRoomV02` for regular rooms or `SIMRoomVi02` for irregular rooms.

1. Room

Dimensions

The dimensions of the enclosure are defined in meters. The origin of the simulation model is assumed to be in the upper left corner of the room seen from above as shown in Figure I.15.

Absorption Coefficients

The absorption coefficient of the walls floor and ceiling can be defined here. A number from 0.0001 to 1 can be inserted which indicates the absorption coefficient of the wall.

Observation Layer

The observation height is defined here, this is for the calculation of the sound pressure level (SPL) in a horizontal plane along the room.

Corner Coordinate

In the software version for irregular rooms a text box is included where the coordinates of the partition corner can be entered (see Figure E.4).

Odd Mesh

Here an odd number of cells is forced for the discretization of the room.

Cell Size

The size of the cell in cm is defined here.

2. Sound Sources

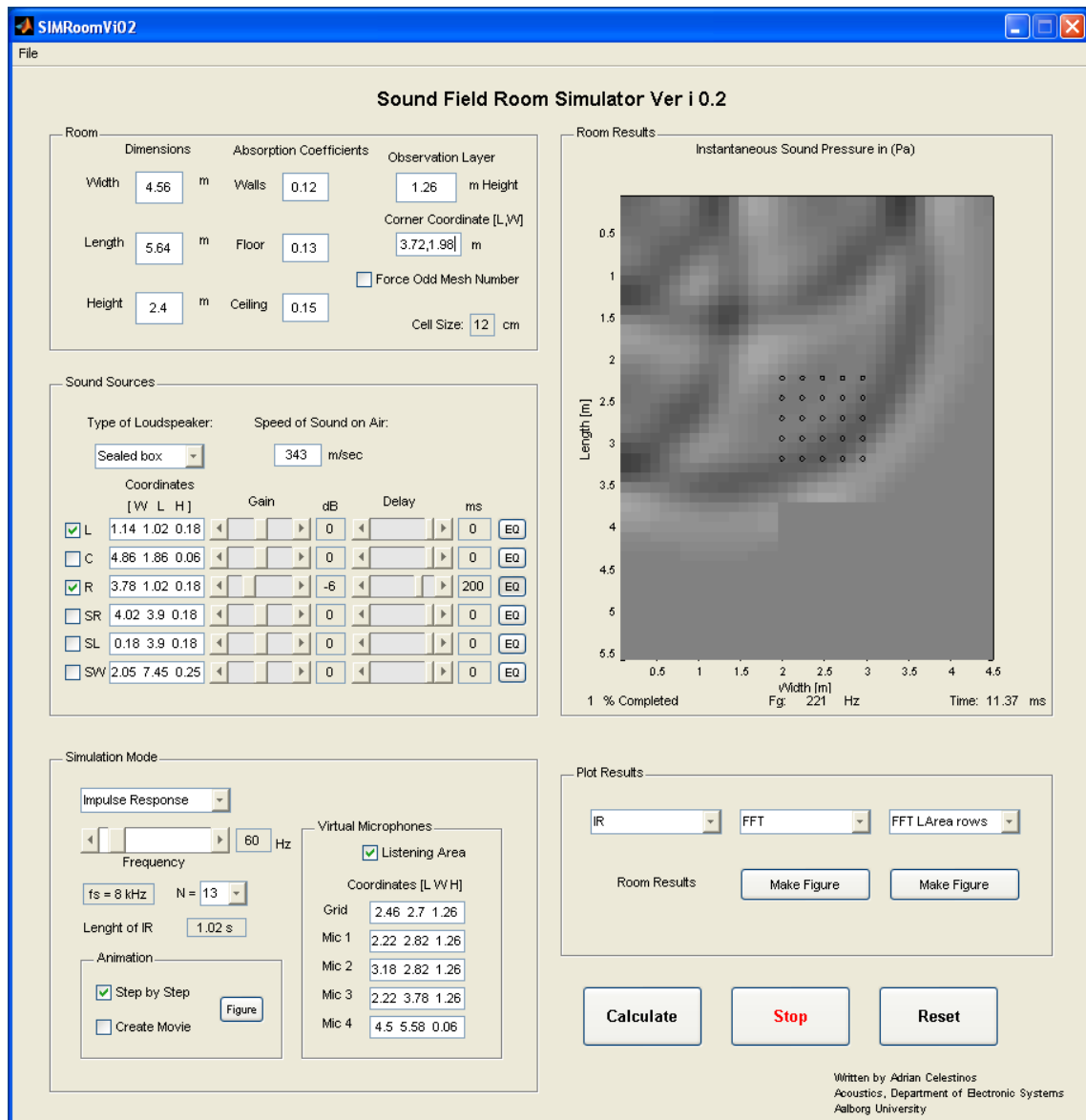

Figure I.15: Graphical user interface (GUI) of the Sound Field Room Simulator

Type of loudspeaker

In this menu different sound sources can be chosen, a pre-defined impulse response of a real loudspeaker “Real Loudspeaker”, a modeled sealed box type loudspeaker “Sealed box” and a “Pulse” which is a Gaussian pulse with flat frequency response from 0 Hz to 100 Hz approx. Additionally by chosen “Transfer

function” the low passed dirac impulse described in Section I.1.3 is utilized to obtain the transfer function measurement of the room.

Number of loudspeakers

Up to six loudspeakers can be switched on in each simulation by activating each box marked as L, C, R, SR, SL, and SW.

Coordinates

The coordinates of each loudspeaker in the room are defined in the text boxes.

Gain

A gain of ± 12 dB can be adjusted for each loudspeaker.

Delay

A pure delay from 0.125 ms (1 sample) up to 500 ms (4000 samples) can be added to each loudspeaker.

EQ

By activating this button the loudspeaker is pre filtered by an FIR filter or an IIR filter. The coefficients of this filter should be saved before in matrix file as “eqfilters.mat”.

Speed of Sound in Air

The speed of sound in the media can be set here.

3. Simulation Mode

Two simulation modes can be utilized, “Impulse Response” and “Single Frequency”. The first mode is to acquire impulse responses at the listening area and the four virtual microphones. The second mode is to obtain an approximation of the SPL in a horizontal section of the room. In this mode the loudspeakers are driven by a single frequency. This frequency is pre-filtered with the loudspeaker impulse response.

Frequency

If the “Single Frequency” simulation mode has been chosen then the driving frequency can be introduced by the slider or by entering the number into the text box.

Simulation Time

The simulation time can be adjusted by modifying the “N” order button having $N=13$, $N=14$ and $N=15$ as possible options. Time responses of 2^N samples can be acquired. The length in seconds is presented in the box below the “N” order button.

Animation

The animation for visualization purposes can be activated by marking the box “Step by Step” under the Animation frame. By doing this the horizontal layer at the selected height under the box “Observation Layer” is displayed on the

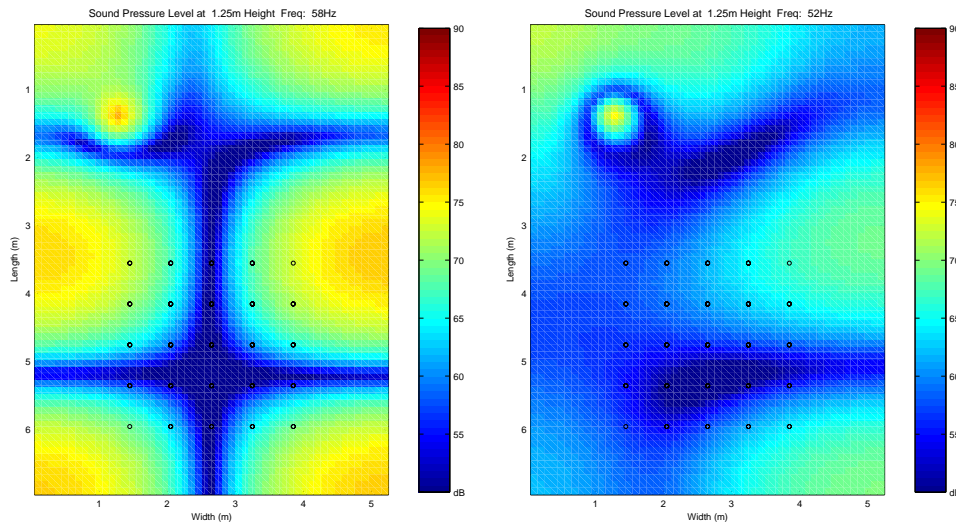

Figure I.16: Example of results of room simulations using “Single Frequency” mode and selecting “SPL 2D”. Sound pressure level distribution in the room, Left the loudspeaker is driven by 52 Hz. Right, the loudspeaker is driven by 58 Hz.

frame Room Results. If the “Figure” button is activated the animation is detached from the GUI and an individual figure is created.

Movie file

By marking the box “Create Movie” an .AVI file can be created. This is done by indexed frames taken from the animated figure. In order to properly close the movie file before completing the total simulation time, the button “Stop” has to be pressed until the simulation stops.

Virtual Microphones

Four “Virtual microphones can be located at different positions within the room. The microphone coordinates can be introduced on each text box.

Listening Area

By default the program fixes a Listening Area of 25 virtual microphones centered in the room. The location of the center can be adjusted by introducing the new coordinates in the text box “Grid”. By marking the box “Listening Area” the location of the microphones can be seen if the animation is displayed.

4. Plot Results After a simulation is completed the results can be displayed in different forms by selecting the menus under the Plot Results frame. If the simulation mode “Impulse Response” was chosen the impulse response at the four microphones are displayed in the Room Results frame. For example, by selecting “FFT” into the first or second menu from left to right the frequency response of the time responses can be

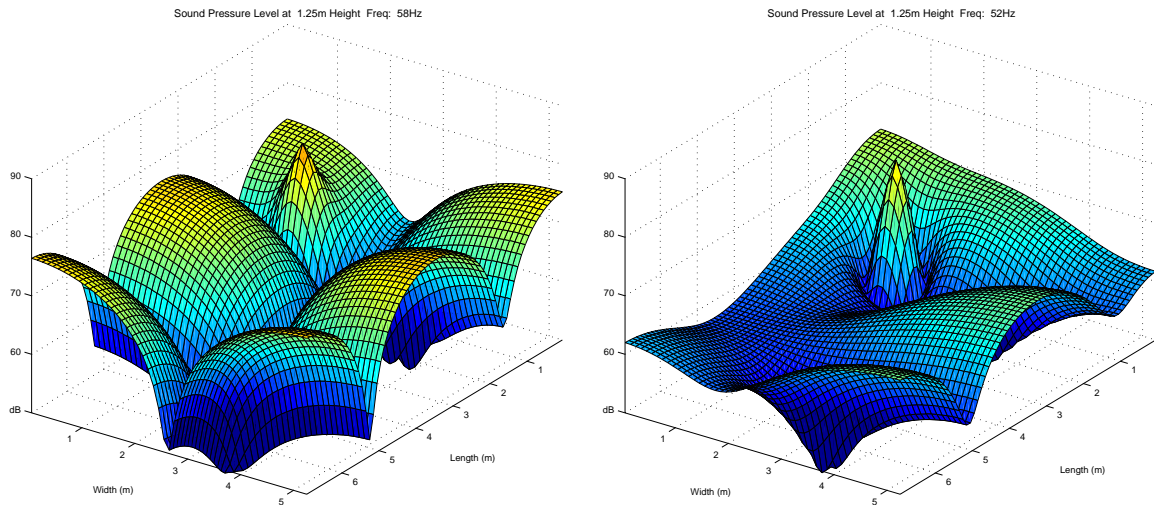

Figure I.17: Example of results of room simulations using “Single Frequency” mode and selecting “SPL Surf”. Sound pressure level distribution in the room, Left the loudspeaker is driven by 52 Hz. Right, the loudspeaker is driven by 58 Hz.

displayed (see Figure I.18). To display the time and frequency responses in the same frame “IR FFT” must be selected (see Figure I.19). To display frequency response and phase “FFT Phase” can be selected. To display the 25 frequency responses at the listening area in one plot “FFT LArea all” must be selected (see Figure I.18). To display the frequency responses by rows from the listening area “FFT LArea rows” can be selected. If the selected simulation mode is “Single Frequency” different options of displaying the results can be chosen under the menus. By selecting “SPL 2D” a two dimensional color plot is displayed (see Figure I.16). By selecting “SPL Surf” a surface plot is generated (see Figure I.17). If “SPL Surf Grid” is selected a surface plot delimited by the listening area is displayed.

Make Figure

By pressing the “Make Figure” button a separate figure can be created with the above selected option.

5. Room Results

The results are displayed in this panel as well as the animation frames.

Percentage bar

During the simulation a percentage bar is displayed showing the completed simulation in percentage. This is displayed in the Room Results panel too.

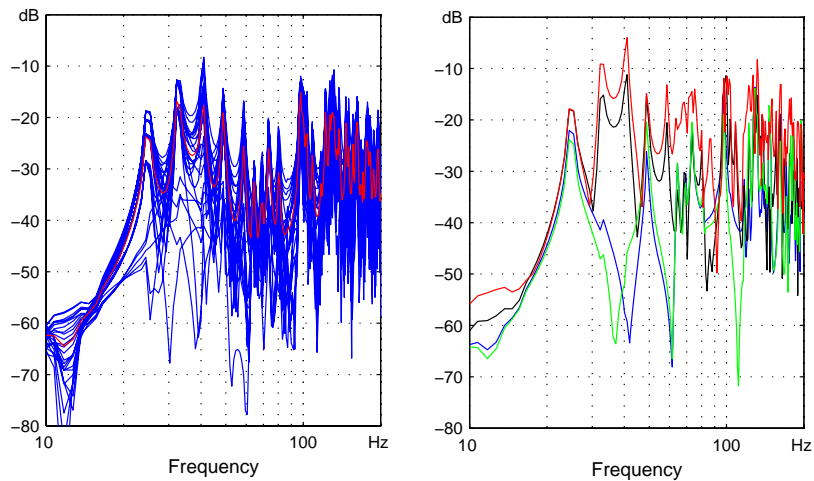

Figure I.18: Frequency response of the time responses. Example of results of room simulations using “Impulse response” mode. Left, selecting “FFT LArea all” all positions in the listening area are included. Right, selecting “FFT” only the four microphone positions are included.

Fg

Under the Room Results frame the estimated Schroeder frequency f_g is calculated with the given dimensions.

Simulation Time

When the “Step by Step” function is activated the simulation time t in milliseconds is displayed here.

6. Start simulation After all parameters are set the button “Calculate” has to be pressed.
7. Stop button In order to stop the simulation the “Stop” button has to be pressed.
8. Reset button

In order to reset the simulation program to the default settings the “Reset” button has to be pressed.

9. File menu

Under the “File” menu a set of functions can be done as for example, to save just the results on a small file, to save the simulation settings or to save the complete simulation on a desired location in the hard disk of the PC.

Load Settings from File

A previously saved file containing the settings of the simulation can be loaded.

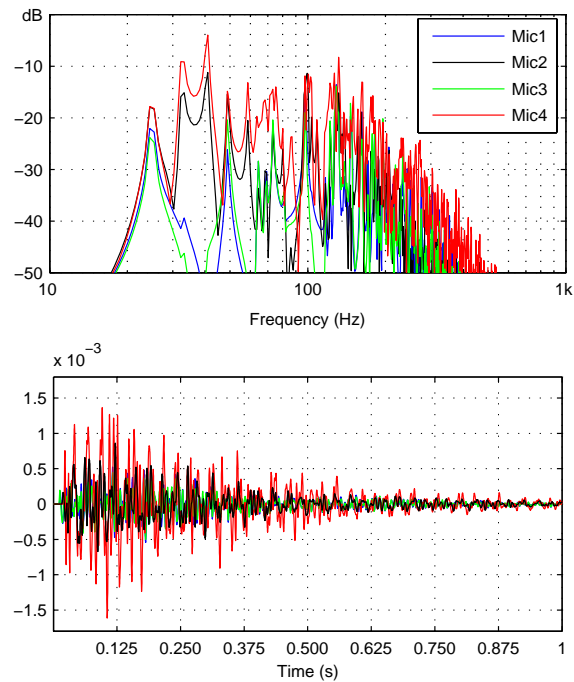

Figure I.19: Frequency responses and impulse responses. Example of results of room simulations using “Impulse response” mode selecting “IR FFT”. Upper, frequency response at the four microphone positions. Lower, time responses at the four microphone positions.

Save Settings as

All settings of the simulation are saved on a desired location in the PC.

Save Results as

The impulse responses of the listening area and the four microphone responses can be saved on disk as a texttt.mat file.

Save all as

The complete set of variables, settings and results can be saved into a file texttt.mat. This file can be recalled to repeat the simulation or just to display the results.

Load Results from File

A previously saved file by “Save all as” containing all set of variables, settings and results of the simulation can be loaded. The simulation can be repeated or the results can be displayed again.

Close Program

This option closes the simulation program and GUI interface after displaying a warning window.

II

Appendix II

II.1 Normal Modes of Vibration in Rooms

In this Appendix the derivation of the normal modes of vibration in an enclosure from the conventional solution of the wave equation is presented.

The propagation of sound in fluids contained in regions of space can be derived by the linear, lossless wave equation valid for acoustic processes of small amplitude¹² which is given by

$$\nabla^2 p = \frac{1}{c^2} \frac{\partial^2 p}{\partial t^2} \quad (\text{II.39})$$

where c is the speed of sound in the propagation media and ∇^2 is the three dimensional Laplacian in Cartesian coordinates therefore Eq.II.39 can be rewritten in terms of the Cartesian coordinates

$$\frac{\partial^2 p}{\partial x^2} + \frac{\partial^2 p}{\partial y^2} + \frac{\partial^2 p}{\partial z^2} = \frac{1}{c^2} \frac{\partial^2 p}{\partial t^2} \quad (\text{II.40})$$

In order to calculate the normal modes of vibration in the enclosure a conventional solution to the wave equation (II.39) can be given in the form of

$$p(x, y, z, t) = \Psi e^{j\omega t} \quad (\text{II.41})$$

where Ψ is a function of position and substitution of $k = \omega/c$ yields to a

$$\nabla^2 \Psi + k^2 \Psi = 0 \quad (\text{II.42})$$

which is well known as the Helmholtz equation, after separation of variables and since Ψ is a product of three functions each dependent on only one the dimensions $\Psi(x, y, z) = \mathbf{X}(x)\mathbf{Y}(y)\mathbf{Z}(z)$ therefore Eq. (II.41) becomes

$$p(x, y, z, t) = \mathbf{X}(x)\mathbf{Y}(y)\mathbf{Z}(z)e^{j\omega t} \quad (\text{II.43})$$

and Eq. (II.42) can be rewritten as

$$\frac{\partial^2 \Psi}{\partial x^2} + \frac{\partial^2 \Psi}{\partial y^2} + \frac{\partial^2 \Psi}{\partial z^2} + k^2 \Psi = 0 \quad (\text{II.44})$$

$$\begin{aligned} \left(\frac{d^2}{dx^2} + k_x^2\right)\mathbf{X} &= 0 \\ \left(\frac{d^2}{dy^2} + k_y^2\right)\mathbf{Y} &= 0 \\ \left(\frac{d^2}{dz^2} + k_z^2\right)\mathbf{Z} &= 0 \end{aligned} \quad (\text{II.45})$$

where the angular frequency must be given by

$$\left(\frac{\omega}{c}\right)^2 = k^2 = k_x^2 + k_y^2 + k_z^2 \quad (\text{II.46})$$

Considering a rectangular room of dimensions L_x , L_y and L_z and assuming that the normal component of the particle velocity is zero at all walls therefore the boundary conditions become

$$\begin{aligned} \left(\frac{\partial p}{\partial x}\right)_{x=0} &= \left(\frac{\partial p}{\partial x}\right)_{x=L_x} = 0 \\ \left(\frac{\partial p}{\partial y}\right)_{y=0} &= \left(\frac{\partial p}{\partial y}\right)_{y=L_y} = 0 \\ \left(\frac{\partial p}{\partial z}\right)_{z=0} &= \left(\frac{\partial p}{\partial z}\right)_{z=L_z} = 0 \end{aligned} \quad (\text{II.47})$$

Since the energy can not escape from the enclosure a solution to the wave equation can be the cosines thus Eq.(II.43) becomes

$$p_{lmn} = \mathbf{A}_{lmn} \cos k_{xl}x \cos k_{ym}y \cos k_{zn}z e^{j\omega_{lmn}t} \quad (\text{II.48})$$

where the components of k are

$$\begin{aligned} k_{xl} &= l\pi/L_x & l &= 0, 1, 2, \dots \\ k_{ym} &= m\pi/L_y & m &= 0, 1, 2, \dots \\ k_{zn} &= n\pi/L_z & n &= 0, 1, 2, \dots \end{aligned} \quad (\text{II.49})$$

by using this solution the only allowed angular frequencies where a standing wave will occur are given by

$$\omega_{lmn} = c \sqrt{\left(\frac{l\pi}{L_x}\right)^2 + \left(\frac{m\pi}{L_y}\right)^2 + \left(\frac{n\pi}{L_z}\right)^2} \quad (\text{II.50})$$

or in¹⁴ as

$$f_n = \frac{c}{2} \sqrt{\left(\frac{n_x}{L_x}\right)^2 + \left(\frac{n_y}{L_y}\right)^2 + \left(\frac{n_z}{L_z}\right)^2} \quad (\text{II.51})$$

where c is the speed of sound in the air, n_x , n_y and n_z are integers starting with 0, 1, 2,... and L_y , L_x , L_z are the dimensions of the room. Each standing wave has its own modal frequency and these are specified by the integers l, m, n or n_x, n_y, n_z . The zones where there will be minimum pressure are called *nodes* and the zones where there is a maximum pressure are called *antinodes*. If a sound source is located at a node of a modal frequency this mode will not be excited, on the contrary if a sound source is placed close to or at an antinode of a modal frequency this will be greatly excited. Similarly if a receiver is located at an antinode its output will be great and if the receiver is located at a node of a mode its output will be minimum.