



Large-scale Heat Pumps in Sustainable Energy Systems

Blarke, Morten Boje

Published in:

Long-term perspectives for balancing fluctuating renewable energy sources

Publication date:
2007

Document Version
Publisher's PDF, also known as Version of record

[Link to publication from Aalborg University](#)

Citation for published version (APA):

Blarke, M. B. (2007). Large-scale Heat Pumps in Sustainable Energy Systems. In *Long-term perspectives for balancing fluctuating renewable energy sources* (pp. 83-92). University of Kassel.

General rights

Copyright and moral rights for the publications made accessible in the public portal are retained by the authors and/or other copyright owners and it is a condition of accessing publications that users recognise and abide by the legal requirements associated with these rights.

- Users may download and print one copy of any publication from the public portal for the purpose of private study or research.
- You may not further distribute the material or use it for any profit-making activity or commercial gain
- You may freely distribute the URL identifying the publication in the public portal -

Take down policy

If you believe that this document breaches copyright please contact us at vbn@aub.aau.dk providing details, and we will remove access to the work immediately and investigate your claim.



Long-term perspectives for balancing fluctuating renewable energy sources

Author: John Sievers, Stefan Faulstich, Mathias Puchta, Ingo Stadler, Jürgen Schmid,
Company: University of Kassel,
Department of Efficient Energy Conversion
Adress: Wilhelmshoehher Allee 73
34121 Kassel
Germany
Email: jjsievers@uni-kassel.de
Versions: version 2007-03-15
Document name: Long-term perspectives for balancing fluctuating renewable energy sources
Belongs to: TREN/05/FP6EN/S07.43516/513473
Further Authors: See List on next page
Abstract: This document contains reports about techniques for balancing fluctuating renewable energy sources
2007/05/30 revised
Class: Deliverable 2.3
Annexes:
Distribution: public document



The DESIRE Consortium:

Aalborg University	Principal Contractor & Coordinator	Denmark
EMD	Principal Contractor	Denmark
PlanEnergi	Principal Contractor	Denmark
University of Birmingham	Principal Contractor	United Kingdom
ISET	Principal Contractor	Germany
Universität Kassel	Principal Contractor	Germany
EMD Deutschland	Principal Contractor	Germany
LABEIN	Principal Contractor	Spain
Warsaw Technical Univ.	Principal Contractor	Poland
Tallin Technical Univ.	Principal Contractor	Estonia

Micro Turbines and Night Storage Heaters, reports prepared by:

John Sievers, Ingo Stadler, Jürgen Schmid
University of Kassel, Department of Efficient Energy Conversion
Wilhelmshoeher Allee 73
DE-34121 Kassel

Contact person:

John Sievers; email: jjsievers@uni-kassel.de, Phone: +49 561-804-6206

Buildings as Energy Storage Devices and Increased Storage Capacity through PCM, reports prepared by:

Stefan Faulstich, John Sievers, Ingo Stadler, Jürgen Schmid
University of Kassel, Department of Efficient Energy Conversion
Wilhelmshoeher Allee 73
DE-34121 Kassel

Contact person:

John Sievers; email: jjsievers@uni-kassel.de, Phone: +49 561-804-6206

Heat, Cold and Power, report prepared by:

Carlos Madina, Ángel Díaz, Nerea Ruiz, Elena Turienzo
LABEIN, Energy Unit
C/Geldo – Parque Tecnológico de Bizkaia, Edificio 700
48160 Derio (Bizkaia) - Spain

Contact person:

Carlos Madina; email: cmadina@labein.es, Phone: +34 94 607 33 00

Stirling Engines for CHP Biomass Applications, report prepared by:

Ebbe Muenster
PlanEnergi
Jyllandsgade 1
9520 Skørping - Denmark

Contact person:

Ebbe Muenster; email: em@planenergi.dk, Phone: +45 96820400

Large-scale Heat Pumps in Sustainable Energy Systems

Morten Boje Blarke
Department of Development and Planning
Fibigerstraede 13
DK-9220 Aalborg, Denmark

Contact person:

Morten Boje Blarke; email: Blarke@plan.aau.dk, Phone: +45 9635 7213

Fuel Cells for Balancing Fluctuating Renewable Energy Sources:

Brian Vad Mathiesen
Aalborg University
Department of Development and Planning
Fibigerstraede 13
9220 Aalborg OE
Denmark

Contact person:

PhD Fellow Brian Vad Mathiesen; email: bvm@plan.aau.dk, Phone: +45 9635 7218

Contents

1	Introduction.....	6
2	Summary.....	7
	2.1 Electricity.....	7
	2.2 Heat.....	9
3	Potentials.....	11
	3.1 Night Storage Heaters in the Short Term Perspective.....	11
	3.2 Circulation Pumps.....	12
	3.2.1 Short Term Perspective.....	14
	3.2.2 Long Term Perspective.....	14
	3.3 Air-Conditioning Units.....	17
	3.4 Hot Water Stores with Electric Heaters.....	18
	3.4.1 Short Term Perspective.....	18
	3.4.2 Long Term Perspective.....	19
	3.5 Cooling.....	22
	3.6 Co-generation.....	22
	3.6.1 Heat Demand Scenarios.....	23
	3.6.2 Trigeneration and Cooling.....	26
	3.7 Scenario 2020.....	27
	3.7.1 Assumptions.....	27
	3.7.2 Calculations.....	30
	3.7.3 Results.....	34
	3.8 Final assessment.....	42
4	Stirling Engines (PE).....	44
	4.1 Description.....	44
	4.2 Technological state.....	49
	4.3 Efficiencies.....	49
	4.4 Constraints.....	49
	4.5 Emissions.....	50
	4.6 Costs.....	50
5	Trigeneration (LABLEIN).....	51
	5.1 Technology Description.....	51
	5.1.1 Introduction.....	51
	5.1.2 Efficiency.....	57
	5.1.3 Thermal storage.....	60
	5.1.4 Technical problems and solutions.....	61
	5.2 Calculations.....	62
	5.2.1 Introduction.....	62
	5.2.2 Demand curves.....	62
	5.2.3 Trigeneration system.....	66
	5.2.4 General approach.....	66
	5.2.5 Energy analysis.....	70
	5.2.6 Results.....	72
	5.2.7 Conclusion.....	76
	5.3 Assessment.....	79
	5.3.1 Technical assessment: Suitability and availability.....	79
	5.3.2 Comparison with CHP.....	80
	5.3.3 Economic assessment: Costs, historical and future cost development.....	80
	5.3.4 Environmental aspects.....	82
6	Heat pumps (AAU).....	83

6.1	Key findings	83
6.2	Heat pumps and the principle of relocation.....	84
6.2.1	The principle of relocation.....	84
6.2.2	Early modern large-scale heat pumps	84
6.2.3	Selected existing large-scale heat pump applications	86
6.2.4	Relocation-relevance of heat pump principles and technology applications	87
6.3	CHP-HP Cold Storage.....	89
6.4	Instruments for promoting relocation in distributed generation	90
6.5	Conclusion and perspectives	91
7	Fuel cells for balancing fluctuating renewable energy sources (AAU)	93
7.1	Technology Description	93
7.1.1	Introduction.....	93
7.1.2	Fuel cell characteristics, efficiencies and applications	93
7.2	Calculations of fuel cells wind balancing abilities	97
7.3	Assessment of fuel cells	99
7.4	Environmental impacts.....	100
8	Micro turbines (UniK)	104
8.1	Technology Description:	104
8.1.1	Introduction.....	104
8.1.2	Efficiency of Micro Turbine CHP Units.....	105
8.1.3	Thermal Storage.....	108
8.1.4	Technical Problems and Solutions.....	108
8.1.5	Influence on Electricity Supply and Demand Load Curve	108
8.2	Assessment	109
8.2.1	Technical Assessment: Suitability and Availability	109
8.2.2	Comparison with Motor CHP	109
8.2.3	Economic Assessment: Costs, Historical and Future Cost Development.....	110
8.2.4	Environmental Aspects:.....	110
9	Electric Night Storage Heaters (UniK)	111
9.1	Technology Description:	111
9.1.1	Introduction.....	111
9.1.2	Efficiency.....	112
9.1.3	Thermal Storage.....	112
9.1.4	Technical Problems and Solutions.....	113
9.2	Assessment	114
9.2.1	Technical Assessment: Suitability and Availability	114
9.2.2	Comparison with CHP	114
9.2.3	Economic Assessment	114
9.2.4	Environmental Aspects	114
9.3	Wind Power Balancing Abilities	114
9.3.1	Influence on Electricity Supply and Demand Load Curve	114
9.3.2	Potential	114
10	Buildings as Energy Storage Devices (UniK).....	116
10.1	Technology Description	116
10.1.1	Introduction	116
10.1.2	Efficiency	118
10.1.3	Thermal Storage	118
10.1.4	Technical Problems and Solutions	120
10.2	Wind Power Balancing Abilities	120
10.3	Assessment	122
11	Increased storage capacity through PCM (UniK)	123
11.1	Technology Description:	123
11.1.1	Introduction	123

11.1.2	Efficiency	131
11.1.3	Thermal Storage	131
11.1.4	Technical Problems and Solutions	134
11.2	Assessment	135
11.2.1	Technical assessment: Suitability and availability	135
11.2.2	Comparison with CHP	136
11.2.3	Economic assessment: Costs, historical and future cost development	136
11.2.4	Environmental aspects	136
12	References	137

1 Introduction

This document summarizes investigations about new concepts for balancing wind energy, the at present most important fluctuating weather dependent renewable power source in Europe, by different measures on the power supply and demand side. The investigations shall contribute to the efforts to solve the question of how to integrate higher shares of renewable energies in the European power supply.

After a description of the national present states of those countries that participate in the EU-project DESIRE, which has been done in a document named “**Analysis of CHP designs and boundary conditions in different European countries**”, the present and future CHP plant balancing abilities have been analyzed within a document, named “**Concepts for small scale CHP units to be integrated into buildings or industry and medium scale CHP units with district heating**”. In the given document, called “**Long term perspective for balancing fluctuating renewable energy sources**”, the results of researches regarding the palette of balancing capable techniques for the long term perspective are presented.

The investigation comprises technical requirements and potentials for an optimal design of electric consumer- and generator-techniques for balancing fluctuating wind power. The research about long-term solutions concerns the question how far the existing energy supply system is capable for this today and how it should be designed in the future.

This document consists of several reports prepared by the University of Kassel and its partners. After this overview the 2nd chapter contains a summary of the results and the 3rd chapter explains balancing potentials; the following chapters are detailed technology reports.

We want to say thanks to Bernhard Lange and Kurt Rohrig for letting us using the ISET wind data. As well we thank for the contribution of the co-authors (see below), and Sasa Bukvic-Schäfer, Anna Holzmann and Thorsten Reimann for consumption data of electric consumers and researches about electric heaters and a micro turbine scenario.

2 Summary

The **long term perspective** for the integration of high shares of renewable energies in the European power supply has to deal with **coordinated** supply by **combined generation and use of power and heat** and with **demand response or demand side management** by time shifted consumption.

Today fluctuating wind power still plays a minor role for electricity supply with less than 10 % of the energy production in Europe. Only in Denmark and some regions in Spain and Germany the share lies above 20 %.

In 2020 wind energy could **easily reach the order of 25 %** of the power production in many European Union member states. Very optimistic also 50 % could be achieved, /Scheer 2007/.

In order to keep power supply secure and stable the huge potentials of coordinated combined generation and use of power and heat and **demand side management and response** shall be used (chapter 3). The basic need is the combined consideration of heat and electricity, which is described in the following chapters.





2.1 Electricity

Balancing principle

The European electricity grid is balanced by many transmission system operators at the UCTE level and at other levels like of distribution system operators, energy traders and at industrial company level etc. It also has different time frames like a daily market (spot market), intraday trading, primary, secondary and tertiary reserve in the time frame of seconds to minutes and an hour, or bilateral contracts with base loads in a time frame of several years.

Additionally to the generation side the **demand response principle** is used to adapt consumption.

Table 2-1: Principle of providing balancing power /Armbrüster 2005/

Positive Balancing Power	Negative Balancing Power
Power Generation  operate power plants	Power Generation  shut down power plants
Electric Consumer  turn off consumers	Electric Consumer  operate consumers

Power is delivered to the grid by positive balancing power, which can be offered by operation of power plants or by turning off consumers. Power within the grid is reduced by the so called negative balancing power, when power plants are turned off or by activating consumers, see *Table 2-1*.

Existing Demand Response, state of the art

Very important demand response instruments are night storage heaters. They are in use since plenty of years in order to **shift electricity consumption from day to night**. Typically 8 hours of consumption in the low load period giving negative balancing power to take off the electricity of inert coal fired and nuclear power plants; then about 16 hours without consumption in the high load period. Sometimes there are also some hours at medium load that are used for negative balancing power. Opposite to that is the thermal load and heating power: The thermal energy is stored in the night; heat release is low during night time and high during day time. Hot water storages are used analogous for domestic hot water and furthermore heat pumps can be used for generating space heat and domestic hot water.

Demand Response by Conversion of Electricity into Heat

Direct electric heaters consume electricity and deliver heat when they are turned on. They are not appropriate for an efficient and flexible power management.

Flexibility is achieved by:

1. Heat storage
2. a 2nd heat generation unit (bivalent)

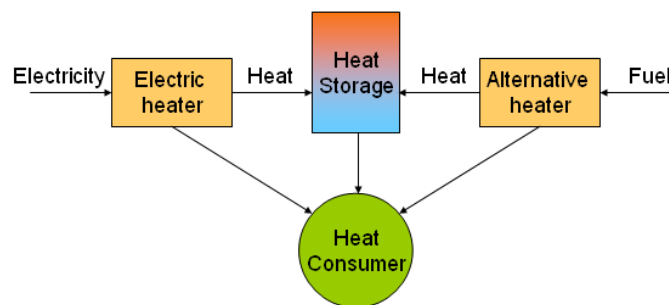

Figure 2-1: Providing heat by electricity, storage and a further heating source

- Without a storage: Space heat and hot water are produced when demanded
- A storage allows a shifted operation: Consumption as **providing negative balancing power** and storing the “product”; on the other hand giving **positive balancing power** in times they stay off (releasing heat)
- An alternative non electric heater allows more **positive balancing power** – staying off in times with low electricity generation.

The most flexible system consists of electric heater, storage and an alternative heating source.

There are further electric consumers like pumps which are used for distribution of heat and there are a lot of other consumers like washing machines, dish washers etc., which can be operated at certain times. The investigations here concentrate on thermal use of electricity for heating and cooling.

2.2 Heat

Realistic scenarios for a future supply with cogeneration and use of heat and power have to consider how far energy consumption and heating energy in particular will be reduced. This is mainly a political question how economic and technical boundary conditions are created, see /D.2.1/.

Considerations about which measures have **priority for reducing energy consumption** lead to the following order:

- The highest efficiency potential lies in reducing **space heat demand** by insulating building shells

A lower range lies in reducing **process heat** demand in the industry or **domestic hot water** consumption in households.

- Another efficiency improvement can be achieved by substituting separated heat and power by **combined production**, e.g. with Diesel Motors and Micro Turbines.

The following figure shows the entire range in-between the nowadays predominating low and a possible future high insulation standard. The present situation is characterized as without or negligible heating energy efficiency measures on the predominating old buildings, but future insulation standard could achieve low energy or even passive house standard. The following graph shows the range for the yearly specific heating energy demand per m² living area.

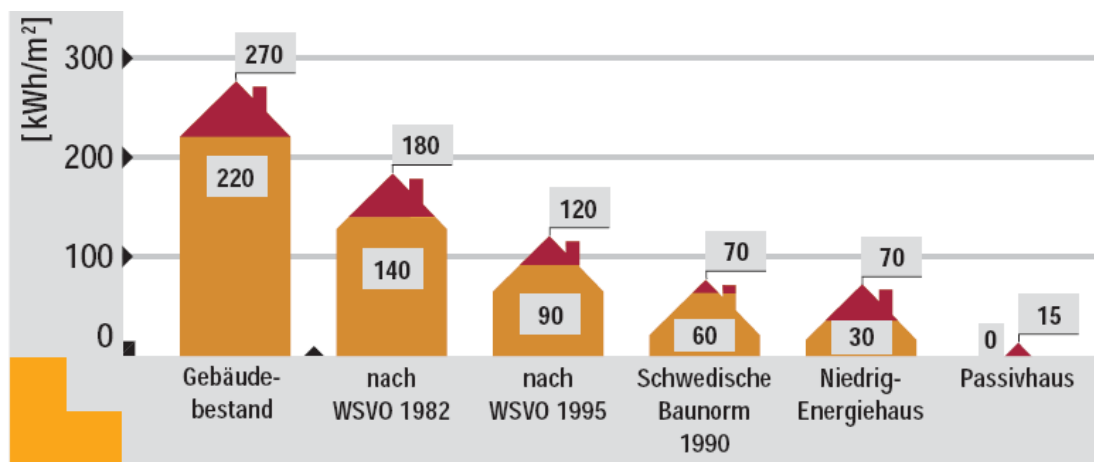

Figure 2-2: Yearly heat demand of buildings from old buildings to passive houses / Impulsprogramm 05/

Heat Demand Model

Heat transfer happens over the surface of the building and depends on the insulation standard, i.e. the u-value which permits or inhibits heat transfer more or less, and it depends on the temperature difference between in- and outside. The outdoor temperature varies much more than the indoor temperature or u-value, which are considered as average or are even interpreted as constant. Heating energy is calculated with degree days or in hourly values (Kelvin hours), /Recknagel 1999/.

If the ambient temperature is sinking below a defined start temperature for heating, a heat energy demand occurs, i.e. it has to be heated to achieve the room temperature. The temperature difference between in- and outside determines the heat demand:

Besides these losses there are losses by ventilation (fresh air demand) and there are energy gains by solar energy through windows and internal gains by people and electric devices. Typically the heat transfer over the building surface dominates the energy balance, but when heat transfer is reduced, the other energies reach a comparable order of magnitude. The insulation effect is modeled both by a sinking u-value and a lower ambient temperature for starting to heat, i.e. not at an ambient temperature of 15°C, but as recently as it drops below 12°C it is necessary to heat.

3 Potentials

Not every electric consumer is appropriate for providing balancing power. This document considers from the appropriate ones only the possibilities given by conversion of electricity into thermal energy or in the context of using it as thermal energy (space heat, domestic hot water and cold). The potentials are described for the German conditions as example.

3.1 Night Storage Heaters in the Short Term Perspective

There is an enormous potential today: Approximately 40 GW installed capacity in Germany and about 27 TWh (5 %) of electricity consumption, /IS 2005/. The important technical parameters and boundary conditions are:

- There is a **considerable static heat release** of the hot storage
- The static heat release delivers too high heating power for warmer outdoor temperatures; room temperature gets too high (overheating)
- The usable **storage capacity depends on the outdoor temperature**: Full load has to be avoided at temperatures higher than ~ 4 to 7 °C, /IS 2005/.
- The complete heat demand is covered by electricity (**monovalent**)

For estimating the potential, this has to be considered. The static heat transfer of different electric night storage heaters varies slightly. Below an ambient temperature of 7 °C or 4 °C heaters can be completely loaded. For an ambient temperature of 15 °C the maximum load is in the order of 40-50 %.

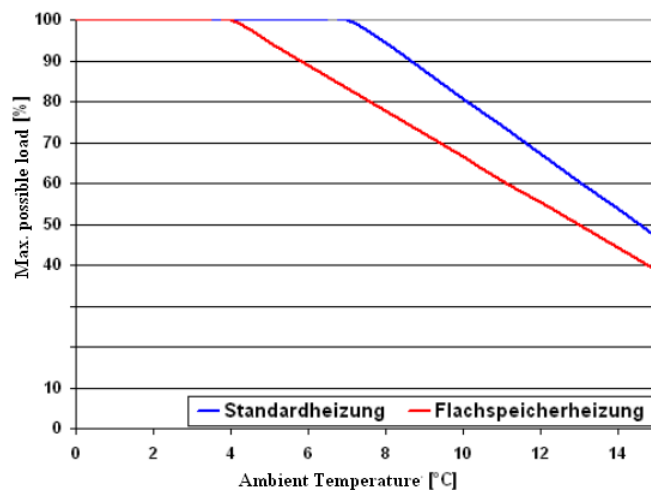

Figure 3-1: Maximum allowed load /IS 2005/

The warmer it gets the slower is the discharging process of the storage and there is less storage capacity in a warm period because of the reduced allowed capacity and because of a reduced discharging that has to be considered before or which occurs in the operation.

Long term perspective

Heat storages can in principle be charged with the installed nominal capacity for some hours, but in practice certain shares are operated for certain periods. The longest possible period of

course occurs at cold temperatures. This allows 8 to 12 hours of charging and, depending on the ambient temperature, a longer or shorter period of discharging. In future a combination of electric space heating and electric hot water generation within storages will be a promising option.

3.2 Circulation Pumps

Circulation pumps are typically running the whole heating period. Therefore **circulation pumps can only provide a positive control potential**.

In the buildings stock of Germany there are about 30 million pumps installed /BINE 2001/. A subdivision for small and for large residential buildings has been done by the Wuppertal Institut. The installed pumps in small buildings can be quoted with 8.7 million pumps /Wuppertal 2003/ and in large buildings with 19.2 millions/Wuppertal 2004/.

The state of the art of the installed pumps are small pumps, which are switchable (45/65/90 Watt), but mostly run on the middle or on the highest level /Königstein 2002/.

If an average installed power of **65 Watt for small buildings** and of **90 Watt for large buildings** is assumed, the total installed power of the pumps can be seen as:

$$P = \underbrace{8,7 \cdot 10^6}_{\text{Amount-of-pumps-small-buildings}} \cdot 65W + \underbrace{19,21 \cdot 10^6}_{\text{Amount-of-pumps-large-buildings}} \cdot 90W = 2,29GW$$

power-of-pumps-small-buildings power-of-pumps-large-buildings

This result is subjected to inaccuracies because of the assumed power of the single pumps. Since there are on the one hand a lot of over dimensioned pumps but on the other hand some high-efficiency pumps with small power installed an estimation of the average power of a single pump is very difficult. The result of **P=2.29 GW** changes for example to **P=2.15 GW** if the average power of each pump is 5 Watts smaller than assumed.

Another way of estimation is through the total energy needed by the pumps. For this estimation the amount of **27.9 million pumps** is considered /Wuppertal 2003/, /Wuppertal 2004/. The energy needed has the order of about **15 TWh** and with 3.5% of Germanys electricity demand it is as big as the energy needed for the public railway transportation of the “Bundesbahn” /BINE 2001/. Since this energy is equal to the power times the operating time, it is necessary to know how long the pumps are in operation.

The following table gives an overview about the energy demand of different pumps from oversized and always running (top left corner) to high efficient with pumping stop control (down right corner).

Table 3-1: Energy demand of pumps (Source: /BdEV 2002/)

Energy demand of pumps at different operation times			
Pump-operation from beginning of September to the end of Mai	140-Watt-pump	65-Watt-pump	7-Watt-pump
Continuous operation (ca 6.500 hours)	917 kWh	425 kWh	46 kWh
Partially turned off in the night (ca 5.300 hours)	740 kWh	345 kWh	37 kWh
With "Pump-stop-control" (ca 3.300 hours)	460 kWh	215 kWh	23 kWh

The age structure of the pumps in Germany is shown in *Figure 3-2*

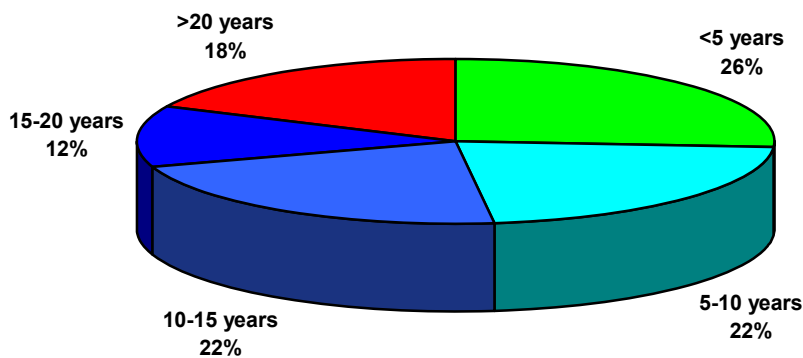

Figure 3-2: Age structure of the pumps in Germany (Source: /Hirschberg 2002/)

Figure 3-2 shows that nearly 75% of the pumps are older than five years. Therefore a large proportion of the pumps are still working continuously. The absolute average operating time of the pumps is between 5.000 and 6.000 hours per year /Eicke-Henning 2006/. In /Hans 2006/ an average duration of 5.400 hours is determined. With this duration the power can be calculated to

$$P = \frac{E}{t} = \frac{15TWh}{5400h} = 2,8GW$$

This result is also subjected to inaccuracies. Assuming for example that nearly all pumps are working continuously the potential would be reduced from $P = 2.8 \text{ GW}$ to $P = 2.3 \text{ GW}$.

Recapitulating the different estimations it can be stated that the power of the pumps is **in the range of 1.8 to 2.8 GW**. Because of the mentioned inaccuracies and with the future development in mind a potential power of $P = 2 \text{ GW}$ is assumed.

The power of circulation pumps depends on the outside temperature, see Figure 3-3. The power drops around 15°C because the average temperature where heating starts is assumed to be at that temperature. Therefore the heating systems and respectively the pumps are incrementally turned off around that temperature value.

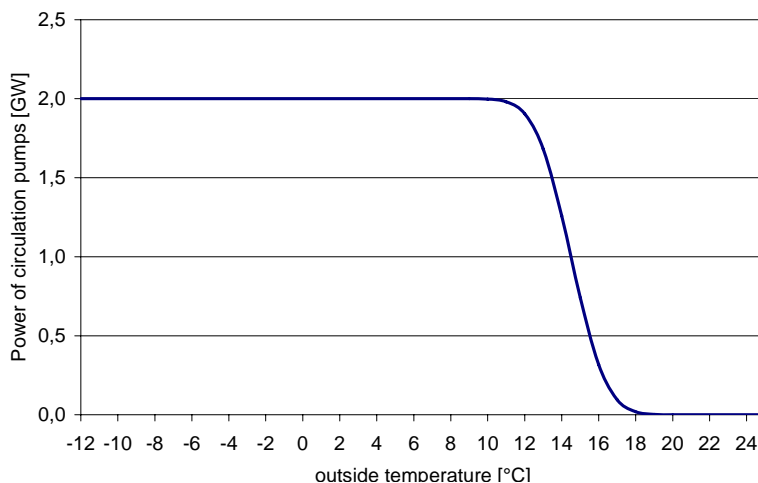

Figure 3-3: Power of circulation pumps dependant on the outside temperature (adapted from: /Stadler 2005/)

The estimation of the installed power and possible time in which the heating system could be turned off allows an estimation of the possible control potential.

3.2.1 Short Term Perspective

The following figure shows the control potential of circulation pumps at an insulation penetration of 30 %, which is the state of the art in Germany /Wuppertal 2002/.

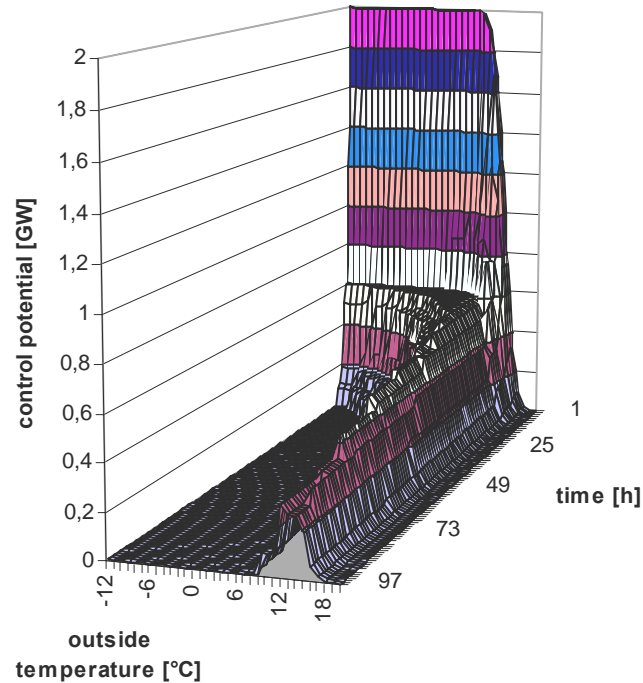

Figure 3-4: Control potential of circulation pumps (30% insulated buildings, /Stadler 2005/

The possible control potential is either high, but for a short duration, or low and at a long duration. Balancing potential for wind power is therefore low.

3.2.2 Long Term Perspective

The long term perspective for balancing fluctuating renewable energy sources depends on two developments. These are on the one hand the development of the insulation penetration and on the other hand the development of the power and of the operation periods of the pumps.

For an estimation of the installed power of the pumps in the future it is assumed that 0.15 Watt per m² are sufficient /Hans 2006/. Together with the living space in Germany of 3.200 km² /DESTATIS 2003/ the overall installed power follows from the above to **P= 0.48 GW**.

The resulting long term perspective for the control potential of circulation pumps is shown in Figure 3-5.

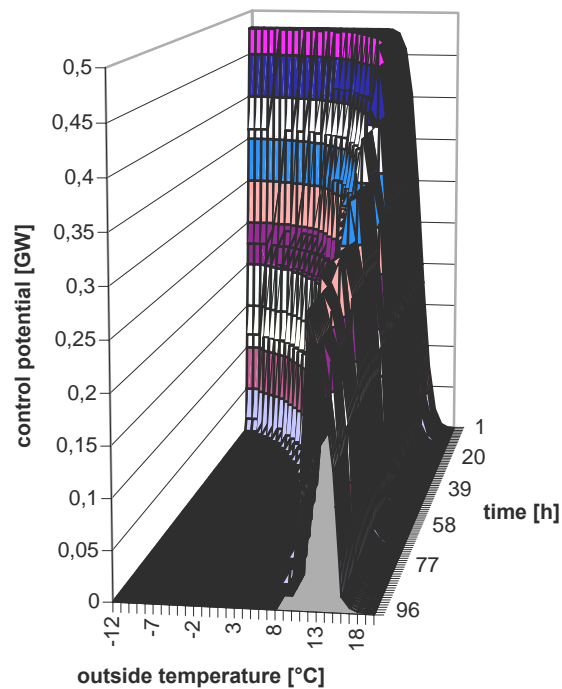

Figure 3-5: Control potential of circulation pumps (100% insulated buildings) (adapted from: /Stadler 2005/)

Phase-Change-Materials

Durations can be increased by the **use of Phase-Change-Materials** as heat store and insulation. This possibility is described in the part “Increased storage capacity through PCM”. The duration of a possible control potential is thereby increasing significantly. Especially at lower outside temperatures the stored energy from the PCM-layer has a substantial contribution. The long term perspective for the possible control potential for a completely insulated building inventory with a supplementary PCM-layer in 30% of the buildings is shown by Figure 3-6.

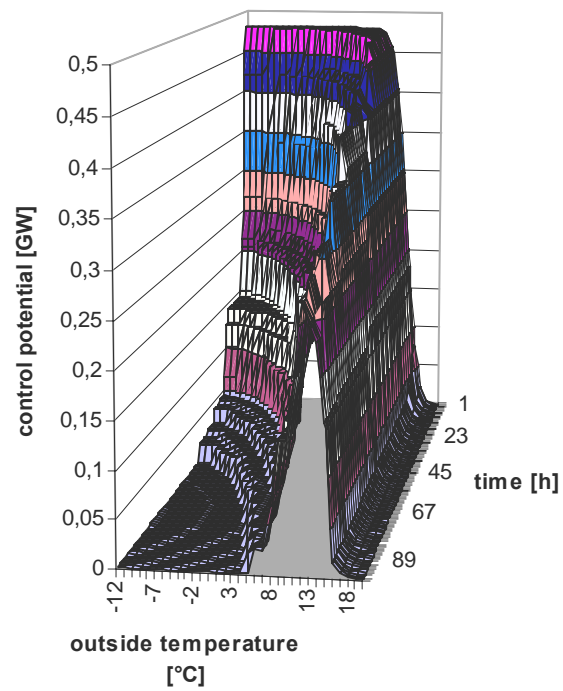

Figure 3-6: Control potential of circulation pumps (All buildings insulated and 30% of the buildings with PCM) (adapted from: /Stadler 2005/)

3.3 Air-Conditioning Units

The purpose of an air conditioning unit is to keep a good air quality. **Air quality** is the parameter for the control potential of air conditioning units, and the storage device is the air inside of the building. If the air quality is good, the air conditioning unit could be turned off until the air quality drops under a certain level. This would mean that the storage device is empty and the air conditioning unit has to be turned on again to improve air quality.

In /Stadler 2005/ the control potential of air conditioning units has been investigated in detail. The results are shown in *Figure 3-7* and *Figure 3-8*.

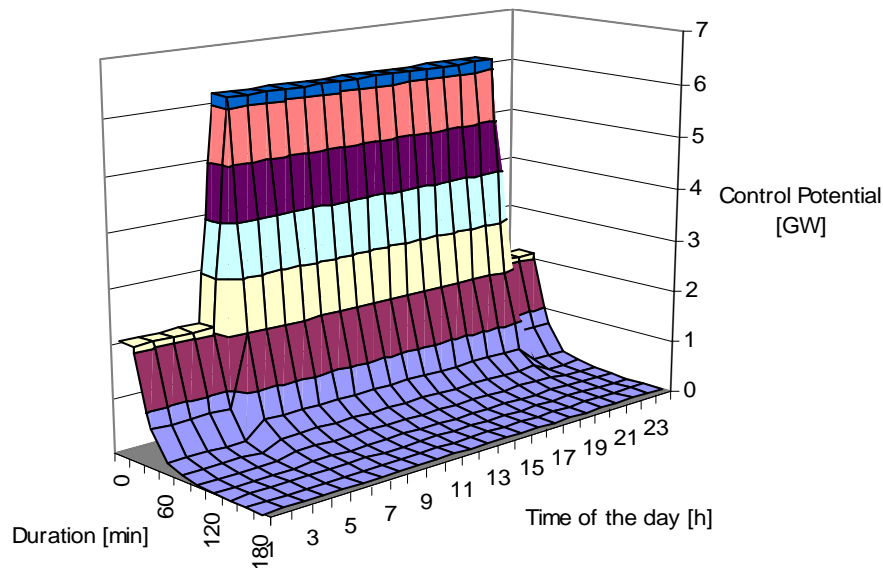

Figure 3-7: Positive Control Potential of air-conditioning units (Source: /Stadler 2005/)

Since the air-conditioning units can be seen just as a normal storage device, a negative control potential could also be provided. The results for a possible control potential calculated in /Stadler 2005/ are shown in *Figure 3-8*.

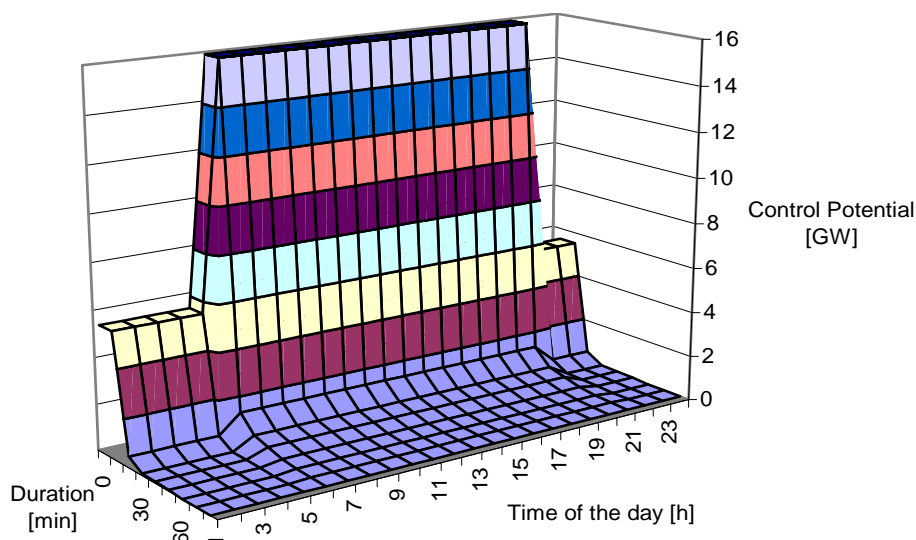

Figure 3-8: Negative Control Potential of air-conditioning units (Source: /Stadler 2005/)

3.4 Hot Water Stores with Electric Heaters

Using electricity for heating or respectively for hot water generation is not reasonable at today's state of the energy supply structure. The generation of electricity in fossil fired power plants is coupled with high losses due to the low energy conversion efficiency. Using electricity, which stems from conversion of chemical energy of the fuel into thermal energy, means reconverting it into thermal energy and this is much less efficient than using conventional gas or fuel oil boilers. The prejudices against heating with electricity are therefore absolutely reasonable.

When in the future the electricity will increasingly stem from the use of renewable energy sources, the conversion of electricity into heat has to be reconsidered.

Especially with regard to the fluctuation of renewable energies, the electric hot water generation with a constant demand becomes an interesting option: Through the possibility of storing, heat can be generated at times with low electricity consumption or high wind power contribution and without losing comfort.

A scenario as a long term perspective was developed in order to investigate this option, which is only an option for future hot water generation, because of the efficiency reasons mentioned before. It is assumed that **every household** in Germany will **install an electric hot water store to cover his daily hot water demand**.

3.4.1 Short Term Perspective

In /Stadler 2005/ the control potential of hot water stores has been investigated in detail. It was determined that **7 TWh per year** are available for a load transfer. The available power was consequently calculated considering a frequency distribution of the hot water demand per person and day and to the relation between the operation time and the sum of operation time and off time in dependency on the daily hot water consumption. Thereby two types of storages have been taken into account: one store with a volumetric capacity of 95 liters and one with a capacity of 35 liters. The time, in which this power is available for balancing purposes, depends on the hot water consumption.

The results for the positive control potential are shown in the following figure.

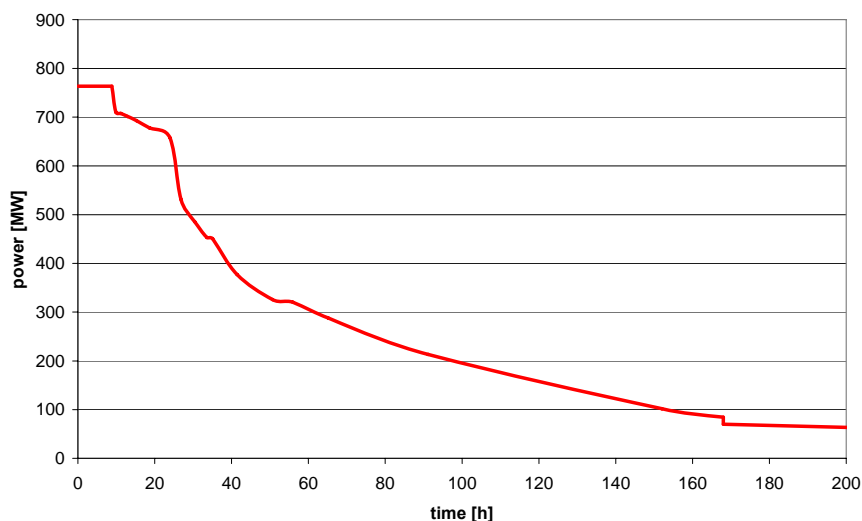

Figure 3-9: Positive control potential of electric hot water stores, /Stadler 2005/

The positive control potential of electric hot water stores in Germany is shown in *Figure 3-9*. The existing balancing potential was considered as rather low with a maximum relocatable power of less than **0.8 GW**.

The negative control potential shows a slightly higher potential. The maximum power of approximately **5 GW** can be used for balancing purposes for a duration of **8 hours**. This duration results from the assumption that the devices are designed in such a way that they realize a full charge of the storage within 8 hours. By that they are able to use lower priced night tariff for charging.

3.4.2 Long Term Perspective

For an assessment of the resulting potential some assumptions are necessary.

The following table provides an overview about the daily hot water demand per person, which is the most important variable for the following calculations.

Table 3-2: Hot water demand and specific useful heat: /VDI R2067/

Demand classification	Hot water demand per person in l/d		Specific useful heat per person in Wh/d
	60 °C	45 °C	
Low consumption	10-20	15-30	600-1200
Average consumption	20-40	30-60	1200-2400
High consumption	40-80	60-120	2400-4800

For further calculations a hot water demand of $30 \frac{l}{d \cdot person}$ and a **hot water temperature of 60°C** are assumed.

With approximately 80 millions habitants in Germany the daily hot water consumption equals to $30 \frac{l}{d \cdot person} \cdot 80.000.000 \text{ personen} = 2,4 \cdot 10^9 \frac{l}{d}$.

Together with the heat storage capacity ($4,187 \frac{kJ}{kg \cdot K}$) and the density of water ($1 \frac{kg}{l}$) the daily needed thermal energy for an inlet temperature of the **cold water of 10°C** follows to

$$Q = m \cdot c \cdot \Delta T = \rho \cdot V \cdot c \cdot \Delta T = 2,4 \cdot 10^9 \frac{l}{d} \cdot 1 \frac{kg}{l} \cdot 4,187 \frac{kJ}{kg \cdot K} \cdot (60^\circ C - 10^\circ C) \cdot \frac{1h}{3600s} = 139,57 \frac{GWh}{d}$$

The needed **annual energy** follows from the above to:

50.9 TWh

For comparison:

State of the art of the electric hot water generation, /ISI 2002/

15 TWh

Final energy consumption for hot water of households, /VDEW 2006/

87.9 TWh

Electric hot water stores use nearly 100 % of the electricity for heating up the water. The main reason for losses is the heat transfer through the thermal insulation (also outgoing dripping water because of thermal expansion). Thus the efficiency of the electric hot water stores is

$$\eta = \frac{E_{el}}{Q_{th}} \approx 100\%$$

The electricity needed for generating the hot water consequently is about

$$E_{el} = Q_{th} = 139,6 \frac{GWh}{d}$$

If it is furthermore assumed that a 30-litres hot water store needs approximately **one hour for heating up the water from 10°C up to 60°C**, then the needed electric power is

$$P = \frac{E_{el}}{t} = \frac{139,6GWh}{1h} = 139,6GW$$

With the assumed amount of 80 millions devices the **average power would be 1.75 kW per device**. This power is slightly below the average power of commercial devices which is typically around **2 kW** /Dimplex 2007/, /Stiebel 2007/.

If runtimes of the uncoordinated single devices are assumed statistically even distributed over the day, the **continuous power is 5.82 GW**, like shown in the blue line in *Figure 3-10*.

By a coordinated operation all storages could be charged at the same time. The resulting potential is shown in the red line in *Figure 3-10*.

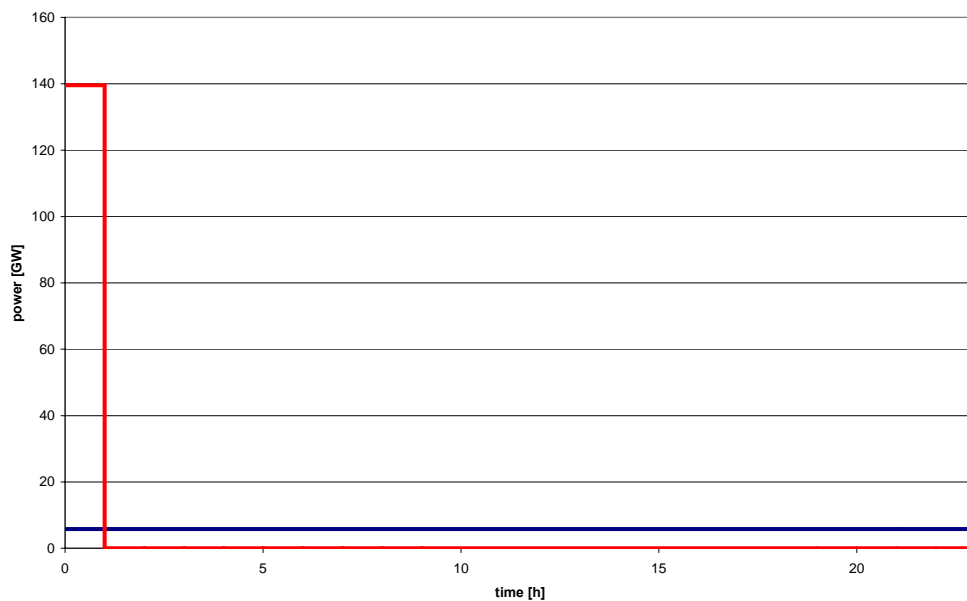

Figure 3-10: Future control potential of electric hot water stores -I

By a coordinated operation a negative **control potential of 139.57 GW** can be provided **every day for one hour**.

A coordination of the electric hot water stores also offers the possibility to arrange the daily needed energy of 139.6 GWh according to requirements over the day.

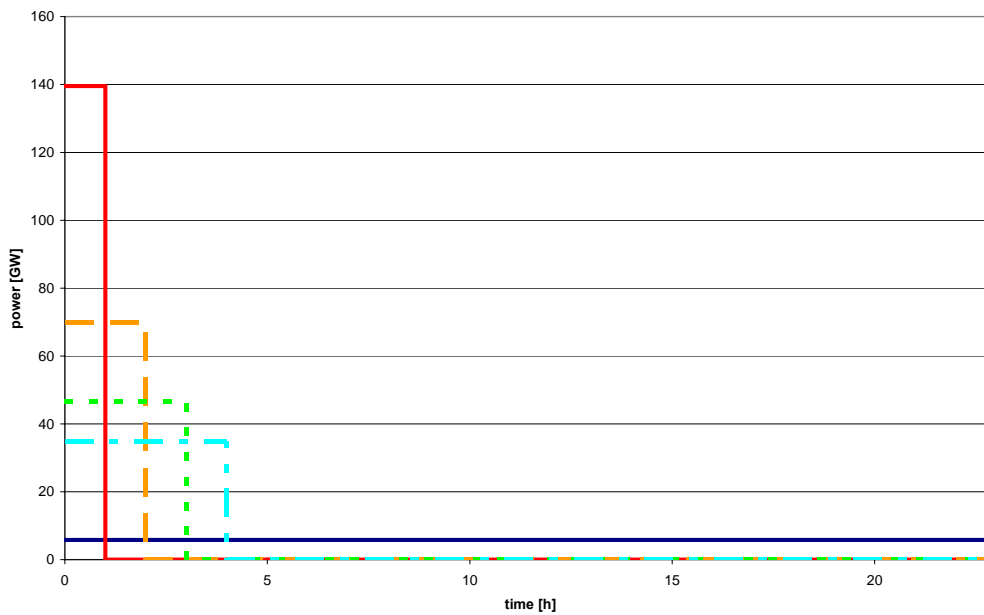

Figure 3-11: Future control potential of electric hot water stores -II

Therefore there are several possibilities for balancing. For instance:

139.6 GW	for	1 hour
69.8 GW	for	2 hours
46.5 GW	for	3 hours
34.9 GW	for	4 hours
27.9 GW	for	5 hours
...		...
17.5 GW	for	8 hours

The possibility for 3 days storing would allow 3 times 140 GWh and also 17.5 GW a whole day long or about 8 GW for two days (wind capacity Germany < 20 GW in the beginning of 2007).

Storage types

For the realization of this potential the most appropriate storage type has to be chosen.

Hot water tanks can be distinguished in three categories:

- The first one is essential for the comfort: the **hot water tank for domestic hot water**.
- The second is a **storage tank for space heating**, the so-called buffer storage tanks which store the energy for the heating system.
- The third type of storage tanks are **combined systems**. Both the energy for the domestic hot water and the energy for heating appliances are stored within this type of storage tank.

The market shares of these types are shown in Table 3-3.

Table 3-3: Market share of different hot water tanks /BdEv-b/

Storage type	Market share %
Hot water tanks	75
Buffer storage tanks	5
Combisystems	20

A combisystem has several advantages. It is cheaper to buy a combisystem instead of two storage tanks for domestic hot water and for space heating. One tank has lower heat losses because of the smaller surface area, requires less space. Already now the market share of combisystems is increasing, /Solid2007/. Combisystems will be the best choice in the future.

Additionally to the mentioned advantages of the combisystems another advantage for balancing potential can be found. Since the combisystems are storing both, the energy for domestic hot water and the energy for space heating, the resulting balancing potential is increasing. The electric generation of hot water would be also able to **provide energy for the heating system**.

The size of combisystems is at today's state of the art limited due to the fact that they need to be transported to its location. The tanks have to fit through normal doors, which is a fact that limits the size /IBS/. The assumptions for the storage size are: 200 liters for domestic hot water and 600 liters for space heating,

3.5 Cooling

Another huge potential lies in the food industry and in the whole food production chain and life cycle:

In Germany 66 TWh/a of electricity are needed for cooling, corresponding to 14 % of the electricity demand and 7.6 GW average power. 26 TWh are needed for freezers and refrigerators in households (3 GW average power) and 13 TWh for supermarkets (1.5 GW). Ice storages can be used to shift electricity consumption in the industry, as latent heat storages, with a lower space heat demand. Full loaded freezers and refrigerators can be cooled down some degree more for delivering negative balancing power and can then warm up for positive balancing power (as not operating), /IS 2005/.

3.6 Co-generation

On the generation side there are motor CHP, i.e. Diesel- and gas engines, Stirling machines and there are some few fuel cells. The principle is always to **use** both energies of this "combined generation" of power and heat. If a certain amount of heat is wasted – depending on the single system – the advantage in efficiency is getting lost compared with "traditional" separated generation.

There are technical differences in the energy conversion like described in the respective subchapters. Main distinctions for an assessment of technical differences are the **electric efficiency, the power-heat ratio and by this the total efficiency**. Power has a higher value so a high power-heat ratio is wanted.

The present potential for balancing wind energy stems from Diesel and Gas Motor CHP of smaller plants and of steam or gas turbines or combined gas and steam cycles. In the future (2020) fuel cells and other techniques might as well play a role for combined heat and power.

Scenarios for the future have to consider the overall efficiency, the power-heat ratio, the installed wind power and CHP capacity, the heat demand type (e.g. regarding insulation standard of buildings) and the yearly distribution.

3.6.1 Heat Demand Scenarios

Heating energy is the main design parameter for cogeneration. The question is what happens when in future heat demand will be reduced by insulation measures on buildings is answered by two scenarios for the cogeneration side. The investigations shall give an answer to the question if and how far a future new-design differs from today's.

Common Assumptions for the two scenarios

- Space heat demand is sinking from a standard level of 200 kWh/m²a (per m² living area) = low standard without insulation
- down to 40 kWh/m²a = high standard of low energy houses
- The simulation is done by a degree day calculation with hourly mean temperature values, a reduction of the start temperature for heating and a reduced u-value

Scenario 1: Sinking Heat Energy Consumption with Different Insulation Standards

The scenario **Sinking Heat Energy Consumption** (see *Figure 3-12*) compares a district heating system before and after a drastic optimization of heat transmission of buildings.

In practise the assumption means that a district heating system keeps its size, i.e. its costumers, but heat demand is drastically optimized, i.e. reduced by insulation measures:

- The ratio nominal thermal capacity of the turbine cogeneration unit in relation to the heat demand peak
- and the characteristic of the annual load duration curve is changing by the assumptions
- Domestic hot water demand is assumed to remain constant

The operation of micro gas turbines, dimensioned in two different sizes with 20 % and 35 % of the maximum heating power demand (including heating and domestic hot water) is shown in the annual load duration curve below.

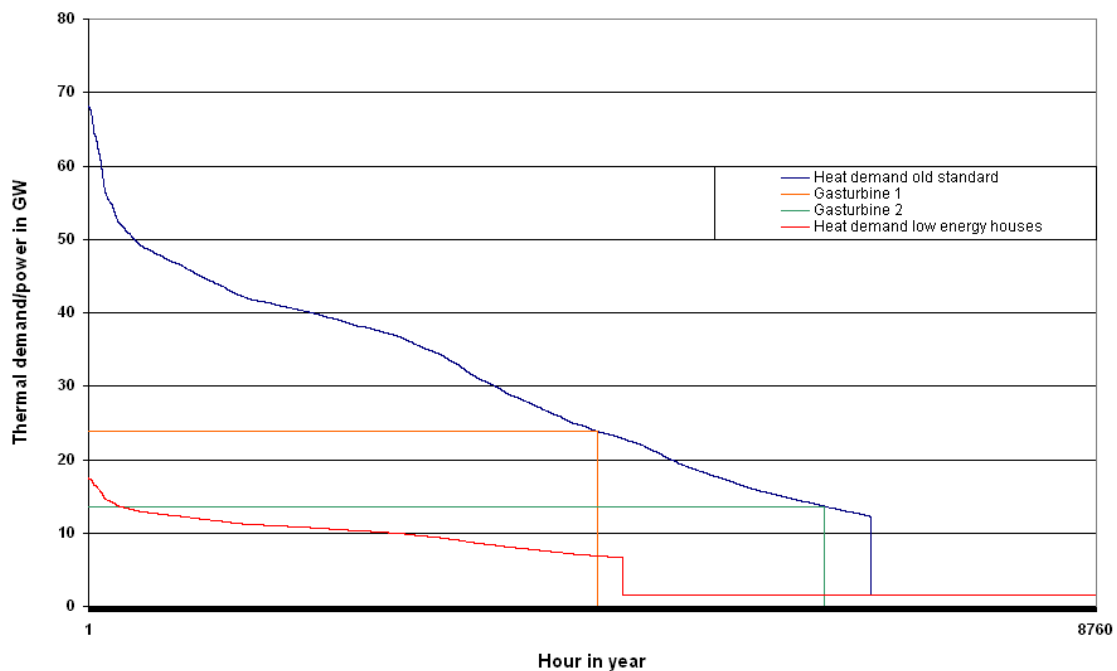

Figure 3-12: Annual heat load curves; standard (blue) and low energy houses (red) with heat production of micro gas turbines; assuming the same number of flats

Influence on balancing capabilities:

- Heating period is reduced from a duration of nearly 7.000 h/a down to 4.700 h/a
- Heating power is sinking from by a factor 3.8.
- The design with 35 % thermal capacity of the units compared to the heat demand peak in present state leads to an oversized turbine for the future design from the thermal point of view, while the 20 % fits well, leading to a Danish Design, see /D2.2/
- The 20 % design leads to a Danish design with CHP thermal capacity equal to the heat demand peak.

Scenario 2: Equal Heat Energy Demand with Different Insulation Standards

A second scenario compares the influence of heat demand types from different insulation standards on the design with a consumption of an equal amount of heat energy. This is the opposite assumption to that in the **Sinking Heat Energy Demand scenario**, in which heating energy is reduced.

In practise the assumption means that the district heating system is comparable in respect of consumed energy, but it is different regarding insulation standard. This could be a completely new design for Low Energy Houses or it can be interpreted as an existing district heating system in which insulation measures are performed and where in the same period the number of supplied houses is extended.

Assumptions

- Equal energy demand
- Domestic hot water demand is assumed as rising, which is a consequence of the energy assumption: there must be a higher amount of low energy houses, living area and persons respectively
- The ratio nominal thermal capacity of the turbine cogeneration unit in relation to the heat demand peak
- and the characteristic of the annual load duration curve is changing only little by the assumptions

Hot water therefore plays a much more important role, relatively to the whole consumption, in new houses with high insulation standard than in houses without thermal insulation.

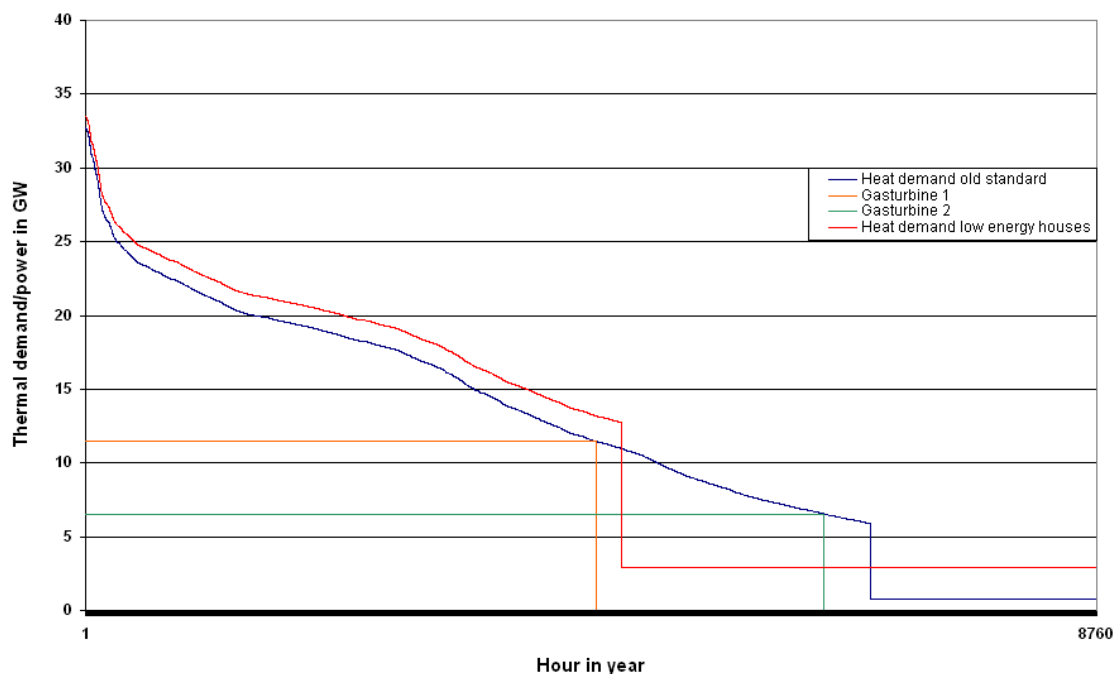

Figure 3-13: Annual heat load curves standard (blue) and low energy houses (red) with gas turbine heat production and the same yearly heating energy demand

Influence on balancing capabilities:

- Heating period is reduced from a duration of nearly 7.000 h/a down to 4.700 h/a
- Domestic hot water plays a more important role leading to a higher base load
- The main difference is the summer and temperatures between the two different start temperatures for heating (12 to 15°C)
- Heating power in winter is slightly different
- For the design with 35 % thermal capacity of the units compared to the heat demand peak in present state, a slight improvement in operating hours can be achieved (longer horizontal orange line, may touch the red line)
- In contrary to this the 20 % design would allow less operating hours (shorter horizontal green line, may touch the red line)

- With a big heat store, both designs are suitable, but in an efficient Danish Design thermal capacity would have to be increased, see /DESIRE D2.2 2006/

3.6.2 Trigeneration and Cooling

The use of heat for cold production allows a higher production in summer. Buildings with cooling demand in summer, e.g. under Spanish conditions need only slightly more heat than before, where the summer heat demand stems from domestic hot water, (see chapter trigeneration).

3.7 Scenario 2020

3.7.1 Assumptions

Balancing ability is analyzed in four scenarios. The basic inputs of the scenario are the electricity demand, the electricity production and the heat demand.

Electricity demand

The aim is not only to balance wind power fluctuations, but rather the fluctuations which arise by wind power production together with the electric load profile. The following figure shows the assumed electric load profile of Germany.

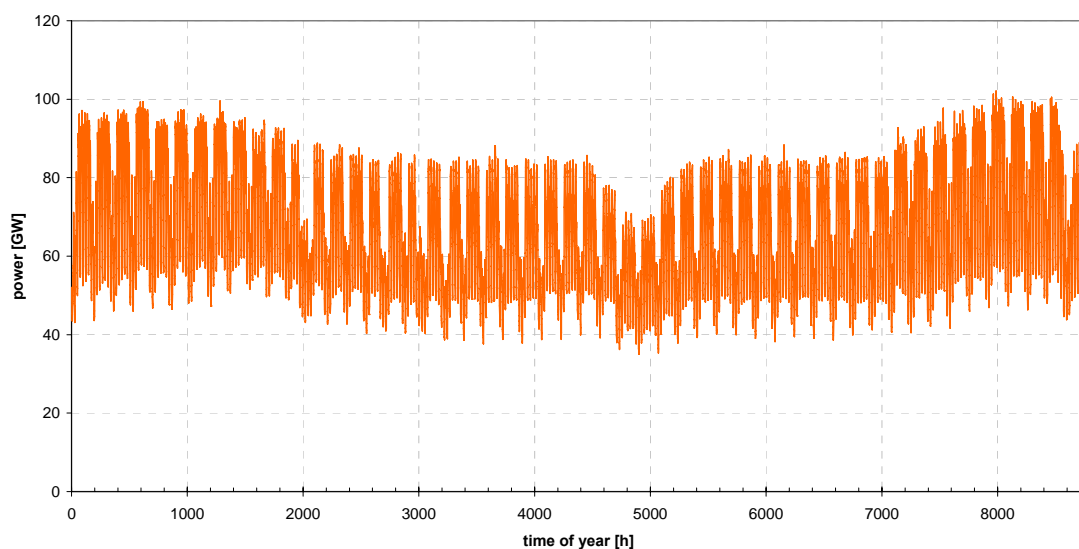

Figure 3-14: Assumed electric load profile for Germany

This load profile is assumed to be the same for all four scenarios.

Electricity production

The **Proportion of wind power production** is the next main input. Wind power is assumed to be much higher in the scenarios than in the year 2004. In 2004 the wind energy contribution on the whole electricity generation in Germany was 4 %.

This parameter is varied in the scenarios from **25%** (in the scenarios further called “low wind”) up to **50%** (“high wind”) **of the whole electricity production**. The profile for the case of “low wind” is shown in Figure 3-15: .

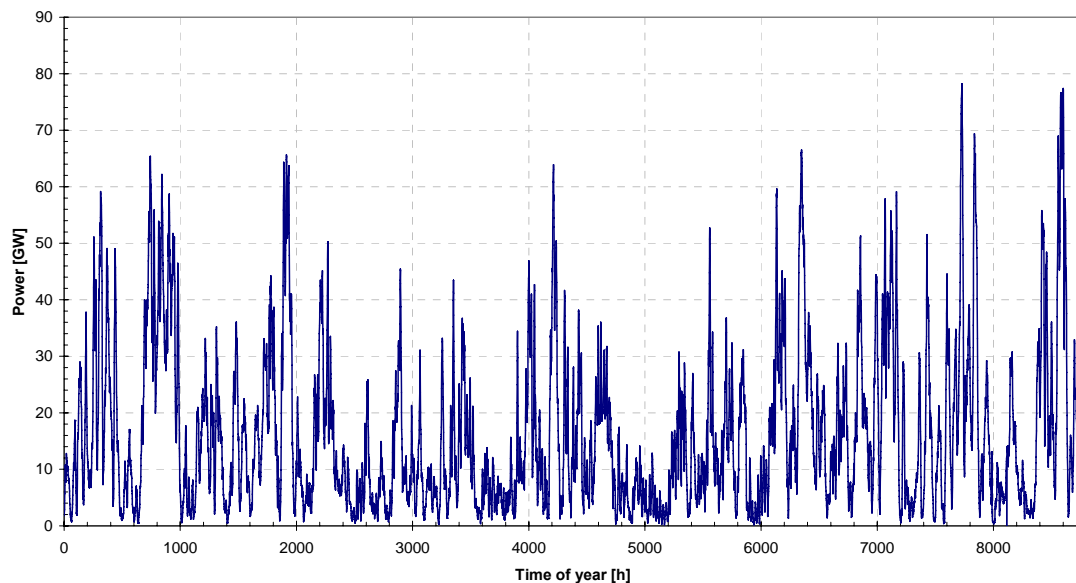

Figure 3-15: Wind profile at 25%

Additionally to the wind power production a base load production of conventional plants is assumed. This parameter has an important influence on balancing ability. For the scenarios with a wind power proportion of 25 %, a **constant base load of 35 GW** is assumed. This amount is adapted to the assumed electric load profile, which has a minimum at 35 GW. For the scenarios with 50 % wind proportion a lower base load of **25 GW** is assumed, because the higher wind power share needs less additional power.

Heat demand

In Germany there are about 36 millions flats. Nearly 5 millions flats are supplied by district heating. Thereof 2 million are considered as flexible CHP. The remaining 31 millions flats are heated with a trivalent system (50 %) of CHP, electric heaters and fuel fired boiler. The rest (50 %) is supplied by a bivalent system of electric heaters and fuel fired boiler.

The heat demand is considered as with a temperature-dependent part (space heating) and a temperature-independent part (hot water). For the temperature-independent part all scenarios assume, that in 2020 all households have a hot water demand of 30 liters per day and person, while having an average floor space of 89.4 m²/DESTATIS/.

The space heat demand is a parameter which is varied. It differs between an energy consumption for space heating of 60kWh/m²a (in the scenarios further called “low heat demand”) to an energy consumption for space heating of 200kWh/m²a (“high heat demand”).

The profile for the “low heat demand” is shown in Figure 3-16: .

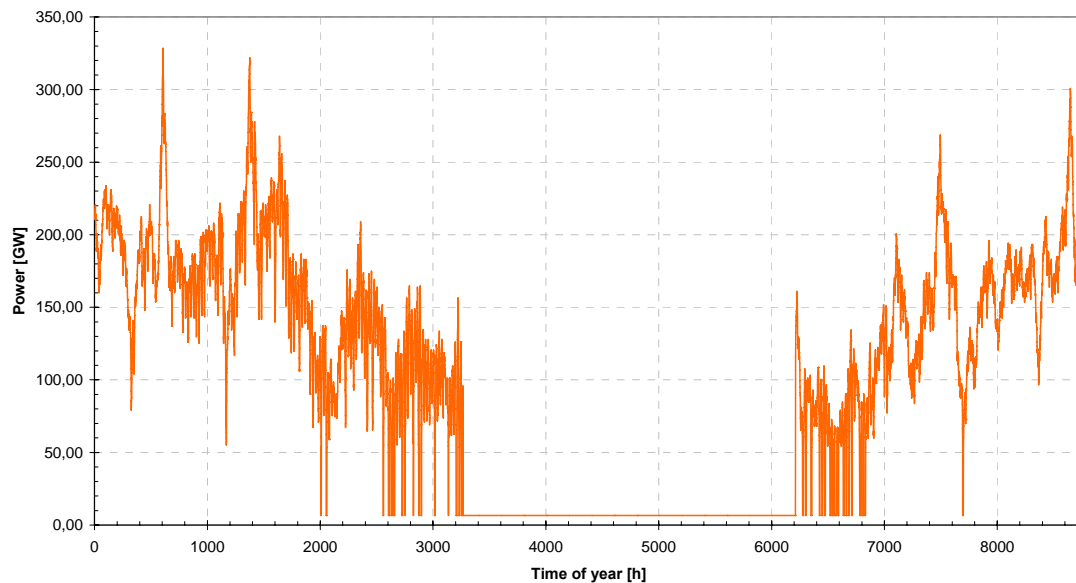

Figure 3-16: Heat demand profile

The case of the “high heat demand” represents today’s state of the art. In the case of “low heat demand” it is assumed that buildings have reached the state of low energy houses. This scenario assumes that energy saving becomes an important political goal, so that this is realized by governmental subsidies, laws and other incentives.

Additionally to the heat demand of buildings a part of the heat demand of public and industrial buildings is taken into account. The overall heat demand of the buildings is therefore assumed to be 40 % higher.

Balancing mechanisms

In the scenarios a balancing is achieved through two mechanisms:

The Demand Side Management is supposed to cut off high wind power production peaks; CHP units fill the power gaps at low wind energy production.

Demand Side Management

A possibility to balance wind energy is to shift operation of electric consumers from times with little to times with high wind power contribution, as well as from times with high electricity demand to times with low consumption.

Applications that are used in today’s Demand Side Management are electric heating devices like night storage heating facilities, heat pumps and heating rods. A future electric heating system might consist of hot water tanks and heat pumps

Hot water tanks

In the scenario it is assumed that every flat has a combitank with 200 liters for domestic hot water and 600 liters for space heating. Each of these tanks can additionally to the normal heating system be charged by an electrical heating rod with a heating power of 5 kW. A flat in Germany consists normally of 2 persons. The scenario therefore supposes that the hot water demand can be stored for three days. Therefore $7,2 \cdot 10^9$ liters hot water can be stored. This amount equals exactly three times the daily hot water demand stated before.

Heat pumps

For a better use of energy **heat pumps** are a better choice. This reduces the average electricity consumption in the order of a factor 3 to 4, depending on the available temperature level and technique.

For the use of efficient heat- pumps it is assumed, that the total amount of approximately one Million is installed till 2020 /BWP2007/, with a total average power of 6 kW for space heating and domestic hot water. The other heating devices have like already explained a 5 kW heating rod additionally to a gas or fuel oil boiler or CHP unit installed.

Night storage heating facilities

The already existing NSHF are not considered for the future control potential, because they are already included in the load profile and provide flexibility to the electricity companies.

CHP

Opposite to electric heaters the CHP units should fill the gaps of low wind power production. The CHP-plants therefore fulfill a new task. Instead of running uncoordinated as base load they provide balancing power. This leads to lower operating hours, but also to an effective balancing instrument together with an efficient heat generation.

The total CHP capacity for all scenarios is assumed to be 25 GW. This is only a small increase in the capacity since today already 20 GW are installed, but it refers to district heating plants, while industrial plants are not considered here. The reason why there is such a small increase is explained later in the results.

For a good flexibility the CHP-plants have their own heat storage facility. The heat storage capacity is assumed to be designed to store half of the heat of the coldest day.

3.7.2 Calculations

A schematic structure of the calculations is shown in the following figure.

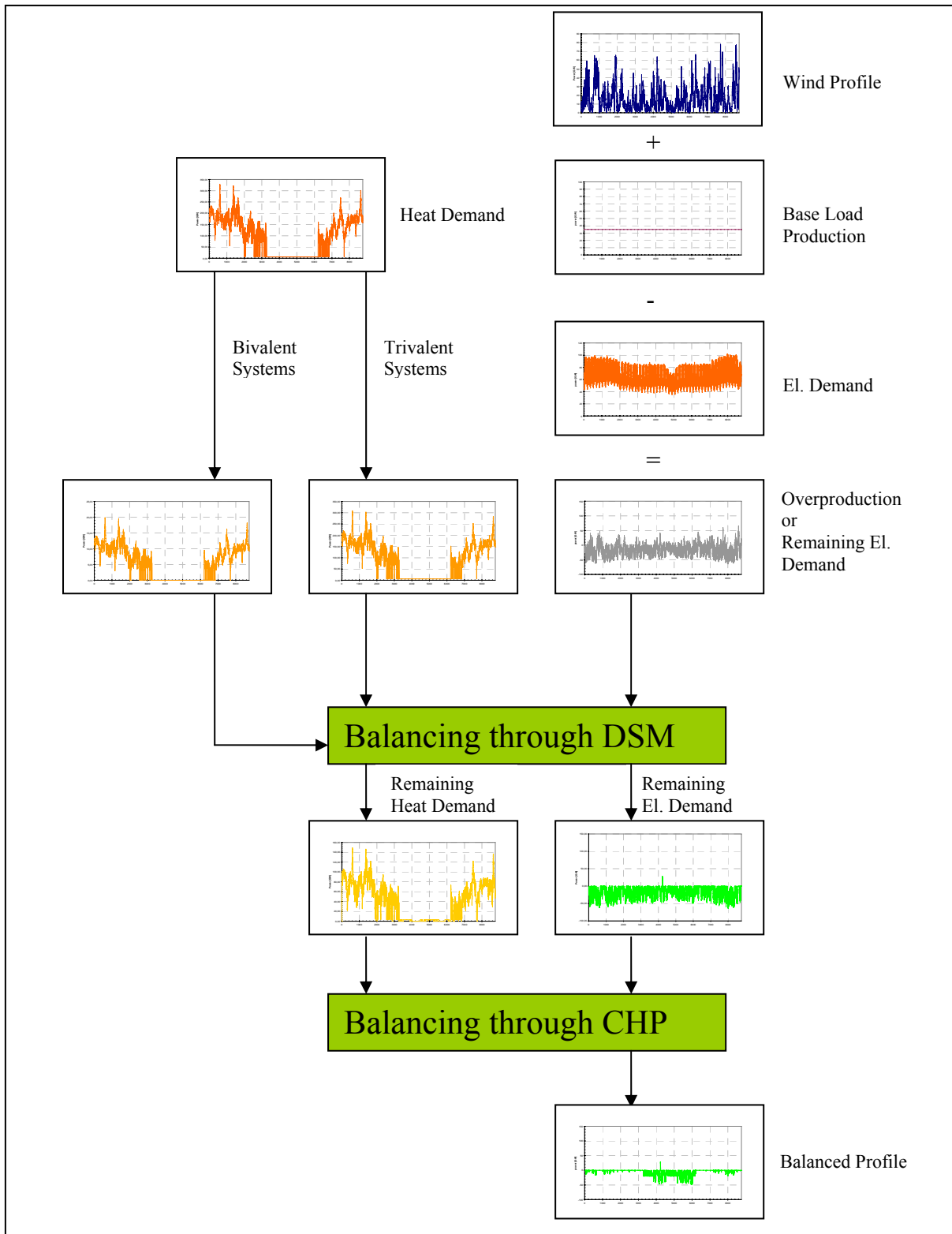

Figure 3-17: Schematic structure of the calculations

Wind power and base load production are added and consumption is subtracted, which leads to the assumed electric load profile with overproduction or remaining electric demand, see Figure 3-18: .

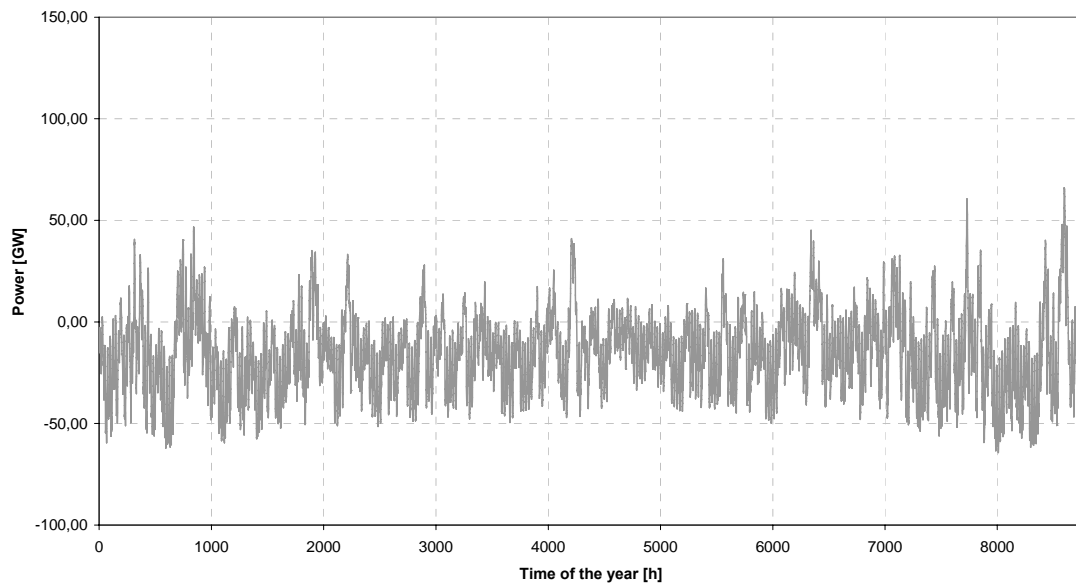

Figure 3-18: Profile of overproduction respectively remaining electric demand

At the time when the profile is in the positive range the electric power generation by wind power and base load production is greater than the demand. The surplus of energy shall be cut by Demand Side Management.

When the profile is in the negative range the electric power generation is smaller than the demand. These gaps have to be filled by using CHP-plants.

The other main input for the calculations besides the electric profile is the heat demand. The overall heat demand is like already mentioned subdivided in the heat demands for bivalent and trivalent systems. This heat demand and the described electric profile are the inputs for calculating balancing by Demand Side Management and CHP.

A flowchart for the calculations of balancing through Demand Side Management is shown in the following figure.

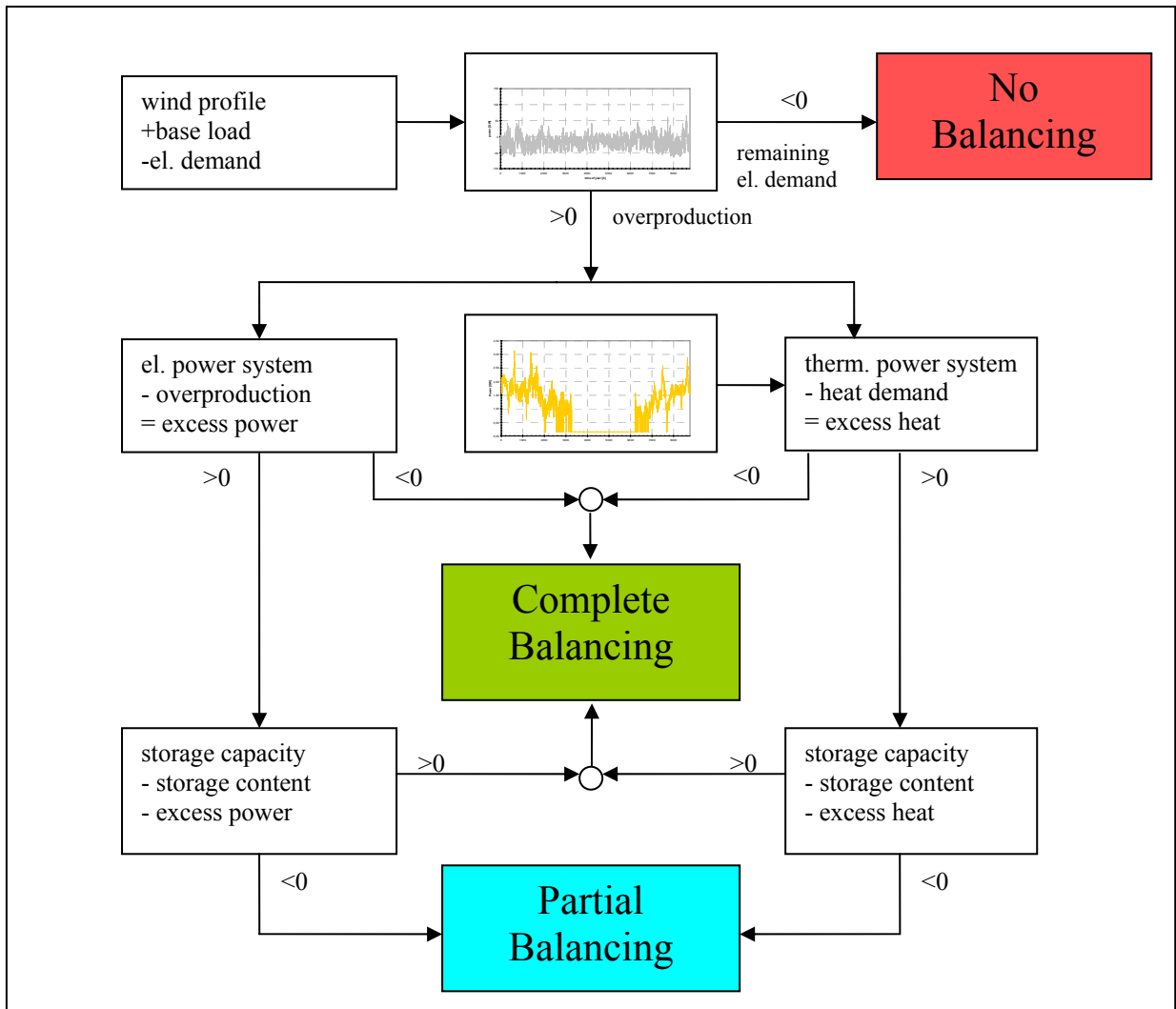

Figure 3-19: Structure of the calculations for balancing through Demand Side Management

In the first step it is determined whether we have a surplus or a lack of energy. Only with a spill-over the Demand Side Management can make a contribution for the balancing. So with a lack of energy there is no balancing effect through the DSM and the profile is unchanged.

The next step is divided in two parts. On the one side the needed electric power is compared to the power of the electric heating system. On the other side a comparison of the thermal power with the heat demand takes place. If the power of the system is not enough to balance the whole overproduction but enough to cover the heat demand then a balancing, which is in the structure called complete balancing, takes place. This means that the whole power of the system can be used for the balancing.

If one of these requirements is not fulfilled then it has to be determined whether the excess power can be used to fill the storage. When this is the case then again the whole power can be used for balancing. If the excess energy, which has to be stored, excels the storage capacity, then only a part of the system power can be used. This is the case which is called partial balancing in the structure.

The results of the calculations for balancing through DSM are, like shown in figure 3-17, a remaining heat demand and a new profile for the remaining electric demand. The remaining

heat demand is added to the heat demand for the bivalent systems. These profiles are the input for calculating balancing through CHP, which is similar to balancing through DSM only with an opposite sign.

3.7.3 Results

The results are divided into four scenarios. The following table gives an overview on these scenarios.

Table 3-4: Overview on the scenarios

Heat demand:	Building stock 200 kWh/m ² a	Low energy houses 60 kWh/m ² a
Wind proportion 25%	Scenario I: low wind, high heat demand	Scenario III: low wind; low heat demand
Wind proportion 50%	Scenario II: high wind, high heat demand	Scenario IV: high wind, low heat demand

For a better comparison most of the input parameters are the same for all scenarios. Changing parameters are wind power production and heat demand. But also base load production is adapted to the wind power capacity. *Table 3-5:* provides an overview of the input parameters of the scenarios.

Table 3-5: Inputs for the scenarios

		Scenario I	Scenario II	Scenario III	Scenario IV
Electricity demand		Figure 3-18			
Electricity production					
	Wind power proportion	25%	50%	25%	50%
	Base load	35 GW	25 GW	35 GW	25GW
Heat demand		200 kWh/m ² a	200 kWh/m ² a	60 kWh/m ² a	60 kWh/m ² a
Balancing value					
	DSM	0 GW			
	CHP winter	0 GW			
	CHP summer	-20 GW			
CHP capacity		25 GW			
Power of the heating rods		5 kW			
Power of the heat pumps		6 kW			

These parameters are chosen in that way that the scenarios fulfil an important boundary condition. The **operating hours of the CHP-units are supposed to be in a range of normal operation**. Otherwise with operating hours below 3000 h an economical operation would not be possible.

Scenario I: low wind, high heat demand

This scenario is the most conservative of the four scenarios. The proportion of wind power is increased up to 25% and the heat demand is kept at today's level with 200 kWh/m²a.

Balancing should be the easiest case of the four scenarios. The fluctuations of wind power production are lower than at 50 % wind proportion and the high heat demand provides the needed flexibility. *Figure 3-20* shows the profile with balancing by Demand Side Management.

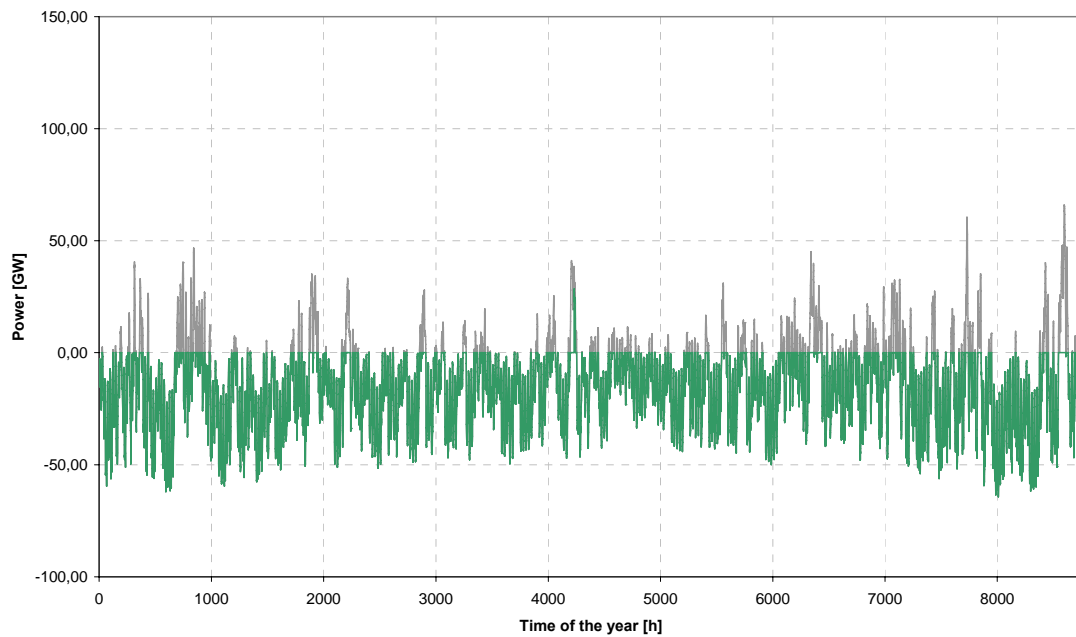

Figure 3-20: Scenario I: Balanced with contribution of Demand Side Management

Balancing by Demand Side Management fulfils the role as a balancing mechanism. There is only one peak left during the whole year. The peak left is shown together with the storage content in Figure 3-21.

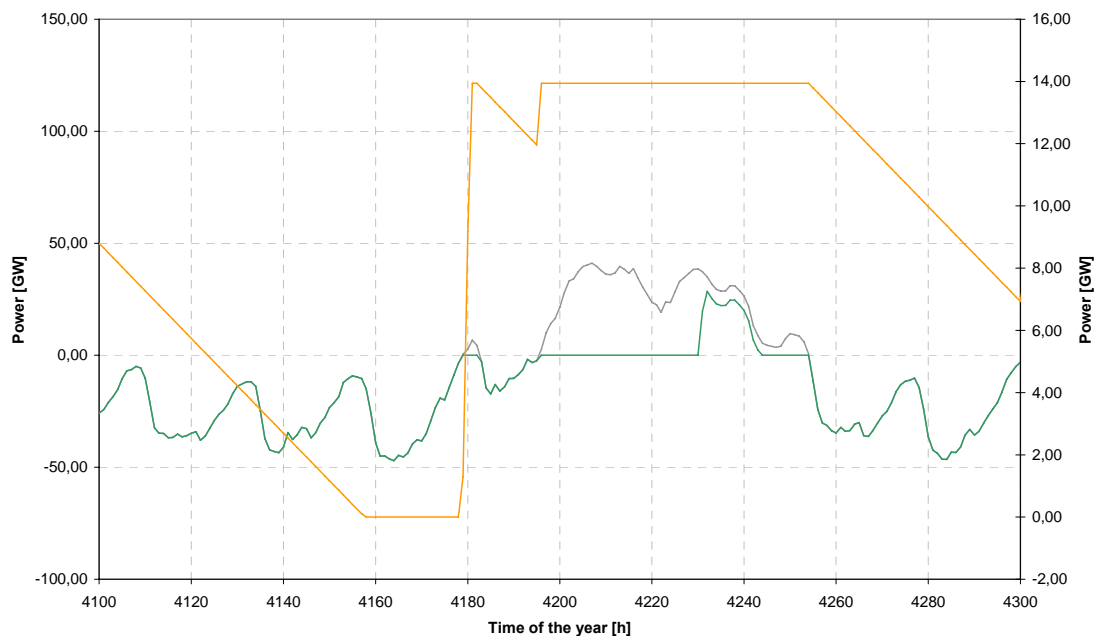

Figure 3-21: Scenario I: Balanced with contribution of Demand Side Management –II

The single peak, which can not be balanced, is during summer time. DSM is, like CHP-plant operation, linked with the heat demand. Therefore it is reasonable that this **peak occurs in a time with low heat demand**. The original peak reduced, but only hot water demand, is at that

certain point not enough to gain a complete balancing. Normally the heat storage provides the needed flexibility to the electric heating system, but in this case the orange line in *Figure 3-21* reaches the maximum, i.e. the **storage has reached his total capacity at that time**.

The same problem during summer time occurs when balancing with CHP-plants. *Figure 3-22* shows the balanced profile with contribution of DSM and CHP.

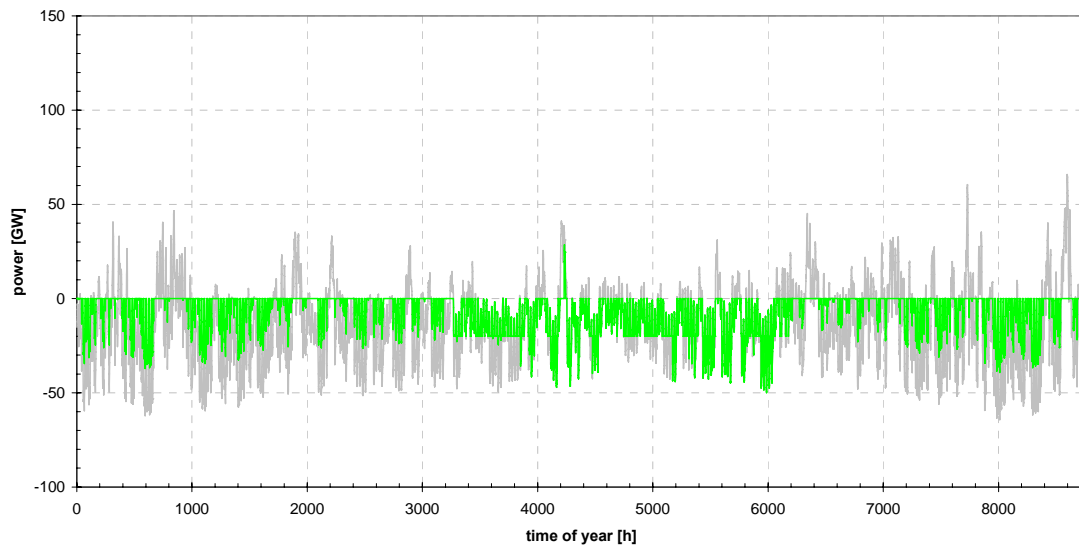

Figure 3-22: Scenario I: Balanced with contribution of Demand Side Management and CHP

The CHP-units fill some of the gaps and covers a high part of the demand, but the boundary conditions do not allow a total balancing. A detailed description of the behaviour of CHP-plants in a shorter period is shown in *Figure 3-23*.

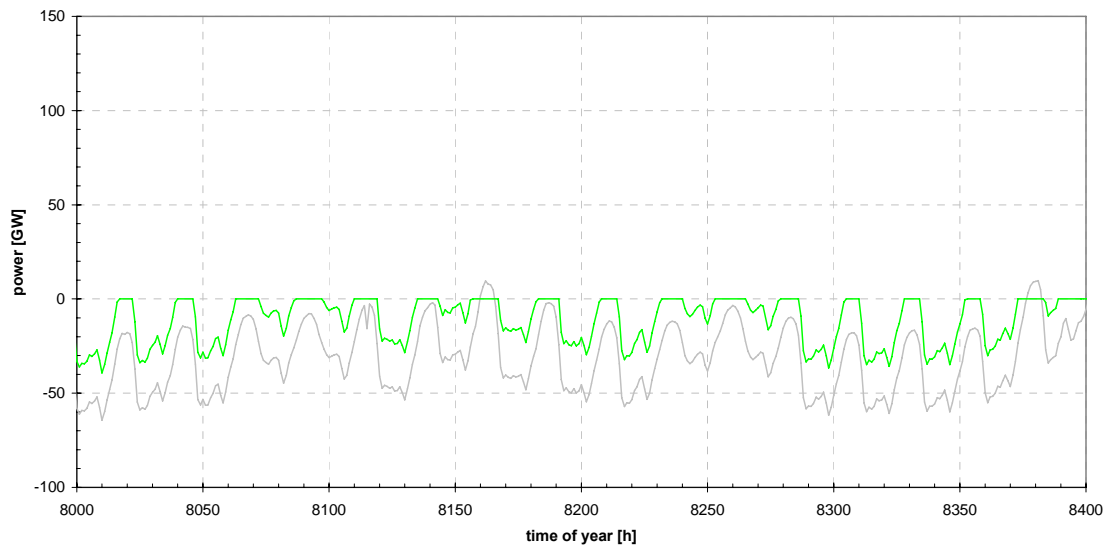

Figure 3-23: Scenario I: Balanced with contribution of Demand Side Management and CHP –II

This figure shows that balancing through CHP is not as worse as it seems in *Figure 3-22*. The CHP-units often even out the fluctuations. At the times when an equilibrium can not be established the CHP are nevertheless operating. CHP-plants achieve 3.5000 operating hours, but **the total CHP-capacity is not enough for balancing the profile in total**. Since the CHP-capacity is 25 GW, it is not possible to balance gaps of around 50 GW.

Scenario II: high wind, high heat demand

In this scenario it is assumed that wind power is extended to a proportion of 50 % of the whole electricity production. The heat demand is kept at the high level of 200 kWh/m²a. As already explained before base load is, reduced from 35 GW to 25 GW, because of the high wind proportion. Nevertheless peaks, as well as the gaps, are much greater than in the case of “low wind”. The DSM for example has to be able to cut off peaks of 125 GW in this case.

Figure 3-24 shows the results for balancing through DSM.

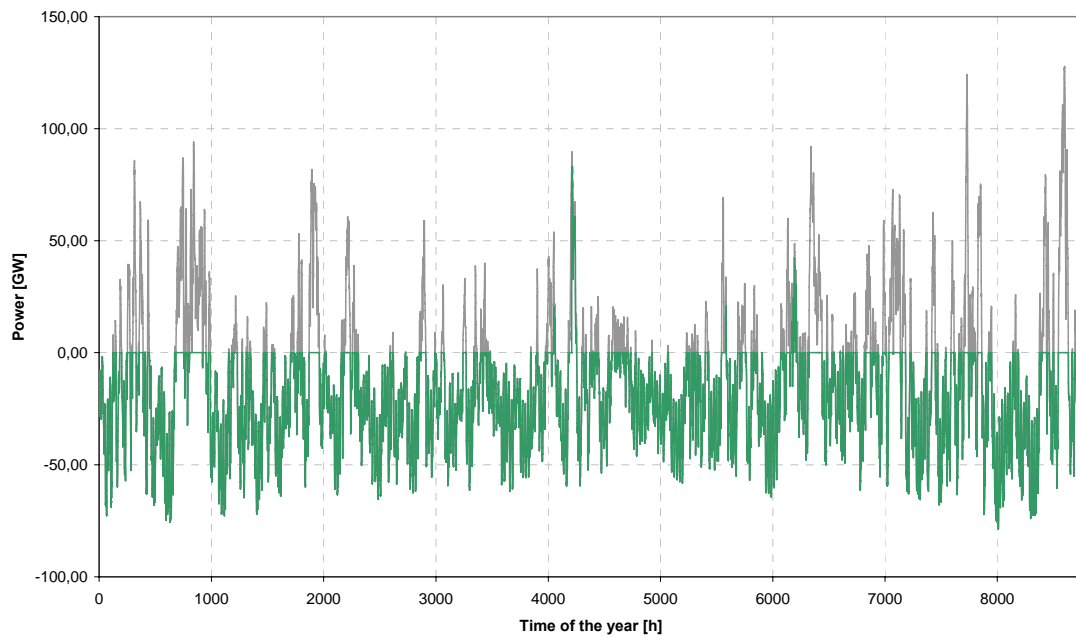

Figure 3-24: Scenario II: Balanced with contribution of Demand Side Management

There are still only some peaks left and these **peaks are again at times with low heat demands and a completely filled heat store.**

Nevertheless once again it is impressive how the DSM is able to cut off such high peaks. Especially at the end of the year there are **two peaks with maxima of around 125 GW which are completely cut off.**

Balancing with contribution of DSM and CHP is shown in Figure 3-25. Since the CHP-capacity is unchanged at 25 GW the principle results are similar to the first scenario.

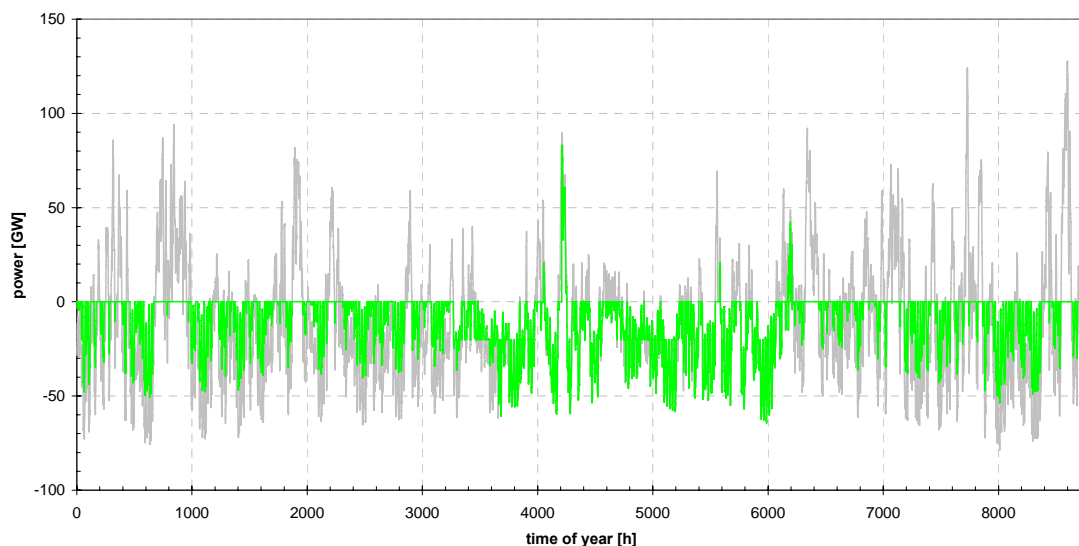

Figure 3-25: Scenario II: Balanced with contribution of Demand Side Management and CHP

The CHP-units have 3443 operating hours and take over a main share in balancing, but a total balancing can again not be reached. The explanation for this can again be found in **the maximum CHP-capacity which is not enough to balance the gaps** which are sometimes twice or triple as much.

Scenario III: low wind; low heat demand

This scenario assumes that wind power has a proportion of 25 % like in scenario I. The heat demand is drastically reduced in this scenario.

The results for balancing through DSM are shown in *Figure 3-26*.

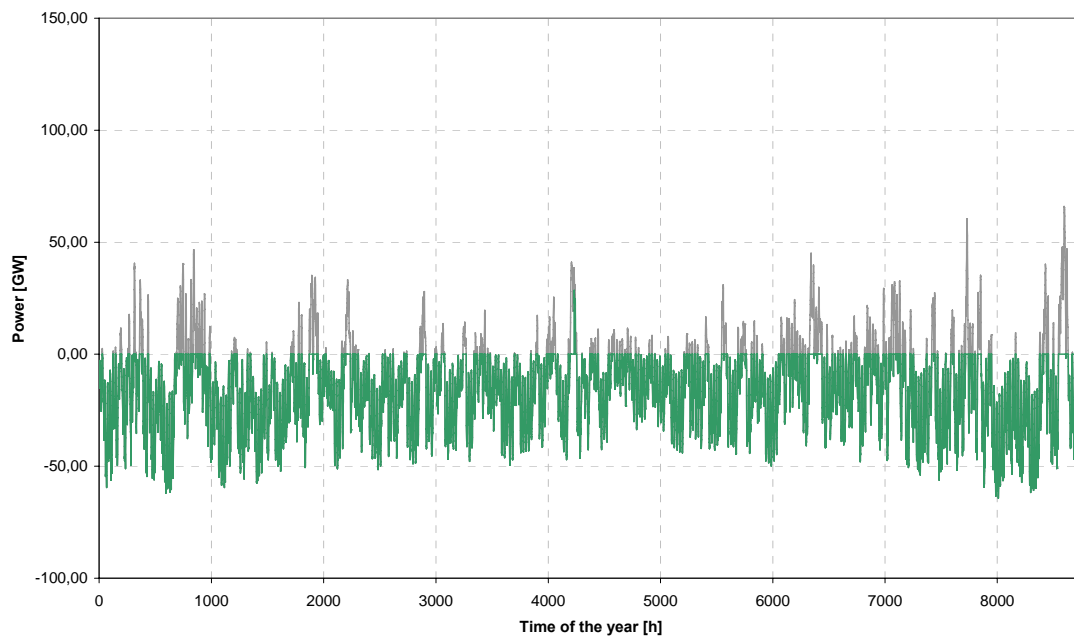

Figure 3-26: Scenario III: Balanced with contribution of Demand Side Management

The results for balancing through DSM are similar to the scenario I. The lower heat demand has nearly no effect to this balancing. This fact can be explained with **the share of the electric heating system on the heat generation**. In scenario I the electric heating system covers less than 3 % of the heat demand of bivalent and trivalent systems. The share of the heating-boiler is therefore around 97 % in the bivalent systems and 69 % in the trivalent systems. In scenario II with the low heat demand **the proportion of electric heating system rises**. It has a share of 8 %, while the share of fuel fired boilers decreases to 92 % in the bivalent systems and to 20 % in the trivalent systems. The share of fuel fired boilers is also affected by the share of CHP-plants.

Figure 3-27 shows the results for balancing through DSM and CHP.

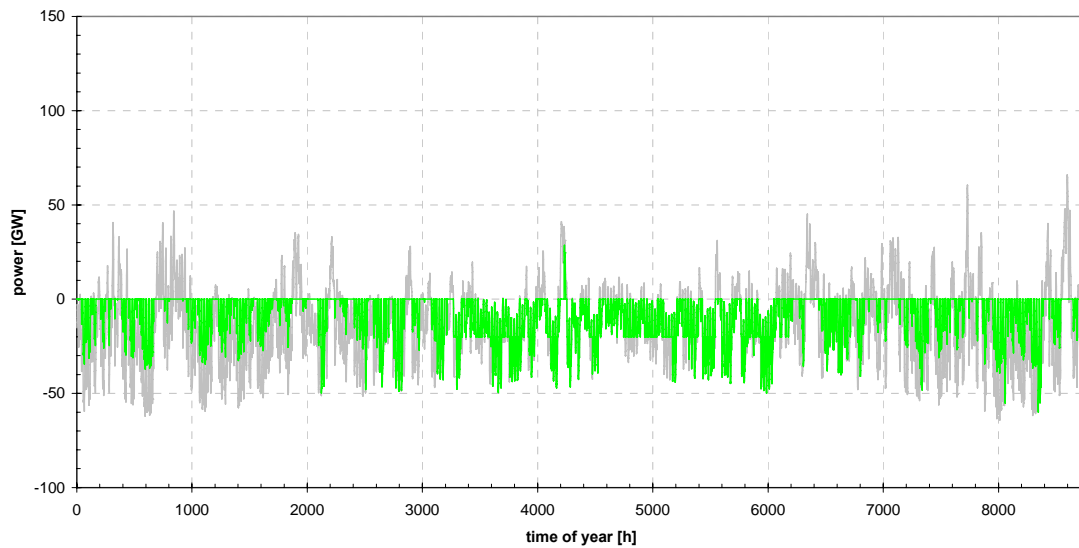

Figure 3-27: Scenario III: Balanced with contribution of Demand Side Management and CHP

As already stated the share of CHP-units on heat generation is drastically increased. Nevertheless a decreasing of the operating hours to 3062 hours takes place because of the lower heat demand. Balancing through DSM and CHP however still shows similar results to the previous scenarios.

Scenario IV: high wind, low heat demand

Scenario IV is the most optimistic. It is assumed that the wind power proportion is increasing up to 50 % and the heat demand is drastically reduced. This scenario is the ecological preferable one, but to achieve a complete balancing is the catchiest of all four scenarios. The high wind power production leads to high peaks and low gaps like in scenario II and the low heat demand results in a low flexibility. The results for balancing through DSM are shown in *Figure 3-28*.

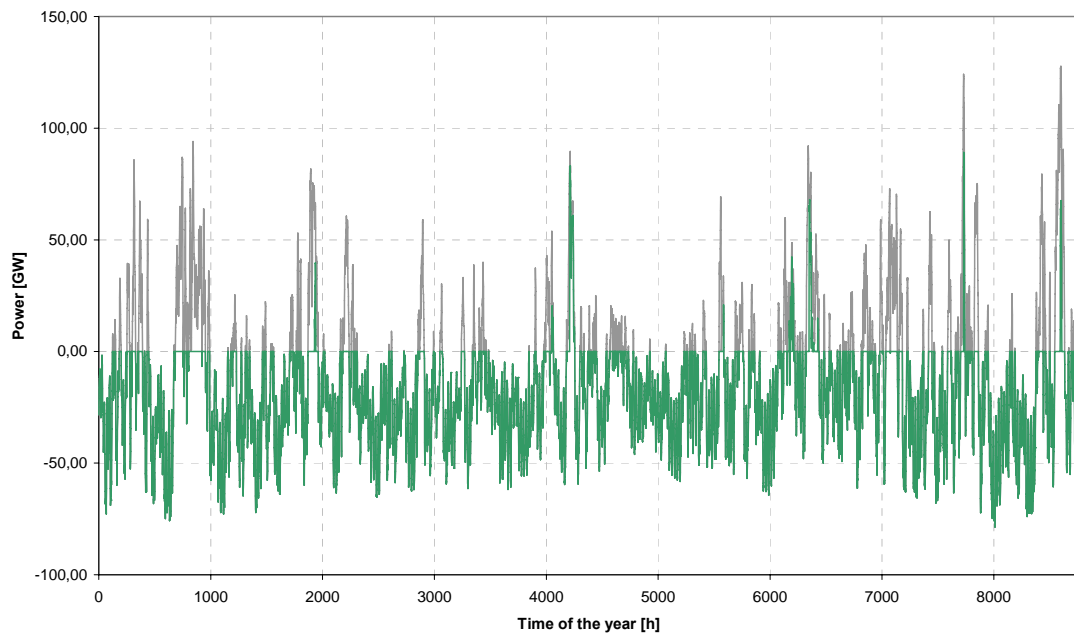

Figure 3-28: Scenario IV: Balanced with contribution of Demand Side Management

Balancing through DSM is a bit worse than in scenario II. The high peaks, which have been cut off in that scenario, are only lowered in this scenario. The **low heat demand is the explanation** for this fact. The same is true for the results of balancing through DSM and CHP which are shown in Figure 3-29.

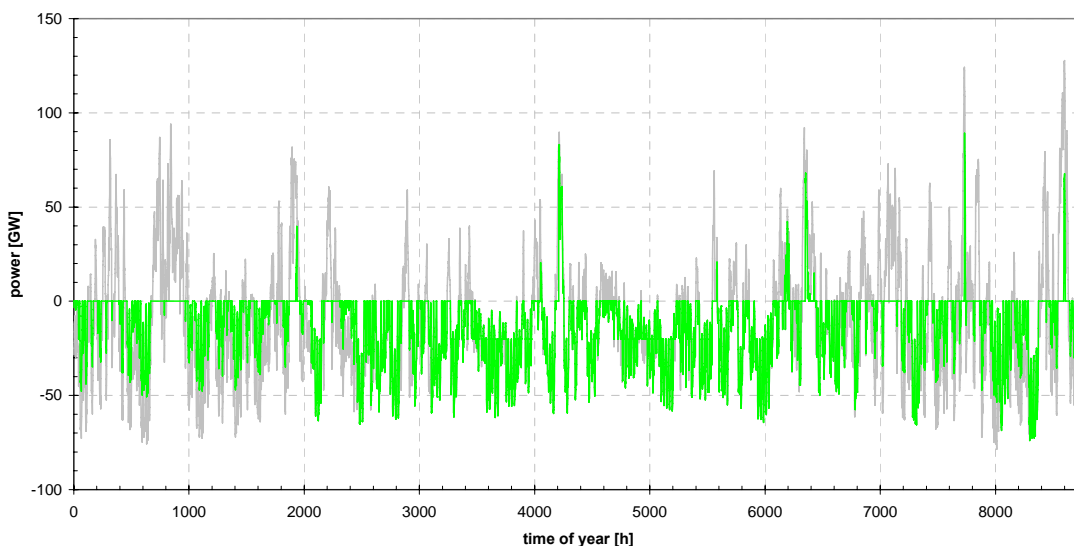

Figure 3-29: Scenario IV: Balanced with contribution of Demand Side Management and CHP

The large gaps can not be filled with the assumed heat demand. The low heat demand and the high fluctuations are leading to only 2454 operating hours for the CHP-units.

3.8 Final assessment

The stated results show clearly that a total balancing in the scenarios can not be achieved. Like further explained below, the problems are more on the side of filling gaps by using CHP-plants than cutting off peaks by using Demand Side Management.

Balancing through Demand Side Management

The shown results make clear that in such an electric heating system, which is assumed in the scenarios, a Demand Side Management has no problems cutting off high wind power production peaks. An example for the effectiveness of the DSM is shown in *Figure 3-30*, which shows a the end of the year in scenario II. Power peaks of around 125 GW are balanced.

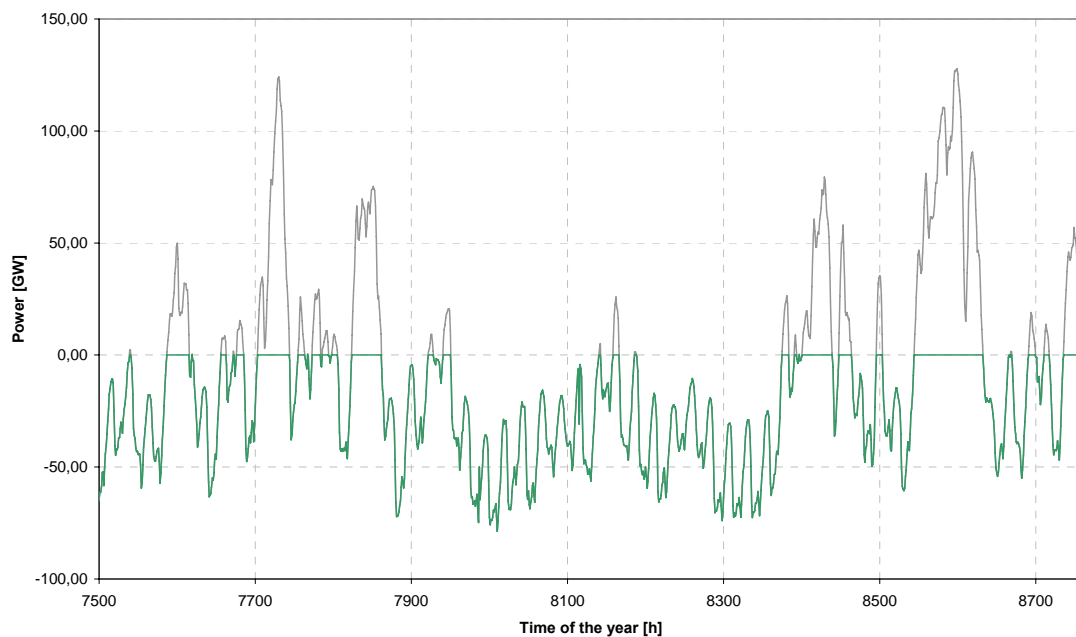

Figure 3-30: Effectiveness of balancing through Demand Side Management

In the cases of “low wind” there is just one peak left while all others have been balanced. But also in the cases of “high wind” there are just some peaks left. These peaks are not really a problem because there are still other balancing measures, which are not included in the scenario. For example the existing night storage heating facilities and the possible contribution of cooling are not applied in the assumed system. Additionally to these mechanisms there are other forms of storing the surplus energy like reverse hydro power pumping storages or in future there might as well be a considerable capacity of compressed air energy storages.

There is no problem with excess wind power, because it could be used somehow (street light during daytime, which is also done today) or even be reduced at the wind power plants itself, but of course the most reasonable possibility to use the high valuable electricity should be applied.

Balancing through CHP

Compared to the Demand Side Management possibilities CHP-plants are also an effective mechanism for balancing, but it is not easy to always achieve the equilibrium, when there are consumption peaks and wind power gaps respectively, even in the scenario with “low wind” and “high heat demand” which offers the “optimal” conditions for balancing by CHP.

A high efficient cogeneration system has to use all of the produced heat, so that in summer operation is reduced in order not to waste the heat, when cogeneration plants should work according to the needs of the electricity grid. It has been demonstrated that cogeneration is most efficient with large heat stores. In future CHP will by that be able to produce as balancing instrument for peak load production, spot markets, manual reserve and possibly – as long as they are in operation - even as primary reserve.

The operation hours will be decreasing, but the product will have a higher value than today, where they are typically used as base load or even heat demand oriented producers. The new tasks will or at least should allow higher incomes with less operating hours. *Figure 3-31:* shows the results for scenario I with an increased CHP capacity.

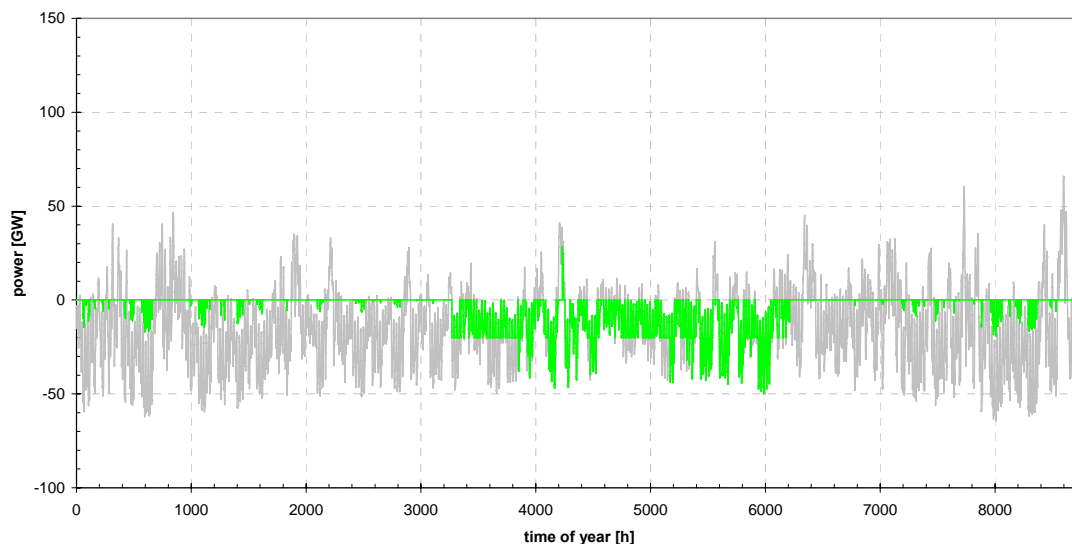

Figure 3-31: Scenario I: Balanced with contribution of Demand Side Management and CHP; increased CHP capacity

The CHP-plants in this case have a capacity of 45 GW and can be used for a partial balancing. The operation hours however are below 2500 hours.

The summer gap could be filled by wasting the produced heat at these certain times like in conventional power plants, but a better solution would be to use other sources like hydro power and make use of strong interconnections within the UCTE area and the neighboring countries in order to even out such unbalances.

The Danish system not only includes big thermal stores, but also a high installed thermal capacity of CHP units, corresponding approximately to the heat demand peak of the supplied system. This is different to the rest of Europe where 30 – 70 % are common.

Even oversized plants (e.g. 120 %) are a good technical solution and with the right boundary conditions considering the valuable delivering of balancing power, this design and operation could be established as an economic solution for balancing the common wind power and consumption electricity profile.

4 Stirling Engines (PE)

4.1 Description

There are obvious reasons for developing a reliable and effective technique for implementing small scale biomass powered cogeneration. In the industrialized countries such a technique would enable optimal use of the biomass potential - in the developing countries it might offer a possibility of production of electricity using the only fuel available.

The steam engine and the Stirling engine offered the first two practical solutions for the conversion of chemically stored energy to mechanical energy.

They formed the basis of the industrial revolution. The latter mainly as stationary installations below 10 kW shaft power.

The Stirling engine works by a very simple principle: A working gas in a closed circuit is moved from the hot section to the cold section and vice versa by a replacement piston. When the gas is being heated a working piston expands the volume and vice versa when the gas is cooled. It is in fact as simple as it sounds to make a small demonstration model of this process. But to make a reliable engine with good efficiency is something else.

Some of the obstacles are:

- to obtain a good thermodynamic efficiency a large difference between the mean temperature of the gas in the hot section and in the cold section is necessary. In practice it should be above 500 K. This requires a so-called regenerator between the two volumes, where heat can be stored intermediately between the strokes. (The heat is stored in the regenerator as the gas moves from the hot section to the cold and regained when it returns). A very careful design of the regenerator and the heat exchangers in the heating and cooling section is needed to make the process work with the necessary speed and effectiveness.
- to avoid very voluminous engines a high pressure of the working gas is needed. In practice pressures of 50 to 100 Bar are common.
- to avoid losses due to the work involved in moving the gas through tubes and heat exchangers gases with very low viscosity must be used. In practice Helium or Hydrogen.
- the combination of gases with high pressure and small molecules causes leakage problems.

During the last 30 years great efforts have been made at several laboratories to overcome these obstacles using computer aided design and advanced material technology. Phillips, General Motors, United Stirling and Ford should be mentioned. Important activities in Japan and New Zealand have also been reported.

The state of the art is in short that efficiencies above 30 % have been reached, but production costs and leakage problems have so far prevented mass production. A Stirling engine for biomass combustion is produced in India with some success, but this system has a low overall efficiency (10 %).

Stirling engines are produced in limited numbers for military use (low noise) and the German company Solo produces generating sets in the 10 kW range for natural gas in small series.

Particularly for production of electricity by combustion of biomass the Stirling engine has obvious advantages. Due to the closed circuit of the active medium in this engine almost any fuel can be used. Unlike the steam engine it does not require specially trained and certified operators for safety reasons.

However, biomass applications arises new obstacles:

- design of an effective Stirling engine given the special conditions: relatively large heating section, relatively low heater temperature.
- design of a furnace with low ash temperature to avoid clinker on the grate and on the heater and to avoid production of aggressive gases which would corrode the heater.
- design of a furnace with an effective combustion air preheater to enable operation with exhaust gases in the range of 800 °C and input air temperatures in the range of 600 °C.

Some experiments to use high efficient Stirling engines designed for oil or gas combustion with biomass have been reported. All with the result of heat exchangers being clogged up and destroyed in a very short time. With two stage combustion (gasification) and filtration of the gas this might work, but it would effect the simplicity and the costs of the complete system negatively.

In Denmark researchers at the Technical University developed a 10 kW Stirling engine with 30 % efficiency in 1993. /1/ and /2/. Based on this design a complete biomass cogeneration system incorporating a wood chip burner and a 35 kW and a 70 kW Stirling engine is currently being developed in cooperation between the Danish Technical University and a number of private companies. The project receives financial support from the Danish Energy Agency and from the TSO, Energinet.dk.

In the following the design and the operational results are given.

Wood chips are fed to a moving grate boiler by screw conveyors. The mechanical parts of this system are standard but the control system is especially developed in order to maintain a very stable temperature on the surface of the heater of the Stirling engine.

On top of the boiler a four cylinder double acting Stirling engine with a specially designed heater is placed 'upside down'. Because of the position of the heater app. 50 % of the heat from the combustion is transferred by radiation. The rest is transferred by convection as the hot flue gas passes the fins of the tubes in the heater. The design temperature of the heater surface is 750 °C. This causes the exhaust to be very hot (770 °C). If this exhaust was entirely used for the production of heat the overall electric efficiency of the system would be rather low despite the high efficiency of the Stirling engine itself. Instead the exhaust it led to an air preheater where it is heat exchanged with the incoming fresh air for the combustion. This causes the combustion air to be 600 °C. The preheated combustion air enables combustion of wet biomass and causes a very fast combustion. In order to keep a constant temperature in the heater a more or less continuous fuel input is used.

The output from the preheater is still 315 °C. In order to obtain a high overall efficiency this output is cooled to app. 110 °C. Further cooling with condensation of the water from the fuel is a possibility.

The Sankey diagram shows that the majority of the heat is produced by the cooling of the Stirling engine. It explains how the electric efficiency of app. 24 % and the heat efficiency of app. 63 % are obtained.

Fig. 0.2 shows the mechanical design of the Stirling engine.

With a four cylinder design no replacement pistons are needed. One cylinder passes the gas on to the next etc. In this design leakage has been avoided by incorporating the generator into the pressurized part of the engine much the same way as the motor is incorporated in a refrigerator compressor.

The engine has a bore of 140 mm and a stroke of 74 mm. The speed of the shaft is 1015 rpm, the working gas is helium and the mean pressure 4 MPa.

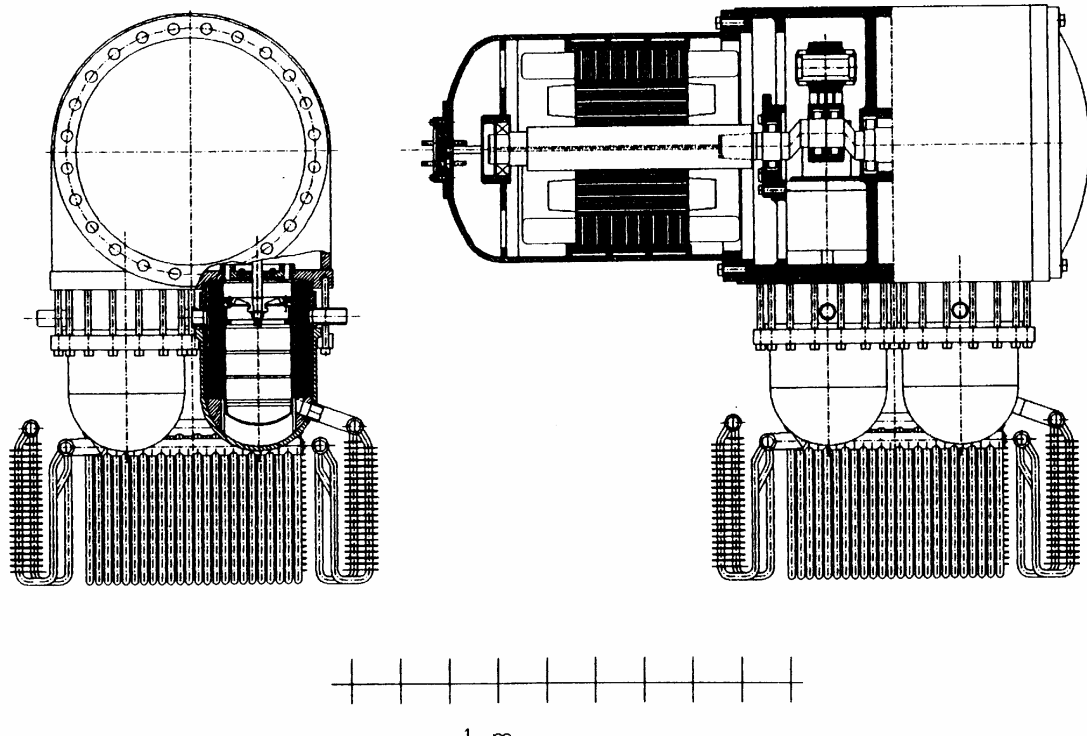

Figure 4-2: *The 35 kW Stirling engine for solid fuel.*

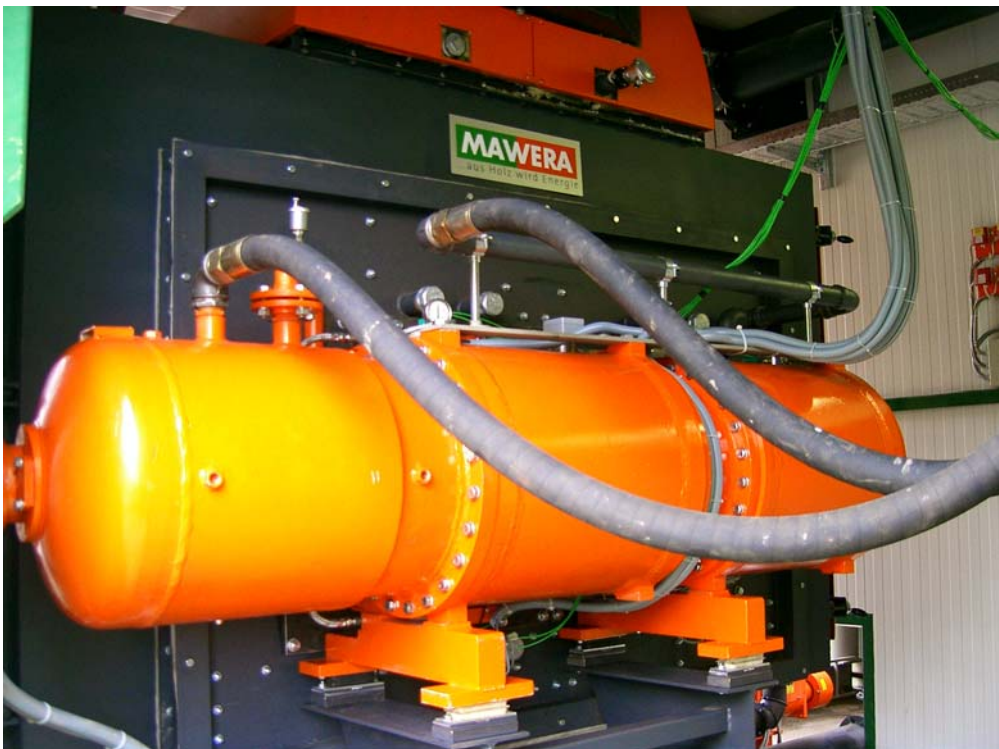

Figure 4-3: 70 kW Stirling engine at boiler. Austria.[Ref. 3]

4.2 Technological state

Stirling engines build for wood chips in the range of 10 - 70 kW electricity can be available in year 2007. In the last 5 years intensive operational tests have taken place at a number of pilot plants (total number of operational hours app. 15.000)

Larger engines (up to 500 kW) and engines designed for straw and other difficult biomasses could be available around 2010.

4.3 Efficiencies

Based on the present experience in the Danish development project the following efficiencies are expected:

Table 4-1: Efficiency

Year	2004	2020
Electric efficiency	25	30
Total electric efficiency of plant	12	20
Heat rate %	50 - 85	50 - 80

The 'Electric Efficiency' stated above refers to the electricity output compared to the heat input to the heater.

The 'Total electric efficiency of plant' refers to the electricity output compared to the lower calorific value of the fuel.

The reason for the big difference between these numbers is the fact that high temperature heat only is relevant for the Stirling process.

An interesting application which has been suggested for the use in Austria in particular, where biomass boilers at district heating plants are common and the rates for produced electricity is high, is to equip relatively large boilers with Stirling engines using just a fraction of the heat in the flue gases. This way the problem of using the upper range of the temperatures only is solved.

The actual thermal efficiency of a plant is mainly a question of an economic optimization.

4.4 Constraints

Biomass powered Stirling engines seem to be competitive in the mentioned range only. Smaller engines will be too expensive compared to the output. Bigger engines will not compare favourably to steam turbines.

Due to the simple design of the system they are suited for automatic operation.

As efficiency depends on operating temperature they should be operated at 100 % load only.

4.5 Emissions

Emissions are not influenced by the Stirling engine directly. Hence emission figures will be similar to comparable boilers. Because of the high temperatures of the combustion NO_x - emission will be in the upper range, while the careful control on air/fuel ratio will result in CO and particle emission in the lower range for the actual fuel and boiler combination.

4.6 Costs

As the Stirling engine for biomass is not yet in mass production only estimates of the cost are available. The Danish development team estimates the costs as follows:

Table 4-2: Investment costs

Year	2004	2020
Investments, Mio €/MWe	3	2
O&M, €/MWh-e *)	3	2.5

*) costs refer to the Stirling engine only. Investment and running costs for the furnace can be judged by costs for boilers of similar type and capacity. Because of the specialized design of the boiler (preheater) and the need for regular cleaning of the heater 30 % should be added to both costs.

5 Trigeneration (LBEIN)

5.1 Technology Description

5.1.1 Introduction

The trigeneration is the simultaneous production of power, heat and cold. In one process, the fuel is converted into three energy products: electricity, hot water or steam and cold water.

Trigeneration is also called *CHCP* (*combined heating, cooling and power generation*) and allows having greater operational flexibility at sites with demand for energy in the form of heating as well as cooling. This way, it is possible to meet both heating demand in winter time and cooling demand during the summer months. For building applications, an American acronym is also used: *BCHP* (*Building Cooling, Heating and Power*).

Figure 5-1 below shows schematically how a trigeneration system converts fuel into energy.

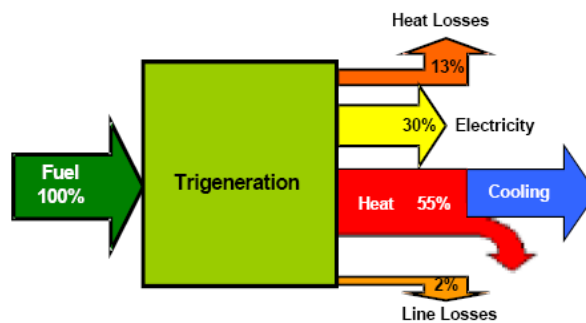

Figure 5-1: Trigeneration principle

Trigeneration systems may consist of a variety of technologies (internal combustion engines, fuel cells, gas turbines, etc.) that can be combined in different ways to produce the desired mix of electricity, heat and cooling with the optimal consumption of fuel. Actually, it can be considered as a cogeneration plant with a chiller (absorption, adsorption or compression chiller) that uses some of the heat or electricity recovered from the cogeneration system to produce chilled water.

The refrigeration can therefore be obtained in three different ways, through an absorption, an adsorption and a compression chiller. The difference between them is the external source used to produce the low temperatures. In the absorption and adsorption systems, the external source is the heat obtained from the cogeneration system (

Figure 5-2 0). In the compression system, however, the electricity produced by the cogeneration system is the source for cooling (Figure 5-3 0).

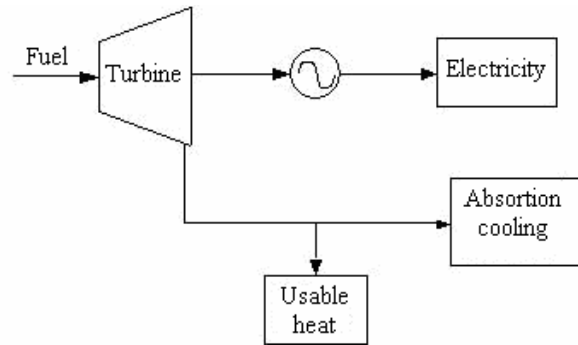

Figure 5-2: Trigeneration with absorption chiller

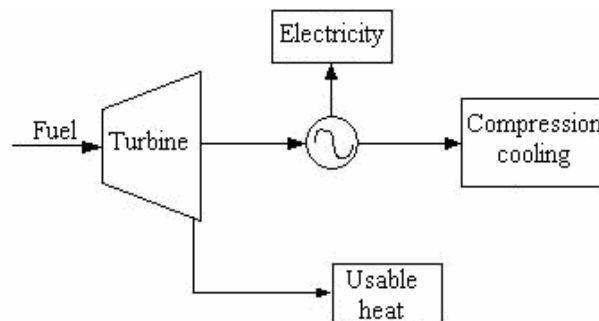

Figure 5-3: Trigeneration with compression chiller

The most common system used is the absorption chiller but, as a general rule, it can be considered that absorption and adsorption chillers will be more suitable when there is waste or low-cost heat, while compression will be the ideal option when there is excess electricity. In the first case, the overall primary energy consumption is reduced by using the low quality heat (low temperature and pressure), that is not used by the CHP plant, to drive the absorption or adsorption chillers.

Absorption chillers

Absorption cycle chillers are driven by low quality heat. There is always a **refrigerant** (which is the substance that evaporates) and an **absorbent** (that absorbs the vapours) that are called a “working pair”. Nowadays, the main absorption refrigeration technologies commercially available for trigeneration plants are based on the following cycles:

- **Ammonia (refrigerant) – water (absorbent):** adapted for industrial processes. This pair is mostly used when evaporation temperatures are below 0°C.
- **Water (refrigerant) – lithium bromide (absorbent):** more adapted for air conditioning, it is used with temperatures above 0°C.

There are three types of absorption systems: **single-effect**, **double-effect** and **triple-effect** systems.

The simplest design of an absorption machine consists of an evaporator, a condenser, an absorber, a generator and a solution pump (Figure 5-4 0). They can use hot water (about 80°C).

The **evaporator** is the element through which, the refrigerant absorbs the surrounding heat and evaporates so that the space around the evaporator becomes colder.

The **condenser** is a heat exchanger that usually uses water (from a cooling tower or any other source) to condense the refrigerant.

The **absorber** is the element where the absorbent (liquid) absorbs the refrigerant (vapour), to obtain the absorbate, which is a solution with high concentration of refrigerant. Cooling is needed in this process.

The **generator** (or desorber) is a heat exchanger fired by the heat source of the system to heat the solution of refrigerant-absorbent and separate them.

In the ammonia-water cycles, a **separator or distillation column** is also used. This is a more sophisticated heat exchanger that ensures the maximum separation of ammonia and water (100 ppm of water content in the ammonia or less).

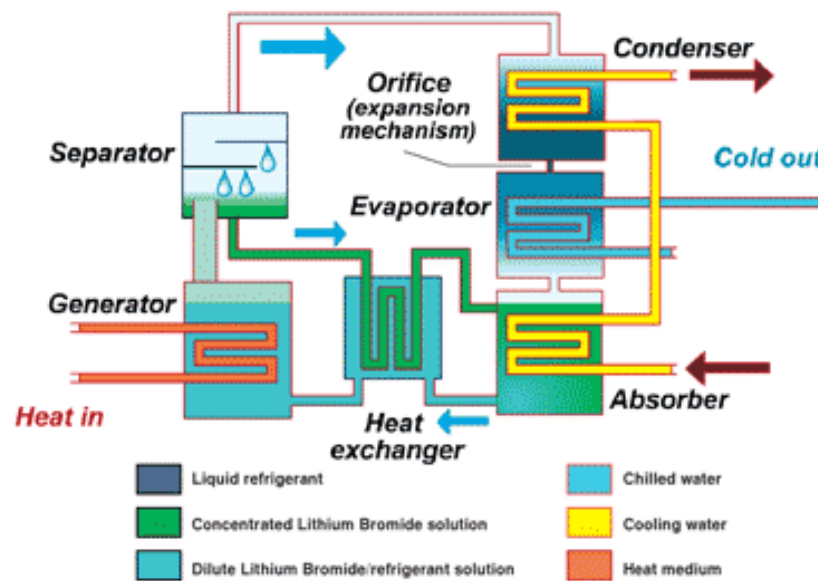

Figure 5-4: Scheme of a single-effect absorption machine

The double-effect systems incorporate two generator-absorber blocks that are staged, so as to utilize the heat twice (*Figure 5-5 0*). Water at about 120-190°C or vapour (3-10 bar) is needed. The ammonia-water pair is seldom used in these systems because of the safety problems that may occur with high pressures.

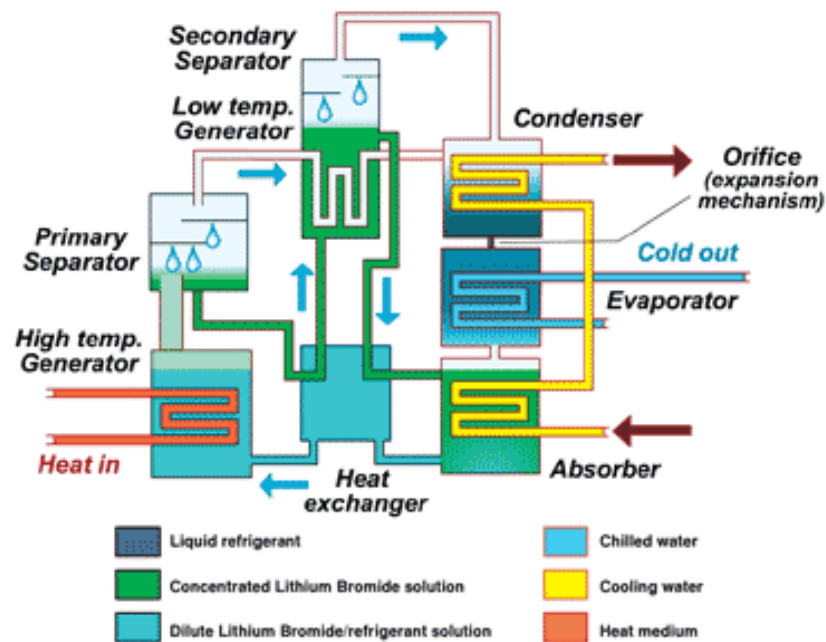

Figure 5-5: Scheme of a double-effect absorption machine

The Triple-effect systems are not going to be considered here because there are only experimental machines working under this effect.

Adsorption chillers

In this case, water is used as a cooling agent and a solid as an adsorbent. Water evaporates in a vacuum at room temperature and thereby extracts heat from its surroundings. This way, a cooling takes place in the circuit.

This is a closed system, so the evaporated water is not released as steam into the surroundings, but recondensed within the machine. For thermodynamical reasons, the evaporated water can not be condensed directly and, therefore, an adsorbent (silica-gel, zeolithe) is used. It collects the water vapour and then, with the use of hot water, the water adsorbed is evaporated again and thereby the material is regenerated.

The evaporation process depends on the temperature and pressure.

Figure 5-6 0 shows the scheme of an adsorption chiller.

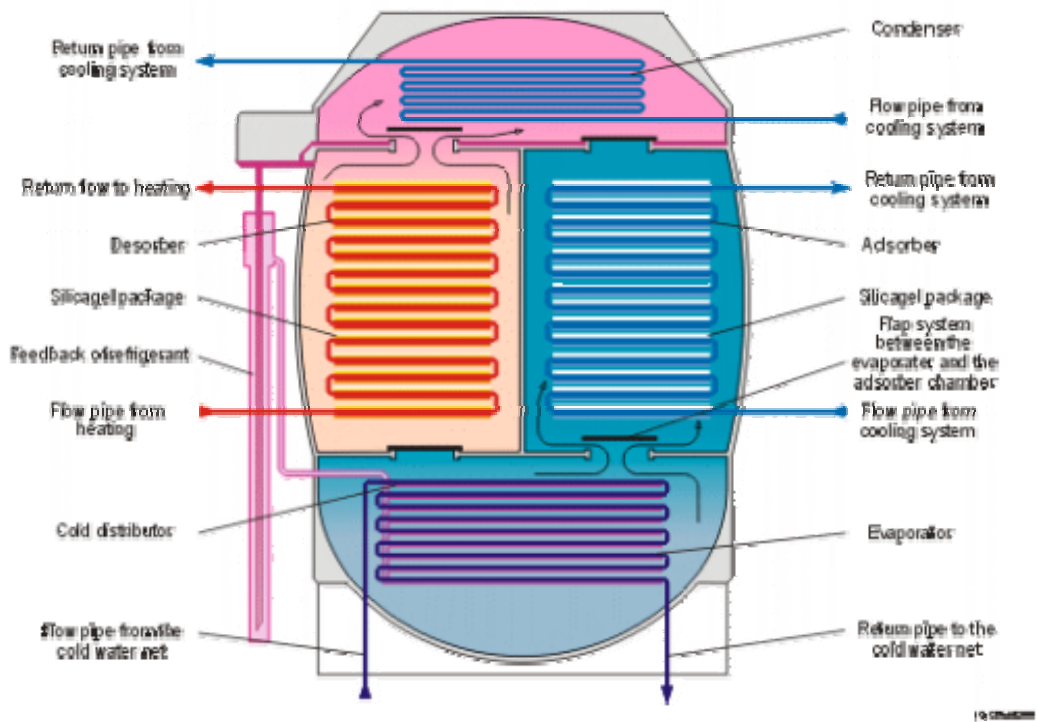

Figure 5-6: Scheme of an adsorption Chiller

The adsorption chiller is a pressure vessel divided into four chambers: the first one (lower) is the evaporator; the generator/receiver (receiver and generator are alternately heated and cooled) is in the middle; and the last one (upper) is the condenser (Figure 5-7).

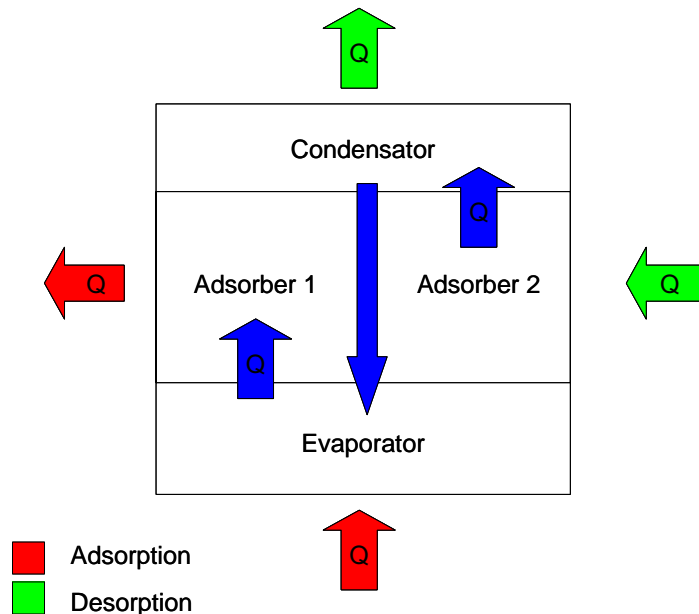

Figure 5-7: Adsorption Chiller

The operating cycle consists of four steps:

1. Water is brought into the evaporator and evaporates and the cooling circuit cools down.
2. The water evaporated is adsorbed on the receiver.

3. Then, thermal energy is supplied and the water adsorbed is de-adsorbed. The receiver turns into the generator.
4. Finally, the de-adsorbed water is condensed in the condenser (cooling cycle) and it returns into the evaporator (step one).

The machine is controlled by the temperature at which the chilled water is supplied to the evaporator.

These systems can be powered by a large range of heat source temperatures, compared to liquid absorption systems, but they have low efficiencies.

These systems are appropriate for applications in trains, busses, boats and spacecrafts, because they do not have corrosion problems (due to the working pairs normally used) and they are less sensitive to shocks and to the installation position.

Compression systems

The compression chillers produce cooling via the reverse-Rankine or vapour-compression cycle. The basic idea of this cycle is that highly compressed fluids at one temperature tend to get colder when they are allowed to expand.

Compression systems consist of a compressor, a condenser, an expansion valve (or throttle valve) and an evaporator and they use a refrigerant (such as Freon) that absorbs heat from the space to be cooled. The refrigerant enters the **compressor** (in the saturated vapour state) and is compressed to a higher pressure, increasing its temperature. This hot and compressed vapour (superheated vapour) can be cooled and condensed in the **condenser** with typically available cooling water or cooling air. Here the refrigerant rejects heat from the system and the rejected heat is carried away by either the water or the air.

The condensed refrigerant (in the saturated liquid state) passes through an expansion valve where its pressure is highly reduced, resulting in the adiabatic flash evaporation of a part of the liquid refrigerant. The auto-refrigeration effect of the evaporation lowers the temperature of the liquid and vapour refrigerant mixture, getting colder than the temperature of the enclosed space to be refrigerated.

The cold mixture of liquid and vapour refrigerant enters then the evaporator, where the refrigerant is vaporized and heat is rejected in the condenser. A fan circulates warm air, evaporating the liquid part of the mixture. At the same time, the air is cooled and the temperature is lowered.

To complete the refrigeration cycle, the vapour from the evaporator is routed back into the compressor as a saturated vapour¹, as *Figure 5-8 0* shows.

¹ Saturated vapours/liquids are vapours/liquids at their saturation temperature and saturation pressure. A superheated vapour is at a temperature higher than the saturation temperature corresponding to its pressure.

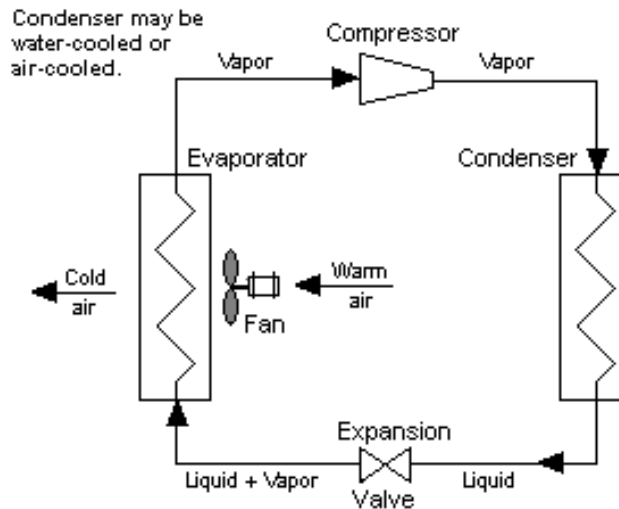

Figure 5-8: Typical single-stage vapour compression refrigeration

There are basically four types of compression chillers:

- **Reciprocating compressors:** employed in small- and medium-sized cooling systems. They are similar to gasoline engines.
- **Screw compressors:** used in big refrigeration systems.
- **Scroll compressors:** high compression efficiency due to the low leakage rate.
- **Centrifugal compressors:** used to compress air or gas.

These types of chillers are used:

- for industrial refrigeration applications;
- for low back pressure air conditioning applications;
- in explosive, corrosive, dusty, humid and other severe-duty industrial environments;
- in low height condensing units; and
- in all industrial and commercial areas.

5.1.2 Efficiency

The efficiency of trigeneration plants can surpass the one of cogeneration plants by about 50%. Cogeneration allows producing electricity and heat with 20-30% less fuel than it takes to produce them separately. Trigeneration, produces cold as well and it can reduce the consumption of fuel by a 50%.

In general, for trigeneration plants, the efficiencies are:

- Total plant efficiency raises to even above 90%.
- Electric power efficiency: 46.6%.
- Heating (total efficiency): 86.4%.
- Chilling (total efficiency): 71.2%.

Chiller efficiency is usually measured by the “**Coefficient of Performance**” (COP). It is defined as the ratio of cooling obtained from a chiller to energy supplied to achieve this refrigeration.

- Absorption plant: $COP = \left(\frac{T_{evap}}{T_{cond} - T_{evap}} \right) * \left(\frac{T_{gen} - T_{cond}}{T_{gen}} \right)$
- Compression plant: $COP = \frac{T_{evap}}{T_{cond} - T_{evap}}$

For compression chillers, the **Energy Efficiency Ratio (EER)** can also be defined. It is the ratio of cooling capacity of the air conditioner in British Thermal Units per hour, to the total electric input in watts under ARI-specified test conditions.

$$EER = COP * 3.413$$

The following table 0 shows the efficiency ranges of the different types of chillers:

Table 5-1: Efficiency ranges of chillers

Type of chiller		COP
Absorption	Ammonia-water. Single effect	0.5-0.8
	Water-lithium bromide. Single effect	0.5-0.7
	Water-lithium bromide. Double effect	0.9-1.2
Adsorption		0.2-0.7
Compression	Centrifugal	4.0-6.0
	Screw	About 5.0
	Scroll	About 4.0

Many parameters influence the efficiency. For absorption chillers, the efficiency decreases exponentially with the decrease of the heat source temperature. As an example:

Table 5-2: Influence of the heat source temperature on the chiller efficiency

Heat source temperature	Power
130°C (nominal)	2 000 kW (nominal)
115°C	1 200 kW
95°C	800 kW

In general, the higher the heat source temperature, the lower the evaporation temperature and the cooling temperature (better cooling capability).

The evaporation temperature also influences the efficiency. As an example, the following graph 0 shows the variation of the COP of a single stage ammonia absorption plant (100-600 kW), with the evaporation temperature, considering different water cooling temperatures.

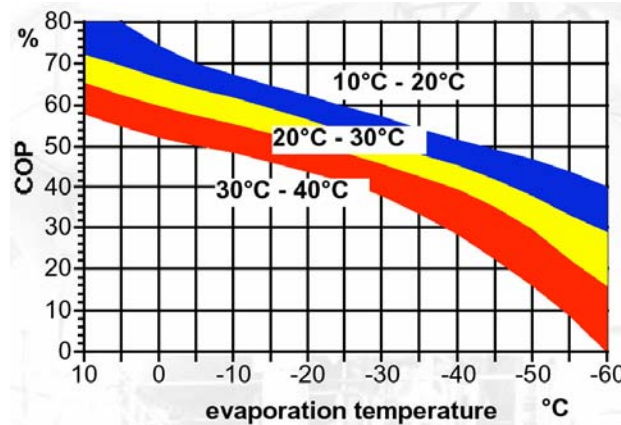

Figure 5-9: Efficiency of a single stage ammonia absorption plant (100-600 kW)²

Another important factor to take into account is the operation at part load conditions. The dependence of COP and capacity will involve many variables and diagrams but, the part load behaviour, may be described in a simplified way.

If a design condition is defined, capacity at part load for an absorption machine follows energy input in a linear fashion. The COP is almost independent of load down to 60% of design load, and below that value the COP decreases linearly.

For the majority of the time, plants run at part load, with low efficiencies. Screw compressors at high compression ratios have particularly poor part load characteristics. In order to improve the efficiency:

- As chillers work poorly at low load conditions, the best option is to have a range of chillers and controls to match load minimising low load operation.
- Operating temperatures (temperature of the chilled water and the water going to the cooling towers) can be adjusted to improve efficiency.
- Around 10% of the heat rejected by the chiller can also be used to heat water at 60-70°C.

The table below summarises the main parameters of the chillers. Triple effect absorption chillers are not considered because, for the moment, they only exist for experimental purposes, but they can reach COPs above 1.6 and operate in the temperature range 170-200°C.

Table 5-3: Chillers' main characteristics

Indices	Absorption			Adsorption	Compression		
	Ammonia	Lithium Bromide			Centrifugal	Screw	Reciprocating
	Single	Single	Double				
Cooling capacity (kW)	20-2500	15-23000	15-23000	35-1300	350-5300	140-4000	3-1400
Temperature range (°C)	120-132	120-132	150-170	50-600			
Installation costs (€/ton)	1250-1750	870-920	930-980				

² Only for orientative use.

There is no upper limit for the size of a plant with absorption chillers and solutions can be found for every requirement, by adding more refrigeration modules (same or different technology) or by designing tailored plants.

5.1.3 Thermal storage

Thermal Energy Storage consists of heating or cooling a material and keeping its temperature as constant as possible in order to cool or heat a space when required. According to the application of the energy, storage systems can be divided in:

- **Storage for cooling:** cold water, water-ice, hydrated salts.
- **Storage for heating:** hot water, bricks or concrete.

Regarding the storage for cooling, in Heating, Ventilation, Air Conditioning and Refrigeration (HVACR) sector, ice and chilled water are the only thermal energy storage technologies with significant current commercial use.

In cool storage, a storage medium can be cooled while chiller operating cost is low, and the storage can be discharged when chiller operating cost is high. Chillers tend to be most economically operated at night, when building cooling loads are low and electric rates may be lower. Furthermore, the lower outdoor temperatures allow the chiller to reject heat more efficiently.

Water is the most used for residential and commercial heating applications. The main disadvantages of the water storage, compared to ice, are the need of a lot of space and the limitation in the refrigeration temperature. On the other hand, the advantages are lower equipment installation costs, a higher charging temperature and the fact that the chillers can operate more efficiently during charging.

In a thermal storage system the total integrated cooling load (ton³-hours, kWh), must be met by the chiller over its entire operating period with appropriate capacity adjustments for different conditions.

There is a minimum chiller capacity defined in terms of its daytime capacity that can supply all the required cooling:

$$\text{Chiller tons} = \text{total ton hours} / (\text{day hours} + \text{derating}^4 * \text{night hours})$$

The minimum storage capacity will be the following:

$$\text{Storage ton hours} = \text{total ton hours} - \text{chiller tons} * \text{day hours}$$

The more hours the chiller is stopped during the day, the larger its size will be. Furthermore, if the chiller is stopped during the cooling period, the size of the storage equipment needs to be increased. If the chiller is stopped during the non-cooling period, the ice build time is reduced and therefore lower glycol temperatures are required and the chilled COP is reduced.

For the operation of systems with thermal storage, there are four different possibilities:

- **Full storage:** The chiller operates at its full capacity during the 12 hour unoccupied period when there is no cooling load or it is small. All the cooling is produced at the ice-making capacity. The chiller in this application is approximately equal to the non-storage alternative. The installation cost is higher compared to the other operation modes but operational costs are lower, that is why, this solution is more common where

³ 1 ton (cooling capacity) = 1 RT (refrigeration ton) = 3.517 kW = 12,000 Btu/h.

⁴ Derating: ice making capacity compared to the nominal value of the chiller (it can be estimated around a 65%).

extended payback periods are acceptable or where incentives or rebates are offered. Its profitability is also highly dependant in the cost of on-peak power.

- **Partial Storage:** The fully loaded chiller operates continuously throughout a design cooling day. Part of the cooling load is covered by the storage and the other part by the chiller. Both, the installed chiller and storage capacity, are reduced with respect to the "full storage" option, minimising the initial investment.
- **Two chillers partial:** Two chillers are operated at night to produce stored cooling, but only one runs during the day, on-peak, period. They can be used to achieve an intermediate level of demand avoidance while enhancing redundancy.
- **On-peak window:** In some areas of the USA utilities have established shorter on-peak periods typically from noon to 6 p.m. These often are described as window rates.

When the system is designed for partial storage, there are two basic operating strategies:

- **Storage priority strategy:** meets as much of the load as possible from the storage and the chiller is only used when the load exceeds the total stored cooling capacity of the store. With this strategy less energy is consumed but it is more complex for controlling and larger storage and chiller sizes are needed.
- **Chiller priority strategy:** meets as much of the load as possible from the chiller and the storage is only used when the load exceeds chiller capacity. This strategy, with 24h chiller operation, is the most used.

5.1.4 Technical problems and solutions

Absorption machines have a great thermal inertia to adapt to external variations (due to its volume and the absorbent and refrigerant quantities).

Figure 5-10 0 shows the performance of a chiller at start-up, based on no load limiting start-up. The selected chiller is a single-effect absorption chiller, which uses LiBr, and with a capacity between 420 and 4 840 kW.

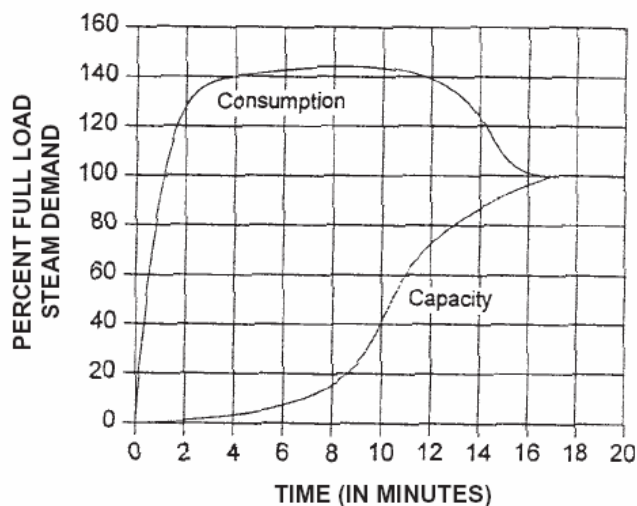

Figure 5-10: Typical chiller start-up performance

5.2 Calculations

5.2.1 Introduction

The objective of this chapter is evaluating the technical viability of employing Trigeneration systems instead of conventional ones for electricity, heat and cold production. The study has been carried out for a specific case study, referred to a commercial building sited in Spain. The commercial sector consumes a very important fraction of the total energy demanded in Spain and therefore, a reduction in their use of energy, would lead to a significant reduction of costs and environmental impact.

This work analyses energy demand curves corresponding for the building, in order to determine the advantages or disadvantages that the usage of a Trigeneration system might provide.

5.2.2 Demand curves

The building under study buys the required electricity in the market and contains a thermal installation for heat and cold production that is composed of the following elements:

- A gas boiler for water and space heating (efficiency = 85%)
- An electric air-conditioning system for cooling (coefficient of performance-COP = 2.5)

The hourly energy demands of the building for a typical day of winter in kW are presented in *Table 5-4*. Data are divided into total electricity demand of the building, the electricity demand of the air-conditioning system and the natural gas consumption of the boiler.

Table 5-4. Energy demands – Winter

Time	Total electricity demand	Air-conditioning electricity demand	Gas demand
0:00	40.39	0	4.05
1:00	40.39	0	4.05
2:00	40.39	0	4.05
3:00	40.39	0	4.05
4:00	40.39	0	4.05
5:00	40.39	0	4.05
6:00	56.68	0	4.05
7:00	100.98	0	4.05
8:00	152.44	0	42.57
9:00	180.46	0	297.97
10:00	188.27	0	450.00
11:00	190.23	0	277.70
12:00	185.67	0	170.27
13:00	175.90	0	156.08
14:00	171.34	0	173.21
15:00	161.56	0	188.51
16:00	149.19	0	188.51
17:00	150.49	0	182.43
18:00	147.23	0	170.87
19:00	134.20	0	87.16
20:00	112.05	0	4.05
21:00	89.90	0	4.05
22:00	67.10	0	4.05
23:00	50.81	0	4.05

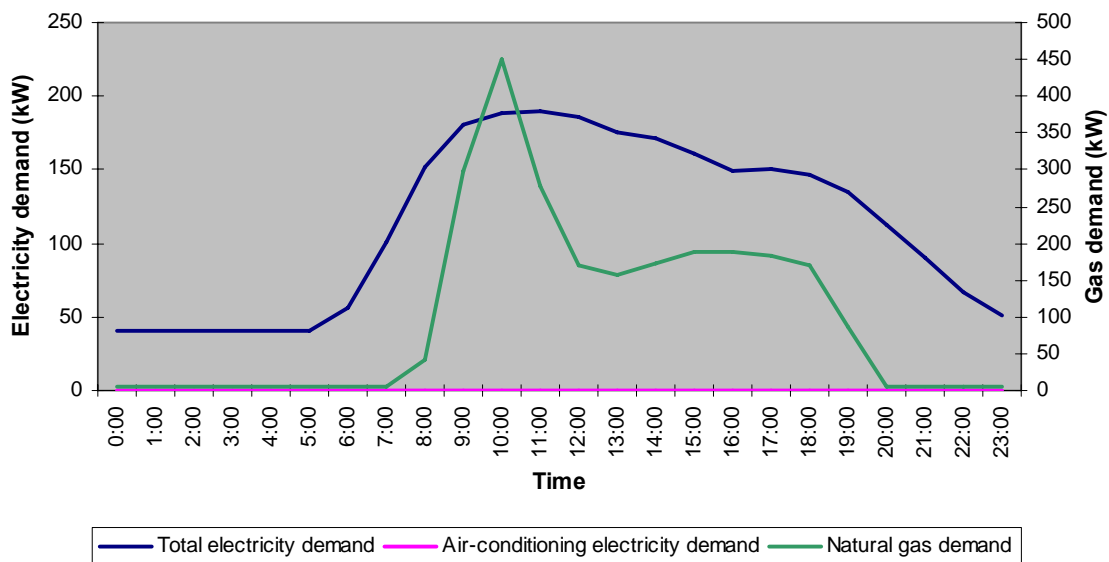

Figure 5-11: Energy demands - Winter

As it can be seen, there is no electricity demand for the air-conditioning system in winter, because it is not connected in this season for weather conditions.

The following table shows data corresponding to a typical day of summer (also in kW):

Table 5-5. Energy demands – Summer

Time	Total electricity demand	Air-conditioning electricity demand	Gas demand
0:00	36.73	1.63	0.40
1:00	35.92	1.63	0.40
2:00	35.92	1.63	0.40
3:00	35.92	1.63	0.40
4:00	37.55	1.63	0.40
5:00	53.88	1.63	0.40
6:00	122.45	1.63	0.40
7:00	183.67	1.63	0.40
8:00	208.98	1.63	3.81
9:00	220.41	2.44	27.49
10:00	226.94	10.57	39.73
11:00	230.20	10.57	24.28
12:00	229.39	12.20	15.45
13:00	223.67	4.88	14.45
14:00	206.53	8.94	15.65
15:00	195.10	2.44	16.86
16:00	194.29	1.63	17.26
17:00	188.57	1.63	16.45
18:00	172.25	1.63	15.45
19:00	137.96	1.63	8.43
20:00	86.53	1.63	0.40
21:00	58.78	1.63	0.40
22:00	48.16	1.63	0.40
23:00	44.08	1.63	0.40

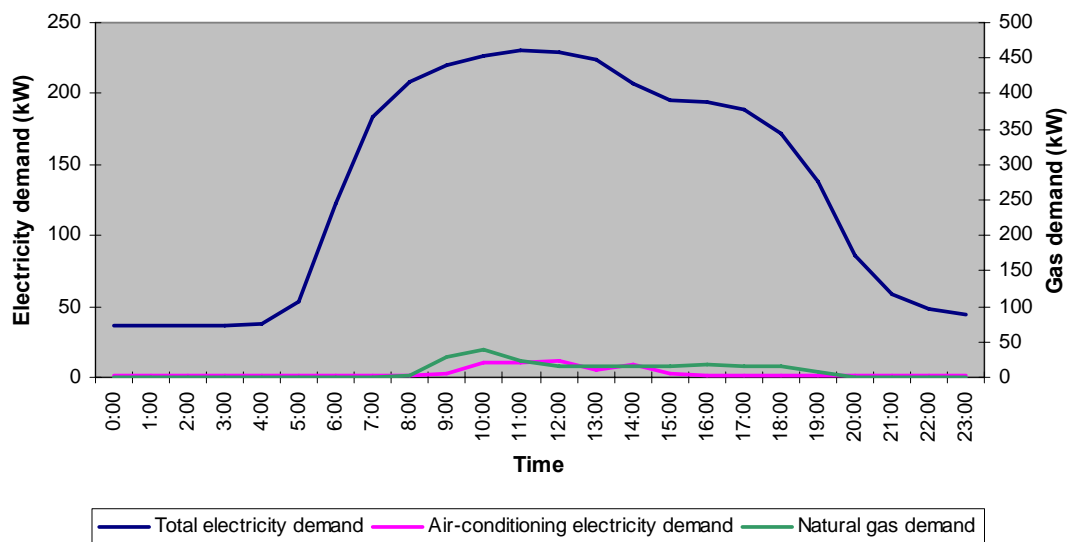

Figure 5-12: Energy demands - Summer

It can be noticed that the natural gas consumption in summer is very small. To be more precise, it is approximately a 9% of winter demand. This is because gas consumption includes both space and water heating, and space is not heated in summer. Consequently, gas demand in summer is only due to water heating.

In order to perform the study for the whole year, data corresponding to typical days of spring and autumn are required as well. These data are not available for this building so they have been calculated by averaging the energy demands corresponding to winter and summer respectively.

It has been supposed that spring and autumn data are the same, because the ambient conditions in both seasons are very similar. In that manner the following values are obtained:

Table 5-6. Energy demands - Spring/Autumn

Time	Total electricity demand	Air-conditioning electricity demand	Gas demand
0:00	38.56	0.81	2.23
1:00	38.15	0.81	2.23
2:00	38.15	0.81	2.23
3:00	38.15	0.81	2.23
4:00	38.97	0.81	2.23
5:00	47.13	0.81	2.23
6:00	89.56	0.81	2.23
7:00	142.33	0.81	2.23
8:00	180.71	0.81	23.19
9:00	200.43	1.22	162.73
10:00	207.61	5.28	244.87
11:00	210.22	5.28	150.99
12:00	207.53	6.10	92.86
13:00	199.78	2.44	85.26
14:00	188.93	4.47	94.43
15:00	178.33	1.22	102.69
16:00	171.74	0.81	102.89
17:00	169.53	0.81	99.44
18:00	159.74	0.81	93.16
19:00	136.08	0.81	47.80
20:00	99.29	0.81	2.23
21:00	74.34	0.81	2.23
22:00	57.63	0.81	2.23
23:00	47.45	0.81	2.23

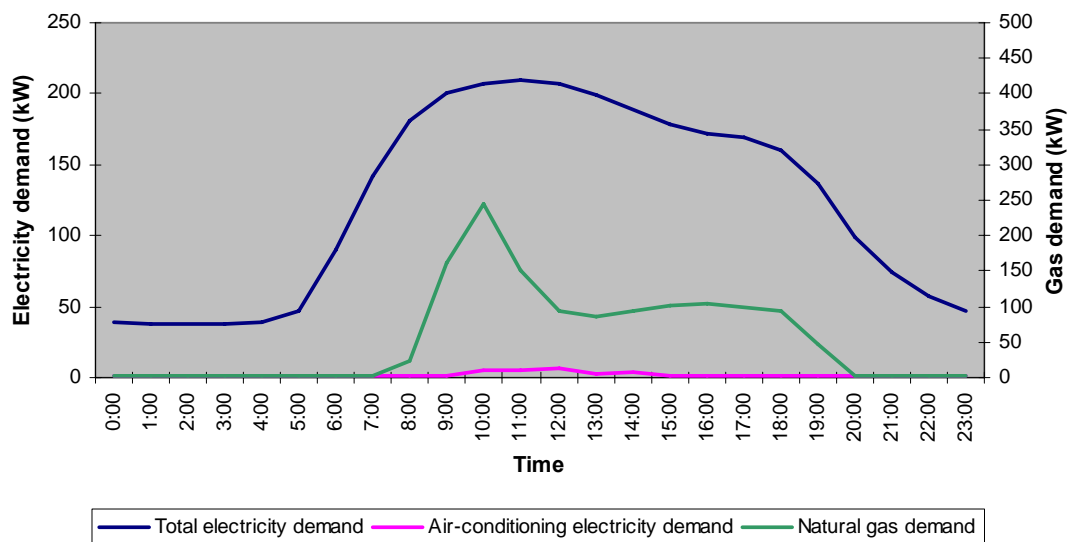

Figure 5-13: Energy demands – Spring/Autumn

5.2.3 Trigeneration system

Due to the thermal and electric requirements of the building, it has been decided that the installation will be composed of the following elements:

- Two gas microturbines of 135 kW of electric power and 225 kW of thermal power each. Natural gas consumption of each microturbine is 450 kW, so electric efficiency is 30% and thermal efficiency 50%, as *Table 5-7* shows:

Table 5-7: Gas microturbine characteristics

Electricity Power (kW)	135
Thermal Power (kW)	225
Gas Demand (kW)	450
Electric Efficiency	30%
Thermal Efficiency	50%

- A double-effect H₂O/LiBr steam absorption refrigeration system activated with the exhaust gases of the microturbine. The COP of this system for cold production is 1.15.

In this work, it has not been considered a cold storage system.

5.2.4 General approach

The objective of this section is explaining the general methodology employed in order to define the demand curves of the building for the whole year based on the data provided in the previous section. For this purpose, several assumptions have been made:

1. The year is divided into three periods that correspond to the different seasons: winter, summer and spring/autumn.
2. Data provided in *Table 5-8* and *Table 5-6* refer to a day with the average ambient temperature of the period.
3. Hourly demand curves are the same for all days of the same month.

The following table shows the months that have been included in each period as well as the average temperatures for each month and period. These temperatures were registered in Madrid and represent historical average values.

Table 5-8: Periods and temperatures considered in the study

Period	Month	Month average (°C)	Period average (°C)
Winter	January	6	7.8
	February	7	
	Mach	9	
	November	10	
	December	7	
Spring/Autumn	April	12	14.3
	May	16	
	October	15	
Summer	June	20	22.3
	July	24	
	August	24	
	September	21	

As it can be seen, the criterion that has been followed in order to group the months into the different periods is:

- Winter: months with an average temperature lower than or equal to 10 °C.
- Spring/autumn: months with an average temperature between 10°C and 20 °C.
- Summer: months with an average temperature higher than or equal to than 20°C.

Therefore, the hourly demand curves provided in section 5.2.2 correspond to the average temperatures of 7.8°C (winter), 14.3°C (spring/autumn) and 22.3°C (summer) respectively.

The calculation of the energy demand curves for each month of the year has been carried out as follows:

- **Air-conditioning electricity demand:** it is obtained taking as a reference the profile of the corresponding period and modifying it proportionally to the difference between the average temperature of the period and the average temperature of the month considered. This way, the higher the temperature is, the bigger the electricity consumption is. Due to the third assumption, the obtained curves will be the same for all days of the same month.
- **Total electricity demand:** it has been supposed that the only electricity consumption that varies along the year is the corresponding to the air-conditioning system. Therefore, the electricity demand without taking into account the air-conditioning is the same for all months of the same period. Total electricity demand is calculated adding to these values, the air-conditioning consumption corresponding to each month that is obtained as it was explained in the previous paragraph. The same as previously, all days of the same month have the same curves.
- **Gas demand:** this demand is due to both space and water heating. It has been considered that gas consumption corresponding to water heating is the same for all months of the year in contrast to space heating, whose consumption depends on the ambient temperature: the lower the temperature, the higher the consumption, because more energy is required to reach the comfort temperature. The calculation of this variable has been carried out taking into account the deviation of the average temperature of each month in relation to the comfort temperature that has been considered to be 20°C. The obtained differences will be used to modify demand data corresponding to each period in order to obtain the demand curves for each month. For example, the space heating demand for one day of January at a determined time H will be calculated with the following formula:

$$D_{January}^{SH} = D_{winter}^{SH} \frac{(20^{\circ}C - 6^{\circ}C)}{(20^{\circ}C - 7.8^{\circ}C)}$$

Where D_{winter}^{SH} is the natural gas demand for one day of winter at time H, and 7.8°C and 6°C, the average temperatures of winter and January respectively. Total gas demand will be the addition of space heating and water heating (D^{WH}) demands. As stated previously, the last one is the same for all days of the year:

$$D_{January}^{Total} = D_{January}^{SH} + D^{WH}$$

From these calculations, the following curves for the total electricity demand, air-conditioning electricity demand and natural gas consumption are obtained. These curves represent the hourly demands for one day of each month:

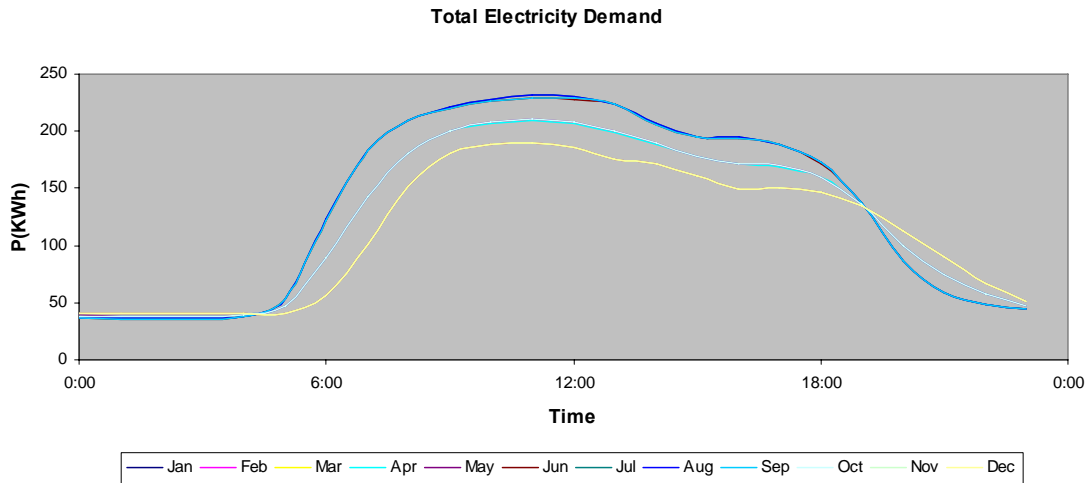

Figure 5-14: Hourly electricity demand for each month (Conventional installation)

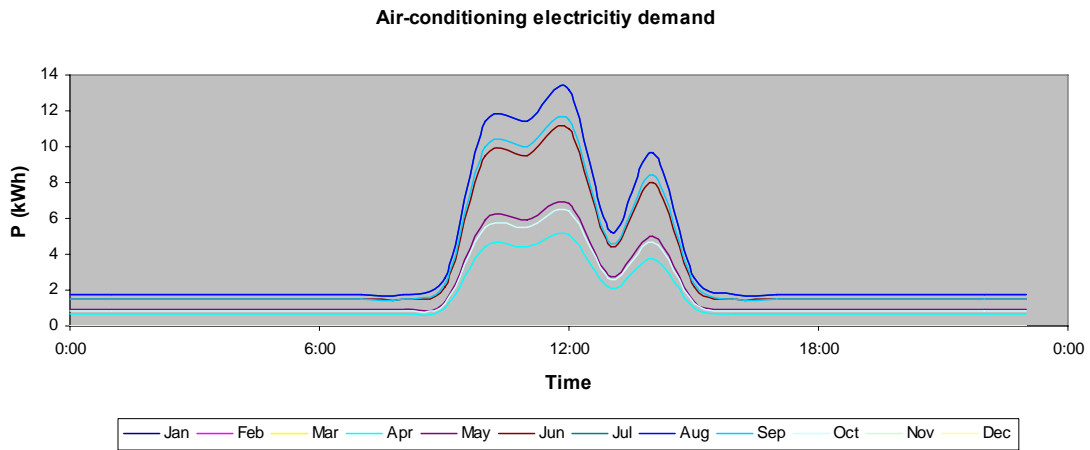

Figure 5-15: Hourly air-conditioning electricity demand for each month (Conventional installation)

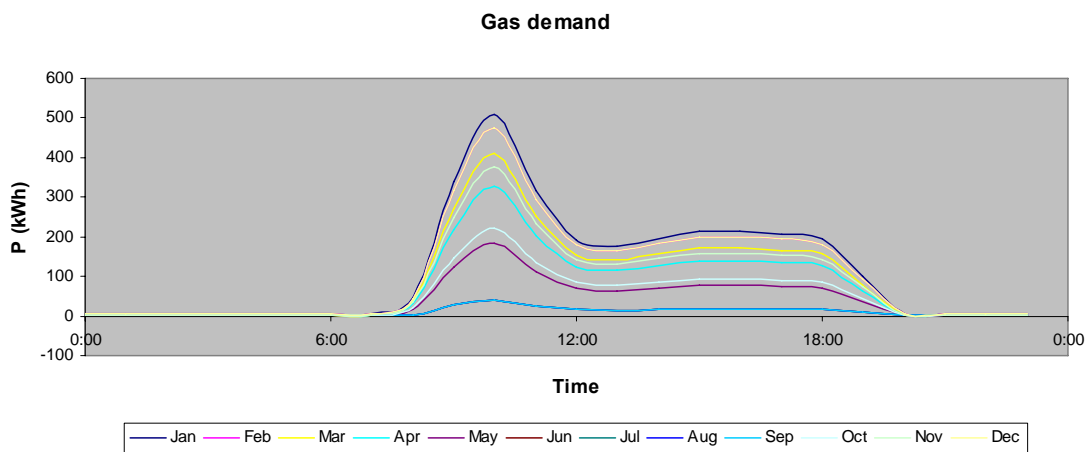

Figure 5-16: Hourly gas demand for each month (Conventional installation)

By adding the values for the whole day, total daily demands can be obtained.

These added values are presented in *Table 5-9*, *Figure 5-17* and *Figure 5-18*.

Table 5-9: Energy demand for each month (Conventional installation)

Month	Energy demand (KWh/day)		
	Total Electricity	Air-conditioning electricity	Gas
January	2 706.84	0.00	2 760.57
February	2 706.84	0.00	2 579.11
March	2 706.84	0.00	2 216.19
April	2 953.87	33.35	1 782.82
May	2 964.99	44.47	1 001.48
June	3 205.82	71.62	220.13
July	3 220.14	85.94	220.13
August	3 220.14	85.94	220.13
September	3 209.40	75.20	220.13
October	2 962.21	41.69	1 196.81
November	2 706.84	0.00	2 034.73
December	2 706.84	0.00	2 579.11

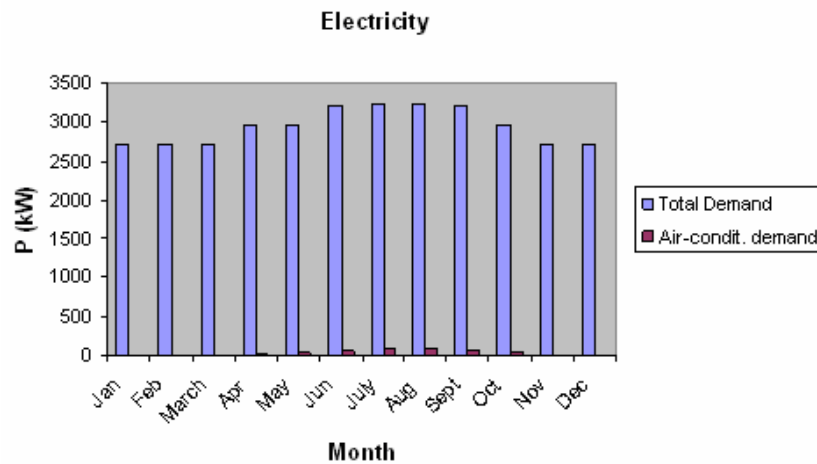

Figure 5-17: Daily electricity demand for each month (Conventional installation)

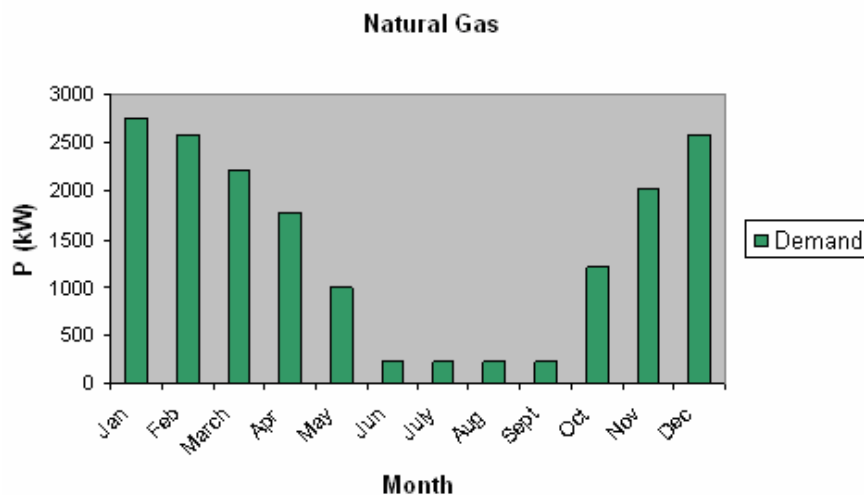

Figure 5-18: Daily natural gas demand for each month (Conventional installation)

The next step consisted in calculating the energy demand curves for the whole year, by making use of the third assumption that supposes that all days of the same month have the same demand for electricity and natural gas.

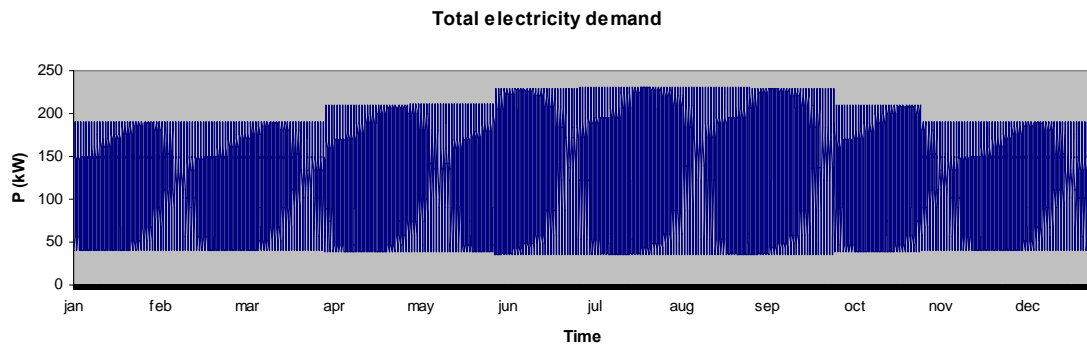

Figure 5-19: Total electricity demand for the whole year (Conventional installation)

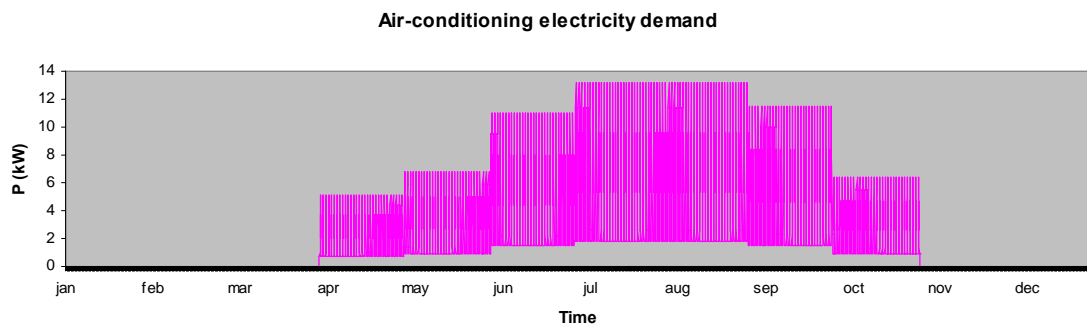

Figure 5-20: Electric demand of the air-conditioning system for the whole year (Conventional installation)

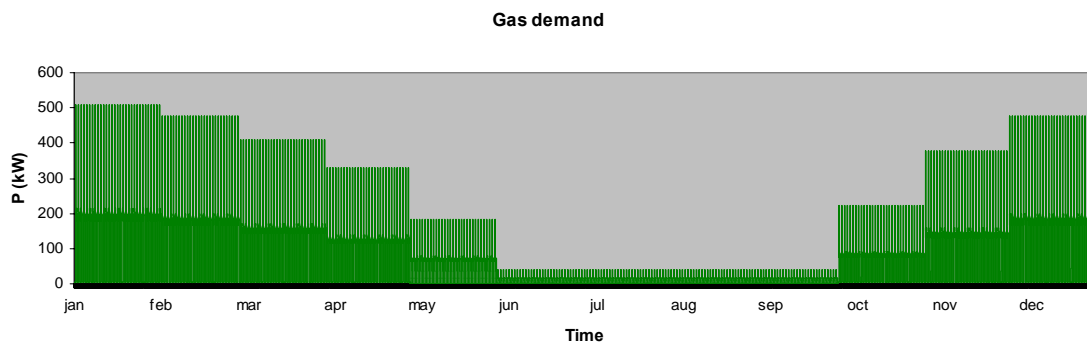

Figure 5-21: Natural gas demand for the whole year (Conventional installation)

Finally, in the following table the total amount of energy demanded in the whole year is presented:

Table 5-10: Total Energy demands for the whole year (Conventional installation)

Energy demand (KWh/year)		
Total Electricity	Air-conditioning electricity	Gas
1 073 198	13 404	515 977

5.2.5 Energy analysis

The purpose of this analysis is obtaining the heat and electricity production of the Trigenation system and comparing it with the thermal and electricity demand of the building, in order to determine its technical feasibility.

Before the analysis, the operating conditions of the Trigeneration plant must be defined. It has been supposed that its objective is covering all the thermal demand of the building. Consequently, the electricity will be imported or exported to the market as a function of the consumption of the building and the generation of the Trigeneration system in that moment.

Thermal balance

Taking into account the previous assumption, the total **thermal generation** must be equal to the total thermal demand. The **thermal demand** is calculated by adding the thermal demand corresponding to space and water heating ($Thermal\ demand_{s\&w}$), and the thermal demand of the air-conditioning system ($Thermal\ demand_{ac}$):

$$Thermal\ generation = Thermal\ demand = Thermal\ demand_{s\&w} + Thermal\ demand_{ac}$$

Thermal demand of space heating and water heating is obtained multiplying the natural gas consumption by the boiler efficiency (85%):

$$Thermal\ demand_{s\&w} = Gas\ demand * Boiler\ Efficiency = Gas\ demand * 0.85$$

The calculation for thermal consumption of the air-conditioning system is performed taking into consideration the COP of the air-conditioning (2.5) and the COP of the absorption refrigeration system for cold production (1.15). It can be formulated as follows:

$$\begin{cases} COP_{ac} = \frac{Cold\ generation}{Electricity\ demand_{ac}} \\ COP_{absorption} = \frac{Cold\ generation}{Thermal\ demand_{ac}} \end{cases}$$

As a result, if both “Cold generation” terms are equalised, the total thermal demand of the air-conditioning is obtained:

$$Thermal\ demand_{ac} = Electricity\ demand_{ac} \frac{COP_{ac}}{COP_{absorption}} = Electricity\ demand_{ac} \frac{2.5}{1.15}$$

With the previous formulation it is possible to obtain the total thermal demand of the building and consequently the total thermal generation of the Trigeneration installation.

$$Thermal\ generation = Thermal\ demand = Gas\ demand * 0.85 + Electricity\ demand_{ac} \frac{2.5}{1.15}$$

Electricity balance

The **electricity demand** in the second scenario (Trigeneration system) is the same as in the previous one (conventional installation) but subtracting the consumption corresponding to the air-conditioning because in this case, the cold is produced by the absorption system:

$$Electricity\ demand = Electricity\ demand_{previous} - Electricity\ demand_{ac}$$

The **electricity generation** is obtained as a function of the efficiency of the microturbine. If it is taken into account that the electricity and the thermal efficiencies are 0.5 and 0.3 respectively, the total electricity production is:

$$Electricity\ generation = Thermal\ generation \frac{thermal\ efficiency}{electric\ efficiency} = \frac{0.3}{0.5} Thermal\ generation$$

5.2.6 Results

As it was explained previously, the energy analysis comprises the calculation of the electricity and thermal demands of the building as well as the thermal and electricity generation of the Trigeneration system. This section provides the results of such analysis for three different time horizons: daily, monthly and yearly.

Daily energy balance

The following figures show the daily energy balance for three specific days corresponding to the three periods of time defined along the year. To be more precise, the considered days belong to the following months:

- March (winter).
- May (spring/autumn).
- August (summer).

Results for the remaining months have not been presented in this document because the results are proportional to these ones.

The yellow line represents both the thermal generation and the thermal demand. As the Trigeneration system is operated to satisfy the total thermal demand of the building at any moment, thermal generation and demand have the same values.

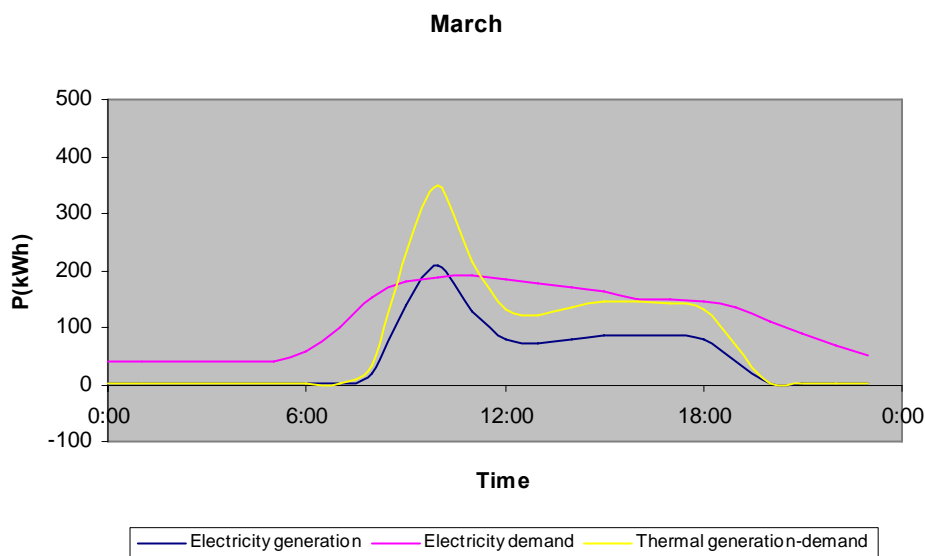

Figure 5-22: Energy balance for one day of winter (Trigeneration system)

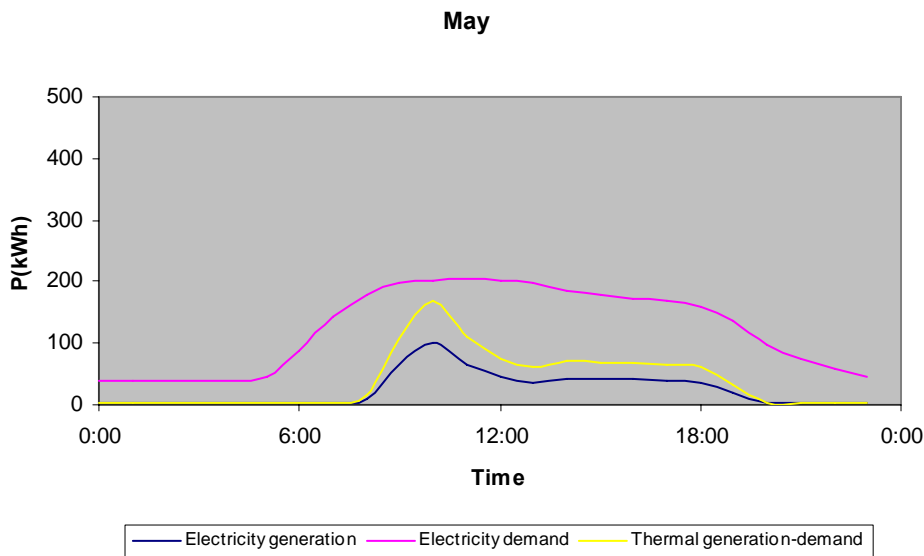

Figure 5-23: Energy balance for one day of spring/autumn (Trigeneration system)

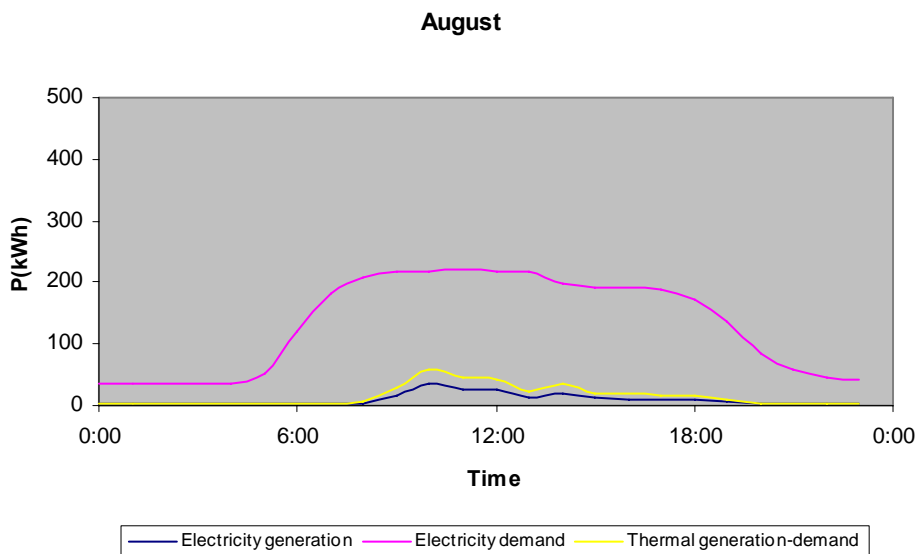

Figure 5-24: Energy balance for one day of summer (Trigeneration system)

It can be seen that the electricity generation is proportional to the thermal generation because they are obtained as a function of the microturbine efficiency.

Monthly energy analysis

Table 5-11 shows the monthly balance obtained for the Trigeneration system. These values represent the addition of all hourly consumptions and generations for each month and have been obtained multiplying the total daily demands and generations by the number of days that the corresponding month has.

For this purpose, it has been necessary to take into account the assumption that all days of the same month have the same curves.

Graphical representation for the values in Table 5-11 is in Figure 5-25 and Figure 5-26.

Table 5-11: Monthly energy balance (Trigeneration system)

Month	Energy demand (KWh/month)		Energy production (KWh/month)	
	Electricity	Thermal	Electricity	Thermal
January	83 912.12	72 741.08	43 644.65	72 741.08
February	75 791.59	61 382.87	36 829.72	61 382.87
March	83 912.12	58 396.67	35 038.00	58 396.67
April	87 615.68	47 637.15	28 582.29	47 637.15
May	90 536.20	29 385.83	17 631.50	29 385.83
June	94 026.08	10 284.14	6 170.48	10 284.14
July	97 160.28	11 592.22	6 955.33	11 592.22
August	97 160.28	11 592.22	6 955.33	11 592.22
September	94 026.08	10 517.67	6 310.60	10 517.67
October	90 536.20	34 345.64	20 607.38	34 345.64
November	81 205.28	51 885.68	31 131.41	51 885.68
December	83 912.12	67 959.61	40 775.77	67 959.61

Thermal

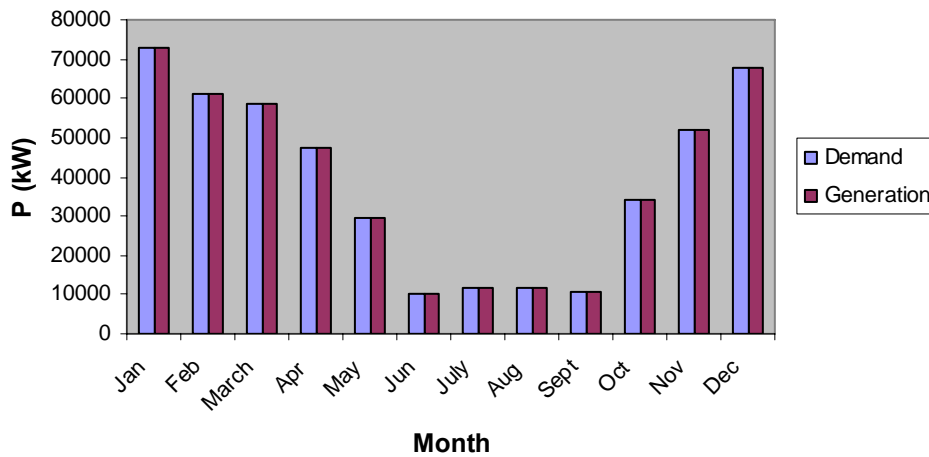

Figure 5-25: Monthly thermal balance (Trigeneration system)

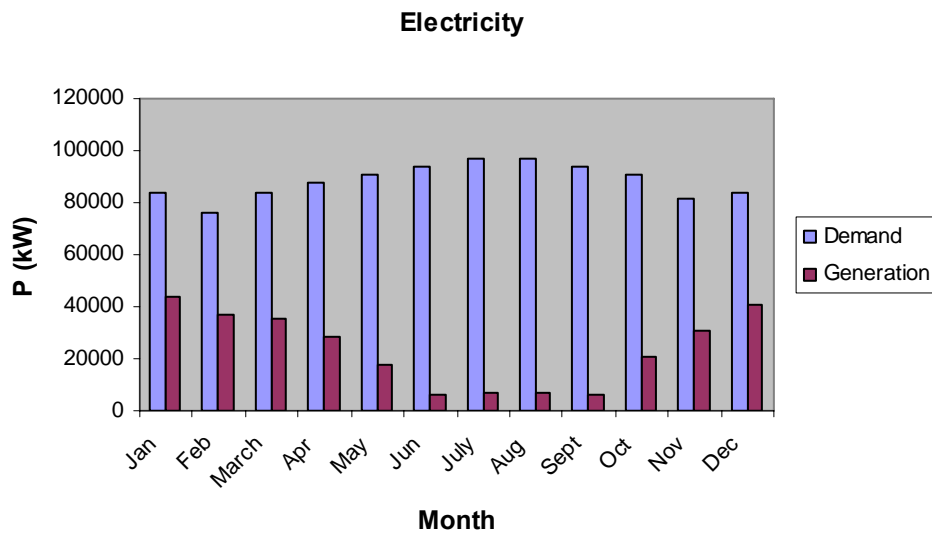

Figure 5-26: Monthly electricity balance (Trigeneration system)

In *Figure 5-25* thermal generation equals thermal demand because the operating conditions of the installation have been defined for this purpose. On the contrary, in *Figure 5-26* the big difference between the amount of generated and consumed electricity becomes visible, mainly in summer months. As a result of the low heat demand in summer, the thermal generation of the Trigeneration plant is very small and consequently, the electricity generation too. The remaining electricity will have to be bought in the market.

From these data and taking into account the efficiency of the microturbine, it is possible to obtain the consumed amount of natural gas:

Table 5-12: Monthly natural gas demand (Trigeneration system)

Month	Gas demand (kWh/month)
January	145 482.16
February	122 765.75
March	116 793.35
April	95 274.30
May	58 771.66
June	20 568.27
July	23 184.45
August	23 184.45
September	21 035.34
October	68 691.27
November	103 771.36
December	135 919.22

Natural Gas

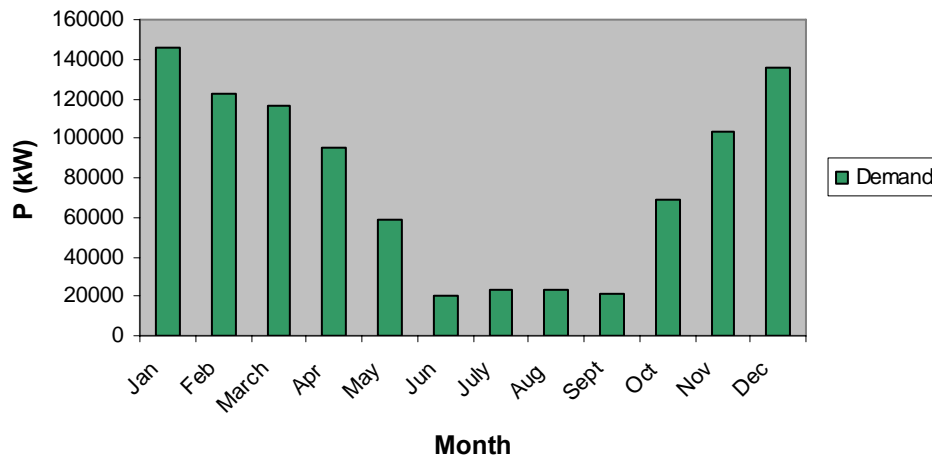

Figure 5-27: Monthly natural gas demand (Trigeration system)

It is obvious that the natural gas consumption in summer is very small because in this season the thermal generation of the microturbine is very low.

Yearly energy analysis

Finally, if the values for all months provided in Table 5-11 are added, the energy balance for the whole year is obtained. These results, as well as the total natural gas demand for the whole year are presented below:

Table 5-13: Yearly energy balance (Trigeration system)

Energy demand (KWh/year)			Energy production (KWh/year)	
Electricity	Thermal	Gas	Electricity	Thermal
1 059 794	467 721	935 442	280 632	467 721

In order to determine the total amount of electricity to be bought on the market for the whole year, the electricity generation has to be subtracted from the total electricity production. That is: $1\ 059\ 794 - 280\ 632 = 779\ 162$ kWh/year.

5.2.7 Conclusion

This document shows that if a conventional installation composed of a natural gas boiler and an air-conditioning system is replaced by a Trigeration system capable of generating heat, cold and electricity simultaneously, the demand and generation profiles of the building where it is installed are modified.

The first change occurs in the electricity demand, which is reduced because the absorption refrigeration system is responsible for producing the required cold instead of the air-conditioning system. Therefore, total electricity demand is the difference between the previous electricity demand and the electricity consumption of the air-conditioning system.

Another change happens in the amount of electricity bought in the market. With the conventional installation, all the electricity demand of the building was bought in the market. However, the Trigeration plant generates not only heat and cold but also electricity. Consequently, the amount of electricity that has to be bought is reduced and, sometimes, there

might even be a surplus that could be sold to the market. The amount of electricity bought is calculated subtracting the electricity generation of the Trigeneration plant to the total electricity demand of the building. The obtained results are graphically represented in the following figures. Only the three days selected in section 0 have been considered because they represent the behaviour of the system in the three time periods defined. In these graphs, the cyan line defines the amount of electricity imported from or exported to the market in each moment. Negative values mean that there is a surplus of electricity generation.

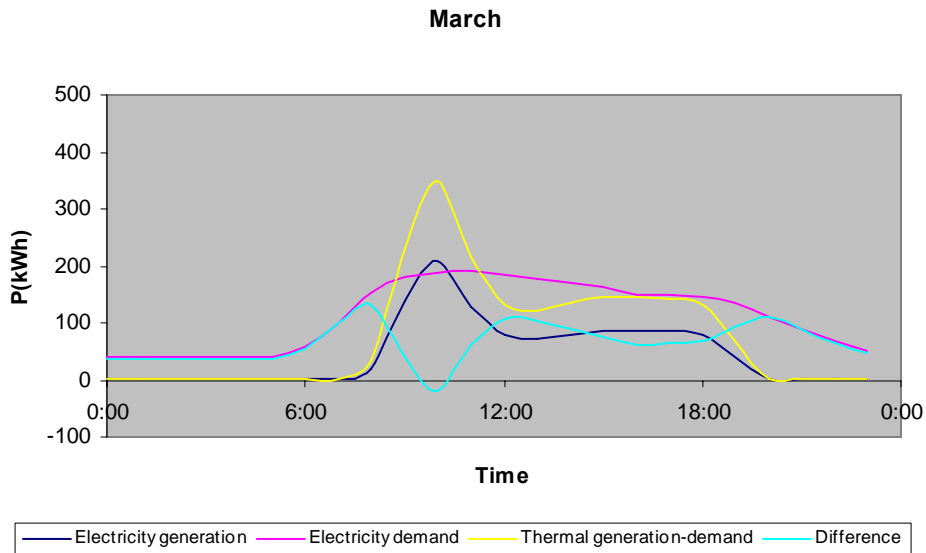

Figure 5-28: Amount of electricity imported from/exported to the market on a winter day

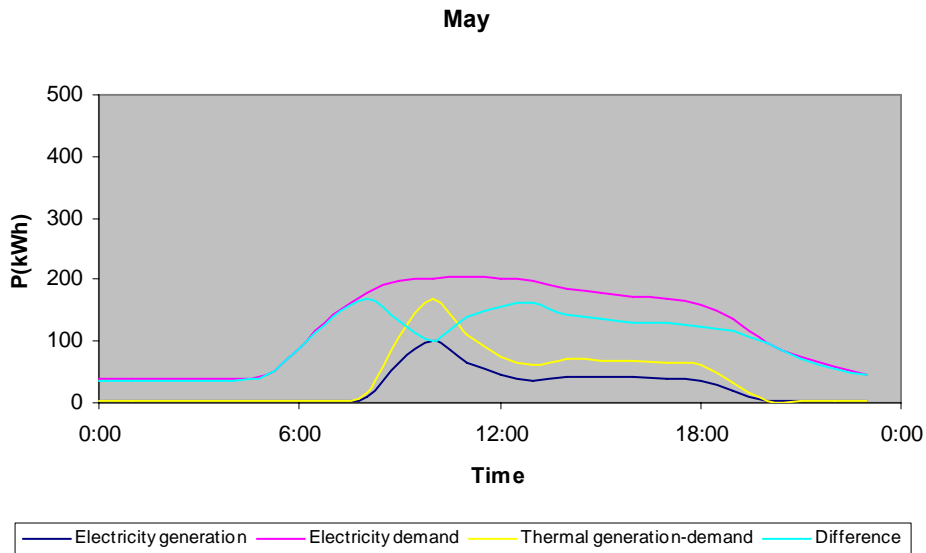

Figure 5-29: Amount of electricity imported from/exported to the market on a spring/autumn day

August

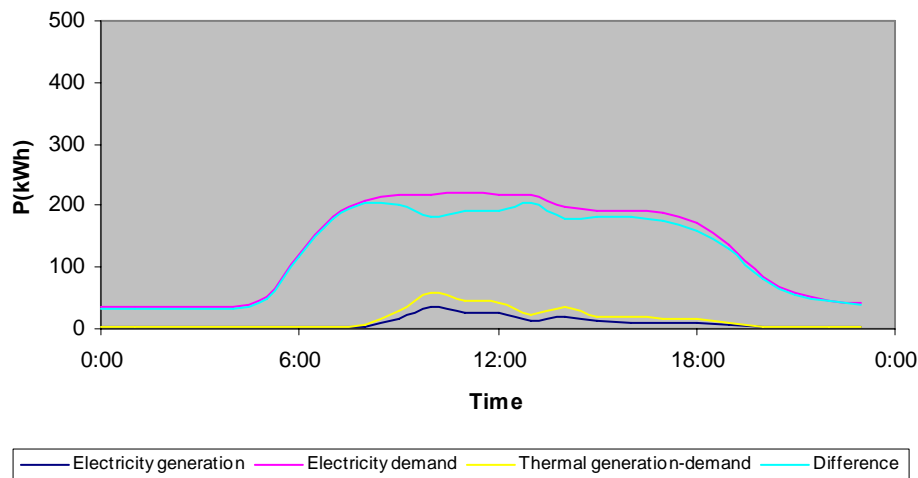

Figure 5-30: Amount of electricity imported form/exported to the market on a summer day

Looking at the previous graphs it can be concluded that most of the time, the amount of electricity generated is not enough to cover the demand and, consequently, it is necessary to buy the difference in the market. The only exception occurs during winter months (January, February, March, November and December) where the energy production exceeds the demand during approximately two hours in the morning.

The following table shows a review of the daily electricity demands in both scenarios for the three days considered above, as well as the percentage of electricity that is saved to be bought in the energy market when the trigeneration system is employed:

Table 5-14: Daily savings on electricity

Month	Period	Electricity demand (kWh/day)		
		Conventional	Trigeneration	Saving (%)
March	Winter	2 706.84	1 576.58	41.8
May	Spring/Autumn	2 964.99	2 351.76	20.7
August	Summer	3 220.14	2 909.84	9.6

It can be seen how the most important savings occur in winter months, where it is possible to reduce the amount of energy bought in the market in a 41.8 %. The reason is that the generation of the Trigeneration system is very big in this season, even exceeding the demand sometimes.

The following table shows the total yearly demands of electricity and natural gas for the two situations considered. It has to be noted that the electricity demand for the Trigeneration system is referred to the amount of energy that is bought in the market, that is, the difference between the electricity demand and the generation.

Table 5-15: Comparison between both scenarios

	Demand (kWh/year)	
	Gas	Electricity
Conventional installation	515 977	1 073 198
Trigeneration system	935 442	779 162

Looking at this table it can be seen that the Trigeneration system reduces considerably the amount of electricity that is bought in the market. However, this reduction on the electricity demand implies an increase on the gas consumption of the building.

From the point of view of the system as a whole, it can be concluded that this kind of generation contributes to reduce the total consumption of primary energy. If it was considered that the energy production of the system as a whole is obtained using a thermal power plant of natural gas whose efficiency is 30% and that transmission and distribution losses of the system are equal to the 14%⁵, the following values would be obtained:

Table 5-16: Comparison of the natural gas consumption of the system as a whole

	Electricity demand (kWh/year)	Electricity production (kWh/year)	Gas consumption (kWh/year)		
			Whole system	Building	Total
Conventional	1 073 198	1 223 446	4 078 154	515 977	4 594 131
Trigeneration	779 162	888 244	2 960 814	935 442	3 896 255

That means, first the amount of natural gas has been calculated that the whole system has to burn in order to supply the required electricity demand. Then, the natural gas consumption of the microturbine installed in the building has been added to the previous value, obtaining as a result the total primary energy consumption. Looking at the results it can be concluded that the requirements of natural gas are smaller for the Trigeneration system. To be more precise, primary energy needs are reduced a 15%.

It is important to take into account that this reduction will contribute not only to provide economical savings, but also to reduce greenhouse gas emissions. This kind of plants has also the advantage of allowing a more reliable and safer energy supply.

5.3 Assessment

5.3.1 Technical assessment: Suitability and availability

- Availability: Trigeneration can be bought, but installation is not so easy, since a dedicated pipeline network is required to transport hot water or chilled water. Installation costs can be reduced by installing a single, hot water network and producing cold where it is needed.

The technology is well-known but seldom used in Spain, although some areas appear to be very well-suited for its usage: in the Spanish Tertiary Sector, 23 trigeneration plants were registered by TriGeMed project in 2003, representing an installed electric capacity of 48 MW⁵. Most installations were found in hospitals, but there are also some in hotels, sport centres, universities, etc.

In the Industrial Sector, many processes require cooling, so trigeneration can be a very appropriate way of producing cold, taking advantage of the CHP installation where it exists. The existence of a CHP plant makes the installation costs decrease, because only the chiller equipment is necessary.

Another application of trigeneration would be District Heating & Cooling but in Spain is still not spread, because of the difficulty of carrying out the installation and the heavy costs that it involves.

⁵ The list was not exhaustive but the most significant plants were represented.

- Suitability: Trigeneration systems are an efficient way of recovering “waste” heat (through absorption or adsorption chillers) or electricity (compression chillers) generated with CHP systems to produce cold as well as heat and electricity. The wind power peaks can be reduced when both types of chillers (heat-fired and electricity-fired) are installed in combination with the CHP plant. When an excess of electricity exists, compression chiller is used to produce cold, and when more electricity is needed, the surplus heat is used to produce cooling with absorption or adsorption chillers.
- *The main characteristics of trigeneration* are the high efficiencies and not very costly equipment and installation when a CHP plant exists

5.3.2 Comparison with CHP

Trigeneration systems are more efficient than CHP systems, as already stated in section 1.2. On the other hand, installation costs are greater, as cooling equipment is also needed.

CHP systems usually have a high thermal to electric ratio, so either they do not produce all the electricity required, or have excess heat. Since the trigeneration system uses more heat than CHP, more electricity demand can be satisfied locally and, thus, wind balancing ability is also greater. Besides, the increase on thermal demand will also probably increase the need for thermal storage, which also increases balancing ability.

5.3.3 Economic assessment: Costs, historical and future cost development

For the economic assessment, the same example as in Section 2 will be used. The analysis will consist in comparing the energy bill before the implementation of the trigeneration system and the energy bill after implementing the system. Then energy bill savings will be compared to the required investment, to determine whether savings pay for the investment.

Gas prices are updated every three months and electricity prices have been updated in the middle of 2006, but, for simplicity reasons, constant gas and electricity prices will be considered for the whole year. Prices to be taken into account are for the first quarter of 2006.

Before implementing the trigeneration system, gas consumption was 515 977 kWh/year, with a maximum demand of 450 kW. Electricity demand was 1 073 198 kWh/year, with a maximum of 230.20 kW. According to 0, gas price is 135.07 €/month and 0.021852 €/kWh (annual consumption between 500 000 kWh and 5 000 000 kWh). Therefore, gas bill before implementing the trigeneration system is:

$$\text{Gas bill}_{\text{before}} = 135.07 \text{ €/month} * 12 \text{ months/year} + 0.021852 \text{ €/kWh} * 515\,977 \text{ kWh/year}$$

$$\text{Gas bill}_{\text{before}} = 12\,895.97 \text{ €/year}$$

Regarding electricity bill, it must be taken into account the payment for accessing the grid and the payment for the electricity to be bought in the market. According to 0, energy and capacity terms for installations with a capacity above 15 kW depend on the time of consumption, as Table 5-17 shows:

Table 5-17. Access tariff components

	Period 1	Period 2	Period 3
Hours: Winter	18-22	8-18/22-24	0-8
Summer	9-13	8-9/13-24	0-8
Capacity term (€/kW/year)	21.551694	12.753270	2.767759
Energy term (€/kWh)	0.018980	0.017331	0.013712

The market prices to be taken into account correspond to day-ahead market, as most transactions are made in that session. Data are obtained from the market operator's homepage 0, and monthly average values for each hour are used. Values include the period between December 2005 and November 2006. Electricity bill is then obtained by adding the capacity term and the energy term, which includes the access tariff and the market price. For the capacity term, maximum demands in each period must be taken into account, which, in this case, are 231.04, 224.06 and 183.8, for periods 1,2 and 3, respectively. As a result, electricity bill was:

$$\text{Electricity bill}_{\text{before}} = \Sigma (\text{Max.demand} * \text{Capacity term})_{\text{period}} + \Sigma (\text{Demand} * \text{Energy term})_{\text{hour}} + \Sigma (\text{Demand} * \text{Market price})_{\text{hour}}$$

$$\text{Electricity bill}_{\text{before}} = 209\,040.26 \text{ €/year}$$

Consequently, total energy bill before implementing the trigeneration plant is the addition of gas bill and electricity bill:

$$\text{Energy bill}_{\text{before}} = \text{Gas bill}_{\text{before}} + \text{Electricity bill}_{\text{before}}$$

$$\text{Energy bill}_{\text{before}} = 221\,936.23 \text{ €/year}$$

Once the trigeneration plant is installed, gas consumption increases, but the tariff to be used is the same, so only consumption will be different from the previous bill:

$$\text{Gas bill}_{\text{after}} = 135.07 \text{ €/month} * 12 \text{ months/year} + 0.021852 \text{ €/kWh} * 935\,422 \text{ kWh/year}$$

$$\text{Gas bill}_{\text{after}} = 22\,061.68 \text{ €/year}$$

Now, electricity consumption is lower than in the case before, and also maximum hourly demands: 201.09, 205.71 and 179.94 for periods 1, 2 and 3. In this case, there is some extra electricity to be sold in the market at certain hours, so, at these hours, the value of the energy term of the access tariff will be zero. Electricity bill after implementing the trigeneration system is therefore:

$$\text{Electricity bill}_{\text{after}} = \Sigma (\text{Max.demand} * \text{Capacity term})_{\text{period}} + \Sigma (\text{Demand} * \text{Energy term})_{\text{hour, demand}} + \Sigma (\text{Demand} * \text{Market price})_{\text{hour, demand}} - \Sigma (\text{Sales} * \text{Market price})_{\text{hour, sales}}$$

$$\text{Electricity bill}_{\text{after}} = 147\,126.38 \text{ €/year}$$

Adding up the two concepts, total energy bill after implementing the scenario will be:

$$\text{Energy bill}_{\text{after}} = \text{Gas bill}_{\text{after}} + \text{Electricity bill}_{\text{after}}$$

$$\text{Energy bill}_{\text{after}} = 169\,188.06 \text{ €/year}$$

Annual energy bill savings are obtained by subtracting the new bill to the old bill:

$$\text{Energy savings} = \text{Energy bill}_{\text{before}} - \text{Energy bill}_{\text{after}} = 221\,936.23 \text{ €/year} - 169\,188.06 \text{ €/year}$$

$$\text{Energy savings} = 52\,748.17 \text{ €/year}$$

The equipment required for this installation includes the two microturbines and the absorption chiller. Installation costs for a microturbine and for an absorption cooling device are about 800 €/kWe for each 0. Therefore, total investment is:

$$\text{Investment} = \text{Investment}_{\text{Microturbine}} + \text{Investment}_{\text{Absorption}} = (800 \text{ €/kWe/unit} * 135 \text{ kWe} * 2 \text{ units}) + (800 \text{ €/kWe/unit} * 135 \text{ kWe} * 2 \text{ units}) = 216\,000 \text{ €}$$

Different investment criteria will be analysed:

1. Single payback period (SPP):
$$SPP = \frac{\text{Investment}}{\text{Savings}} = \frac{216\,000.00}{52\,748.17} = 4.09 \text{ years}$$

2. Net Present Value (NPV): Assuming a discount rate of 7%, accumulated NPV is positive in year 4, as Table 5-18 shows:

Table 5-18. NPV analysis for the investment

Year	0	1	2	3	4
Investment costs	-216 000.00	0.00	0.00	0.00	0.00
Savings	52 748.17	54 858.10	57 052.42	59 334.52	61 707.90
SUM	-163 251.83	54 858.10	57 052.42	59 334.52	61 707.90
NPV	-163 251.83	51 269.25	49 831.79	48 434.64	47 076.66
Accumulated NPV	-163 251.83	-111 982.58	-62 150.79	-13 716.15	33 360.51

3. Internal Rate of Return (IRR): For the same conditions as for the NPV, the IRR value in year 4 is 15.56%.

5.3.4 Environmental aspects

As described in “Yearly energy analysis” section (0), the use of trigeneration reduces the total energy requirements in the system, although local energy requirements increase. Therefore, the use of trigeneration reduces the emission of CO₂ and other pollutants.

Another improvement of the environment refers to the reduction of peak power plants. As described in the “Economic assessment” section (5.3.3), the use of trigeneration reduces peak demands in the three billing periods. As a result, highly-pollutant peak-power plants can be switched off, so that the improvement is even higher.

The only adverse impact of trigeneration is that it increases local emissions. Nevertheless, the improvement in the system as a whole pays for it, unless the trigeneration plant is located in a highly polluted environment.

6 Heat pumps (AAU)

6.1 Key findings

The purpose of this paper has been to explore options for using large-scale heat pumps for the purpose of relocation. Particular attention should be given to the following 5 key findings:

1. Large-scale compression and absorption heat pumps are competing options for increasing the overall efficiency of CHP production by utilizing condensed flue gas. In concurrent operation CHP plants with heat pumps (CHP-HP plants) reaches overall plant efficiencies of above 100% (based on LHV). While absorption heat pumps are currently better positioned market-wise and the preferred short-term choice by investors, only compression heat pumps may potentially serve the purpose of relocation.
2. While forcing CHP producers away from fixed tariffs onto market conditions (spot market and regulating market) has already effectively solved the problem of critical excess electricity production in the Danish energy system, additional instruments are being introduced to stimulate relocation-driven use of electricity. However, the L1417 instrument introduced in 2006 that reduces energy and environmental taxation on electricity use for district heating production at CHP plants without concurrent power production penalizes efficient use of electricity and excludes the use of compression heat pumps in favour of less efficient electric boilers.
3. In this paper, we are introducing the 1st generation CHP-HP Cold Storage (2007-2012) concept, that integrates CHP and heat pumps (HP) using heat recovered from flue gasses as the heat pump's heat source, storing this heat in a "cold storage" allowing for flexible and integrated operation of CHP unit and heat pump. The CHP-HP Cold Storage concept is the most effective CHP plant principle around, and would effectively stimulate a flexible and relocation-driven operational praxis in distributed generation. Furthermore, it implies a breakthrough for transcritical heat pump technologies and a first step towards the 2nd generation CHP-HP Cold Storage concept (2010-2015) that introduces supplementary low-temperature heat sources, like ground-source, allowing for greater flexibility, and higher HP production rates.
4. However, current taxation instruments, at least in Denmark, makes it difficult for CHP plants to opt for the CHP-HP Cold Storage concept despite its' system-wide benefits. Compared to the inflexible CHP-HP option with mechanical drive compression, CHP-HP Cold Storage with electrical drive compression currently results in annual financial cost savings that are lower for mechanical drive. In a specific case, for a CHP-plant currently on triple tariffs, both options will be subject to financial payback periods of 10 years or more. In conclusion, our assumptions about efficiencies, investment costs, prices shows that are it is likely that no break-through incentives in the current market place for large-scale heat pumps serves the purpose of relocation.
5. Aalborg University recommends for the Danish Parliament to allow for the compensation of energy and environmental tax of up to 10 % of self-produced electricity for use in compression heat pumps producing district heating (the 10%-instrument), which would be a targeted and suitable incentive for replacing current un-flexible distributed CHP plants with relocation-oriented 1st and 2nd generational CHP-HP Cold Storage plants, supporting higher penetration levels of wind power and CHP in the energy system.

6.2 Heat pumps and the principle of relocation

In February 2003, the Danish Ministry of Finance announced that a cost-effective climate strategy for Denmark [1] should be based not only on the continued build-up of wind power capacity (for what it is worth), but also include the penetration of large-scale heat pump projects "substituting" combined heat and power production. MoF's initial assessment indicated a potential of 1,5 mill. ton of CO₂ per year from 2012 at an economic CO₂ shadow cost of DKK -60 (negative sixty) per ton of CO₂ for decentralized CHP, and 5,0 mill. ton of CO₂ per year at an economic CO₂ shadow cost of DKK 250 for centralized CHP, i.e. a combined CO₂ reduction potential of 6,5 mill. ton per year, or about 13% of the Danish energy sector's CO₂ emissions in 2002.

The appropriateness of such strategy is backed by more recent assessments by Aalborg University [2] which concludes that the introduction of large-scale heat pumps is a feasible option for sustaining an energy system with fluctuating electricity supply (CHP and wind), and quite recently also by the Danish Board of Technology [3]. This and other research introduces the principle of relocation and provides theoretical energy balances and cost assessments that involve electricity use for heat production, even substantiating comparative preference to heat pumps over electric boilers.

In December 2006, the Danish system grid authority (energinet.dk) announced awarding Aalborg University, EMD International, and Danish Technological Institute DKK 11 mill. for a full-scale demonstration project that attempt to exploring the feasibility of integrating a large-scale heat pump using CO₂ as working fluid with an existing distributed CHP plant.

The analyses includes with this paper relates to concepts of integrating large-scale heat pumps with CHP plants in general, and to the concept of CHP-HP Cold Storage in particular.

6.2.1 The principle of relocation

High penetration levels of intermittent energy resources and combined heat and power (CHP) plants require innovations with respect to storage and relocation, i.e. system flexibility by storing energy or by bridging energy carriers [4]. This paper explores large-scale heat pumps as a relocation technology.

Figure 6-1 illustrates the principle of relocation in a 2nd generation sustainable energy system. The heat pump provides cooling and heat, using either mechanical or electrical drive to produce the required work.

While this paper focuses on the application of large-scale heat pumps used for heating purposes in district heating and industry, it will initially review the main principles and technology applications with respect to the principle of relocation.

6.2.2 Early modern large-scale heat pumps

In 1980, the world's largest compression heat pump was established in Frederikshavn, Denmark. The 10 MW_q heat pump was powered by a diesel generator, using sewage discharge as the low-temperature heat source, and supplying district heating to the municipality. Around the same time, Ronneby Municipality, Sweden, installed a 0,5 MW_q diesel-powered compression heat pump to supply heating to 55 individual houses. This heat pump was using ambient air as the low-temperature heat source.

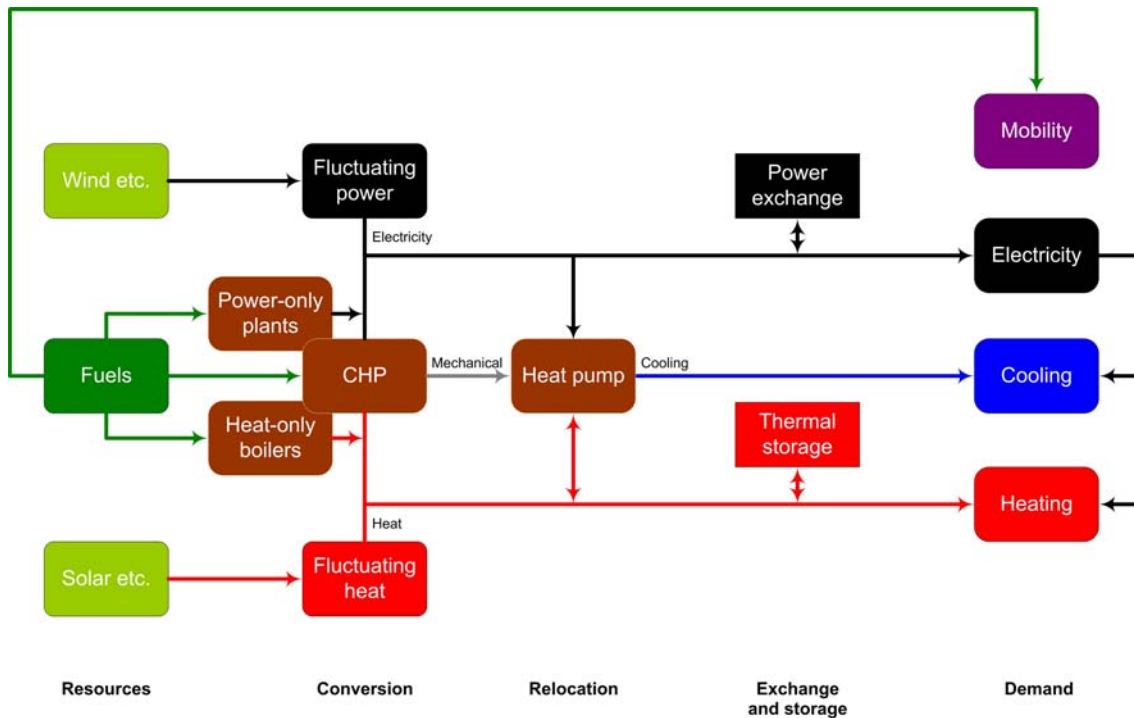

Figure 6-1: 2nd generation sustainable energy system introducing relocation and thermal storage for added operational flexibility

Both experiments were later terminated due to operational challenges. In 1987, the Frederikshavn heat pump was replaced by a natural gas fired CHP plant, and in 1993, the Ronneby heat pump was replaced by a wood-fired boiler. While these projects turned out to be long-term misfits, valuable experiences for future large-scale heat pump systems were produced:

1. The delivered heat should meet the actual needs of the heat takers. In Ronneby, no supplemental heating supply in a low-temperature district heating design with a 60°C plant temperature did likely not satisfy consumers.⁶
2. The heat pump's integration with the operational profile of other elements in the system of operation should be carefully assessed. In Frederikshavn, the prioritized district heating production from the local MSW plant severely restricted the operational space for the heat pump.
3. The design efficiency should carefully match the operational efficiency. In Ronneby, the design COP of 2,0 turned out to be less than 1,6 under actual long-term operation. In Frederikshavn, the actual operational COP of 1,8 was however according to design.
4. The potential threats from using particular working fluids should be carefully assessed. Both Frederikshavn and Ronneby were using the most aggressive ozone depletion and global warming potent cooling liquids (R114 and R12)⁷ in complex mechanical driven heat pump systems. In fact, Frederikshavn had particular problems with leaking sealings [5].

⁶ My hypothesis.

⁷ R12, dichlorodifluoromethane, ODP: 0.95, GWP (100): 10,600; R114, dichlorotetrafluoroethane, ODP: 0.70, GWP (100): 9,800.

5. Particular technical challenges points to flue gas cooling heat exchanger corrosion and leaking sealings.
6. None of these heat pump applications would fit well within a 2nd generation sustainable energy system as they are mechanically powered and do not provide any significant flexibility.⁸

The large-scale plants in Frederikshavn and Ronneby represent an early phase of modern heat pump technology application for district heating purposes. Much has happened since 1980, most notably the nation-specific widespread dissemination of individual heat pumps with supplemental electric heaters, in the US and Japan often combined with A/C, the integration of large-scale heat pumps with combined heat and power plants, including MSW plants, in Sweden and Denmark, and the application of large-scale heat pumps for the utilization of low-temperature geothermal resources.

Sweden is particular rich with past and present case studies; large-scale heat pumps with heat capacities between 5 and 40 MW are found in Stockholm, Gothenburg, Solna, Örebro, Borlänge, Eskilstuna, and Malmö, using sea water or purified sewage water as low-temperature source. In Lund, Sweden, a large-scale heat pump utilizes low-temperature geothermal water.

6.2.3 Selected existing large-scale heat pump applications

In fact, Sweden is the dominant European arena for heat pumps, both in terms of individual and large-scale heat pumps for district heating. In 2005, 100,000 individual units, mainly ground-source or rock-source, were installed, or about one third of the total number of units sold in the European market for individual heat pumps. And in 2004, 12% of Sweden's district heating production was supplied by heat pumps operating at an average COP of 3,5⁹ [6].

As such, it is not surprising that the world's largest district heating compression heat pump is located in Sweden, in the town of Umeå, where it has been in operation since September 2000. The 3,4 MWe heat pump uses R134a for working liquid and is an integrated component of a 15 MWe CHP plant that uses wood and industry waste for fuel. The heat pump utilizes condensed flue gas, and delivers heat at an output temperature of 70°C, which is subsequently heated further by turbine condensation to a grid delivery temperature of 105°C. A rather low 10 degree temperature lift allows for an average COP of about 4,0. The heat pump can only be operated concurrently with the CHP plant, reportedly raising the overall efficiency from 94% (without heat pump) to 107% (with heat pump) based on the lower heating value.

But other significant large-scale heat pumps applications are found in the Netherlands, in Norway, and in Denmark.

In Swifterbant, the Netherlands, what is probably the largest ground-source (non-geothermal) heat pump system in operation, 10 couple ground-source heat pumps supplies 79 houses with heating at an average COP of 2,2. Supplementary individual in-house heat pumps are used to supply hot tap water.

In Trondheim, Norway, a large shopping center is cooled and heated by a heat pump system that during the heating period uses the cooling distribution system of a telecommunication centre

⁸ Innosys, who designed a natural gas powered heat in Ejby in 1984, during a period of evaluation in 1997 said that the major experience from operation is that the heat pump should preferably be split into an electricity producing part, and an electricity using heat pump.

⁹ It is unclear to me whether absorption heat pumps integrated with CHP are included in these statistics, and if so, how. Likely, they are not included.

next-door as the heat source. In the summertime, the heat pump operates mainly for cooling, during which excess heat is distributed to pre-heat sanitary water in a neighbouring hotel. The COP for heating is 3,5.

The last application includes here is Vestforbrændingen, Denmark, an MSW plant, which in December 2006 began operating a flue gas condensation system with two absorption heat pumps.¹⁰ The plant extracts 8,3 kg of steam per second at 163°C to produce 32-43 MW of district heating, equivalent to a COP of 1,9-2,5¹¹. While the applied principle has not focused on adding any relocation-driven flexibility to the operation of the plant, it does in principle allow for the extracted steam either to be used for electricity generation¹², or for the heat pump.

These four large-scale heat pump applications represent the variety of the currently best available technologies in large-scale pumps. However, none of these applications provides any flexibility with respect to relocation-driven use of electricity.

6.2.4 Relocation-relevance of heat pump principles and technology applications

In conclusion, existing large-scale heat pump applications are not operated or possible to operation according the principle of relocation.

While an average COP of 3,5 suggest for Swedish heat pumps to be mainly closed-cycle compression systems, various heat pump principles are applied for district heating, individual heating, and industrial purposes.

Table 6-1. reflects on the likely relevance with respect to the principle of relocation of various heat pump principles and technology applications.

Transcritical compression heat pumps that allows for the operation of heat pump with no supplemental heat production (temperature lift), allowing production to thermal storage, is arguably the most promising heat pump technology awaiting application.

The question for researchers and practitioners is how large-scale heat pumps are better designed for the optional purpose of relocation, while assessing the comparative consequences of competing concepts for doing so. The research at AAU is focusing on a particularly promising candidate in this respect; the CHP-HP Cold Storage concept, introduced below and assessed preliminary, which utilizes the principle of transcritical operation.

¹⁰ While the absorption principle is not an obvious choice with respect to the principle of relocation, as explained later in more detail, it is important to include here, as it is a major alternative option for utilization of flue gas condensation, the relevance of which will appear from the introduction of the CHP-HP Cold Storage below.

¹¹ Energy value of extracted steam can be made a matter of interpretation. In this case, the COP is calculated from the enthalpy of evaporation of the extracted steam, which, at 2 GJ per ton at 30 tons per hour equals 60 GJ, or 16,7 MWh.

¹² At the cost of decreasing overall plant efficiency.

Table 6-1. *Heat pump principles and applications, and relocation relevance.*

System	Applications	Efficiency	Relevance
Closed-cycle compression	Applied for production of heat/ cooling in industry and for district heating/cooling. Maximum output temperature given by working fluid. For ammonia and other non-transcritical working up to 70 °C. Transcritical operation using CO2 allows for exit temperatures up to 120°C.	Typically from 1,5 to 5,0 dependent on temperature lift and the nature of the low-temperature heat source.	Highly relevant, in particular with respect to transcritical operation, e.g. using CO2 as working fluid, enabling output temperatures that allows for the operation of heat pump with no supplemental production, allowing production to thermal storage.
Absorption	Applied either as heat pump or heat transformer. As heat pump, with water/lithium bromide as working pair, output temperatures up to 100°C, temperature lift up to 65°C. New technology (two-stage) up to 260°C and higher temperature lifts and COPs. Limited use of drive energy. Heat transformers with no external drive energy, up to 150°C, lift 50°C. Widely applied for heat recovery in refuse incineration plants in Sweden and Denmark.	Typically from 1,2 to 1,4 for heat pump operation according to IEA (obviously the principle for the calculation the COP is open for translation, as mentioned above).	Relevant for further investigation, however limited drive energy is applied, or not at all. Allows for increased flexibility in plant operation due to increases in heat production. A widespread alternative to closed-cycle compression heat pumps in terms of cost-effective heat recovery, resulting in very high overall plant efficiencies, but without any relocation potential.
Adsorption	Applied as heat pump, e.g. by adsorption of ammonia into active carbon [7] or water into silica gel.	?	Highly relevant for further investigation, but only with respect to the principle of chemical storage of heat, not for relocation.
Stirling or Stirling-Vuillumier	Multifunctional heat pumps, often heat assisted, using gas-engine drives.	2-2,4 for gas-engine drive [8]. Possibly 3,0-4,0 for electric drives.	Highly relevant alternative to closed-cycle compression system. Currently few practical experiences from large-scale operation, mainly used for cryogenic cooling systems in which Stirling excels.
Vapour recompression	Vapour is compressed to a higher pressure and temperature, and condensed in the same process giving off heat. No evaporator, no condenser, small temperature lift (from 70-80°C to 110-150°C, up to 200°C). Typically H2O as working fluid.	COPs of 10 to 30.	No immediate relevance, though systems may be redesigned for electrical work rather than integrated industrial mechanical work, allowing for load-shifting.
Reverse Brayton	Recovering solvents from gases. Solvent laden air is compressed, and then expanded. The air cools through the expansion, and the solvents condense and are recovered.	N/A	Not relevant, does not serve any primary heating or cooling purposes.

6.3 CHP-HP Cold Storage

The innovative CHP-HP Cold Storage concept (CHP-HP-CS) provides a solution to problems previously faced when applying large-scale heat pumps in district heating. Furthermore, the concept provides relocation by allowing for greater flexibility in plant operation, allowing for efficient and flexible use of electricity for heat production.

In CHP-HP-CS, low-temperature heat recovered from flue gasses is recovered and stored when the CHP unit is in operation. The recovered heat stored in the cold storage is used as heat source for a transcritical compression heat pump, which is operational at very high COPs due to the relative high temperature level of the heat source and available for operation even without the CHP unit operating. When the heat pump operates it generates cold water for subsequent flue gas cooling and condensation. Temperature levels of cold storage will be in the range of 20-60°C, possibly integrated with the thermal storage, then operating in the range from 20-90°C (Figure 6-2).

With respect to the operation of a heat pump without concurrent operation of CHP unit or supplementary heat production, it was previously not possible reaching the required exit temperature for district heating, which is typically above 80°C. With a transcritical heat pump using CO₂ for working fluid, a technology successfully developed at Danish Technological Institute [9] being marketed through start-up company Advansor [10], this problem is solved in the CHP-HP-CS concept.

Aalborg University, EMD International, Danish Technological Institute, and Advansor join forces in a full-scale CHP-HP-CS demonstration project funded by Energinet.dk, the Danish TSO, to be implemented during 2007-2008.

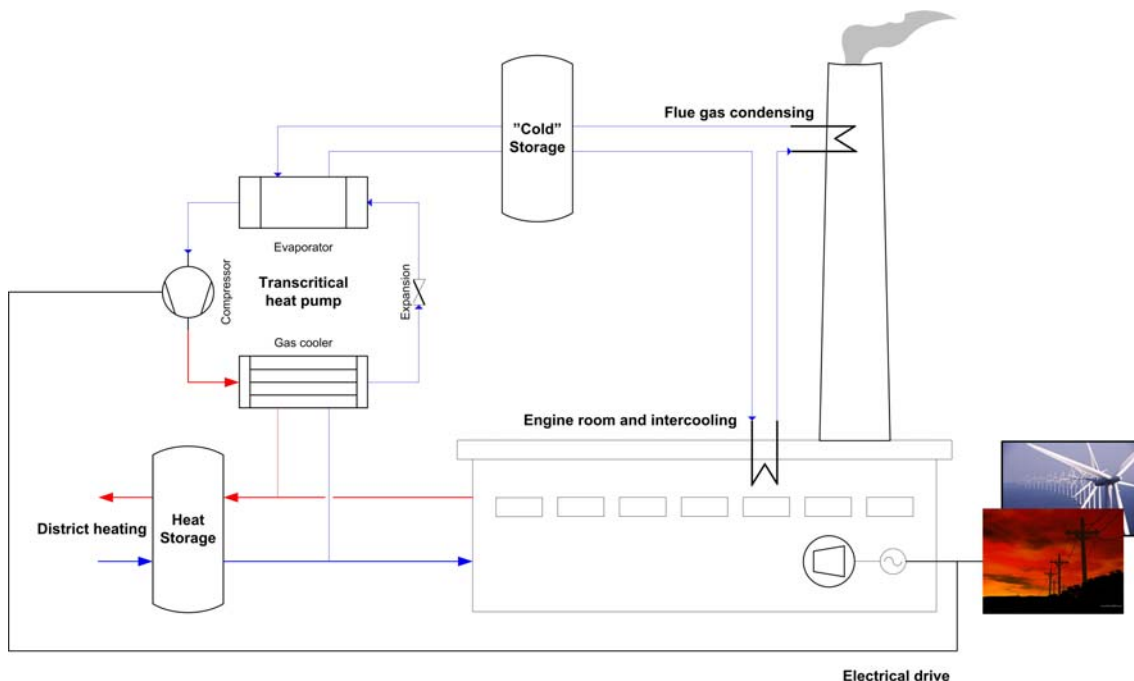

Figure 6-2: 1st generation CHP-HP Cold Storage concept for utilization of heat recovered from flue gasses, concurrent operation AND relocation possible (i.e. operation of heat pump unit or CHP unit).

Table 6-2. *Techno-economic datasheet for CHP-HP Cold Storage*

	Status	Scenario assumptions	
	2006	Low penetration	High penetration
Working fluid		CO ₂	
Electric capacity	Up to 10% of installed CHP electricity generating capacity		
Heating capacity	Around 30% of installed CHP heating capacity		
COP	3,7	3,8	3,9
Investment costs ¹³	DKK 19,5 mill. per MWe	DKK 19,5 mill. per MWe	DKK 15,0 mill. per MWe
O&M costs		0 ¹⁴	
Life time	20 years	20 years	25 years

Techno-economic research and results have been excluded from this paper due to limitations of space, but may be found in Blarke [4,11,12], articles all of which are acknowledging the DESIRE project.

6.4 Instruments for promoting relocation in distributed generation

The first step for introducing relocation and increasing the operational flexibility in an energy system with a high level of penetration of CHP and wind power like the Danish has been gradually to force decentralized power producers to operate on market conditions.

By January 2005, all Danish CHP plants above 10 MWe (49 plants @ 1.220 MWe) had moved away from fixed tariffs to market conditions (spot market, regulating market). Immediately, this effectively solved the problem of critical excess electricity production.¹⁵ In January 2007, all Danish CHP plants between 5 and 10 MWe (74 plants @ 438 MWe) are being moved to operate on market conditions. All plants below 5 MWe (684 plants @ 713 MWe) may continue on triple tariffs at least until 2015. As of January 2007, 144 plants will be operating on market conditions, representing about 70-75 % of total electricity generating CHP capacity.

As the introduction of market conditions have effectively made the integration of CHP and wind power more practical, additional instruments are required in preparing for the further penetration of wind power, and substitution of non-CHP utility units.

In December 2005, the Danish Parliament agreed on Law L1417 [13] that introduces incentives to promote the relocation-driven use of electricity. L1417 introduces changes to existing energy and environmental taxes, most notably with respect to the taxation of the use of electricity for district heating production, and is mainly intended to stimulate the introduction of electric boilers at existing CHP plants.

Prior to L1417 any use of electricity for heating production, also self-produced electricity, was subject to an energy and environmental tax of DKK 0,665 per kWh.¹⁶ With L1417 this tax is reduced to DKK 50 per produced GJ of district heating¹⁷, but applies on the condition of no

¹³ Based on case study, plant specific: HP unit 60%, Cold Storage: 14%, generator: 2%, optional stainless stack kernel replacement: 10%, optional LP heat exchanger replacement: 14%.

¹⁴ Meromkostning ift. eksisterende kraftvarmeproduktion. Baserer sig på en antagelse om at varmpumpeanlæggets D&V omkostninger dækkes af D&V besparelser for kraftvarmeheden.

¹⁵ According to information obtained from energinet.dk in November 2006 (Jens Pedersen).

¹⁶ DKK 0,576 per kWh (energy tax) plus DKK 0,09 per kWh (CO₂ tax).

¹⁷ DKK 45 per GJ (energy tax) plus DKK 5 per GJ (CO₂ tax).

concurrent production at the CHP unit. The instrument's particular condition of no-concurrency illustrates the operational strategy hereby introduced for balancing wind power and CHP: on demand, reduce CHP-production, while increasing relocation-driven use of electricity.

However, the mischief in this respect is that L1417 while promoting the relocation-driven use of electricity also penalizes the efficient use of electricity. As the new energy and environmental tax is calculated on the basis of district heating production, not on electricity use, the more efficient use of electricity, the higher the resulting tax per kWh of consumed electricity. While the tax for electricity used in an electric boiler is reduced by 73% (from DKK 0,665 per kWh to DKK 0,18 per kWh), the tax for electricity used in an efficient compression heat pump is reduced only by 5% (from DKK 0,665 per kWh to DKK 0,63 per kWh)¹⁸.

In result, the revised energy and environmental taxation scheme sustains the current situation for large-scale compression heat pumps, that, if found applicable, will, if compression heat pumps are favoured at all, result in the choice of mechanically driven compression, allowing only for concurrent operation of CHP-unit and heat pump. This result in fuel savings and high efficiency plant operation, however mechanical driven compression does not allow for relocation-driven use of electricity, as electrical drive potentially does. In fact, even for similar operational strategies, electrical drive is "disallowed" by existing energy and environmental taxation system.

In April 2006, communication with the Central Customs and Tax Administration is opening for the possibility that tax on the use of electricity in a CHP-HP-CS concept may be subject to principle that in praxis will burden a kWh of electricity used in a heat pump similar to that in an electric boiler.

However, looking forward to concept that includes external heat source, what kind of instrument would effectively stimulate the introduction of designs in distributed production that allows for relocation? Aalborg University is arguing for the introduction of an instrument that will allow for various CHP-HP concepts in the short-term future to be established using electricity-driven compression: the 10%-instrument. Aalborg University recommends for the Danish Parliament to allow for the compensation of energy and environmental tax of up to 10 % of self-produced electricity for use in compression heat pumps producing district heating.

The 10%-instrument would stimulate not only a more efficient CHP production for concurrent operation of CHP unit and heat pump, but also, in combination with L1417, support the relocation-driven use of electricity. Under the current Danish policy climate, the strength of this instrument is that it is arguably neutral with respect to fiscal revenues, as mechanical-driven and electrical-driven compression results in identical operation for concurrent operation of CHP unit and heat pump. Both options works similar to reducing electricity production, while increasing heating production, often reaching overall plant efficiencies of above 100 % (based on Lower Heating Value).

However, in praxis, the issue of fiscal revenues and other impacts is somewhat trickier, as the introduction of electrical-drive compression intentionally opens up for other concepts.

6.5 Conclusion and perspectives

Large-scale heat pumps should not be regarded an efficient alternative to electric boilers, but rather as an integrated system component that contributes to increased operational flexibility. In the future, large-scale heat pumps may be an efficient alternative to combined heat and power

¹⁸ For a COP of 3,8.

production, but in the short to medium term to solution is to research options that integrate large-scale heat pumps with distributed generators, maintaining the benefits of cogeneration, while allowing for balancing intermittent resources.

From a review of large-scale heat pump applications, it is found that large-scale heat pumps are never an off-the-shelf turn-key solution, but always appears as a customized industrial component being integrated with other plant components. There is a particular important reason for this: heat pumps utilizes a low-temperature heat source, either recovered heat from flue gasses, ground or rock-source, solar, sea, lake, waste water, ambient air, cooling demand, or intercooling. The availability of low-temperature heat source is highly localized. The specific availability and temperature level of this localized low-temperature heat source is used to settle for a particular operational design and resulting COP. As such, the COP may range from as little as 1 to above 5 depending here mainly on inlet temperature to the evaporator, i.e. the temperature level of the heat source.

The CHP-HP-CS concept is a solution to many of the problems associated with integrating large-scale heat pumps in to the energy system, while increasing the flexibility required for greater penetration levels of CHP and wind power. Targets could be to set to achieve market penetration for this generation concept during 2007-2012.

However, the 1st generation CHP-HP-CS may be seen only as the first step towards the 2nd generation CHP-HP-CS concept that introduces supplementary low-temperature heat sources, like ground-source, and even combines heat pumps and electric boilers. Targets could be to set to achieve market penetration for this 2nd generation concept during 2010-2015, *Figure 6-3*.

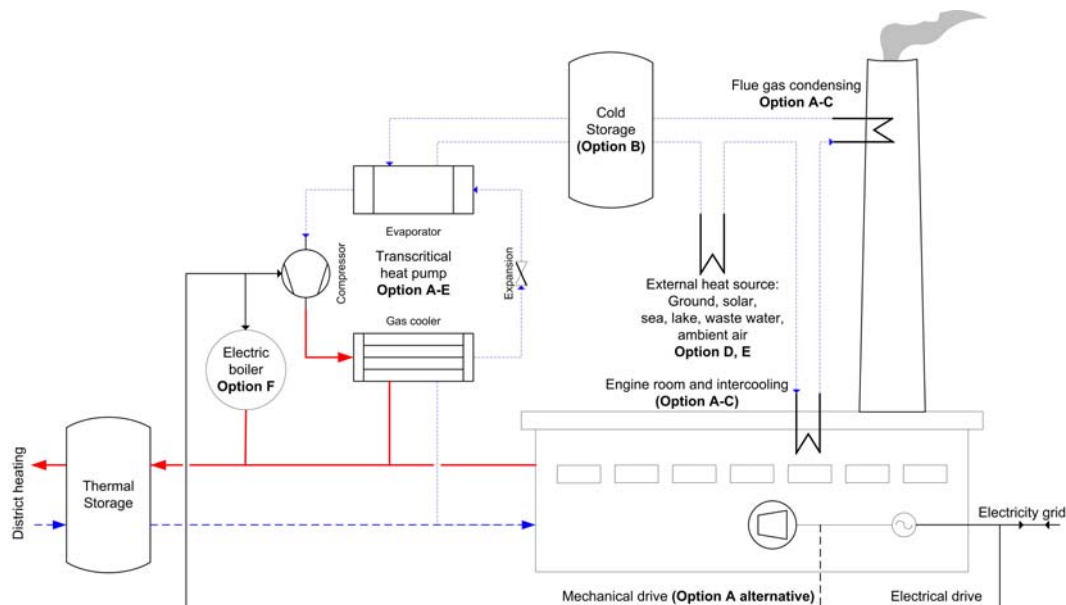

Figure 6-3: 2nd generation CHP-HP Cold Storage concept for utilization of condensed flue gas AND optional low-temperature source, like ground-source, possibly also combining heat pump and electric boilers.

Energinet.dk, the Danish TSO, is sponsoring a DKK 11 mill. demonstration project for a CHP-HP-CS demonstration plant being in operation no earlier than by December 2007. DESIRE partners Aalborg University and EMD will particular be involved in further developing system and project modeling methodologies under the project.

7 Fuel cells for balancing fluctuating renewable energy sources (AAU)

7.1 Technology Description

7.1.1 Introduction

CHP plants have proven to have good and efficient abilities to integrate fluctuating energy sources. The expansion of CHP systems is important to increase the overall fuel efficiencies in both energy systems with high amounts of fluctuating wind power and in systems with low amounts of fluctuating wind power. The efficiencies of the CHP plants themselves can be improved significantly by means of fuel cell technologies. These can improve the overall fuel efficiency further and reduce the environmental impacts connected to the production of energy. In these cells chemical energy is converted directly into electricity instead of traditional technologies where the energy content in fuels is converted into thermal energy, then mechanical energy and then electricity.

Although several types of fuel cells are currently being developed and demonstrated, for large stationary appliances or micro-CHP one kind of fuel cell is especially promising because of its high efficiency and fuel flexibility, solid oxide fuel cells (SOFC). Other kinds for fuel cells are more suitable for mobile or smaller distributed generation. The most promising fuel cells within these applications are proton exchange membrane fuel cells (PEMFC), because of their rather simple design and quick start-up.

For the task of integration of wind power and other fluctuating renewable energy sources the different fuel cells have different capabilities. Fuel cells, like other technologies, cannot be seen as an isolated improvement, but has to be assessed within the energy system surrounding it. In this section the advantages and disadvantages of using fuel cells for balancing fluctuating renewable energy sources is assessed.

7.1.2 Fuel cell characteristics, efficiencies and applications

All fuel cells have in common that the core consists of a cell with an electrolyte and two electrodes, the anode and the cathode. In Figure 7-1 the reactions in different fuel cells is illustrated. In the cell the hydrogen and oxygen is converted to water producing electricity and heat. The conversion of hydrogen takes places in a chemical process, where the catalytic active electrodes convert hydrogen into positive ions and oxygen into negative ions. The precise reactions depend on the type of fuel cell. The ions cross the electrolyte and form water and possibly CO₂ depending on the fuel and fuel cell. Only protons can cross the electrolyte creating

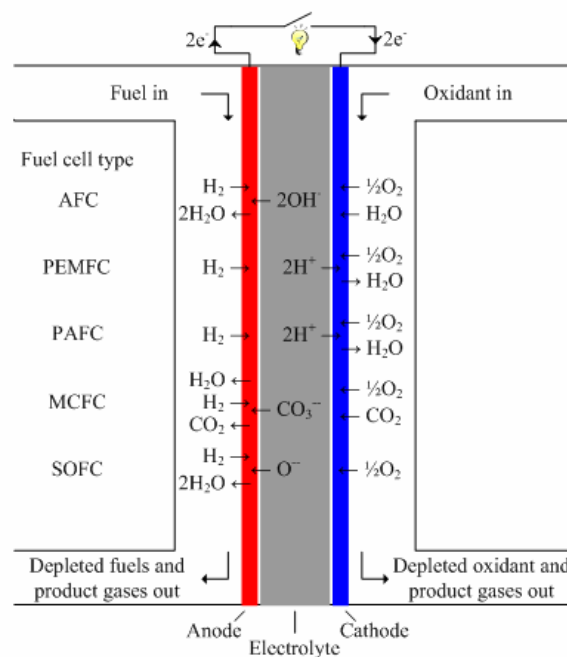

Figure 7-1: Schematics of different fuel cell types.

a voltage difference between the anode and the cathode in the cell. This voltage difference can create the current in a fuel cell system. [1]

Fuel cell types

In Table 7-2 the characteristics of the five main types of fuel cells are listed. Although some fuel cells are mainly considered for mobile and others for stationary use, this is not at all determined yet. The different characteristics of the fuel cells however, make certain potential applications more probable than others. The fuel cells are named after their electrolyte which also determines its operating temperature.

Table 7-2: Characteristics of the five main types of fuel cells and potential areas of use. [1-4].

* 75% electricity efficiency can be achieved when combined with gas turbines.

Fuel cells	AFC	PEMFC	PAFC	MCFC	SOFC
Name (electrolyte)	Alkaline	Polymer	Phosphoric acid	Molten carbonate	Solid oxide
Operating temp.	<120 °C	70-120 °C	150-200 °C	550-650 °C	500-1000 °C
Fuel(s)	Perfectly pure H ₂	Pure H ₂ or CH ₃ OH	Pure H ₂	H ₂ , CO, NH ₃ , hydrocarbons	H ₂ , CO, NH ₃ , hydrocarbons
Intolerant to	CO, CO ₂ , S	CO, S, NH ₃	CO, S, NH ₃	S	S
Future electric efficiency %	40	40	40	60*	60*
Potential area of use	Space, military	Mobile units, micro-CHP	Smaller CHP units	Larger CHP units	Small & large CHP units

For the *low temperature fuel cells* the advantages are mainly that the cells are compact, light weight and have a quick start-up potential. This combined with the fact that the efficiency can not compete with other power producing technologies, makes the most promising application transport and mobile applications where they can compete with the efficiencies of the existing technologies. For stationary appliances other technologies already have better efficiencies today.

Phosphoric acid fuel cells (PAFC) are widely used today as emergency power and stand-alone units in hospitals, schools and hotels. They have been commercially available since 1992 but the costs are still about three times higher than other comparable alternatives. The main problems are that they are dependent on noble metals for the electrodes and that the efficiencies are not much better than other technologies.

Alkaline fuel cells (AFC) are highly reliable and compact, but no widespread commercial use is expected, because of the cost of the extensive gas purification needs. CO₂ in ambient air has to be completely removed via scrubbing and if hydrogen is derived from fossil fuels it also needs to be purified.

There are different variants of PEMFC available. These cells are characterised by a rather simple design and fast start-up. The conventional PEMFC at 80 °C is easily poisoned by small amounts of CO. Higher temperature PEMFCs are being developed in which gaseous water is used. These cells are rather promising. Even though they still contain platinum which makes them more expensive, the amount has been reduced significantly. The system is simpler than the conventional cells because of fewer problems with water management, cooling etc. These higher temperature PEMFC are more tolerant to CO, which makes the fuel processing simpler. Another variant of PEM is the direct methanol fuel cell (DMFC) which uses methanol directly

without prior external reforming. These are mainly considered for small portable devices such as mobile phones, computers etc.

For *high temperature fuel cells* the two main advantages are the higher efficiencies and the fuel flexibility. Other advantages include that the high operating temperatures allow internal reforming or direct conversion, which enables a rather simple system design. Also they consist of rather cheap materials and do not contain noble metals.

In molten carbonate fuel cells (MCFC) it is necessary to add CO₂ with ambient air on the cathode side. Also the molten carbonate is heavily corrosive, which is the main problem in these cells today. Research is still being conducted to improve the cells mainly for larger CHP and power plants.

Solid oxide fuel cells (SOFC) seem to be more promising as they have already proven rather long lifetimes and efficiencies. The main challenge for further improvement is to replace some of the ceramics with lower cost metals as the ceramics are rather expensive to produce. This is why efforts are being made to reduce the temperature to around 550 °C in order enable the use of metal-supported SOFCs. At the moment the temperature has been reduced from 1.000 °C to 700 °C. Another challenge for the cells is temperature gradients in start-up and shut-down which require matching thermal expansion characteristics. This problem is also reduced with lower operating temperatures.

Overall the higher temperature PEMFCs and high temperature SOFCs are the most promising for the mobile and stationary appliances. These two technologies are elaborated in the following sections.

Fuel supply

To a large extent, the balance of plant equipment for all types of fuel cells is the same. One major exception is that the low temperature requires fuel pre-reforming into hydrogen whereas the high temperature fuel cells can reform natural gas and other fuels internally or use these directly in the conversion. These fuel processes are connected to losses which are not taken into account for the lower temperature fuel cells in Table 7-2 since these efficiencies are derived when using hydrogen in the fuel cells. For high temperature fuel cells hydrocarbon based fuels may have even higher efficiencies than indicated in the table.

Since hydrogen is not readily available it has to be procured by electrolyses or reforming of hydrocarbons. The maximum electricity-to-hydrogen efficiency in electrolysis is 84,5% no matter which technology is used. In the future electrolysis may be based on reversed or reversible PEMFCs or SOFCs. Various losses such as the system energy usage, activation losses and leakages will however occur. The electricity-to-hydrogen efficiency of commercially available electrolyzers can be up to 73% today. [5-7]

For fuels reforming the theoretical achievable efficiencies vary from fuel to fuel. Methanol has the highest potential efficiency, 96%, which, in combination with rather mild reforming conditions, is considered promising [8]. Other fuels such as natural gas and ethanol also have rather high potential efficiencies and have the advantages that the infrastructure is already widely spread. Hydrogen and methanol have unsolved problems concerning infrastructure such as storage. The most promising energy carriers concerning weight and volume are methanol and ethanol.

The fuels also have to be clean for the substances which the fuel cells are intolerant to. All cells have to be fitted with a de-sulphuriser and the lower temperature cells also have to have CO,

CO₂ and NH₃ removed, depending on the type of cell. The intolerances of the fuel cell are listed in Table 7-2.

In the SOFCs the electrolyte allows oxygen to pass from cathode to anode. In the PEMFCs hydrogen passes from anode to cathode. For the SOFCs this means that a wide range of fuels including natural gas, biogas, ethanol, diesel, LPG, methanol etc. can be used without the requirement to reform the fuel completely into hydrogen and CO₂ prior being processed in the fuel cell [9].

Efficiencies, start-up times and regulation abilities

It requires a stack of cells to deliver direct current at high voltage. In a stack individual cells are connected in series divided by interconnectors. The interconnector is a bipolar metal plate that distributes the electricity produced. To form a power unit, the fuel cell has to be fitted with an appropriate support system and research is still being done to improve the fuel cell systems, for example different heat recovery systems for the fuel supply. The fuel processing system requires reforming and the supply system has to deliver fuel and air under the right conditions, i.e. temperature, pressure, moisture and mix. The fuel supply and reforming systems are the major challenges for fuel cells on the system level.

After the electricity production in the fuel cell an inverter has to change the current from DC to AC which also is connected to losses. Other power electronics can give the fuel cells the same abilities as other traditional power supply units concerning grid stability. [1]

The high temperature fuel cells can be used in combined cycle systems, potentially improving the electricity efficiency from 60% up to 75% by adding gas turbines. Both PEMFC and SOFC can be used as CHP units. The total efficiency of both micro-CHP and larger CHP based on fuel cells can potentially reach 90%. These CHP-systems can function in the same manner as some of the existing CHP-systems i.e. be connected to the natural gas grid and combined with heat storage. In Figure 7-3 the conceptual design of a solid oxide fuel cell is illustrated. If hydrogen is used, an electrolyser or fuel reformer has to produce this prior the usage in the plant.

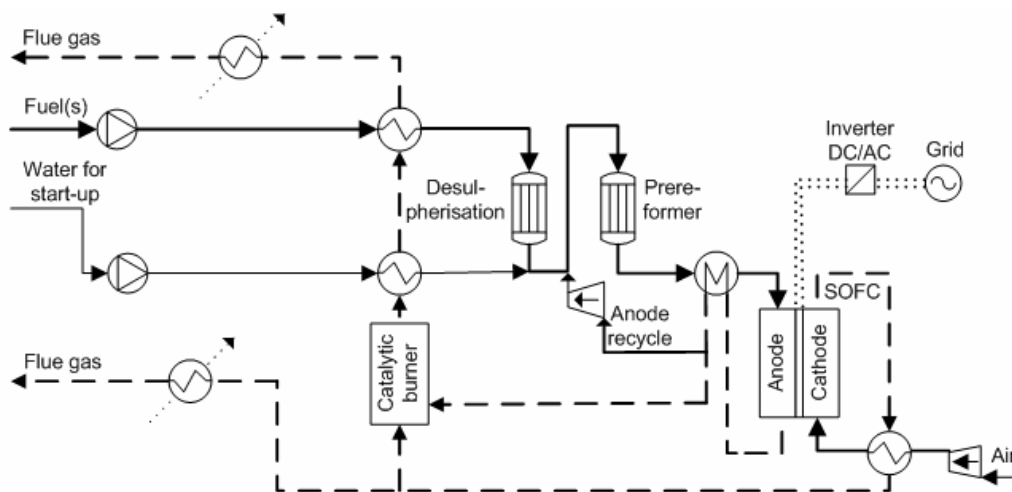

Figure 7-3: Conceptual design of a solid oxide fuel cell combined with a gas turbine.

For fuel cells such as PEMFC and SOFCs up- and downscaling does not interfere with the efficiency. Power density of the fuel cells however can be affected, if the support systems or the power electronics are less scalable.

PEMFCs have very fast start-up because of the rather low operating temperatures. High temperature PEMFCs may even prove to have the shortest start-up time of the two because of less problems with liquid H₂O. This on the other hand is a challenge for SOFCs because these have more problems with temperature gradients than PEMFCs. The SOFCs are several hours to start-up because of their high operating temperature and the temperature gradients. These problems however can be reduced by fitting the cells with start-up burners, or as a more promising alternative, keeping them at a high temperature by operating them periodically and with insulation [10]. SOFCs can be operated on low amounts of fuel and producing very little electricity but keeping the temperature at the right operation level.

When in operation both types of fuel cells have very fast regulation abilities, enabling them to have properties similar to batteries. Fuel cells also have good part load efficiencies between 20 and 100% load. This, in combination with the rather low heat production and good regulation abilities, enables them to be a flexible market player.

7.2 Calculations of fuel cells wind balancing abilities

The characteristics of fuel cells give the technology a strong potential to be combined with large amount of fluctuating renewable energy. Analysis shows that high temperature fuel cells, such as SOFC are better than conventional power plants with high amounts of wind turbines.

If fuel cells are able to remove the necessity to have running capacity available at all times and can ensure grid stability, this can enable more wind power to be integrated efficiently and also increase the flexibility of the energy system [11]. However this requires that the cells are constructed so that they can regulate from 0-100% of the capacity, that the system is constructed with fast start-up and shut-down and is fitted with additional power electronics. Also it requires that wind turbines or technologies on the demand side are able to deliver grid stability. These requirements are already being made for new wind turbines. The high temperature SOFCs have proven good regulation abilities. By insulating the SOFC and adapting the operation in situations with prolonged stand still it may be possible to have fast start-up [10].

Based on the methodology in [12] the official reference energy system in Energy Strategy 2025 [13] for Denmark in 2030 has been analysed with increasing amounts of wind and with SOFCs with the abilities mentioned above. The analysis is conducted in the EnergyPLAN model hour-by-hour. The energy system's ability to integrate fluctuating renewable energy sources is illustrated in two different diagrams. One diagram shows the annual excess electricity production (in TWh) as a function of the renewable energy input in an open energy system. The less excess electricity production the better capacity of energy system to integrate fluctuating renewable energy sources. The other diagram shows the resulting fuel consumption (in TWh) in a closed energy system excluding the primary fuel consumption from renewable energy sources, in this case wind power. The less fuel consumption the better the system is to use the wind production efficiently. In the closed system the following strategy for handling surplus wind production is used: first the CHP production is replaced by boilers in the district heating systems, next the excess electricity production is utilised for electric heating and finally wind turbines are stopped. In both diagrams the production from wind turbines varies between 0 and 50 TWh equal to a variation from 0 to 100 percent of the electricity demand in the reference.

The analysis of the reference energy system has been made with the following restrictions in ancillary services in order to achieve grid stability: At least 30 percent of the power or as a minimum 450 MW (at any hour) must come from power production units capable of supplying grid stability such as central power stations and CHP units. At least 450 MW running capacity in large power plants must be available at any moment. Distributed generation from renewable energy sources and small decentralised CHP units are not capable of supplying ancillary services.

In the same energy system SOFC CHP plants are introduced. To illustrate the full potential of the SOFCs all CHP and power plants are replaced with the fuel cells. For smaller SOFC CHP plants the electricity efficiency is 56% and the thermal efficiency is 34%. In larger SOFC CHP and power plants the efficiencies are assumed to be 66% for electricity and 24% for heat. These efficiencies are considered achievable in 2015 [11].

The analysis is conducted on the reference energy system and an energy system where the CHP and power plants have been replaced by SOFCs. The energy system with the SOFCs is also analysed without the restrictions mentioned above, which these fuel cells potentially can enable in the future. As a base case the Danish reference for 2030 has also been analysed without CHP plants, i.e. the heat demand is met by boilers and electric heating. In Figure 7-4 the excess electricity production from 0 to 100 percent of the electricity consumption is illustrated. The energy system where the SOFCs can enable less restrictions has by far the best abilities to integrate wind energy. This is mainly due to the shift in the electric and thermal efficiencies, thus lowering the heat controlled production at the CHP plants.

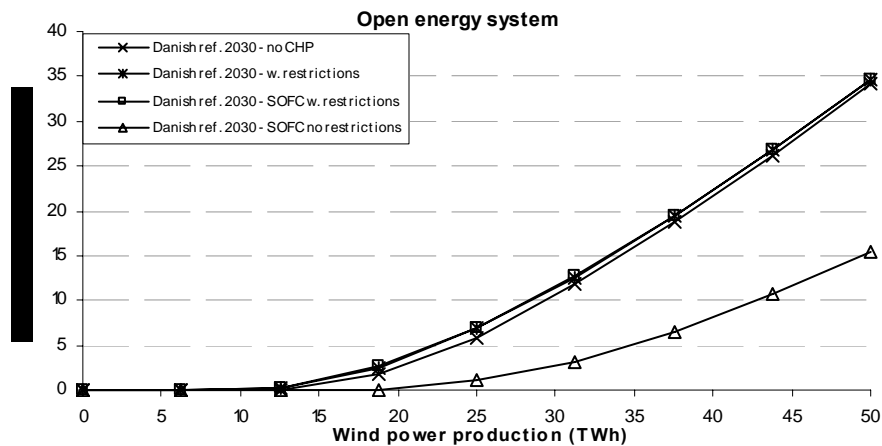

Figure 7-4: Excess electricity production.

In Figure 7-5 the primary energy consumption excluding wind power is illustrated for increased wind power production. The SOFC energy systems are significantly better at reducing the fuel consumption, because of their higher electric efficiencies. If the potential for very fast regulation abilities is achieved, the fuel consumption can be even lower, especially for wind production above 50 percent of the annual electricity demand in this reference. The energy system with no CHP plants is a bit better at reducing the excess electricity production. This is due to the fact, that there is no heat bound electricity production. As expected this energy system without CHP proves to be very inefficient because of the extensive use of boilers and electric heating.

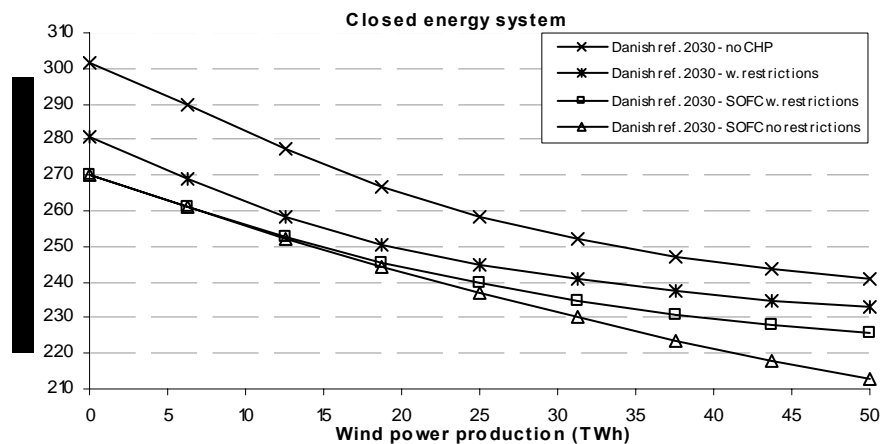

Figure 7-5: Primary energy consumption (PES) excl. wind power.

7.3 Assessment of fuel cells

In the perspective of using fuel cells for integration of fluctuating renewable energy the SOFCs are the most promising. These cells have the advantage of significantly higher electricity efficiency than competing technologies and fuel flexibility. Fuel cells in general also have the advantage of fast regulation abilities combined with excellent part-load efficiencies. Additionally scaling the cells from W to kW to MW is possible and does not influence the efficiencies of the cells. The feasibility of the scaling however depends on the market at hand and the fuel cells characteristics.

Wind integration can also be preformed with other types of fuel cells than the SOFCs such as PEMFC in micro-CHP. These however have the disadvantage that the efficiency is lower and require pure hydrogen. PEMFCs have advantages for mobile applications replacing internal combustion engines and batteries were feasible. For mobile applications the PEMFCs have the advantages that they can compete with internal combustion engines with fast start-up, fast regulation abilities and better efficiencies. In comparison with batteries fuel cells have the advantage that they have higher energy densities and can be refilled instantly, however the storage problems have yet to be solved. As storage and energy carriers methanol and ethanol are the most promising in regards to mass and volume. These can be used directly in SOFCs but have to be reformed for use in PEMFC.

New technologies that can provide energy system flexibility, such as SOFCs, heat pumps and heat storage technologies are more important than storing electricity as hydrogen via electrolysis in energy systems with high amounts of wind [12]. Unnecessary energy conversions should be avoided. However in future energy systems with wind providing more than 50% of the electricity and with the best measures for improving flexibility have already been taken, making fuels via electrolysis is one of the alternatives to integrate more renewable energy. Creating the road map to a 100% renewable energy systems require difficult choices between balancing fluctuating renewable with hydrogen production or electric cars, and on the other hand using biomass and bio fuels [11]. Fuel cells can have an important role in these future energy systems.

Investment cost

At the moment most types of fuel cells are at a development stage where only demonstration plants are being produced. The cost of fuel cells is still several thousand dollars pr. kW effect.

Both PEMFC and SOFC, which are considered to be the most promising cells, are expected to be competitive with other competing technologies within the next 10 years. The goal for the US Department of Energy (DOE) is that the prices of stationary application for SOFCs should be 400\$/kW before 2015 also for SOFC systems combined with gas turbines. The system should have 40.000 hours of durability. Reaching these cost reduction estimates require that the obstacles outlined above are dealt with. The cost for stationary SOFCs may prove closer to 1.000 \$/kW [11]. If the durability can be lower the costs can also be lower and SOFCs are also considered for mobile application. For PEMFC for transportation the goal for DOE in 2015 is 30\$/kW in 2015 with a durability of 5.000 hours [14]. The costs for other applications and for the other mentioned fuel cells are expected to be higher, though these may have other advantages [1].

It should also be mentioned that the maintenance cost can prove to be rather high in comparison with other technologies, especially concerning fuel cells for stationary appliances. The fuel cells themselves require little daily attention and can in principle be run automatically. However the stacks of cells in stationary appliances have to be changed periodically because of cell-degradation. Today this is connected to rather high cost because of the ceramics used. As these get thinner or replaced by other materials in future third generation metal-supported cells the maintenance costs may be reduced.

For PEMFC the main problems concerning cost may not be the cells themselves, but the storage and reforming systems. For SOFCs the infrastructure and storage problems and cost are significantly lower because of the internal reforming of hydrocarbons. When using the PEMFCs for mobile or stationary appliances the cost for new infrastructure and for reforming of fuels into hydrogen have to be added.

7.4 Environmental impacts

The environmental impacts of a fuel cell in operation are minute in comparison with other technologies. The global warming potential and emissions of CO₂ is directly linked to the fuel used in the cells. When using fossil fuels such as natural gas in SOFCs the CO₂ emissions per kWh are however lower than the traditional gas turbines, because of higher efficiencies.

Other emissions such as sulphur, NO_x and CO are expected to be very low, because of the fuel pre-treatment, higher efficiencies and direct chemical conversion. Sulphur has to be removed from the fuels so SO_x is not a problem like it is in combustion technologies. The sulphur emissions are virtually nonexistent. The NO_x emissions are also significantly lower and these emissions are connected only to the catalytic burner using unused fuel from the fuel cell for heat in the fuel supply system. The emission of CO is rather low for all cells, as it is used as a fuel in the higher temperature cells, and is poison and hence removed for the low temperature cells. There may be emissions of unused hydrocarbons, but this can be reduced in the system design. No non methane volatile organic compounds or NMVOC and particles are emitted from the cells. Also the cells are very quiet with almost no sound in operation.

Apart from the environmental impacts and resource consumptions in the operation of fuel cells impacts in a life cycle perspective is also important to investigate. Here one of the two most promising fuel cells, the SOFC, is investigated in a life cycle perspective. The primary energy consumption for the production the fuel cell is used as an indicator of the environmental impacts and resource consumptions. The development within the field of SOFCs has commenced from first generation electrolyte-supported cells, to second generation anode-supported cells. These are less costly to produce and also have less internal resistance [10]. The third generation metal-

supported cells are now being developed and will continue on this course, making the cells more efficient.

In Figure 7-6 the distribution of primary energy consumption for the production of materials and manufacturing of a first generation cell and system is illustrated. The dataset used in Figure 7-6 is based on a planar 1 kW SOFC from Karakoussis, 2001 [15] which can be considered as the first estimate of the likely environmental burdens connected to SOFCs. For this type of fuel cell the main part of the energy consumption is connected to production of materials. The production of chromium alloy used in the interconnector and the production of steel used for heat exchangers, air and fuel supply etc. are the two most important factors in the production stage of this fuel cells life cycle.

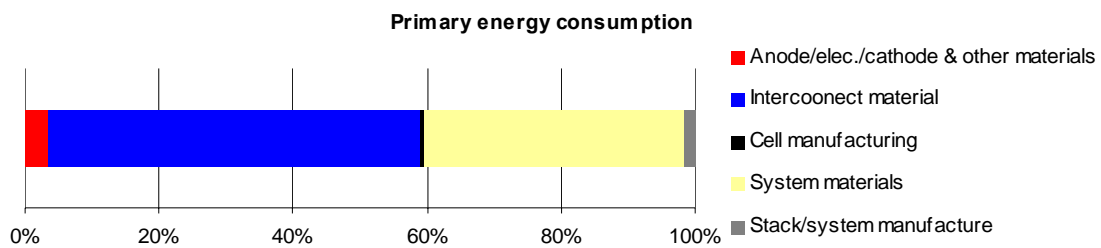

Figure 7-6: Distribution of primary energy for materials and manufacture of cell and system forming a fuel cell. The data is based on a 1 kW planer SOFC.

When the cells develop towards the third generation cells the relative contribution from the anode/electrolyte/cathode will diminish as these parts will become thinner and be supported by the interconnector. The interconnector may also become thinner as the cells develop, thus the system surrounding the cells themselves will become more and more important. The energy consumption to manufacture of the anode, cathode and electrolyte has been assessed using the energy consumption for aluminium production pr. mass in the cell analysed here. At this time, no exact data about the production of these materials in the cell itself have been acquired because of commercial confidentiality. Doubling the energy usage for manufacturing the anode, cathode and electrolyte has proved only to increase the total energy requirement for materials and manufacturing by 1.6 per cent. This is due to the interconnector made from chromium-alloy and the steel for the system which by far have the largest energy consumption in the cells themselves [15].

The production of the anode, cathode and electrolyte is not likely to be connected with larger energy consumption in the future and only contribute marginally to the total energy consumption in the production of the fuel cells. In addition to the cells, the system surrounding the cells is also connected to energy consumption. The system constitutes for approximately 40 percent of the energy consumption in this cell and also here the material production has a significant contribution.

The processes used in Karakoussis, 2001 are not optimised for mass production. As an example, the anode and cathodes are not co-sintered, thus increasing the energy demand in the data used here. Furthermore, no recycling of the materials in the system has been assumed, which can prove important for lowering the energy consumption for the production of materials for this fuel cell.

The power density of this fuel cell is 0.2 W/cm² and it has an operating temperature of 900°C. The power density of the fuel cell, i.e. the capacity of the individual cell pr. cm², is rather important pr. capacity for the amount of material and energy used for producing a fuel cell. The

power density is expected to exceed 0.5 W/cm^2 [10], which means that the energy consumption for producing a 1 kW fuel cell would decrease 40 percent. At this point in time 0.48 W/cm^2 has been performed in electrolyte-supported cells, and experimental second generation cells have performed 0.8 W/cm^2 [10]. Third generation interconnector metal-supported cells are still on the experimental stage. However, these are expected to increase the power densities even more. The running temperature is lowered to $550\text{-}650^\circ\text{C}$ as oppose to $900\text{-}1.000^\circ\text{C}$ in the first generation cells. This will lower the internal resistance. The power density will increase from the first generation cell analysed here and subsequently the overall energy consumption for producing 1 kW SOFC will decrease.

In Figure 7-7 the energy consumption pr. kW for producing the SOFCs and traditional power producing units is illustrated. Two SOFCs is illustrated. One with a power density of 0.2 W/cm^2 and another SOFC, where the same data are used, but is scaled for an improved power density of 0.5 W/cm^2 . The SOFCs are compared to the primary energy consumption for the production of a large coal fired power plant and for three sizes of gas turbine power plants, all of which represent today's technologies. For these power plants existing data from the EcoInvent database has been used. The EcoInvent database is one of the most comprehensive and up-to-date life cycle inventory databases available. The 2.500 processes, products, and services in the database are applicable in a European context [16-19]. This database contains data gathered in 2004 for processes, products, and services in the year 2000 and was constructed from several Swiss databases covering both data for Switzerland and for Europe.

The primary energy consumption for SOFC in the production stage is already more efficient than large coal fired power plants as power density higher than 0.5 W/cm^2 has been achieved. The lifespan however is still a problem and require further development. The coal fired power

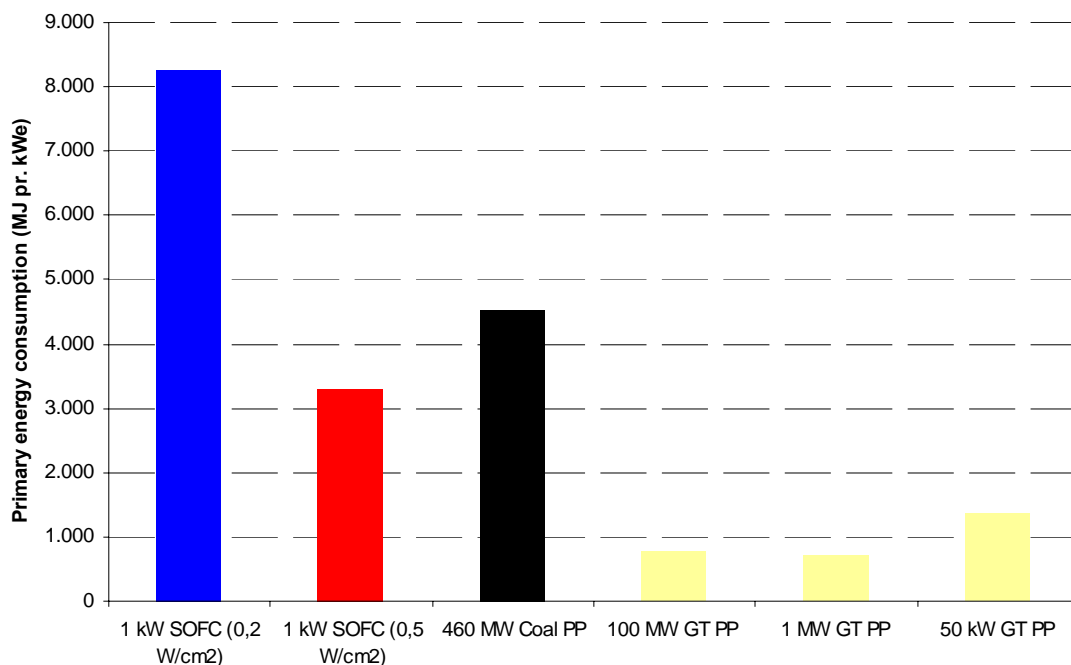

Figure 7-7: Primary energy consumption connected to the production of power producing unit pr. kWe.

plants are connected to large energy consumption pr. kW because of large amounts of steel. The gas turbines are still less energy consuming to produce than SOFCs. The SOFC would have to

reach a power density of 1 W/cm^2 and reuse at least one third of the interconnector and system material to be comparable to gas turbines in the production stage.

The most important part of traditional power producing environmental impact is in the operation of the plant. These environmental impacts are global warming, acidification, smog and eutrophication. For fuel cells the main part of acidification, smog and eutrophication is likely to be in the manufacturing stage of the fuel cell [15]. The main part of the contribution to global warming is in the operation phase if based on fossil fuels. If the operation of the fuel cell is based on biofuels the main contribution will also be in the manufacturing stage.

The environmental impacts in the operation of the SOFC are a lot smaller than for traditional power plants. The impacts in the manufacture and materials for the fuel cell are relatively more important, compared to traditional combustion technology because the emissions in the operation phase are smaller in the fuel cell. In Figure 7-9 the manufacture of a fuel cell is compared to other power plants, and it is evident, that the SOFC is already close to other technologies. When taking the manufacture and operation of the SOFC into consideration, the environmental impacts can potentially be reduced significantly when the cells are developed enough to replace other traditional combustion technologies.

8 Micro turbines (UniK)

8.1 Technology Description:

8.1.1 Introduction

A micro gas turbine is a small combustion turbine, i.e. a turbo machine converting chemical energy of a fuel via a combustor and an expansion turbine into heat and power.

The two main **fields of application** of gas turbines are transportation especially for aircraft, but as well for boats, trains and as prototypes for busses, trucks, cars and for power generation. In the last 16 years the situation in the German **power generation sector** e.g. was a growth in the number and installed capacity of gas turbines from 1.4 GW to 4.5 GW, /ASUE 2000/.

Table 8-1: Power range in different applications of micro turbines /ASUE 2001/

Field of application	Airplane	Generators/ Compressors
Power range in kW	500 – 40.000	500 - 230.000

Table 8-2: Development in the number and installed electric capacity of gas turbines /ASUE 2001/

Year	Number of installed turbines	Installed capacity in GW
1990	100	1.4
1998	1400	4.5

Gas turbine principle and components

Gas turbines consist of a compressor, a combustor and a turbine; see section through a turbine, *Figure 8-1*. The gas-turbine uses a continuous combustion process, in which compressed air is mixed with fuel, and burned under constant pressure conditions within the combustor. The resulting hot gas expands through the turbine to perform work. A part of this work is spent for compressing the incoming combustion air; the rest is available for other work, respectively as mechanical drive for electric power generation. The remaining heat remains unused or can be used as co-generated heat as part of a combined heat and power plant.

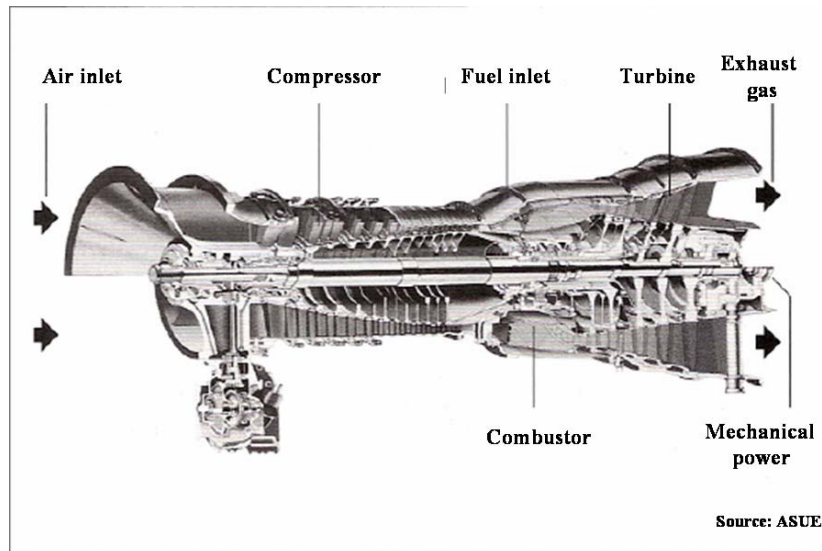

Figure 8-1: Section through an industrial gas turbine (airplane engine origin) /ASUE 2001/

Definition of Micro Turbines

Micro turbines are understood as the range of small turbines below **1 or 0.5 MW** electric capacity, generating electricity and using both electric and thermal energy as part of a combined heat and power supply /ISET/ /FVS 01/.

8.1.2 Efficiency of Micro Turbine CHP Units

In micro turbines chemical energy of the fuel is converted into electricity, useful and waste heat.

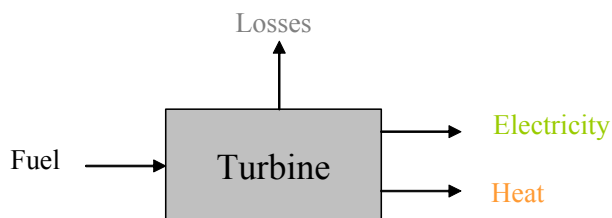

Figure 8-2: Micro gas turbine in- and output

Process Efficiency

The burning process in the combustor generates thermal energy from compressed air and fuel, see Figure 8-3. The hot exhaust gas performs work in the turbine where it is expanded (pressure and temperature are reduced) delivering mechanical energy for **powering generator** and compressor.

Colder and with low pressure the exhaust gas reaches the heat exchanger, where it is further cooled down to the **heat circuit** temperature level. The exhaust gas leaves the heat exchanger and the system with an air temperature above ambient temperature and including gaseous water – which is an exhaust gas component due to the hydrogen content of the fuel. This unused thermal energy is the main reason for conversion losses in the system.

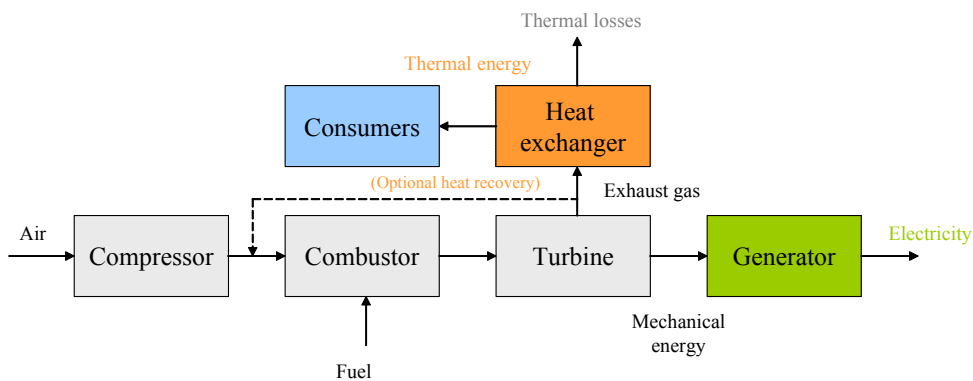

Figure 8-3: Micro gas turbine components

In order to **improve the process**, heat from the hot exhaust gas can be used to heat up the compressed air (optional heat recovery behind the compressor). This improves **mechanical and electricity** output, because it leads to a higher temperature in the turbine inlet, which is the most important parameter for improvements in converting heat into mechanical energy.

Further efficient techniques for higher mechanical and electric efficiencies are:

- **Steam injection (Cheng Cycle):** Thermal energy of the exhaust gas can be used to produce steam, which can be injected in the combustor. This allows electric efficiencies up to 42%, via a reduced thermal efficiency.

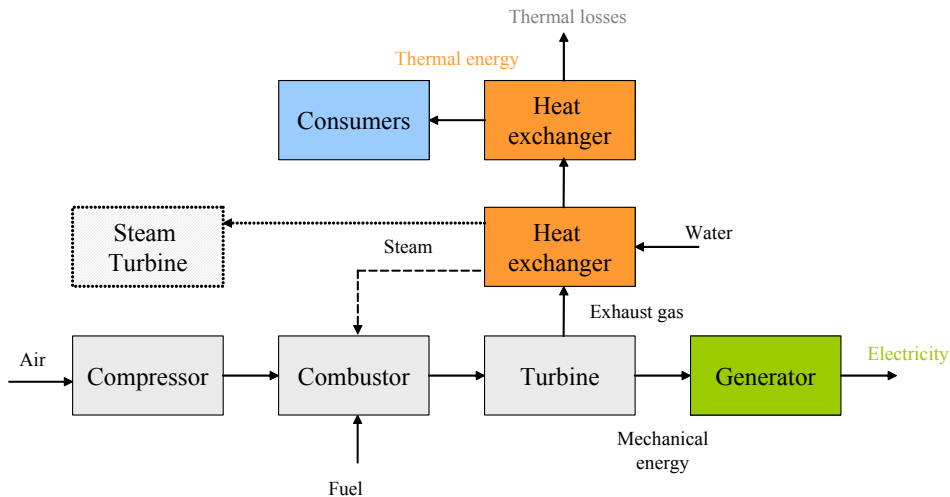

Figure 8-4: Process modification to enhance electric efficiency

- The **combined process of gas and steam turbine IGCC** (integrated gas combined cycle) leads the steam not back into the combustor, but through a steam turbine. This technique achieves electric efficiencies of 40 % in the industrial practice, but ambitious technical designs can even reach 60 %.
- **Full load operation:** Partial load should be avoided. Highest efficiency is achieved at full load, like illustrated in the following graph. This only full load operation can be realized best with a thermal store.

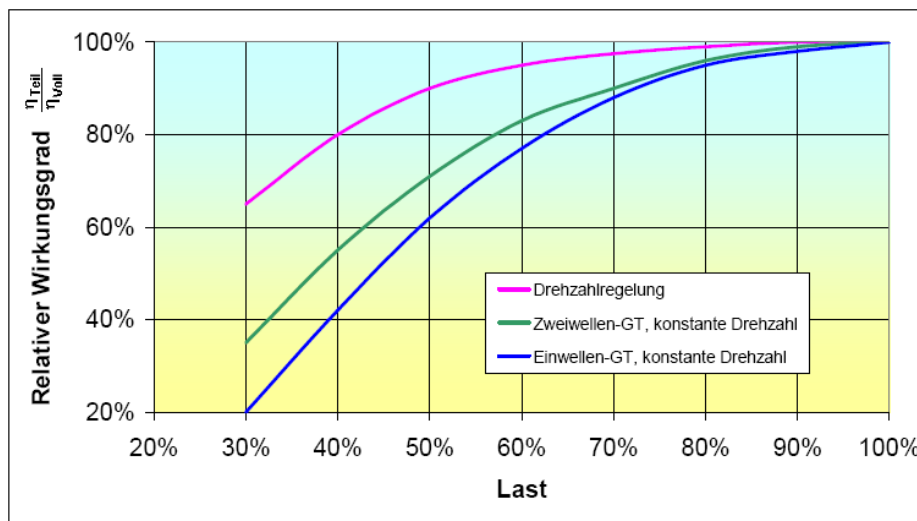

Figure 8-5: Partial load of micro gas turbines with one and two shafts and variable speed /Diel/

Thermal Efficiency:

- In order to improve the **thermal output**, heat losses of the exhaust gas have to be reduced, which can be achieved by lowering the temperature level in particular by condensing the gaseous water. This possibility requires a heating system with a low system temperature (condensing boiler technology).

8.1.3 Thermal Storage

Heat can be stored in a thermal store like done by the Danish motor CHP system. This has the advantage of being able to follow the electricity demand requirements without wasting heat.

8.1.4 Technical Problems and Solutions

- Low electric efficiency of **simple micro gas turbines**: 15 – 20 %, solutions are recuperators and steam injection or Cheng Cycle.

8.1.5 Influence on Electricity Supply and Demand Load Curve

An efficient cogeneration means to **use** electricity and heat and not to waste heat. Electricity has the higher technical value and price, but efficiency and economy make it necessary also to use heat as much as possible. Typically costs and electricity are coupled.

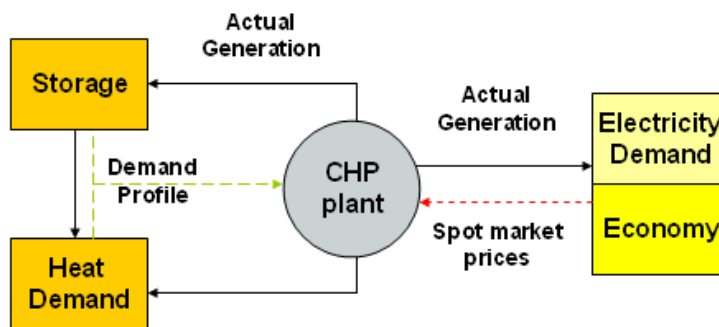

Figure 8-6: Cogeneration with heat storage and an electricity price dominated economy (e.g. spot market

Operation of micro turbines in a future system with high fluctuating renewable energy production will depend on 2 boundary conditions:

- High heat demand
- Low wind power production

Under these conditions wind gaps can be filled by micro turbines. In that way micro turbines can assist motor CHP units in wind power balancing.

Correspondingly operation restrictions for micro turbines arise, in case of:

- Low heat demand
- High wind power production

Under these conditions power generation peaks can be reduced by micro turbines and micro turbines assist motor CHP units in wind power balancing.

8.2 Assessment

8.2.1 Technical Assessment: Suitability and Availability

- Availability: Well known technique, several producers.

The following list shows that there are even several producers of very small micro gas turbines: Producer, price, electric capacity, efficiency, specific investment cost per kW, maintenance costs

Table 8-3: Prices of market available micro gas turbines (source /AEA OPET 2004/)

Anlagenhersteller / Vertreiber bzw. Pa- ckager	Richtpreis der Anlage [Euro]	Elektr. Leistung [kW]	Elektrischer/ Gesamt-Wirkungsgrad [% / %]	Richtpreis pro kW _{el} [Euro / kW _{el}]	Wartung [Euro/kWh _{el}]
Capstone Turbine Corp.	67.600 (52.000)****	28	25 / 82	2.410	0,01 *)
Capstone Turbine Corp.	101.000 (81.800)****	60	26 / 89	1.690	K. A.
Gasturbo (Bowman Power Sys- tems Ltd.)	87.200	50	22 / 72	1.740	0,02 *)
Gasturbo (Bowman Power Sys- tems Ltd.)	116.300	80	25 / 74	1.470	0,02 *)
Turbec / API ***)	85.000 (123.200)****	100	30 / 80	850 (1360)****	0,007 **) (0,015 **) ****)

8.2.2 Comparison with Motor CHP

As a producer of electricity micro turbines are quite close to cogeneration with motors. Both techniques have the advantage of being able to be turned on and off within minutes, and having balancing power abilities like supplying power during peak demand within a 15 minute start up period.

The disadvantages of a simple system must be seen in a low efficiency compared with motors. As a combined cycle including steam engine gas turbines can be efficient up to 60 % electric efficiency, but this IGCC (integrated gasification combined cycle) is only applied for large plants. One of the main advantages of micro turbines are the lower maintenance costs.

Table 8-4: comparison of micro turbines and Diesel motors

Micro turbines	Diesel motors
	High electric efficiency
	High CHP coefficient (ratio power/heat)
Longer life time	
Less maintenance	
Smaller and lighter	
Low emissions	
Low maintenance costs	
	Low investment costs

The high temperature level of the micro turbine exhaust gas makes it attractive for steam production and for process heat at high temperature level and therefore it is appropriate for industrial applications.

8.2.3 Economic Assessment: Costs, Historical and Future Cost Development

- Investment costs

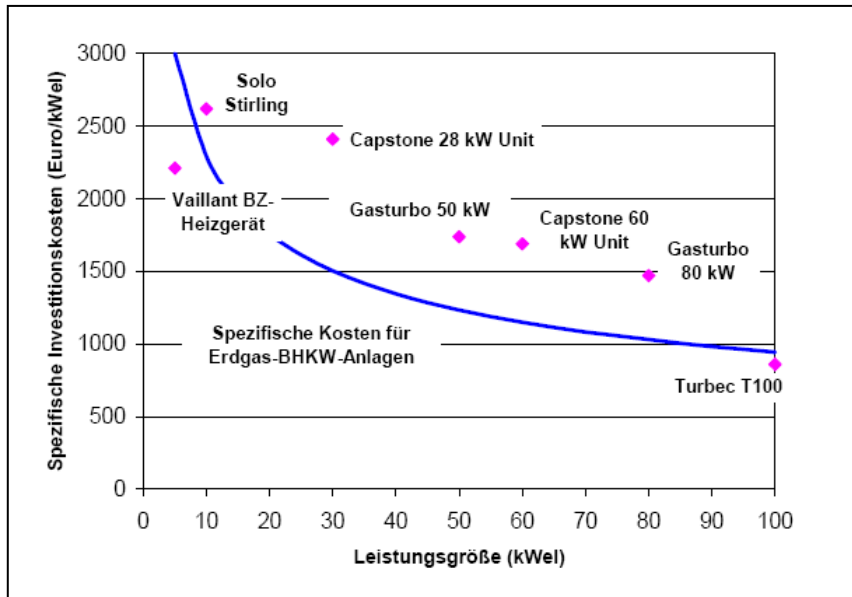

Figure 8-7: Specific investment costs for motors (blue line) micro turbines and other cogeneration units /AEA OPET 2004/

Operation Costs:

Energytech.at publishes figures about the relevance of costs telling that CHP fuel costs are determining the electricity prices (in the order of 2/3) while maintenance and investment are less important and in a similar range. A high electric efficiency then means to demand less fuel for electricity generation leading to a better economy.

8.2.4 Environmental Aspects:

With 30 % of the chemical energy of the burned fuels being converted into electricity and another up to 60 % thermal energy it is an efficient energy conversion.

9 Electric Night Storage Heaters (Unik)

9.1 Technology Description:

9.1.1 Introduction

Night storage heating facilities (NSHF) are electric heating devices with storage. The incentive for using this technique is a cheaper electricity price during low electric demand periods such as overnight. The heat is stored in solid materials in the interior of the device and released when required in the peak electric (and heat) load period during the day. Its electricity consumption is measured separately to the rest of consumption because of a lower price when demanded in low electric load period¹⁹. Heat is typically supplied decentralized from each single night storage heating facility in each single room.

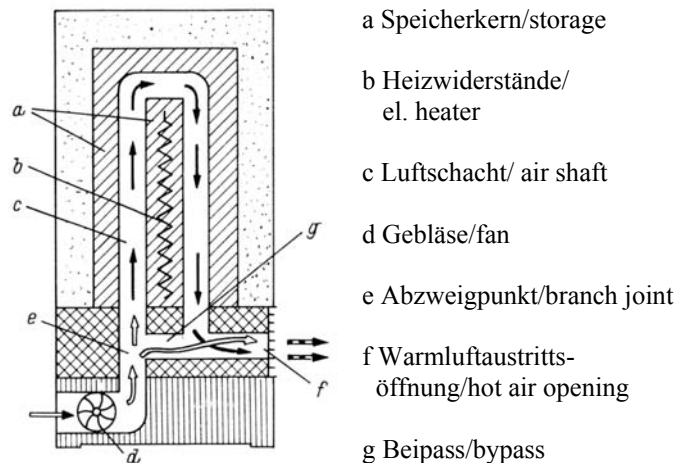

Figure 9-1: STIEBEL ELTRON storage heater, view from outside. Typical modern type, /1/

Figure 9-1 shows a front view and a section, from a side view, through an electric heating device:

An **electric heater** (b) converts electricity into heat. The heating element inside is an electric resistor. An electric current flowing through this resistor converts electricity into heat energy.

The **heat store** (a) is typically a magnesite store of ferric oxide and magnesium which can be heated up to temperatures of 650 °C. Insulation around the storage reduces the uncontrolled or so called static heat transfer to the room.

Controlled or so called dynamic **heat release** of modern NSHF types is done by a ventilator (d) that transports air through the hot storage (c) and a bypass (g). Both partial flows of different temperature are mixed in order to deliver the defined air temperature at the opening (f).

¹⁹ It can occur that electricity is as well demanded in high electric load period. Then the two tariffs counter registers the more expensive peak electric load consumption separately.

The use of such appliances in order to influence i.e. to raise or reduce **consumption at certain times**, a demand side management has been used with **control** commands from distribution system operators or electricity suppliers to electric consumers called ripple control: the distribution system operator does this by a transmitter sending impulses via the electricity grid²⁰ and these signals are a kind of telegram addressed to the receivers of electric appliances like heaters, street lighting and devices in the industry. Received signals are filtered amplified and prepared for the signal decoder, which compares the telegram to its known commands. In case of conformance of e.g. a starting command **the heating programm** starts.

9.1.2 Efficiency

Within the night storage heating facility electricity is converted completely into heat. There are no conversion losses of the system itself.

9.1.3 Thermal Storage

Heat is stored in and discharged from solid materials, which are surrounded by insulation. The following Table 1-1 shows the palette of typically used materials for heat storing and its material properties. Characteristic in comparison to water are high storage temperatures and a low thermal capacity of these solid materials.

Table 9-1: Storage materials properties (average values), 21 /Mod1975/

Material	Useable temperature-range in °C	Useable temperature difference in °C	specific heat capacity c_p in Wh/kgK	Density ρ in kg/dm ³	Volume specific heat capacity ρc_p in Wh/dm ³
Fireproof concrete	600-100	500	0,24	2,2	0,53
Heavy fireclay	600-100	500	0,26	2,0	0,52
Olivine	600-100	500	0,29	2,6	0,75
Alucrodon	600-100	500	0,28	2,9	0,81
Water	95-45	50	1,16	1,0	1,16
Magnesite	650-80	570	0,31	2,95	0,91
Cast iron	650-120	530	0,15	7,25	1,09
Oil	300-120	180	0,76	0,6	0,46
Salt	500-140	360	0,52	1,8	0,94

The storage requirements are to be able to store much energy and to release the heat fast. Therefore a high density and heat capacity (storing) and a high conductivity (heat release) are necessary. Under consideration of the price Magnesite fulfils all requirements best, /STA2005/.

²⁰ Impulses in a range up to 2000 Hz, i.e. much higher than grid frequency (50 Hz), with an amplitude of about 1...8 % of the grid voltage.

²¹ Given values are temperature dependent.

Control

Heat release and electricity converted to heat and stored as heat energy are needed in relation to the outdoor temperature. A typical **loading period** comprises the hours between 22:00 and 06:00. Additionally there can be two hours in the medium load period.

Input signals

The loading process needs information about the **outdoor, room and storage temperatures**. The **outdoor temperature** defines the overall heat demand, starting e.g. at temperatures below 16°C, and thereby defining the necessary heat energy in the storage e.g. a load state of 50 % of full load. The **storage temperature** delivers the information about the state of charge and thereby the answer if it has to be loaded or not.

The **room temperature** is responsible for heat release. Additionally to the static heat transfer of the heater in case when the room temperature falls short of the set minimum temperature value, the fan is activated and as long as this **dynamic heat release** reaches the defined higher temperature level.

If the storage capacity is not sufficient direct electric heating at higher price level is activated.

Wind power balancing abilities: Influence on Electricity Supply and Demand Load Curve

Electricity consumption of electric heaters will in future depend on 2 boundary conditions:

- Actual space heat demand
- High wind power production

Under these conditions wind peak production can be cut by NSHF. NSHF will be part of a Demand Side Management system together with other techniques like pumps and ventilation systems in buildings and including walls with or without phase change materials (PCM) and insulation materials.

9.1.4 Technical Problems and Solutions

One technical problem is the uncontrolled static heat transfer, which may lead to heat transfer although not needed, /STA2005/.

Technical problems regarding energy efficiency are not to be found within the system, but are more due to the manner of electricity generation. As consumers of electricity from wind energy it has to be assessed better than from thermal power plants, but in comparison to heat pumps which produce 3 times as much heat with the same electricity, it is not the best solution.

9.2 Assessment

9.2.1 Technical Assessment: Suitability and Availability

- Availability: It can be bought; can be easily installed, well known technique (2.6 million devices).
- Suitability: Today electric heaters mainly consume electricity in the low load period in the night. In order to **reduce wind power peaks** in the heating period electricity **consumption** will be shifted from night time to **wind power peaks**.
- Solid storage, heavy device, high space demand

9.2.2 Comparison with CHP

As consumer it is a perfect supplement to cogeneration as wind power balance instrument. The disadvantages must be seen in the lower efficiency compared with heat pumps. This way of heating has the advantage of a quite easy installation without pipes and chimney.

9.2.3 Economic Assessment

Quite low investment costs, but high operation costs for electricity. In future systems with a high capacity of wind power much lower price in peak production times might improve the costs.

9.2.4 Environmental Aspects

Thermal power plants dominate European power generation and waste about 60 % of the chemical energy of the burned fuels. Therefore as electric consumers under European conditions night storage heating facilities are causing high primary energy consumption and are by that as well responsible for global warming. An advantage of such systems is that they allowed to let run sluggish coal fired power plants permanently and avoid its inefficient start ups and shut downs. In combination with wind energy there are no environmental disadvantages.

9.3 Wind Power Balancing Abilities

9.3.1 Influence on Electricity Supply and Demand Load Curve

Electricity consumption of electric heaters will in future depend on 2 boundary conditions:

- Actual space heat demand
- High wind power production

Under these conditions wind peak production can be cut by NSHF. NSHF will be part of a Demand Side Management system together with other techniques like pumps and ventilation systems in buildings and including walls with or without phase change materials (PCM) and insulation materials.

9.3.2 Potential

The existing potential in Germany is 40 GW and 27 TWh. The relocateable yearly energy depends on heat demand and storage capacity and the co-occurrence of space heat demand and wind power peaks.

In future energy for space heating can be reduced by a factor 5 up to more than 10. This would influence the here discussed technology in so far that balancing potential for wind power is reduced.

The following *Table 9-2* contains the installed electric heater capacity of the Desire states. The data source for Germany is /VDEW98/.

Table 9-2: Electric heater potential

	Number in 1.000	Electric Capacity MW	Electricity GWh
Estonia	31	79	
Germany	2.600	40.000	26.680
Spain	1.156	5.781	

As the development of the installed electric heater capacity in Germany shows, from the 1970ies on this technique has been widely used in Germany. In the 1990ies the trend reversed.

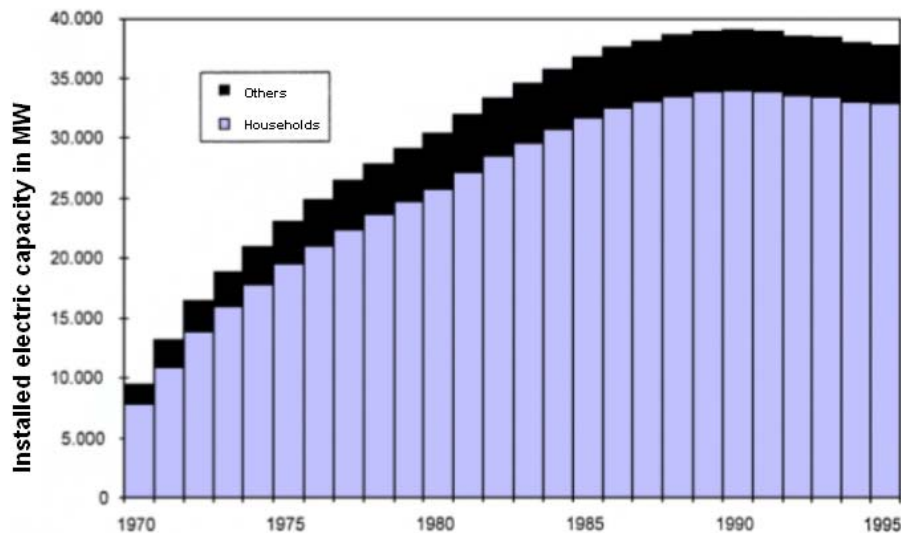

Figure 9-2: Development of the installed capacity of electric heaters in Germany, /VDEW 98

10 Buildings as Energy Storage Devices (UniK)

10.1 Technology Description

10.1.1 Introduction

Normally a classification of consumption structures is done in four groups:

- Industry
- Private Households
- Trade and Commerce
- Transport sector

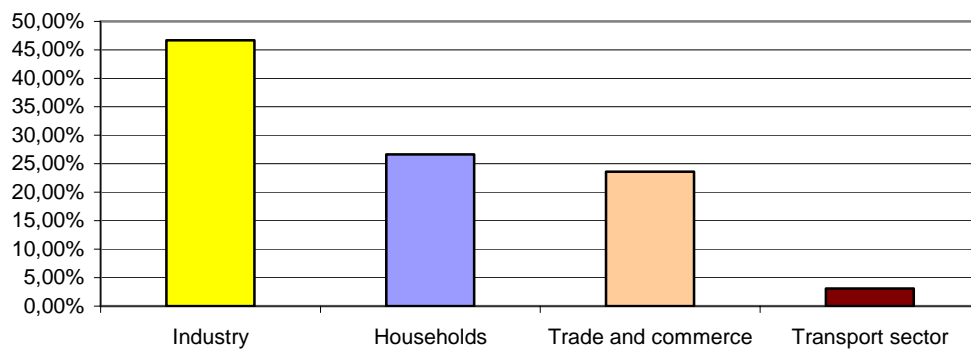

Figure 10-1: Proportion of the different consumption structures on the electricity demand 2004 /VDEW/

The largest part of electricity demand has the industry. Nearly 47% of the demand is used in the 300.000 companies. A little bit more than a fourth of the consumption is demanded by the 39 million households. Thus the households are the second most important consumer group. Therefore we expect a great control potential in regarding buildings as energy storage devices. For analyzing the possibilities for buildings as energy storage devices we first have to take a look at the energy demand in buildings. Since we want to balance the electrical imbalances caused by the fluctuating wind energy, through a Demand Side Management, we are just investigating the electrical consumers and not the overall energy demand. In Figure 2 and Table 10-1 the distribution of the different applications in German households is shown.

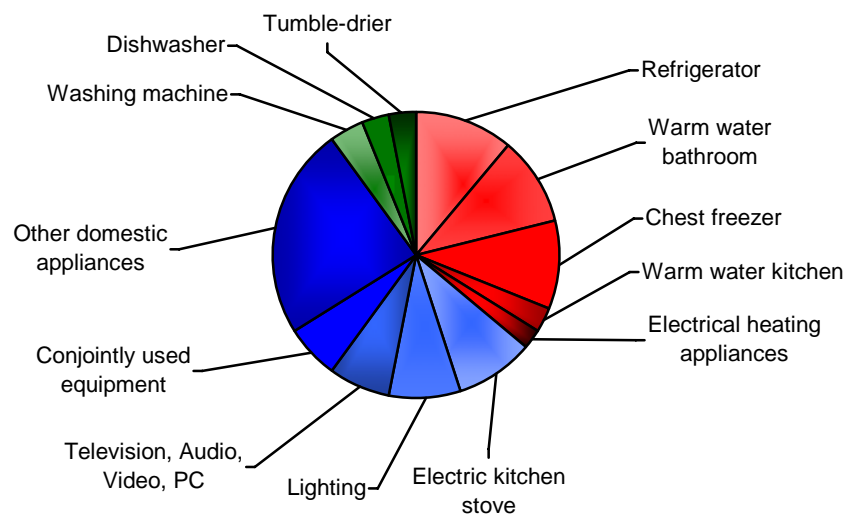

Figure 10-2: Electricity demand in German households /VDEW/

Application	Proportion [%]	Category
Refrigerator	11	3
Warm water bathroom	10	3
Chest freezer	10	3
Electric kitchen stove	9	1
Lighting	8	1
Television, Audio, Video, PC	7	1
Conjointly used equipment like stairway lightning, elevator	6	1
Washing machine	4	2
Dishwasher	3	2
Warm water kitchen	3	3
Tumble-drier	3	2
Electrical heating appliances	2	3
Other domestic appliances	24	1

Table 10-1: Electricity demand in German households /VDEW/

Like done in *Figure 10-2* and *Table 10-1*, the energy demand in buildings can be divided in three categories:

1. Base load and user specific loads
2. Time shiftable loads
3. Thermal based loads

These three categories are to be described afterwards.

Base load and user specific loads

This category comprised loads like light or information and communication technologies. These loads are necessary for the users comfort and therefore they are not shiftable. Thus they can't participate in a Demand Side Management and therefore they are not investigated.

Time shiftable loads

Equipments that run a certain program are consolidated in this category. Devices like washing machine, dishwasher or tumble-drier are running for a fixed time when started. The time in which they are started, and therefore the time when the energy is needed, can be shifted very easily. Normally it is not necessary for these equipments to operate at the time they are turned on. A dishwasher for example, which is turned on at evening is supposed to be finished the next morning. At what time of the night the program is running isn't of interest for the normal user. Furthermore an additional potential could be activated by changed user behavior. Examples are vacuum-cleaning, ironing etc.

Thermal based loads

In this category are devices that use electrical energy to provide cold or heat. Refrigerators or chest freezers are supposed to cool; electrical heating appliances are for heating. Normally these consumers are coupled with some kind of thermal energy storage device. Since storing thermal energy is way easier than storing electrical energy this group is perfectly appropriate for participating in a Demand Side Management.

In addition to these equipments the auxiliary power needed for the heating system can also make a contribution to a DSM.

As we can see in *Figure 10-2*, nearly half of the consumption of electrical energy in households (categories 2 and 3: 46%) can have a share in a Demand Side Management.

10.1.2 Efficiency

Using buildings as energy storage devices like further described shows a good efficiency. By storing the electrical energy through storing the energy form later needed, the benefits are fulfilled and additionally the effect of storing energy is given.

Within the circulation pumps and the air conditioning units electricity is converted into mechanical energy. Pumps in heating systems of single occupancy and semidetached houses only convert 10 to 15% of the electrical energy in pumping storage. In Switzerland and from a German manufacturer a small pump has been developed, which performs the same hydraulic delivery rate with a 75% lower power consumption („Faktor-4-Pumpe“) /BMU2006/.

10.1.3 Thermal Storage

Cooling down behavior can be described with the law of heat conduction, also known as Fourier`s law.

$$\frac{\partial T}{\partial t} = \frac{\lambda}{c \cdot \rho} \cdot \frac{\partial^2 T}{\partial x^2}$$

For the simulation of the buildings thermal storage ability a simulation-tool had to be accomplished for calculating this equation. This was realized using LabVIEW™. The cooling down behavior of the room temperature at different outside temperatures, while the heating system is turned off, is to be investigated.

The room temperature at the initial state (walls without insulation) is decreasing very fast. The simulation results for the walls without insulation at an outside temperature of 0°C are shown in Figure 10-3. The simulated walls are representative for the actual inventory of the outside walls in Germany. The time in which the room is cooling down to 18°C is only several minutes.

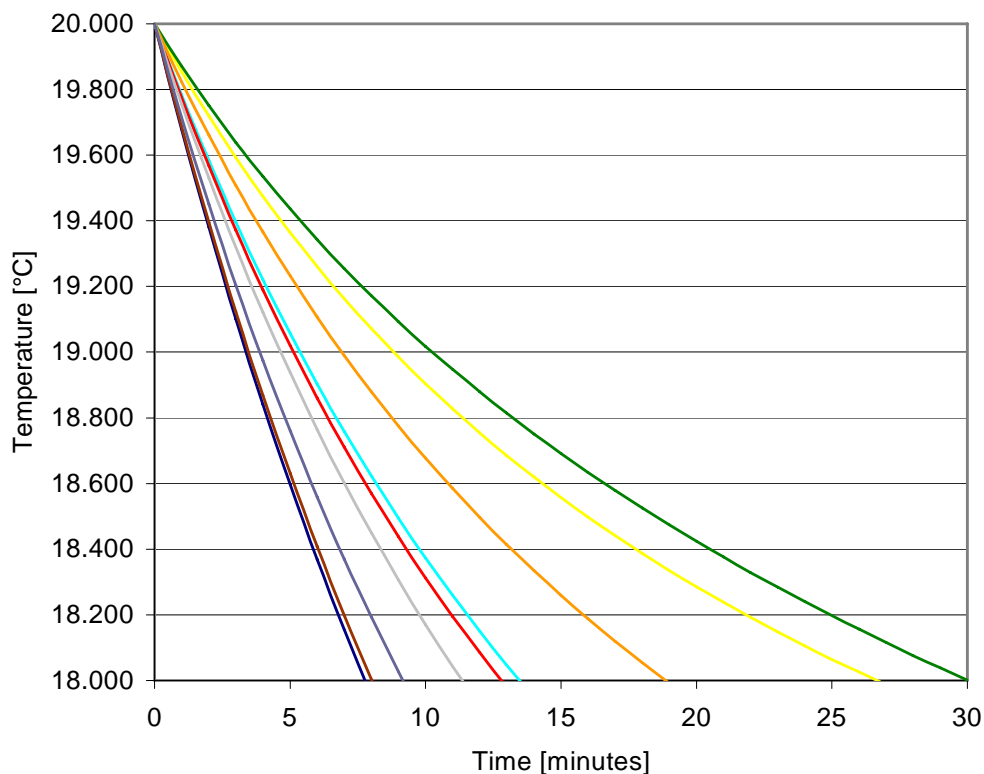

Figure 10-3: Simulation results for an outside temperature of 0°C –I /Faulstich2005/

The results for a simulation of the same wall-types, but this time with an insulation of 12 cm, at an outside temperature of 0°C are shown in Figure 10-4. Instead of several minutes the time in which the room is cooling down is in the range of several hours. The achieved improvement is therefore enormous. The time in which the heating system could be turned off is extremely increasing. This leads to a better possible usage of buildings as energy-storage devices.

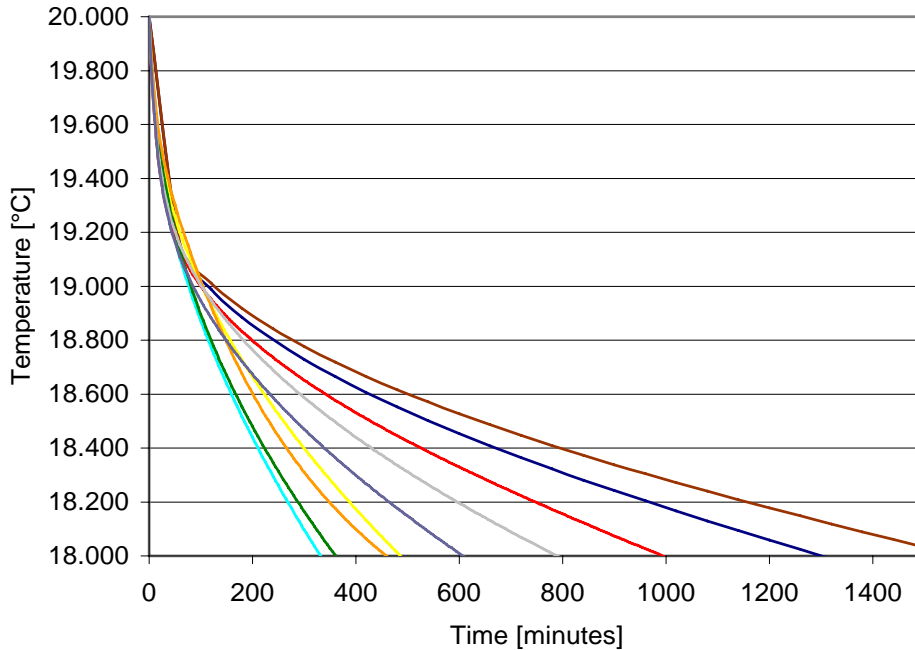

Figure 10-4: Simulation results for an outside temperature of 0°C –II /Faulstich2005/

The simulation results for one typical wall-type at the initial state and together with insulation as well as a simulation result for a wall which only consists of a 12 cm insulation-layer are shown in Figure 10-5 for a better explanation of the effects of the controlled cooling.

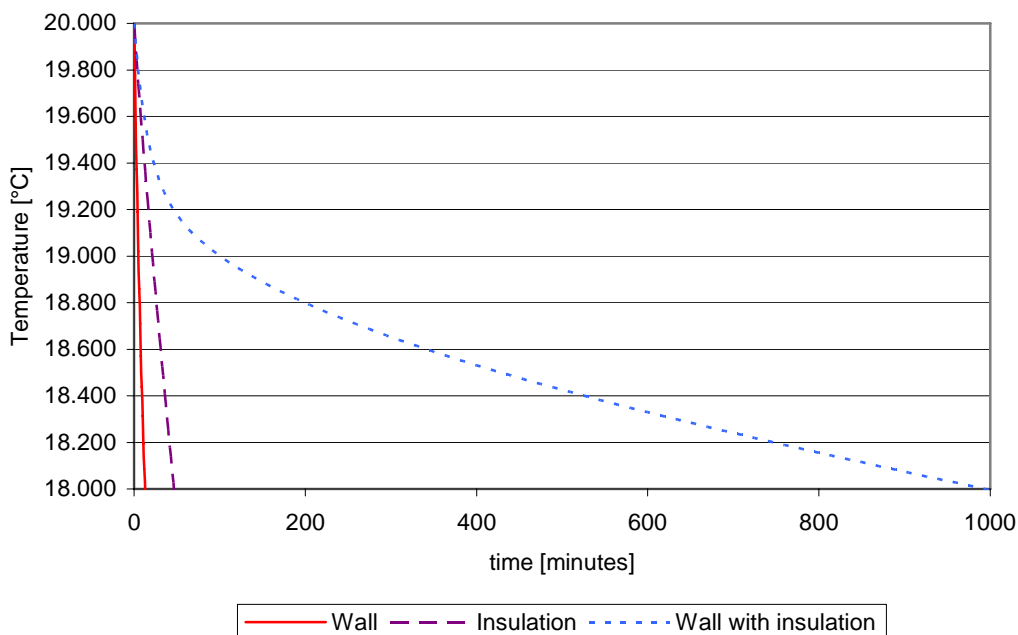

Figure 10-5: Simulation results for an outside temperature of 0°C –III /Faulstich2005/

The cooling down behaviour can be described with the given law of heat conduction. It can clearly be seen in the given equation that the influencing variables are the thermal conductivity λ and the specific heat capacity, which is the product of the heat capacity c and the density ρ . The thermal conductivity is an indicator for the amount of energy that can pass through the wall; the specific heat capacity indicates the amount of energy that can be stored inside the wall.

The red line in *Figure 10-5* shows the behaviour of the **wall without insulation**. The fast, nearly linear breakdown of the temperature can be explained by the high conductivity of the wall. The energy stored in the wall has nearly no effect on the behaviour. The influence of the conductivity is more important in this case.

The violet line shows the behaviour of a 12 cm **only-insulation-layer**. The time, in which the room is cooling down, is a little bit longer because of the way lower conductivity. The effect is not really big because the insulation material in fact has a low thermal conductivity but also a low specific heat capacity. Therefore only a little bit of energy can be stored in the layer and be passed into the room. An opportunity, which combines the positive properties of low conductivity and high storage potential, is the **wall with insulation**, shown in the blue line. The conductivity is because of the insulation still low in this case and the stored energy is dominated by the energy stored in the original wall. Therefore the insulation is responsible for a low heat conductance and the rest of the wall for the stored energy. Because of this the resulting effect is enormous. The needed time for cooling is way bigger than the sum of the durations from the individual parts.

The non-linearity of the last curve can also be explained with the two properties conductivity and storage ability. At the beginning of the cooling, there is plenty of energy stored in the wall and a high heat transfer because of the great temperature difference (between inside temperature and outside temperature). The effect of the high heat transfer dominates and the temperature drops. With ongoing cooling the amount of stored energy decreases as well as the heat transfer. Therefore the influence of the stored energy rises and the temperature drop decelerates.

Good buildings thermal storage ability is needed for the participation of circulation pumps in a Demand Side Management. Therefore both, low hat conductance and high storage ability, are needed because of the effects explained above.

10.1.4 Technical Problems and Solutions

For the usage of buildings as energy storage devices a lot of communication effort is necessary. This problem is to be investigated more detailed in chapter 0.

A problem regarding the pumps is the over-dimensioning and unnecessary long duty periods. In many cases a hydraulic adjustment is also missing.

10.2 Wind Power Balancing Abilities

For an estimation of the potentials for a Demand Side Management we need to know how often the consumers are operating and how much energy they need for each operation.

The peak capacity of the consumer is of interest for the maximum possible relocatable potential. Furthermore the knowledge of the market penetration is essential for a countrywide estimation. All of these features are stated for the consumption group 2 (time shiftable loads) in Table 10-2. The stated numbers are a result of the network “Energie und Kommunikation” which among other things deals with the possibilities for the realization of a Demand Side Management.

Application	specific consumption p.a.	Market penetration	Frequency of operation /ISI2004/	Peak capacity /Siemens/	Consumption per operation	Relocatable potential per household and month

	(kWh)	(%)		(kW)	(kWh)	(kWh)
Washing machine	150,0	95,0	12,2 washing operations per month	2,3	1,0	11,59
Tumble dryer	280,0	34,0	9,7 drying operations per month	3,1	2,4	7,92
Dishwasher	215,0	52,0	3,8 washing operations per week	2,3	1,1	8,69

Table 10-2: Potential relocatable loads for a daily adjustment on the load profile /EuK/

Assuming that all consumers operate on the same day, the maximum relocatable potential per household and day is 4,5 kWh. According to the frequency of operation and to the market penetration the relocatable potential per household and month is 28,2 kWh. This leads to a relocatable potential per household and day of 0,94 kWh.

In Table 10-3 the needed information for the consumer group 3 (thermal based loads) are stated.

Application	Market penetration	Frequency of operation	Usage length per operation	Average power	Consumption per operation	Control potential per household
	(%)		(h)	(kW)	(kWh)	(kW)
Refrigerator	99,0	8 hours per day	0,33	0,09	0,031	0,029
Chest freezer	75,0	8 hours per day	0,33	0,12	0,037	0,029
Circulation pumps (heating, warm water)	93,0	12 hours per day in Winter (8 month)	12,00	0,10	1,200	0,047
Climate control units	1,4	210 hours p.a. (35 days in summer)	6,00	2,50	15,000	0,009

Table 10-3: Control potential for a short adjustment on the imbalance /EuK/

According to the market penetration and to the frequency of operation, an average control potential per household of 90,17 W (in summer 67 W, in winter 105 W) can be calculated.

The available control potential only depends on the power of the applications and on the appearance probability; whereas the duration of the power offering is up to the storage capacity. In case of refrigerator and chest freezer this storage capacity is a property of the applications themselves. The circulation pumps or the climate control and the air conditioning units respectively however don't have an internal storage. They actually use the building for storing the energy. Therefore the building topology and the storage ability of the building are important influence variables, which are to be investigated more detailed in following.

For estimating the storage potential in the building, it is differentiated between three types of the building structure /DIN/:

- Lightweight construction $C_{\text{wirk}}/A_G < 50 \text{ Wh}/(\text{m}^2\text{K})$
- Average construction $50 \text{ Wh}/(\text{m}^2\text{K}) < C_{\text{wirk}}/A_G < 130 \text{ Wh}/(\text{m}^2\text{K})$
- Weightiness construction $C_{\text{wirk}}/A_G > 130 \text{ Wh}/(\text{m}^2\text{K})$

A_G is the living space. C_{wirk} is a function of the heat storage capacity c , the density ρ , the thickness d and the surface area A of the used materials.

As a matter of fact a heavier construction type can store more energy in the building and allows longer shutdown durations of the heating or cooling system.

10.3 Assessment

Technical assessment: Suitability and availability

The mentioned potentials are technical realizable and they could be automatized. As already mentioned a lot of communication effort would be necessary. A controlling mechanism needs plenty of informations for a practical implementation of these potentials. Besides the informations regarding the electricity demand and supply other informations like the state of charge of the used storage devices are needed. The indicator for the state of charge would be the room temperature for the case of using walls as a storage devices and the air-quality for the case of using air-conditioning units. Furthermore information about the possible duration of the time in which the systems can work as storage devices and the resultant consequences for their duty afterwards are needed. All these informations are needed by a control unit, which decides whether the systems would operate in their normal way or can be used for the shifting of energy.

Comparison with CHP

The usage of buildings as energy storage devices allows storing heat as well as electrical energy. Therefore it is a perfect supplement to cogeneration as wind power balance instrument.

Economic assessment: Costs, historical and future cost development

In case of the circulation pumps the low investment costs and high operation costs for the electricity are essential in every warm water heating system. Therefore the only additional costs of using buildings as energy storage devices are the costs for the communication effort. This means quite low operation costs, but high investment costs for the described communication technologies.

Environmental aspects

According to the use of buildings as energy storage devices there are no environmental disadvantages. An advantage can be seen in the fact that the amount of energy which can be shifted would be needed anyway just at another time.

11 Increased storage capacity through PCM (UniK)

11.1 Technology Description:

11.1.1 Introduction

Storing electrical energy is a difficult venture. Considering the necessary expenses an integration of non electrical storages and/or load management measures would be exceptional.

New developments of thermal insulations are concerned with the investigation of so called phase change materials (PCM). These materials have a melting temperature at ambient temperature, which means that they can store large amounts of energy for space heating at a desired temperature level. The same material allows designing heaters, which would - if they are at least partially electrically - open high load management potentials.

Therefore this investigation deals with the energy storage potentials.

A large amount of the stored energy in Phase Change Materials is the energy used for the transition between one state of aggregation and another.

The medium water is a great example for explaining the topic of Phase-Change-Materials. An ice cube at a temperature of 0°C is, if heat is provided, melting and changes his phase from solid to liquid. Its temperature stays at 0°C as long as it is melting and rises not until the change is completely done and the ice cube has turned into water.

If the heat is continuously provided the temperature of the water will rise up until the next phase change, the change liquid-gaseous has been reached. For the given example of water this point is at a temperature of 100°C . Again, exactly as explained for the solid-liquid-change, the temperature of the water stays constant until it is completely vaporized. After finishing this process the temperature of the vapour may ascend.

The same correlations between temperature and phase changes are valid for the opposite case. If the temperature of the water is cooling down to 0°C it again holds this temperature until it is completely frozen and has turned into ice. If this is the case, the temperature of the ice can get a temperature below 0°C but then there is no more water because it has completely changed its phase.

The described coherences can be seen in Figure 11-1.

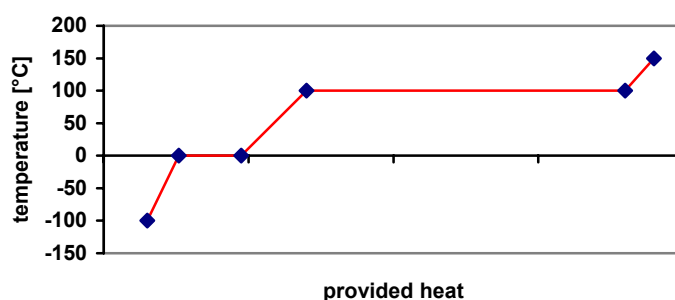

Figure 11-1: Temperature of water as a function of the specific enthalpy

Figure 11-1 shows the intervals of the phase-changes very clearly. Also the figure shows the enormous energetic potential of phase-changes.

For melting ice of 0°C to water of 0°C , 335 kJ/kg are needed. This energy suffices to heat up the same amount of water from 0°C to 80°C . The needed amount of energy for the phase-change liquid-gaseous is actually nearly 6 times as much.

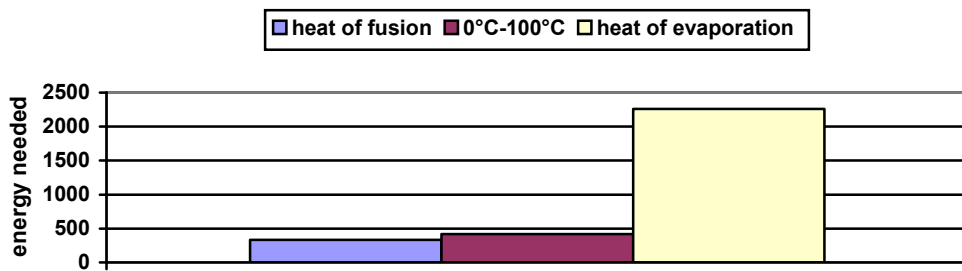

Figure 11-2: Comparison between the needed energy amounts to heat up water

Types of Phase-Change-Materials

In the field of Phase-Change-Materials there are many substances, which are suitable for a wide range of usages /BINE2002a/.

These substances differ in a lot of properties. The most important attributes are the phase transition temperature and the heat of fusion. An overview about the covered ranges of these two features is given in Figure 11-3.

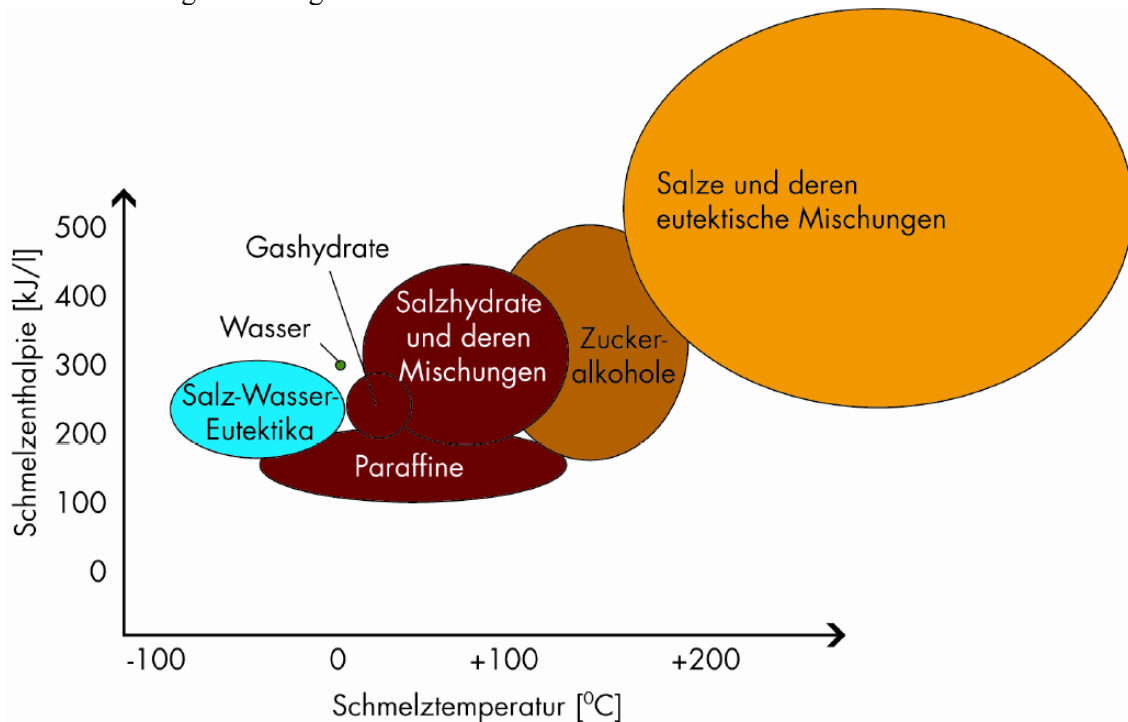

Figure 11-3: Types of Phase-Change-Materials /ZAE/

All further explained PCM:

- Eutectic water salt-dilution
- Gas hydrates
- Sugary alcohols
- Salts and their eutectic compounds
- Salt hydrates
- Paraffin waxes

Eutectic water-salt-dilution

Eutectic water-salt-brines are the most common type of PCM. They have a melting point below 0°C. That's why they are not suitable for heat storage but excellent as a cold storage device. Because these PCM are basically a dilution of mostly cheap salts in water they are not very expensive.

Gas hydrates

Gas hydrates have a melting point between zero and 20°C. At the moment research and development is going on in order to cover the mentioned temperature range.

To get gas hydrates gas is under pressure diluted into water.

Sugary alcohols

Sugary alcohols have a melting temperature range from 90 to 180°C, which normally is too high for heat storage in buildings. Like the gas hydrates developing of these PCM is going on right now. Figure 11-4 shows some examples for sugary alcohols.

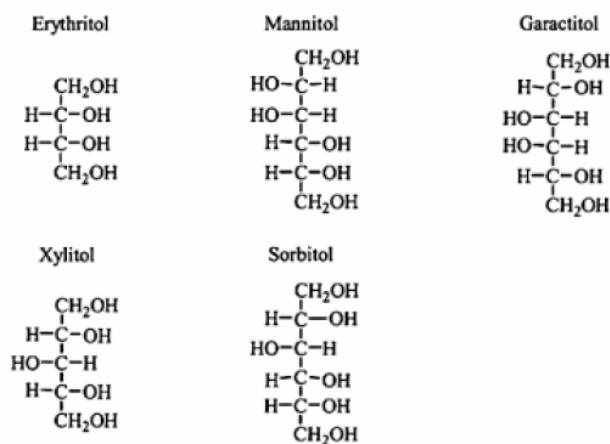

Figure 11-4: Sugary alcohols /Milow2001/

Salts and their eutectic compounds

These Phase-Change-Materials are used as heat storage devices in high temperature ranges because of their high melting temperature above 180°C. An example for an application of these PCM is the use in solar power plants.

Salt hydrates

The melting temperature range of salt hydrates is from zero to 130°C. These Phase-Change-Materials can be seen as an extreme modification of the lattice of water or as salts with very high water content (chemically combined water). Some of the most common Salt hydrates /Milow2001/:

- $\text{CaCl}_2 \cdot 6\text{H}_2\text{O}$
- $\text{Na}_2\text{SO}_4 \cdot 10\text{H}_2\text{O}$
- $\text{Na}_2\text{HPO}_4 \cdot 12\text{H}_2\text{O}$
- $\text{Na}_2\text{S}_2\text{O}_3 \cdot 5\text{H}_2\text{O}$
- $\text{NaCH}_3\text{COO} \cdot 3\text{H}_2\text{O}$

Salt hydrates react corrosive, show a supercooling behaviour and an incongruent melting. Therefore a lot of problems have to be solved before these PCM would be suitable.

As opposed to paraffin wax, salt hydrates have a higher heat of fusion and so are in actual fact superior for storing heat. However besides the mentioned problems salt hydrates have another great disadvantage. Unfortunately the great mobility of the chemically combined water does avoid a promising micro encapsulation, which is described in chapter 0.

Paraffin waxes

The melting point range of these Phase-Change-Materials is from zero to 150°C. Paraffin waxes are inorganic substances. Paraffin is a collective name for saturated hydrocarbon alloys. It is mainly extracted of crude oil and is a spin-off product of the lubricant fabrication.

The empirical formula for paraffin waxes reads as follows: C_nH_{2n+2}

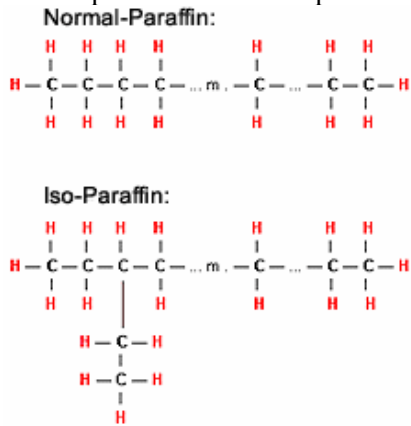

Figure 11-5: Paraffin waxes /Reenergie/

One differentiates between normal-paraffin, which are straight chains and iso-paraffin, that additionally to the long ground warp has derived branches. For thermo technical applications n-paraffin is preferred /Reenergie/.

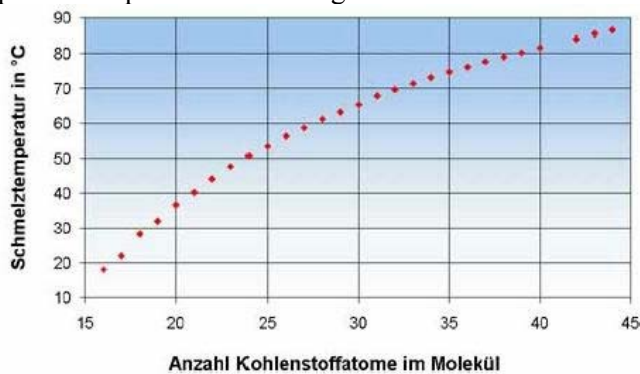

Figure 11-6: Melting temperature as a function of the amount of carbon-atoms /Reenergie/

The melting point of paraffin wax is adjustable through the length of its chain. A greater molecule chain length and a greater mole mass are leading to a higher melting temperature /Reenergie/. Paraffin waxes are plain sailing substances (lat.: „parum“: too little; „affinis“: nonparticipating → virtually no chemical reaction). They don't show a supercooling behaviour, don't react corrosive and are not toxic. Nevertheless they are a fire hazard (not without reason they are used for candles).

Material properties

A Phase-Change-Material which is to be used for heat storage or insulation has to fulfil many requirements /Lane1983/, /Milow2001/. Table 11-1 provides an overview of the criterions, which will be discussed shortly.

Physical requirements	
	Heat storage capacity
	Heat conductance
	Density
	Heat of fusion
Technical requirements	

	Change in volume
	Long term chemical stability
	Supercooling
	Corrosiveness
	Combustible
Ecological and economical requirements	
	Sustainable
	Recycling
	Profitability

Table 11-1: Requirements for Phase-Change-Materials (adopted from: /Lane1983/)

Physical requirements

To store a large amount of energy, the Phase-Change-Materials should have a high heat storage capacity. The density of the material should also be high because the stored energy depends on the specific heat storage capacity, which is the product of density and heat storage capacity. However the density change through the phase change should be as small as possible because this means also an unwelcome change in volume.

Like already explained, the stored energy in a Phase-Change-Material is as high because of the heat of fusion, so this should be as high as possible.

Depending on the kind of application, the heat conductance plays a significant role.

For insulation a low heat conductance is of advantage, whereas for energy storage one prefers a high heat conduction because of the charge and the discharge. However, in principle Phase-Change-Materials show a low heat conductance.

Technical requirements

The use of Phase-Change-Materials does have some technical problems.

The materials for example should not supercool. Supercooling occurs if the setting temperature is significant below the melting temperature. They also should not react corrosive.

Since several cycles are needed in the usage of PCM, the materials have to have a certain cycle stability.

A low change in volume is mandatory for a technical application. Otherwise an appropriate encapsulation would be unfeasible.

Another problem is an incongruent melting. In the process of melting, several phases can develop, which may separate from another because of the different densities. Is the material supposed to gel again, either heat must be provided for a long time or otherwise high temperatures are needed.

In the application of some Phase-Change-Materials, like for example paraffin wax, the combustibility of the material also plays a decisive role. Especially when using the PCM as a wall-layer the fire protection requirements have to be observed.

Ecological and economical requirements

For a technical use of Phase-Change-Materials, these of course have to be sustainable. They should for example be recyclable.

Even though at the moment other aspects are more important, PCM have to be somehow economical to gain acceptance.

Technical realisation of Phase-Change-Materials for heat storage and insulation

For a technical realisation of Phase-Change-Materials, these have to be somehow bonded. A solution for this problem is, besides a compound-element, a type of encapsulation. An encapsulation is a hermetically sealed sheathing. Referred to the size of the sheathing it differs between the macro encapsulation and the micro encapsulation.

An encapsulation has to fulfil many requirements /Lane1986/. Table 11-2 gives an overview about these requirements.

Mechanical stability
Flexibility
Thermal stability
Barrier for moisture, air etc.
Stable against UV and environmental influences
Heat conductance
No corrosivity
No reaction between PCM and encapsulation

Table 11-2: Requirements for an encapsulation /Lane1986/

Macro encapsulation

The most common type of PCM containment is the macro encapsulation, in which a significant quantity of PCM is encapsulated in a discrete unit. The volume of PCM per unit may range from a few grams to many pounds. PCM that are packed like this may be used as a storage device for floor heating for example.

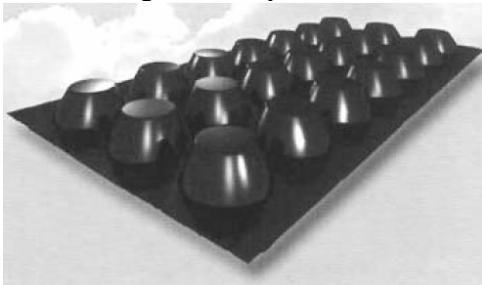

Figure 11-7: Macro encapsulation /TEAP/

Micro encapsulation

The micro encapsulation is a chemical or physical procedure, in which smallest particles of the PCM are completely enclosed in a shell with a diameter of 1 – 1000 μm .

Microcapsules are used worldwide since 1953 in carbon papers.

According to /Jahns2004/ chemical in-situ processes are most adequate for setting up microcapsules.

Molten paraffin is distributed through agitation into water. Depending on the speed of the agitation and some other parameters tiniest paraffin drops are generated.

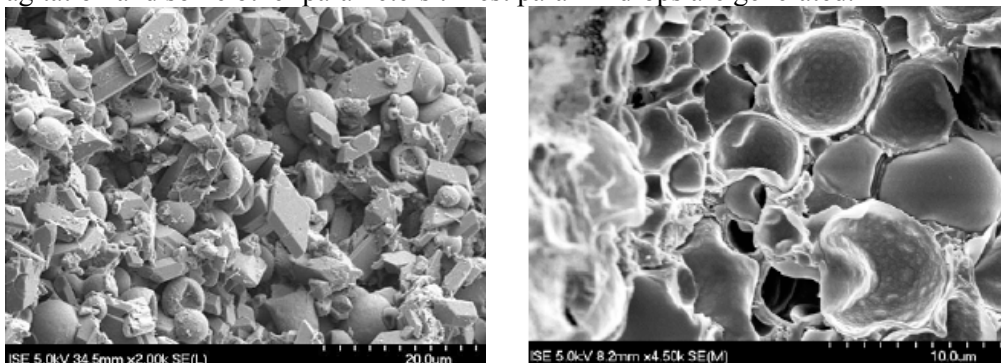

Figure 11-8: Micro encapsulation /ISE/

Around every of these drops a stable and very thin wall of preliminary synthetic products is generated for the microcapsules with a size of 3-20 μm /BINE2002b/, /Jahns2004/.

Phase-Change-Materials which are worked up like this can easily be processed further. They may find appliance in plasterboards, finery or putty. The company Maxit for example has PCM-filled finery, which is to be described further in chapter 0.

Usage of Phase-Change-Materials for heat storage and insulation

For an increase of the thermal storage capacity in buildings the use of Phase-Change-Materials is outstanding /BINE2002b/, /Schossig2004/, /Henning2002/. Some of the possible usages for this purpose are shown in Figure 11-9.

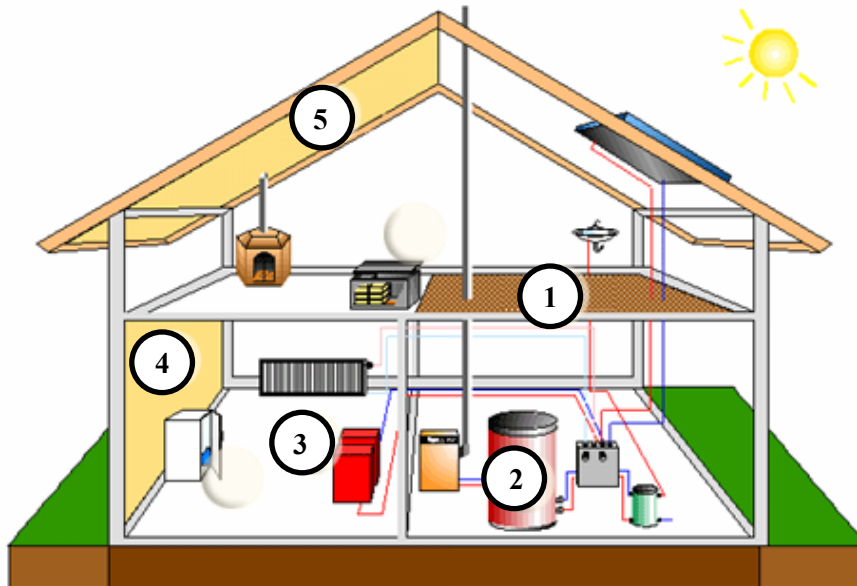

Figure 11-9: Possible Usages for PCM /Rubitherm/

The increase of the thermal storage capacity is possible through the following alternatives, which are to be described afterwards:

- Floor-elements with PCM
- Latent hot water tank
- Air reservoir with PCM
- Insulation with PCM

Floor-Elements with PCM

A possibility for heat storage with PCM is the use as an element for floors. The TEAP Company sells those floor-elements for the use with floor heating systems /TEAP/.

The basic principle of such an element like it is shown in Figure 11-10 is pretty ordinary.

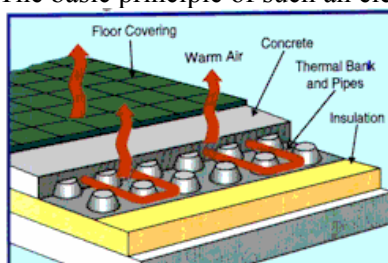

Figure 11-10: Floor-elements /TEAP/

As long as the floor heating systems provides heat, the PCM-elements are loaded. After the heating is shut down, the latent stored energy can be provided by the elements to the room.

Latent hot water tank

Figure 11-11 shows the schematic arrangement of a latent hot water tank for heating and hot water generation. The latent storage material is located inside of the tank and therefore has direct contact to the water.

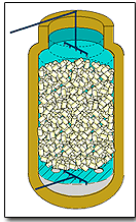

Figure 11-11: Latent hot water tank /Rubitherm/

The Rubitherm GmbH /Rubitherm/ says that the heat storage capacity of such a tank could be 2.5 times greater (at 10 K temperature difference) and a significant diminishment in storage volume and required space could be achieved.

Air-reservoir with PCM

Another possibility of latent heat storage is a PCM-filled Air-reservoir. The fresh air, coming from outside of the building, is warmed up by conveyance through a container filled with PCM-granulate. The stored energy in this PCM-granulate, which is provided by exhaust air or by hot water from a solar circulation, is used to heat up the incoming air.

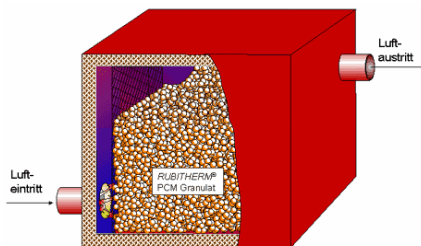

Figure 11-12: Air-reservoir with PCM /Rubitherm/

By using PCM as a preheating unit heating costs could be reduced and cold draught could be avoided. Therefore this is an interesting solution for usages in administration or rather large buildings. The application in single occupancy houses is also imaginable, but the question arises, whether the additional charges for such a system would be worthwhile.

Insulation with PCM

In Figure 11-13 the possibility for enhancing the heat storage capacity of a wall by using insulation with Phase-Change-Materials is illustrated.

As already said the Maxit Company offers PCM-filled finery. At the moment the usage of this finery is the protection from overheating in the summer. This is a result of their relatively high melting temperature at 26°C. An application as a heat storage device is imaginable for the future because a lower melting range could easily be realised.

Through the possibility of the micro-encapsulation the PCM-material could be used in other building materials besides finery. The application in gypsum plasterboards is another example for the possible implementation in insulation.

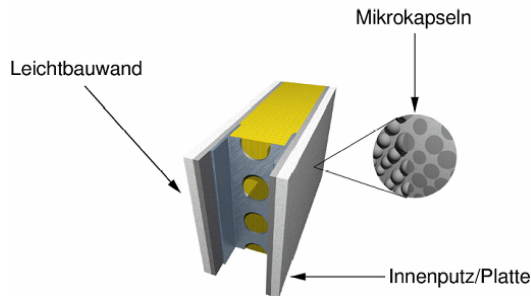

Figure 11-13: Insulation with Phase-Change-Materials /ISE/

Furthermore an application as a passive building material is absolutely imaginable.

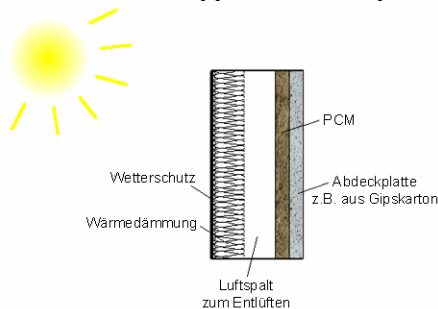

Figure 11-14: PCM as a passive building material /Rubitherm/

According to /Lenzen2002/ the development of a latent building material for an usage in transparent insulated walls is investigated.

11.1.2 Efficiency

PCM-elements work as storage devices. Since the thermal energy is just stored and is given back as thermal energy there are no conversion losses of the system itself.

Within the PCM-elements the energy is stored without losses until the temperature drops under the melting point and the energy is provided back to the room.

11.1.3 Thermal Storage

Basically there are three methods of storing thermal energy. It is differentiated between the thermo chemical, the sensible and the latent heat storage /Fisch2004/, /Lane1983/.

The thermo chemical heat storage uses appropriate reversible chemical reactions, like for example the adsorption of a working substance on a solid. The energy in this type of heat storage, which should not be described any further, is stored in endo- and exothermal chemical reactions.

Sensible heat storage

If heat is provided to a material, the temperature of this material rises. The provided energy is stored in sensible heat which can be felt.

$$Q = c \cdot m \cdot \Delta T = c \cdot \rho \cdot V \cdot \Delta T = \Delta x \cdot A \cdot c \cdot \rho \cdot \Delta T$$

The sensible heat storage is the type of heat storage which is the most familiar form, as our senses gauge the heat content of a material by how hot or cold it may feel.

Latent heat storage

If the temperature of the warmed up material passes a phase-change, the temperature does not rise, although heat is continuously provided. The energy needed for the phase-change is stored as latent (latent [lat.], existing covertly) energy.

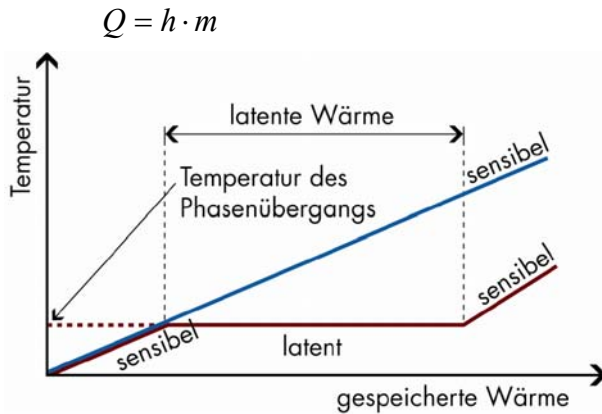

Figure 11-15: Comparison of latent and sensible heat /BINE2002a/

Since the heat storage capacity before and after the phase change is not equal, the whole stored energy of the Phase-Change-Material can be calculated with

$$Q = m \cdot \left[\underbrace{c_1 \cdot (T_m - T_1)}_{\text{sensibel}} + \underbrace{h}_{\text{latent}} + \underbrace{c_2 \cdot (T_2 - T_m)}_{\text{sensibel}} \right]$$

The energy needed for melting is stored in the PCM and is provided as heat when the material solidifies.

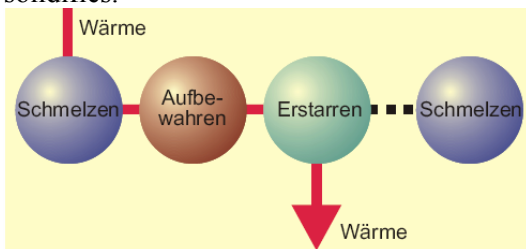

Figure 11-16: Latent energy /Rubitherm/

In Table 11-3 some characteristics for selected Phase-Change-Materials are stated.

Medium	Phase-Change	Phase-Change-temperature θ_f °C	Phase-Change-heat Δh_f kJ/kg	specific heat storage capacity c_{p1}/c_{p2} kJ/kg K	
Water	solid/liquid	0	335	2,1/4,19	
	liquid/gaseous	100	2.540	4,19/1,86	
Paraffine	solid/liquid	36,6	243	1,94/2,08	
	Rohparaffin solid/liquid	34,3	142		
Fettsäuren	Laurinsäure solid/liquid	44	183	1,8/2,16	
	Myristinsäure solid/liquid	54	187		
	Stearinsäure - rein - technisch	solid/liquid	69,7		221
		solid/liquid	64,8		203
Salzhydrate	$\text{Na}_2\text{SO}_4 \cdot 10\text{H}_2\text{O}$ solid/liquid	32	241		
	$\text{Na}_2\text{S}_2\text{O}_3 \cdot 5\text{H}_2\text{O}$ solid/liquid	48	201,2		
	$\text{Ba}(\text{OH})_2 \cdot 8\text{H}_2\text{O}$ solid/liquid	78	266,7		
Salzgemische	48NaCl/52MgCl ₂ solid/liquid	450	432	0,9/1,0	
	67NaF/33MgF ₂ solid/liquid	832	618		1,42/1,38

Table 11-3: Characteristics for some Phase-Change-Materials /Fisch2004/

For the simulation of PCM-elements a simulation-tool had to be accomplished. This was realized using LabVIEW™.

The cooling down behaviour of the room temperature at different outside temperatures, while the heating system is turned off, is to be investigated. A comparison between the cooling-down-times is done for different exemplary walls. The usage type of the PCM is the insulation with PCM, which was described in 0. Each wall is simulated at initial state, with insulation, with 2 cm PCM-filled finery and with both, insulation and a PCM-layer.

Simulation results

The room temperature at the initial state (walls without insulation) is decreasing very fast. The time in which the room is cooling down to 18°C is only several minutes. A great increase can be accomplished by every one of the improvements.

The simulation results for the three cases at an outside temperature of 0°C are shown in Figure 11-17.

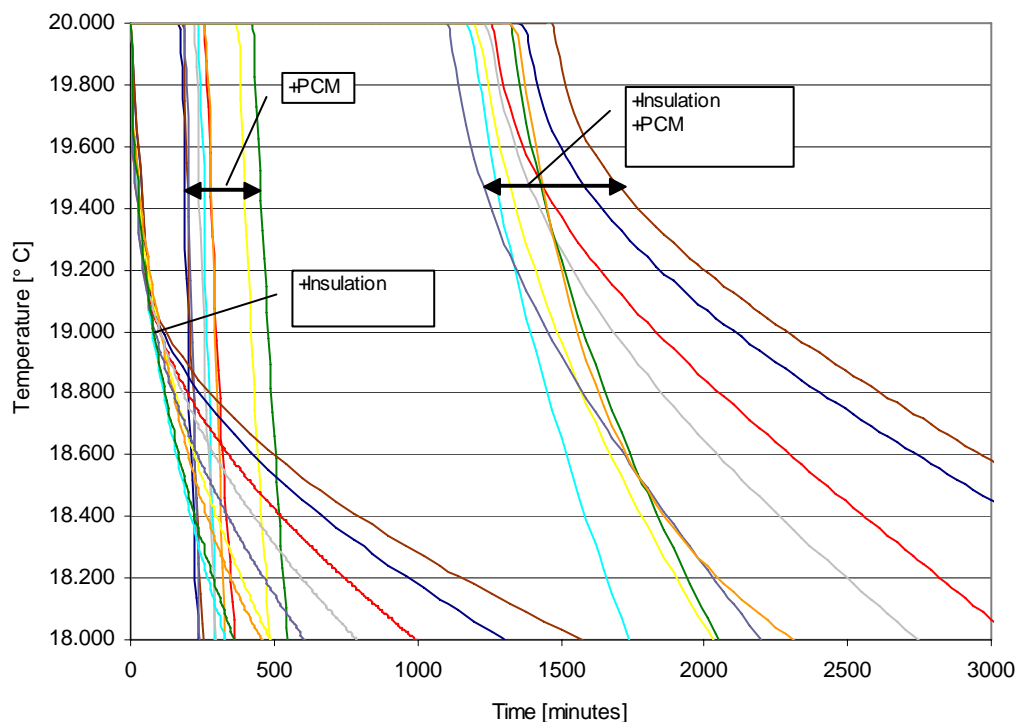

Figure 11-17: Simulation results for an outside temperature of 0°C /Faulstich2005/

Instead of several minutes the cooling-off-time is in the range of several hours. The achieved improvement is therefore enormous. The time in which the heating system could be turned off is extremely increasing. This leads to a better possible usage of buildings as energy-storage devices.

The simulation results for one typical wall-type (the red curves from Figure 11-17) at the initial state and together with insulation as well as a simulation result for a wall which only consists of a 12 cm insulation-layer and the simulation results for the wall with a 2 cm PCM-layer and for the wall with insulation and a PCM-layer are shown in Figure 11-18.

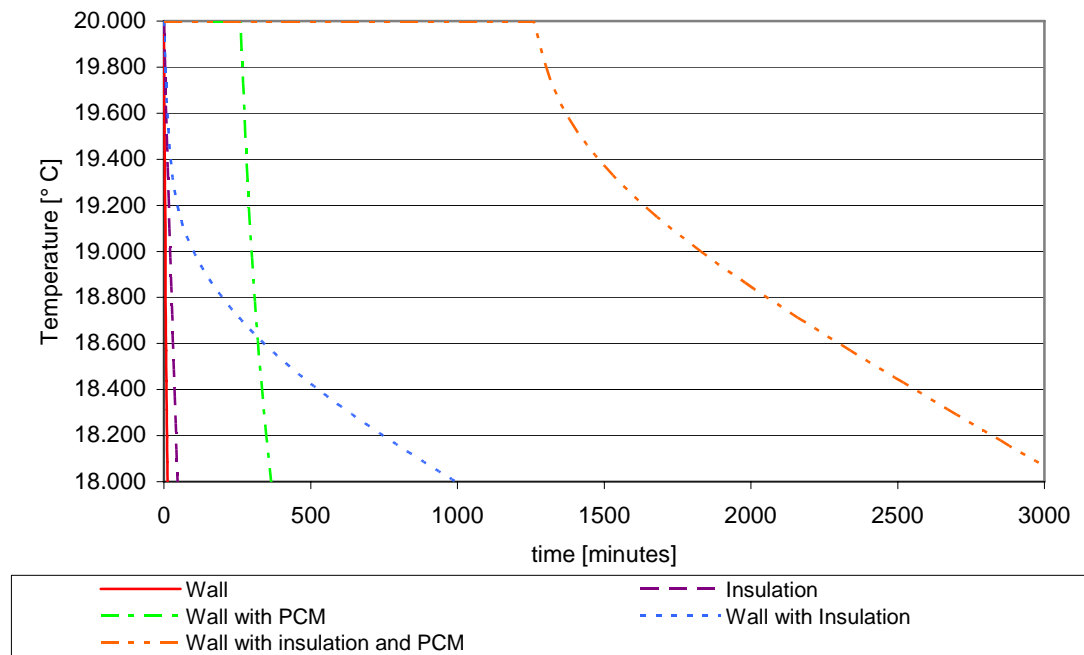

Figure 11-18: Simulation results for an outside temperature of 0°C – II /Faulstich2005/

The behaviour of the wall without insulation and without PCM-layer as well as of the wall with insulation and of the insulation layer was already described in the part “Buildings as Energy Storage Devices”.

For the description of the behaviours of the walls with PCM-layer (with and without insulation) we again need the law of heat conduction. The first important variable, the heat conductivity, does not really change in the cases with PCM-layer. It is still dominated by the insulation. Nevertheless the results show a much longer duration for the cooling. This is a consequence of the increased storage capacity. The energy which was needed for the phase change of the PCM is in the case of cooling provided to the room. At the beginning of the cooling the temperature remains the same because the PCM-layer first has to finish the phase change (in this case at 20°C). The time which is needed for this depends on the heat transfer and therefore on the conductivity of the wall. After finishing the phase change the temperature drops very fast. The characteristic of the falling temperature is then the same as in the case of the wall without PCM. As we can see in Figure 18 the run on the curve of the green line is after finishing the phase change the same as of the red curve. The same is true for the orange curve compared to the blue one.

This leads to the conclusion that both, low heat conductivity and high heat storage capacity, are very important for the cooling behaviour. Therefore it is senseless regarding just one of these characteristics. For a long turn-off time both need to be optimised. Today the conductivity seems to be more important for most people and the storage capacity is neglected. For using walls as energy storage devices the storage capacity is getting more and more important.

A possibility of increasing the storage ability is the use of PCM. In combination with a low heat conductivity long off periods can be achieved. This leads to a better possible usage of buildings as energy-storage devices.

11.1.4 Technical Problems and Solutions

An unresolved problem which occurs at a PCM-insulation-usage is the difference between the room temperature and the temperature of the wall surface. Because of the heat transmission coefficient the surface temperature is below the room temperature (assuming that it is colder outside). In the simulation the melting point of the PCM had been at 20°C. When the surface

temperature drops below 20°C the PCM provides energy to the room and the temperature is kept constant. This case isn't a problem because the room temperature drops itself. The problem occurs when heating up again and when the PCM is supposed to melt. To increase the surface temperature of the wall up to 20°C, the room temperature has to be much higher.

A possible solution for this problem could be the usage of a heating installation directly at the wall to provide thermal radiation to the PCM.

11.2 Assessment

11.2.1 Technical assessment: Suitability and availability

Knowledge about the area of the outside walls is essential for an assessment of the technical potential. Therefore an estimation of the amount of buildings was done by using the overall living space and the living space per building /IWU/. This leads to the fact that there are about 12 million buildings in Germany. The estimation of the available area of the outside walls was done with this result and the wall area per building /IWU/. In the country of Germany there are about 12 million buildings with an overall living space of 2.649 km² and an overall area of the outside walls which is with 2.347 km² nearly as much as the living space.

Assumed that the building materials have an average density of 1000 kg/m³ and regarding that the specific heat storage capacity is according to DIN 4108 for all inorganic materials 1 kJ/kgK, the energy stored in the walls of Germany can be calculated with

$$Q = x \cdot A \cdot c \cdot \rho \cdot \Delta T$$

$$Q = 0,3m \cdot 2347 \cdot 10^6 m^2 \cdot 1000 \frac{kg}{m^3} \cdot 1000 \frac{J}{kg \cdot K} \cdot \Delta T = 0,3 \cdot 2347 \cdot 10^6 \cdot 1000 \cdot 1000 \cdot \Delta T \frac{J}{K}$$

$$Q = 700TJ \cdot \Delta T [K] = 195 \cdot 10^6 kWh \cdot \Delta T [K]$$

At a temperature difference of 1°C there is as much energy in Germany's walls as in 19,5 million litres Oil (with an annual heating energy demand of 2.000 litres oil per flat in Germany, this energy correspond approximately to the energy demand of 25.000 Germans).

If all the boundary walls would get a PCM-finery-layer of 2 cm, the stored energy would be increased by the latent energy of the PCM-finery. This latent energy can be calculated with the following formula. The average heat of fusion of PCM is 180 kJ/kg. For the calculation of the stored latent energy we can just take 18 kJ/kg because the PCM-finery-layer consists of 10% PCM and 90% finery.

$$Q_{stored, latent} = 2cm \cdot 2347km^2 \cdot 1000 \frac{kg}{m^3} \cdot 18000 \frac{J}{kg} = 0,02 \cdot 2347 \cdot 10^6 \cdot 1000 \cdot 18000 \cdot J \approx 845 TJ$$

For storing such a high amount of energy about 200 million m³ water per degree Celsius would be necessary.

$$m = \frac{Q_{stored}}{c \cdot \Delta T} = \frac{845 \cdot 10^9 kJ}{4,19 \frac{kJ}{kg \cdot K} \cdot \Delta T [K]} \approx 202 \cdot 10^9 kg / \Delta T [K]$$

Assumed furthermore that an average hot water tank stores 300 litres and is working in the temperature range between 40°C and 90°C, then about 13 million hot water tanks would be needed to store an energy amount of 845 TJ. This means that it would be equal to one 300 litre hot water tank in every building in Germany.

Because of the large number density of the heat storage capacity of PCM the potential storage mass in buildings may be strongly increased.

Especially the modern architecture, like the lightweight construction, in spite of having an eye on the insulation ability, does not make use of the energy storage capacity of the building. Because of the lack of storage mass, those buildings are subjected to high variations in

temperature and therefore have a great need for heating and cooling. Phase-Change-Materials could be a remedy.

11.2.2 Comparison with CHP

The usage of buildings as energy storage devices with an increased storage capacity through PCM allows storing heat as well as electrical energy. Therefore it is a perfect supplement to cogeneration as wind power balance instrument.

11.2.3 Economic assessment: Costs, historical and future cost development

Today the increase in comfort by using Phase-Change-Materials is more important than the application for storing energy. The economic assessment is very difficult because an increase in comfort can not easily be monetized. Therefore the following assessment considers only the use as an energy storage device.

For using storage materials in a wide spectrum, a large availability at low investment cost is necessary. A comparison of the prices of an m^3 of different storage materials makes clear, why water still is the most important medium /Fisch2004/. The costs for water are about 1,50 € to 1,80 € per m^3 , 1 m^3 gravel including the supply costs ten times as much and for Phase-Change-Materials the investment costs per m^3 are increased by the factor 1000 compared to water.

According to /BINE2002a/ the prices for PCM with a melting range above 0 °C are about 0,5 €/kg. If an energy price of 0,05 €/kWh is assumed, then 10 kWh are to be stored per kilogram PCM to balance the costs with the stored and later used energy.

At a typical storage density of 150 – 200 kJ/kg (\approx 0,05 kWh/kg), 200 cycles during the lifetime are needed. Dependent on the weather conditions this could already be the case after 2 – 3 years.

The following comparison can serve to get an impression about the relation between the stored energy and the value/price of Phase-Change-Materials.

Regarding the profitability of latent storage materials, the BASF AG /Schmidt/ provides an article – “Latentwärmespeicher der BASF - Anwendung und Wirtschaftlichkeit” – showing the simulation results for two examples.

In the first example studies of an administration building where done. The economical comparison was done according to a cooling concept with concrete core activation in the same building. As a result a yearly cost reduction of 25.000 € is presented. Therefore the increased investment costs would have amortised after less than two years.

The second example regards a single occupancy building with 120 m^2 living space.

Here, by assuming an increase of 5% to the energy price, the PCM would have amortised after five years and after 15 years 5000 € would have been saved.

11.2.4 Environmental aspects

For the the choice of the PCM ecological requirements are of significance and have already been considered when choosing an appropriate material. Furthermore the Phase-Change-Materials act as storage devices so that no additional energy is needed in the utilization. Therefore there are no environmental disadvantages.

Just like in the case of using buildings as energy storage devices an advantage can be seen in the fact that the amount of energy which can be shifted would be needed anyway just at another time.

12 References

Chapter 1

/Scheer 2007/ /Scheer, H.: <http://www.eurosolar.de/de/>; Plan für Ökostrom vorgelegt. Artikel erschienen in Frankfurter Rundschau, 20. März 2007.

Chapter 2

/AGFW hs2001/ Pluralistische Wärmeversorgung, AGFW Hauptstudie – Erster Bearbeitungsschritt Band 1, Langfassung, Frankfurt a. M., 2001

/AGFW sb2000/: Pluralistische Wärmeversorgung, AGFW Hauptstudie – Schlussbericht, Frankfurt a. M., 2000

/Armbrüster 2005/ Armbrüster, H.: Neue Chancen durch Regelenergie, 10th Kasseler Symposium Energy Systems Technology, The Future of Distribution Grids, Report 10.-11. November 2005, Kassel

/ASUE 2005/ ASUE (Hrsg.): BHKW-Kenndaten 2005, Verlag Rationeller Erdgaseinsatz, Kaiserslautern, 2005

/ASUE 98/. ASUE (Hrsg.): BHKW-Marktübersicht '98, Verlag Rationeller Energieeinsatz, Kaiserslautern 1998.

/BET 2001/ Krzikalla, N.: Kurzgutachten im Auftrag des Bundesverband Windenergie e. V. und des Bund der Energieverbraucher e. V., Aachen, 2001

/BEI 2004/ Hille, M.; Gabriel, J.: Entwicklung der Kraftwerkskapazitäten an der deutschen Nordseeküste bei Ausbau der Windenergienutzung, Gutachten im Auftrag der Bremerhavener Gesellschaft für Investitionsförderung und Stadtentwicklung mbH Bremer Energie Institut, Bremen, August 2004

/BINE 1995/ Fachinformationszentrum Karlsruhe (Hrsg.): Mini BHKW, BINE Informationsdienst, Bonn, 1995

/BWK 1999/ VDI-Gesellschaft Energietechnik (Hrsg.): BHKW-Handbuch, Brennstoff Wärme Kraft – Zeitschrift des Vereins Deutscher Ingenieure, Sondernummer I/99

/DBDH 1-2004/ Petersen, M. K.; Aagaard, J.: Heat accumulators, News from Danish Board of District heating (DBDH), Journal number 1/2004, Taastrup, Denmark, March 2004. www.dbdh.dk

/DESIRE D 2.1 2005/ Sievers, J.; Stadler, I.; Schmid, J.: Analysis of CHP designs and boundary conditions in different European countries, Deliverable 2.1 EU-Desire-Project, University of Kassel, Kassel, 2005.

/DESIRE D 2.2 2005/ Sievers, J.; Stadler, I.; Schmid, J.: Analysis of CHP designs and boundary conditions in different European countries, Deliverable 2.2 EU-Desire-Project, University of Kassel, Kassel, 2005.

/DESIRE D 3.3/ Madina, C. et al.: Attitudes of market actors to the demonstration projects, DESIRE Deliverable 3.3, Derio, 2005

/DESIRE D 3.2/ Madina, C. et al.: Potential for access to the electricity markets for the demonstration projects in the different countries - case studies, DESIRE Deliverable 3.2, Derio, 2005

/ELTRA/: www.eltra.dk/

/EnWG 1999/ Bundesgesetzblatt: Gesetz zum Einstieg in die ökologische Steuerreform, sowie zur Änderung des Energiewirtschaftsgesetzes und des Mineralölsteuergesetzes Vom 24. März 1999, Bundesgesetzblatt, Jahrgang 1999 Teil I Nr. 14, Bonn, 1999

/Eurostat 2003/: Loesonen, Pekka: Statistik über Kraft-Wärme-Kopplungsanlagen, (KWK-Anlagen) in der EU im Jahr 2000, Eurostat, Statistik kurz gefasst, Umwelt und Energie, Thema 8 - 12/2003

/FfE 2004/ FfE: Analyse des Bestandes von Kraft-Wärme-Kopplungsanlagen in Bayern, Endbericht der Forschungsstelle für Energiewirtschaft e.V. (FfE), München, 2004

/GC 2005/ / Czisch, G.: Szenarien zur zukünftigen Stromversorgung, Dissertation an der Uni Kassel, Kassel 2005

/Geiger 2002/ Geiger, B.; Hellwig, M.: Entwicklung von Lastprofilen für die Gaswirtschaft, im Auftrag des Bundesverbandes der deutschen Gas- und Wasserwirtschaft e.V. und des Verbandes kommunaler Unternehmen e.V. Gewerbe, Handel und Dienstleistung, Lehrstuhl im Institut für Energietechnik, TU München, München, November 2002

/Impulsprogramm 05/ <http://www.impulsprogramm.de/>

/IS 2000/ Stadler, I.: Dialogfähige Energiemanagementsysteme im Kontext von Energieverbrauch und Nutzerverhalten, Dissertation an der Universität Kassel, Kassel, 2000

/IS 2005/ Stadler, I.: Demand Response, Nichtelektrische Speicher für Elektrizitätsversorgungssysteme mit hohem Anteil erneuerbarer Energien, Habilitation eingereicht beim Fachbereich Elektrotechnik der Universität Kassel, Kassel, 2005

/ISET 2004/ ISET (Hrsg.): Windenergie Report Deutschland 2004, Institut für Solare Energieversorgungstechnik, Kassel, 2004

/ISETb 2004/ Hoppe-Kilpper, M.; Rohrig, K.: Integration großer Offshore-Leistungen in die elektrische Energieversorgung, Institut für solare Energieversorgungstechnik (ISET), Kassel, 2004

/KSS 05/ Armbrüster, H.: Neue Chancen durch Regelenergiemärkte, Tagungsband Zehntes Kasseler Symposium, Kassel, 2005 p 168 ff.

/Lund and Andersen 2004/ Andersen, Anders N; Lund, Henrik: *Decentralised CHP in a Competitive market*. News from DBDH journal 1/2004 pp. 14-17. [Danish Board of District Heating](#). Download: (1295 KB)

/Quaschnig 2000/ Quaschnig, V.: Systemtechnik einer klimaverträglichen Elektrizitätsversorgung in Deutschland für das 21. Jahrhundert, Fortschr.-Ber. VDI Reihe 6 Nr. 437. Düsseldorf: VDI Verlag 2000

/Recknagel 1999/ Recknagel, H.; Sprenger, E.; Schramek, E.-R.: Taschenbuch für Heizung + Klimatechnik 2000, R. Oldenburg-Verlag, München-Wien, 1999

/RS 2005/ Kraft-Wärme-Kopplung in Zusammenhang mit thermischen Speichern, Potential zum Ausgleich von Schwankungen in der Stromgenerierung durch erneuerbare Energien, Diplomarbeit Uni Kassel, Kassel 2005

/Traube 2004/ Traube, K.: Die EU- Richtlinie über die Förderung der Kraft-Wärme-Kopplung (KWK) 23.5.04 <http://www.bkww.de/bkww/aktuelles/politik/>

/WEC 2004/ World Energy Council: Energie für Deutschland, Fakten, Perspektiven und Positionen im globalen Kontext, Schwerpunktthema „Zur Dynamik der Öl- und Erdgasmärkte“, Deutsches Nationales Komitee des Weltenergieerates DNK, 2004

/Winkens 1999/ Winkens, H.P.: Heizkraftwirtschaft und Fernwärmeversorgung, ein Kompendium, VWEV-Verlag, 1. Ausgabe, Frankfurt a.M., 1999

Chapter 3

/Stadler 2005/ Stadler, I.: Demand Response - Nichtelektrische Speicher für Elektrizitätsversorgungssysteme mit hohem Anteil erneuerbarer Energien, Habilitation, Kassel, Oktober 2005

/BINE 2001/ BINE Informationsdienst (Hrsg): Stromsparende Pumpen für Heizungen und Solaranlagen; BINE projektinfo 13/01; ISSN 0937-8367; 2001

/Wuppertal 2003/ Wuppertal Institut für Klima, Umwelt, Energie GmbH; Optimierung der Heizungssysteme und „Faktor 4“-Umwälzpumpen in EFH/ZFH; Überarbeiteter Endbericht im Auftrag der Hans-Böckler-Stiftung; Wuppertal; Oktober 2005

/Wuppertal 2004/ Wuppertal Institut für Klima, Umwelt, Energie GmbH; Optimierung der Heizungssysteme und hocheffiziente Umwälzpumpen in größeren Gebäuden; Überarbeiteter Endbericht im Auftrag der Hans-Böckler-Stiftung; Wuppertal; Oktober 2005

/Königstein 2002/ Königstein, Thomas; Die 7-Watt-Heizungspumpe; Energie & Bildung

/BdEV 2002/ Bund der Energieverbraucher; Heizungspumpen – Klein aber fein;

/Wilo 2006/ WILO AG; Mit Hocheffizienz zu mehr Markterfolg; Pressemitteilung; Dortmund; Mai 2006

/BdEv-b/ Bund der Energieverbraucher; Solarspeicher

/Hirschberg 2002/ Hirschberg, Rainer; Bestimmung der Belastungsprofile von Heizungsumwälzpumpen in der Gebäudetechnik – Vergleichende Betrachtung für Süd- und Nordeuropa; VDMA-Bericht; März 2002

/Eicke-Henning 2006/ Eicke-Henning, Werner; Alte Umwälzpumpen: Verschwendung im Dauerlauf – 1000 EUR Energiekosten sparen mit modernen Pumpen; Pressemitteilung der Hessischen Energiespar-Aktion; Frankfurt/Main; Mai 2006

/Hans 2006/ Haus und Markt; Zu viele Haus-Oldies in Deutschland

/Wuppertal 2002/ Wuppertal Institut für Klima, Umwelt, Energie GmbH; Umwälzpumpen für Heizungsanlagen – Faktor 4 Praxisbeispiele; 2002

/DESTATIS 2003/ Statistisches Bundesamt Deutschland DESTATIS; Bewohnte Wohneinheiten in Wohngebäuden und sonstigen Gebäuden mit Wohnraum nach Belegung und Fläche; August 2003

/Faulstich 2007/ Faulstich, Stefan; Phasenwechselmaterialien zur Wärmespeicherung und Wärmedämmung; Diplomarbeit an der Universität Kassel; Dezember 2005

/VDI R2067/ VDI Richtlinie 2067 „Berechnung der Kosten von Wärmeversorgungsanlagen“, Blatt 4 „Warmwasserversorgung“

/ISI 2002/ ISI / DIW / GfK / IfE: Energieverbrauch der privaten Haushalte und des Sektors Gewerbe, Handel, Dienstleistungen (GHD). Projektnummer 17/02, Abschlussbericht an das Bundesministerium für Wirtschaft und Arbeit, März, 2004

/VDEW 2006/ Verband der Elektrizitätswirtschaft – VDEW (Hrsg.), Arbeitsgemeinschaft Energiebilanzen; Endenergieverbrauch in Deutschland 2004; Berlin; April 2006

/Fisch 2004/ Fisch, N.; Kühl, L.; Schnürer, H.; Wärmespeicher; TÜV-Verlag, Reihe „BINE-Informationspakete“, 4. erweiterte und völlig überarbeitete Auflage 2004 ISBN 3-8249-0853-0

/Dimplex 2007/ Informationen der Firma Dimplex@ www.dimplex.de

/Stiebel 2007/ Informationen der Firma Stiebel Eltron@ www.stiebel-eltron.de

/BVWP/ Bundesverband Wärmepumpe

/STBA/ Statistisches Bundesamt Deutschland DESTATIS; Bewohnte Wohneinheiten in Wohngebäuden und sonstigen Gebäuden mit Wohnraum nach Belegung und Fläche; August 2003

Chapter 4

H.Carlsen, '10 kW Hermetic Stirling Engine for Stationary Applications' 6th International Stirling Engine Conference, Eindhoven, Holland, ISEC-93 086, 6p.

H.Carlsen, 'Operating experience with a 10 kW hermetic Stirling Engine', 20th Intersociety Energy Conversion Engineering Conference, Monterey CA, USA, August 1

Münster, E and Carlsen,H: 'Operation Experiences, Wood Chip Fuelled Stirling Engines below 100 kW, Denmark and Austria.' BioEnergy 2005 conference, Trondheim.

Chapter 5

TriGeMed project “*Promotion of Tri-generation technologies in the tertiary sector in mediterranean countries*”. Survey Report,. August 2003. http://www.trigemed.com/images/files/Trigemed_Survey_Report_en.pdf, November 2006

Picon M., Teopa E., Gallegos A. “*Selección de Turbinas de Gas para Sistemas de Trigeneración*” (“*Selection of Gas Turbines for Trigeneration Systems*”). Información

tecnológica, vol.16, n°6-2005, pp.79-86, ISSN 0718-0764, Online version: http://www.scielo.cl/scielo.php?script=sci_arttext&pid=S0718-07642005000600012&lng=es&nrm=iso, November 2006

Gesellschaft für Biogas und Umwelttechnik mbH (Company for Environmental Technology), *Construction of the Adsorption Chiller NAK*. <http://www.gbunet.de/frame-set/Frame-Set%20AK-NAK-e.html>, November 2006

Wikipedia, *Vapor-compression refrigeration*, http://en.wikipedia.org/wiki/Vapor-compression_refrigeration, November 2006

Wang R.Z., Oliveira R. G., “*Adsorption refrigeration – An efficient way to make good use of waste heat and solar energy*”, International Sorption Heat Pump Conference, June 22-24, 2005; Denver (CO), USA; ISHPC - 101 K - 2005, <http://www.sjtuirc.sjtu.edu.cn/news/ISHPC%20-%20101%20K.pdf>, November 2006

Guo W., “*The state-of-the art of trigeneration and its application in tertiary sector*”, TriGeMed project. <http://www.zeri.org.cn/Energy%20Documents/TRIGEMED-synth.pdf>, November 2006

Broad Air Conditioning, *Absorption chiller product catalogues*. <http://www.broad.com>, November 2006

Energy Star, *Heating & Cooling* <http://www.energystar.gov>, November 2006

MacCracken M., “*Thermal Energy Storage in Sustainable Buildings*”, ASHRAE Journal-Reprinted by CALMAC Manufacturing Corporation. September 2004, http://www.ashrae.org/doclib/20061025_22616MacCracken.pdf, November 2006

YORK INTERNATIONAL. <http://www.york.com>, November 2006

Cogen Europe, “*Cogen Challenge: The European information campaign on small-scale cogeneration*”, Newflash N°4, June 2006, http://www.cogen.org/cogen-challenge/Downloadables/Newsflash/Newsflash_4.pdf, November 2006

Weeda M. “*Combined Cold Heat and Power Generation – Techno-economic assessment of integrated fuel cell and sorption heat pump systems*”. ECN – Clean Fossil Fuels, ECN-C-02-074, November 2002, <http://www.ecn.nl/docs/library/report/2002/c02074.pdf>, November 2006

Frejman M., “*Trigeneration-three benefits in one*”, Wärstilä Energy News, Issue 18, February 2004, ISSN 1456-3274, pp.22-23, http://www.wartsila.com/Wartsila/global/docs/en/power/media_publications/energy_news/18/trigeneration.pdf, November 2006

EcoGenerationSolutions, *Trigeneration Technologies*, <http://www.cogeneration.net/Trigeneration.htm>, November 2006

Arias-Varela H.D., Soto-Gomez W., Castillo-Lopez O., Best-Brown R., “*Thermodynamic design of a solar refrigerator to preserve sea products*”, <http://www.cientificosaficionados.com/energia%20solar/termodinamica.pdf>, November 2006

cHose project. “*Energy Savings by CHCP plants in the Hotel Sector. Absorption chillers*”. May 2001, http://www.inescc.pt/urepe/chose/reports/B-absorption_chillers.pdf, November 2006

Sebzali M. J., Rubini P. A., “*Analysis of ice cool thermal storage for a clinic building in Kuwait*”, Energy Conversion and Management, December 2005, <http://public.cranfield.ac.uk/me/me028/rubini/thesis/publications/sebzali1.pdf>, November 2006.

Massagués L., Rodríguez J., Bruno J.C., Coronas A. “Estudio comparativo de una instalación de trigeneración con microturbina de gas y un sistema convencional con bomba de calor en un complejo hotelero” 9th Spanish Portuguese Congress on Electric Engineering (9CHLIE), July 2005, <http://www.aedie.org/9CHLIE-paper-send/402-MASSAGUES.pdf>, November 2006

Orden ITC/4101/2005, de 27 de diciembre, por la que se establecen las tarifas de gas natural y gases manufacturados por canalización, alquileres de contadores y derechos de acometida para los consumidores conectados a redes de presión de suministro igual o inferior a 4 bar (Order TCI/4101/2005, December 27, which establishes tariffs for natural gas and manufactured gases through pipeline, renting of meters and connection rights for consumers connected to networks with a supply pressure equal or lower than 4 bar), Boletín Oficial del Estado – BOE (Spanish Official Gazette), nº 312, pp.43132-43139, December 30, 2005

Real Decreto 1556/2005, de 23 de diciembre, por el que se establece la tarifa eléctrica para 2006 (Royal Decree 1556/2005, 23 December, which establishes electric tariff for 2006), Boletín Oficial del Estado – BOE (Spanish Official Gazette) nº310, pp.42576-42600, December 28, 2005

OMEL, website, <http://www.omel.com>, November 2006

Chapter 6

- [1] Finansministeriet. En omkostningseffektiv klimastrategi. <http://www.dmi.dk/dmi/web-3.pdf> 2003.
- [2] Lund H, Østergaard P, Andersen AN, Hvelplund F, Mæng H, Münster Eet al. Lokale Energiarkeder (Local Energy Markets). 2004.
- [3] Teknologirådet. Dansk energiproduktion i fremtiden. 2006.
- [4] Blarke MB, Lund H. The effectiveness of storage and relocation options in renewable energy systems. Manuscript submitted for publication to Renewable Energy, April 2007.
- [5] Ai-gruppen øa. Central jordvarmepumpe til landsbysamfund 1997.
- [6] Energimyndigheten. Energy in Sweden Facts and figures 2005. <http://www.energimyndigheten.se/web/biblshop.nsf/frameset.main?ReadForm&Doc=1766> 2006.
- [7] Prof Robert Critoph. Gas-powered sorption heat pump. <http://www.carbontrust.co.uk/NR/rdonlyres/4335F33F-CB14-497E-B89C-205790B39192/0/2003386.pdf> 2006.
- [8] Sumio YagyuIchiro Fujishima, Yuji Fukuyama, Tomoyuki Morikawa, Norio Obata, John Corey, Naotsugu Isshikiet al. Performance characteristics of a gas engine driven Stirling heat pump. 2006.
- [9] Danish Technological Institute. Danish Technological Institute (Danish: Teknologisk Institut) 2007. See also: <http://www.teknologisk.dk>
- [10] Advansor A/S. Advansor A/S 2007. See also: <http://www.advansor.dk>
- [11] Blarke MB, Lund H. Large-Scale Heat Pumps In Sustainable Energy Systems: System And Project Perspectives. Journal of Thermal Science 2007;In Press, Corrected Proof.
- [12] Blarke MB, Andersen A. Technical and economic effectiveness of large-scale compression heat pumps and electric boilers in energy systems with high penetration levels of wind power and CHP. Manuscript submitted for publication to Energy, April 2007.
- [13] Anon. Law 1417. Retsinfo 2006.

Chapter 7

- [1] M. Farooque and H. C. Maru, "Fuel Cells - The Clean and Efficient Power Generators," Proceedings of the IEEE, vol. 89, no. 12, pp. 1819-1829, 2001.
- [2] J. Zhang, Z. Xie, J. Zhang, Y. Tang, C. Song, T. Navessin, Z. Shi, D. Song, H. Wang, and D. P. Wilkinson, "High temperature PEM fuel cells," Journal of Power Sources, vol. 160, no. 2, pp. 872-891, Oct.2006.
- [3] A. Weber and E. Ivers-Tiffée, "Materials and concepts for solid oxide fuel cells (SOFCs) in stationary and mobile applications," Journal of Power Sources, vol. 127, no. 1-2, pp. 273-283, Mar.2004.
- [4] R. W. Sidwell and W. G. Coors, "Large limits of electrical efficiency in hydrocarbon fueled SOFCs," Journal of Power Sources, vol. 143, no. 1-2, pp. 166-172, Apr.2005.
- [5] A. Roy, S. Watson, and D. Infield, "Comparison of electrical energy efficiency of atmospheric and high-pressure electrolyzers," International Journal of Hydrogen Energy, vol. 31, no. 14, pp. 1964-1979, Nov.2006.
- [6] A. Marshall, B. Borresen, G. Hagen, M. Tsytkin, and R. Tunold, "Hydrogen production by advanced proton exchange membrane (PEM) water electrolyzers--Reduced energy consumption by improved electrocatalysis," Energy, vol. 32, no. 4, pp. 431-436, Apr.2007.
- [7] J. Ivy, "Summary of Electrolytic Hydrogen Production - Milestone Completion Report," No. NREL/MP-560-36734, National Renewable Energy Laboratory, Colorado, USA,2004.
- [8] A. Qi, B. Peppley, and K. Karan, "Integrated fuel processors for fuel cell application: A review," Fuel Processing Technology, vol. 88, no. 1, pp. 3-22, Jan.2007.
- [9] H. Tu and U. Stimming, "Advances, aging mechanisms and lifetime in solid-oxide fuel cells," Journal of Power Sources, vol. 127, no. 1-2, pp. 284-293, Mar.2004.
- [10] H. Apfel, A. Rzepka, H. Tu, and U. Stimming, "Thermal start-up behaviour and thermal management of SOFC's," Journal of Power Sources, vol. 154, no. 2, pp. 370-378, Mar.2006.
- [11] H. Lund and B. V. Mathiesen, "Danish Society of Engineers' Energy Plan 2030, Ingeniørforeningens Energiplan 2030 - Tekniske energisystemanalyser, samfundsøkonomisk konsekvensvurdering og kvantificering af erhvervspotentialer. Baggrundsrapport," Danish Society of Engineers, IDA, Copenhagen,Dec.2006.
- [12] B. V. Mathiesen and H. Lund, "Fuel-efficiency of hydrogen and heat storage technologies for integration of fluctuating renewable energy sources," St. Petersburg: Energy Systems Institute: St. Petersburg Polytechnical University, 2005.
- [13] The Danish Ministry of Transport and Energy, "Energy Strategy 2025 - Perspectives to 2025 and Draft action plan for the future electricity infrastructure," The Danish Ministry of Transport and Energy, Copenhagen,Nov.2005.

[14] United States Department of Energy, "Hydrogen Posture Plan - An Integrated Research, Development and Demonstration Plan," U.S. Department of Energy (DOE), Washington DC, Feb. 2004.

[15] V. Karakoussis, N. P. Brandon, M. Leach, and R. van der Vorst, "The environmental impact of manufacturing planar and tubular solid oxide fuel cells," *Journal of Power Sources*, vol. 101, no. 1, pp. 10-26, Oct. 2001.

[16] R. Dones, C. Bauer, R. Bolliger, and B. Burger, "Ecoinvent 2000 - Life Cycle Inventories of Energy Systems: Results for Current Systems in Switzerland and Other UCTE Countries. Data V.1.1., Ecoinvent Report No. 5," July 2004.

[17] R. Frischknecht and G. Rebitzer, "The ecoinvent database system: A comprehensive web-based LCA database," *Journal of Cleaner Production*, vol. 13, no. 13-14, pp. 1337-1343, 2005.

[18] R. Frischknecht, N. Jungbluth, H. J. Althaus, G. Doka, R. Dones, T. Heck, S. Hellweg, R. Hirschler, T. Nemecek, G. Rebitzer, and M. Spielmann, "The ecoinvent database: Overview and methodological framework," *International Journal of Life Cycle Assessment*, vol. 10, no. 1, pp. 3-9, 2005.

[19] R. Frischknecht, N. Jungbluth, H. J. Althaus, G. Doka, R. Dones, T. Heck, S. Hellweg, R. Hirschler, T. Nemecek, G. Rebitzer, and M. Spielmann, "Ecoinvent 2000 - Overview and Methodology. Data V1.1, Ecoinvent Report No.1," Swiss Centre for Life Cycle Inventories, Dübendorf, June 2004.

Chapter 8

/AEA OPET 2004/ Simader, G. R.; Ritter, H.; Benke, G. (E.V.A., the Austrian Energy Agency): Mikro- und Mini-KWK-Anlagen in Österreich, Micro- and Mini-CHP Plants in Austria, March 2004

/ASUE 2000/ ASUE (Hrsg.): Flexible Stromerzeugung mit Gasturbinen, Kaiserslautern

/ASUE 2001/ ASUE (Hrsg.): Grundlagen - Technik - Betrieb, Kaiserslautern

/DESIRE D 2.2 2006/ Sievers, J.; Stadler, I.; Schmid, J.: Concepts for small scale CHP units to be integrated into buildings or industry and medium scale CHP units with district heating, EU-Desire-Project, University of Kassel, Kassel, 2006.

/Diel/ Dielmann, K.; Schieke, W.: Mikrogasturbinen, Aufbau und Anwendung, Präsentation beim VDI Düsseldorf, September 2001 (FH Aachen)

<http://www.nowum-energy.com/index.php3?currentNumber=8¤tIsExpanded=0>, 12/2006

/FVS 01/ Bard, J.; Blum, L.; Brinner, A.: Dezentrale Kraftwärmekopplung – Konversionstechnologien und Einsatzmöglichkeiten, FVS Themen 2001, 2001

/ISET/ http://www.mikrogasturbine.de/die_gasturbine.html, 12/2006

/VDEW 98/ Vereinigung Deutscher Elektrizitätswerke – VDEW – e.V.: *Raumwärmemarkt – Strategie-Optionen deutscher Stromversorger*. Verlags- und Wirtschaftsgesellschaft der Elektrizitätswerke m.b.H. – VWEW, Frankfurt am Main 1998

/Winkens 1999/ Winkens, H.P.: Heizkraftwirtschaft und Fernwärmeversorgung, ein Kompendium, VWEW-Verlag, 1. Ausgabe, Frankfurt a.M., 1999

Chapter 9

/Mod1975/ Moditz, H. : Elektrische Raumheizung. Springer-Verlag, Wien –New York 1975

/STA2005/ Stadler, I.: Demand Response, Nichtelektrische Speicher für Elektrizitätsversorgungssysteme mit hohem Anteil erneuerbarer Energien, Habilitation eingereicht beim Fachbereich Elektrotechnik der Universität Kassel, Kassel, 2005

/VDEW98/ Vereinigung Deutscher Elektrizitätswerke –VDEW – e.V.: *Raumwärmemarkt – Strategie-Optionen deutscher Stromversorger*. Verlags- und Wirtschaftsgesellschaft der Elektrizitätswerke m.b.H. – VWEW, Frankfurt am Main 1998

/Win1999/ Winkens, H.P.: Heizkraftwirtschaft und Fernwärmeversorgung, ein Kompendium, VWEW-Verlag, 1. Ausgabe, Frankfurt a.M., 1999

Chapter 10

/BMU2006/ Bundesministerium für Umwelt; Naturschutz und Reaktorsicherheit; Politikinstrumente zur Effizienzsteigerung von Elektrogeräten und –anlagen in Privathaushalten, Büros und im Kleinverbrauch; Forschungsbericht 201 41 137; UBA-FB 000870 ISSN 1862-4804; Dessau; Juni 2006

/DIN/ DIN V 4108-6

/EuK/ unveröffentlichte Berechnungen im Rahmen des Netzwerks "Energie und Kommunikation"

/Faulstich2005/ Faulstich, Stefan; Phasenwechselmaterialien zur Wärmespeicherung und Wärmedämmung; Diplomarbeit an der Universität Kassel; Dezember 2005

/ISI2004/ Fraunhofer ISI: Energieverbrauch der privaten Haushalte und des Sektors Gewerbe, Handel, Dienstleistung, Abschlußbericht an das Bundesministerium für Wirtschaft und Arbeit, Projektnummer 17/02, 2004

/Siemens/ typische Kennwerte von handelsüblichen Produkten, Produktdatenblätter Siemens

/VDEW/ Informationen des Verband der Elektrizitätswirtschaft @ www.vdew.de

Chapter 11

/BINE2002a/ Fachinformationszentrum Karlsruhe, Gesellschaft für wissenschaftlich-technische Informationen mbH, Eggenstein-Leopoldshafen. BINE Informationsdienst (Hrsg): Latentwärmespeicher. 2002. BINE themeninfo IV/02

/BINE2002b/ Fachinformationszentrum Karlsruhe, Gesellschaft für wissenschaftlich-technische Informationen mbH, Eggenstein-Leopoldshafen. BINE Informationsdienst (Hrsg): Latentwärmespeicher in Baustoffen. 2002. BINE projektinfo 06/02

/Faulstich2005/ Faulstich, Stefan; Phasenwechselmaterialien zur Wärmespeicherung und Wärmedämmung; Diplomarbeit an der Universität Kassel; Dezember 2005

/Fisch2004/ Fisch, N.; Kühl, L.; Schnürer, H.; Wärmespeicher; TÜV-Verlag, Reihe „BINE-Informationenpakete“, 4. erweiterte und völlig überarbeitete Auflage 2004 ISBN 3-8249-0853-0

/Henning2002/ Henning, Dr. Hans-Martin; Wärmespeicher mit Phasenwechselmaterialien und thermochemische Systeme- Einsatz von thermischen Speichern in Gebäuden; Fraunhofer Institut für solare Energiesysteme; Vortrag im Rahmen des Workshop Dezentrale Energiespeicherung- Schlüssel zur wirtschaftlichen Entfaltung erneuerbarer Energien; Wuppertal, 8.April 2002

/ISE/ Informationen des Fraunhofer Instituts für Solare Energiesysteme @ www.ise.fhg.de
letzter Zugriff: 30.03.2007

/IWU/ IWU Institut für Wohnen und Umwelt, Darmstadt; Deutsche Gebäudetypologie, 2.Auflage, Dezember 2003, ISBN 3-932074-64-5

/Jahns2004/ Jahns, Dr. Ekkehard; Mikroverkapselte PCM: Herstellung, Eigenschaften, Anwendungsgebiete; BASF AG; Vortrag im Rahmen des ZAE-Symposiums 2004

/Lane1983/ Lane, G.A.; Solar Heat Storage: Latent Heat Materials, Volume I; CRC Press, Boca Raton, Florida, 1983; ISBN 0-8493-6585-6

/Lane1986/ Lane, G.A.; Solar Heat Storage: Latent Heat Materials, Volume II; CRC Press, Boca Raton, Florida, 1986; ISBN 0-8493-6586-4

/Lenzen2002/ Lenzen, Dipl.-Ing. Birgit; Entwicklung und Untersuchung eines latentwärmespeichernden Baumaterials zum Einsatz in transparent gedämmten Außenwänden; Fortschritt-Berichte VDI, Reihe 4 Bauingenieurwesen, Nr. 175, 2002; ISBN 3-18-317504-5

/Milow2001/ Milow, Bernhard (DLR); Stadermann, Gerd (FVS); Workshopband Wärmespeicherung; Workshop Wärmespeicherung, ForschungsVerbund Sonnenenergie, 2001

/Reenergie/ Informationen der Firma Reenergie @ www.reenergie-systems.com
letzter Zugriff: 30.03.2007

/Rubitherm/ Informationen der Firma Rubitherm @ www.rubitherm.com
letzter Zugriff: 30.03.2007

/Schmidt/ Marco Schmidt (BASF AG, Marketing Bauchemie), Latentwärmespeicher der BASF Anwendung und Wirtschaftlichkeit, @ www.basf.de

/Schossig2004/ Schossig, P.; Henning, H.M.; Haussmann, T.; Mikroverkapselte Phasenwechselmaterialien in Wandverbundsystemen; Fraunhofer Institut für solare Energiesysteme; Vortrag im Rahmen des ZAE-Symposiums 2004

/TEAP/ Informationen der Firma TEAP @ www.teaptvm.motor.ca.com.au/
letzter Zugriff: 30.03.2007 /ZAE/ Informationen des Zentrum für Angewandte Energietechnik, ZAE Bayern @ www.muc.zae-bayern.de/zae/specials/vortraege_2004.html letzter Zugriff: 26.07.2006

List of Tables

<i>Table 2-1: Principle of providing balancing power /Armbrüster 2005/</i>	7
<i>Table 3-1: Energy demand of pumps (Source: /BdEV 2002/)</i>	12
<i>Table 3-2: Hot water demand and specific useful heat: /VDI R2067/</i>	19
<i>Table 3-3: Market share of different hot water tanks /BdEv-b/</i>	21
<i>Table 3-4: Overview on the scenarios</i>	34
<i>Table 3-5: Inputs for the scenarios</i>	34
<i>Table 4-1: Efficiency</i>	49
<i>Table 4-2: Investment costs</i>	50
<i>Table 5-1: Efficiency ranges of chillers</i>	58
<i>Table 5-2: Influence of the heat source temperature on the chiller efficiency</i>	58
<i>Table 5-3: Chillers' main characteristics</i>	59
<i>Table 5-4. Energy demands – Winter</i>	62
<i>Table 5-5. Energy demands – Summer</i>	63
<i>Table 5-6. Energy demands - Spring/Autumn</i>	65
<i>Table 5-7: Gas microturbine characteristics</i>	66
<i>Table 5-8: Periods and temperatures considered in the study</i>	66
<i>Table 5-9: Energy demand for each month (Conventional installation)</i>	69
<i>Table 5-10: Total Energy demands for the whole year (Conventional installation)</i>	70
<i>Table 5-11: Monthly energy balance (Trigeneration system)</i>	74
<i>Table 5-12: Monthly natural gas demand (Trigeneration system)</i>	75
<i>Table 5-13: Yearly energy balance (Trigeneration system)</i>	76
<i>Table 5-14: Daily savings on electricity</i>	78
<i>Table 5-15: Comparison between both scenarios</i>	78
<i>Table 5-16: Comparison of the natural gas consumption of the system as a whole</i>	79
<i>Table 5-17. Access tariff components</i>	80
<i>Table 5-18. NPV analysis for the investment</i>	82
<i>Table 6-1. Heat pump principles and applications, and relocation relevance.</i>	88
<i>Table 6-2. Techno-economic datasheet for CHP-HP Cold Storage</i>	90
<i>Table 7-2: Characteristics of the five main types of fuel cells and potential areas of use. [1-4]. * 75% electricity efficiency can be achieved when combined with gas turbines.</i>	94
<i>Table 8-1: Power range in different applications of micro turbines /ASUE 2001/</i>	104
<i>Table 8-2: Development in the number and installed electric capacity of gas turbines /ASUE 2001/</i>	104
<i>Table 8-3: Prices of market available micro gas turbines (source /AEA OPET 2004/)</i>	109
<i>Table 8-4: comparison of micro turbines and Diesel motors</i>	109
<i>Table 9-1: Storage materials properties (average values), /Mod1975/</i>	112
<i>Table 9-2: Electric heater potential</i>	115
<i>Table 10-1: Electricity demand in German households /VDEW/</i>	117
<i>Table 10-2: Potential relocatable loads for a daily adjustment on the load profile /EuK/</i>	121

<i>Table 10-3: Control potential for a short adjustment on the imbalance /EuK/</i>	<i>121</i>
<i>Table 11-1: Requirements for Phase-Change-Materials (adopted from: /Lane1983/)</i>	<i>127</i>
<i>Table 11-2: Requirements for an encapsulation /Lane1986/.....</i>	<i>128</i>
<i>Table 11-3: Characteristics for some Phase-Change-Materials /Fisch2004/</i>	<i>132</i>

List of Figures

<i>Figure 2-1: Providing heat by electricity, storage and a further heating source</i>	<i>8</i>
<i>Figure 2-2: Yearly heat demand of buildings from old buildings to passive houses / Impulsprogramm 05/.....</i>	<i>9</i>
<i>Figure 3-1: Maximum allowed load /IS 2005/.....</i>	<i>11</i>
<i>Figure 3-2: Age structure of the pumps in Germany (Source: /Hirschberg 2002/)</i>	<i>13</i>
<i>Figure 3-3: Power of circulation pumps dependant on the outside temperature (adapted from: /Stadler 2005/)</i>	<i>13</i>
<i>Figure 3-4: Control potential of circulation pumps (30% insulated buildings, /Stadler 2005/..</i>	<i>14</i>
<i>Figure 3-5: Control potential of circulation pumps (100% insulated buildings) (adapted from: /Stadler 2005/)</i>	<i>15</i>
<i>Figure 3-6: Control potential of circulation pumps (All buildings insulated and 30% of the buildings with PCM) (adapted from: /Stadler 2005/)</i>	<i>16</i>
<i>Figure 3-7: Positive Control Potential of air-conditioning units (Source: /Stadler 2005/)</i>	<i>17</i>
<i>Figure 3-8: Negative Control Potential of air-conditioning units (Source: /Stadler 2005/)</i>	<i>17</i>
<i>Figure 3-9: Positive control potential of electric hot water stores, /Stadler 2005/</i>	<i>18</i>
<i>Figure 3-10: Future control potential of electric hot water stores -I</i>	<i>20</i>
<i>Figure 3-11: Future control potential of electric hot water stores -II.....</i>	<i>21</i>
<i>Figure 3-12: Annual heat load curves; standard (blue) and low energy houses (red) with heat production of micro gas turbines; assuming the same number of flats.....</i>	<i>24</i>
<i>Figure 3-13: Annual heat load curves standard (blue) and low energy houses (red) with gas turbine heat production and the same yearly heating energy demand</i>	<i>25</i>
<i>Figure 3-14: Assumed electric load profile for Germany.....</i>	<i>27</i>
<i>Figure 3-15: Wind profile at 25%.....</i>	<i>28</i>
<i>Figure 3-16: Heat demand profile</i>	<i>29</i>
<i>Figure 3-17: Schematic structure of the calculations</i>	<i>31</i>
<i>Figure 3-18: Profile of overproduction respectively remaining electric demand</i>	<i>32</i>
<i>Figure 3-19: Structure of the calculations for balancing through Demand Side Management..</i>	<i>33</i>
<i>Figure 3-20: Scenario I: Balanced with contribution of Demand Side Management.....</i>	<i>35</i>
<i>Figure 3-21: Scenario I: Balanced with contribution of Demand Side Management –II.....</i>	<i>35</i>
<i>Figure 3-22: Scenario I: Balanced with contribution of Demand Side Management and CHP.</i>	<i>36</i>
<i>Figure 3-23: Scenario I: Balanced with contribution of Demand Side Management and CHP –II</i>	<i>37</i>
<i>Figure 3-24: Scenario II: Balanced with contribution of Demand Side Management</i>	<i>38</i>
<i>Figure 3-25: Scenario II: Balanced with contribution of Demand Side Management and CHP</i>	<i>38</i>

<i>Figure 3-26: Scenario III: Balanced with contribution of Demand Side Management</i>	39
<i>Figure 3-27: Scenario III: Balanced with contribution of Demand Side Management and CHP</i>	40
<i>Figure 3-28: Scenario IV: Balanced with contribution of Demand Side Management</i>	41
<i>Figure 3-29: Scenario IV: Balanced with contribution of Demand Side Management and CHP</i>	41
<i>Figure 3-30: Effectiveness of balancing through Demand Side Management</i>	42
<i>Figure 3-31: Scenario I: Balanced with contribution of Demand Side Management and CHP; increased CHP capacity</i>	43
<i>Figure 4-1: Overall design of the system with Sankey diagram of the energy conversion</i>	46
<i>Figure 4-2: The 35 kW Stirling engine for solid fuel</i>	48
<i>Figure 4-3: 70 kW Stirling engine at boiler. Austia.[Ref. 3]</i>	48
<i>Figure 5-1: Trigeneration principle</i>	51
<i>Figure 5-2: Trigeneration with absorption chiller</i>	52
<i>Figure 5-3: Trigeneration with compression chiller</i>	52
<i>Figure 5-4: Scheme of a single-effect absorption machine</i>	53
<i>Figure 5-5: Scheme of a double-effect absorption machine</i>	54
<i>Figure 5-6: Scheme of an adsorption Chiller</i>	55
<i>Figure 5-7: Adsorption Chiller</i>	55
<i>Figure 5-8: Typical single-stage vapour compression refrigeration</i>	57
<i>Figure 5-9: Efficiency of a single stage ammonia absorption plant (100-600 kW)</i>	59
<i>Figure 5-10: Typical chiller start-up performance</i>	61
<i>Figure 5-11: Energy demands - Winter</i>	63
<i>Figure 5-12: Energy demands - Summer</i>	64
<i>Figure 5-13: Energy demands – Spring/Autumn</i>	65
<i>Figure 5-14: Hourly electricity demand for each month (Conventional installation)</i>	68
<i>Figure 5-15: Hourly air-conditioning electricity demand for each month (Conventional installation)</i>	68
<i>Figure 5-16: Hourly gas demand for each month (Conventional installation)</i>	68
<i>Figure 5-17: Daily electricity demand for each month (Conventional installation)</i>	69
<i>Figure 5-18: Daily natural gas demand for each month (Conventional installation)</i>	69
<i>Figure 5-19: Total electricity demand for the whole year (Conventional installation)</i>	70
<i>Figure 5-20: Electric demand of the air-conditioning system for the whole year (Conventional installation)</i>	70
<i>Figure 5-21: Natural gas demand for the whole year (Conventional installation)</i>	70
<i>Figure 5-22: Energy balance for one day of winter (Trigeneration system)</i>	72
<i>Figure 5-23: Energy balance for one day of spring/autumn (Trigeneration system)</i>	73
<i>Figure 5-24: Energy balance for one day of summer (Trigeneration system)</i>	73
<i>Figure 5-25: Monthly thermal balance (Trigeneration system)</i>	74
<i>Figure 5-26: Monthly electricity balance (Trigeneration system)</i>	75
<i>Figure 5-27: Monthly natural gas demand (Trigeneration system)</i>	76

<i>Figure 5-28: Amount of electricity imported from/exported to the market on a winter day.....</i>	<i>77</i>
<i>Figure 5-29: Amount of electricity imported from/exported to the market on a spring/autumn day.....</i>	<i>77</i>
<i>Figure 5-30: Amount of electricity imported form/exported to the market on a summer day</i>	<i>78</i>
<i>Figure 6-1: 2nd generation sustainable energy system introducing relocation and thermal storage for added operational flexibility.....</i>	<i>85</i>
<i>Figure 6-2: 1st generation CHP-HP Cold Storage concept for utilization of heat recovered from flue gasses, concurrent operation AND relocation possible (i.e. operation of heat pump unit or CHP unit).</i>	<i>89</i>
<i>Figure 6-3: 2nd generation CHP-HP Cold Storage concept for utilization of condensed flue gas AND optional low-temperature source, like ground-source, possibly also combining heat pump and electric boilers.</i>	<i>92</i>
<i>Figure 8-1: Section through an industrial gas turbine (airplane engine origin) /ASUE 2001/105</i>	
<i>Figure 8-2: Micro gas turbine in- and output.....</i>	<i>105</i>
<i>Figure 8-3: Micro gas turbine components</i>	<i>106</i>
<i>Figure 8-4: Process modification to enhance electric efficiency.....</i>	<i>107</i>
<i>Figure 8-5: Partial load of micro gas turbines with one and two shafts and variable speed /Diel/</i>	<i>107</i>
<i>Figure 8-6: Cogeneration with heat storage and an electricity price dominated economy (e.g. spot market).....</i>	<i>108</i>
<i>Figure 8-7: Specific investment costs for motors (blue line) micro turbines and othe cogeneration units /AEA OPET 2004/.....</i>	<i>110</i>
<i>Figure 9-1: STIEBEL ELTRON storage heater, view from outside. Typical modern type, /I/</i>	<i>111</i>
<i>Figure 9-2: Development of the installed capacity of electric heaters in Germany, /VDEW 98</i>	<i>115</i>
<i>Figure 10-1: Proportion of the different consumption structures on the electricity demand 2004 /VDEW/</i>	<i>116</i>
<i>Figure 10-2: Electricity demand in German households /VDEW/.....</i>	<i>117</i>
<i>Figure 10-3: Simulation results for an outside temperature of 0°C –I /Faulstich2005/.....</i>	<i>118</i>
<i>Figure 10-4: Simulation results for an outside temperature of 0°C –II /Faulstich2005/.....</i>	<i>119</i>
<i>Figure 10-5: Simulation results for an outside temperature of 0°C –III /Faulstich2005/</i>	<i>119</i>
<i>Figure 11-1: Temperature of water as a function of the specific enthalpy.....</i>	<i>123</i>
<i>Figure 11-2: Comparison between the needed energy amounts to heat up water</i>	<i>124</i>
<i>Figure 11-3: Types of Phase-Change-Materials /ZAE/</i>	<i>124</i>
<i>Figure 11-4: Sugary alcohols /Milow2001/.....</i>	<i>125</i>
<i>Figure 11-5: Paraffin waxes /Reenergie/.....</i>	<i>126</i>
<i>Figure 11-6: Melting temperature as a function of the amount of carbon-atoms /Reenergie/ .</i>	<i>126</i>
<i>Figure 11-7: Macro encapsulation /TEAP/.....</i>	<i>128</i>
<i>Figure 11-8: Micro encapsulation /ISE/.....</i>	<i>128</i>
<i>Figure 11-9: Possible Usages for PCM /Rubitherm/.....</i>	<i>129</i>
<i>Figure 11-10: Floor-elements /TEAP/</i>	<i>129</i>

<i>Figure 11-11: Latent hot water tank /Rubitherm/.....</i>	<i>130</i>
<i>Figure 11-12: Air-reservoir with PCM /Rubitherm/.....</i>	<i>130</i>
<i>Figure 11-13: Insulation with Phase-Change-Materials /ISE/.....</i>	<i>131</i>
<i>Figure 11-14: PCM as a passive building material /Rubitherm/.....</i>	<i>131</i>
<i>Figure 11-15: Comparison of latent and sensible heat /BINE2002a/.....</i>	<i>132</i>
<i>Figure 11-16: Latent energy /Rubitherm/.....</i>	<i>132</i>
<i>Figure 11-17: Simulation results for an outside temperature of 0°C /Faulstich2005/.....</i>	<i>133</i>
<i>Figure 11-18: Simulation results for an outside temperature of 0°C – II /Faulstich2005/.....</i>	<i>134</i>