

Scalable Spectrum Sharing Mechanism for Local Area Networks Deployment

Da Costa, Gustavo Wagner Oliveira; Cattoni, Andrea Fabio; Kovacs, Istvan Zsolt; Mogensen, Preben

Published in:
IEEE Transactions on Vehicular Technology

DOI (link to publication from Publisher):
[10.1109/TVT.2009.2039361](https://doi.org/10.1109/TVT.2009.2039361)

Publication date:
2010

Document Version
Early version, also known as pre-print

[Link to publication from Aalborg University](#)

Citation for published version (APA):
Da Costa, G. W. O., Cattoni, A. F., Kovacs, I. Z., & Mogensen, P. (2010). Scalable Spectrum Sharing Mechanism for Local Area Networks Deployment. *IEEE Transactions on Vehicular Technology*, 59(4), 1630-1645. <https://doi.org/10.1109/TVT.2009.2039361>

General rights

Copyright and moral rights for the publications made accessible in the public portal are retained by the authors and/or other copyright owners and it is a condition of accessing publications that users recognise and abide by the legal requirements associated with these rights.

- Users may download and print one copy of any publication from the public portal for the purpose of private study or research.
- You may not further distribute the material or use it for any profit-making activity or commercial gain
- You may freely distribute the URL identifying the publication in the public portal -

Take down policy

If you believe that this document breaches copyright please contact us at vbn@aub.aau.dk providing details, and we will remove access to the work immediately and investigate your claim.

Corresponding Author:

Gustavo W.O. da Costa - Radio Access Technology Group, Aalborg University.

E-mail: gc@es.aau.dk

Phone: +45 9940 8644

Fax: +45 9815 1583

A Scalable Spectrum Sharing Mechanism for Local Area Networks Deployment

Gustavo W.O. da Costa, *Student Member, IEEE*, Andrea F. Cattoni, *Member, IEEE*, István Z. Kovács, *Member, IEEE*, and Preben E. Mogensen, *Member, IEEE*

Abstract—The current wireless access networks are able to provide relatively low data rates when compared to wired access. In order to extend the access to high data rate services to wireless users, the International Telecommunication Union (ITU) established new requirements for future wireless communication technologies of up to 100Mbps in high mobility conditions and 1Gbps in low mobility. The low mobility goal can only be achieved through the use of highly optimized local area access networks, operating at low range and low transmission power. The efficient sharing of radio resources among local area cells will be very difficult to achieve with a traditional network planning/dimensioning approach due to their intrinsic uncoordinated deployment characteristic. Cognitive Radio (CR) based networking methodologies are considered as the most promising solutions for such radio resource sharing problems, enabling also unlicensed/open spectrum operations. In this paper, a Game Theory inspired scalable algorithm for Inter-Cell Dynamic Spectrum Access (IC-DSA) is introduced in order to enable distributed resources allocation in CR environments. The new CR-based cell is called here Cognitive Cell (C-cell), and it is the minimal entity which allocates a resource set. The simulation results demonstrate the effectiveness of the proposed spectrum sharing approach. This solution achieves a better overall performance in several load and interference scenarios in terms of both outage and average capacity when compared to fixed frequency reuses cases.

I. INTRODUCTION

The market availability of powerful and lightweight mobile devices [1] has led to a fast diffusion of mobile services for end users, and the trend is shifting from voice based services to multimedia content distribution. On one hand, this is a positive tendency driving a further increase of the wireless communication market. On the other hand, this shift poses great technology challenges due to a suboptimal support of such enriched services from the existing wireless communication technology side. As a matter of fact, current wireless access networks are able to support relatively low data rates with limited Quality of Service (QoS), when compared to wired access. Nowadays, voice traffic is still considered by users and operators as a high priority application for such networks, and high data rate Internet-based multimedia services cannot fully rely on guaranteed throughput and/or latency.

Copyright ©2009 IEEE. Personal use of this material is permitted. However, permission to use this material for any other purposes must be obtained from the IEEE by sending a request to pubs-permissions@ieee.org. Gustavo W.O. da Costa, Andrea F. Cattoni and Preben E. Mogensen are with the Radio Access Technology group, Department of Electronic Systems, Aalborg University, 9220 Aalborg, Denmark (email: {gc, afc, pm}@es.aau.dk). István Z. Kovács and Preben E. Mogensen are with the Development Center–Aalborg, Nokia Siemens Networks, 9220 Aalborg, Denmark (email: {istvan.kovacs, preben.mogensen}@nsn.com)

In order to extend the access to high data rate services to wireless users, the International Telecommunication Union (ITU) established new requirements for future wireless communication technologies. The global standard for International Mobile Telecommunication – Advanced (IMT-A) specifies very high peak data rate, up to 1Gbps in low mobility conditions and up to 100Mbps in high mobility conditions, for the 4th Generation of wireless systems [2].

While the high mobility target will be achieved by technologies already in deployment, such as 3GPP LTE and WiMax 802.16m, the low-mobility IMT-A goals can only be achieved through the use of low transmit power and high efficiency local area access networks taking the spatial frequency reuse one step further from existing cellular technology. Under this framework, the deployment of small picocells and femtocells is a promising methodology for increasing network capacity, and the standardization groups, such as 3GPP LTE-Advanced [3] and IEEE 802.16 WIMAX [4], are already provisioning for femto and pico base station deployment [5], which are seen as the direct competitors for the current WiFi access points [6], [7].

Unfortunately, the massive deployment of femtocells poses significant challenges on efficient radio resource sharing. Using the traditional network planning/dimensioning approach would require unacceptable costs and effort. Another access solution could be to exploit the benefits of the unlicensed bands or the open spectrum operations, which enable an easier access, from a regulatory point of view [8], to the spectrum resource. In this case, the presence of other technologies, *competing* for the spectrum access [9] can raise complicated co-existence issues.

Unlicensed wireless local area networks are usually deployed in a completely uncoordinated way, whose basic characteristics are a high density of Access Points (APs) in the same geographical area, and the position of the APs, within the area, randomly chosen by their owners. The APs can work in complete autonomy or be part of larger networks, such as a mobile operator network (see Figure 1). The APs dynamically share the same pool of resources and should achieve an efficient performance in terms of QoS and interference reduction [10].

Current communication standards do not always include such advanced QoS control mechanisms, and the service deployment requires costly dimensioning of the involved network and system. Hence, dynamic and scalable self-configuration of spectrum allocation is one of the most important, if not *the* most important, aspect for a successful

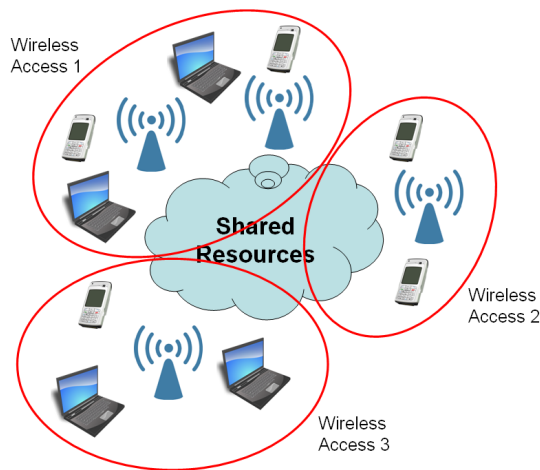

Figure 1. Shared Resources Scenario: multi access nodes/operators are sharing the same pool of resources. Maximization of QoS benefits and simultaneous reduction of cross-interferences should be achieved.

APs deployment.

We believe that technological and engineering challenges for this new class of local area AP devices can only be solved by looking into advanced flexible spectrum management/sharing algorithms based on Cognitive Radio (CR) [11] and Cognitive Network (CN) [12] concepts. This is the main motivation for investigating an Inter-Cell Dynamic Spectrum Allocation (IC-DSA) based on Cognitive cells (C-cell). A C-cell is an autonomous cell capable of configuring its spectrum allocation. The cognitive functions can be concentrated on the AP to limit the complexity of the served nodes, but anyway they assist the AP in the spectrum sensing task.

The goal of the proposed IC-DSA methodology is to provide an efficient trade-off between the performance of the planned and the unplanned networks. The methodology, inspired by Game Theory, is designed in order to have better flexibility compared to the contention/collision avoidance-based networks (e.g. WiFi [13], Bluetooth [14]) and to achieve similar or better results in terms of average cell throughput and guarantee of service requirements compared to the planned femto/pico base station based networks. The simulation results prove the efficiency of the proposed approach.

The paper is organized as follows: a brief review of the literature on spectrum and radio resource management mechanisms for similar cognitive radio deployment scenarios is presented in Section II. Section III describes the concept and the details of the proposed Game-based Resource Allocation in a Cognitive radio Environment (GRACE) spectrum sharing approach. Formal definitions and game theoretic analysis are presented in Section IV. In Section V the performance of the GRACE is evaluated with system level simulations. Section VI summarizes the conclusions and indicates future research directions.

II. EXISTING SOLUTIONS

Spectrum sharing and cognitive networking can be seen as an interference management across independent networks. The interference management is not a new problem at all. In cellular systems there are practical interference management or avoidance solutions such as Inter-Cell Interference Coordination (ICIC) [15] or Dynamic Frequency and Channel Allocation (DFCA) [16]. These solutions can, in principle, be extended to work across different networks using centralized architecture. However, they have strong inter-cell signaling requirements.

Some examples of centralized architecture for interference reduction in a cognitive radio environment are given in [17], [18]. Unfortunately centralized approaches are not viable, from a business point of view, when several and independent networks/operators have to share sensitive information among them. Furthermore, a high signaling overhead would be required in order to share the needed information among the networks, together with a powerful computing system to keep track of all the localized spectrum assignment region-wide or national-wide. On the contrary, to achieve full scalability in the massive deployment of IMT-A access, the signaling overhead across the networks should be minimized as much as possible. Wireless networks already have intra-network traffic overhead and the addition of an extra one is, therefore, not desirable. For all these reasons, a distributed/decentralized approach would be preferred.

The Carrier Sense Multiple Access with Collision Avoidance (CSMA/CA) protocol can be seen as a distributed solution which leads to time domain spectrum sharing. Unfortunately, as CSMA/CA is currently implemented [13], it is not scalable neither to high data rate nor to a large number of users [19]. In [20] the Authors proposed a cooperative multichannel MAC protocol solution which supports wireless devices of vastly different capabilities and applications with different requirements. A three phase asynchronous split MAC algorithm has been used to achieve spectral efficiency and fairness goals. The devices use a Request-To-Send/Clear-To-Send (RTS/CTS) exchange to make an agreement on the channel utilization. This mechanism can, in principle, be extrapolated for a scalable inter-cell cooperation, since the nodes (femtocell APs) do not have to be synchronized. However, the femtocell devices are operating under the control of the AP (resource allocation, timing, etc.), thus the RTS/CTS exchange between the APs becomes bandwidth demanding and potentially inefficient.

In the scenario depicted in Figure 1, each C-cell compete with other C-cells for spectrum access. The decision is made by each C-cell autonomously. Moreover, each C-cell can be assumed to work in its own interest. This is fundamentally different from the classical wireless networks, where each network element works to optimize the network as a whole. One of the most promising approaches to study the interaction amongst CRs is the application of Game-Theory (GT) [21]. Game-theoretic analysis can be used to characterize decentralized decision algorithms for cognitive networking.

In [22], a general framework for interference avoidance based on potential games is introduced. In some cases, potential

game based approaches can be implemented without communication such as in [23]. In [24], potential games are used to dynamically generate the frequency planning of a cellular network. One limitation of potential based approaches is the difficulty to accommodate system capacity in the utility functions.

Cooperative game theory, based on the *Nash Bargaining Solution* (NBS), is applied to the spectrum sharing problem in [25], [26]. The NBS allows maximizing system capacity directly, but there is a need of an underlying protocol for exchanging information among the players. Computational complexity and scalability can be a concern when using NBS-based approaches.

Another track of spectrum sharing algorithms based on GT is the auction-based secondary access to the spectrum. For instance, in [27] the primary users lease unused channels to the secondary users. However, the direct application of auction mechanisms poses significant challenges in terms of signaling and trusted entities, such as the spectrum brokers.

All the analyzed literature solutions present some weak points in terms of signaling overhead, flexibility, scalability or information to be shared between different mobile operators. This paper tries to overcome or, at least, minimize several of these limitations with a fully distributed competitive solution. No inter-AP signaling is required, thus leading to a better scalability. Channel measurement reports between UE and AP are required, but they are usually present in already existing communication standards, e.g. for channel equalization purposes. The efficiency and scalability of the proposed scheme is proved by simulation results.

III. A GAME-BASED RESOURCE ALLOCATION IN COGNITIVE RADIO ENVIRONMENT

This Section introduces the proposed IC-DSA solution, starting with the design criteria. Then, the global behavior of the algorithm is described through its cognitive cycle. Finally, the adopted utility function is motivated.

A. Design Criteria

The Game-based Resource Allocation in a Cognitive radio Environment (GRACE) is a dynamic spectrum sharing approach designed to meet the requirements summarized in table I. The last requirement in table I can be more precisely defined: the average capacity needs not to be optimal, since this usually implies a low degree of fairness. However, the average capacity should be comparable to the case where all C-cells use the entire bandwidth (reuse one). Otherwise, it would be questionable whether to apply dynamic spectrum sharing at first. This also means that the peak capacity has to be achievable when a C-cell is in total isolation. Therefore, the scheme cannot rely on hard limits on the spectrum usage. The aim of these requirements is to drive the development of an efficient and fair spectrum sharing framework with minimal complexity and signaling overhead needs. The wireless networks already have a lot of traffic overhead due to control channels, pilot channels and measurement feedbacks.

Table I
DESIGN CRITERIA FOR THE PROPOSED SPECTRUM SHARING SOLUTION.

Requirement	Reasoning
Each C-cell decides its spectrum allocation autonomously	Minimize complexity
There is no inter-cell signaling	Minimize overhead and complexity
Each link has to attain a minimal quality	Increase user experience and fairness
Large average capacity	Spectral Efficiency

The spectrum awareness should be built upon these existing signaling mechanisms, whenever possible, instead of adding the extra complexity of inter-cell signaling or centralized entities. As a matter of fact, the GRACE is built upon the same mechanisms needed for an efficient frequency domain scheduling: the characterization of the signal and of interference over the frequency channels. Therefore, the introduction of the GRACE into a traditional multi-carrier cellular network can be done with a *very low*, or even zero, extra overhead.

B. GRACE overview

The GRACE is an Inter-Cell Dynamic Spectrum Allocation (IC-DSA) mechanism, which operates in tight coordination/cooperation with the Radio Resource Management (RRM) and Medium Access Control (MAC), but on a coarser time granularity. The GRACE consists of an iterative optimization of a utility function defined in section III-C. Due to its iterative nature, the algorithm can be described through a cognitive cycle as depicted in Figure 2, where the interaction between the IC-DSA cognitive cycle (GRACE) and the RRM cycle is shown through a mirror representation [28].

In the present paper, a limited cognitivity is considered. The learning process of the parameters is performed by a set of rules which update the radio settings based on a random process named Better-Reply Dynamics (BRD). This type of cognitivity and its implications are described in [29]. The BRD process is further discussed in section IV-C. In the *Sensing* stage, the algorithm collects the power measurements about the radio environment. Part of the measurements is directly performed in the AP by the Physical Layer (PHY). The remaining part is performed by the User Equipments (UEs) and sent to the AP through proper MAC messages. The RRM also uses this information to assign the least interfered communication channel to the UEs. Hence RRM sends all the aggregated measurements to the IC-DSA for the global resource optimization. The *Sensing* stage also collects the QoS requirements through the Admission Control (AC) layer.

Then, the measurement vector is passed on to the *Analysis* stage where the specific interference metrics are computed. In particular, in the current development, the Signal-to-Interference-plus-Noise Ratio (SINR) and the Interference-to-Noise Ratio (INR) are used. The Uplink (UL) and Downlink

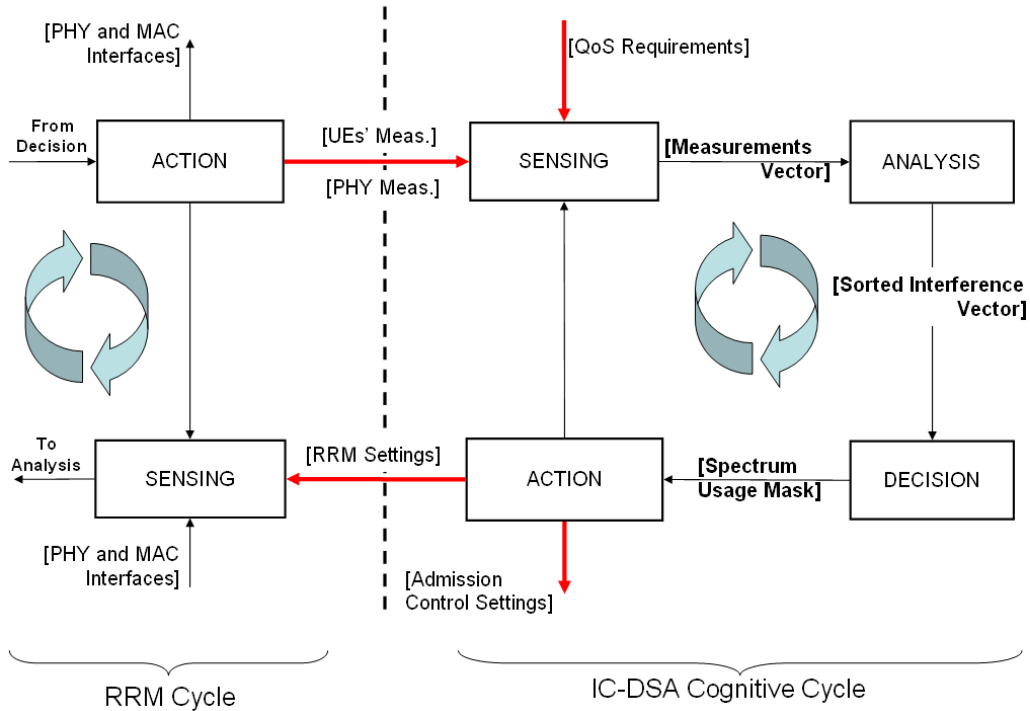

Figure 2. Cognitive Cycle Representation of GRACE

(DL) metrics are aggregated in order to have a full picture of the interference on the entire system bandwidth.

Finally, all the physical channels comprised in the system bandwidth are sorted according to the interference metric, in order to facilitate the evaluation of the proposed utility function. A channel is a sub-portion of the system bandwidth, chosen according to the capabilities/standardized design of the PHY. Afterwards, the sorted interference vector is sent to the following stage of the Cognitive Cycle. In the *Decision* stage each channel is evaluated according to the utility function, and after a global evaluation of the interference on all the channels the spectrum usage mask is generated. It is a synthetic representation of which channel will be available for the RRM, the AC and the MAC layers. The mask is passed on to the *Action* stage where the RRM and the AC settings are generated according to the specific Application Protocol Interface formats.

C. Utility function

One key aspect, while modeling a problem as a game, is the definition of the utility function. In game theory, the decision makers greedily optimize their utility functions. In this framework the decision makers are the C-cells. The major design challenge is here to make the local greedy optimization within a C-cell lead to an acceptably good global performance. The global optimization of the interference avoidance process can be achieved by using a greedy optimization, given a *fixed* traffic demand [24]. A global optimization is harder to get when the traffic demand is elastic, or when the optimization criteria is the capacity (see e.g. the price of anarchy in [30]). Therefore, a central question can be raised: what should be the utility function of a C-cell?

The efficiency of the traditional cellular networks relies on one basic principle: the spatial frequency reuse is planned to be as tight as possible, without degrading the SINR too much. Hence, when a dynamic spectrum allocation is introduced, the same principle shall drive the design of the utility function. On top of that, the spectrum which is not used in one C-cell has to be made available to its neighbors. We advocate that each C-cell needs to strive for:

- High bandwidth utilization.
- Avoiding transmission over heavily interfered channels.
- High spectral efficiency.

Clearly, there is a trade-off between the first two objectives, while the third one is connected to both of them. One major contribution of this paper is to define a utility function that can jointly handle these different aspects. This relation is further discussed later on in this section. First, we show that this quantity and the corresponding weighting function naturally arises on a simplified, but still relevant, topology. Then, the framework is extended for generalized topologies simply by allowing different weighting functions.

In Figure 3 a simplified two-cells scenario is depicted. Notice that the interference coupling is mutual, hence $I_{ij} = I_{ji}$. It is intuitive that in the case of fierce interference and mutual interaction the C-cells should use a solution where the channels are orthogonal, such as Frequency Division Multiplexing (FDM). If the interference is low enough, each of the C-cell should be able to reuse the whole spectrum. Formalizing the concept, an m -clique interference game is a situation where there are m C-cells with a relevant pairwise interference coupling; C-cells not belonging to the clique do not produce relevant interference to the C-cells on the clique. Such a game can be considered as the basic building block of more complex topologies. We want to determine, in a m -clique interference game, when a FDM solution can be considered

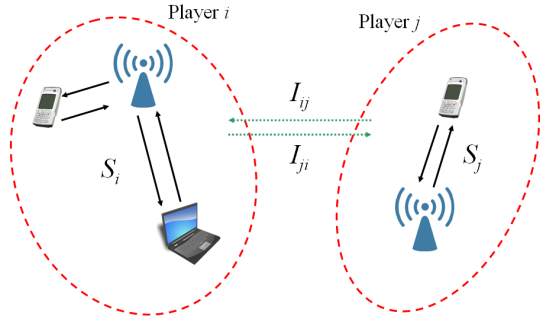

Figure 3. Each C-cell is a player. The interference coupling defines the interaction amongst players.

superior to the shared channel one. In order to identify such a situation, let us analyze under which circumstances the channel capacity of a single interference free channel becomes greater than the capacity of m interfered channels.

The concept is formalized by comparing the summed Shannon capacity in both cases. Whenever the following inequality holds, a FDM solution would surely be preferred over the full reuse:

$$B \log_2 \left(1 + \frac{\tilde{S}}{N} \right) > m B \log_2 \left(1 + \frac{\tilde{S}}{\tilde{I} + N} \right) \quad (1)$$

Where B is the bandwidth, \tilde{S} is the average received power, \tilde{I} is the average interference and N is the noise power in B . All these quantities are relative to a single channel. Note that at the left side of equation (1) no interference is present (FDM solution), while at the right side the interference is present (shared channels solution). By eliminating B , equation (1) can be rewritten as:

$$\log_2 \left(1 + \frac{\tilde{S}}{N} \right) > (m - 1) \log_2 \left(1 + \frac{\tilde{S}}{\tilde{I} + N} \right) \quad (2)$$

And the terms can be rearranged to:

$$\log_2 \left(1 + \frac{\tilde{S}}{N} \right) - \log_2 \left(1 + \frac{\tilde{S}}{\tilde{I} + N} \right) > (m - 1) \log_2 \left(1 + \frac{\tilde{S}}{\tilde{I} + N} \right) \quad (3)$$

By using the properties of the logarithmic function, the terms on the left can be written as:

$$\begin{aligned} \log_2 \left(1 + \frac{\tilde{S}}{N} \right) - \log_2 \left(1 + \frac{\tilde{S}}{\tilde{I} + N} \right) &= \\ \log_2 \left(\frac{\tilde{S} + N}{N} \right) - \log_2 \left(\frac{\tilde{S} + \tilde{I} + N}{\tilde{I} + N} \right) &= \\ \log_2 (\tilde{S} + N) - \log_2 (N) - \log_2 (\tilde{S} + \tilde{I} + N) + \log_2 (\tilde{I} + N) &= \\ \log_2 \left(\frac{\tilde{I} + N}{N} \right) - \log_2 \left(\frac{\tilde{S} + \tilde{I} + N}{\tilde{S} + N} \right) & \quad (4) \end{aligned}$$

By substituting equation (4) back into equation (3) we obtain:

$$\begin{aligned} \log_2 \left(\frac{\tilde{I} + N}{N} \right) - \log_2 \left(\frac{\tilde{S} + \tilde{I} + N}{\tilde{S} + N} \right) &> \\ (m - 1) \log_2 \left(1 + \frac{\tilde{S}}{\tilde{I} + N} \right) &\Leftrightarrow \\ (m - 1) \log_2 \left(1 + \frac{\tilde{S}}{\tilde{I} + N} \right) - \log_2 \left(1 + \frac{\tilde{I}}{N} \right) &< \\ -\log_2 \left(\frac{\tilde{S} + \tilde{I} + N}{\tilde{S} + N} \right) & \quad (5) \end{aligned}$$

Now, note that the right side of the equation is always lower than zero:

$$-\log_2 \left(\frac{\tilde{S} + \tilde{I} + N}{\tilde{S} + N} \right) = \log_2 \left(\frac{\tilde{S} + N}{\tilde{S} + \tilde{I} + N} \right) \leq \log_2 (1) \equiv 0 \quad (6)$$

Substituting (6) in (5) and dividing by $m - 1$ leads to this simple decision rule:

$$\log_2 \left(1 + \frac{\tilde{S}}{\tilde{I} + N} \right) - \frac{1}{(m - 1)} \log_2 \left(1 + \frac{\tilde{I}}{N} \right) \leq 0 \quad (7)$$

Whenever the relaxed condition (for simplicity) shown in equation (7) holds, a C-cell can safely determine that it prefers an FDM allocation over a full sharing one in an m -clique interference game. Let us assume that there are K channels in total and, in order to implement a channel reuse m , the C-cell allocates n_i channels. Being $m = K/n_i$:

$$\begin{aligned} \frac{1}{m - 1} &= \frac{1}{(K/n_i - 1)} = \frac{1}{(K - n_i)/n_i} = \\ \frac{n_i}{(K - n_i)} &= \frac{n_i/K}{(1 - n_i/K)} \quad (8) \end{aligned}$$

We define the weighting function as:

$$w(n_i/K) = \frac{n_i/K}{(1 - n_i/K)} \quad (9)$$

Where n_i/K is the percentage of used channels. In order to simplify the notation we further define:

$$C(x) = \log_2(1 + x) \quad (10)$$

Substituting equations (9) and (10) in equation (7) leads to:

$$C \left(\frac{\tilde{S}}{\tilde{I} + N} \right) - w \left(\frac{n_i}{K} \right) C \left(\frac{\tilde{I}}{N} \right) \leq 0 \quad (11)$$

The starting point in equation (1) was the comparison of two different situations: interfered and interference free transmission. Therefore, equation (11) locally identifies an undesirable situation: all the nodes transmit in all channels even though they could achieve a better performance by coordinating their transmissions. It would be much more beneficial for the whole network if this condition was never reached or, at least, a recovery from this state would be possible. Hence, consider the situation where each of the C-cells starts from an empty allocation and all of them are allowed to allocate one more channel in a round robin fashion until all K channels are allocated. If each C-cell evaluates equation (11) before adding a new channel, the undesired condition will never be reached. Therefore, the C-cells can iteratively increase the percentage of used channels (n_i/K) and *dynamically* find a proper FDM solution to any m -clique interference game.

This result, derived for a basic topology, motivates the definition of a general utility function that can be used also on more complex topologies:

$$\Pi_i = \sum_{k_i=1}^K s_i^{(k_i)} [C_i^{(k_i)} - w \left(\frac{k_i}{K} \right) \psi_i^{(k_i)}] \quad (12)$$

Where:

- k_i is a sorting of the channels in terms of increasing interference.
- $s_i^{(k_i)} = 1$ if the C-cell transmits at channel k_i and $s_i^{(k_i)} = 0$ if there is no transmission.

- $C_i^{(k_i)}$ is the channel capacity of channel k_i , and it represents the link level performance of the system.
- $\psi_i^{(k_i)}$ is a measure of spectrum congestion based on the relation between interference and noise in channel k_i . Equation (11) suggests that the same function used to map SINR into $C_i^{(k_i)}$ should be used to map I/N into $\psi_i^{(k_i)}$
- $w(k_i/K)$ is a weighting function. This function is a design parameter and it should be a non-decreasing function of k_i/K . Equation (9) gives one possible definition.

The function $\psi_i^{(k_i)}$ has an interesting interpretation: when transmitting over an interfered channel, part of the transmit power is spent to overcome interference instead of being used to transmit useful data rate. The function $\psi_i^{(k_i)}$ measures this quantity as the extra capacity that could be achieved on another (clean) channel.

The utility function defined in equation (12) can be maximized without analyzing all possible channel allocations, thanks to the channel sorting and the separability of the utility function per channel. In order to develop such a result, let us define the marginal utility as the extra utility provided by the addition of a single channel, i.e. setting $s_i^{(k_i)} = 1$ instead of $s_i^{(k_i)} = 0$:

$$\frac{\Delta \Pi_i}{\Delta k_i} = C_i^{(k_i)} - w\left(\frac{k_i}{K}\right) \psi_i^{(k_i)} \quad (13)$$

Maximizing the utility in equation (12) is equivalent to choosing all the channels that provide positive marginal utility according to equation (13). An analysis of equations (12) and (13) shows that the following properties can be achieved by a proper choice of $w(k_i/K)$:

- *High Bandwidth Utilization*: If the interference is low enough, the utility function approximates the channel capacity. This means that each C-cell will eagerly add more bandwidth if the interference is sufficiently low. Furthermore, each C-cell will opportunistically use the channels which are not allocated by its neighbors. Therefore, a high bandwidth utilization can be achieved.
- *Avoidance of heavily interfered channels*: The marginal utility provided by a highly interfered channel is negative. Therefore, a C-cell maximizing Π_i will not allocate highly interfered channels, otherwise this would reduce Π_i .
- *High spectral efficiency*: Selecting channels with a positive marginal utility, given by equation (13), is the same as comparing the spectral efficiency to a dynamic threshold. The higher the interference, the higher the threshold will be. Therefore, only the channels with a high spectral efficiency are chosen.

This utility function framework is very flexible, and a suitable definition is essential for the efficiency of the GRACE. In order to provide the best performance, the weighting function has to be adjusted for the desired deployment topology. Figure 4 shows an example of a sigmoidal weighting function, as the one used in the simulations presented in section V. The sigmoid is an s-shaped curve, and it provides an interesting weighting solution. The C-cells with a low number of channels will disregard the existence of interference, and they will add

more channels anyway, because the weight for $\psi_i^{(k_i)}$ will be close to zero. Moreover, the C-cells with a high number of channels will only add more if the interference is extremely low, since the weight for $\psi_i^{(k_i)}$ will be close to one. These two features enhance the capability of the GRACE on attaining both minimal outage performance and fairness. Naturally, it is also an option that $w(k_i/K)$ can be dynamically learned for a given topology.

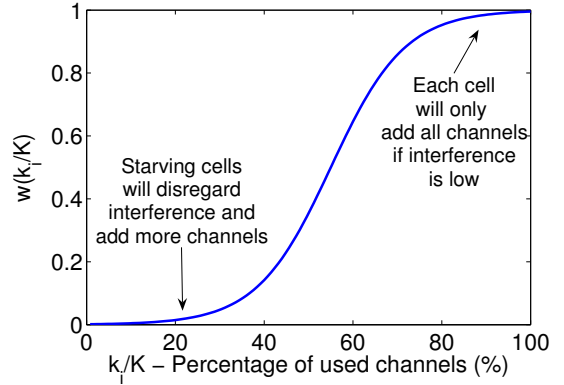

Figure 4. Example of sigmoid function, used as the weighting function on GRACE.

IV. GAME THEORETICAL MODELS AND ANALYSIS OF GRACE

In this Section the inter-cell spectrum sharing problem is analyzed in the light of Game Theory (GT). The game model is introduced in IV-A while in Section IV-B the existence of the equilibria and the general game behavior are analyzed. The dynamics and the strategy learning process are finally described in section IV-C.

A. Spectrum Sharing Game Model

A *game* is any situation where the outcome of the decision process of each decision maker is affected by the decisions made by other decision makers. Since the spectrum allocation performed by each CR affects the allocation of the other CRs in the environment through the means of interference, the cognitive networking can be modeled using games. Several auxiliary definitions and model assumptions are introduced first, then the definition of a *GRACE Spectrum Sharing Game* is given at the end of this section.

A *game in strategic form*[31] Γ is a tuple $\Gamma = (\mathcal{S}, (\Sigma_i)_{i \in \mathcal{S}}, (\Pi_i)_{i \in \mathcal{S}})$ where, $\mathcal{S} = \{1, \dots, |\mathcal{S}|\}$ is the set of players, Σ_i is the pure strategy space of player i , and it is defined for each player in \mathcal{S} . A strategy profile P is a particular selection of strategies for each player $P = \{s_1, \dots, s_{|\mathcal{S}|}\}$, where s_i is a strategy of player i . The utility function $\Pi_i : P \rightarrow \mathbb{R}$ is a real valued function determining the preference of each player over the set of all possible strategy profiles.

In our spectrum sharing game formulation a player corresponds to a C-cell. Hereafter, the terms C-cell and player

will be used interchangeably depending on the context. A particular player can have several communication links as illustrated in Figure (3). The nodes within a C-cell coordinate themselves to access the medium, providing the functions of duplexing and multiple access. The IC-DSA deals only with how the spectrum is shared amongst the C-cells, i.e. based on I_{ij} and I_{ji} (see Figure 3).

Let $\mathcal{K} = \{1, 2, \dots, K\}$ be the pool of dynamically shared channels. Each player has access to all channels in the pool. Furthermore, the channels are orthogonal, i.e. there is no cross-interference between two different channels. The strategy space of each player is the same and consists of all possible spectrum usage masks. Following the notation from equation (12), $s_i(k)$ is a binary variable: $s_i(k) = 1$ if the C-cell transmits on channel k and $s_i(k) = 0$ if there is no transmission. Hence, the spectrum usage mask \mathbf{s}_i can be written as the binary vector:

$$\mathbf{s}_i = [s_i^{(1)}, \dots, s_i^{(k)}, \dots, s_i^{(K)}] \quad (14)$$

The players only interact with each other by the means of interference. The total interference power perceived by player i , on channel k is:

$$I_i^{(k)} = \sum_{\substack{j=1 \\ j \neq i}}^{|\mathcal{S}|} s_j^{(k)} I_{ji}^{(k)} \quad (15)$$

Where $I_{ji}^{(k)}$ is the incoming interference from player j to player i on channel k . Equation (15) tells that there is no incoming interference from player j on channel k if that player does not transmit on channel k . Similarly, the received signal power of player i is represented by $S_i^{(k)}$ and it is only available if that channel is allocated:

$$S_i^{(k)} = \begin{cases} \tilde{S}_i^{(k)}, & \text{if } s_i(k) = 1 \\ 0, & \text{otherwise.} \end{cases} \quad (16)$$

It is assumed that each player is capable of reducing all relevant sensing information¹ to two values per channel: $I_i^{(k)}$ and $S_i^{(k)}$. A simple implementation of such reduction is the use of the sensing information about the link with the worst SINR.

While k is the global channel index, common to all players, the utility function is defined using a player-specific ordering k_i based on the increasing level of interference:

$$q_i(k) > q_i(k^*) \Leftrightarrow I_i^{(k)} > I_i^{(k^*)} \\ k_i = q_i(k), k_i \in \mathcal{K} \quad (17)$$

The quantity q_i is defined as a bijective function from \mathcal{K} to \mathcal{K} , corresponding to a channel sorting according to the increased level of the worst interference case. Since this is a bijective function, the global channel indexing can be obtained through the inverse function $k = q_i^{-1}(k_i)$. Hereafter, this conversion is implicitly considered where needed. For example:

$$S_i^{(k_i)} \equiv S_i^{(q_i^{-1}(k_i))} \quad (18)$$

Therefore, the utility function from equation (12) can be explicitly put in terms of $S_i^{(k_i)}$ and $I_i^{(k_i)}$:

$$\Pi_i = \sum_{k_i=1}^K s_i^{(k_i)} \left[C \left(\frac{S_i^{(k_i)}}{I_i^{(k_i)} + N_i^{(k_i)}} \right) - w \left(\frac{k_i}{K} \right) C \left(\frac{I_i^{(k_i)}}{N_i^{(k_i)}} \right) \right] \quad (19)$$

¹Although it is out of scope of this paper to investigate handover procedures, once a handover is initiated, a special treatment is needed to determine if the corresponding UE measurements should be used or not on the spectrum analysis. Otherwise, the spectrum allocation generated by the GRACE could be biased to protect a UE that will soon not be served by that cell.

Where, $N_i^{(k_i)}$ is the noise power, and $C(x)$ is the link level mapping from SINR to throughput.

The GRACE spectrum sharing game Γ is defined as tuple $(\mathcal{S}, \mathcal{K}, (\Sigma_i)_{i \in \mathcal{S}}, I_{ji}^{(k)}, S_i^{(k)}, (\Pi_i)_{i \in \mathcal{S}})$ where, $(\Sigma_i)_{i \in \mathcal{S}}$ is the set of strategy spaces corresponding to all possible combinations of channel allocations,

$I_{ji}^{(k)}$ is the interference coupling on channel k for the ordered pair of players i, j ,

$S_i^{(k)}$ is the signal received by player i on channel k ,

Π_i is the utility function given by equation (19).

B. Game Statics

In GT it is common to denote the set of strategies of all the players but i as s_{-i} , i.e., $s_{-i} = \{s_1, \dots, s_{i-1}, s_{i+1}, \dots, s_{|\mathcal{S}|}\}$. A *Nash Equilibrium* (NE) is a strategy profile where each strategy is the best response to the strategies of the other players. Formally, a NE is a strategy profile where the following condition holds for every i :

$$\Pi_i(s_i, s_{-i}) \geq \Pi_i(\tilde{s}_i, s_{-i}) \text{ for } \forall \tilde{s}_i \quad (20)$$

In a NE, no player has incentives for taking unilateral deviations. Pure Strategy Nash Equilibria (PSNE) need not to exist. However, a mixed strategy Nash Equilibrium always exists for the finite strategic-form games [31]. A *mixed strategy* is a probability distribution over the pure strategies.

The best reply correspondence b_i of player i is a mapping from the opponents strategies to a optimal strategy for player i . A best reply selection is a particular single valued implementation of the best reply correspondence. In the GRACE game, the best reply selection can be implemented by selecting all the channels with a positive marginal utility, as given by equation (13)

From a particular player's point of view, a GRACE spectrum sharing game with more than two players has the same structure of a two-player game. Player i utility depends only on the summed incoming interference, as given by equation (15), and not on which player is generating the interference. Therefore, from the player i point of view, replying to a single opponent or to several ones is exactly the same thing.

In a two player GRACE game, a best reply selection can be determined directly by the number of allocated channels, n_1 and n_2 , since the two players will minimize the allocation overlap to each other. An example, with $K = 125$ channels, is illustrated in Figure 5. Note that in this example the function $b_1(n_2)$ has the independent variable n_2 on the y -axis while the dependent variable b_1 on the x -axis. The NE is explicitly marked, and it corresponds to a strategy profile in which the joint best reply selection of both the players reaches a fixed point. Furthermore, the best reply $b_2(n_1)$ is downward slopping. For example, if player 1 does not have much traffic and allocates only 10 channels, the best reply for player 2 is to allocate the remaining 115 channels. If player 2 starts increasing the number of allocated channels, player 1 will be motivated to reduce its own allocation. This is a characteristic of the *submodular games*. The analysis, presented later on in this section, shows that a GRACE game is indeed a submodular game under some conditions.

Another interesting characteristic of the GRACE utility function is that it creates a plateau on the best reply selection.

This is an important stability result: for a large portion of the strategy profiles one player is indifferent to the strategic changes of the other player. The plateau level depends on the level of the perceived interference. If the interference coupling is very strong, several PSNE may exist. Intuitively, the symmetric one is preferred. This is further discussed in section IV-C.

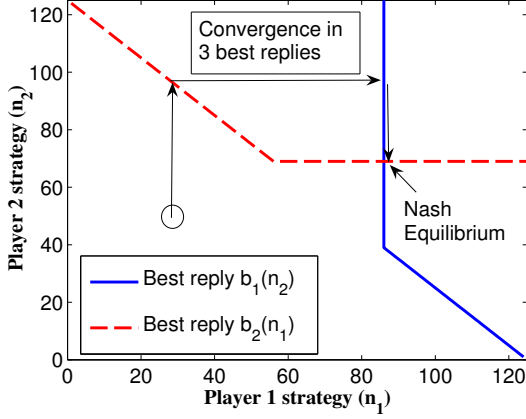

Figure 5. The best reply correspondence in a two player GRACE game with fixed power per channel. Note that for $b_1(n_2)$ the independent variable is on the y -axis and the dependent variable is on the x -axis. From any initial point the convergence to a NE can be achieved with at most three best replies.

Before formalizing the concept of a submodular game, a few additional definitions will be useful. Let x and y be k -dimensional vectors belonging to \mathbb{R}^k . The *meet*, $x \wedge y$, and the *join*, $x \vee y$, operators are defined as:

$$x \wedge y \equiv \{\min(x_1, y_1), \dots, \min(x_k, y_k)\} \quad (21)$$

$$x \vee y \equiv \{\max(x_1, y_1), \dots, \max(x_k, y_k)\} \quad (22)$$

Moreover, Σ is a *sublattice* of \mathbb{R}^m if $x \in \Sigma$ and $y \in \Sigma$ imply that $x \wedge y \in \Sigma$ and $x \vee y \in \Sigma$. A real valued multi-variable function $\Pi(x)$ is *supermodular* if:

$$\Pi(x \wedge y) + \Pi(x \vee y) \geq \Pi(x) + \Pi(y) \quad (23)$$

The utility Π_i has *decreasing differences* in (s_i, s_{-i}) if:

$$\Pi_i(s_i, s_{-i}) - \Pi_i(\tilde{s}_i, s_{-i}) \leq \Pi_i(s_i, \tilde{s}_{-i}) - \Pi_i(\tilde{s}_i, \tilde{s}_{-i}) \quad (24)$$

when $s_i \geq \tilde{s}_i$ and $s_{-i} \geq \tilde{s}_{-i}$. Here, $x \geq y$ means that $x_k \geq y_k, \forall k$. If $x_k > y_k$ for some index k but $x_l < y_l$ for some other index l , then the vectors x and y are not comparable.

The Equation (24) can be interpreted as follows: when the externality s_{-i} is increased, the marginal profit is reduced or maintained. In other words, an increase in s_{-i} cannot make player i become more attracted to increase s_i .

A *submodular game* is a game where the following conditions stand for each player i :

- Σ_i is a sublattice of \mathbb{R}^{m_i} . Note that the dimension m_i of Σ_i can be player specific.
- Π_i has decreasing differences in (s_i, s_{-i}) .
- Π_i is supermodular in s_i .

Proposition 1: Σ_i is a sublattice of \mathbb{R}^K .

Proof: A strategy is defined in equation (14) as a binary vector $s_i \in \mathbb{R}^K$. The meet operation defined in equation (21) can be implemented for a binary vector as a bitwise logical

AND. Similarly, the join operation is equivalent to a bitwise logical OR. Therefore, it follows that if $s_i \in \Sigma_i$ and $\tilde{s}_i \in \Sigma_i$, then $(s_i \wedge \tilde{s}_i) \in \Sigma_i$ and $(s_i \vee \tilde{s}_i) \in \Sigma_i$ since $(s_i \text{ AND } \tilde{s}_i) \in \Sigma_i$ and $(s_i \text{ OR } \tilde{s}_i) \in \Sigma_i$. Consequently, Σ_i satisfies the definition of sublattice of \mathbb{R}^K . ■

Proposition 2: Π_i is supermodular in s_i .

Proof: From the definition in Equation (23), this condition requires that:

$$\Pi_i(s_i \wedge \tilde{s}_i) + \Pi_i(s_i \vee \tilde{s}_i) \geq \Pi_i(s_i) + \Pi_i(\tilde{s}_i) \quad (25)$$

for any pair of strategies \tilde{s}_i and s_i . As noted in proposition 1, this is equivalent to:

$$\Pi_i(s_i \text{ AND } \tilde{s}_i) + \Pi_i(s_i \text{ OR } \tilde{s}_i) \geq \Pi_i(s_i) + \Pi_i(\tilde{s}_i) \quad (26)$$

Using equations (12) and (13), the right side of equation (26) can be written as:

$$\Pi_i(s_i) + \Pi_i(\tilde{s}_i) = \sum_{k_i=1}^K s_i^{(k_i)} \frac{\Delta \Pi_i}{\Delta k_i} + \sum_{k_i=1}^K \tilde{s}_i^{(k_i)} \frac{\Delta \Pi_i}{\Delta k_i} \quad (27)$$

The terms of the first sum for which $s_i^{(k_i)} = 1$ but $\tilde{s}_i^{(k_i)} = 0$ can be moved to the second sum and set $s_i^{(k_i)} = 0$ in the first sum. After this change, the positive terms in the first sum will consist of the positive terms in both \tilde{s}_i and s_i , while the second sum will consist of the positive terms which are \tilde{s}_i , s_i or both of them. Then, by definition:

$$\Pi_i(s_i) + \Pi_i(\tilde{s}_i) = \Pi_i(s_i \text{ AND } \tilde{s}_i) + \Pi_i(s_i \text{ OR } \tilde{s}_i) \quad (28)$$

Proposition 3: The quantity Π_i , as defined in the GRACE, has decreasing differences in (s_i, s_{-i}) .

Proof: Equation (24) compares the quantity $\Pi_i(s_i, t) - \Pi_i(\tilde{s}_i, t)$ for $t = s_{-i}, \tilde{s}_{-i}$. Using equations (12) and (13), this quantity can be written as:

$$\begin{aligned} \Pi_i(s_i, t) - \Pi_i(\tilde{s}_i, t) = \\ \sum_{k_i=1}^K s_i^{(k_i)} \frac{\Delta \Pi_i}{\Delta k_i}(s_i, t) - \sum_{k_i=1}^K \tilde{s}_i^{(k_i)} \frac{\Delta \Pi_i}{\Delta k_i}(\tilde{s}_i, t) \end{aligned} \quad (29)$$

Recall that the strategies are binary vectors of size K . Therefore, $s_i \geq \tilde{s}_i$ implies that $s_i^{(k)} = 1$, whenever $\tilde{s}_i^{(k)} = 1$. Otherwise the vectors would not be comparable. In other words, the allocation \tilde{s}_i is necessarily contained in s_i . Therefore, all the terms appear in both sums in equation (29), except the channels which are in s_i but not in \tilde{s}_i . Let κ represent such a set, with reference to the index k_i .

Then, equation (29) can be rewritten as:

$$\Pi_i(s_i, t) - \Pi_i(\tilde{s}_i, t) = \sum_{k_i \in \kappa} s_i^{(k_i)} \frac{\Delta \Pi_i}{\Delta k_i}(s_i, t) \quad (30)$$

Similarly, the condition $s_{-i} \geq \tilde{s}_{-i}$ only holds if $s_{-i}^{(k)} = 1$, whenever $\tilde{s}_{-i}^{(k)} = 1$. This last condition implies $I_i^{(k)}(s_{-i}^{(k)}) = I_i^{(k)}(\tilde{s}_{-i}^{(k)})$ if $s_j^{(k)} = \tilde{s}_j^{(k)}$, for all players $j \neq i$ and $I_i^{(k)}(s_{-i}^{(k)}) > I_i^{(k)}(\tilde{s}_{-i}^{(k)})$ if $s_j^{(k)} \neq \tilde{s}_j^{(k)}$, for any player $j \neq i$. These relations can be seen from equation (15). Therefore, the interference to player i can only increase or be maintained when the opponents move from \tilde{s}_{-i} to s_{-i} .

Note that the indexing k_i may be different in the two situations compared in (24), since the interference affects the ranking according to equation (17). Let us denote $k_i = q_i(k)$ as the indexing when the opponents strategy profile is s_{-i} and

$\tilde{k}_i = \tilde{q}_i(k)$ when their strategy is given by \tilde{s}_{-i} . Furthermore, let $\tilde{\kappa}$ represent the set of channels s_i but not in \tilde{s}_i , with reference to the index \tilde{k}_i . According to equation (29), κ and $\tilde{\kappa}$ have the same number of elements in the sum. Because of that, the n -th element of κ will have an indexing k_i which is no smaller than the index \tilde{k}_i of n -th element $\tilde{\kappa}$. This is relevant because the elements of κ and $\tilde{\kappa}$ can be paired such that the weighting function relation can be written as $w(k_i/K) \geq w(\tilde{k}_i/K)$ for $k_i \in \kappa$ and $\tilde{k}_i \in \tilde{\kappa}$. Summarizing, it is possible to pair the elements of κ and $\tilde{\kappa}$ such that the following conditions hold for all of them:

- $k_i \geq \tilde{k}_i$
- $w(k_i/K) \geq w(\tilde{k}_i/K)$
- $I_i^{(k_i)}(s_{-i}^{(k_i)}) \geq I_i^{(\tilde{k}_i)}(\tilde{s}_{-i}^{(\tilde{k}_i)})$
- $\psi_i^{(k_i)} \geq \psi_i^{(\tilde{k}_i)}$

If we further impose, $C_i^{(k_i)} \leq C_i^{(\tilde{k}_i)}$, then the following condition necessarily holds for the marginal utilities, given by equation (13):

$$\frac{\Delta \Pi_i}{\Delta k_i}(s_i, s_{-i}) \leq \frac{\Delta \Pi_i}{\Delta \tilde{k}_i}(s_i, \tilde{s}_{-i}) \quad (31)$$

Then, substituting (31) into equation (30):

$$\begin{aligned} \Pi_i(s_i, s_{-i}) - \Pi_i(\tilde{s}_i, s_{-i}) = \\ \sum_{k_i \in \kappa} s_i^{(k_i)} \frac{\Delta \Pi_i}{\Delta k_i}(s_i, s_{-i}) \leq \sum_{\tilde{k}_i \in \tilde{\kappa}} s_i^{(\tilde{k}_i)} \frac{\Delta \Pi_i}{\Delta \tilde{k}_i}(s_i, \tilde{s}_{-i}) \end{aligned} \quad (32)$$

Then, the equation (30) can be used at the right side of equation (32) to establish the condition of equation (24) which is the definition of decreasing differences:

$$\Pi_i(s_i, s_{-i}) - \Pi_i(\tilde{s}_i, s_{-i}) \leq \Pi_i(s_i, \tilde{s}_{-i}) - \Pi_i(\tilde{s}_i, \tilde{s}_{-i}) \quad (33)$$

Theorem 1: A GRACE spectrum sharing game is a submodular game. ■

Proof: It follows directly from the definition of a submodular game, Proposition 3 and Proposition 2. ■

Corollary 1: A PSNE always exists in a two-player GRACE spectrum sharing game.

Proof: A *supermodular game* can be defined along the same lines as a submodular game, by replacing decreasing differences with increasing differences [31], i.e., if Equation (24) is true when the inequality signal is reversed.

A two-player submodular game can be turned into a supermodular game by reversing the action vector of one of the players [32]. In the case of a GRACE spectrum sharing game this modification can be done as follows: one of the players decides which channels to allocate, and the other decides which channels *not* to allocate.

Supermodular games always has at least one PSNE. Therefore, a two-player GRACE spectrum sharing game always have a PSNE. ■

In our simulated cases, the convergence to a PSNE was always reached, independently of the number of players, as discussed in section V-B. However, it is still an open issue in the game theory literature what are the most general conditions that can guarantee the PSNE existence in submodular games with more than two players. Refer to [33] and references therein for the latest advances in the topic.

C. Game Dynamics

The game dynamics can be seen as a learning process, in which the players attempt to discover how to play a NE after a few game repetitions. In the particular case of a GRACE spectrum sharing game, the players are interested in learning, through the past sensed information, the equilibrium for the spectrum allocation.

Figure 5 shows one example where the convergence to PSNE can be achieved in a two-player game with only three steps using the best-reply dynamics, i.e. if the players iteratively play the best responses.

Despite the nomenclature, there are several situations where the *better-reply dynamics* (BRD) are preferred over best-reply dynamics [29]. The BRD is a random process in which, at each stage of a repeated game, one player $i \in \mathcal{S}$ is selected to revise its current strategy (the status-quo strategy). The selected player will sample other strategies. The sampled strategy will be adopted if and only if it is a *better-reply*, i.e. if its utility is higher than the one provided by the status-quo strategy. Otherwise, the status-quo strategy is kept for the next stage.

Supermodular games have the *weak Finite Improvement Property* (weak-FIP), which guarantees the convergence of the game to a PSNE. Therefore, any two-player GRACE spectrum sharing game will converge under BRD, because it is a supermodular game (see Corollary 1) as well. Whenever the BRD converges, the convergence point is a PSNE [29]. Therefore, the convergence to a PSNE can be empirically verified by using the BRD.

We then propose two modifications to the BRD that, in our view, are more adequate to the spectrum sharing problem:

- 1) Each player decides autonomously to revise its status-quo strategy with probability ϵ , equal for all players. Referring to the cognitive cycle in Figure 2, a C-cell starts the analysis process only when a revision of the status-quo strategy is decided. This modification, which is also used in [24], avoids any coordination amongst the players enhancing the scalability of algorithm itself.
- 2) A C-cell can only change its allocation by a maximum of Δn_{MAX} channels at a time. Referring to the cognitive cycle in Figure 2, the Decision process is the one affected by this modification which smooths the changes in the spectrum allocation, and it serves a number of purposes. First, the sensing information becomes more stable because the spectrum allocation varies less often. Secondly, the other cognitive processes, such as the RRM and the Admission Control, can more easily adapt to small changes in the spectrum allocation rather than large ones. Furthermore, a C-cell will wait for the adaptation of the other C-cells before making drastic changes in its own allocation. This is very important for the presence of multiple PSNE, where the convergence toward a symmetric equilibrium is preferred. Last, but not least, this modification should provide smoother transitions in the transmission data rate provided to the upper layers. Naturally, this modification comes at the price of a reduced spectrum agility. Some of it can be recovered by setting high values of the status-quo

revision probability (ϵ).

This modified BRD will also converge in games with weak-FIP property, since there is a positive probability that the players will follow exactly the same improvement path as in BRD.

One implementation note: from Equation (13) it is possible to state that the better replies can be formed from the current allocation by adding the channels which have a positive marginal utility while removing those which have a negative marginal utility. Therefore, the modified better-reply dynamics can have a simple implementation, where only a few channels have to be evaluated at a time instead of analyzing all possible channel allocations.

V. SIMULATED SOLUTION AND RESULTS

In this section, the system-level simulation results are presented. The Uplink (UL) results are omitted in most of the cases, because they are very similar to the Downlink (DL) results in terms of relative gains. All the throughput results are normalized by dividing the throughput by the maximum theoretical capacity of the system. Hence, a *normalized throughput* of 100% means that the theoretical capacity is achieved (transmission over the whole bandwidth at the maximum spectral efficiency of the system).

A. Simulation Model and Parameters

A system level simulator was used to evaluate the performance of the GRACE algorithm. Let us now introduce the system level model, assuming an infra-structured OFDMA (Orthogonal Frequency Division Multiplexing) system, using a single contiguous bandwidth of 100 MHz. The duplexing is provided by a TDD (Time-Division Duplexing) operation mode. The UL/DL switching point is fixed for simplicity: 50% of the frame is used for the UL and the remaining 50% for the DL.

The 100 MHz bandwidth is subdivided into $K = 125$ channels. There is no pre-reservation of the resources and, therefore, all the 125 channels are dynamically shared.

The results are based on 500 randomly generated simulation scenarios. The positions of the houses and the sidewalks are fixed, but the position of both the APs and the UEs are randomly chosen within each house. Therefore, the simulation scenario models an uncoordinated deployment. In Figure 6, one scenario example is depicted. It consists of tightly packed houses, constructed in blocks of four houses. Each house has its own C-Cell operating autonomously. Unless otherwise stated, the results correspond to a 16 C-cells scenario. A closed subscriber group approach is considered and, therefore, each UE is connected to the corresponding AP even if the received signal strength (RSS) from another AP is higher and no handovers are possible.

The simulator uses a semi-static approach, where positions are fixed during a simulation drop while the time is varied, and correlated results of the repeated application of the GRACE are thus available. In each run 60 iterations (game stages) are simulated. The results that compare the GRACE to the other approaches are taken from the last iteration. The simulations

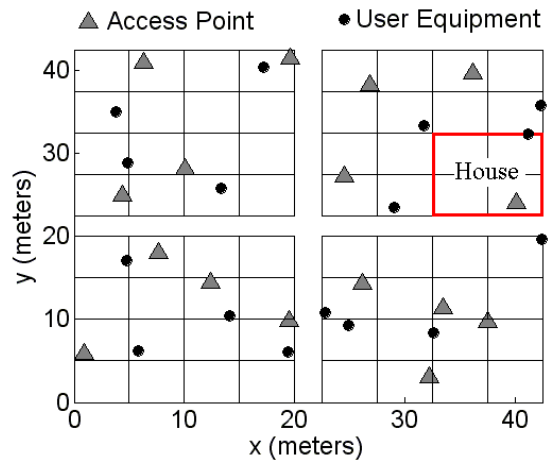

Figure 6. Example of randomly generated scenario with 16 access points. Note that both AP and UE positions are randomized within a house.

of GRACE algorithm are initialized with a *Reuse One* (R1) spectrum use scheme as a starting point.

In order to capture the effects of varying interference patterns, not all the APs are always active at the same time. In the results, the activity factor is defined as the probability of having network usage within a particular network (AP plus UE).

Further simulation parameters are summarized in Table II.

Table II
PARAMETERS FOR SYSTEM-LEVEL SIMULATIONS

System Model		
Spectrum allocation	100 MHz centered at 3.5 GHz	
AP parameters	Max. TX power	24 dBm
	Antenna system	Omni (3dBi)
UE parameters	Max. TX power	24 dBm
	Antenna system	Omni (0dBi)
Access scheme	OFDMA	
Duplexing scheme	TDD	
Frequency resources	125	
Link Level Model[34]		
3G-LTE approximation	SINR efficiency	(0.56,0.52) in (DL,UL)
	Bandwidth efficiency	(2.2,3.4) in (DL,UL)
Scenario Model		
Home Scenario	Room size	5m x 5m
	Sidewalk width	2.5 m
	AP position	50 random layouts
	UE position	10 drops per layout
Propagation Model - Winner II A1 Indoor[35]		
Minimum coupling loss	45 dB	
Home Scenario	Internal walls	5 dB attenuation
	External walls	10 dB attenuation
	Shadow Fading	3-8 dB deviation
Traffic Model		
Data generation	Full buffer (There is always data for transmission)	
GRACE parameters		
Weighting function	$w = 1 - \frac{1}{1 + \exp(12*(x - 0.55))}$ (Figure 4)	
Status-quo revision probability	$\epsilon = 50\%$ (Section IV-C)	
Maximal allocation change	$\Delta n_{MAX} = 10$ (Section IV-C)	

B. Convergence Study

Two key aspects of a spectrum sharing mechanism designed for an uncoordinated deployment are scalability and convergence. The target is to evaluate the scalability of the algorithm when the size of the problem is increased, i.e. scenarios with more C-cells. The convergence has been addressed for four setups:

- Two C-cells, forming a 2x1 grid of houses.
- Four C-cells, forming a 2x2 grid of houses.
- 16 C-cells, forming a 4x4 grid of houses.
- 64 C-cells, forming a 8x8 grid of houses.

For each of these setups the convergence results were averaged over 640 samples from randomly generated scenarios. They are presented in the form of an *allocation error*, defined as the difference between the number of channels currently allocated and the number of channels allocated in the NE. Therefore, the allocation error is a metric that measures how far a particular C-cell is from the equilibrium allocation.

Figure 7 shows the evolution of the worst allocation error. It is possible to observe that there is some dependency of the worst case of the convergence behavior from the number of C-cells, but the time required for converging does not grow as fast as the problem size. In the worst case scenario with 64 C-cells, the PSNE is only achieved after 58 iterations, but even in this case, most of the convergences are achieved within 30 iterations.

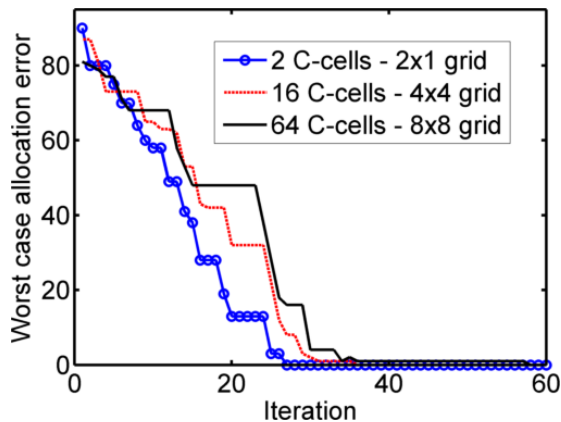

Figure 7. Evolution of worst case allocation error, amongst 640 C-cells. This is indicative of the worst-case convergence behavior of GRACE.

Figure 8 shows the evolution of the average allocation error. The average convergence behavior is very interesting. In the simulated scenarios, the average convergence time for the 64 C-cells scenarios is the same as for the 4 C-cells scenarios. Therefore, the GRACE scales very well with the problem size, and it is suitable as a spectrum sharing solution in massive uncoordinated deployments.

We remark that the convergence behavior is here a consequence of the limitation of the maximum allowed allocation change $\Delta n_{MAX} = 10$ (Section IV-C). Depending on the scenario, the convergence can be made faster if no limitations are imposed on how fast the C-cells can adapt. Furthermore, as discussed in section IV-C, the convergence results of this

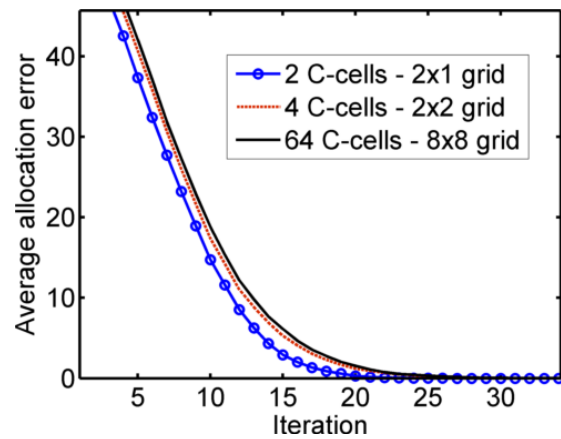

Figure 8. Evolution of the average allocation error, amongst 640 C-cells. This is indicative of the average convergence behavior of GRACE.

section prove that the PSNE exists for all the studied scenarios, because the convergence point of the BRD must be a PSNE.

C. Analysis of the GRACE Performance

In this section the performance of the GRACE is presented for an activity factor of 100%, i.e. when all the C-cells are active. In Figure 9, the evolution of the outage throughput is shown. It is possible to see that a steady increase in the outage throughput is achieved. Since the full reuse is the starting point, this is due to the interference avoidance nature of the GRACE. In other words, the number of allocated channels is reduced and, thus, the interference generated to other C-cells is also reduced.

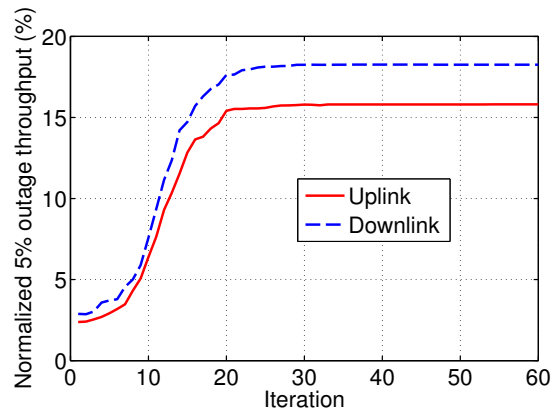

Figure 9. Evolution of outage throughput over the iterations when GRACE is used. Here, the activity factor is 100%.

The GRACE average throughput performance is shown in Figure 10. During the first iterations, the average capacity decreases, but once the interference is substantially reduced, the average throughput stabilizes on a higher level compared to the first iteration. The reason for this behavior can be seen from the Shannon capacity point of view. The channel capacity increases linearly with the bandwidth and logarithmically with the SINR. Therefore, a rather large increase in the SINR is needed to compensate for a reduction of the bandwidth.

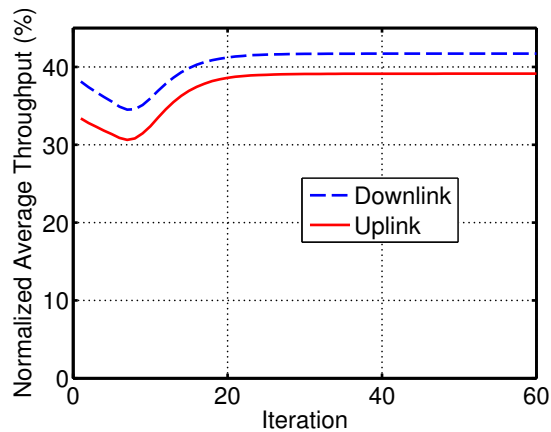

Figure 10. Evolution of average throughput over the iterations when GRACE is used. Here, the activity factor is 100%.

It is important to highlight the fact that a greedy local optimization of a single link capacity may not lead to a better average system performance. This can be seen from the initial reduction of the average capacity (see Figure 10), caused by the reduction of the allocated bandwidth. In order to avoid a poor performance, it is necessary to consider both the capacity and the interference avoidance, as in the GRACE.

Figure 11 shows the following performance indicator:

$$\sum \frac{I}{N} = \frac{\text{sum of interference power over all links in all allocated channels}}{\text{sum of noise power over all links in all allocated channels}} \quad (34)$$

All the links, including both the UL and the DL, are taken into account here. Note that the reduction in the interference, shown in Figure 11, is obtained without any sort of power control. Instead, only the interference avoidance is applied.

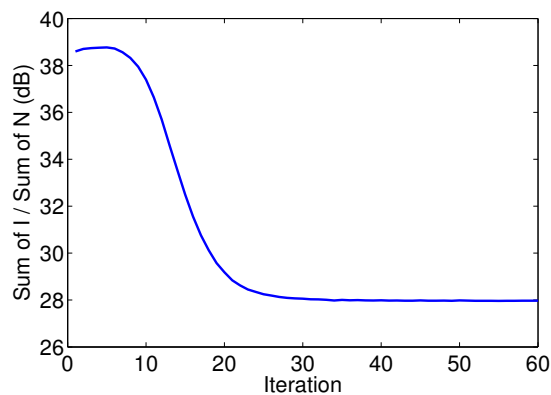

Figure 11. Evolution of total system noise rise (sum of interference power over all links / sum of noise power on all links).

In figure 11, apart from the very first few steps, the interference is steadily decreased. The target of the algorithm is not to completely eliminate the interference, but simply to reduce it to an equilibrium level. As a matter of fact, zero interference would correspond to a FDM allocation, which can be quite ineffective if forced on a large area. Each cell would in that case become severely bandwidth limited. On the contrary, the GRACE aims at providing an efficient and tight soft frequency reuse.

D. Comparison with Fixed Frequency Reuses

In this Section the performance of the GRACE is compared with the performance of several fixed frequency reuses which have been traditionally used in planned networks. The optimal frequency reuse depends on the number of the active networks, as well as the traffic they demand. The results of this section prove that the proposed algorithm is able to autonomously adapt to different spectrum loads, attaining a performance similar to the best frequency reuse for a given network usage.

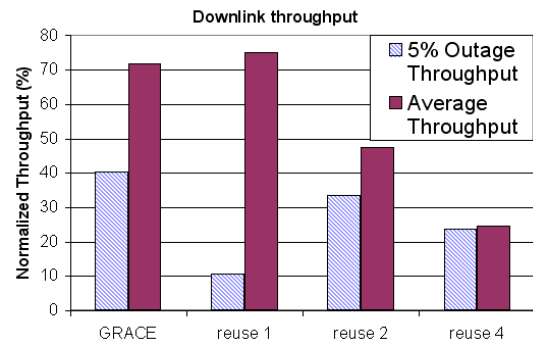

Figure 12. Average and 5% outage downlink throughput achieved by the proposed algorithm (GRACE) and fixed reuse strategies, when 20% of the access points are active on average.

The average DL throughput and the 5% outage DL throughput are presented in Figure 12. It should be noticed that the Reuse 1 (R1) has the overall best average throughput in low load scenarios, at the cost of having by far the worst outage performance. On the other hand, GRACE follows closely the R1 average throughput while providing the best outage throughput for a low activity factor.

In this kind of scenario where only a few APs are activated, the interference becomes quite asymmetric. While the GRACE is able to adapt the spectrum usage to this condition in order to exploit all the available resources, the fixed frequency reuses cannot do it, simply because they are optimized for other load situations (all the APs active). This is one of the main reasons for justifying the IC-DSA over the traditional planned networks.

The cumulative distribution function (CDF) of the DL throughput is shown in Figure 13. For a large part of the throughput distribution, the R1 has the best performance. However, it suffers from a low outage throughput. On the contrary, the GRACE has the best outage throughput among all the compared schemes. On top of that, the GRACE achieves the maximum theoretical capacity (100%) in most of the cases where R1 also does it (isolated cells). Note that in this low load scenario all the schemes become clearly bandwidth limited for a large portion of the cells. This can be seen from the range in which the CDF is almost vertical. Therefore it is very important to exploit the whole bandwidth in low load conditions.

The GRACE is able to achieve similar average throughput as R1, as shown in Figure 12, even though the median is much lower (see Figure 13). This behavior can be explained

by two facts: first, the GRACE performs better than the R1 in outage. Secondly, the maximum throughput achievable for isolated cells has a high impact on average while no impact on the median. In other words, the GRACE distributes the total throughput more evenly. This is a direct consequence of the choice of the weighting function (Figure 4).

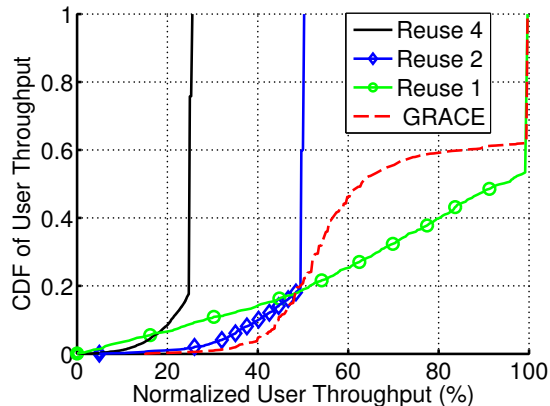

Figure 13. Cumulative Distribution Function of throughput, for an activity factor of 20%

Figure 14 shows the average and the 5% outage DL throughput for an activity factor of 100%. The Reuse 2 (R2) becomes the best solution for both the outage and the average capacity. The GRACE performance follows the R2 performance very closely.

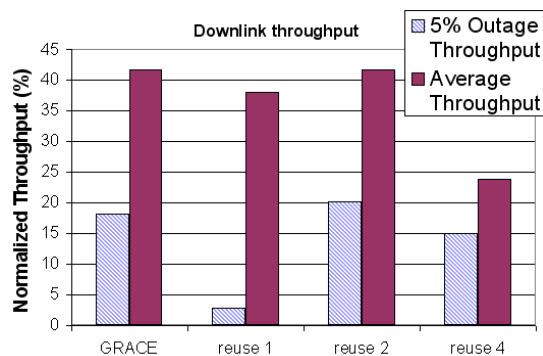

Figure 14. Average and 5% outage downlink throughput achieved by the proposed algorithm (GRACE) and fixed reuse strategies, when all access points are always active.

Finally, the CDF of the DL throughput for an activity factor of 100% is depicted in Figure 15.

The GRACE performances are close to the R2 ones, being slightly worse on the lower part and much better on the upper part of the distribution (when the R2 becomes bandwidth limited). This higher spread is a consequence of the competitive nature of the algorithm. Still, the GRACE is strictly superior in performance to the R1 and the Reuse 4 (R4), under a full load.

The previous examples, for a low load and the maximum load, show that the performance of a spectrum sharing algorithm should be analyzed under several loads.

Summarizing results are presented in Figures 16 and 17, for activity factors ranging from 20% to 100% .

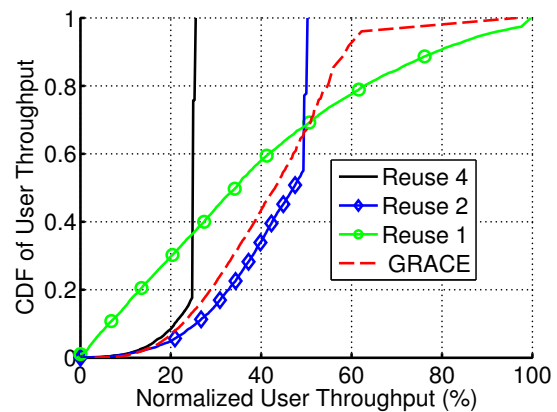

Figure 15. Comparison of GRACE CDF of normalized throughput with fixed frequency reuses.

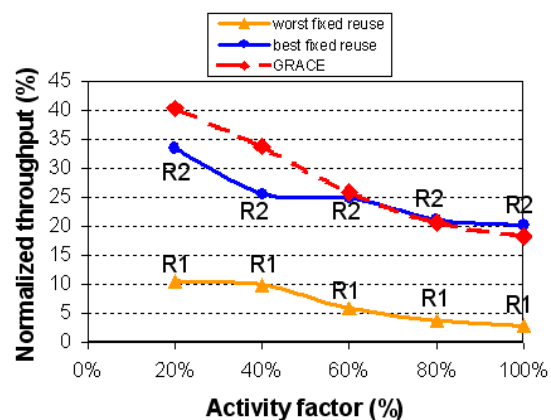

Figure 16. 5% outage downlink throughput achieved by the proposed algorithm (GRACE) and fixed reuse strategies. For each activity factor, the best and worst fixed reuse for that particular load is shown.

Figure 16 shows the 5% outage throughput in DL. For low loads, the GRACE provides the best outage performance, while for higher loads, its performance is equivalent to the best fixed reuse.

Figure 17 shows the results for the average throughput in DL.

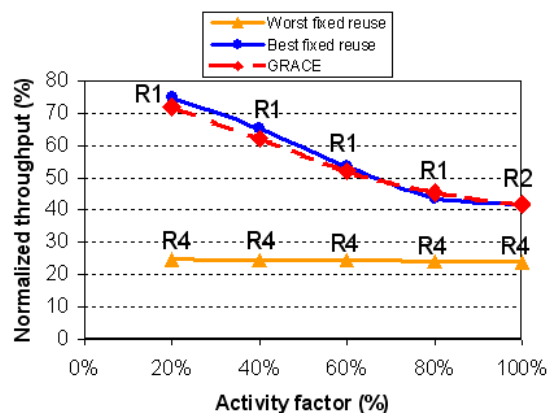

Figure 17. Average downlink throughput achieved by the proposed algorithm (GRACE) and fixed reuse strategies. For each activity factor, the best and worst fixed reuse for that particular load is shown.

It is important to emphasize that under low loads the best outage performance for a fixed reuse is provided by R2, while the best average throughput is obtained by R1. Therefore, they cannot be achieved at the same time by fixed reuses. The GRACE, on the other hand, is able to achieve good results in both outage and average throughput simultaneously.

In order to highlight the importance of this result, a scatter plot is shown in Figure 18, where the throughput values correspond to the sum of UL and DL throughput. It is interesting to compare the different schemes on more than one optimization dimension, especially when the optimization targets are conflicting or can not be combined. The Reuse 3 (R3) and a soft frequency Reuse 1.5 (R1.5) were also included for comparison. This R1.5 was obtained by applying the global interference minimization method described in [24], with each cell set to allocate 75% of the resources.

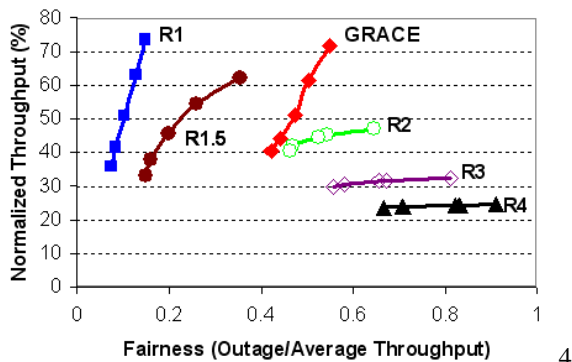

Figure 18. Scatter plot showing average throughput and fairness. The y-axis represents the total capacity on the simulated area. Fairness (x-axis) represent how equally this total capacity is distributed amongst the cells. The values presented here corresponds to the sum of uplink and downlink throughput.

Each point on the plot represents the average performances, under different loads, for a specific algorithm. In general, the algorithms which have curves on the top right have a better performance. The fairness metric should be understood as the fairness amongst the C-cells, and it represents how equally the total capacity is distributed amongst the cells. For example, the R4 has a very poor capacity performance, but this capacity is distributed very evenly amongst the cells, because the interference is very low.

Compared to the other schemes, the GRACE always has a close to top capacity. Also, the GRACE has a strong balance between the two optimization criteria. Comparing each activity factor, the GRACE always dominates R1.5, R3 and R4 in terms of total capacity. The GRACE also provides much more fairness than the R1 and, in most cases, a capacity superior to the R2 is provided. The one and only activity factor where the GRACE is strictly dominated (in terms of outage and average throughput) by a fixed reuse is in a full load network. And even in this situation the performance closely follows the best fixed reuse, the R2, as previously shown in details in Figure 15.

The results in Figures 16, 17 and especially in Figure 18 prove that the strength of GRACE is to adapt the allocation in order to achieve a good performance in several load and interference scenarios, always attaining high throughput in

both the outage and the average senses. We believe that these characteristics should, in general, be present in any efficient and fair spectrum sharing algorithm.

VI. CONCLUSIONS AND FUTURE WORKS

The new requirements, established for future wireless communication technologies by ITU (up to 1Gbps in low mobility), can only be achieved through the use of low range, low power, highly optimized Local Area access networks. Due to their uncoordinated deployment, these networks should be self-configurable in terms of spectrum allocation. Cognitive Radio (CR) based networking methodologies are considered as the most promising solutions for such radio resource sharing problems.

A "Game-based Resource Allocation in a Cognitive radio Environment" (GRACE) algorithm has been designed to enable a distributed and scalable resource allocation in competitive radio spectrum environments typical for cognitive cells (C-cells) in uncoordinated deployment scenarios. The overall complexity of such a proposal is low since no inter-cell signaling is required, and the needed signaling overhead in the AP-UE control plane is already present in OFDMA systems. One key part of the concept is the proposed utility function framework. As a practical telecommunication solution, the optimization of such utility function can be enforced by a regulator policy, a telecommunication standard or simply an operator can apply it within its network.

The proof-of-concept simulation results highlight the main strength of the GRACE: to adapt efficiently and dynamically in a fully distributed manner. The convergence of such procedure shows a little dependence on the number of C-cells, a high average throughput is achieved, and a minimum outage is attained. We believe that these are the main characteristics of any future cognitive radio/network which aims at an efficient and fair spectrum sharing in fully uncoordinated deployment scenarios.

The proposed methodology, due to its limited cognitivity, is intended to be the first practical step into the design of a *light* CR. Further research will primarily be devoted to increase the cognitivity of the GRACE through a continuous learning process that will enable boosting of the performances both in terms of accuracy and time convergence.

Other aspects have also to be investigated, such as the effective performances of the GRACE under real traffic conditions, including bursty and low-latency data traffic, and the effects of fast topology changes caused by handovers.

REFERENCES

- [1] W. Consult and U. Burggarten, "Wearable Computers and Wearable Electronics: The Last Mile to Ubiquitous Computing," *Ubiquitous Services and Applications: Exploiting the Potential; EURESCOM Summit 2005; Conference Proceedings, 27-29 April 2005, Marriott Hotel, Heidelberg, Germany*, 2005.
- [2] "Requirements related to technical performance for imt-advanced radio interface(s)," Report M.2134, ITU-R.
- [3] "Requirements for Further Advancements for E-UTRA (LTE-Advanced)," Technical Spec. TS 36.913.
- [4] "IEEE Standard for Local and metropolitan area networks Part 16: Air Interface for Fixed Broadband Wireless Access Systems," Standard.

- [5] Signal Research LLC, *Femto Forum Femtocell Business Case White Paper*, April 2009.
- [6] V. Chandrasekhar, JG Andrews, and A. Gatherer, "Femtocell networks: a survey," *IEEE Communications Magazine*, vol. 46, no. 9, pp. 59–67, 2008.
- [7] S. Yeh, S. Talwar, S.C. Lee, and H. Kim, "WiMAX femtocells: a perspective on network architecture, capacity, and coverage," *IEEE Communications Magazine*, vol. 46, no. 10, pp. 58–65, 2008.
- [8] J. McMillan, "Why auction the spectrum?," *Telecommunications Policy*, vol. 19, no. 3, pp. 191–199, 1995.
- [9] A. Ghasemi and ES Sousa, "Collaborative spectrum sensing for opportunistic access in fading environments," *New Frontiers in Dynamic Spectrum Access Networks, 2005. DySPAN 2005. 2005 First IEEE International Symposium on*, pp. 131–136, 2005.
- [10] JP Shim, U. Varshney, S. Dekleva, and G. Knoerzer, "Mobile and wireless networks: services, evolution and issues," *International Journal of Mobile Communications*, vol. 4, no. 4, pp. 405–417, 2006.
- [11] S. Haykin, "Cognitive radio: brain-empowered wireless communications," *Selected Areas in Communications, IEEE Journal on*, vol. 23, no. 2, pp. 201–220, 2005.
- [12] R.W. Thomas, D.H. Friend, L.A. Dasilva, and A.B. Mackenzie, "Cognitive networks: adaptation and learning to achieve end-to-end performance objectives," *IEEE Communications Magazine*, vol. 44, no. 12, pp. 51–57, 2006.
- [13] "IEEE Standard for Information technology-Telecommunications and information exchange between systems-Local and metropolitan area networks-Specific requirements - Part 11: Wireless LAN Medium Access Control (MAC) and Physical Layer (PHY) Specifications," Standard.
- [14] Bluetooth SIG, Inc., *Bluetooth standard, Specification of the Bluetooth System*, v 1.2 edition, November 2003.
- [15] "Evolved Universal Terrestrial Radio Access Network (E-UTRAN); X2 general aspects and principles," Technical Spec. TS 36.420.
- [16] T. Halonen, R.G. Romero, and J. Melero, *GSM, GPRS and EDGE performance: evolution towards 3G/UMTS*, Wiley, 2003.
- [17] A. Attar and A.H. Aghvami, "A Framework for Unified Spectrum Management (USM) in Heterogeneous Wireless Networks," *IEEE Communications Magazine*, p. 45, 2007.
- [18] M. Nekovee, "Dynamic spectrum access - concepts and future architectures," *BT Technology Journal*, vol. 24, no. 2, pp. 111–116, 2006.
- [19] Y. Yuan, W.A. Arbaugh, and S. Lu, "Towards Scalable MAC Design for High-Speed Wireless LANs," *EURASIP Journal on Wireless Communications and Networking*, 2007.
- [20] J. Lee, J. Mo, T.M. Trung, J. Walrand, and H.S.W. So, "WiFlex: Multi-Channel Cooperative Protocols for Heterogeneous Wireless Devices," in *IEEE Wireless Communications and Networking Conference, 2008. WCNC 2008*, 2008, pp. 1489–1494.
- [21] J. Neel, J. Reed, and A. MacKenzie, "Cognitive radio network performance analysis," in *Cognitive Radio Technology*, pp. 501–580. Newnes, 2006.
- [22] R. Menon, A. B. MacKenzie, R. M. Buehrer, and J. H. Reed, "A game-theoretic framework for interference avoidance in ad hoc networks," *Global Telecommunications Conference, 2006. GLOBECOM '06. IEEE*, pp. 1–6, Nov. 2006.
- [23] N. Nie and C. Comaniciu, "Adaptive channel allocation spectrum etiquette for cognitive radio networks," *Mobile Networks and Applications*, vol. 11, no. 6, pp. 779–797, 2006.
- [24] J. Ellenbeck, C. Hartmann, and L. Berlemann, "Decentralized inter-cell interference coordination by autonomous spectral reuse decisions," June 2008, pp. 1–7.
- [25] A. Leshem and E. Zehavi, "Cooperative game theory and the Gaussian interference channel," *IEEE Journal on Selected Areas in Communications*, vol. 26, no. 7, pp. 1078–1088, 2008.
- [26] J. E. Suris, L. A. Dasilva, Z. Han, and A. B. Mackenzie, "Cooperative game theory for distributed spectrum sharing," in *Communications, 2007. ICC '07. IEEE International Conference on*, 2007, pp. 5282–5287.
- [27] B. Wang, Y. Wu, Z. Ji, K.J.R. Liu, and T.C. Clancy, "Game Theoretical Mechanism Design Methods," *IEEE Signal Processing Magazine*, vol. 25, no. 6, pp. 74–84, 2008.
- [28] Andrea F. Cattoni, *Distributed Context Awareness in Cognitive Radio*, Ph.D. thesis, Doctoral School in Information and Communication Sciences and Technologies curriculum in Space Sciences and Engineering, University of Genoa, April 2008.
- [29] James W. Friedman and Claudio Mezzetti, "Learning in games by random sampling," *Journal of Economic Theory*, vol. 98, no. 1, pp. 55–84, May 2001.
- [30] A. Leshem and E. Zehavi, "Cooperative game theory and the gaussian interference channel," *Selected Areas in Communications, IEEE Journal on*, vol. 26, no. 7, pp. 1078–1088, September 2008.
- [31] Drew Fudenberg and Jean Tirole, *Game Theory*, MIT Press, 1991.
- [32] Rabah AMIR, "Supermodularity and complementarity in economics: an elementary survey," CORE Discussion Papers 2003104, Universit catholique de Louvain, Center for Operations Research and Econometrics (CORE), Dec. 2003.
- [33] Martin Kaae Jensen, "Aggregative games and best-reply potentials," *Journal of Economic Theory*.
- [34] P. Mogensen, Wei Na, I.Z. Kovacs, F. Frederiksen, A. Pokhariyal, K.I. Pedersen, T. Kolding, K. Hugl, and M. Kuusela, "LTE Capacity Compared to the Shannon Bound," *Vehicular Technology Conference, 2007. VTC2007-Spring. IEEE 65th*, pp. 1234–1238, April 2007.
- [35] P. et al. Kysti, "IST-WINNER D1.1.2. "WINNER II Channel Models", ver 1.1," Tech. Rep., Winner II, 2007.