



**AALBORG UNIVERSITY**  
DENMARK

**Aalborg Universitet**

## **Voltage Feedback based Harmonic Compensation for an Offshore Wind Power Plant**

Chaudhary, Sanjay K.; Lascu, Christian Vasile; Teodorescu, Remus; Kocewiak, ukasz

*Published in:*

Proceedings of the 2016 IEEE International Conference on Power Electronics, Drives and Energy Systems (PEDES)

*DOI (link to publication from Publisher):*

[10.1109/PEDES.2016.7914549](https://doi.org/10.1109/PEDES.2016.7914549)

*Publication date:*

2016

*Document Version*

Accepted author manuscript, peer reviewed version

[Link to publication from Aalborg University](#)

*Citation for published version (APA):*

Chaudhary, S. K., Lascu, C., Teodorescu, R., & Kocewiak, . (2016). Voltage Feedback based Harmonic Compensation for an Offshore Wind Power Plant. In Proceedings of the 2016 IEEE International Conference on Power Electronics, Drives and Energy Systems (PEDES) Trivandrum: IEEE Press.  
<https://doi.org/10.1109/PEDES.2016.7914549>

### **General rights**

Copyright and moral rights for the publications made accessible in the public portal are retained by the authors and/or other copyright owners and it is a condition of accessing publications that users recognise and abide by the legal requirements associated with these rights.

- ? Users may download and print one copy of any publication from the public portal for the purpose of private study or research.
- ? You may not further distribute the material or use it for any profit-making activity or commercial gain
- ? You may freely distribute the URL identifying the publication in the public portal ?

### **Take down policy**

If you believe that this document breaches copyright please contact us at [vbn@aub.aau.dk](mailto:vbn@aub.aau.dk) providing details, and we will remove access to the work immediately and investigate your claim.

# Voltage Feedback based Harmonic Compensation for an Offshore Wind Power Plant

S. K. Chaudhary, C. Lascu and R. Teodorescu

Department of Energy Technology  
Aalborg University  
Denmark

Lukasz Kocewiak

Electrical System Analysis  
DONG Energy Wind Power  
Gentofte, Denmark

**Abstract**—When an offshore wind power plant is connected to the grid, there is a risk of amplification of certain harmonics and appearance resonances at the point of connection due to the interaction between the grid network and the wind power plant network. Hence, the plant developer is obliged to maintain the harmonic distortion at the point of common coupling within the planning level limits using harmonic compensation, which is usually done by passive filters. In this paper a novel active harmonic compensation technique using voltage feedback from a non-local bus has been proposed and analyzed. Its effectiveness has been demonstrated through real time simulations on a test system model.

**Keywords**— Harmonic distortion, active power filter, resonance, damping, wind power plants.

## I. INTRODUCTION

Offshore wind power plants (WPPs) are connected to the onshore grid using long high voltage cables, and usually a transformer at the grid end. Besides there is a large amount of cables in the collector grid increasing the complexity of the WPP electrical infrastructure and leading to resonance phenomena. The combination of the transformer reactance and the cable capacitances and their interaction with the grid impedance can lead to the amplification of harmonic distortion levels and potential resonances [1]. Harmonic standards like IEEE [2] and IEC [3] recommend certain harmonic limits for harmonic emissions from individual equipment. For the grid connection of WPP projects in the UK, Engineering Recommendation G5/4-1 [4] defines the planning levels for the grid connection of the non-linear equipment.

There are different harmonic sources, like the power electronic converters, or the non-linear loads in the power system network, which generate the harmonic voltages and draw harmonic currents. Consequently, there is some amount of harmonic distortion. Such a distortion is the resultant effect of all the harmonic sources and impedances in the network. When a WPP is connected to the network, it adds a lot of cable capacitance which is in shunt connection and the transformer reactance in series. Therefore, the harmonic impedance characteristic of the grid changes and depending upon the impedance values of the grid and the wind power plant, there might be an amplification or attenuation of the harmonics at the point of connection (POC). If the reactive parts of the grid impedance and the WPP impedance cancel each other, i.e. when one is capacitive and the other is inductive, there will be a severe

resonance, which can be hazardous for the system. Such an amplification of harmonic distortion at the POC might lead to unacceptable levels of harmonic distortion and poor power quality. Moreover, the power converters present in the WPP, might also be injecting certain amount of harmonics in the power system. Consequently, the excessive level of harmonic distortion can lead to grid code compliance issues, malfunction of protection devices, accelerated aging process of power system components or even damage of such vulnerable device as switch-mode power supplies (SMPSs).

Harmonic compensation by emulating the resistive behavior at the harmonic orders has been described in literature [5]. It was pointed out in [6] that this approach cannot guarantee the compensation at the busses upstream in the grid. Hence, it might not be able to limit the harmonic distortion at the POC. This paper describes the amplification of the harmonic voltage levels in the background grid due to the interactions between the grid and the WPP impedances at the POC. Harmonic current injection from the wind turbines (WTs) in the WPP has been ignored in this study. Harmonic compensation strategy has been proposed using voltage feedback from the POC (400 kV bus) to control the active filter embedded in a STATCOM unit which is connected not at the POC, but at another bus in the WPP network. The control approach is mathematically analyzed and validated by real time simulation on RTDS.

## II. TEST WIND POWER PLANT NETWORK

A test model of the 400 MW Anholt WPP has been modelled in RSCAD as shown in Fig. 1 [7]. In this case, the grid impedance is given as a frequency dependent characteristic. It has been fitted into a rational function applying the vector fitting algorithm [8] in RSCAD. The background harmonic levels present in the grid is represented by the Thévenin's voltage sources, i.e. the ideal harmonic voltage sources in series with the frequency-dependent impedance.

There are 3x140 MVA, 225/32 kV plant step up transformers to connect the collector bus to the 220 kV export cables, which consist of 24.5-km submarine cable and 58-km underground cables. Finally, it is connected to the onshore grid using two 450 MVA, 410/233 kV transformers. Shunt reactors are provided at both ends of the underground cable for the compensation of cable capacitance. Detailed layout of the high voltage (HV) cables including the cross-bonding has been used. Trefoil formation has been assumed for both the underground and submarine cables.

---

This work was supported by Energinet.dk through the project "Active filter functionalities for power converters in wind power plants" (ForskEL program, project number PSO-2014-1-12188).

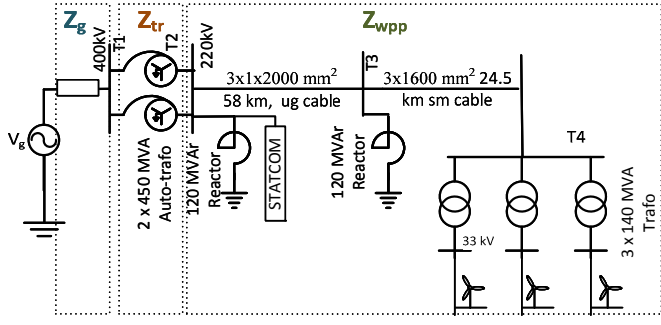

Fig. 1. WPP electrical network model.

A STATCOM, connected at the 220-kV bus  $T_2$  provides the reactive power compensation as well as the harmonic compensation by its current control capability. It is assumed that it has sufficient bandwidth and voltage ratings to control the currents up to the 19<sup>th</sup> harmonic. Therefore, in this work, it is treated as a controlled current source. Moreover, the paper describes only the harmonic current injection from the STATCOM for active filtering. Hence, the reactive power compensation is not described here.

### III. THEORETICAL ANALYSIS

A simplified equivalent circuit of the WPP along with the STATCOM and its controller for harmonic filtering is shown in Fig. 2. The following theoretical and static analysis assumes all impedances at a specified  $h^{\text{th}}$  harmonic order. Therefore, the analysis should be repeated for the different harmonic orders. The interaction among the equivalent grid impedance,  $Z_g$ , the transformer impedance,  $Z_{tr}$ , and the equivalent impedance of the WPP,  $Z_{wpp}$ , as well as the background voltage  $V_h$  in the grid determines the voltages  $V_1$  and  $V_2$  at the terminals  $T_1$  and  $T_2$  respectively as follows,

$$V_1 = \frac{(Z_{wpp} + Z_{tr})V_h - Z_g Z_{wpp} I_F}{Z_g + Z_{tr} + Z_{wpp}}, \quad (1)$$

$$V_2 = \frac{Z_{wpp} V_h - (Z_g + Z_{tr}) Z_{wpp} I_F}{Z_g + Z_{tr} + Z_{wpp}}. \quad (2)$$

When there is no harmonic compensating current injection from the STATCOM, the base case harmonic voltages at  $T_1$  and  $T_2$  can be obtained by setting,  $I_F = 0$  in (1) and (2).

#### A. Harmonic compensation using voltage feedback

The impedance,  $Z_{wpp}$ , of the WPP is estimated by the frequency scan analysis of the WPP network model. The grid impedance data is obtained from the grid operator. The transformer impedance is specified in its datasheet. Now, if the STATCOM is controlled to inject the harmonic currents as per the relation,

$$I_F = \frac{KV_1}{Z_2}. \quad (3)$$

Under such a circumstance, the resultant harmonic voltage due to the background harmonics,  $V_h$ , in the grid and the corresponding amplification ratio at  $T_1$ , and  $T_2$ , are given by (4) and (5) respectively.

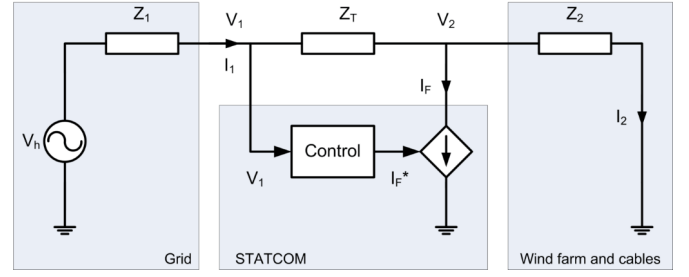

Fig. 2. Simplified wind power plant model with compensation at  $T_2$  based on  $T_1$  voltage feedback.

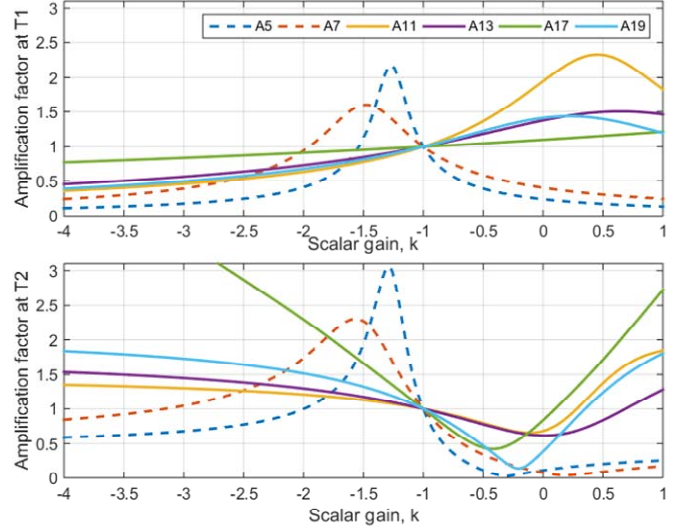

Fig. 3. Amplification at  $T_1$  and  $T_2$  due to the compensation  $I_F = \frac{kV_1}{Z_2}$  at  $T_2$

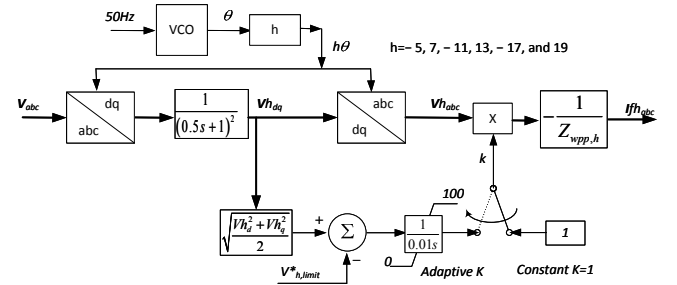

Fig. 4. Generation of the harmonic current references for the STATCOM.

$$\left. \begin{aligned} V_1 &= V_h \frac{Z_{wpp} + Z_{tr}}{(1+K)Z_g + (Z_{wpp} + Z_{tr})} \\ A_1 &= \frac{V_1}{V_h} = \frac{Z_{wpp} + Z_{tr}}{(1+K)Z_g + (Z_{wpp} + Z_{tr})} \end{aligned} \right\} \quad (4)$$

$$\left. \begin{aligned} V_2 &= V_h \frac{Z_{wpp} - kZ_{tr}}{(1+K)Z_g + (Z_{wpp} + Z_{tr})} \\ A_2 &= \frac{V_2}{V_h} = \frac{Z_{wpp} - kZ_{tr}}{(1+K)Z_g + (Z_{wpp} + Z_{tr})} \end{aligned} \right\} \quad (5)$$

The static characteristic of the amplification ratios,  $A_1$  and  $A_2$  in (4) and (5), are shown in Fig. 3. The harmonic voltage

amplification ratios at  $T_1$  and  $T_2$  are unity for  $K = -1$ . This means, that under such circumstances, the harmonic currents will not flow from the grid into the WPP and, therefore, there will not be any change in harmonic distortion due the grid connection of the WPP.

The plot also shows that the harmonic amplification at the bus  $T_1$  could be reduced to very low levels, below the background levels by controlling the value of the gain  $K$  in the voltage feedback (3).

Of course, this approach requires precise estimation of  $Z_{wpp}$  in order to map the background distortion  $V_h$  at  $T_1$ . It is believed that the knowledge about the WPP electrical infrastructure is well known and the impedance assumption can be trustful. Of course, this approach requires precise estimation of  $Z_{wpp}$  in order to map the background distortion  $V_h$  at  $T_1$ . It is believed that the knowledge about the WPP electrical infrastructure is well known and the impedance assumption can be trustful.

### B. Harmonic current compensator

A block diagram of the harmonic current controller is shown in Fig. 4. Specific harmonic voltage components are extracted using Park's transformation, which converts the specific harmonic voltage components into the dc quantities along the  $d$  and  $q$  axes, while other harmonic quantities appear as harmonic components. The harmonic components are filtered away and the dc components are transformed back into phase domain by the inverse Park's transformation.

The impedance of the WPP network exhibits a frequency dependent characteristics. For the specific frequency it has a constant value, which can be inductive or capacitive. This impedance is represented by a suitable transfer function. If it is inductive, it is given by,

$$Z_{wpp}(s) = H_{APF}(s) = \frac{I_F^*(s)}{V_1(s)} = \frac{1}{L_2s + R_2}, \quad (6)$$

When it is capacitive it is given by (7), as follows,

$$Z_{wpp}(s) = H_{APF}(s) = \frac{I_F^*(s)}{V_1(s)} = \frac{C_2s}{R_2C_2s + 1}. \quad (7)$$

These transfer functions are match the actual impedance value only at the specific harmonic frequency for which it has been derived. Hence, a separate transfer function has to be derived for separate harmonic frequencies, like the 5<sup>th</sup>, 7<sup>th</sup>, 11<sup>th</sup>, etc.

Since  $K = -1$ , provides unity amplification of the harmonic voltages at  $T_1$  and  $T_2$ ; and negative values of the gain  $K$ , ensures lower harmonic voltage amplification, it is decided to include the negative sign in the impedance transfer function as shown in Fig. 4. The new gain  $k = -K$  is denoted by a small letter. Individual harmonic current references are thus obtained in the phase domain and then added together, to generate the overall harmonic current reference for the STATCOM.

Depending upon the choice of constant or adaptive gain constant, there are two possibilities as described below.

#### 1) Harmonic compensator with constant gain $k$

When constant gain  $k = 1$  is used, the harmonic voltage amplification is unity at both  $T_1$  and  $T_2$ . This implies that there will not be any harmonic voltage amplification at both  $T_1$  and  $T_2$  irrespective of the grid impedance variation. In other words, the harmonic voltages will settle at the background harmonic levels. Hence, if there was a harmonic attenuation prior to the application of the harmonic filter as in the case of the 5<sup>th</sup> and 7<sup>th</sup> harmonic component at  $T_1$ , they would appear to increase to the background levels due to the application of the filter. At the bus  $T_2$ , all the harmonics appear attenuated in the base case, and hence all of them will appear amplified to the background levels.

#### 2) Harmonic compensator with Adaptive controller

In the next case, the gain  $k$  is increased till the harmonic voltage at  $T_1$ , which is considered as the PoC, is brought down to the desired limit levels. Since, the curves for the 5<sup>th</sup> and 7<sup>th</sup> harmonic shows that they are attenuated prior to the harmonic compensation, no compensation is applied to these components. The curves in Fig. 3 show that such a compensation will increase as the gain  $k$  is increased towards unity. Similarly, the harmonic voltage levels at  $T_2$  will be increased as a result of this compensation.

## IV. REAL TIME SIMULATION RESULTS

The test WPP network has been modelled in detail in RSCAD as shown in Fig. 5. The wind turbine units are aggregated into 66 MW equivalents units. Moreover, this work analyzes the amplification of the background harmonics in the grid due to the grid connection of the WPP network. Therefore, the harmonic injections from the WT units have been completely ignored.

The individual harmonic voltage components at  $T_1$  are estimated using Park's transformations. Then they are scaled by the gain  $k$ , which can be constant or adaptive depending upon the selected mode. It can be switched into constant gain or adaptive gain modes in the run-time environment in RTDS. Finally, they are negated and multiplied by the transfer function equivalent of the grid impedance as described in Section III.

### A. Simulation results with constant gain $k=1$

When the compensator was activated with gain  $k$  kept constant at unity, it was observed that the harmonic voltage levels at  $T_1$  and  $T_2$  settled close to the background levels specified in the voltage source, as shown in Table I and Fig. 6. There is a good matching of the harmonic voltages of from the 11<sup>th</sup> to the 19<sup>th</sup> orders. The 5<sup>th</sup> and the 7<sup>th</sup> harmonic order voltage components at  $T_1$  get amplified from 0.22% and 0.23% to 0.41% and 0.28% respectively. Thus they rise towards the background harmonic levels.

Fig. 6 shows the dynamics of the harmonic voltage levels at  $T_1$  after the compensator is activated at 2s. The dotted lines indicate the background harmonic levels before the connection of the WPP. The measured harmonic levels are indicated by the solid lines or the curved lines for the 5<sup>th</sup> and the 7<sup>th</sup> harmonic components.

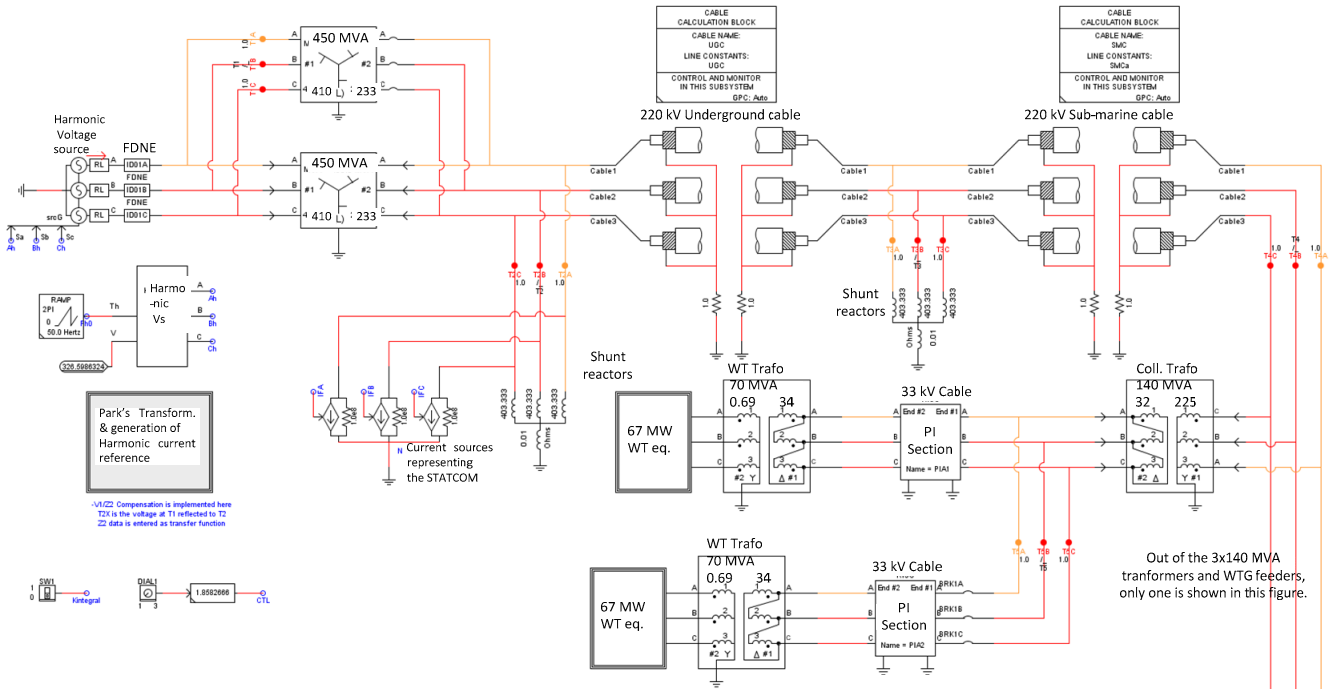

Fig. 6. RTDS model of the WPP with harmonic compensation.

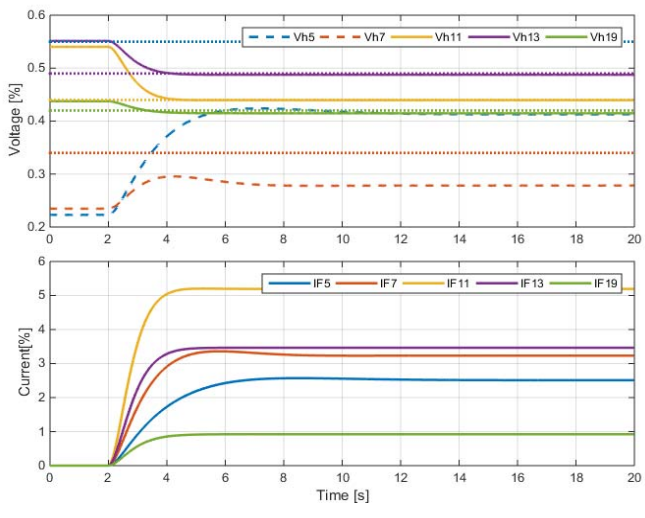

Fig. 5. Harmonic compensator with unity gain (a) Background harmonic levels (dotted) and the observed harmonic voltage levels (solid or dashed)

Since this method leads to an amplification for the 5<sup>th</sup> and the 7<sup>th</sup> harmonic components of voltage, it is only of theoretical significance as a validation of the concept. In practice, the method can be applied only for the harmonic orders which get amplified to bring them back to the background harmonic levels. Thus, the harmonic voltage amplification ratio at T<sub>1</sub> can be limited to unity.

TABLE I. VOLTAGE HARMONICS AT T1 AND STATCOM HARMONICS CURRENTS FOR UNITY FEEDBACK GAIN.

Harmonic	5th	7th	11th	13th	17th	19th
Background	0.50%	0.34%	0.44%	0.49%	0.10%	0.42%
T1 - Base	0.22%	0.23%	0.54%	0.55%	0.10%	0.44%
T1-Compensated	0.41%	0.28%	0.44%	0.49%	0.10%	0.41%
T2 - Base	0.22%	0.05%	0.06%	0.08%	0.03%	0.14%
T2-Compensated	0.47%	0.29%	0.46%	0.51%	0.11%	0.50%
Current, I <sub>f</sub>	2.5%	3.2%	5.2%	3.5%	0.3%	0.92%

TABLE II. VOLTAGE HARMONICS AND STATCOM HARMONICS CURRENTS FOR ADAPTIVE FEEDBACK GAIN.

Harmonic	5th	7th	11th	13th	17th	19th
Background	0.50%	0.34%	0.44%	0.49%	0.10%	0.42%
Limits	0.40%	0.30%	0.30%	0.20%	0.20%	0.15%
T1	0.22%	0.23%	0.3%	0.2%	0.10%	0.171%
T2	0.22%	0.05%	1.00%	2.40%	0.03%	4.50%
T4	0.35%	0.13%	2.20%	3.40%	0.11%	3.80%
Gain, K <sub>c</sub>	0	0	3.5	13	0	29
Current, I <sub>f</sub>	0	0	12%	19%	0	11%

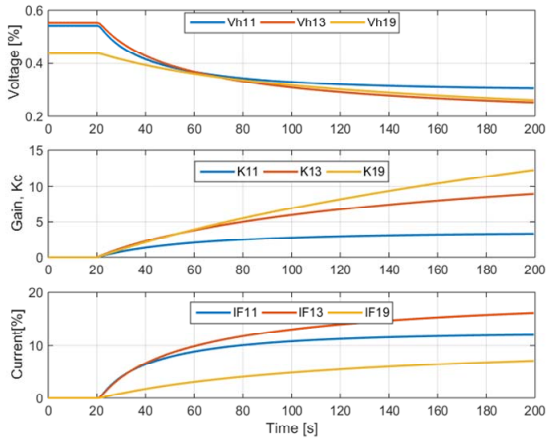

**Fig. 7.** Harmonic compensator with adaptive gain (a) 11<sup>th</sup>, 13<sup>th</sup> and 19<sup>th</sup> Harmonic voltage levels at T1. (b) Adaptive gain  $k$  (i.e.  $-K$ ). (c) Harmonic current from the STATCOM.

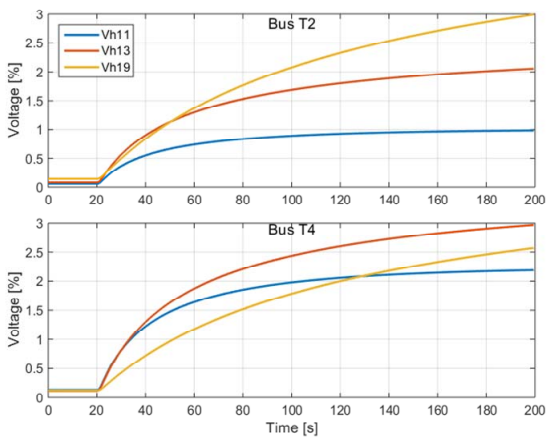

**Fig. 8.** Harmonic compensator with adaptive gain. 11<sup>th</sup>, 13<sup>th</sup> and 19<sup>th</sup> harmonic voltage levels at  $T_2$  and  $T_4$ .

### B. Simulation results with adaptive gain $k$

Stringent harmonic limits were set to bring down the 11<sup>th</sup>, 13<sup>th</sup> and the 19<sup>th</sup> order harmonics down to 0.3%, 0.2% and 0.15% respectively. The mode was changed to the adaptive gain and the compensator was activated at 20 s. Its performance over a period of 200 s is shown in Fig. 7. The slow dynamics depends upon the delays introduced by the filters used in the extraction of the individual harmonics from the measured three phase voltage data, and the time constant of the integral used in the adaptive gain.

The harmonic voltage levels slowly decrease towards the specified limit levels. By the end of 15 minutes-period, the 11<sup>th</sup>, 13<sup>th</sup> and 19<sup>th</sup> order harmonic voltages decrease to 0.3%, 0.2% and 0.17% respectively as shown in Table II. The corresponding gains are 3.5, 13 and 29, and the compensating currents are 12%, 19% and 11% of the nominal rated current for the 11<sup>th</sup>, 13<sup>th</sup> and the 19<sup>th</sup> harmonic orders respectively. The harmonic voltages at the buses  $T_2$  and  $T_4$ , which lie within the WPP network, get amplified to quite high levels, like 4.5% and 3.8% for the 19<sup>th</sup>

harmonic order at  $T_2$  and  $T_4$  respectively. The rise of harmonic voltages at  $T_2$  and  $T_4$  are shown in Fig. 8.

## V. CONCLUSION

This paper describes the amplification of background harmonic voltages due to the grid-connection of an offshore WPP is connected to the grid. The amplification occurs, even when the WTs are not injecting any harmonics. Afterwards, a novel harmonic compensation technique for the active filtering of these harmonic voltages using voltage feedback from the POC. The technique for harmonic compensation is mathematically derived and two cases, one with constant unity gain and another with adaptive gain, are described.

The application of the harmonic compensator is demonstrated through the real-time simulation of a on a detailed WPP network model in RTDS. The simulated results confirm the performance of the proposed harmonic compensation as the harmonic voltage levels could be brought down to the background harmonic levels (i.e. unity amplification ratio) when the unity gain was applied in the voltage feedback. Moreover, it was possible to bring them down to the specified limits as low as 0.15% even when the background harmonic level remained at 0.42% for the 19<sup>th</sup> harmonic. Thus, it proved to be a very efficient method to comply with the harmonic requirements at the grid. However, such a stringent limit resulted in amplification of the harmonic distortion at the buses internal to the WPP. Therefore, the impact of such amplification on the electrical infrastructure within the WPP should be thoroughly assessed to ensure to ensure that the relevant standards and design guidelines are not violated. The real-life implementation would require such considerations and optimization on a system level.

## REFERENCES

- [1] M. Bradt et al., "Harmonics and resonance issues in wind power plants," in IEEE PES GM, San Diego, CA, 2011.
- [2] IEEE Std. 519-1992, "IEEE Recommended Practices and Requirements for Harmonic Control in Electrical Power Systems".
- [3] IEC Standard 61000-3-6 (2008), Electromagnetic compatibility (EMC) – Part 3-6 – Limits: Assessment of the connection of the distorting installation to MV, HV and EHV power systems.
- [4] Planning levels for harmonic voltage distortion and connection of non-linear equipment to transmission and distribution networks in the UK, Engineering Recommendations (ER) G5/4-1.
- [5] H. Akagi, H. Fujita, and K. Wada, "A shunt active filter based on voltage detection for harmonic termination of a radial power distribution line," IEEE Trans. Ind. Appl., vol. 35, no. 3, pp. 638–645, 1999.
- [6] S. K. Chaudhary, C. Lascu, B. Hoseinzadeh, R. Teodorescu, L. H. Kocewiak, T. Sørensen, C. F. Jensen, "Challenges with harmonic compensation at a remote bus in offshore wind power plants," in Proc. IEEE International Conference on Environment and Electrical Engineering (EEEIC), IEEE, 07-10 June 2016, Florence, Italy, p. 1-6.
- [7] L. H. Kocewiak et al., "Active Filtering Application in Large Offshore Wind Farms," in International Workshop on Large-Scale Integration of Wind Power into Power Systems as well as Transmission Networks for Offshore Wind Farms, Berlin, 2014.
- [8] Gustavsen and H. M. J. De Silva, "Inclusion of rational models in an electromagnetic transients program: Y-Parameters, Z-Parameters, S-parameters, transfer functions," IEEE Trans. Power Deliv., vol. 28, no. 2, pp. 1164–1174, 2013.