



Aalborg Universitet

AALBORG UNIVERSITY  
DENMARK

## Evaluation of Aggregators for Integration of Large-scale Consumers in Smart Grid

Rahnama, Samira; Shafiei, Seyed Ehsan; Stoustrup, Jakob; Rasmussen, Henrik; Bendtsen, Jan Dimon

*Published in:*  
Proceedings of the 19th IFAC World Congress, 2014

*DOI (link to publication from Publisher):*  
[10.3182/20140824-6-ZA-1003.00601](https://doi.org/10.3182/20140824-6-ZA-1003.00601)

*Publication date:*  
2014

*Document Version*  
Accepted author manuscript, peer reviewed version

[Link to publication from Aalborg University](#)

*Citation for published version (APA):*  
Rahnama, S., Shafiei, S. E., Stoustrup, J., Rasmussen, H., & Bendtsen, J. D. (2014). Evaluation of Aggregators for Integration of Large-scale Consumers in Smart Grid. In *Proceedings of the 19th IFAC World Congress, 2014* (1 ed., Vol. 19, pp. 1879-1885). IFAC Publisher. <https://doi.org/10.3182/20140824-6-ZA-1003.00601>

### General rights

Copyright and moral rights for the publications made accessible in the public portal are retained by the authors and/or other copyright owners and it is a condition of accessing publications that users recognise and abide by the legal requirements associated with these rights.

- Users may download and print one copy of any publication from the public portal for the purpose of private study or research.
- You may not further distribute the material or use it for any profit-making activity or commercial gain
- You may freely distribute the URL identifying the publication in the public portal -

### Take down policy

If you believe that this document breaches copyright please contact us at [vbn@aub.aau.dk](mailto:vbn@aub.aau.dk) providing details, and we will remove access to the work immediately and investigate your claim.

# Evaluation of Aggregators for Integration of Large-scale Consumers in Smart Grid <sup>★</sup>

Samira Rahnama, S. Ehsan Shafiei, Jakob Stoustrup,  
Henrik Rasmussen, Jan Bendtsen <sup>\*</sup>

<sup>\*</sup> *Department of Electronic Systems, Automation and Control, Aalborg University, Aalborg, Denmark (e-mail: {sar, ses, jakob, hr, dimon}@es.aau.dk).*

---

**Abstract:** Utilization of consumers to mitigate the impact of increasing renewable resources on power systems is one of the visions of future smart grids. Flexible consumers are consumers who can change their consumption patterns in such a way as to help the grid to tackle the balancing problem. In previous work, we proposed a hierarchical structure to provide regulating power to the grid by just utilizing the consumption units. The main focus of that work was on designing a centralized controller, a so-called aggregator, which is responsible for aggregating the flexibilities in an optimal way. To accomplish the optimization, the aggregator requires a model which describes the behavior of each consumption unit. These models should be sufficiently simple to be used in the optimization task. However, simple models might not capture all dynamics and features of the real system. In this paper, we will evaluate the proposed set-up to understand to what extent the utilization of simplified models can lead to reasonable results. To this end, we will connect the aggregator to a complex and verified model of an actual supermarket refrigeration system which enables us to investigate the closed-loop behavior of the whole set-up.

Keywords: smart grid, flexible demand.

---

## 1. INTRODUCTION

Future smart grids will enable us to increase the penetration of renewable resources, which is a promising way to reduce CO<sub>2</sub> emission and overcome depletion of fossil fuel resources. On the other hand, establishing a balance between production and consumption is becoming more challenging as the share of intermittent resources increases. In a smart grid context, one idea to resolve this issue is to involve the consumer side in balancing effort (Nayyar et al. [2013] and Kizilkale and Malhame [2013]). This can be done by urging or postponing the consumption units when there is power surplus or power deficit in the power grid. In this way, consumers will be able to offer different power services in various electricity markets like the day-ahead or regulating power markets (Zhang and Baillieul [2013] and Chen et al. [2013]). Different control strategies have been proposed to integrate the consumers to the smart grid. However, generally we can classify them into two main categories, which are entitled direct control and indirect control (Kosek et al. [2013]). In summary, direct control refers to those strategies in which the consumers receive control commands from a grid operator to follow. In most cases, this implies a two-way communication and exchanging information between the players. On the contrary, indirect control is a one-way communication approach where the grid operator distributes an incentive signal

such as price to change the consumption. Since there is no obligation for the consumers to react to this signal, indirect control is always accompanied by uncertainty. Most of the studies regarding the indirect control address residential units and home appliances. For instance, Corradi et al. [2013] develops a method to estimate the consumers' response to the price signal. The method is then applied to a household heating system. Another example is the work in Paschalidis et al. [2012], which proposes a mechanism to provide ancillary services such as fast reserves from the loads inside a building through a smart microgrid operator. However, in practice, home owners may not consent to participate in balancing tasks under the direct policy, as this can disturb their privacy. Nonetheless, to aggregate many small energy consumers, the indirect control, which is a distributed approach, can be applicable. However, industrial or commercial loads, which are large energy consumers with less privacy issues, can be reasonably utilized under a direct and centralized approach.

In Rahnama et al. [2013], we formulated a centralized controller, the so-called *aggregator* to provide down-regulating power to the grid. The term *aggregator* has been recently used in smart grid literature as a new player in the future electricity market. An aggregator is an entity placed between a grid operator and a number of flexible consumers to handle the energy/power services can be derived from the demand that these consumers represent. However, aggregator responsibilities can vary depending on several factors such as control strategies, demand types, provided services etc. In You et al. [2009], the VPP aggregator (vir-

---

<sup>★</sup> This work is supported by the Danish government via the Strategic Platform for Innovation and Research in Intelligent Power (iPower), as well as the Southern Denmark Growth Forum and the European Regional Development Fund under the Project Smart & Cool

tual power plant aggregator) has been categorized according to the control strategies. The direct controlled VPP aggregator is responsible for optimally operating a portfolio of units based on the available information whereas the indirect controlled aggregator acts as a broadcast agent to distribute price signals. In Gkatzikis et al. [2013], the aggregator is designed to operate between the residential units and the utility operator. In the proposed setup, the aggregator negotiates with the home owner when the operator announces its rewards for power services. After they reach an agreement, the aggregator will offer services on behalf of the units to the operator. This setup is different from the direct aggregator since there is no direct command. It is also different from the indirect aggregator because of the negotiation.

The aggregator proposed in Rahnama et al. [2013] is based on direct control. Fig. 1 shows a hierarchical structure where such an aggregator operates. In this contract based setup, the aggregator commits to follow a specified power reference within a specific period of time called the activation time. The objective is to optimally split up the power reference between the consumers while respecting their constraints. The aggregator can then offer flexibility to the TSO (Transmission System Operator), DSO (Distribution System Operator) or BRP (Balance Responsible Party). How the power reference is defined by the top-level controller is not in the scope of this study. At the bottom, we consider a heterogeneous portfolio of industrial consumers. Our case studies are a supermarket refrigeration system and a chiller equipped with ice storage. The general setup in this paper is similar to Petersen et al. [2013]. In that work, a direct control VPP is introduced which has the task of providing power to a portfolio of flexible consumers. A taxonomy for flexible consumption is also presented as "Buckets, Batteries and Bakeries" that describe the flexibility based on the power/energy capacity, minimum runtime and the energy level at a specific time. In our setup, we take into account the dynamics of individual consumer to some extent. The aggregator in this direct setup requires a model of each consumer to achieve its goal. To develop a realistic aggregator, the models should be extremely simple; however, this may lead to inaccurate results. In this paper, we connect the aggregator with the simplified models to a complex and verified model of a supermarket developed in Shafiei et al. [2013]. Then, by comparing the estimated results obtained from the aggregator with the actual results, we evaluate our proposed aggregator setup.

The structure of the paper is as follows: Section 2 describes the aggregator business model. We improve our previous setup in Rahnama et al. [2013] by changing the cost function and chiller model. In Section 3, the complex model for supermarket is provided. In Section 4, we first introduce the scenario we consider for the evaluation. Then the simulation results will be provided. Finally we conclude the paper in Section 5.

## 2. AGGREGATOR BUSINESS MODEL

In order to develop a business model for the aggregator based on the direct set-up, we need to specify the following items:

- (1) Optimization problem at the aggregator

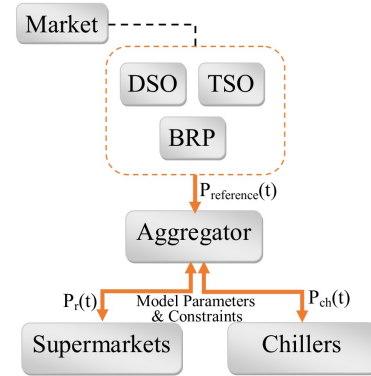

Fig. 1. Hierarchical Direct Control Setup

- (2) Model of the consumption units
- (3) Information flow between the aggregator and the units

In this paper, we assume one supermarket and one chiller under the direct jurisdiction of the aggregator. In a real business case, indeed, we have several supermarkets and chillers. Hence, this setup can be interpreted as a special case where we have several identical supermarkets and chillers which are seen as one supermarket and one chiller.

Note that, in both cases, we deliberately employ simplified models at the aggregator level. This is done for several reasons:

- Computational complexity: using complex models at the aggregator increases the computational complexity. This makes the computational time unacceptable in practice, where we aim to find the optimal solution for a large number of units within a limited period of time.
- Information encapsulation: as mentioned above, the direct control requires information exchange between the players. Increasing the complexity will lead to increase in the required information to be exchanged. Thus, the information encapsulation becomes difficult.
- Separation of responsibility: the aggregator would not intend and it is out of the scope of its responsibilities to control the consumers in detail, such as every single valves or pumps. Therefore, having a complex model of the whole system is not necessary at the aggregator.

### 2.1 Optimization Problem

Here, we consider a situation where the aggregator is asked to follow a power reference which is greater than its baseline consumption. This can happen when the aggregator decides to provide down-regulating power to the grid. In this case, the aggregator is actually faced with the problem of storing some extra energy in thermal storages at its disposal. In Rahnama et al. [2013], we formulated this problem based on the fact that the more energy can be stored during the activation, the more energy can be retrieved just after the activation by turning off the consumption units. In this paper, we improve our formulation in a way that exactly reflects the energy savings after the activation.

During this time, the units consume the minimum power whereas in case of no activation, they have to consume at least the baseline power. Therefore, at each time instant, the consumers are able to save  $P_{base} - P_{min}$  as long as they consume the minimum power. The optimization problem is formulated as follows:

$$\max_{P_r, P_{ch}} [(P_{r,base} - P_{r,min}) \times t_{r,off} + (P_{ch,base} - P_{ch,min}) \times t_{ch,off}] \quad (1)$$

subject to :

$$P_r(t) + P_{ch}(t) = P_{reference}(t) \quad (2)$$

Consumers' Dynamic

Consumers' Constraints

where  $t_{r,off}$  and  $t_{ch,off}$  indicate the duration when the supermarket refrigeration and chiller consume the minimum power.  $P_r$  and  $P_{ch}$  are the power consumption of supermarket and chiller respectively.  $P_{r,base}$  and  $P_{ch,base}$  represent the associated baseline consumption.  $P_{r,min}$  and  $P_{ch,min}$  are their minimum power consumption.

## 2.2 Model of the Consumers

First, let us consider a simple cold room in a supermarket. As presented in Rahnama et al. [2013], the following state space model describes the change in thermal energy:

$$\dot{x}_r(t) = A_r x_r(t) + B_r u_r(t) \quad (3)$$

$$A_r = -\frac{UA_{amb,cr}}{m_{food}c_{p,food}} \quad (4)$$

$$B_r = COP_r \quad (5)$$

where the state and input are defined as:

$$x_r(t) = m_{food}c_{p,food}(T_{cr,base} - T_{cr}) \quad (6)$$

$$u_r(t) = P_r(t) - P_{r,base} \quad (7)$$

$m_{food}$  and  $c_{p,food}$  are the mass and the specific heat capacity of refrigerated food.  $UA_{amb,cr}$  represents the heat transfer coefficient between the cold room and ambient and  $COP_r$  is the average coefficient of performance. Compressors in the supermarket need to consume  $P_{r,base} = \frac{UA_{amb,cr}}{COP_r}(T_{amb} - T_{cr,base})$  to keep the cold room temperature,  $T_{cr}$ , at the baseline temperature  $T_{cr,base}$ . This model is subject to the following constraints:

$$x_{r,min} \leq x_r(t) \leq x_{r,max} \quad (8)$$

$$P_{r,min} - P_{r,base} \leq u_r(t) \leq P_{r,max} - P_{r,base} \quad (9)$$

In a real supermarket, there are several cold rooms and display cases to store the refrigerated goods. Assume a single first-order model that describes the dynamic of a number of cold rooms in the supermarket:

$$\frac{x_r(s)}{u_r(s)} = \frac{K_p}{1 + T_p s} \quad (10)$$

The constant parameters,  $K_p$  and  $T_p$ , in Eq. (10) can not be found just by adding the individual models of each cold room. We therefore apply system identification to a verified and complicated model of an actual supermarket to identify the parameters.

In Rahnama et al. [2013], we modelled the ice storage as an energy integrator which starts to store energy when the input power is greater than a threshold power,  $P_{threshold}$ . The model describes the system where only one chiller is utilized to make ice and provide cooling to the building. However, using the same chiller for both charging and direct cooling is not optimal from an efficiency point of view. The reason is that the evaporator temperature and consequently the COP of the system, is much lower in charging mode compared to the direct cooling. This means the chiller needs to switch between two very different operating modes. In general, a chiller that is designed for one operating point is not optimal in any other point Wulfinghoff [1999]. One way to avoid this is to consider separate chillers for charging and direct cooling. Assuming two chillers, the following model is provided for the whole system:

$$\dot{x}_{ch}(t) = \begin{cases} B_{1,ch}u_{ch}(t) & u_{ch}(t) > 0 \\ B_{2,ch}u_{ch}(t) & u_{ch}(t) \leq 0 \end{cases} \quad (11)$$

$$B_{1,ch} = COP_{ch,ice} \quad (12)$$

$$B_{2,ch} = COP_{ch,cool} \quad (13)$$

where the state and input are defined as:

$$x_{ch}(t) = L(m_{ice} - m_{ice,base}) \quad (14)$$

$$u_{ch}(t) = P_{ch}(t) - P_{ch,base} \quad (15)$$

$m_{ice}$  and  $L$  are the mass of ice and the specific latent heat of water. Therefore, the system state,  $x_{ch}$ , simply indicates the thermal energy that is stored in the ice storage from when it is activated.  $m_{ice,base}$  is the mass of ice at the beginning of the activation. To satisfy the cooling load from the building,  $\dot{Q}_{cool}$ , the cooling chiller needs to consume  $P_{ch,base} = \frac{\dot{Q}_{cool}}{COP_{ch,cool}}$ . When the input power to the system is lower than the baseline power, part of the load should be provided by melting the ice. The second part in Eq. (11) describes this situation. When the input power is greater than the baseline power, the first part in Eq.(11) is valid, which means that extra power is used by the charging chiller to make ice. As for the supermarket model, this model is subject to the constraints:

$$x_{ch,min} \leq x_{ch}(t) \leq x_{ch,max} \quad (16)$$

$$P_{ch,min} - P_{ch,base} \leq u_{ch}(t) \leq P_{ch,max} - P_{ch,base} \quad (17)$$

The chiller model presented in Eqs. (11-15) is a mixed logical dynamical system. To solve the optimization problem (1), we convert the logical part into linear inequalities by applying the method proposed in Bemporad and Morari [1999]. Assume  $\delta$  is a binary variable such that:

$$\begin{cases} \delta(t) = 1 \iff u_{ch}(t) > 0 \\ \delta(t) = 0 \iff u_{ch}(t) \leq 0 \end{cases} \quad (18)$$

According to Bemporad and Morari [1999], Eq. (32) can be replaced by the following inequalities:

$$-(P_{ch,min} - P_{ch,base})\delta(t) \leq u_{ch}(t) - P_{ch,min} - P_{ch,base} \quad (19)$$

$$-(P_{ch,max} - P_{ch,base} + \epsilon)\delta(t) \leq -u_{ch}(t) - \epsilon \quad (20)$$

$\epsilon$  is a small positive scalar. Then the model (11-13) can be rewritten as below:

$$\dot{x}_{ch}(t) = B_{ch}u_{ch}(t) + D_{ch}z(t) \quad (21)$$

$$B_{ch} = COP_{ch,cool} \quad (22)$$

$$D_{ch} = COP_{ch,ice} - COP_{ch,cool} \quad (23)$$

$$z(t) = \delta(t)u_{ch}(t) \quad (24)$$

Finally, we can replace the Eq. (24) by the following inequalities:

$$z(t) \leq (P_{ch,max} - P_{ch,base})\delta(t) \quad (25)$$

$$z(t) \geq (P_{ch,min} - P_{ch,base})\delta(t) \quad (26)$$

$$z(t) \leq u_{ch}(t) - (P_{ch,min} - P_{ch,base})(1 - \delta(t)) \quad (27)$$

$$z(t) \geq u_{ch}(t) - (P_{ch,max} - P_{ch,base})(1 - \delta(t)) \quad (28)$$

According to the models we have presented, the off-time periods in Eq. (1) can be obtained as follows:

$$t_{r,off} = T_p \ln\left(1 + \frac{x_r(t_f + 1)}{(P_{r,base} - P_{r,min}) \times K_p}\right) \quad (29)$$

$$t_{ch,off} = \frac{x_{ch}(t_f + 1)}{(P_{ch,base} - P_{ch,min}) \times B_{ch}} \quad (30)$$

where  $x_r(t_f + 1)$  and  $x_{ch}(t_f + 1)$  represent the state of the charge of the cold room in supermarket and the ice storage at the end of the activation.  $t_f$  is the duration of the activation. Since the last input power is applied at  $t = t_f$ , we consider the state of the charge at  $t = t_f + 1$ .

### 2.3 Information Flow

As stated above, direct control is a two-way communication approach between the consumers and the aggregator. The aggregator needs to know the parameters and the constraints that describe the model of the consumers. This information is listed in table 1 and table 2. As soon as the aggregator is activated, each consumer should send and update the parameters and constraints whenever they change.

Table 1. Information flow-supermarket

Parameters	Description
$K_p, T_p$ [sec]	first-order model parameters
$P_{r,base}$ [kW]	baseline power
$x_{r,min}$ [kWh]	minimum thermal energy
$x_{r,max}$ [kWh]	maximum thermal energy
$P_{r,min}$ [kW]	minimum power
$P_{r,max}$ [kW]	maximum power

Table 2. Information flow-chiller

Parameters	Description
$COP_{ch,ice}$	average COP in charging mode
$COP_{ch,cool}$	average COP in direct cooling mode
$P_{ch,base}$ [kW]	baseline power
$x_{ch,min}$ [kWh]	minimum thermal energy
$x_{ch,max}$ [kWh]	maximum thermal energy
$P_{ch,min}$ [kW]	minimum power
$P_{ch,max}$ [kW]	maximum power

## 3. SUPERMARKET REFRIGERATION BENCHMARK

In this section, a CO<sub>2</sub> booster configuration of a typical supermarket refrigeration system is described. The system is equipped with a local MPC enabling the system to follow the assigned power references for smart grid services.

### 3.1 CO<sub>2</sub> Booster Refrigeration System

The basic layout of a typical refrigeration system including several cooling units with two racks of compressors in a booster configuration is shown in Fig. 2. Starting from the receiver (REC), two-phase refrigerant (mix of liquid and vapor) at point ‘8’ is split out into saturated liquid (‘1’) and saturated gas (‘1b’). The latter is bypassed by a bypass valve (BPV), and the former flows into expansion valves where the refrigerant pressure drops to medium (‘2’) and low (‘2’’) pressures. The electronic expansion valves EV\_MT and EV\_LT are responsible for regulating the air temperature inside the medium temperature (MT) and the low temperature (LT) cooling units, respectively, by controlling the entering mass flows into the evaporators. Flowing through medium and low temperature evaporators (EVAP\_MT and EVAP\_LT), the refrigerant absorbs heat from the cold reservoir. The pressure of low temperature units (LT) is increased by the low stage compressor rack (COMP\_LO). All mass flows from COMP\_LO, EVAP\_MT and BPV outlets are collected by a suction manifold at point ‘5’ where the pressure is increased again by high stage compressors (COMP\_HI). Afterward, the gas phase refrigerant enters the condenser to deliver the absorbed heat from cold reservoirs to the surrounding. The detailed dynamical model of the system is found in Shafiei et al. [2013].

### 3.2 Predictive Power Consumption Control

Here the utilized supermarket benchmark is equipped with a local MPC that can regulate the power consumption of the compressor racks to the assigned set-points. The objective function for power following is defined as:

$$J_P = \sum_{k=1}^N \|P_c[k] - P_{ref}[k]\|_2^2 \quad (31)$$

where  $P_{ref}$  is the power reference,  $k$  denotes the current time instant, and  $N$  is the prediction horizon in terms of the number of time steps (samples). Manipulated variables are the opening degrees of the expansion valves ( $OD$ ) and the evaporation temperature set-point ( $\hat{T}$ ). In the present work, for the sake of simplicity, we have considered a fixed evaporation temperature set-point.

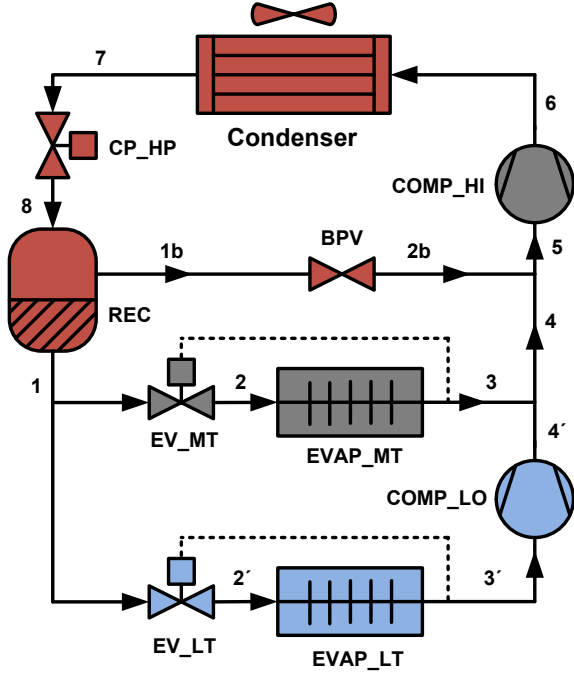

Fig. 2. Basic layout of a typical supermarket refrigeration system with booster configuration.

Looking at the compressor rack as a closed loop system controlling the evaporation temperature, it turns out that the power consumption ( $P_c$ ) is the nonlinear function of the evaporation temperature ( $T_e$ ); and the cooling capacity ( $\dot{Q}_e$ ) is also a nonlinear function of both the evaporation temperature and opening degree of expansion valves ( $OD$ ). In Shafiei et al. [2014] it is shown that how a convex optimization problem can be formulated by (i) introducing a fictitious manipulated variable; (ii) novel incorporation of  $T_e$  into the MPC scheme; and (iii) choosing appropriate sampling time and prediction horizon. Fig. 3 shows how the predictive controller is able to follow a power reference even with a dramatic magnitude changes for energy balancing services.

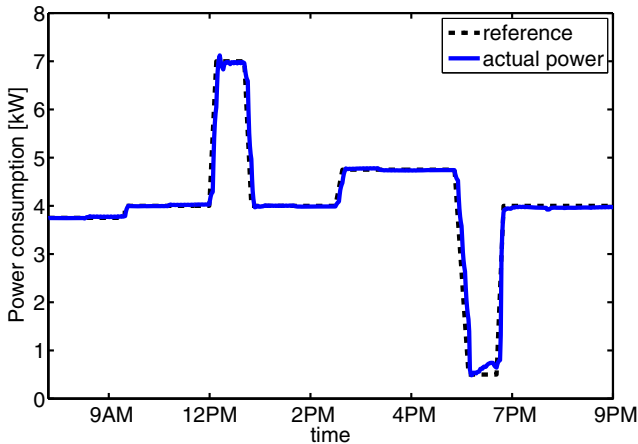

Fig. 3. Power following performance of the supermarket refrigeration system for energy imbalance management.

Note again, however, that this level of fidelity is *not* available at the aggregator level. As discussed earlier, the

aggregator uses a simplified model of the supermarket's power consumption and energy storage.

#### 4. SIMULATION RESULTS

As we stated in Eq. (1), energy saving after the activation can be acquired from  $\Sigma(P_{base} - P_{min}) \times t_{off}$ . In fact, the energy saving represents the profit attained by the aggregator. Due to mismatch between the simple and complex model, there will be discrepancy between the actual and estimated profit. To evaluate the aggregator against the verified model of supermarket that was described in section 3, we will compare the actual profit with the estimated profit. In this way, we will understand how accurate the proposed business model is in estimating the actual profit.

Numerical values for the parameters listed in table 1 and table 2 are as follows:  $P_{r,min} = P_{ch,min} = 0$ ,  $P_{r,max} = 11.6$ ,  $P_{ch,max} = 10$ ,  $P_{r,base} = 4.1$ ,  $P_{ch,base} = 2.5$ ,  $x_{r,min} = x_{ch,min} = 0$ ,  $x_{r,max} = 47$ ,  $x_{ch,max} = 23.2$ ,  $K_p = 70$ ,  $T_p = 140$ ,  $COP_{ch,ice} = 2.2$  and  $COP_{ch,cool} = 4$ . The supermarket consists of seven medium temperature and four low temperature cold rooms with temperature limits [ $1^\circ C, 5^\circ C$ ] and [ $-24^\circ C, -18^\circ C$ ] respectively.

The aggregator distributes power references every minute during the one hour activation time. After the activation, the local MPC at the supermarket will receive power references in the following way:

$$\begin{cases} P_r(t) = P_{r,min} & x_r(t) > X_r \\ P_r(t) = \alpha P_{r,base} & x_r(t) \leq X_r \end{cases} \quad (32)$$

where  $\alpha$  is a constant value close to one. The supermarket will consume its minimum power as long as the stored energy reaches a certain value close to zero ( $X_r$ ). To retrieve the remaining energy, the supermarket will then keep its consumption at a level a bit below the baseline. Afterwards, it will consume its baseline consumption. This strategy minimizes the time needed for regaining the stored energy and consequently minimizes the heat loss to the surrounding. The constant values,  $\alpha$  and  $X_r$ , are considered to ensure the temperature constraints will not be violated at the supermarket. A simple local controller can handle the time after the activation since the aggregator does not know the actual energy level.

Fig. 4 shows the power distribution among the supermarket and chiller for three different values of  $P_{reference}$ . For low power reference ( $P_{reference} = 8kW$ ), the aggregator dedicates the extra power to the supermarket exclusively. The chiller consumes its baseline in this case. From the figure, we can see the utilization of chiller increases with the increase of power reference. For  $P_{reference} = 15$  &  $18kW$ , the chiller consumes its maximum power in the beginning and the rest of power is dedicated to the supermarket. After a while, the aggregator switches to the supermarket. We can also see the switching time is becoming closer to the end of activation as the power increases. This is due to the different nature of the two thermal storages. The supermarket is a high-COP unit compared to the chiller. However, it has heat loss to the surrounding, whereas the chiller is a low-COP unit without loss. For low power reference, the aggregator prefers to use the supermarket since the heat loss is not significant for small deviation from the baseline. However, heat loss increases as the

power increases. Therefore, the aggregator starts to use the chiller. On the other hand, keeping the cold rooms at a low temperature in the supermarket is accompanied with heat loss. That is why the supermarket is utilized at the end of activation.

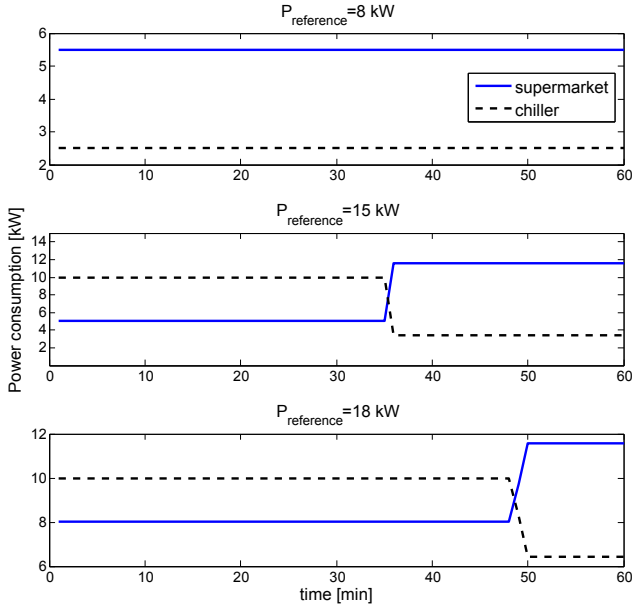

Fig. 4. Power distribution from the aggregator to the consumers during a one-hour activation time

Actual power consumption of the supermarket during the activation is shown in Fig. 5. Double-sided arrows indicate the activation time when the supermarket is asked to follow the power reference. After the activation, the supermarket does not need to follow the reference. As we stated before, zero power is just distributed to deplete the storage as fast as possible. It is shown the supermarket can follow the power reference in a good way, although there is a delay in response to power changing. This delay is due to the different sampling times of the aggregator and the supermarket. Fig. 6 shows the temperature variation of different cold rooms at the supermarket after the activation. As we can see, medium temperature cold rooms are exploited more than the low temperature. The reason is the lower loss because of the lower temperature difference between the ambient and the medium temperature cold rooms.

The actual and estimated profit in terms of energy saving after the activation for the power references from  $8 \text{ kW}$  to  $20 \text{ kW}$  are shown in Fig. 7. The estimated profit is obtained from the optimization shown in (1) whereas, for the actual profit, we consider the actual energy regained after the activation at the supermarket. For all power references, the actual profit is greater than the estimated profit, however for high power references, the discrepancy between the actual and estimated profit is higher. This is not unexpected. In the simple model of supermarket, we assume the COP to be constant. This assumption is no longer valid when the power consumption increases. The average difference between the actual and estimated profit is 11.2%.

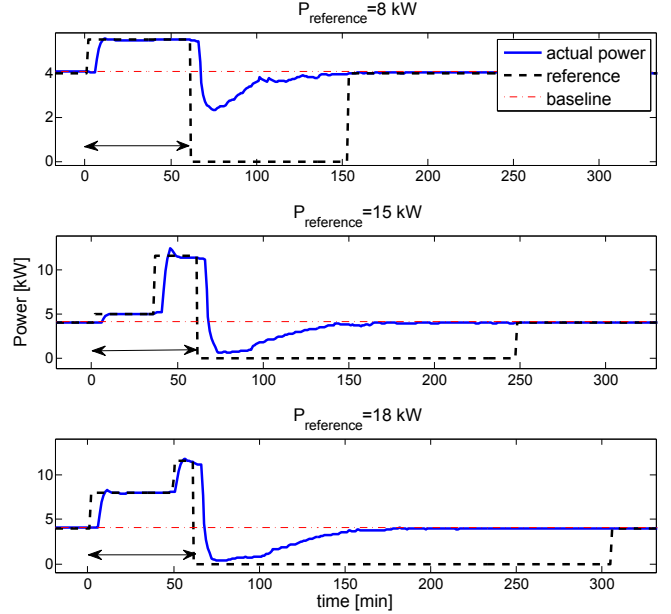

Fig. 5. Actual power consumption of the supermarket for different power references - double sided arrows indicate the activation time.

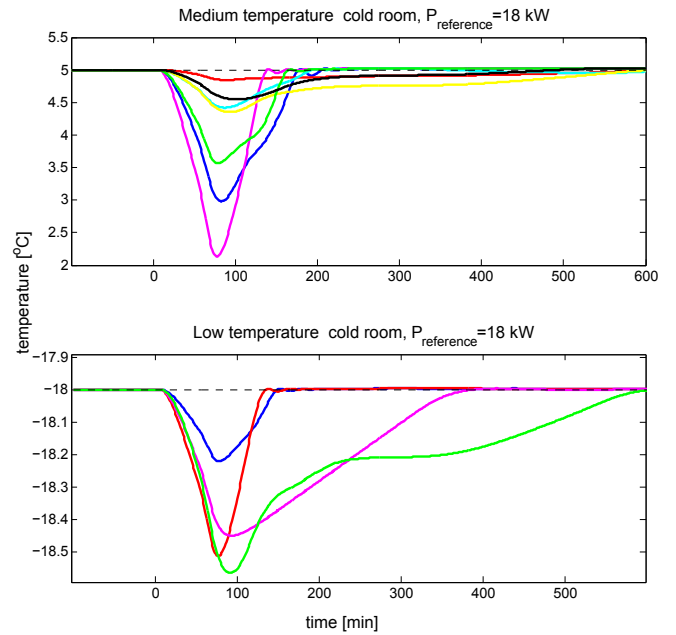

Fig. 6. Temperature variation of cold rooms at the supermarket after the activation.

## 5. CONCLUSION AND FUTURE WORK

In this paper, we first introduced a business model for the aggregator in the direct setup. The business model is specified with three items which are the optimization problem, model of the consumers and the information flow between the aggregator and the consumers. We chose the supermarket refrigeration system and the chiller with ice storage as our case studies. Thereafter, we evaluated the aggregator against a verified model of an actual supermarket in terms of maximizing the profit of the aggregator. Simulation results showed there is a 11.2% difference between the estimated profit obtained from the optimization



problem with the simple model of the consumers and the actual profit. Moreover, we saw that the actual supermarket is able to satisfy the aggregator's objective in terms of following a specified power reference.

To improve the performance of the aggregator, we have the following suggestions. As we saw in Fig. 5, there is a delay in response to power changing at the supermarket. One solution to alleviate this is to include the delay in modelling of the supermarket refrigeration system. Another suggestion is to update the information flow during the activation. We cannot model all the operating points of supermarket with a first order model. For instance, the COP of the system varies significantly for large variation of power consumption. In a real setup, the supermarket might be able to update the model parameters at some points during the activation. This will decrease the difference between the actual and estimated profit.

The results shown here evaluate a distribution obtained from an optimization based on two simple models of supermarket and chiller against a verified model of the supermarket and a simple model of the chiller. However, if we have a verified model of the chiller as well, a comprehensive scenario for evaluation can be considered. In this case, we investigate if there is other power distribution between the consumers which leads to higher profit in practice. The authors have studied the nature of profit curves for different switching strategies between the supermarket and chiller. Those turned out to be very 'flat' close to the optimum. The authors take this to be evidence for the following conjecture: The discrepancy between the estimated and actual profit could be very small if we evaluate the aggregator against the two verified models of supermarket and chiller. Thus, if this conjecture holds then the business model of the aggregator approach could be much less uncertain than indicated by Fig. 7. In future work, we intend to evaluate this conjecture.

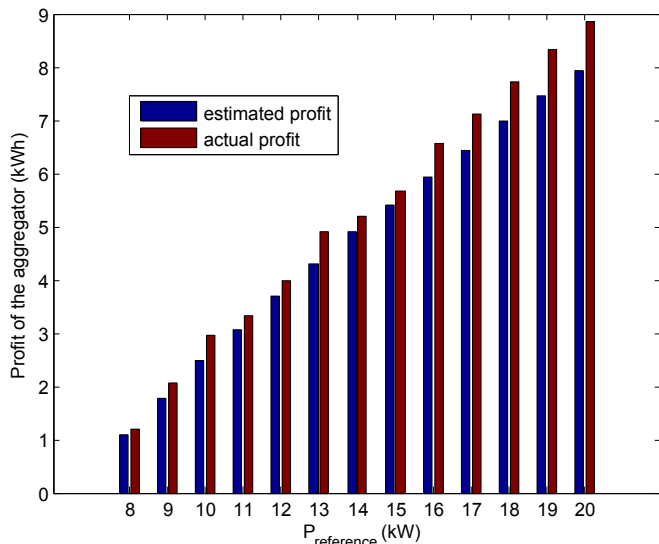

Fig. 7. Profit of the aggregator in terms of energy saving after the activation.

## REFERENCES

A. Bemporad and M. Morari. Control of systems integrating logic, dynamics, and constraints. *Automatica*, 35:

- 407–427, 1999.
- H. Chen, A. K. Coskun, and M. C. Caramanis. Real-time power control of data centers for providing regulation service. In *2013 IEEE Conference on Decision and Control*, Florence, Italy, 2013.
- O. Corradi, H. Ochsenfeld, H. Madsen, and P. Pinson. Controlling electricity consumption by forecasting its response to varying prices. *IEEE Transactions on Power Systems*, 28(1):421–429, 2013.
- L. Gkatzikis, I. Koutsopoulos, and T. Salonidis. The role of aggregators in smart grid demand response markets. *IEEE Journal on Selected Areas in Communications*, 31(7):1247–1257, 2013.
- A. C. Kizilkale and R. P. Malhame. Mean field based control of power system dispersed energy storage devices for peak load relief. In *2013 IEEE Conference on Decision and Control*, Florence, Italy, 2013.
- A. M. Kosek, G. T. Costanzo, H. W. Bindner, and O. Gehrke. An overview of demand side management control schemes for buildings in smart grids. In *IEEE International Conference on Smart Energy Grid Engineering (SEGE'13)*, Portland, Oregon, USA, 2013.
- A. Nayyar, J. Taylor, A. Subramanian, K. Poolla, and P. Varaiya. Aggregate flexibility of a collection of loads. In *2013 IEEE Conference on Decision and Control*, Florence, Italy, 2013.
- I. Ch. Paschalidis, B. Li, and M. C. Caramanis. Demand-side management for regulation service provisioning through internal pricing. *IEEE Transactions on Power Systems*, 27(3):1531–1539, 2012.
- M. K. Petersen, K. Edlund, L. H. Hansen, J. D. Bendtsen, and J. Stoustrup. A taxonomy for flexibility modeling and a computationally efficient algorithm for dispatch in smart grids. In *Proceedings of the 2013 American Control Conference*, Washington, DC, USA, June 2013.
- S. Rahnama, J. Stoustrup, and H. Rasmussen. Integration of heterogeneous industrial consumers to provide regulating power to the smart grid. In *2013 IEEE Conference on Decision and Control*, Florence, Italy, 2013.
- S. E. Shafiei, H. Rasmussen, and J. Stoustrup. Modeling supermarket refrigeration systems for demand-side management. *Energies*, 6(2):900–920, 2013.
- S. E. Shafiei, J. Stoustrup, and H. Rasmussen. Model predictive control for flexible power consumption of large-scale refrigeration systems. In *Submitted to the 2014 American Control Conference*, Portland, Oregon, USA, June 2014.
- D.R. Wulfinghoff. Measure 2.11.1 install cooling thermal storage. Technical report, Energy Efficiency Manual-Chapter 2 Chiller Plant, 1999.
- S. You, C. Traeholt, and B. Poulsen. Generic virtual power plants: Management of distributed energy resources under liberalized electricity market. In *8th International Conference on Advances in Power System Control, Operation and Management*, Hong Kong, China, 2009.
- B. Zhang and J. Baillieul. A two level feedback system design to provide regulation reserve. In *2013 IEEE Conference on Decision and Control*, Florence, Italy, 2013.