



AALBORG UNIVERSITY
DENMARK

Aalborg Universitet

Multi-Operation Management of a Typical Micro Grid Using Particle Swarm Optimization: A Comparative Study

Anvari-Moghaddam, Amjad; Seifi, Alireza; Niknam, Taher

Published in:
Renewable & Sustainable Energy Reviews

Publication date:
2012

[Link to publication from Aalborg University](#)

Citation for published version (APA):

Anvari-Moghaddam, A., Seifi, A., & Niknam, T. (2012). Multi-Operation Management of a Typical Micro Grid Using Particle Swarm Optimization: A Comparative Study. *Renewable & Sustainable Energy Reviews*, 16(2), 1268 – 1281.

General rights

Copyright and moral rights for the publications made accessible in the public portal are retained by the authors and/or other copyright owners and it is a condition of accessing publications that users recognise and abide by the legal requirements associated with these rights.

- Users may download and print one copy of any publication from the public portal for the purpose of private study or research.
- You may not further distribute the material or use it for any profit-making activity or commercial gain
- You may freely distribute the URL identifying the publication in the public portal -

Take down policy

If you believe that this document breaches copyright please contact us at vbn@aub.aau.dk providing details, and we will remove access to the work immediately and investigate your claim.



Multi-operation management of a typical micro-grids using Particle Swarm Optimization: A comparative study

Amjad Anvari Moghaddam^a, Alireza Seifi^a, Taher Niknam^{b,*}

^a Department of Power & Control, Shiraz University, Shiraz, Iran

^b Department of Electrical and Electronics Engineering, Shiraz University of Technology, Shiraz, Iran

ARTICLE INFO

Article history:

Received 1 February 2011

Accepted 3 October 2011

Available online 9 November 2011

Keywords:

Particle Swarm Optimization

Multi-operation planning

Energy management

Micro-grid

ABSTRACT

Nowadays, it becomes the head of concern for many modern power grids and energy management systems to derive an optimal operational planning with regard to energy costs minimization, pollutant emissions reduction and better utilization of renewable resources of energy such as wind and solar. Considering all the above objectives in a unified problem provides the desired optimal solution. In this paper, a Fuzzy Self Adaptive Particle Swarm Optimization (FSAPSO) algorithm is proposed and implemented to dispatch the generations in a typical micro-grid considering economy and emission as competitive objectives. The problem is formulated as a nonlinear constraint multi-objective optimization problem with different equality and inequality constraints to minimize the total operating cost of the micro-grid considering environmental issues at the same time. The superior performance of the proposed algorithm is shown in comparison with those of other evolutionary optimization methods such as conventional PSO and genetic algorithm (GA) and its efficiency is verified over the test cases consequently.

© 2011 Elsevier Ltd. All rights reserved.

Contents

1. Introduction	1269
2. Operation management of a micro-grid considering environmental/economic objectives	1270
2.1. Objective functions	1270
2.1.1. Objective 1: minimization of the total operating cost in the micro-grid	1270
2.1.2. Objective 2: minimization of the total pollutants emissions in the micro-grid	1270
2.2. Constraints	1271
2.2.1. Load balance	1271
2.2.2. Active power constraints of units	1271
2.2.3. Charge and discharge rate limits of storage devices	1271
3. Micro-grid modeling	1271
4. Principles of multi-objective optimization and PSO algorithm	1271
5. Fuzzy Self Adaptive PSO (FSAPSO)	1272
5.1. Fuzzification	1273
5.2. Fuzzy rules	1273
5.3. Defuzzification	1273
6. Implementation of FSAPSO to multi-operation management problem	1273
7. Simulation results	1274
7.1. First scenario (main case)	1276
7.2. Second scenario (Max-Ren.)	1278
7.3. Third scenario (WLE)	1279
8. Conclusion	1281
References	1281

* Corresponding author at: Department of Power & Control, School of Electrical and Computer Engineering, Shiraz University, Engineering Faculty No. 1, Zand St. Shiraz, Iran. Tel.: +98 711 2337852; fax: +98 711 6473575.

E-mail addresses: am.anvari@ieee.org (A.A. Moghaddam), seifi@shirazu.ac.ir (A. Seifi), niknam@sutech.ac.ir (T. Niknam).

Nomenclature

<i>ECS</i>	energy conversion system
<i>DER</i>	distributed energy resource
<i>T</i>	total number of hours
N_g	total number of generation units
N_s	total number of storage units
N_k	total number of load levels
$u_i(t)$	status of unit <i>i</i> at hour <i>t</i>
$P_{Gi}(t)$	active power output of <i>i</i> th generator at time <i>t</i>
$P_{Sj}(t)$	active power output of <i>j</i> th storage at time <i>t</i>
$P_{Grid}(t)$	active power bought/sold from/to the utility at time <i>t</i>
$B_{Gi}(t)$	bid of the <i>i</i> th DG source at hour <i>t</i>
$B_{Sj}(t)$	bid of the <i>j</i> th storage options at hour <i>t</i>
$B_{Grid}(t)$	bid of utility at hour <i>t</i>
S_{Gi}	start up/shut-down costs for <i>i</i> th DG unit
S_{Sj}	start up/shut-down costs for <i>j</i> th storage device
$E_{Gi}(t)$	emissions in kg/MWh for <i>i</i> th DG unit at hour <i>t</i>
$E_{Sj}(t)$	emissions in kg/MWh for <i>j</i> th storage device at hour <i>t</i>
$E_{Grid}(t)$	emissions in kg/MWh for utility at hour <i>t</i>
$CO_{2DC_i}(t)$	carbon dioxide pollutants of <i>i</i> th DG unit at hour <i>t</i>
$SO_{2DG_i}(t)$	sulphur dioxide pollutants of <i>i</i> th DG unit at hour <i>t</i>
$NO_{xDG_i}(t)$	nitrogen oxide pollutants of <i>i</i> th DG unit at hour <i>t</i>
$CO_{2Storage_j}(t)$	carbon dioxide pollutants of <i>j</i> th storage device at hour <i>t</i>
$SO_{2Storage_j}(t)$	sulphur dioxide pollutants of <i>j</i> th storage device at hour <i>t</i>
$NO_{2Storage_j}(t)$	nitrogen oxide pollutants of <i>j</i> th storage device at hour <i>t</i>
$CO_{2Grid}(t)$	carbon dioxide pollutants of utility at hour <i>t</i>
$SO_{2Grid}(t)$	sulphur dioxide pollutants of utility at hour <i>t</i>
$NO_{xGrid}(t)$	nitrogen oxide pollutants of utility at hour <i>t</i>
P_{Lk}	the amount of <i>k</i> th load level
$P_{G,min}(t)$	minimum active power production of <i>i</i> th DG at hour <i>t</i>
$P_{s,min}(t)$	minimum active power production of <i>j</i> th storage at hour <i>t</i>
$P_{grid,min}(t)$	minimum active power production of the utility at hour <i>t</i>
$P_{G,max}(t)$	maximum active power production of <i>i</i> th DG at hour <i>t</i>
$P_{s,max}(t)$	maximum active power production of <i>j</i> th storage at hour <i>t</i>
$P_{grid,max}(t)$	maximum active power production of the utility at hour <i>t</i>
$W_{ess,t}$	battery energy storage at time <i>t</i>
$P_{charge}/P_{discharge}$	permitted rate of charge/discharge through a definite period of time
$\eta_{charge}/\eta_{discharge}$	charge/discharge efficiency of the battery
$W_{ess,min}/W_{ess,max}$	lower/upper bounds on battery energy storage
$P_{charge,max}/P_{discharge,max}$	maximum rate of charge/discharge during each time interval
ω	inertia weight
c_1 and c_2	weighting factors of the stochastic acceleration terms (learning factors)
$rand(\cdot)$	random function in the range of [0,1]
$P_{best,i}$	best previous experience of the <i>i</i> th particle that is recorded
G_{best}	best particle among the entire population
F	vector of objective functions

X	vector of the optimization variables
$f_i(X)$	<i>i</i> th objective function
$g_i(X)$	equality constraints of <i>i</i> th objective function
$h_i(X)$	inequality constraints of <i>i</i> th objective function
\vec{v}_i^{k+1}	updated velocity vector of <i>i</i> th particle
\vec{x}_i^{k+1}	updated position of <i>i</i> th particle
$\Delta\omega$	weight correction value
<i>NBF</i>	normalized best fitness
BF_{min}	minimum fitness value
BF_{max}	maximum fitness value

1. Introduction

In recent times new trends in power systems are conducted towards distributed generation (DG), which means that energy conversion systems (ECSs) are situated close to energy consumers and large units are substituted by smaller ones. On the other hand, for the consumer the potential lower cost, higher service reliability, higher power quality, increased energy efficiency, and energy independence are all reasons for interest in DGs. The use of renewable resources of energy or green powers such as wind and solar can also provide significant environmental benefits [1–3]. In this regard, micro-grid (MG) is a concept which provides an effective means to integrating small-scale DGs into the bulk electric grid and provides the needs of future power grids [4–6]. As a whole, a micro power grid is defined as an aggregation of electrical loads and DGs (mainly renewable resources such as wind and solar) along with the storage options operating as a single system providing both power and heat. It seems that energy management systems and power system optimizers accompanied by integration of new generation resources which form a whole micro-grid vision, have the capability of serving as a basic tool to reach energy independence and climate changes objectives. Additionally, with low incorporation of renewable energy sources the total effect on grid operation is confined, but as their penetrations are augmented their mutual effects increase too [7]. Considering all the points mentioned before, it can be easily concluded that there is an urgent need for more precise scheduling of energy sources in a micro-grid that is helpful for improvement of a power system operation and its behavior both in economy and emission which in turn necessitates the development of more trusted methods of optimization.

Generally, most previous optimization algorithms and optimal power dispatch programs dealt with the case of single objective. These algorithms were faced with the problem of deciding the most economical units to dispatch. For example Boqiang and Chuanwen [8] proposed a hierarchical approach for economic dispatch while considering risk management in the power market. Farag et al. [9] proposed a linear programming based optimization procedure where one objective was considered at any time. Park et al. [10] implemented neural networks and used a Hopfield algorithm to treat the economic dispatch problems with PQCF. Lee et al. [11] also developed a Revised Adaptive Hopfield Neural Network (RAHNN) scheme to deal with this problem. A model for economic dispatch of combined cycle cogeneration units based on nonlinear programming was developed in [12] with regard to environmental constraints. Likewise, evolutionary programming techniques were also applied to solve such kind of problems [13,14]. Later on, researchers tried to minimize or maximize a single objective function using evolutionary optimization models e.g., a Particle Swarm Optimization (PSO) approach was deployed by Gaing [15] to implement the economic dispatch of units considering their related constraints. Recently, combined economic/environmental

dispatch (CEED) is proposed as a practical solution to operation management problem because a multi-objective optimizer is able to reduce the pollutant emissions with lower operating cost. From this point of view, an optimized power system with respect to several criteria under a group of unavoidable constraints can behave in an economic manner while incurring less environmental footprints. Nowadays, various optimization techniques are implemented to handle the optimal operation management problem in a more efficient way [16–20]. As examples, optimal design methodologies under the carbon emission using meta-heuristic techniques were proposed by Sadegheih [17]. Similarly, Song et al. [20] developed an adaptive genetic algorithm in which parameters are adjusted during fuzzy logic operations. Besides, an improved decision making tree was used in [21] to solve an EED problem. Afterwards, Dhillon et al. [22] proposed a stochastic approach to deal with the EED problem considering uncertainties. Venkatesh et al. [23] did a comprehensive study about evolutionary programming such as GA and Ant Colony Optimization (ACO) in solving EED and related results were compared regarding best solutions. Different multi-objective evolutionary approaches for electric power dispatching were also reported in [24,25]. Hota and Dash [26] take advantage of neural-fuzzy techniques for finding a solution to multi-objective generation dispatch problem.

Among the previously mentioned optimization methods, PSO has been significantly used in optimal operation management problem mainly due to its population-based search capability as well as simplicity, convergence speed, and robustness [27–29], although it's worthy of note that the performance of a conventional PSO algorithm greatly depends upon its learning and weighting factors and it may face the problem of being trapped in local optima. In this paper an expert PSO algorithm is proposed and implemented to solve the multi-operation management problem. In this regard, it's tried to find an optimal scheduling for multi-operation of a micro-grid considering minimum levels of operating cost and emission inside the grid simultaneously. To overcome the local optima problem from one side and to improve the approach performance from the other side a Fuzzy Self Adaptive (FSA) approach is adopted subsequently.

The rest of the paper is organized as follows: Section 2 formulates the multi-objective operation management problem. The whole vision of a micro-grid along with the bunch of micro sources is presented in Section 3. Section 4 describes the fundamentals of multi-objective optimization as well as a PSO algorithm. The proposed FSAPSO algorithm is discussed in Section 5. Section 6 deals with the implementation of the proposed FSAPSO algorithm to the optimal operation management problem. Finally, in Section 7, superior performance of the proposed method and its great feasibility is demonstrated and compared to those from other evolutionary-based optimization approaches such as GA and standard PSO.

2. Operation management of a micro-grid considering environmental/economic objectives

The optimal environmental/economic power dispatch and operation management problem in a typical micro-grid can be formulated as a multi-objective optimization model. During the procedure, the two opposing objectives which are the total operating cost of the micro-grid and the pollutants emission should be minimized at the same time while satisfying system constraints. The mathematical model of such problem can be expressed as follows.

2.1. Objective functions

2.1.1. Objective 1: minimization of the total operating cost in the micro-grid

The total operating cost of the micro-grid includes the fuel costs of the units as well as their start-up/shut-down costs. The output of this section is a set of optimal power flows for a definite period of time from energy sources to load centers in an economical manner. In addition to DGs, storage options are also used to offset expensive energy purchases from utility or to store energy during off-peak hours for an anticipated price spike. The first objective function can be formulated as below:

$$\begin{aligned} \text{Min } f_1(X) &= \sum_{t=1}^T \text{Cost}^t \\ &= \sum_{t=1}^T \left\{ \sum_{i=1}^{N_g} [u_i(t)P_{Gi}(t)B_{Gi}(t) + S_{Gi}|u_i(t) - u_i(t-1)|] \right. \\ &\quad \left. + \sum_{j=1}^{N_s} [u_j(t)P_{Sj}(t)B_{Sj}(t) + S_{Sj}|u_j(t) - u_j(t-1)|] + P_{Grid}(t)B_{Grid}(t) \right\} \end{aligned} \quad (1)$$

where $B_{Gi}(t)$ and $B_{Sj}(t)$ are the bids of the DG sources and storage options at hour t , S_{Gi} and S_{Sj} are the start-up or shut-down costs for i th DG and j th storage device respectively, $P_{Grid}(t)$ is the active power which is bought or sold from or to the utility at time t and $B_{Grid}(t)$ is the bid of utility at t . X is the vector of state variables which includes active powers of units and their related states and is described as follows:

$$\begin{aligned} X &= [P_g, U_g]_{1 \times 2nT} \\ P_g &= [P_G, P_s] \\ n &= N_g + N_s + 1 \end{aligned} \quad (2)$$

where T is the total number of hours in the examined period of time, n is the number of state variables, N_g is the total number of DGs, N_s is the total number of storage units, P_g is the active power of all DG units and U_g is the state vector denoting the on or off states for all units during each hour of the day. These variables can be described as follows:

$$\begin{aligned} P_G &= [P_{G1}, P_{G2}, \dots, P_{G,N_g}] \\ P_{Gi} &= [P_{Gi}(1), P_{Gi}(2), \dots, P_{Gi}(t), \dots, P_{Gi}(T)]; \quad i = 1, 2, \dots, N_g + 1 \\ P_s &= [P_{s1}, P_{s2}, \dots, P_{s,N_s}] \\ P_{Sj} &= [P_{Sj}(1), P_{Sj}(2), \dots, P_{Sj}(t), \dots, P_{Sj}(T)]; \quad j = 1, 2, \dots, N_s \end{aligned} \quad (3)$$

where, $P_{Gi}(t)$ and $P_{Sj}(t)$ are the power outputs of i th generator and j th storage at time t respectively.

$$\begin{aligned} U_g &= [u_1, u_2, \dots, u_n] = \{u_i\}_{1 \times n} \in \{0, 1\}; \\ u_k &= [u_k(1), u_k(2), \dots, u_k(t), \dots, u_k(T)]; \quad k = 1, 2, \dots, n \end{aligned} \quad (4)$$

where $u_k(t)$ is the status of unit k at hour t .

2.1.2. Objective 2: minimization of the total pollutants emissions in the micro-grid

To consider the environmental effect of pollutants emissions as the second objective three of the most important emissions are involved in the optimization problem: carbon dioxide (CO_2), sulphur dioxide (SO_2) and nitrogen oxides (NO_x). Besides, to present a model shows such effects, mathematical functions that associate emissions with power production of different DG units can

be applied; similar to those used for economic dispatch. As a whole the second objective can be described as follows:

$$\text{Min } f_2(X) = \sum_{t=1}^T \text{Emission}^t = \sum_{t=1}^T \left\{ \sum_{i=1}^{N_g} [u_i(t)P_{Gi}(t)E_{Gi}(t)] + \sum_{j=1}^{N_s} [u_j(t)P_{sj}(t)E_{sj}(t)] + P_{Grid}(t)E_{Grid}(t) \right\} \quad (5)$$

where all the above parameters are defined as before and $E_{Gi}(t)$, $E_{sj}(t)$ and $E_{Grid}(t)$ are described as the amount of emissions in kg/MWh for each DG, storage unit and the utility at hour t respectively. These variables are expressed as follows:

$$E_{Gi}(t) = \text{CO}_{2DG_i}(t) + \text{SO}_{2DG_i}(t) + \text{NO}_{xDG_i}(t) \quad (6)$$

where $\text{CO}_{2DG_i}(t)$, $\text{SO}_{2DG_i}(t)$ and $\text{NO}_{xDG_i}(t)$ are the amounts of carbon dioxide, sulphur dioxide and nitrogen oxides emissions from i th DG unit at hour t , respectively.

$$E_{sj}(t) = \text{CO}_{2ndorage_j}(t) + \text{SO}_{2ndorage_j}(t) + \text{NO}_{xStorage_j}(t) \quad (7)$$

where $\text{CO}_{2Storage_j}(t)$, $\text{SO}_{2Storage_j}(t)$ and $\text{NO}_x(t)$ are the amounts of carbon dioxide, sulphur dioxide and nitrogen oxides emissions from j th storage unit during t th hours of the day, respectively.

$$E_{Grid}(t) = \text{CO}_{2Grid}(t) + \text{SO}_{2Grid}(t) + \text{NO}_{xGrid}(t) \quad (8)$$

where $\text{CO}_{2Grid}(t)$, $\text{SO}_{2Grid}(t)$ and $\text{NO}_{xGrid}(t)$ are the amounts of carbon dioxide, sulphur dioxide and nitrogen oxides emissions from the utility or the macro grid in hour t , respectively.

2.2. Constraints

2.2.1. Load balance

To manage a power system operation the basic constraint is to satisfy the load using available generations. Therefore the active power balance of the micro-grid is formulated as below:

$$\sum_{i=1}^{N_g} P_{Gi}(t) + \sum_{j=1}^{N_s} P_{sj}(t) + P_{Grid}(t) = \sum_{k=1}^{N_k} P_{Lk}(t) \quad (9)$$

where P_{Lk} is the amount of k th load and N_k is the total number of load levels.

2.2.2. Active power constraints of units

$$\begin{aligned} P_{Gi,\min}(t) &\leq P_{Gi}(t) \leq P_{Gi,\max}(t) \\ P_{sj,\min}(t) &\leq P_{sj}(t) \leq P_{sj,\max}(t) \\ P_{grid,\min}(t) &\leq P_{Grid}(t) \leq P_{grid,\max}(t) \end{aligned} \quad (10)$$

where $P_{G,\min}(t)$, $P_{s,\min}(t)$ and $P_{grid,\min}(t)$ are the minimum active powers of i th DG, j th storage and the utility at time t . In a similar manner, $P_{G,\max}(t)$, $P_{s,\max}(t)$ and $P_{grid,\max}(t)$ are the maximum power productions of corresponding units at hour t .

2.2.3. Charge and discharge rate limits of storage devices

Due to limitation on charge and discharge rate of storage devices during each time interval the following equation and constraint can be written:

$$W_{ess,t} = W_{ess,t-1} + \eta_{\text{charge}} P_{\text{charge}} \Delta t - \frac{1}{\eta_{\text{discharge}}} P_{\text{discharge}} \Delta t \quad (11)$$

$$\begin{cases} W_{ess,\min} \leq W_{ess,t} \leq W_{ess,\max} \\ P_{\text{charge},t} \leq P_{\text{charge},\max}; \quad P_{\text{discharge},t} \leq P_{\text{discharge},\max} \end{cases} \quad (12)$$

where $W_{ess,t}$ and $W_{ess,t-1}$ are the amounts of energy storage inside the battery at hour t and $t-1$ respectively, P_{charge} and

$P_{\text{discharge}}$ are the permitted rates of charge and discharge through a definite period of time (Δt), η_{charge} and $\eta_{\text{discharge}}$ are the charge and discharge efficiency of the battery. $W_{ess,\min}$ and $W_{ess,\max}$ are the minimum and maximum limits on battery energy storage while $P_{\text{charge},\max}$ and $P_{\text{discharge},\max}$ are the maximum rates of charge or discharge during each interval Δt .

3. Micro-grid modeling

Application of individual DGs can create many problems as it may solve, so a better way to realize the emerging potential of DGs is to take a system approach which views generation and associated loads as a subsystem or a micro-grid. On the other hand, by aggregation of DGs in a micro-grid and exploitation of renewable energies in bulk amount related issues on economy, technology and environment can be studied carefully within the target system and appropriate decisions can be made for better management of its operation. Moreover, distributed generation encompasses a wide range of prime mover technologies, such as internal combustion (IC) engines, gas turbines, micro turbines, photovoltaic, fuel cells and wind power. These emerging technologies have lower emissions and the potential to have lower cost negating traditional economies of scale [30]. For example Fuel cells, which produce electricity from hydrogen and oxygen, emit only water vapor, although during the reformation of natural gas or other fuels, some NO_x and CO_2 emissions are produced. Generally, fuel cells are more efficient than micro turbines with low emissions but are currently expensive. In this paper a typical LV micro-grid has been considered as shown in Fig. 1 including various DGs such as micro turbine (MT), a low temperature fuel cell (PAFC), photovoltaic (PV), wind turbine (WT) and storage devices like lead acid batteries. It is assumed that all DG sources produce active power at unity power factor, neither requesting nor producing reactive power. There is also a power exchange link between the mentioned micro-grid and the utility (LV network) used for energy trading during different hours of a day based on decisions made by micro-grid central controller (MGCC).

4. Principles of multi-objective optimization and PSO algorithm

Many real-world search and optimization problems include several objectives required to be optimized at the same time; a set of objectives that may carry conflicting goals or even incomparable applications. To address such problems towards optimal situations and goals, multi-objective optimization can be applied usefully to result a set of optimal answers [31,32]. Generally, a multi-objective optimization problem includes a set of objectives along with a number of equality and inequality constraints that should be optimized concurrently as stated in Eq. (13):

$$\begin{aligned} \text{Minimize } F &= [f_1(X), f_2(X), \dots, f_m(X)]^T \\ \text{Subject to : } &\begin{cases} g_i(X) < 0 & i = 1, 2, \dots, N_{ueq} \\ h_i(X) = 0 & i = 1, 2, \dots, N_{eq} \end{cases} \end{aligned} \quad (13)$$

where, F is a vector of objective functions and X is the vector of the optimization variables, $f_i(X)$ is the i th objective function, $g_i(X)$ and $h_i(X)$ are the equality and inequality constraints, respectively and m is the number of objective functions.

Among the optimization methods mentioned earlier, PSO has been significantly used in multi-objective problems mainly due to its population-based search capability as well as simplicity, convergence speed, and robustness. It was first introduced by Kennedy and Eberhart [33,34] and was based upon the imitation of animals' social behaviors using tools and ideas taken from computer graphics and social psychology research. Usually, PSO simulates the behaviors of a flock of bird called "swarm" in which

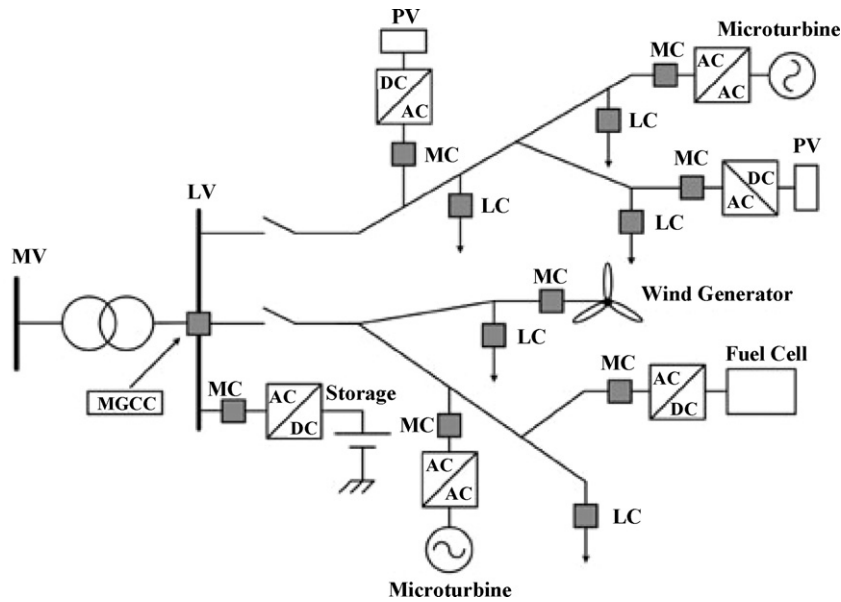

Fig. 1. A typical LV micro-grid model.

any single and feasible solution is a bird and is called “particle” within the search space. Each particle has its own fitness value evaluated by the fitness function to be optimized, and has a velocity vector which addresses the flying of the particle. All the particles fly through the problem domain by following the current optimum particles i.e., to reach the optimal point, particles must update their next displacements according to their own velocities, their best performances or the best performance of their best informant as shown in Fig. 2. The mathematical behavior of each particle can be also formulated by Eqs. (14) and (15):

$$V_i^{k+1} = \omega \cdot V_i^k + C_1 \times rand_1(\cdot) \times (P_{best,i}^k - X_i^k) + C_2 \times rand_2(\cdot) \times (G_{best,i}^k - X_i^k) \tag{14}$$

$$X_i^{k+1} = X_i^k + V_i^{k+1} \tag{15}$$

where V_i^{k+1} is the updated velocity vector of i th particle based on the three displacement fundamentals, X_i^{k+1} is the updated position of i th particle, $rand_1(\cdot)$ and $rand_2(\cdot)$ are random numbers in the range of [0,1] C_1 and C_2 are the learning factors and ω is the inertia or momentum weight factor.

5. Fuzzy Self Adaptive PSO (FSAPSO)

It was observed from Eq. (14) that the performance of a PSO algorithm depends greatly on three influential parameters usually stated as the exploration–exploitation trade off: learning factors

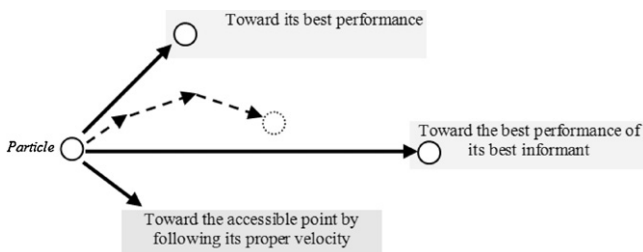

Fig. 2. Fundamental elements for displacement calculation of a particle.

(C_1 , C_2) and momentum weight factor (ω). The ability of an optimization algorithm in searching the problem space and finding the optimum point (especially the global one) is called exploration while exploitation refers to the ability of an optimization algorithm in finding the optimum point accurately through concentration on a promising candidate solution.

The momentum weight factor ω is widely used both for controlling the scope of the search more easily and reducing the importance of maximum velocity, i.e., larger values of ω promotes global exploration while smaller ones facilitate local exploration for fine tuning of the current search area. In simple words, a wise selection of ω provides not only a good trade off between local and global exploration but also a better means of convergence. As an example, linearly decreasing ω -strategy is a method which allows the swarm to explore the problem domain and moves towards a local search when fine-tuning is needed [35].

The learning factors C_1 and C_2 provide an insight from a sociological point of view. Since C_1 has a contribution towards the self-exploration of a particle, it's regarded as the particle's self-confidence. On the other hand, because C_2 has a contribution towards motion of the particles in global direction considering the motions of all the particles in the preceding program iterations, it's defined as swarm confidence. As a rule of thumb, if learning factor C_1 is chosen larger than C_2 , the self-confidence outweighs the swarm confidence which means that the particle will be attracted towards the best position found by itself (P_{best}) and vice versa. It should be noted that the performance of a PSO algorithm is also affected by some other parameters such as the number of particles and the size of the swarm e.g., using few particles in optimization problem may increase the possibility of being trapped in local minimum while choosing a large number of particles may slow down the optimization process. To put all the above statements in a nutshell, it's concluded that finding a definite set of parameters that work well in all cases may be impossible but it is practical to reach such an objective by applying a Fuzzy Self Adaptive mechanism. It's known by experience that lower values of inertia weight and larger values of learning factors work better in optimization process when the best fitness value is low at the end of each iteration. Likewise, higher values of inertia weight and lower amounts of learning factors are required when the system faces a local minimum and the best fitness value remains unchanged for a long period of time. To

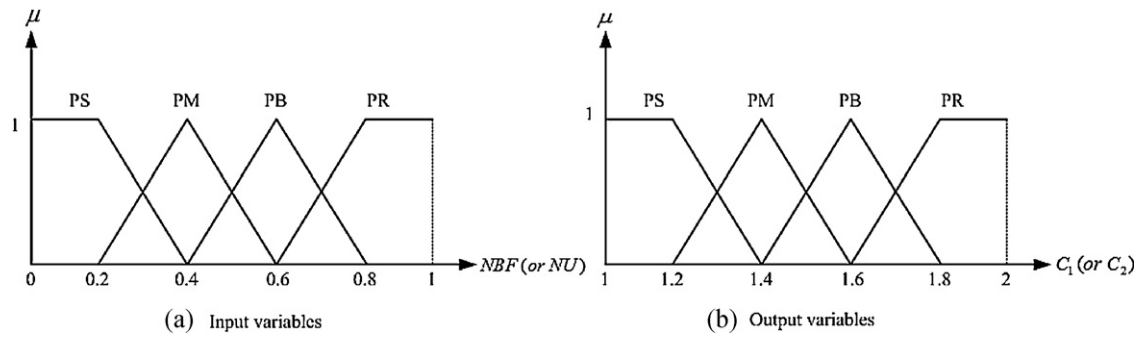

Fig. 3. Membership functions for learning factors fuzzification.

overcome all the deficiencies associated with a conventional PSO algorithm a Fuzzy Self Adaptive PSO (FSAPSO) approach is developed to adjust the inertia weight and learning factors when they are needed. During the work two membership functions are proposed; one for the learning factors adjustment with the input parameters of best fitness (*BF*) and number of generations for unchanged best fitness (*NU*) and the other for weight inertia tuning whose input factors are best fitness (*BF*) and inertia weight (ω). The output variables of these two functions are learning factors (C_1, C_2) and weight correction value ($\Delta\omega$) respectively. Since either a positive or negative value may be assigned to $\Delta\omega$, a range of $(-1, +1)$ has been preferred for the inertia weight correction factor as sated in Eq. (16).

$$\omega^{k+1} = \omega^k + \Delta\omega \tag{16}$$

Furthermore, to make a robust FSAPSO, *BF* and *NU* values can be normalized into $[0,1]$ as shown in Eq. (17):

$$NBF = \frac{(BF - BF_{min})}{(BF_{max} - BF_{min})} \tag{17}$$

where BF_{min} is the minimum fitness value and BF_{max} is the fitness value which is greater or equal to the maximum fitness value. Additionally, values of ω, C_1 and C_2 are limited as follow:

$$0.4 \leq \omega \leq 1; \quad 1 \leq C_1 \leq 2; \quad 1 \leq C_2 \leq 2 \tag{18}$$

To complete the proposed fuzzy-based PSO algorithm the main characteristics of the fuzzy system are described as follows.

5.1. Fuzzification

The membership functions used in this study are triangular types in which the input/output relations are depicted in Figs. 3 and 4. In the first membership function linguist variables for a set of inputs including *NBF* and *NU* and a set of outputs (C_1, C_2) are as following: positive small (*PS*), positive medium (*PM*), positive big (*PB*) and positive bigger (*PR*). For the second membership function similar literature can be defined: small (*S*), medium (*M*) and large (*L*) for the input set (*NBF, ω*) and negative (*NE*), zero (*ZE*) and positive (*PE*) for the output variable ($\Delta\omega$).

5.2. Fuzzy rules

To express the conditional statements which represent a mapping from the input space to output space the Mamdani fuzzy rule is adopted and the corresponding conditions are tabulated in Tables 1–3.

5.3. Defuzzification

To achieve a deterministic control action, a defuzzification strategy based on centroid (center-of-sums) is adopted as shown in Eq.

Table 1
Fuzzy rules for learning factor C_1 .

C_1	<i>NU</i>			
	<i>PS</i>	<i>PM</i>	<i>PB</i>	<i>PR</i>
<i>NBF</i>				
<i>PS</i>	<i>PR</i>	<i>PB</i>	<i>PB</i>	<i>PM</i>
<i>PM</i>	<i>PB</i>	<i>PM</i>	<i>PM</i>	<i>PS</i>
<i>PB</i>	<i>PM</i>	<i>PM</i>	<i>PS</i>	<i>PS</i>
<i>PR</i>	<i>PM</i>	<i>PM</i>	<i>PS</i>	<i>PS</i>

Table 2
Fuzzy rules for learning factor C_2 .

C_2	<i>NU</i>			
	<i>PS</i>	<i>PM</i>	<i>PB</i>	<i>PR</i>
<i>NBF</i>				
<i>PS</i>	<i>PR</i>	<i>PB</i>	<i>PM</i>	<i>PM</i>
<i>PM</i>	<i>PB</i>	<i>PM</i>	<i>PS</i>	<i>PS</i>
<i>PB</i>	<i>PM</i>	<i>PM</i>	<i>PS</i>	<i>PS</i>
<i>PR</i>	<i>PM</i>	<i>PS</i>	<i>PS</i>	<i>PS</i>

(19). The output values of this section are directly used as substitutes of PSO parameters.

$$y = \frac{\int_y \sum_{i=1}^n y \cdot \mu_{Bi}(y) dy}{\int_y \sum_{i=1}^n \mu_{Bi}(y) dy} \tag{19}$$

6. Implementation of FSAPSO to multi-operation management problem

As said beforehand the optimal operation management problem in a typical micro-grid can be formulated as a multi-objective optimization model which can be solved easily by applying an efficient step-by-step procedure. In this section, first the proposed FSAPSO algorithm is presented in detail, and then its application to the mentioned problem is investigated. To implement the FSAPSO algorithm a hierarchical structure must be followed as shown in Fig. 5 while considering the top-down instructions as mentioned below:

Step 1: input data definition

At the beginning of the program required input data must be provided precisely. This information includes: micro-grid

Table 3
Fuzzy rules for inertia weight correction factor.

$\Delta\omega$	ω		
	<i>S</i>	<i>M</i>	<i>L</i>
<i>NBF</i>			
<i>S</i>	<i>ZE</i>	<i>NE</i>	<i>NE</i>
<i>M</i>	<i>PE</i>	<i>ZE</i>	<i>NE</i>
<i>L</i>	<i>PE</i>	<i>ZE</i>	<i>NE</i>

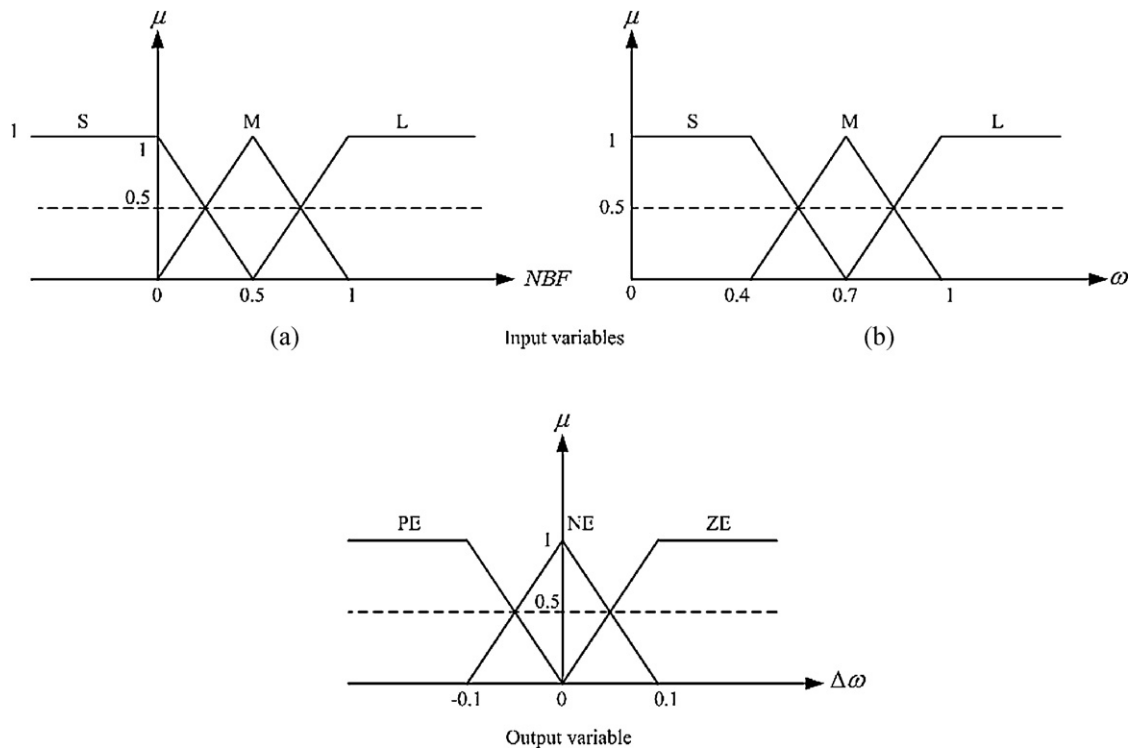

Fig. 4. Membership functions for weight correction factor fuzzification.

configuration, operational characteristics of DG units and the utility, maximum predicted output powers of WT and PV for a day ahead, hourly bids of DGs and the utility, emission coefficients of mentioned units, objective functions and the micro-grid load profile.

Step 2: program initialization

At the second step the program must be initialized by a set of random populations and their corresponding velocities as follows:

$$\begin{aligned} \text{Initial population} &= [X_1 \ X_1 \ \dots \ X_N]^T \\ X_i &= [x_i]_{1 \times 2nT}; \quad \text{for } i = 1, 2, 3, \dots, N; \quad n = N_g + N_s = 1 \quad (20) \\ x_i &= \text{rand}(\cdot) \times (x_i^{\max} - x_i^{\min}) + x_i^{\min} \end{aligned}$$

$$\begin{aligned} \text{Initial velocity} &= [V_1 \ V_1 \ \dots \ V_N] \\ V_i &= [v_i]_{1 \times 2nT}; \quad \text{for } i = 1, 2, 3, \dots, N; \quad n = N_g + N_s + 1 \quad (21) \\ v_i &= \text{rand}(\cdot) \times (v_i^{\max} - v_i^{\min}) + v_i^{\min} \end{aligned}$$

Step 3: calculate the objective function for each individual

Step 4: sort the initial population

In the fourth step the initial populations are sorted in an ascending manner according to their values obtained from multi-objective function.

Step 5: define the best global position

The individual which has the best performance in terms of best fitness among the whole is selected as the best global position (G_{best}).

Step 7: select i th individual

Step 8: define the best local position for the i th individual ($P_{best,i}$)

Step 9: update FSAPSO parameters

Step 10: calculate the next position for each individual using updated parameters and Eq. (15).

Step 11: redo steps 7–11 for the entire population.

Step 12: examine the stop condition

If the maximum number of iterations executed by the FSAPSO is met or the minimum desired error is reached, the optimization procedures is stopped, otherwise the population is replaced with the new generation and the algorithm is repeated from step 4.

Step 13: the G_{best} obtained at the last iteration is the optimal solution of the problem.

7. Simulation results

In this part of the work the proposed Fuzzy Self Adaptive Particle Swarm Optimization algorithm (FSAPSO) is implemented to solve the multi-operation management problem and its performance is compared to those of conventional techniques such as PSO and GA. In the suggested model the objective function considers both the total cost of the micro-grid which includes power generation costs and start-up/shut-down costs of units and the net emission of pollutants.

The mentioned problem is solved in three different scenarios including the main case, where all the units are dispatched regarding their real constraints, the second case in which the both wind turbine (WT) and photovoltaic (PV) operate at their maximum output powers (Max-Ren.) and the third case in which the utility is considered as an unconstrained unit that can exchange energy with the micro-grid without any limitation (WLE). The total load demand within the micro-grid for a typical day comprises a primarily residential area, one industrial feeder serving a small workshop and one feeder with light commercial consumers as shown in Fig. 6. The total energy demand for this day is 1695 kWh. Additionally, the real time market energy price variation for the mentioned day is considered as Fig. 7. For the flexible operation of the micro-grid three DG units including MT, PV and WT are assigned with suitable “on” or “off” states during the power dispatch problem by the optimization algorithm considering both objectives. In a similar manner, since the micro-grid operates at grid-connected mode the on/off state for the utility is considered 1 in all cases. To investigate the total effect of battery and PAFC on the grid operation and to get the highest benefit of such resources the “on” state is chosen intentionally for corresponding units. The minimum and maximum generation limits of the

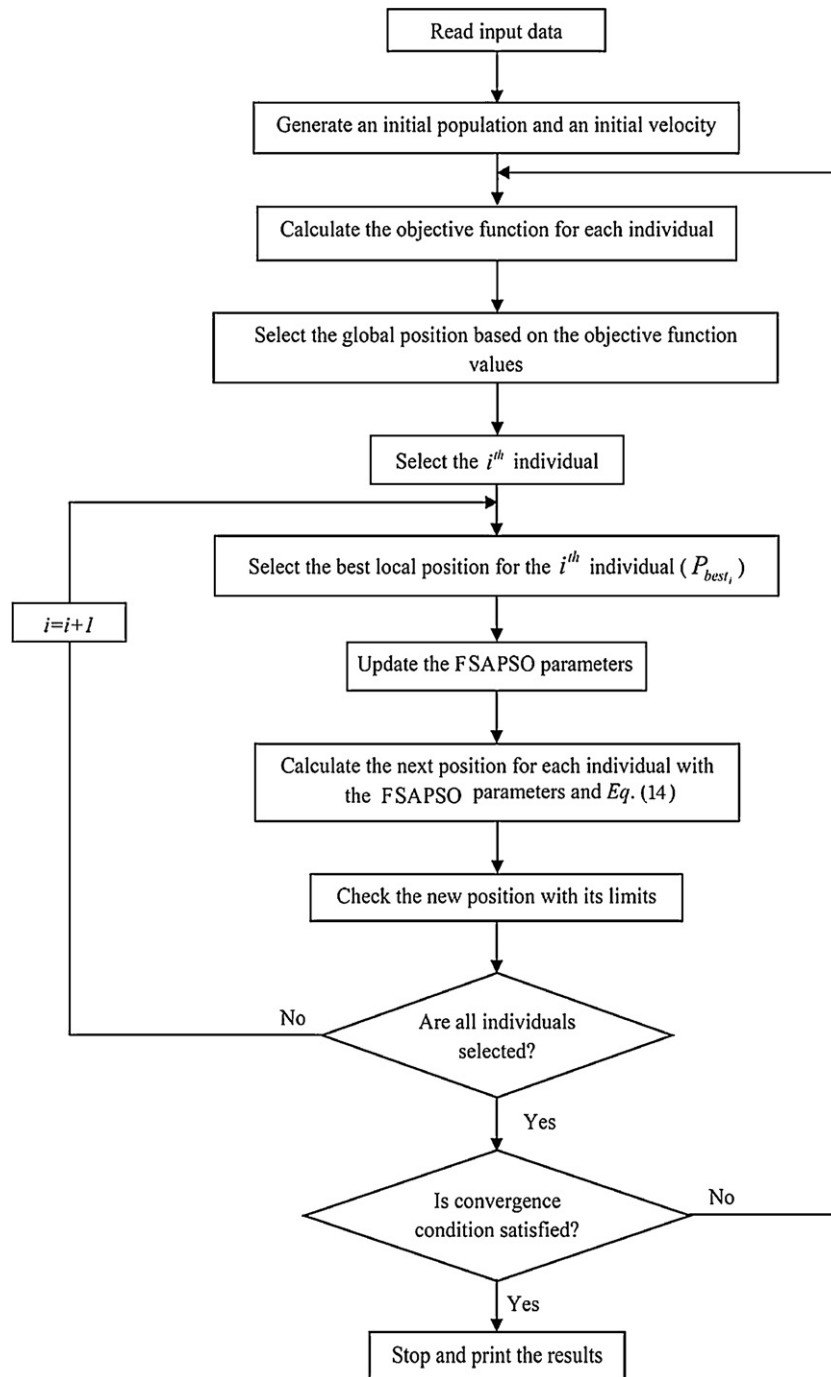

Fig. 5. FSAPSO flowchart.

DG sources are given in Table 4. The bid coefficients in cents of Euro (Ect) per kWh as well as emissions in kilogram per MWh assumed by the DG sources are given in Table 5. In the same table, start up costs where applicable are presented. To simplify

Table 4
Installed DG sources.

ID	Type	Min power (kW)	Max power (kW)
1	MT	6	30
2	PAFC	3	30
3	PV	0	25
4	WT	0	15
5	Bat	−30	30
6	Utility	−30	30

our analysis, all units in this paper are assumed to be operating in electricity mode only and no heat is required for the examined period.

It's worthy of note that the ability to better integrate renewable energies is one of the driving factors in micro-grid installations. For the actual operation of a micro-grid forecasts of future requirements are essential to be able to prepare the flexible systems to behave in the appropriate manner. While renewable energy cannot necessarily be operated in a conventional manner, its behavior can be predicted and the forecast information is exactly the kind of information that the micro-grid must use to improve system efficiency. In this work the power output of PV and WT are also estimated using an expert prediction model which is out of the scope of this paper and will be presented in future

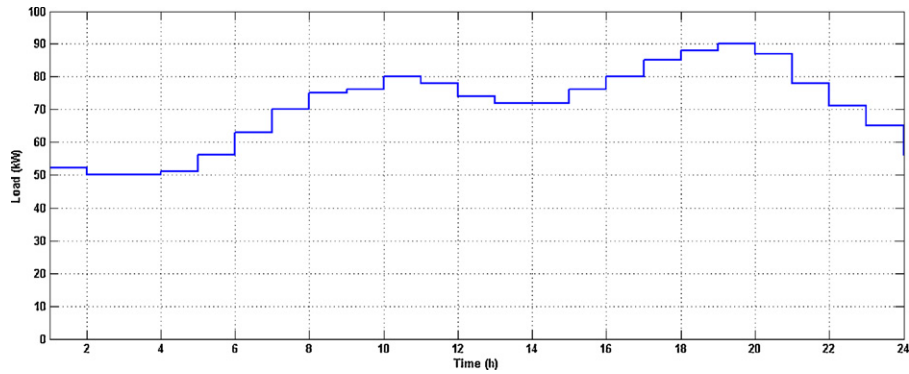

Fig. 6. Load demand in a typical day inside the micro-grid.

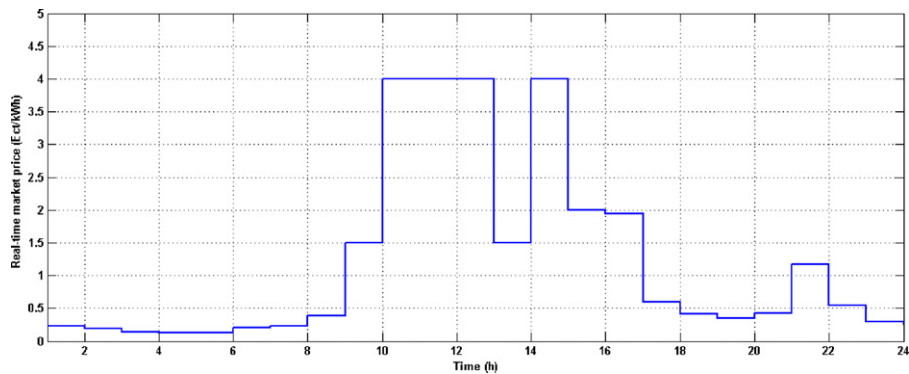

Fig. 7. Real-time market energy prices.

Table 5
Bids and emissions of the DG sources.

ID	Type	Bid (Ect/kWh)	Start-up/shut-down cost (Ect)	CO ₂ (kg/MWh)	SO ₂ (kg/MWh)	NO _x (kg/MWh)
1	MT	0.457	0.96	720	0.0036	0.1
2	PAFC	0.294	1.65	460	0.003	0.0075
3	PV	2.584	0	0	0	0
4	WT	1.073	0	0	0	0
5	Batt	0.38	0	10	0.0002	0.001

works. Table 6 shows the amount of forecasting output of these units.

7.1. First scenario (main case)

Performance assessment of the proposed FSAPSO algorithm begins with the main case in which a typical micro-grid is considered as shown in Fig. 1. Five DG sources with related characteristics mentioned in Tables 4 and 5 produce electricity in the

micro-grid and additional demand or surplus of energy inside the grid is exchanged with the utility from the point of common coupling. All the units including the macro grid (utility) can operate just within their power limits while satisfying the needed constraints. The results of optimization algorithms as well as a brief comparison of their performances for the main case are presented in Tables 7 and 8. To get a better insight into the FSAPSO performance, the convergence characteristics of the FSAPSO and PSO algorithms for the best solution and in the case of each single

Table 6
Forecasting output of WT and PV.

Hour	WT (kW)/installed (kW)	PV (kW)/installed (kW)	Hour	WT (kW)/installed (kW)	PV (kW)/installed (kW)
1	0.119	0	13	0.261	0.956
2	0.119	0	14	0.158	0.842
3	0.119	0	15	0.119	0.315
4	0.119	0	16	0.087	0.169
5	0.119	0	17	0.119	0.022
6	0.061	0	18	0.119	0
7	0.119	0	19	0.0868	0
8	0.087	0.008	20	0.119	0
9	0.119	0.150	21	0.0867	0
10	0.206	0.301	22	0.0867	0
11	0.585	0.418	23	0.061	0
12	0.694	0.478	24	0.041	0

Table 7

Comparison of performance results in the case of cost objective for 50 trials.

Type	Average (€ct)	Standard deviation (€ct)	Worst solution (€ct)	Best solution (€ct)
FSAPSO	125.913	0.0060	125.921	125.909
PSO	145.185	26.848	164.170	126.201
GA	151.886	36.228	210.457	125.911

Table 8

Comparison of performance results in the case of emission objective for 50 trials.

Type	Average (kg)	Standard deviation (kg)	Worst solution (kg)	Best solution (kg)
FSAPSO	422.021	0.0050	422.025	422.015
PSO	449.448	32.635	490.890	422.013
GA	506.776	89.251	680.330	422.015

Table 9

Emission/economic dispatch using FSAPSO algorithm (main case: total cost = 191.0416 €ct; total emission = 721.0757 kg).

Time (hour)	DG sources						States					
	MT	PAFC	PV	WT	Battery	Utility	MT	PAFC	PV	WT	Battery	Utility
1	0	29.9829	0	0	-7.9827	29.9998	0	1	0	0	1	1
2	0	28.8507	0	0	-8.8507	30	0	1	0	0	1	1
3	0	28.1546	0	0	-8.1536	29.999	0	1	0	0	1	1
4	0	29.6293	0	0	-8.6293	29.9999	0	1	0	0	1	1
5	6	29.776	0	0	-9.776	30	1	1	0	0	1	1
6	6	27.3954	0	0	-0.3953	29.9999	1	1	0	0	1	1
7	6	19.427	0	0	14.5729	30	1	1	0	0	1	1
8	6	30	0	0	29.5719	9.4281	1	1	0	0	1	1
9	30	30	0	1.7855	30	-15.7856	1	1	0	1	1	1
10	30	30	7.5279	3.0854	30	-20.6133	1	1	1	1	1	1
11	30	30	9.2276	8.7723	30	-30	1	1	1	1	1	1
12	29.9999	30	3.5868	10.4133	30	-30	1	1	1	1	1	1
13	30	30	0	3.9224	30	-21.9225	1	1	0	1	1	1
14	30	30	9.6235	2.3765	30	-30	1	1	1	1	1	1
15	30	30	0	1.7855	30	-15.7857	1	1	0	1	1	1
16	30	30	0	1.3017	30	-11.3016	1	1	0	1	1	1
17	29.9993	30	0	0	29.9999	-4.9992	1	1	0	0	1	1
18	0	30	0	0	29.9991	28.0007	0	1	0	0	1	1
19	6	30	0	0	29.9998	24.0002	1	1	0	0	1	1
20	6.0007	29.9999	0	0	30	20.9995	1	1	0	0	1	1
21	30	30	0	1.2974	30	-13.2974	1	1	0	1	1	1
22	29.9964	30	0	0	30	-18.9966	1	1	0	0	1	1
23	0	30	0	0	18.0108	16.9892	0	1	0	0	1	1
24	0	19.1864	0	0	6.8135	30	0	1	0	0	1	1

objective are shown in Figs. 8 and 9 separately. Likewise, the best performances of all mentioned algorithms are shown in Fig. 10 taking into account the both objectives. Table 9 is also demonstrates the best optimal power dispatch among DG units and the utility within the micro-grid using FSAPSO algorithm.

Comparison of performances in the case of best and worst solutions for cost and emission objectives reveals that the proposed optimization algorithm not only gives a better response but also presents a faster convergence characteristic. Moreover, the statistical indices of average and standard deviation confirm another benefit of the algorithm in optimization process. As it is observed from Tables 7 and 8 the values of standard deviations in terms of cost and emission objectives for FSAPSO algorithm are limited to 0.006 and 0.005 respectively which verify the excellent performance of the proposed model. Since a Fuzzy Self Adaptive (FSA) mechanism is applied during the optimization process by the proposed algorithm, further improvement is investigated both in

performance characteristic and optimal solutions. It can be seen from Figs. 8 and 9 that the value of cost objective function reaches to minimum after about 784 iterations with FSAPSO method and does not vary thereafter while the PSO algorithm converges in about 865 iterations. Similarly the value of emission objective function settles at the minimum in about 500 iterations with FSAPSO method, while the PSO algorithm converges in about 782 iterations.

It's also observed from Table 9 that according to FSAPSO, in the first hours of the day a major part of the load is supplied by FC within the grid and the utility through the point of common coupling because the bids of corresponding units are lower in comparison with those of others during this period of time. Due to growth of demand and bids of utility during the next hours of the day, DG units increase their output powers according to priority in lower cost and emission correspondingly. In this regard, units start up in sequence on the micro-grid regulatory controller request and the act of energy import from the macro grid is replaced by the export

Table 10

Comparison of performance results in the case of cost objective for 50 trials.

Type	Average (€ct)	Standard deviation (€ct)	Worst solution (€ct)	Best solution (€ct)
FSAPSO	599.9968	0.007142	600.0018	599.9917
PSO	610.6537	14.21645	620.7062	600.6011
GA	632.7230	45.36649	664.8019	600.6440

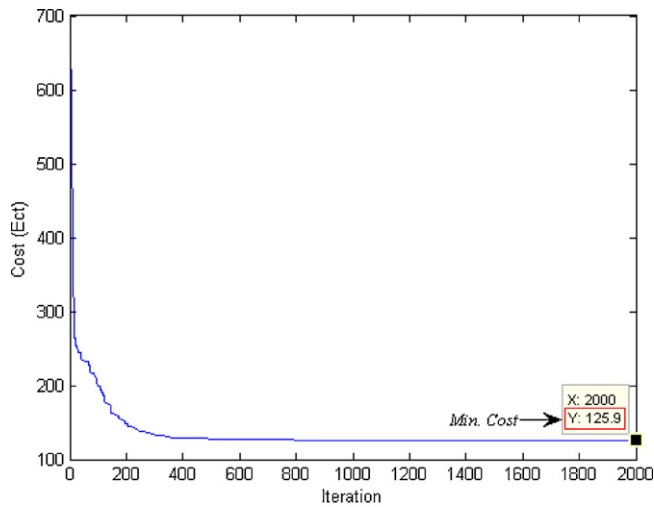

(a) FSAPSO

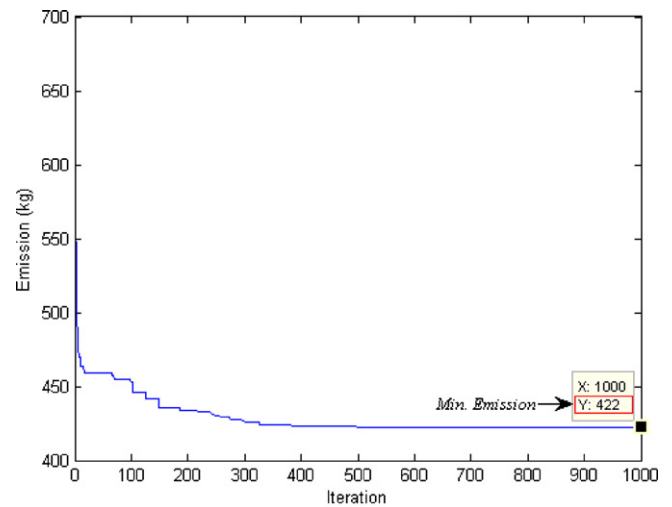

(a) FSAPSO

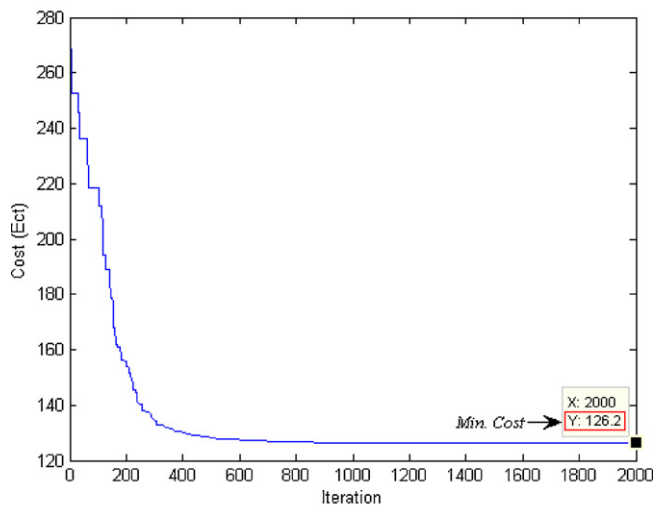

(b) PSO

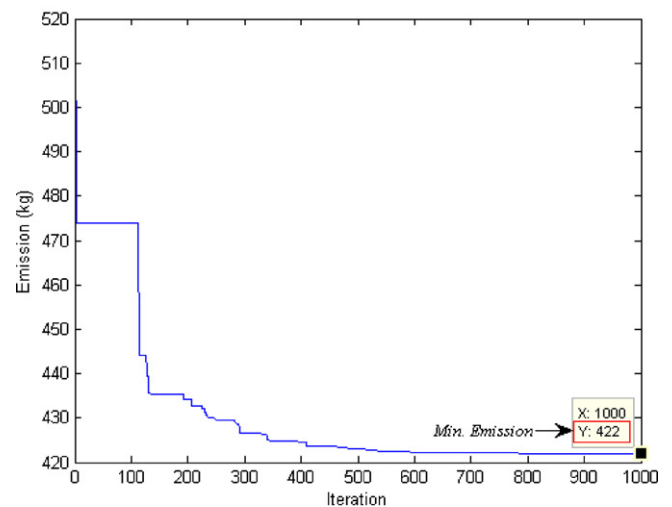

(b) PSO

Fig. 8. Convergence characteristics of FSAPSO and PSO in the case of cost objective (main scenario).

Fig. 9. Convergence characteristics of FSAPSO and PSO in the case of emission objective (main scenario).

action for further revenue and lower net emission during the mentioned period. It should be also noted that the charging process of the battery is done at the first hours of the day when the prices are low but the discharge action is postponed to the midday when the load curve reaches peak values. It's also notable that employing renewable resources of energy such as wind and solar results less pollution while it causes more operating cost, i.e., from an economical aspect, exploitation of energy form such resources must be limited according to emission/economic considerations.

7.2. Second scenario (Max-Ren.)

In the second scenario it's assumed that renewable energy sources (WT and PV) produce their available maximum power during each hour of the day and rests of generators including MT, PAFC, battery and the utility act normally similar to their behavior in the main case. In this regard, the proposed algorithms are implemented again and are applied to the multi-objective optimization problem and corresponding results are recorded. Tables 10 and 11 show a brief comparison from the performance of the mentioned algorithms regarding each single objective for 50 trials. As an example the best performance of the proposed algorithms in the case of

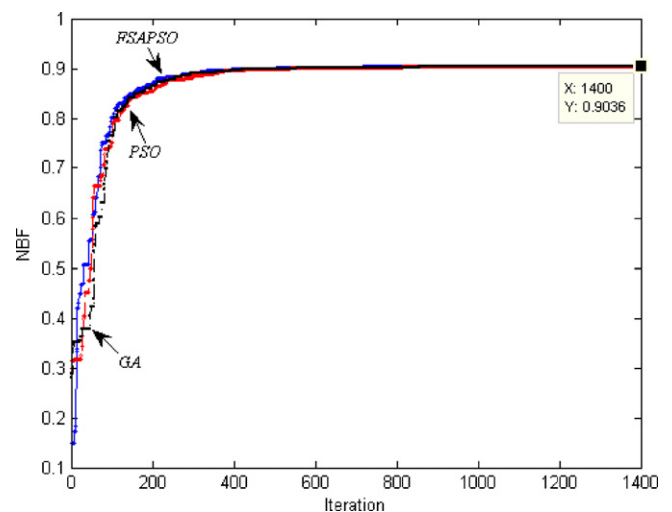

Fig. 10. Convergence characteristics of all optimization models in the case of both objectives (main scenario).

Table 11
Comparison of performance results in the case of emission objective for 50 trials.

Type	Average (kg)	Standard deviation (kg)	Worst solution (kg)	Best solution (kg)
FSAPSO	350.5235	0.007778	350.529	350.518
PSO	356.2970	8.068088	362.002	350.592
GA	370.2415	27.81829	389.912	350.571

Table 12
Emission/economic dispatch using FSAPSO algorithm (second case: total cost = 735.1564 €ct; total emission = 440.4118 kg).

Time (hour)	DG sources						States					
	MT	PAFC	PV	WT	Battery	Utility	MT	PAFC	PV	WT	Battery	Utility
1	6.000848	30	0	1.785415	15	-0.78626	1	1	1	1	1	1
2	6	30	0	1.785542	30	-17.7855	1	1	1	1	1	1
3	0	30	0	1.785542	29.99932	-11.7849	0	1	1	1	1	1
4	6.000256	30	0	1.785542	30	-16.7858	1	1	1	1	1	1
5	6	30	0	1.78486	30	-11.7849	1	1	1	1	1	1
6	6	29.99972	0	0.914197	30	-3.91392	1	1	1	1	1	1
7	0	30	0	1.78553	30	8.21447	0	1	1	1	1	1
8	6.006675	30	0.193748	1.30166	30	7.497917	1	1	1	1	1	1
9	6	30	3.753957	1.779395	29.99965	4.467001	1	1	1	1	1	1
10	6.000621	30	7.527933	3.085416	30	3.386029	1	1	1	1	1	1
11	6	30	10.44118	8.772367	30	-7.21354	1	1	1	1	1	1
12	6	29.99589	11.96401	10.41328	30	-14.3732	1	1	1	1	1	1
13	6	29.99925	23.8934	3.922835	30	-21.8155	1	1	1	1	1	1
14	6.001254	30	21.0493	2.376556	30	-17.4271	1	1	1	1	1	1
15	6	30	7.864028	1.785542	30	0.35043	1	1	1	1	1	1
16	6	30	4.220769	1.300601	30	8.47863	1	1	1	1	1	1
17	6.006595	30	0.538905	1.785542	30	16.66896	1	1	1	1	1	1
18	6	30	0	1.785542	30	20.21446	1	1	1	1	1	1
19	6.002708	30	0	1.30166	30	22.69563	1	1	1	1	1	1
20	6	30	0	1.785542	30	19.21446	1	1	1	1	1	1
21	6	29.99932	0	1.30166	30	10.69902	1	1	1	1	1	1
22	0	30	0	1.300539	30	9.699461	0	1	1	1	1	1
23	0	30	0	0.914197	30	4.09322	0	1	1	1	1	1
24	6	30	0	0.612441	30	-10.6124	1	1	1	1	1	1

multi-objective optimization and allocation of optimal power to the units is also presented in Table 12. Similarly, the convergence characteristics of all optimization models in the case of both objectives considering the second scenario are shown in Fig. 11.

Regarding the second scenario, it's again observed that the proposed algorithm appropriately performs the multi-operation management and maintains a small diversity among its optimal solutions considering each objective and during different trials ($\sigma_{\text{cost}} = 0.007 \text{ €ct}$, $\sigma_{\text{emission}} = 0.0078 \text{ kg}$). Moreover, it's found that in

the case of cost and emission objectives the difference between the average of solutions and the best one is limited to 0.0051 €ct and 0.0055 kg for the proposed FSAPSO algorithm while these values are 10.53 €ct and 7.705 kg for the conventional PSO and 32.079 €ct and 19.67 kg for GA, respectively. It's also observed from Table 12 that during the second scenario the total operation cost of the micro-grid increases greatly compared to the main case and demonstrates a growth of %284.81 in corresponding cost, but it should be noted the net emission decreases %38.92 in comparison with the first scenario i.e., higher penetration of renewable energies into the grid environment results lower net emission but imposes higher costs of operation in a definite period of time. From the same table it's investigated that to reach emission/economic objectives simultaneously, units with higher performance must be utilized suitably. In this regard units such as PAFC and battery are used extensively and the rest are used when they are needed. During the first hours of the day, when the load is light, surplus of energy is exported to the macro-grid but in heavy load levels the energy provided by the utility plays an important role.

7.3. Third scenario (WLE)

In the last scenario, it's supposed that all DG units act within their power limits but the utility behaves as an unconstrained unit and exchanges energy with the micro-grid without any limitation. All the required data for solving the multi-objective optimization problem including the load curve, technical specifications of the DG sources and the real-time market prices remain unchanged as well. Similar to previous scenarios, evolutionary-based optimization algorithms are applied to solve the operation management problem within the micro-grid and the simulation results are gathered correspondingly. Comparisons of performances in terms of

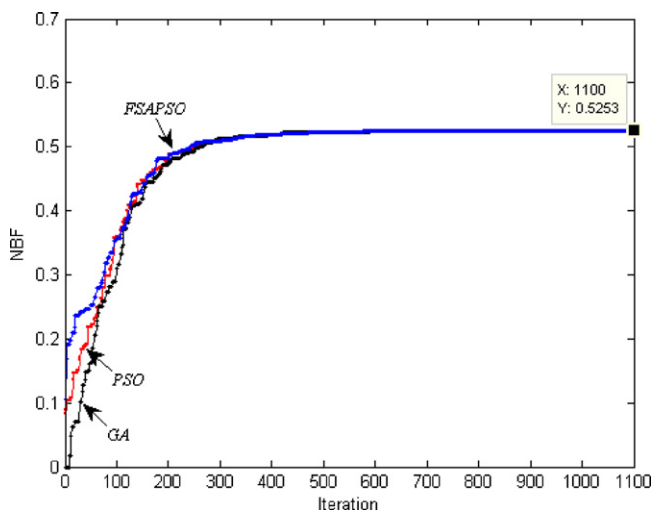

Fig. 11. Convergence characteristics of all optimization models in the case of both objectives (second scenario).

Table 13
Comparison of performance results in the case of cost objective for 50 trials.

Type	Average (Ect)	Standard deviation (Ect)	Worst solution (Ect)	Best solution (Ect)
FSAPSO	100.2170	0.005657	100.221	100.213
PSO	108.2075	11.17158	116.107	100.308
GA	117.1340	23.83374	133.987	100.281

Table 14
Comparison of performance results in the case of emission objective for 50 trials.

Type	Average (kg)	Standard deviation (kg)	Worst solution (kg)	Best solution (kg)
FSAPSO	408.3315	0.006364	408.327	408.336
PSO	413.7145	7.603519	419.091	408.338
GA	423.1640	20.98269	438.001	408.327

Table 15
Emission/economic dispatch using FSAPSO algorithm (third case: total cost = 166.9624 €ct; total emission = 567.4380 kg).

Time (hour)	DG sources						States					
	MT	PAFC	PV	WT	Battery	Utility	MT	PAFC	PV	WT	Battery	Utility
1	6.0118	18.6153	0	0	14.9266	12.44617	1	1	0	0	1	1
2	0	3.701	0	0	29.1897	17.11027	0	1	0	0	1	1
3	6	3	0	0	16.4219	24.57809	1	1	0	0	1	1
4	0	3.0624	0	0.0168	11.9654	35.95519	0	1	1	1	1	1
5	6	3	0	0	12.1335	34.86646	1	1	1	0	1	1
6	0	3	0	0	28.572	31.42766	0	1	0	0	1	1
7	6	19.9798	0	0	29.988	14.03204	1	1	1	0	1	1
8	6	29.8902	0	0	29.984	9.124852	1	1	0	0	1	1
9	29.80453	30	0.1212	1.784	29.9331	-15.64349	1	1	1	1	1	1
10	30	29.9985	7.5279	3.0854	29.9761	-20.58804	1	1	1	1	1	1
11	29.9704	29.999	10.44	8.7606	30	-31.17088	1	1	1	1	1	1
12	29.999	29.999	11.964	10.4118	30	-38.37439	1	1	1	1	1	1
13	29.993	30	0.1398	3.92283	30	-22.05595	1	1	1	1	1	1
14	30	29.9819	21.0493	2.3765	29.962	-41.37002	1	1	1	1	1	1
15	30	30	1.1581	1.78554	29.999	-16.943661	1	1	1	1	1	1
16	29.999	29.9298	0.4798	1.3013	29.9868	-11.697921	1	1	1	1	1	1
17	26.3174	29.999	0	1.7855	30	-3.1029835	1	1	0	1	1	1
18	6	29.825	0	0.296	29.9594	21.919201	1	1	0	1	1	1
19	0	29.779	0	0.3054	30	29.914723	0	1	1	1	1	1
20	6.4606	30	0	0.12515	30	20.414201	1	1	0	1	1	1
21	29.9927	30	0	1.2667	30	-13.2595	1	1	1	1	1	1
22	7.57668	30	0	0	30	3.4233101	1	1	0	0	1	1
23	0	26.434	0	0	30	8.5658216	0	1	0	0	1	1
24	6	28.382	0	0.02049	29.9984	-8.4010003	1	1	0	1	1	1

each single objective are presented in Tables 13 and 14 for the mentioned algorithms. Again for the third scenario the convergence characteristics of all optimization models in the case of both objectives are depicted in Fig. 12. The best optimal power dispatch

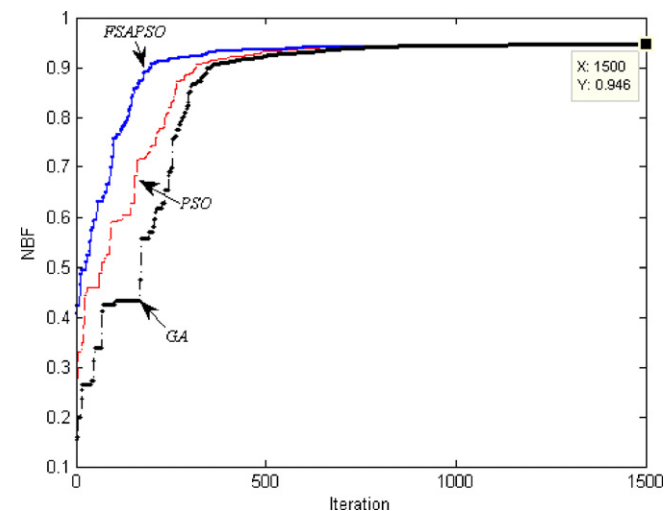

Fig. 12. Convergence characteristics of all optimization models in the case of both objectives (third scenario).

using FSAPSO algorithm is also tabulated in Table 15, considering emission/economic objectives.

For the third time it's observed that the proposed algorithm solve the optimization problem successfully and the variations of optimal solutions remain small in terms of both objectives. Similarly, the difference between the average of solutions and the best answer declines to 0.004 €ct considering cost objective and reaches to 0.0045 kg in terms of emission objective using FSAPSO. In the same manner, comparison of results in the case of each objective using PSO and GA yields much more diversity in performance and shows the deficiency of these algorithms compared to the proposed approach. It's also observed from Fig. 12 that in the third scenario the normalized best fitness (NBF) get the highest value among the whole and the performance of the proposed algorithm completely outweighs of the others. Furthermore, the numerical results of Table 15 confirm that revoking the limits on the rate of power exchange between the utility and the micro-grid ends in a reduction of %12.6 in operating cost as well as a reduction of %21.3 in net emission of the grid in comparison with the main case during the examined period. Comparison of results in the case of costs and emissions among the third scenario and the second one reveals that although the total cost of operation in the third scenario decreases about %77.56, the net emission inside the grid increases %30.88 compared to the second one. It's worthy of note that in the third scenario the utility takes the lead in supplying the load inside the

grid during the first hours of the day while purchasing energy in bulk amount from the micro-grid during the peak times. Regarding both objectives, WT and PV start up when shortage of power generation occurs inside the grid or there is a need for more energy export to the macro grid. The other DGs such as FC and battery generate electricity at their maximum levels during the most hours of the day while MT holds the maximum power rate during a period of time from 9:00 to 17:00.

8. Conclusion

In this paper, a developed multi-objective FSAPSO optimization algorithm has been proposed and applied to a multi-operation management problem in a typical micro-grid. The contribution of the proposed approach lies in the fact that the modification of the heuristic parameters inside the model is assigned to a Fuzzy Self Adaptive system in contrast to the conventional methods. To evaluate the performance of the proposed algorithm against the other evolutionary optimization techniques, three different scenarios have been introduced and the simulation results in the case of each scenario have been gathered truly. The findings show that with high incorporation of renewable energy sources, the total effect on grid operation is considerable especially in the case of emission objective although the total cost of micro-grid increases correspondingly in the examined period of time. Moreover, providing a suitable means of power exchange between the micro-grid and the utility in grid-connected mode can be beneficial in terms of both objectives. Furthermore, it's investigated that using FSAPSO in optimization schemes not only could be the best respondent to the planning needs but also satisfies emission/economic objectives with acceptable precision.

References

- [1] Zangeneh A, Jadid Sh, Rahimi-Kian A. Promotion strategy of clean technologies in distributed generation expansion planning. *J Renew Energy* 2009;34:2765–73.
- [2] Dicorato M, Forte G, Trovato M. Environmental-constrained energy planning using energy-efficiency distributed-generation facilities. *J Renew Energy* 2008;33:1297–313.
- [3] Soroudi A, Ehsan M, Zareipour H. A practical eco-environmental distribution network planning model including fuel cells and non-renewable distributed energy resources. *J Renew Energy* 2011;36:179–88.
- [4] Peza RD, Bernal-Agustina JL, Contreras J. Optimization of control strategies for stand-alone renewable energy systems with hydrogen storage. *J Renew Energy* 2007;32:1102–26.
- [5] Jiayi H, Chuanwen J, Rong X. A review on distributed energy resources and microgrid. *J Renew Sust Energy Rev* 2008;12:2472–83.
- [6] Lidula NWA, Rajapakse AD. Microgrids research: a review of experimental microgrids and test systems. *J Renew Sust Energy Rev* 2011;15:186–202.
- [7] Dondi P, Bayoumi D, Haederli C, Julian D, Suter M. Network integration of distributed power generation. *J Power Sources* 2002;106:1–9.
- [8] Boqiang R, Chuanwen J. A review on the economic dispatch and risk management considering wind power in the power market. *J Renew Sust Energy Rev* 2009;13:2169–74.
- [9] Farag A, Al-Baiyat S, Cheng TC. Economic load dispatch multiobjective optimization procedures using linear programming techniques. *IEEE Trans Power Syst* 1995;10:731–8.
- [10] Park JH, Kim YS, Eom IK, Lee KY. Economic load dispatch for piecewise quadratic cost function using Hopfield neural network. *IEEE Trans Power Syst* 1993;8(3):1030–8.
- [11] Lee KY, Yome AS, Park JH. Adaptive Hopfield neural networks for economic load dispatch. *IEEE Trans Power Syst* 1998;13(2):519–26.
- [12] Rifaat RM. Economic dispatch of combined cycle cogeneration plants with environmental constraints. *Proc Int Conf Energy Manag Power Deliv* 1998;1:149–53.
- [13] Jayabarathi T, Jayabarathi K, Jayakumar DN, et al. Evolutionary programming techniques for different kinds of economic dispatch problems. *Electric Power Syst Res* 2005;73:169–76.
- [14] Abido MA. A novel multiobjective evolutionary algorithm for environmental/economic power dispatch. *Electric Power Syst Res* 2003;65:71–81.
- [15] Gaing Z-L. Particle swarm optimization to solving the economic dispatch considering the generator constraints. *IEEE Trans Power Syst* 2003;18(3):1187–95.
- [16] Mahor A, Prasad V, Rangnekar S. Economic dispatch using particle swarm optimization: a review. *J Renew Sust Energy Rev* 2009;13:2134–41.
- [17] Sadeqheih A. Optimal design methodologies under the carbon emission trading program using MIP, GA, SA, and TS. *J Renew Sust Energy Rev* 2011;15:504–13.
- [18] Moura PS, de Almeida AT. Multi-objective optimization of a mixed renewable system with demand-side management. *J Renew & Sust Energy Rev* 2010;14:1461–8.
- [19] Rodriguez AA, Ault G, Galloway S. Multi-objective planning of distributed energy resources: a review of the state-of-the-art. *J Renew Sust Energy Rev* 2010;14:1353–66.
- [20] Song YH, Wang GS, Wang PV, Johns AT. Environmental/economic dispatch using fuzzy logic controlled genetic algorithms. *IEE Proc Gener Transm Distrib* 1997;144(4):377–82.
- [21] Roa-Sepulveda CA, Herrera M. A solution to the economic dispatch problem using decision trees. *Electric Power Syst Res* 2000;73:255–9.
- [22] Dhillon JS, Parti SC, Kothari DP. Stochastic economic emission load dispatch. *Electric Power Syst Res* 1993;26:179–86.
- [23] Venkatesh P, Gnanadass R, Narayana Prasad P. Comparison and application of evolutionary programming techniques to combined economic emission dispatch with line flow constraints. *IEEE Trans Power Syst* 2003;18(2):688–97.
- [24] Abido MA. A niched Pareto genetic algorithm for multiobjective environmental/economic dispatch. *Electric Power Energy Syst* 2003;25(2):97–105.
- [25] Abido MA. Environmental/economic power dispatch using multiobjective evolutionary algorithms. *IEEE Trans Power Syst* 2003;18(4):1529–37.
- [26] Hota PK, Dash SK. Multiobjective generation dispatch through a neuro-fuzzy technique. *Electric Power Compon Syst* 2004;32:1191–206.
- [27] Coello Coello CA, Pulido GT, Lechuga MS. Handling multiple objectives with particle swarm optimization. *IEEE Trans Evol Comput* 2004;8(3):256–79.
- [28] Delia Cioppa A, De Stefano C, Marcelli A. On the role of population size and niche radius in fitness sharing. *IEEE Trans Evol Comput* 2004;8(6):580–92.
- [29] Fieldsend JE, Everson RM, Singh S. Using unconstrained elite archives for multiobjective optimization. *IEEE Trans Evol Comput* 2003;7(3):305–23.
- [30] Pepermans G, Driesen J, Haeseldonckx D, Belmans R, D'haeseleer W. Distributed generation: definition, benefits and issues. *Energy Policy* 2005;33:787–98.
- [31] Lin CM, Gen M. Multi-criteria human resource allocation for solving multistage combinatorial optimization problems using multiobjective hybrid genetic algorithm. *Expert Syst Appl* 2008;34:2480–90.
- [32] Chang PC, Chen SH, Liu CH. Sub-population genetic algorithm with mining gene structures for multiobjective flowshop scheduling problems. *Expert Syst Appl* 2007;33:762–71.
- [33] Kennedy J, Eberhart R. *Swarm intelligence*. San Francisco: Morgan Kaufmann Publishers; 2001.
- [34] Kennedy J, Eberhart R. Particle swarm optimization. In: *IEEE proceedings of the international conference on neural networks*. 1995. p. 1942–8.
- [35] Niknam Taher, Zeinoddini Meymand Hamed, Nayeripour Majid. A practical algorithm for optimal operation management of distribution network including fuel cell power plants. *Renew Energy* 2010;35:1696–714.