



**AALBORG UNIVERSITY**  
DENMARK

**Aalborg Universitet**

## **Test Setup for Axially Loaded Piles in Sand**

Thomassen, Kristina

*Publication date:*  
2015

*Document Version*  
Publisher's PDF, also known as Version of record

[Link to publication from Aalborg University](#)

*Citation for published version (APA):*  
Thomassen, K. (2015). *Test Setup for Axially Loaded Piles in Sand*. Department of Civil Engineering : Aalborg University. DCE Technical reports No. 195

### **General rights**

Copyright and moral rights for the publications made accessible in the public portal are retained by the authors and/or other copyright owners and it is a condition of accessing publications that users recognise and abide by the legal requirements associated with these rights.

- Users may download and print one copy of any publication from the public portal for the purpose of private study or research.
- You may not further distribute the material or use it for any profit-making activity or commercial gain
- You may freely distribute the URL identifying the publication in the public portal -

### **Take down policy**

If you believe that this document breaches copyright please contact us at [vbn@aub.aau.dk](mailto:vbn@aub.aau.dk) providing details, and we will remove access to the work immediately and investigate your claim.



**DEPARTMENT OF CIVIL ENGINEERING**  
AALBORG UNIVERSITY

# Test Setup for Axially Loaded Piles in Sand

Kristina Thomassen





Aalborg University  
Department of Civil Engineering  
Division of Structures, Materials and Geotechnics

**DCE Technical Report No. 195**

# **Test Setup for Axially Loaded Piles in Sand**

by

Kristina Thomassen

October 2015

© Aalborg University

## Scientific Publications at the Department of Civil Engineering

**Technical Reports** are published for timely dissemination of research results and scientific work carried out at the Department of Civil Engineering (DCE) at Aalborg University. This medium allows publication of more detailed explanations and results than typically allowed in scientific journals.

**Technical Memoranda** are produced to enable the preliminary dissemination of scientific work by the personnel of the DCE where such release is deemed to be appropriate. Documents of this kind may be incomplete or temporary versions of papers—or part of continuing work. This should be kept in mind when references are given to publications of this kind.

**Contract Reports** are produced to report scientific work carried out under contract. Publications of this kind contain confidential matter and are reserved for the sponsors and the DCE. Therefore, Contract Reports are generally not available for public circulation.

**Lecture Notes** contain material produced by the lecturers at the DCE for educational purposes. This may be scientific notes, lecture books, example problems or manuals for laboratory work, or computer programs developed at the DCE.

**Theses** are monographs or collections of papers published to report the scientific work carried out at the DCE to obtain a degree as either PhD or Doctor of Technology. The thesis is publicly available after the defence of the degree.

**Latest News** is published to enable rapid communication of information about scientific work carried out at the DCE. This includes the status of research projects, developments in the laboratories, information about collaborative work and recent research results.

Published Department of Civil Engineering by  
Aalborg University  
Department of Civil Engineering  
Sofiendalsvej 9-11  
DK-9200 Aalborg SV, Denmark

Printed in Aalborg at Aalborg University

ISSN 1901-726X  
DCE Technical Report No. 195

## Contents

1	Objective.....	4
2	Test Setup for axially loaded piles in sand .....	4
2.1	Sand Box .....	5
2.2	Soil Properties.....	6
2.3	Pile Specifications .....	7
2.4	Increasing Effective Stresses .....	7
3	Specifications of Test Parts.....	9
4	Data Acquisition Devices .....	9
4.1	HBM Spider8.....	9
4.2	HBM MGCplus .....	10
4.3	MOOG Modular Test Controller .....	11
5	Data Acquisition Software .....	11
6	Devices for Soil Preparation .....	12
6.1	Ascension Pipe.....	12
6.2	Rod Vibrator .....	12
6.3	CPT–device .....	12
7	Hydraulic Systems.....	13
7.1	Hydraulic System for Installation, Uninstallation and CPT .....	13
7.2	Hydraulic System for Tests .....	14
8	Measuring Devices and Configuration for Installation.....	15
8.1	Displacement Transducer WS15KT.....	16
8.2	Load Cell 1 .....	17
9	Measuring Devices and Configuration for CPT.....	19
9.1	CPT Device .....	19
10	Measuring Devices and Configuration for Tests.....	20
10.1	Load Cell 2 .....	22
10.2	Displacement of Hydraulic Cylinder 2 .....	22
10.3	Displacement Transducers WS10-1 and WS10-2 .....	23
10.4	Pore Pressure Transducers .....	24
10.5	Membrane Suction Transducer .....	25
10.6	Air Pressure Transducer .....	26

## Test Setup for Axially Loaded Piles in Sand

10.7	Vacuum Pump .....	27
10.8	Pressurised Tube .....	27
11	Measuring Devices and Configuration for Uninstallation .....	27
12	Miscellaneous Equipment .....	28
12.1	Aluminium Frames.....	28
12.2	For workspace .....	28
12.3	Transition Pieces.....	28
12.4	Felt Cloth and Membrane.....	29
12.5	Tools .....	29
13	Bibliography.....	30

## Test Setup for Axially Loaded Piles in Sand



## 1 Objective

The test setup for testing axially static and cyclic loaded piles in sand is described in the following. The purpose for the tests is to examine the tensile capacity of axially loaded piles in dense fully saturated sand. The pile dimensions are chosen to resemble full scale dimension of piles used in offshore pile foundations today.

## 2 Test Setup for axially loaded piles in sand

Figure 1 shows the test setup and Figure 2 a principal sketch of the test setup.



Figure 1: Test setup with applied suction.

## Test Setup for Axially Loaded Piles in Sand

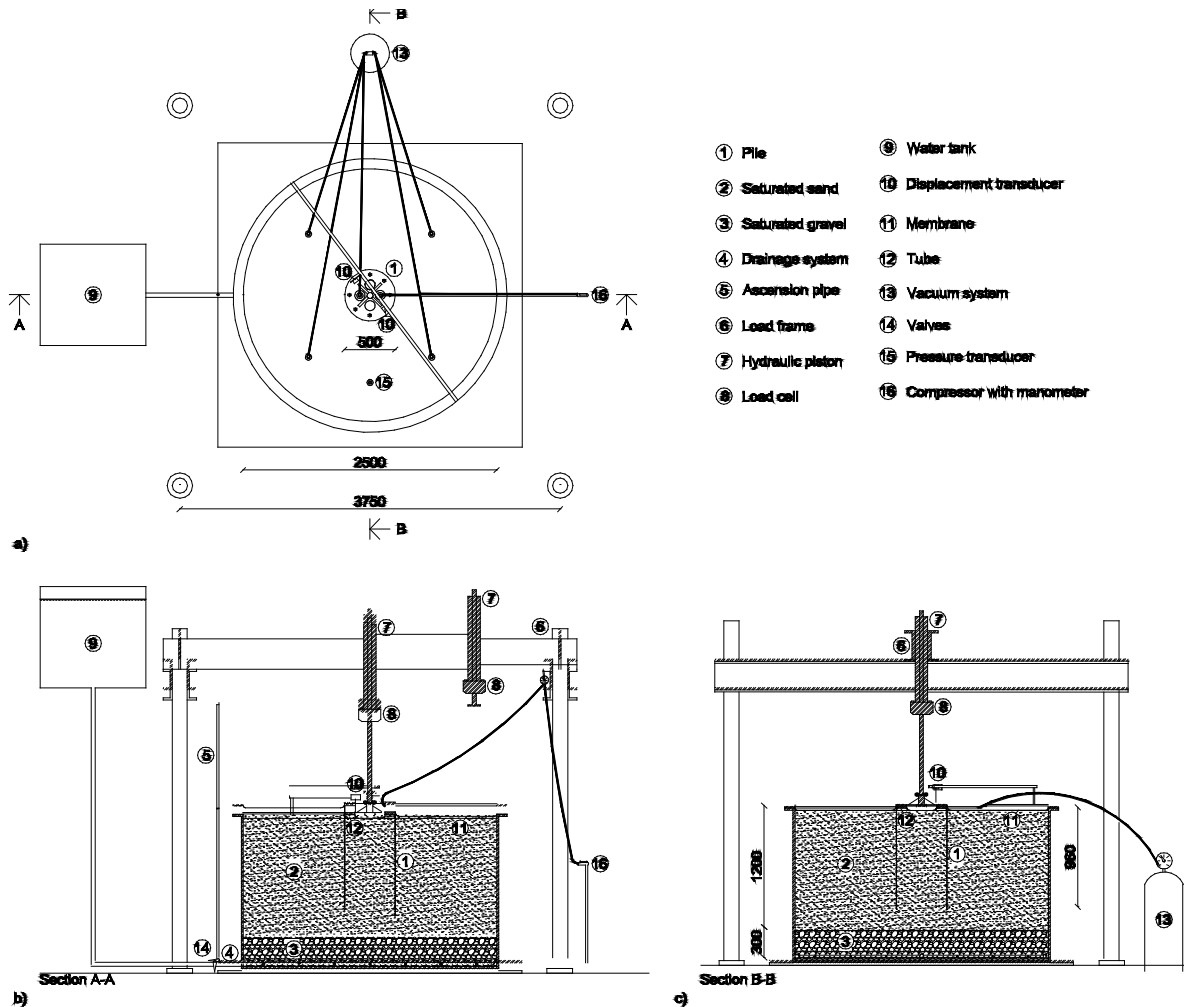


Figure 2: a) Layout of the test setup; b) Section A-A cross-sectional view of the test setup; c) Section B-B cross-sectional view of the test setup.

### 2.1 Sand Box

The sand box has internal dimensions of  $D = 2.5$  m and  $h = 1.2$  m. To get saturated sand, it is necessary to let water in and out of the sand box, therefore, a drainage system is placed in the bottom of the sand box. The drainage system consists of perforated pipes equally placed in 30 cm of gravel. The gravel is covered by a felt cloth to prevent the sand to enter the drainage system. Above the felt cloth, 1.2 m of Baskarp Sand No. 15 is placed.

The pipes in the drainage system are connected to a water tank located above the sand box. From this tank, water is led into the sand box while controlling the gradient of the water through the sand by monitoring the water head in the ascension pipe, cf. Figure 3.



Figure 3: The drainage pipes in the bottom of the sand box. The water tank. The ascension pipe.

## 2.2 Soil Properties

When doing laboratory testing of offshore foundations at Aalborg University, Baskarp Sand No. 15 is used. The material properties for this type of sand are well-defined from previous tests at Aalborg University (Borup og Hedegaard 1995). However, for the presented test setup, a new load of Baskarp Sand No. 15 was purchased in 2012. The new sand is also Baskarp Sand No. 15 and Figure 4 shows that the sieve analyses give the same grain distribution as the sand from 1995. However, no classification tests are conducted on the new load of sand, and it is just assumed that the two sands have the same properties.

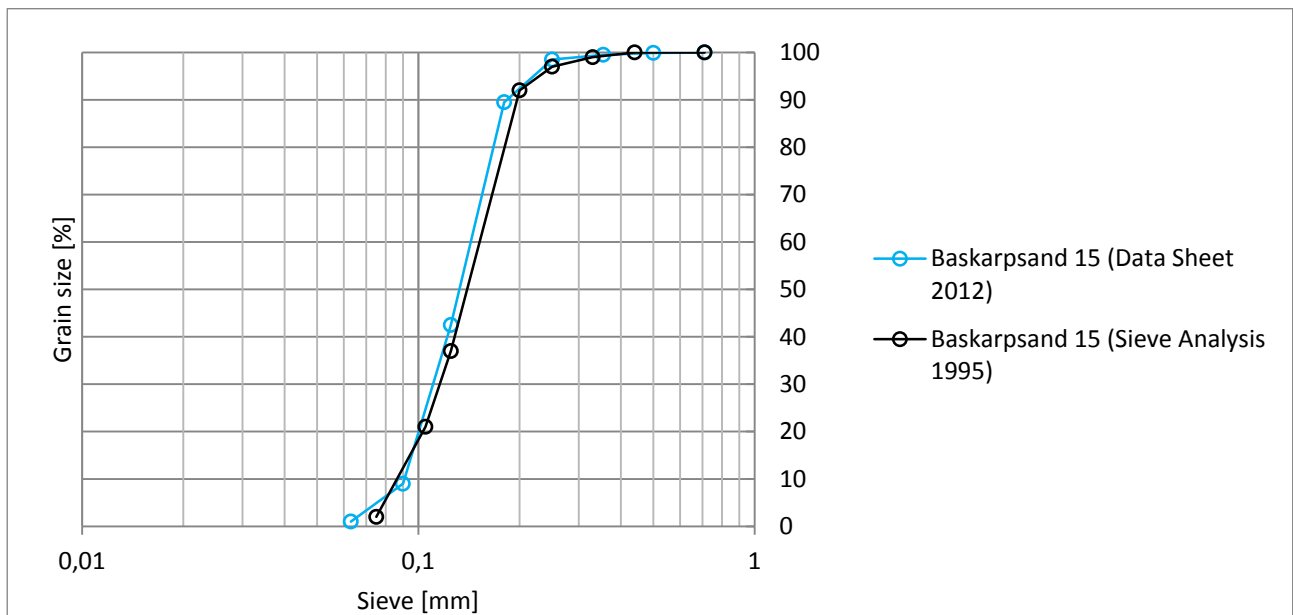


Figure 4: Sieve analyses for the old and new Baskarp Sand No. 15 (Borup og Hedegaard 1995) (SibelcoNordic 2008).

Table 1: Material properties for Baskarp Sand No. 15 (Borup og Hedegaard 1995).

Specific grain density	$d_s$	$[g/cm^3]$	2.64
Maximum void ratio	$e_{max}$	$[-]$	0.854
Minimum void ratio	$e_{min}$	$[-]$	0.549
50%-quantile	$d_{50}$	$[mm]$	0.14
Uniformity coefficient	$c_u = d_{60}/d_{10}$	$[-]$	1.78

### 2.3 Pile Specifications

Figure 5 shows the pile segment is made of steel and is 1 m long and has a diameter of 0.5 m. The wall thickness is 3 mm, which gives a diameter to wall thickness ratio of 17. According to (Randolph og Gourvenec 2011) the smallest offshore piles have a diameter from around 0.76 m and beyond and diameter to wall thickness ratios vary between 25 and 100. Therefore, the pile segment has a diameter which is smaller than the piles used in reality but is much closer to full scale than piles usually used in laboratory tests to understand the processes under axial loading. The smaller diameter to wall thickness ratio of the specimen compared to full scale is not important as long as it is large enough to avoid instability of the pile wall during use. Besides the ratio only has an impact on the base resistance of the pile and the test pile is loaded in tension only.

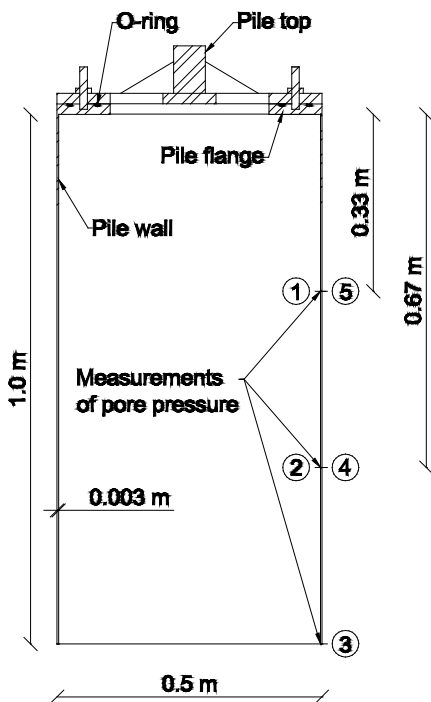


Figure 5: Principal sketch of the pile segment.

The pore pressure along the pile shaft is measured  $1/3 L$  and  $2/3 L$  from the pile top both on the inside and on the outside of the pile shaft. Moreover it is measured at the tip of the pile. Figure 5 shows the positions of the pipes 1-5 connected to the pore pressure transducers on the pile. The pore pressure transducers placed on top of the pile. The specifications of the pore pressure transducers are given in Section Figure 5.

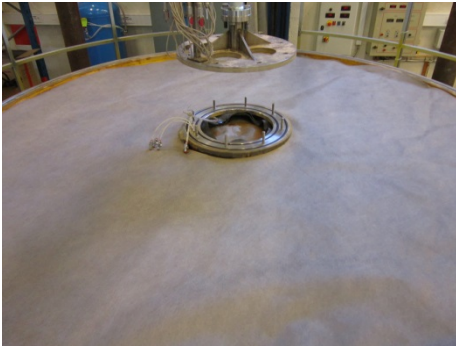
Figure 5 shows the position of pore pressure measurements. The external displacement transducers WS10-1 and WS10-2 are during tests positioned opposite each other connected to the nuts tightening the pile lid and the pile flange.

### 2.4 Increasing Effective Stresses

The effective stresses in the soil are increased by covering the soil surface inside and outside the pile segment with a rubber membrane and applying suction underneath it. Hereby, overlaying soil layers are simulated due to the increase of effective stresses. Thereby, the soil-pile interface behaviour can be

## Test Setup for Axially Loaded Piles in Sand

investigated at various soil depths. To make sure that the suction is applied equally over the sand layer and to avoid that sand is sucked into the tubes, a felt cloth is placed between the sand and the membrane.



**Figure 6: Felt cloth positioned on the sand surface.**

The suction is controlled by a vacuum pump. The manometer on the vacuum system can be used as an indicator when regulating the pressure. However, to get the precise value of the suction it is necessary to attach a pressure transducer to the membrane and connect it to the MGCplus and monitor the pressure in Catman.



**Figure 7: Vacuum system.**

The suction is applied through four hoses connected to the membrane by means of quick-couplings, cf. Figure 8. The membrane is tightened at the edge of the sandbox by an aluminium frame, in the edge is a groove and the membrane is pressed into this groove between two O-rings making the connection air tight, cf. Figure 9a. The same assembly technique is used to tighten the membrane to the pile leaving room for holes in the membrane to lead the pore pressure pipes and bolts used to assemble the pile to the loading plate through, cf. Figure 9b. Here it is necessary with two O-rings, one on each side of the holes. It is important that the sand is 100% saturated and that very few air bobbles are present in the sand before applying the suction because the air expands under vacuum and will press the water out of the sand through the suction hoses. This will result in partially drained instead of fully saturated sand.

## Test Setup for Axially Loaded Piles in Sand

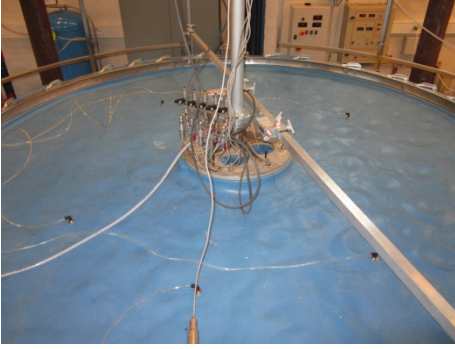


Figure 8: Membrane on sand surface connected to the vacuum pump by hoses.

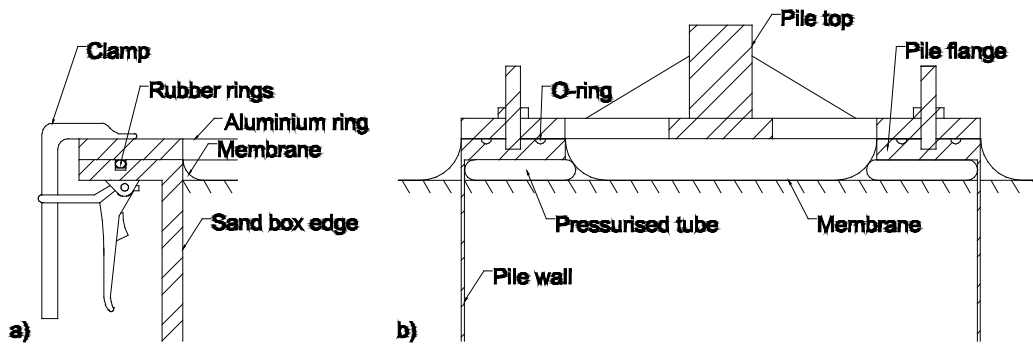


Figure 9: Sealing of the membrane at a) the sand box edge and b) at the pile flange.

### 3 Specifications of Test Parts

The test procedure consists of five parts:

- Installation
- Soil preparation
- CPT
- Test
- Uninstallation

The necessary equipment and specifications are given in the tables in Appendix A.

### 4 Data Acquisition Devices

#### 4.1 HBM Spider8

Spider8 is used for data acquisition from CPT device, Load cell 1 and WS17kt.



## Test Setup for Axially Loaded Piles in Sand



Figure 10: Left: Front of Spider8. Right: CPT device, Load cell 1 and displacement transducer connected to Spider8



Figure 11: The CPT device is connected to Spider8 through the box on the load frame through the socket "Cone" and the displacement transducer is connected via the socket "WS17kt".

### 4.2 HBM MGCplus

The MGCplus is used for data acquisition from the pore pressure transducers, the air pressure transducer, the membrane pressure transducer, the real pile head displacement and the load and displacement recorded by MOOG.



Figure 12: Left: Front of MGCplus. Right: the pore pressure transducers, the air pressure transducer, the membrane pressure transducer, the real pile head displacement and the load and displacement recorded by MOOG connected to MGCplus.

## Test Setup for Axially Loaded Piles in Sand



Figure 13: The displacement transducers are connected to MGCplus via the sockets “WS10-1” and “WS10-2”. The pore pressure transducers are connected through CH6-1, CH6-2, CH6-5, CH6-6 and CH6-7. The membrane pressure transducer is connected to MGCplus via CH6-8.

### 4.3 MOOG Modular Test Controller

The modular test controller is connected to the MOOG computer, load cell 1, the displacement transducer and the MGCplus. The test specifications is given in the program MOOG and executed by the modular test controller.



Figure 14: MOOG Modular Test Controller.

## 5 Data Acquisition Software

The measurements of the devices connected to Spider8 and MGCplus are recorded in Catman 6.0.

The test sequences are made and measurements of the devices connected to the Modular Test Controller are recorded in the MOOG Integrated Test Suite V.2.6.4.



## 6 Devices for Soil Preparation

### 6.1 Ascension Pipe



### 6.2 Rod Vibrator

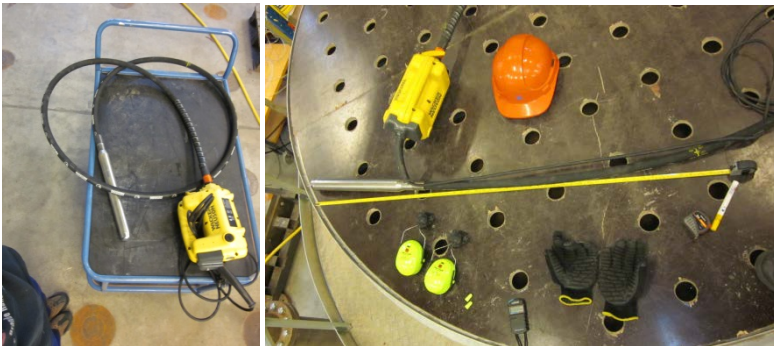


Figure 15: Rod vibrator and equipment for the vibration procedure.

### 6.3 CPT-device

The dimensions of the CPT are given in Figure 12. The cone has a diameter of 15 mm and a 30 degree inclination. The CPT device can only measure the cone resistance and not the sleeve friction and the pore pressure. The cone resistance is measured by four strain gauges placed in a full bridge of the type TML FLE-1-11 with gauge factor 2.03, cf. Figure 13. A more detailed description of the CPT-device and the basis for interpretation of soil parameters for Baskarp Sand No. 15 (aka Aalborg Universitets Sand No 1.) from the CPT measurements is found in Larsen (2008, App. A).

The CPT must be re-calibrated regularly. The calibration procedure is described in App. A. Interpretation of the CPT measurements based on (Larsen 2008) and (Ibsen, et al. 2009) is given in App. B.



Figure 16: CPT-device.

## Test Setup for Axially Loaded Piles in Sand

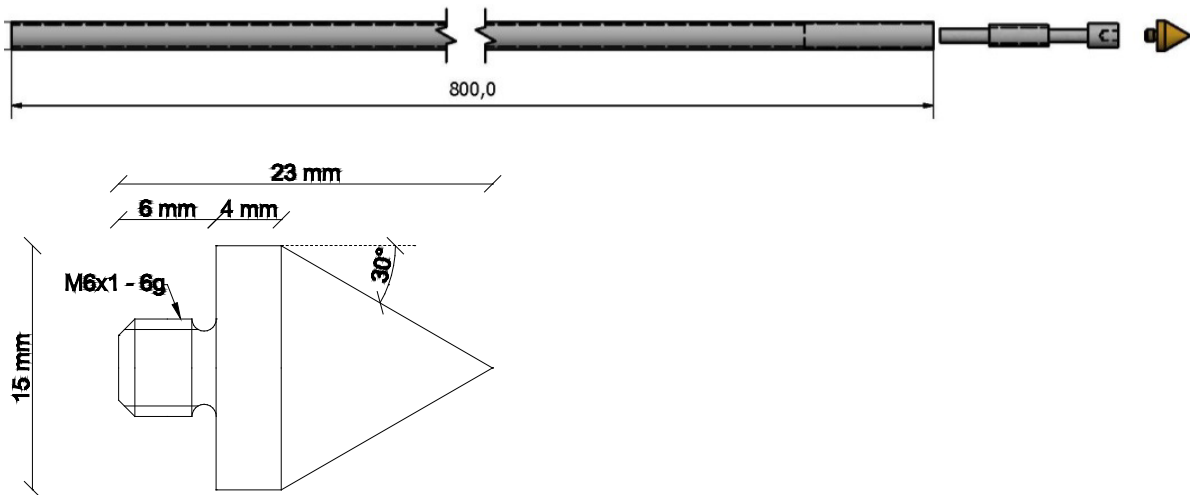


Figure 17: Dimensions of the CPT bar and cone.



Figure 18: Strain gauges and wiring inside the CPT to measure the cone resistance.

## 7 Hydraulic Systems

### 7.1 Hydraulic System for Installation, Uninstallation and CPT

Hydraulic cylinder 1, which is used during installation, uninstallation and CPTs, is the one to the right on Figure 1. The pump pressure is regulated according to the measured displacement rate of the cylinder.



Figure 19: Hydraulic station.

## Test Setup for Axially Loaded Piles in Sand

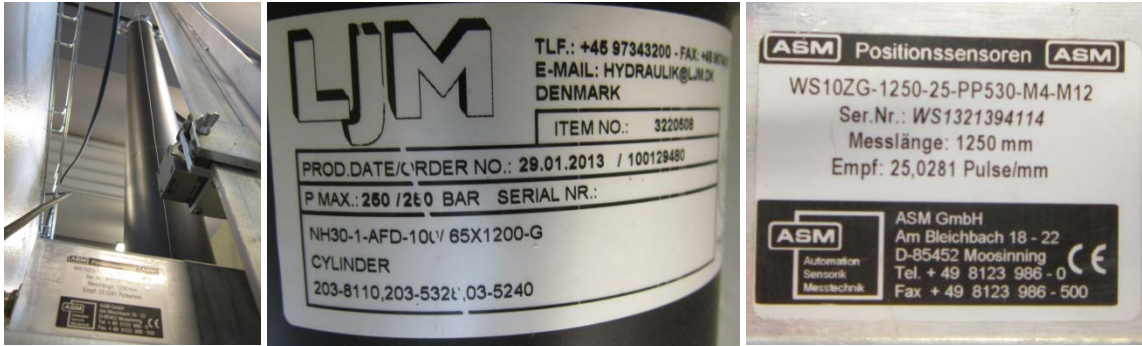


Figure 20: Hydraulic cylinder 1 and position transducer.

The cylinder can only be displacement controlled. The speed is adjusted on the black knob in the upper left corner of the switchboard. The intended speed is then displayed below the knob. While moving hydraulic cylinder 1 down the actual speed is measured and displayed to the right of the knob. The speed can then be adjusted during driving until an actual speed of e.g. 5 mm/s is reached. On the controller for hydraulic cylinder 1 two different speeds can be used. If the black knob on the controller is in horizontal or slightly upward position, the speed of hydraulic cylinder 1 corresponds to the speed chosen on switchboard. If the knob on the controller is turned downwards the hydraulic cylinder moves at maximum speed which is 6.18 mm/s.

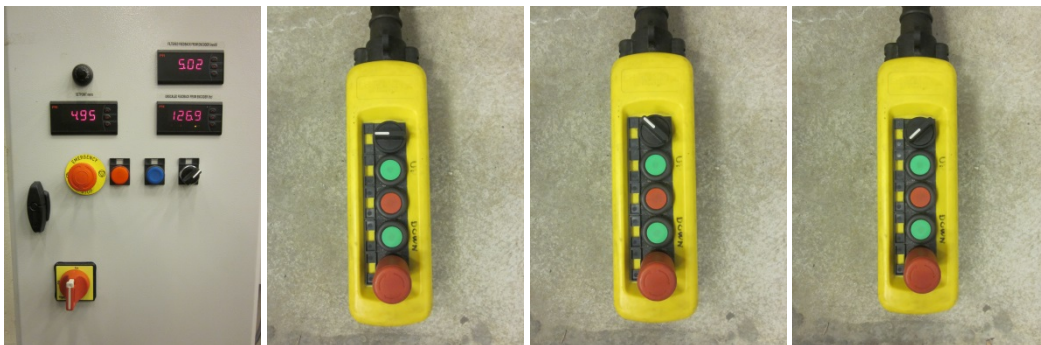


Figure 21: Switchboard and controller for hydraulic cylinder 1.

## 7.2 Hydraulic System for Tests

Hydraulic cylinder 2 used for tests is the one to the left on Figure 1. The hydraulics is turned on at the switchboard. The pressure in the cylinder rises from 0 bars to 200 bars.

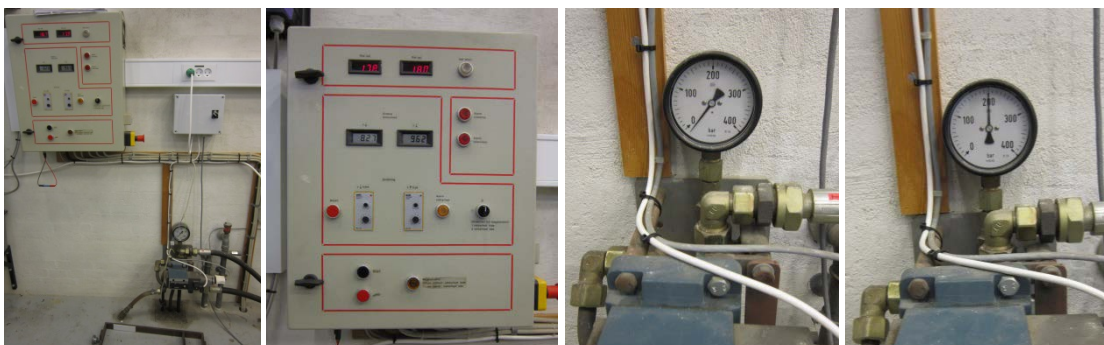


Figure 22: Hydraulic station and switchboard.

## Test Setup for Axially Loaded Piles in Sand

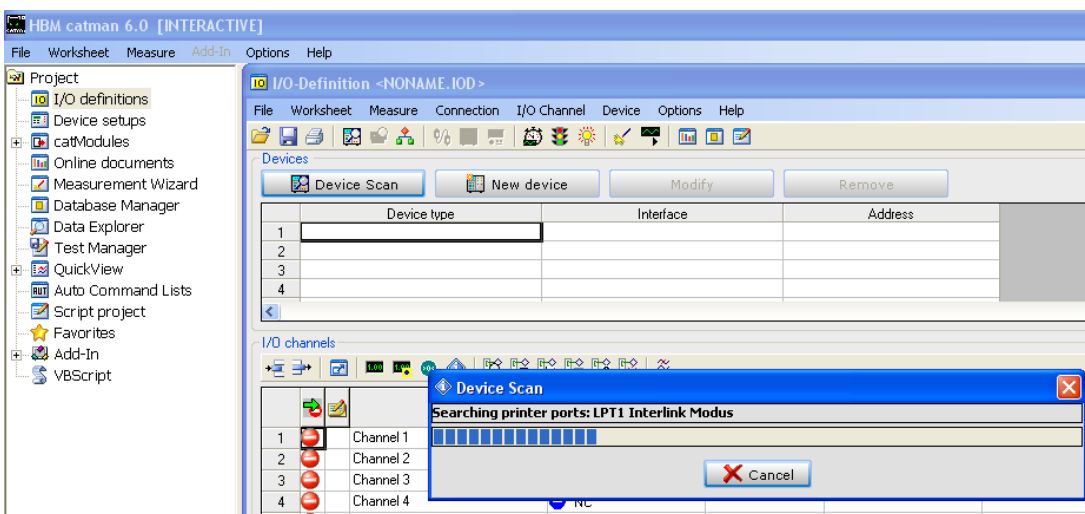
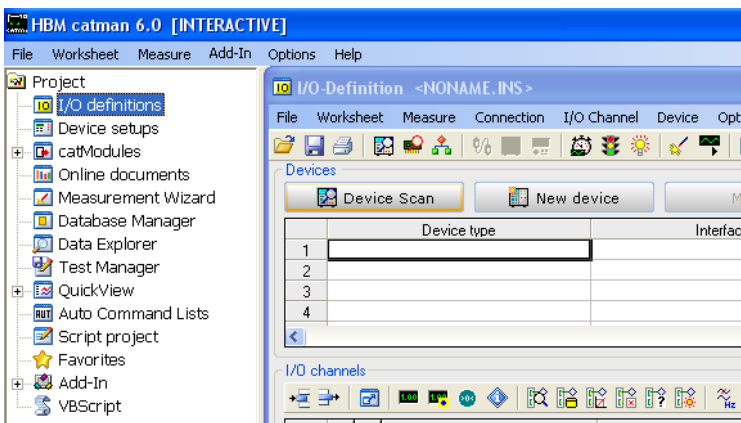
Hydraulic cylinder 1 can either be displacement or force controlled.



Figure 23: Hydraulic cylinder 2.

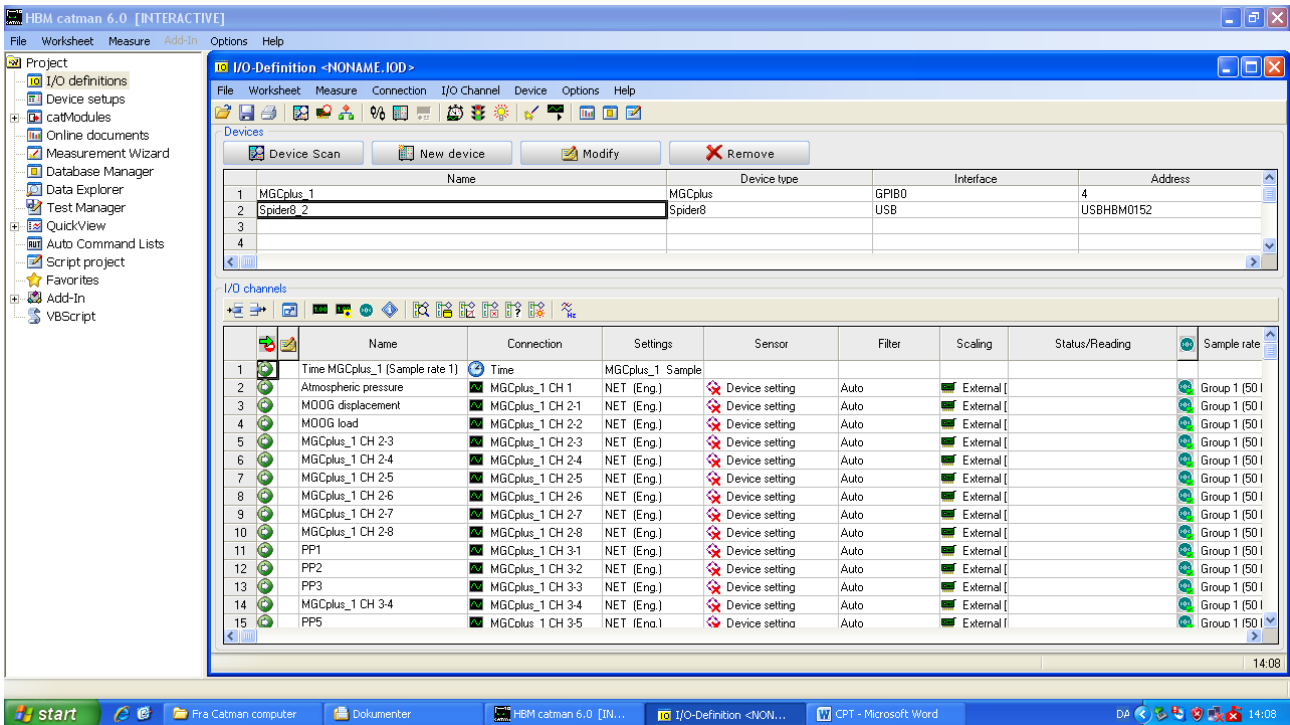
## 8 Measuring Devices and Configuration for Installation

In order to configure the different measuring devices in Catman it is necessary to make a device scan in Catman to locate Spider8 and MGCplus connected to the computer. Open Catman and press device scan.





## Test Setup for Axially Loaded Piles in Sand



### 8.1 Displacement Transducer WS15KT

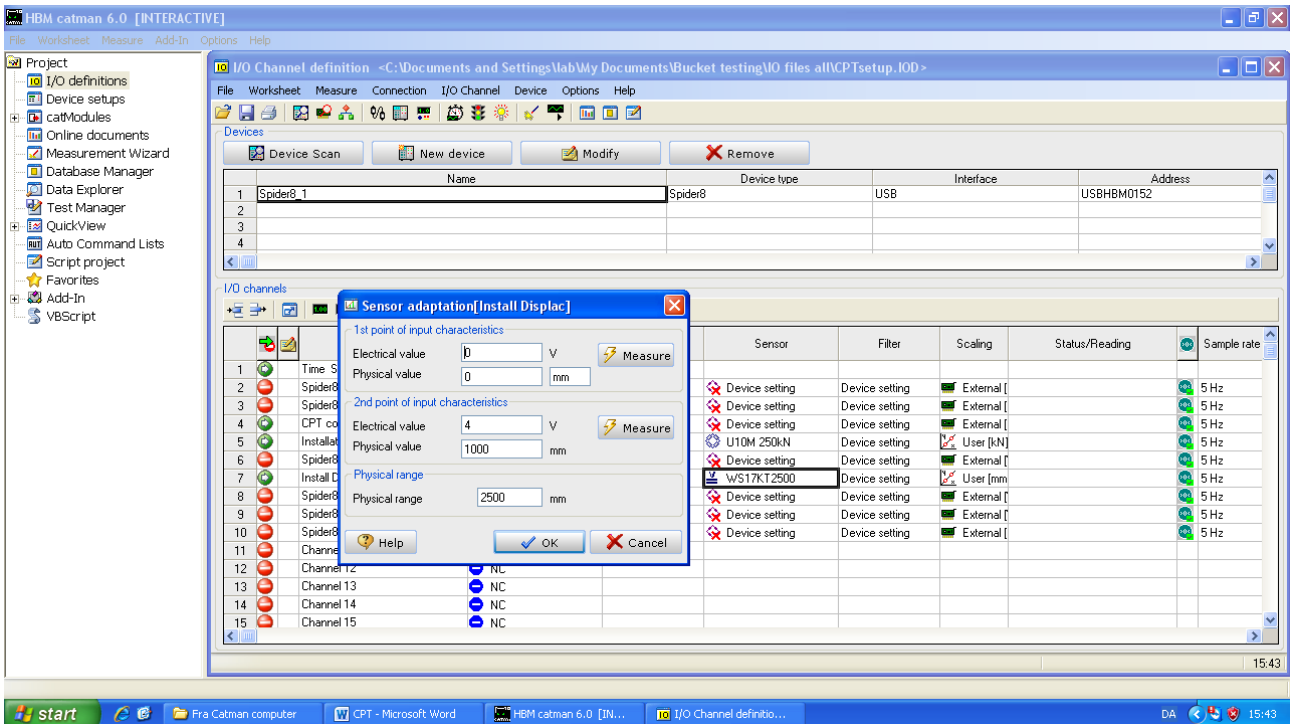
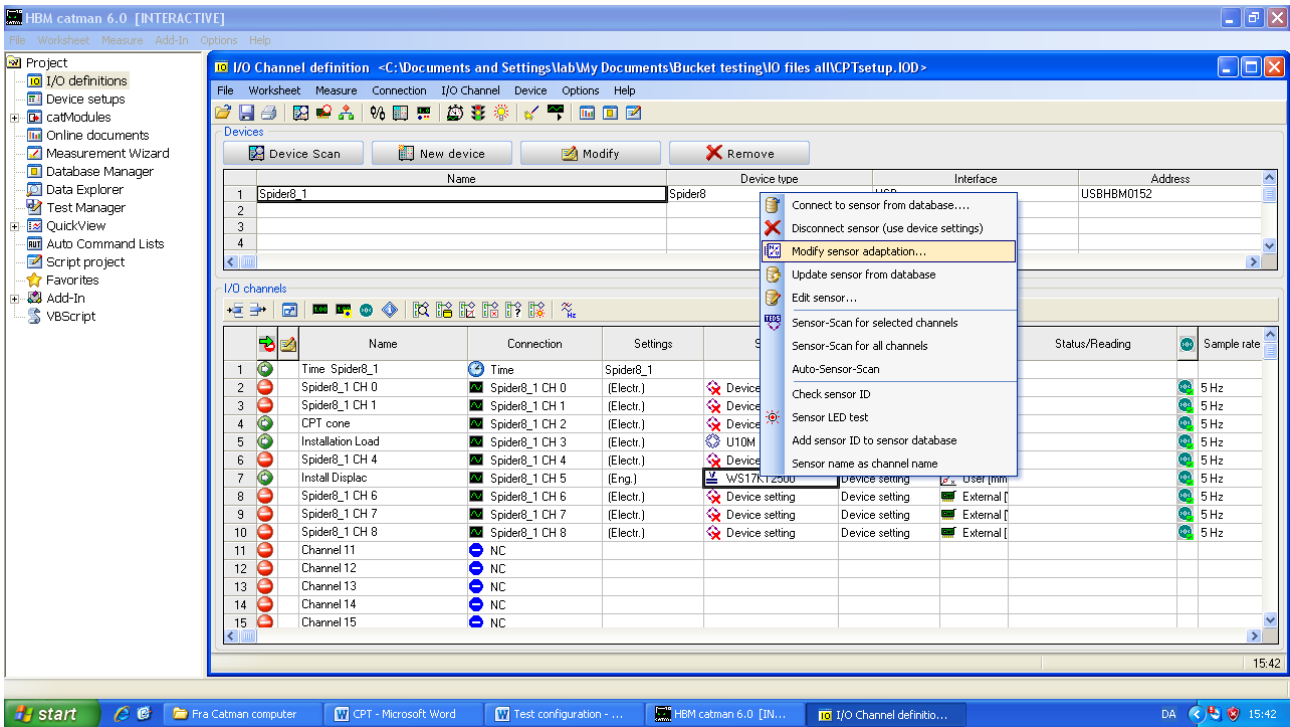
The displacement of hydraulic cylinder 1 is measured by a displacement transducer with a max range of 2500 mm. The transducer is connected to the Spider8 and the measurements are recorded in Catman.



Figure 24: Displacement transducer for hydraulic cylinder 1.

The configuration in Catman is as follows.

## Test Setup for Axially Loaded Piles in Sand



### 8.2 Load Cell 1

Load cell 1 is connected to Spider8 and the measurements are recorded by Catman.

## Test Setup for Axially Loaded Piles in Sand

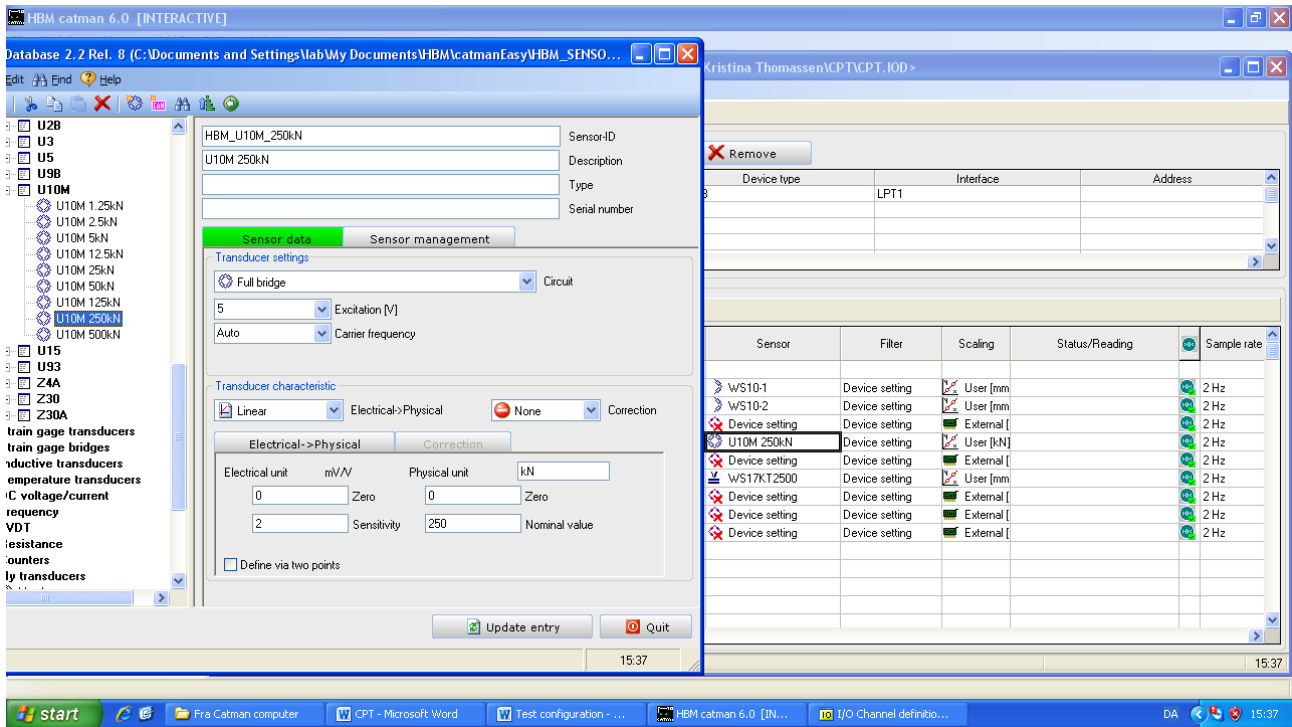


Figure 25: Load cell 1.

The load cell is a standard HBM device and its configuration can be found in the sensor database within Catman as follows. Right click on the Sensor column and chose “Connect to sensor from database”.

Name	Connection	Settings	Sensor
1 Time Spider8_1	Time	Spider8_1	
2 Displacement 1	Spider8_1 CH 0 (Electr.)	WS10-1	De
3 Displacement 2	Spider8_1 CH 1 (Electr.)	WS10-2	De
4 CPT Cone	Spider8_1 CH 2 (Electr.)	Device setting	De
5 Installation Load	Spider8_1 CH 3 (Eng.)	U10M 250kN	De
6 CH 4	Spider8_1 CH 4 (Electr.)	Device setting	De
7 CPT/Install Displacement	Spider8_1 CH 5 (Electr.)	WS17K.T2500	De
8 CH 6	Spider8_1 CH 6 (Electr.)	Device setting	De
9 CH 7	Spider8_1 CH 7 (Electr.)	Device setting	De
10 CH 8	Spider8_1 CH 8 (Electr.)	Device setting	De
11 Channel 11	NC		
12 Channel 12	NC		
13 Channel 13	NC		
14 Channel 14	NC		
15 Channel 15	NC		

## Test Setup for Axially Loaded Piles in Sand

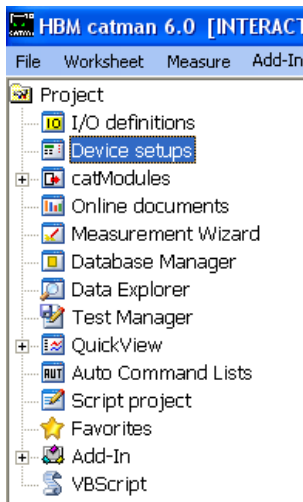


## 9 Measuring Devices and Configuration for CPT

The configuration of the displacement transducer WS15KT and Load cell 1 is presented in Chapter 8.

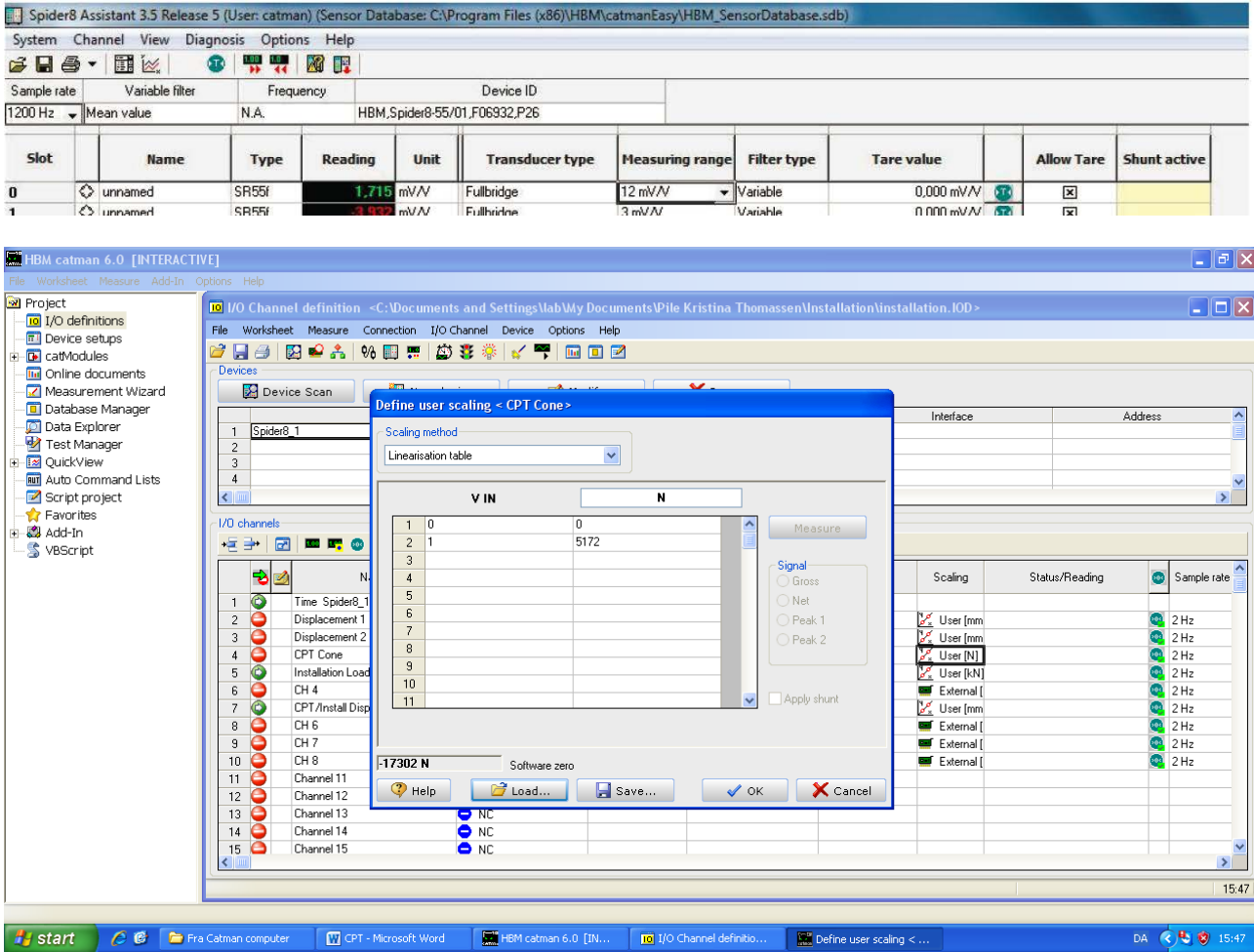
### 9.1 CPT Device

For the configuration of the CPT device open the Device Setup and set the measuring range to 12 mV/V. Return to the I/O Definition and in Scaling choose User and define a linear relationship between the output in mV/V and Newton given by the calibration factor found by the procedure described in Appendix B.





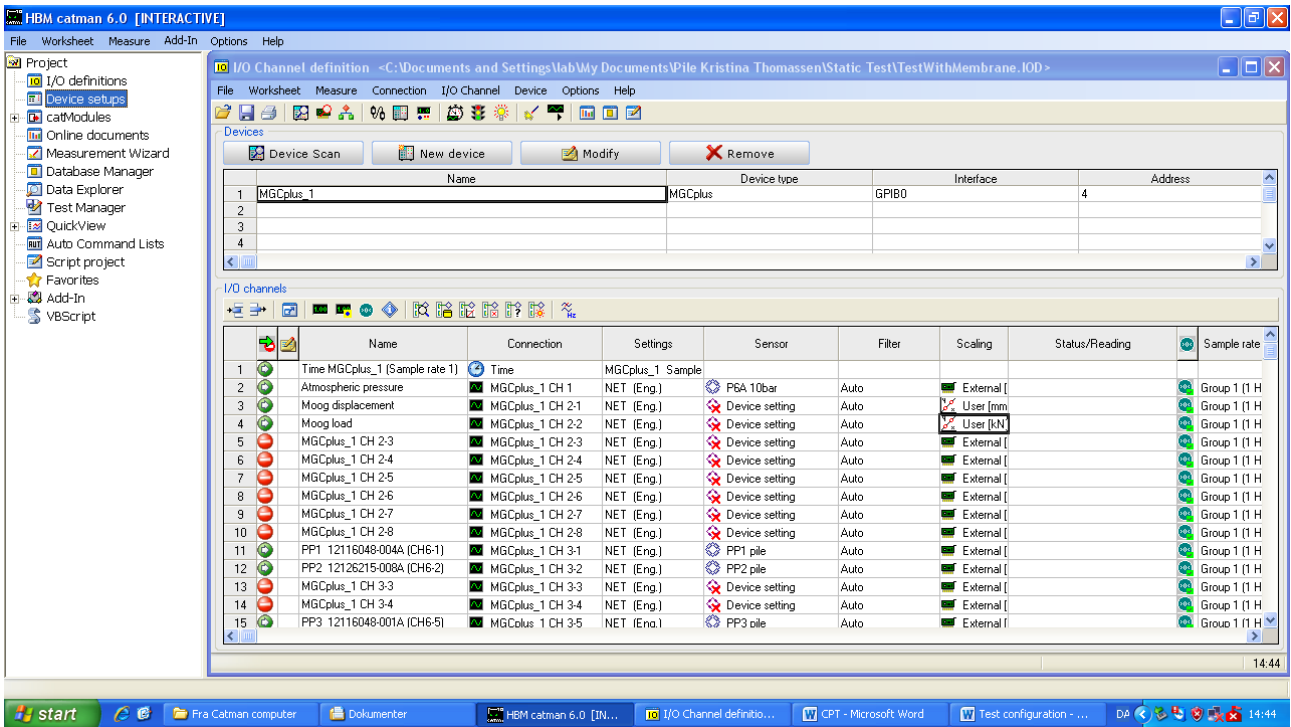
## Test Setup for Axially Loaded Piles in Sand



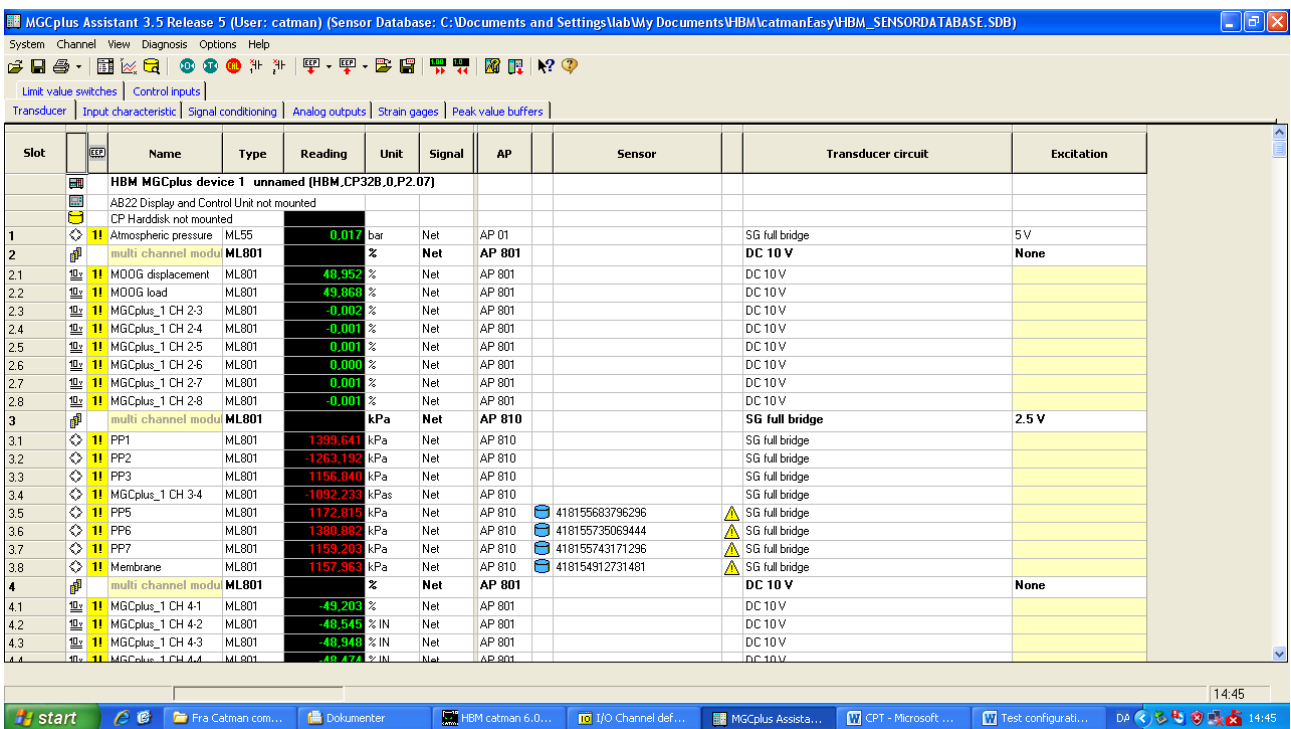
## 10 Measuring Devices and Configuration for Tests

The configuration of the measuring devices in Catman is started by turning on the MGCplus starting Catman and making a Device Scan. Both used and unused channels of the MGCplus connection boards are displayed in I/O definitions. The names of the channels of the connected measurement devices can be changed appropriately.

# Test Setup for Axially Loaded Piles in Sand



After the configuration of the measuring devices as described in the following, check the Device setups. Make sure that the Transducer circuit and the Excitation is correct for all devices.



Slot	Name	Type	Reading	Unit	Signal	AP	Sensor	Transducer circuit	Excitation
<b>HBM MGCPplus device 1 unnamed (HBM_CP32B_0.P2.07)</b>									
AB22 Display and Control Unit not mounted									
CP Harddisk not mounted									
1	Atmospheric pressure	ML55	0.017	bar	Net	AP 01		SG full bridge	5V
2	multi channel modu	ML801	%	%	Net	AP 801		DC 10 V	None

## Test Setup for Axially Loaded Piles in Sand

Slot	Icon	Name	Type	Reading	Unit	Signal	AP	Sensor	Transducer circuit	Excitation
<b>HBM MGCplus device 1 unnamed (HBM.CP32B_0.P2.07)</b> AB22 Display and Control Unit not mounted CP Harddisk not mounted										
1	⏏	Atmospheric pressure	ML55	0.017	bar	Net	AP 01		SG full bridge	5V
2	⏏	multi channel modul	ML801		%	Net	AP 801		DC 10 V	None
2.1	⏏	MOOG displacement	ML801	48.952	%	Net	AP 801		DC 10V	
2.2	⏏	MOOG load	ML801	49.868	%	Net	AP 801		DC 10V	
2.3	⏏	MGCplus_1 CH 2-3	ML801	-0.002	%	Net	AP 801		DC 10V	
2.8	⏏	MGCplus_1 CH 2-8	ML801	-0.001	%	Net	AP 801		DC 10V	
3	⏏	multi channel modul	ML801		kPa	Net	AP 810		SG full bridge	2.5 V
3.1	⏏	PP1	ML801	1399.641	kPa	Net	AP 810		SG full bridge	
3.2	⏏	PP2	ML801	-1263.192	kPa	Net	AP 810		SG full bridge	
3.3	⏏	PP3	ML801	1156.840	kPa	Net	AP 810		SG full bridge	
3.4	⏏	MGCplus_1 CH 3-4	ML801	-1092.233	kPa	Net	AP 810		SG full bridge	
3.5	⏏	PP5	ML801	1172.815	kPa	Net	AP 810	418155683796296	SG full bridge	⚠
3.6	⏏	PP6	ML801	1380.882	kPa	Net	AP 810	418155735069444	SG full bridge	⚠
3.7	⏏	PP7	ML801	1159.203	kPa	Net	AP 810	418155743171296	SG full bridge	⚠
3.8	⏏	Membrane	ML801	1157.963	kPa	Net	AP 810	418154912731481	SG full bridge	⚠
4	⏏	multi channel modul	ML801		%	Net	AP 801		DC 10 V	None
5.8	⏏	MGCplus_1 CH 5-8	ML801	0.000	%	Net	No AP		No AP	
6	⏏	multi channel modul	ML801		mm	Net	AP 836i		potentiometer	10 V
6.1	⏏	WS10-1	ML801	-137.398	mm	Net	AP 836i	4179438375	potentiometer	⚠
6.2	⏏	MGCplus_1 CH 6-2	ML801	-148.059	mm	Net	AP 836i		potentiometer	
6.4	⏏	MGCplus_1 CH 6-4	ML801	-148.059	mm	Net	AP 836i		potentiometer	
6.5	⏏	WS10-2	ML801	-139.378	mm	Net	AP 836i	41794385775463	potentiometer	⚠
6.6	⏏	MGCplus_1 CH 6-6	ML801	-148.059	mm	Net	AP 836i		potentiometer	

### 10.1 Load Cell 2

The load cell is connected to the Modular Test Controller and the measurements are recorded by both MOOG and Catman.



Figure 26: Load cell 2.

Like Load cell 1, Load cell 2 is a standard HBM transducer and can be found in the same manner in the Catman Database.

### 10.2 Displacement of Hydraulic Cylinder 2

The vertical position of hydraulic cylinder 2 is measured by a displacement transducer connected to the MOOG Modular Test Controller.

## Test Setup for Axially Loaded Piles in Sand



Figure 27: Displacement transducer for Hydraulic cylinder 2.

### 10.3 Displacement Transducers WS10-1 and WS10-2

The real displacement of the pile head is measured by means of two ASM WS10 displacement transducers with a range of 0–125 mm. The displacement transducers are connected to Spider8 and the data are recorded in Catman.

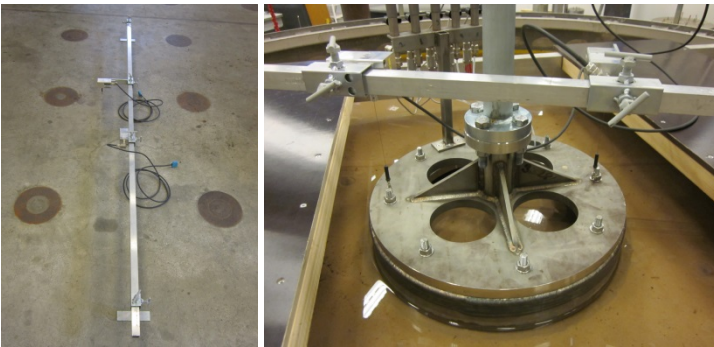


Figure 28: Left: Bar on which the transducers are positioned. Right: Position of the displacement transducers above the pile lid.



Figure 29: Displacement transducer WS10-1.

## Test Setup for Axially Loaded Piles in Sand

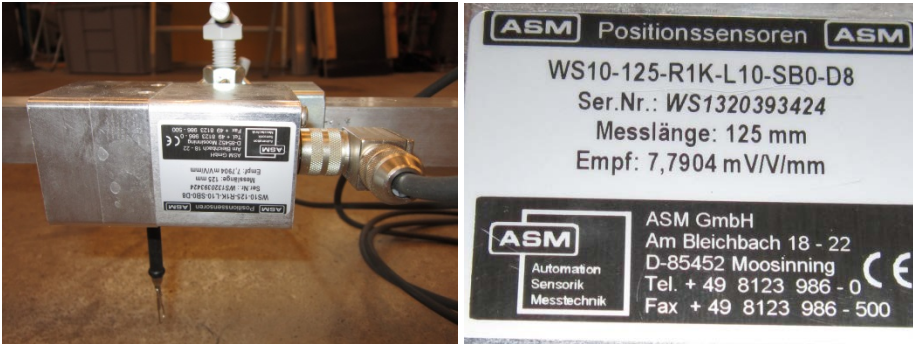
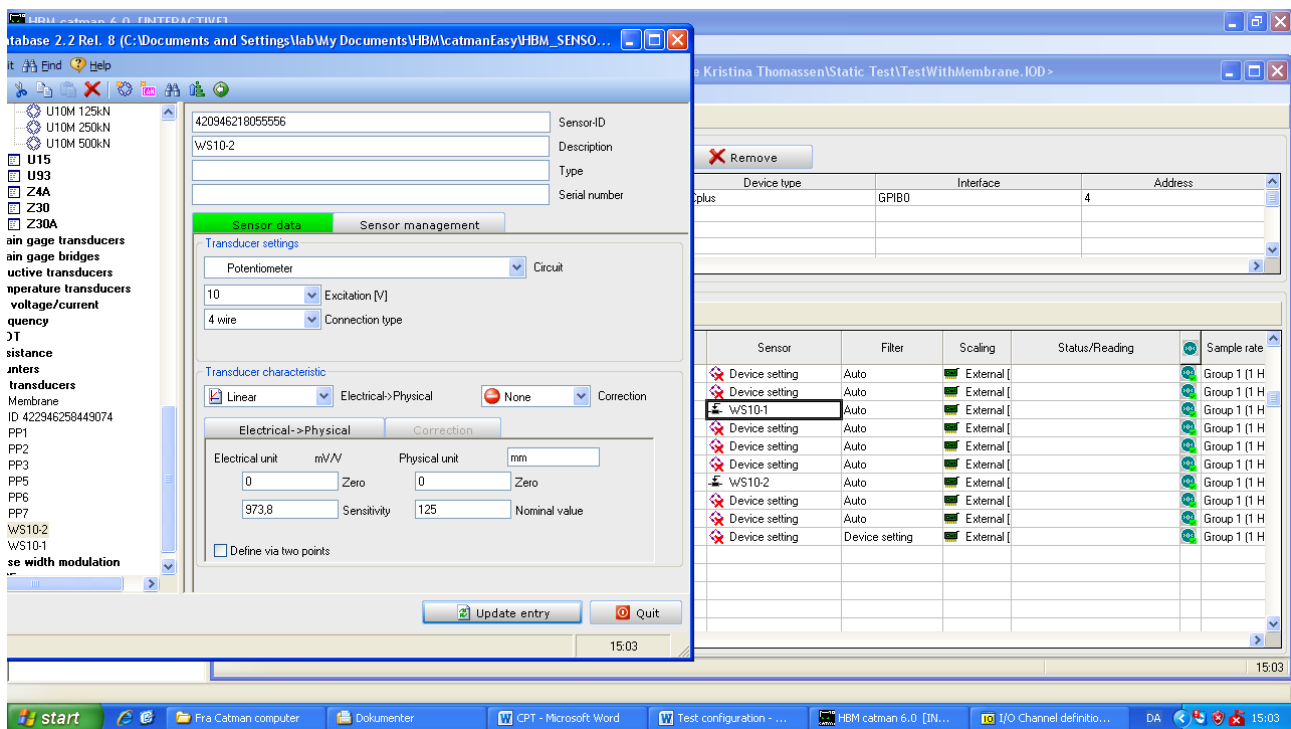


Figure 30: Displacement transducer WS10-2.

It is possible to define your own set of transducers in the HBM database. Right click on the Sensor column and chose “Connect to sensor from database” and press New. It is then possible to define your own transducer. The displacement transducers are defined as potentiometers and the calibration factor (sensitivity) is defined manually.



## 10.4 Pore Pressure Transducers

The calibration factors for each pore pressure transducer are given from the manufacturer for each transducer. Hence, it is important to change the calibration factor, if any of the transducers are replaced by another. The transducer is connected to the MGCplus and the data is recorded in Catman.

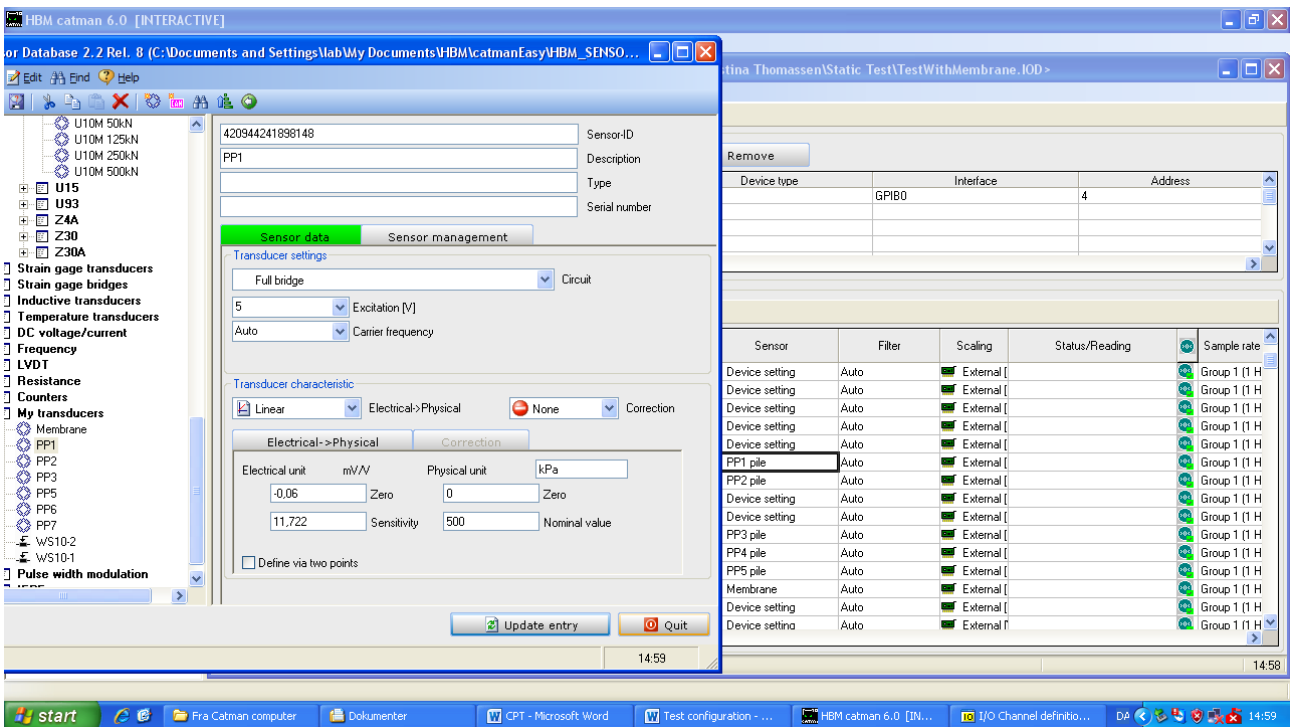


## Test Setup for Axially Loaded Piles in Sand

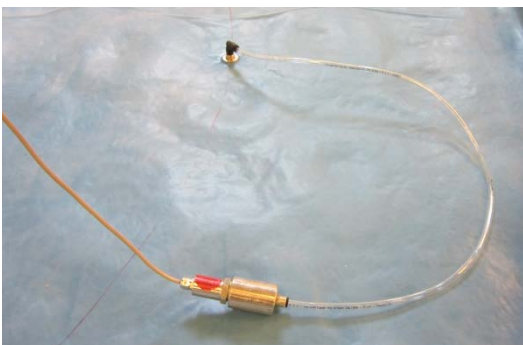


Figure 31: Example of pore pressure transducer.

The pore pressure transducers can also be defined as a new device in the database.

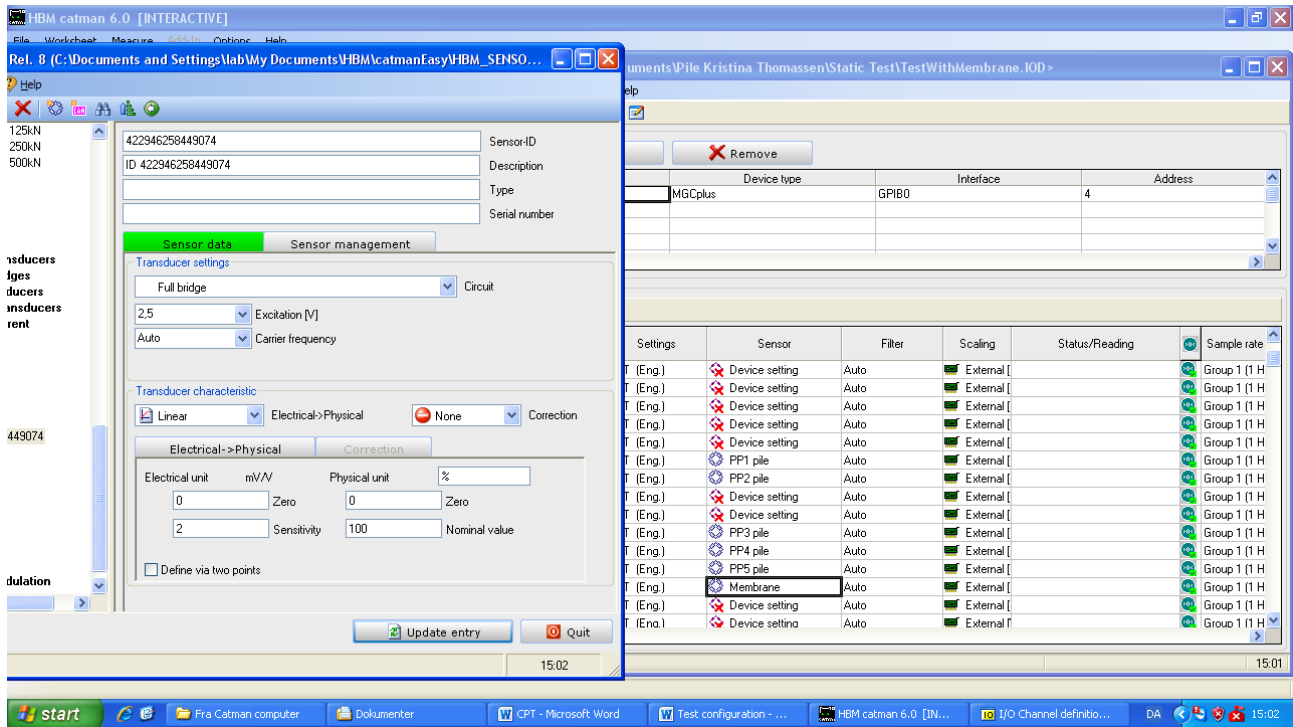


## 10.5 Membrane Suction Transducer



The membrane suction transducers can also be defined as a new device in the database.

## Test Setup for Axially Loaded Piles in Sand



### 10.6 Air Pressure Transducer

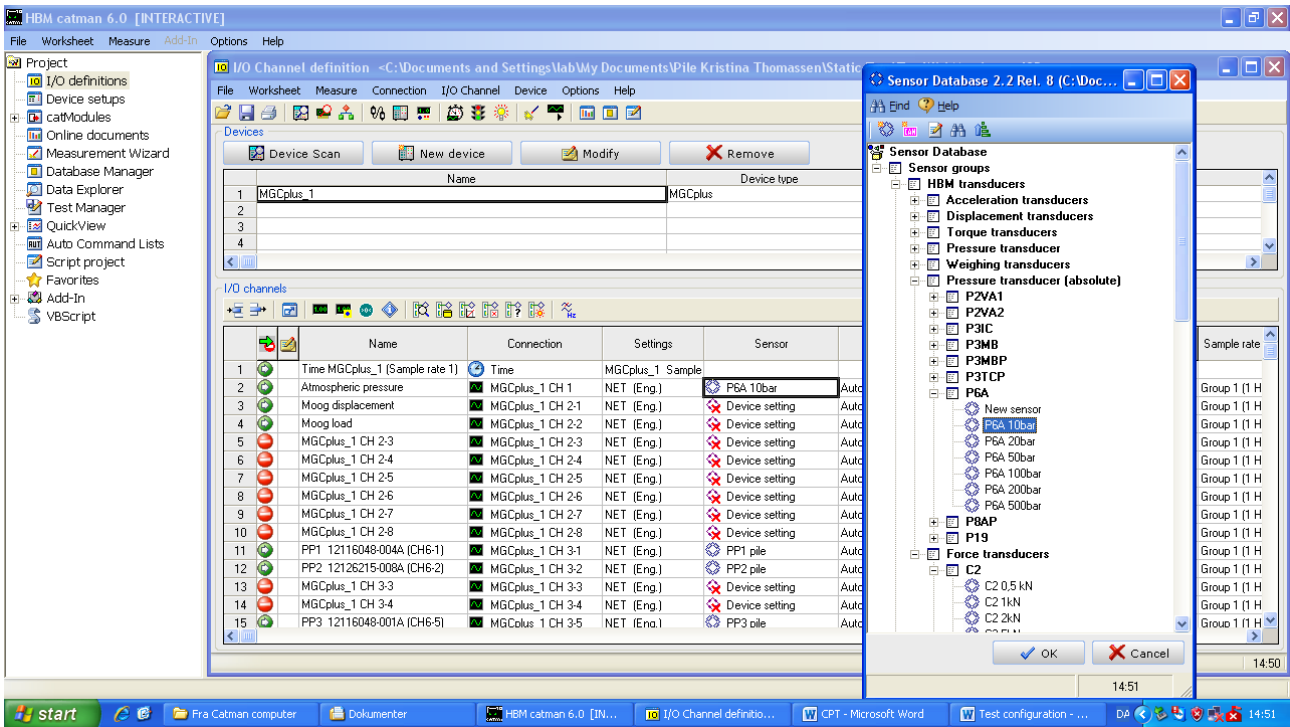
To separate the changes in pore pressure from the changes in air pressure in the laboratory, an absolute pressure sensor of the type HBM p6a 10 bar 2mV/V is placed next to the test setup during tests. The transducer is connected to the MGCplus and the data is recorded in Catman.



Figure 32: Air pressure transducer.

The air pressure transducer is a standard HBM transducer and can be found in the database.

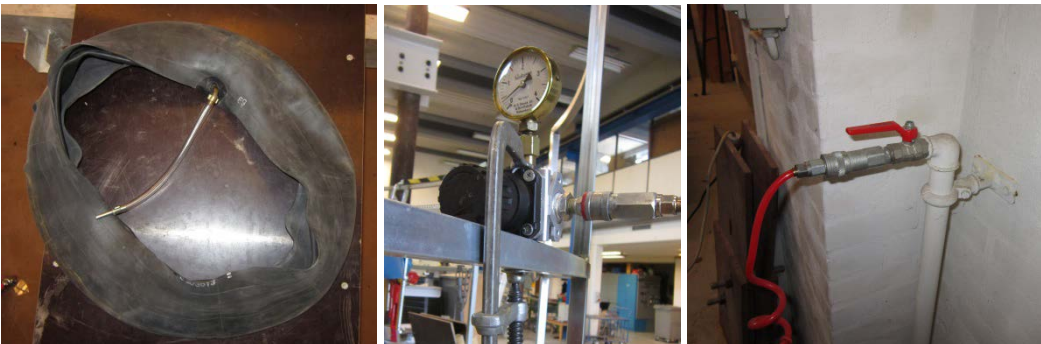
## Test Setup for Axially Loaded Piles in Sand



## 10.7 Vacuum Pump



## 10.8 Pressurised Tube



## 11 Measuring Devices and Configuration for Uninstallation

See Chapter 8 about installation.



## 12 Miscellaneous Equipment

### 12.1 Aluminium Frames

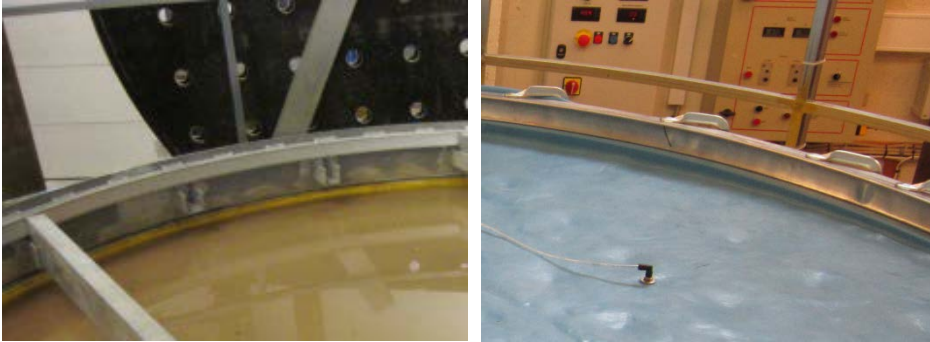


Figure 33: Aluminium frame 1 (to the left) is used during installation and uninstallation of the pile, sand preparation, and when conducting CPTs. Aluminium frame 2 (to the right) is used during tests.

### 12.2 For workspace

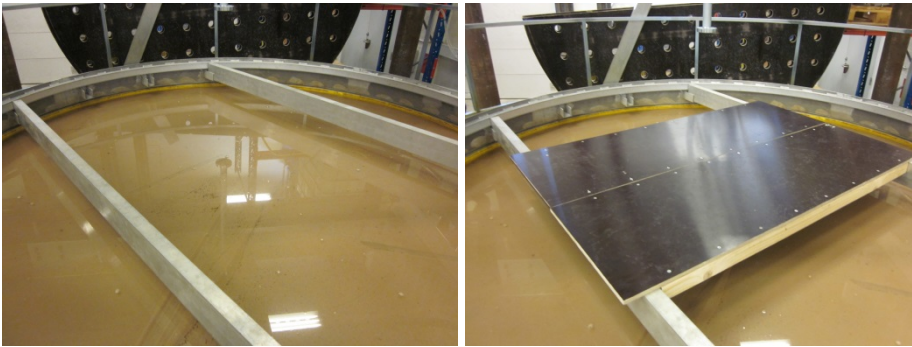


Figure 34: Aluminium bars no. 7 and 8 and footbridges.

### 12.3 Transition Pieces



Figure 35: Transition piece 1 (to the left) is used when conducting CPTs. Transition piece 2 (to the right) is used when installing or uninstalling the pile.

## Test Setup for Axially Loaded Piles in Sand

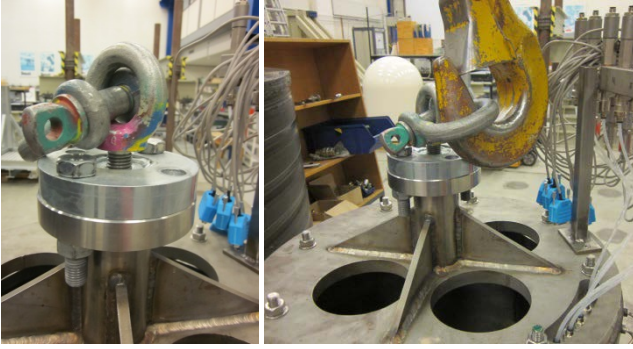


Figure 36: Transition piece for operating the pile with the ceiling crane.

### 12.4 Felt Cloth and Membrane



Figure 37: Felt cloth and Membrane

### 12.5 Tools



Figure 38: Brush for cleaning the pile.



Figure 39: Screwdrivers etc. for moving the rigs with the hydraulic pistons.

## Test Setup for Axially Loaded Piles in Sand



Figure 40: Compressor for cleaning the pore pressure pipes and the sand box edge.



Figure 41: Clamp for tightening the aluminium frames to the sand box edge.



Figure 42: Ratchet for connecting the pile and the CPT to the transition pieces and for tightening the rig with Hydraulic piston 1 to the load beam when conducting CPTs.

## 13 Bibliography

- Borup, M., og J. Hedegaard. *Data Report 9403 - Baskarp Sand No 15*. Aalborg University, 1995.
- Brinkgreve, R. B. J., og W. Swolfs. *PLAXIS 3D Foundation, Material mModels Manual, Version 2*. PLAXIS, 2007.
- Ibsen, L. B., M. Hanson, T. Hjort, og M. Thaarup. *MC-Parameter Calibration for Baskarp Sand No. 15*. DCE Technical Report No. 62, Aalborg University, 2009.
- Larsen, Kim André. *Static Behaviour of Bucket Foundations*. Aalborg: Department of Civil Engineering, Aalborg University, 2008.
- Randolph, M., og S. Gourvenec. *Offshore Geotechnical Engineering*. Spon Press, 2011.

## Test Setup for Axially Loaded Piles in Sand

SibelcoNordic. »Baskarpsand Siktanalys B15.« Data sheet, 2008.

Thomassen, Kristina. *Test procedure for Axially Loaded Piles in Sand*. DCE Technical Report No. 196, Aalborg University, 2015.

## Appendix A Equipment and Specifications

**Table 2: Installation and uninstallation equipment and specifications.**

Specifications	-	Unit		
Installation rate	6	mm/s		
Gradient	$0,9i_{crit}$	-		
Measurements	Unit	Measured by	Connected to	
Displacement	mm	WS17KT	Spider8	
Load	kN	Load cell 1	Spider8	
Time	s			
Equipment	Manufacturer	Type	Specification	Calibration factor
Hydraulic pump 1	Hydra	1SPA1 2-S	250 bar	
Hydraulic cylinder 1	LJM		250 bar	
Position transducer	ASM	WS10ZG-1250-25-PP530-M4-M12	1250 mm	25.0291 pulse/mm
Displacement transducer	ASM	WS17KT-2500-10V-L10-M4-M12	2500 mm	4.000 V/m
Load cell 1	HBM	U10M	250 kN	2.119 mV/V
Ceiling crane				
Pile	AAU			
Transition piece 2	AAU			
Aluminium ring 1	AAU			
Data acquisition	Manufacturer	Type		
Spider8	HBM	Spider8		
Catman	HBM	Catman 6.0		

**Table 3: Soil preparation equipment and specifications.**

Specifications	Unit	
Vibrator penetration rate	2 min/hole	
Gradient	0,9 -	
Equipment	Manufacturer	Type
Rod vibrator	Wacher Neuson	IRFU 45 (rod vibrator) M2000 (motor)
Earmuffs		
Vibration gloves		
Stopwatch		
Helmet		

## Test Setup for Axially Loaded Piles in Sand

**Table 4: CPT equipment and specifications.**

Specifications		Unit		
Penetration rate	5	mm/s		
Measurements	Unit	Measured by	Connected to	
Cone resistance	N	CPT device	Spider8	
Displacement	mm	WS17kt	Spider8	
Load	kN	Load cell 1	Spider8	
Time	s			
Equipment	Manufacturer	Type	Specification	Calibration factor
Hydraulic pump 1	Hydra	1SPA1 2-S	250 bar	
Hydraulic cylinder 1	LJM		250 bar	
Position transducer	ASM	WS10ZG-1250-25-PP530-M4-M12	1250 mm	25.0291 pulse/mm
Displacement transducer	ASM	WS17KT-2500-10V-L10-M4-M12	2500 mm	4.000 V/m
Load cell 1	HBM	U10M	250 kN	2.119 mV/V
CPT device	AAU		4000 N	Must be calibrated on a regular basis, see App. A
Transition piece 1	AAU			
Data acquisition	Manufacturer	Type		
Spider8	HBM	Spider8		
Catman	HBM	Catman 4.0		
Equipment CPT calibration	Manufacturer	Type	Specification	Calibration factor
Load cell	HBM	S9 5	5 kN	2mV/V
Lathe				

## Test Setup for Axially Loaded Piles in Sand

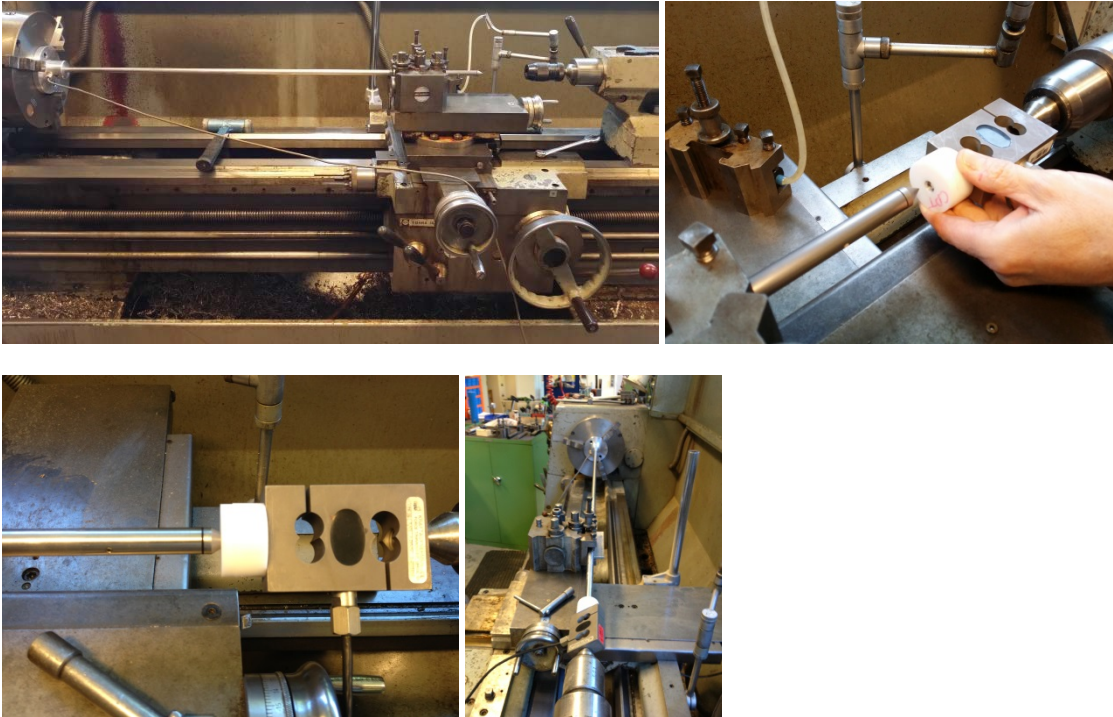
**Table 5: Test equipment and specifications.**

Specifications	Size	Unit			
Pull-out rate *	0,002	mm/s			
Loading frequency **	0,1	Hz			
Sample rate *	1	Hz			
Sample rate **	2	Hz			
Measurements	Unit	Measured by	Connected to	Connection boards	Box name
Time (MOOG)	s				
Time (Catman)	s				
Load	N	Load cell 2	Modular Test controller	AP801	
			MGCplus		
Disp. of hydraulic cylinder 2	mm	Disp. of hydraulic cylinder 2	Modular Test controller	AP801	
			MGCplus		
Disp. pile head	mm	WS10-1	MGCplus	AP836i	WS10-1
		WS10-2			WS10-2
Pore pressure 1 ***	kPa	PP1	MGCplus	AP810i	CH6-1
Pore pressure 2 ***	kPa	PP2	MGCplus	AP810i	CH6-2
Pore pressure 3 ***	kPa	PP3	MGCplus	AP810i	CH6-5
Pore pressure 4 ***	kPa	PP4	MGCplus	AP810i	CH6-6
Pore pressure 5 ***	kPa	PP5	MGCplus	AP810i	CH6-7
Membrane pressure ***	kPa	Membrane	MGCplus	AP810i	CH6-8
Air pressure ***	kPa	p6a	MGCplus	AP810i	p6a
Equipment	Manufacturer	Type	Specification	Calibration factor	Zero point
Hydraulic pump 2	Hydra	1SPA1 2-S	250 bar		
Hydraulic cylinder 2	LJM		250 bar		
Disp. of hydraulic cylinder 2	MooG	S106			
Load cell 2	HBM	U10M	250 kN	2.1171 mV/V	0 mV
WS10-1	ASM	WS10-125-R1K-L10-SBO-D8	125 mm	7.7879 mV/V/mm	0 mV
WS10-2	ASM	WS10-125-R1K-L10-SBO-D8	125 mm	7.7904 mV/V/mm	0 mV
PP1 ***	LISAB	NS-B (12126215-004A)	5 bar	13.802 mV/V	0.270 mV
PP2 ***	LISAB	NS-B (12126215-008A)	5 bar	13.702 mV/V	0.970 mV
PP3 ***	LISAB	NS-B (12126215-006A)	5 bar	13.980 mV/V	-0.030 mV
PP4 ***	LISAB	NS-B (12126215-013A)	5 bar	14.862 mV/V	-0.690 mV
PP5 ***	LISAB	NS-B (12116048-001A)	5 bar	13.918 mV/V	0.300 mV
Air pressure ***	HBM	p6a	10 bar	2 mV/V/bar	
Membrane ***					
Felt cloth ***					
Vacuum pump ***					
Pressurized tube ***					
Data acquisition	Manufacturer	Type			
MGCplus	HBM	MGCplus			
Modular Test Controller	MOOG	Modular test controller			
Catman	HBM	Catman 6.0			
MOOG	MOOG	Test suite V.2.6.4.			
* Static loading tests					
** Cyclic loading tests					
*** Tests with suction applied					



## Appendix B Calibration of CPT-device

The CPT device is calibrated before conducting a series of tests. The CPT device is fastened in a lathe. The cone is protected by a block of hard rubber with an indentation fitting the cone. A HBM force transducer type S9 5 of 5 kN = 2 mV/V (registration no. 54086) is inserted between the cone and the bench to measure the force on the cone when the lathe handle is turned.



The measurements of the force transducer and the CPT device, respectively, are recorded in Catman. The CPT output is in mV/V while the output from the force transducer is in N. The measuring range of the CPT should be 12 mV/V. Prior to the calibration test, the output of the CPT and the force transducer should be zeroed. Let Catman display a real-time graph and apply a force up to maximum 4 kN. Release the force and re-load a couple of times to validate the correlation between the force and the CPT output. Figure 43 shows a calibration example.

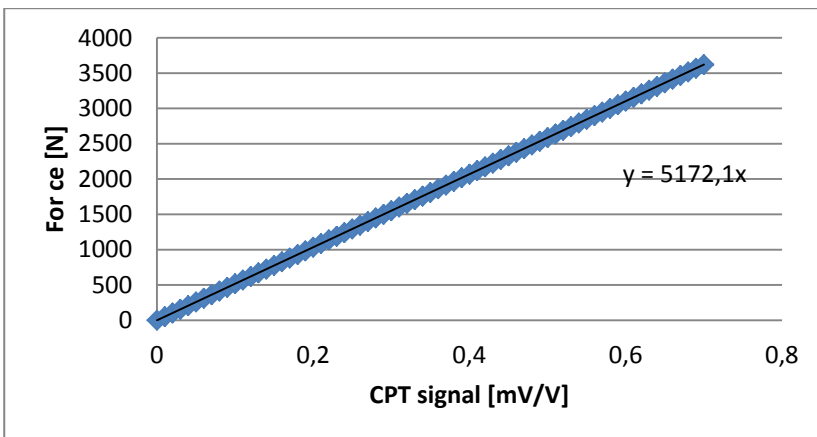


Figure 43: Example of determination of calibration factor.



## Appendix C Interpretation of CPT results

The CPT cone resistance,  $q_c$ , plotted against the depth is used to verify homogeneous compaction of the sand. This means that the cone resistances found from the five CPTs conducted before each test should be very similar. Moreover, the cone resistances should show similar soil conditions for all the conducted loading tests to ensure that the soil conditions and, thereby, the test results in the various tests are comparable.

From the CPT-results the following soil parameters are determined:

- Friction angle,  $\varphi_{tr}$  [°].
- Dilation angle,  $\psi_{tr}$  [°].
- Relative density,  $D_r$  [-].
- Effective unit weight,  $\gamma'$  [kN/m<sup>3</sup>].
- Initial stiffness of the sand,  $E_0$  [kPa].

The expressions for the internal angle of friction and the dilation angle are based on results from triaxial tests on Baskarp Sand No. 15 (Ibsen, et al. 2009). The friction angle and dilation angle are considered dependent on the density index and the confining pressure,  $\sigma'_3$ . The triaxial tests were performed with two different density indices and nine different confining pressures. The expressions for the friction angle and the dilation angle given below were determined by plotting the angles against the density index. The figure shows the friction angles plotted against the density index.

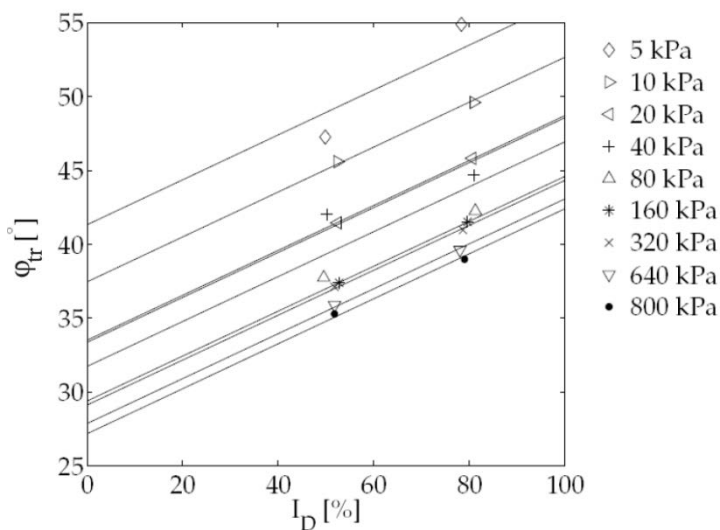
$$\varphi_{tr} = 15.2^\circ \cdot D_r + 27.39^\circ \cdot (\sigma'_3/\sigma'_{3,ref})^{-0.2807} + 23.21^\circ$$

$$\psi_{tr} = 19.5^\circ \cdot D_r + 14.86^\circ \cdot (\sigma'_3/\sigma'_{3,ref})^{-0.09764} - 9.946^\circ$$

Where:

$\sigma'_3$  confining pressure [kPa]

$\sigma'_{3,ref}$  reference effective horizontal stress, 1 kPa



Friction angle versus relative density (Ibsen, et al. 2009).

The density index is found by an iterative procedure involving the following four equations.

## Test Setup for Axially Loaded Piles in Sand

$$\gamma' = \frac{d_s - 1}{1 + e_{in-situ}} \gamma_w$$

$$\sigma'_1 = \gamma' \cdot x$$

$$D_r = c_2 \left( \frac{\sigma'_1 / \sigma'_{1,ref}}{(q_c / q_{c,ref})^{c_1}} \right)^{c_3}$$

$$D_r = \frac{e_{max} - e_{in-situ}}{e_{max} - e_{min}}$$

Where:

$\gamma'$	effective unit weight of soil [kN/m <sup>3</sup> ]
$d_s$	relative density [-], $d_s = 2.64$
$e_{in-situ}$	in-situ void ratio [-]
$\gamma_w$	unit weight of water [kN/m <sup>3</sup> ]
$\sigma'_1$	effective vertical stress [MPa]
$\sigma'_{1,ref}$	reference effective vertical stress, 1 MPa
$q_c$	cone resistance [MPa]
$q_{c,ref}$	reference CPT cone resistance, 1 MPa
$x$	depth below soil surface [m]
$c_1, c_2, c_3$	constants [-], $(c_1, c_2, c_3) = (0.75, 5.14, -0.42)$
$e_{max}$	maximum void ratio [-], $e_{max} = 0.854$
$e_{min}$	minimum void ratio [-], $e_{min} = 0.549$

As the in-situ void ratio and the effective unit weight are unknown, the relative density is found by inserting a guessed value of  $e_{in-situ}$  and iterate until the difference between two successive values of  $e_{in-situ}$  is less than  $10^{-4}$ .

The effective horizontal stress,  $\sigma'_3$ , is dependent on the effective vertical stress and the coefficient of horizontal earth pressure at rest,  $K_0$ .  $K_0$  depends on the friction angle, giving the following expression for  $\sigma'_3$ . Thereby, the friction angle is the only unknown in the expression for the friction angle and can then be found by iteration.

$$\begin{aligned} \sigma'_3 &= \sigma'_1 \cdot K_0 \\ &= (\gamma' \cdot x + P_0) \cdot K_0 \\ &= (\gamma' \cdot x + P_0) \cdot (1 - \sin \varphi_{tr}) \end{aligned}$$

Where

$K_0$	earth pressure coefficient at rest [-]
$P_0$	overburden pressure [kPa]

Inserting this expression into the formula for the friction angle shows that  $\varphi_{tr} \rightarrow \infty$  for  $\sigma'_3 \rightarrow 0$ . Furthermore, the figure shows that the expression for the friction angle does not fit the triaxial test for  $\sigma'_3 = 5$  kPa well. As the CPTs only reach a depth of 1 m,  $\sigma'_3$  lies between 0 kPa and 2 kPa for the tests without overburden pressure (i.e. without suction under the membrane). To be able to use the equation

## Test Setup for Axially Loaded Piles in Sand

for the friction angle,  $\sigma'_3$  is set to 5 kPa for the tests without overburden pressure. As a result, the friction angle may be judged slightly lower than the correct value, however, the difference is considered tolerable.

(Brinkgreve og Swolfs 2007) gives the following expression for the secant stiffness of the soil,  $E_{50}$ . This value of  $E_{50}$  is then used to find the tangential modulus,  $E_0$  (Ibsen, et al. 2009).

$$E_{50} = (0.6322 \cdot D_r^{2.507} + 10920) \left( \frac{c \cdot \cos \varphi_{tr} + \sigma'_3 \cdot \sin \varphi_{tr}}{c \cdot \cos \varphi_{tr} + \sigma_3^{ref} \cdot \sin \varphi_{tr}} \right)$$

$$E_0 = \frac{2 \cdot E_{50}}{2 - R_f}$$

Where:

$E_{50}$  secant stiffness [kPa]

$c$  cohesion [kPa]

$\sigma_3^{ref}$  reference horizontal stress [kPa],  $\sigma_3^{ref} = 100$  kPa

$E_0$  tangential stiffness [kPa]

$R_f$  ratio between  $q_f$  and  $q_a$  [-], the standard value is  $R_f = 0.9$  cf. (Brinkgreve og Swolfs 2007)

$q_f$  ultimate deviatoric stress [kPa]

$q_a$  asymptotic value of the shear strength [kPa]

## Recent publications in the DCE Technical Report Series

