



**AALBORG UNIVERSITY**  
DENMARK

**Aalborg Universitet**

## **Droop Control with an Adjustable Complex Virtual Impedance Loop based on Cloud Model Theory**

Li, Yan; Shuai, Zhikang; Xu, Qinming; Guerrero, Josep M.

*Published in:*

Proceedings of IECON 2016: 42nd Annual Conference of the IEEE Industrial Electronics Society

*DOI (link to publication from Publisher):*

[10.1109/IECON.2016.7793521](https://doi.org/10.1109/IECON.2016.7793521)

*Publication date:*

2016

*Document Version*

Early version, also known as pre-print

[Link to publication from Aalborg University](#)

*Citation for published version (APA):*

Li, Y., Shuai, Z., Xu, Q., & Guerrero, J. M. (2016). Droop Control with an Adjustable Complex Virtual Impedance Loop based on Cloud Model Theory. In *Proceedings of IECON 2016: 42nd Annual Conference of the IEEE Industrial Electronics Society* (pp. 3223 - 3228). IEEE Press. <https://doi.org/10.1109/IECON.2016.7793521>

### **General rights**

Copyright and moral rights for the publications made accessible in the public portal are retained by the authors and/or other copyright owners and it is a condition of accessing publications that users recognise and abide by the legal requirements associated with these rights.

- Users may download and print one copy of any publication from the public portal for the purpose of private study or research.
- You may not further distribute the material or use it for any profit-making activity or commercial gain
- You may freely distribute the URL identifying the publication in the public portal -

### **Take down policy**

If you believe that this document breaches copyright please contact us at [vbn@aub.aau.dk](mailto:vbn@aub.aau.dk) providing details, and we will remove access to the work immediately and investigate your claim.

# Droop Control with an Adjustable Complex Virtual Impedance Loop based on Cloud Model Theory

Yan Li

School of information science and engineering  
Central South University  
Changsha, China  
[liyanly76@gmail.com](mailto:liyanly76@gmail.com)

Zhikang Shuai, Qinming Xu

College of Electrical and Information Engineering  
Hunan University  
Changsha, China  
Josep M. Guerrero, *Fellow, IEEE*  
Department of Energy Technology  
Aalborg University,  
Aalborg, Denmark  
[joz@et.aau.dk](mailto:joz@et.aau.dk)

**Abstract**—Droop control framework with an adjustable virtual impedance loop is proposed in this paper, which is based on the cloud model theory. The proposed virtual impedance loop includes two terms: a negative virtual resistor and an adjustable virtual inductance. The negative virtual resistor term not only can avoid the active/reactive power coupling, but also it may reduce the output voltage drop of the PCC voltage. The proposed adjustable complex virtual impedance loop is putted into the conventional P/Q droop control to overcome the difficulty of getting the line impedance, which may change sometimes. The cloud model theory is applied to get online the changing line impedance value, which relies on the relevance of the reactive power responding the changing line impedance. The verification of the proposed control strategy is done according to the simulation in a low voltage microgrid in Matlab.

**Keywords**—microgrid, droop control, adjustable virtual impedance, membership cloud

## I. INTRODUCTION

In order to manage the widespread penetration of renewable energy and distributed generation (DG) in power distribution networks, the microgrid concept was introduced into electric power systems. The microgrid approach offers the most flexibility and reliability for power systems, and thus the micro-grid is generally regarded as the most attractive DG system configuration [1]-[2].

The active power-frequency droop ( $P$ - $f$  droop) and the reactive power-voltage droop ( $P$ - $V$  droop) is used to realize the “plug and play” characteristic ( $PnP$ ) and to mimic the parallel operation characteristics of synchronous generators, which was initially proposed in [1] for the parallel operation of multiple uninterruptible power supply units [3]. There are mostly the resistive lines in low voltage microgrids [4]. The high resistive value of distribution lines makes the control method of active power ( $P$ ) and reactive power ( $Q$ ) couple. The accuracy of  $Q$ -control in grid-connected operation mode and the  $Q$ -sharing during in islanding mode are affected due to the unequal voltage drops along the microgrid with the impaired line impedances and the inverter output impedances significantly

[5]. Note that voltage is a local variable in the microgrid, while frequency is a global one.

A lot of research works have been done to diminish the abovementioned disadvantages of the traditional droop control. We found out mainly three kinds of methods to perform this:

(i) To make the inverter output impedance to be inductive instead of resistive, controlling parameters can be setting. However, it is important for this method to rely on the power stage and the control parameters of the voltage and current loops, which may trade-off the system stability.

(ii) To solve this problem, Guerrero [7] proposed the control strategy based on the virtual impedance. In order to ensure the inverter output impedance adjusted flexibly, it is necessary to feed back the inverter output current in the virtual impedance loop. It seems to be a good way to diminish problem of power coupling and guarantee  $Q$ -sharing by the virtual impedance [8]. But the control strategy based on the virtual impedance may cause DG voltage distortions because of bad designed or implemented. Therefore the system stability and dynamics are adversely affected [9].

(iii) A droop control method connecting an adjustable virtual impedance is proposed to decrease mismatch voltage drops across lines and to diminish  $P/Q$  coupling in this paper. The adjustable virtual impedance is regulated the cloud model theory.

This paper starts in Section II, which discusses firstly some problems about  $P/Q$  coupling and mismatch line impedances among inverters in a microgrid. Section III shows the proposed droop controlling method with the cloud-based adjustable virtual impedance. The simulation is done in Section IV. The system performance is verified by the simulating results. Section V is the conclusions.

## II. PROBLEMS ON POWER COUPLING AND IMBALANCE LINE IMPEDANCES

The voltage across the equivalent line impedance is shown in Fig.1. Note that the inverter output impedance is included the equivalent line impedance.

This work is supported by National Nature Science Foundation under Grant 51507192, China .

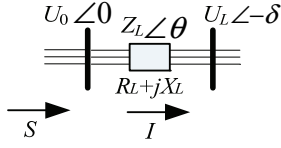

Fig. 1. the line impedance voltage.

From the Fig.1 we can see that the voltage drop ( $\Delta U_L$ ), and the phase angle ( $\delta$ ) difference can be calculated as follows

$$\Delta U_L = U_0 - U_L \approx \frac{R_L P + X_L Q}{U_0} \quad (1)$$

$$\delta = \frac{X_L P - R_L Q}{U_0} \quad (2)$$

Where  $U_0 \angle 0$  denotes the inverter open-circuit voltage and  $U_L \angle -\delta$  the voltage on PCC, respectively; and  $Z_L \angle \theta = R_L + jX_L$  is

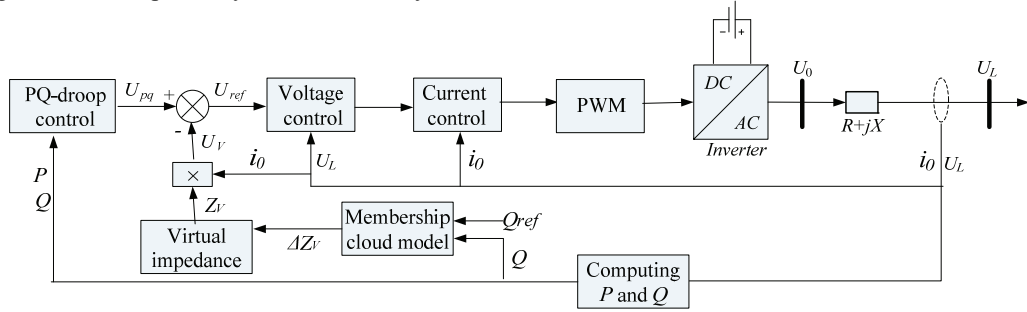

Fig. 2. Control strategy block on the cloud model theory to regulate  $\Delta Z_V$ .

### III. DROOP CONTROL WITH AN ADJUSTABLE VIRTUAL IMPEDANCE

#### A. Adjustable Virtual Impedance Concept

It is well known that not only imbalanced feeder impedances affect power sharing among the inverters, but also high  $R_L/X_L$  ratios deal with voltage raises. We set the virtual impedance as follows to overcome these disadvantages:

$$\vec{Z}_V = -R_L - \Delta R - j\omega\Delta X \quad (4)$$

Then the resistive part of the line becomes 0. The whole impedance of the line is:

$$\vec{Z}_T = j\omega X_L \quad (5)$$

In this case, the problems of  $P/Q$  couple and the imbalance line impedance can be solved. From the equations (1) and (2) it can be seen that after applying equation (4), the equations (1) and (2) can be expressed as:

$$\Delta U_T \approx \frac{X_L Q}{U_0} \quad (6)$$

$$\delta = \frac{X_L P}{U_0} \quad (7)$$

Equations (6) and (7) show that in the inductive impedance-dominated microgrids, the output  $Q$  controls the

the line impedance of the system. From (1) and (2), it can be seen that the higher the  $R_L/X_L$  ratio of the distribution feeders, the higher the  $P/Q$  coupling. Actually, besides the  $P/Q$  coupling effect, the power sharing among the inverters is affected by the mismatch line impedance. For instance, consider that the two DGs present same line impedances  $R_L + jX_L$  is not realistic. The line impedances may change due to many factors. The changing line impedances can be given as in the resistive and/or inductive parts,  $\Delta R$  and  $\Delta X$  respectively. Consequently this imbalance may produce voltage differences  $\Delta U$  and circulating currents, thus these imbalance line impedances  $\Delta R$  and  $\Delta X$  may bring about unequal  $Q$ -sharing. For this case, the total line impedance is presented as:

$$\vec{Z}_T = R_L + \Delta R + j\omega(X_L + \Delta X) \quad (3)$$

Notice that it includes nominal values and variations.

inverter voltage, while  $P$  controls the system frequency, independently. This behavior is similar that those in large power systems, so that similar equations can be found when transmitting power in large distances.

Then equation (4) can be rewritten as follows:

$$\vec{Z}_V = -R_L - \Delta Z_V \quad (8)$$

where  $\Delta Z_V = \Delta R + j\omega\Delta X$  is the changing line impedance portion. In equation (8), although the value of  $R_L$  can be easily obtained, however the knowledge of the changing line impedance value is often not available. In this paper we propose a way to solve this problem by applying the cloud model theory to adjust  $\Delta Z_V$ . The reactive power is inversely proportional to the line impedance. This relationship is used in the control method, which is shown in (6). The control diagram of the proposed approach is given in Fig. 2.

Fig. 2 shows the control strategy based on power/voltage/current three-loop including the proposed adjustable virtual impedance. As we know, communications among the parallel connected DGs can be reduced by the  $P/Q$  droop control method. The well-known traditional  $P/Q$  droop control functions can be expressed as:

$$\omega = \omega_0 - mP \quad (9)$$

$$U = U_0 - nQ \quad (10)$$

Where  $\omega_0$  and  $U_0$  are the set frequency and voltage for micro-grid at no load conditions;  $m$  and  $n$  are the droop coefficients of DGs  $P$  and  $Q$ . Thus, the output voltage  $U_{pq}$  generated from the  $P/Q$  droop control can be shown as:

$$U_{pq} = U \sin \omega t \quad (11)$$

Thus, the reference for the voltage loop can be expressed as follows:

$$U_{ref} = U_{pq} - Z_V I \quad (12)$$

Where  $U_{ref}$  is the final reference voltage. In order to enhance Q-sharing accuracy, an adjustable virtual impedance strategy is proposed here. The cloud model theory is used to obtain the adjustable virtual impedance. We can implement the adjustable virtual impedance strategy straightly without the changing line impedance values.

### B. the Cloud model Theory

We present the principle of the cloud model theory in this SubSection [10]. A membership cloud generator is constructed by three digital characteristics, which can cloud numerical values. Assuming that  $R(E_x, H_e)$  is a random function, which meets a normal distribution. So the normal random entropy can be gotten:

$$E_n' = R(E_n, H_e) \quad (13)$$

Where  $E_x$  is the expected value of a membership cloud. It shows the center of gravity of the cloud.  $E_n$  is the entropy to measure the fuzziness of the concept over the universe of discourse.  $H_e$  is the super-entropy to measure of the randomness of the membership function. Therefore, we can get the normal random number by the random function with an expected value  $E_x$  and the standard error  $E_n'$  :

$$x_i = R(E_x, E_n') \quad (14)$$

The membership function with a normal distribution can be expressed as:

$$\mu_i = \exp\left\{-\frac{(x_i - E_x)^2}{2E_n'^2}\right\} \quad (15)$$

where  $x_i$  with membership  $\mu_i$  is a cloud drop, which is drop( $x_i, \mu_i$ ).

Hence, lots of cloud drops construct the membership cloud. Actually, we also call the membership cloud generator as the membership cloud generator with  $X$ -term.

Here, we say that it has a membership cloud generator with  $Y$ -term, if the set  $\mu_i$  has a membership degree and it satisfies:

$$z_i = E_x \pm \sqrt{-2\ln(\mu_i)} E_n' \quad (16)$$

A set of special cloud rules is established by using cloud generators with  $X$ -term and  $Y$ -term. These special cloud rules can be summed up by human controllers from their experiences. Note that the nonlinear characteristics can be expressed by these specified cloud rules. For example "if  $A$ , then  $B$ ", if the digital characteristics of the linguistic terms  $A$  and  $B$  in that

rule are given. The membership degree,  $\mu_i$ , produced by the cloud generator with  $X$ -term  $CG_X$  represents the activated strength of the rule which goes to control the cloud generator with  $Y$ -term  $CG_Y$  to produce a set of drops( $z_i, \mu_i$ ) quantitatively. All the activated rules will make contributions to a particular input. This natural rule with one "and" can be constructed by the two-dimension membership cloud generator with  $X$ -term and the one-dimension membership cloud generator with  $Y$ -term, for example, "If  $A$  and  $B$ , then  $C$ ".

Set  $GA((E_{xx}, E_{xy}), (E_{nx}, E_{ny}), (H_{ex}, H_{ey}))$  be a two-dimension membership cloud, if there are

$$E_{nx}' = R(E_{nx}, H_{ex}) \quad (17)$$

$$E_{ny}' = R(E_{ny}, H_{ey}) \quad (18)$$

$$\mu(x, y) = \exp\left\{-\frac{(x - E_{xx})^2}{2E_{nx}'^2} - \frac{(y - E_{xy})^2}{2E_{ny}'^2}\right\} \quad (19)$$

Thus we can get the two-dimension membership cloud generator with  $X$ -term.

According to equations (15) and (19), equation (19) can be represented as following:

$$\begin{aligned} \mu(x, y) &= \exp\{\ln(\mu(x)) + \ln(\mu(y))\} \\ &= \exp\{\ln(\mu(x)\mu(y))\} = \mu(x)\mu(y) \end{aligned} \quad (20)$$

Finally, the backward cloud generator is used to obtain the numerical output. The output expected value of  $E_{xu}$  expressed by:

$$E_{xu} = \frac{1}{n} \sum_{i=1}^n z_i \quad (21)$$

being numerical output expressed in (21). It is not necessary to calculate the output entropy  $E_{nu}$  and the output super-entropy  $H_{eu}$  here.

### C. Adjusting the Virtual Impedance

The membership cloud model can convert the qualitative knowledge into the quantitative. The membership cloud model joins the fuzziness into randomness through  $E_x$ ,  $E_n$ , and  $H_e$  for an object. The two-dimension and one-dimension membership cloud generator can form the control rules according to regulating actions. By using this method, the mathematical model is not necessary. It only requires controller's experience and their logic judgments to overcome the nonlinearities and uncertainties of the plant.

The Block diagram of the closed loop system using the cloud model theory to regulate the virtual impedance is shown in Fig. 3. In this control system, the error and the error change of the reactive power is settled as the input signal denoting as  $e$  and  $e_c$ , respectively. According to the input signals error  $e$  and the error change  $e_c$ , the variable term of the adjustable virtual impedance  $\Delta Z_V$  can be obtained by applying the cloud model for online regulation purposes.

In Fig. 3, we set the input signals of the closed loop system  $t$  as  $e$  and  $e_c$  of reactive power  $Q$ . The output signal of the closed loop system is set as the changing virtual impedance  $\Delta Z_V$  for the parameter regulation algorithm. There are three

main steps in the computation process of the cloud model: (i) transforming input numerical values into clouds, (ii) setting reasoning rules and clouding uncertainty reasoning and (iii) transforming output clouds into numerical values.

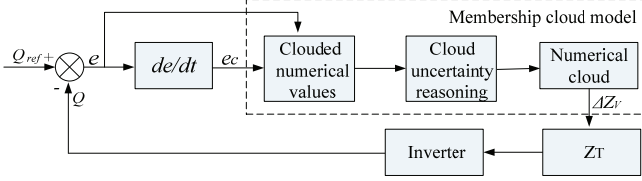

Fig. 3. Block diagram of the closed loop system to regulate the virtual impedance.

The discourse domains of input and output signals can be represented as  $[X_{min}, X_{max}]$ . So that the discourse domains of the error  $e$  and the error change  $e_c$  are  $[-1000 \ 1000]$  and  $\Delta Z_V [-1 \ 1]$ . Here, in order to obtain three digital characteristics of each cloud, the golden section method is adopted[11]. The input and output signals  $e$ ,  $e_c$  and  $\Delta Z_V$  for the cloud model are expressed as  $Ge(E_x, E_n, H_e)$ ,  $Ge_c$  and  $GAZ_V$ , respectively.

Subsequently, seven clouds of the error  $e$  can be expressed as:

$$\begin{aligned} E_{.3} &= Ge1(-1000 \ 333.3 \ 42), E_{.2} = Ge2(-382 \ 206.0 \ 26), \\ E_{.1} &= Ge3(-191 \ 127.3 \ 16), E_0 = Ge4(0 \ 78.7 \ 10), \\ E_{+1} &= Ge5(191 \ 127.3 \ 16), E_{+2} = Ge6(382 \ 206.0 \ 26), \\ E_{+3} &= Ge7(1000 \ 333.3 \ 42). \end{aligned}$$

Thus, the seven clouds of the error change  $e_c$  are:

$$\begin{aligned} EC_{.3} &= Ge1(-1000 \ 333.3 \ 42), EC_{.2} = Ge2(-382 \ 206.0 \ 26), \\ EC_{.1} &= Ge3(-191 \ 127.3 \ 16), EC_0 = Ge4(0 \ 78.7 \ 10), \\ EC_{+1} &= Ge5(191 \ 127.3 \ 16), EC_{+2} = Ge6(382 \ 206.0 \ 26), \\ EC_{+3} &= Ge7(1000 \ 333.3 \ 42). \end{aligned}$$

Hence the seven clouds of the changing virtual impedance  $\Delta Z_V$  can be obtained by:

$$\begin{aligned} \Delta Z_{V.3} &= Ge1(-1 \ 0.3 \ 0.042), \Delta Z_{V.2} = Ge2(-0.4 \ 0.2 \ 0.026), \\ \Delta Z_{V.1} &= Ge3(-0.2 \ 0.1 \ 0.016), \Delta Z_{V0} = Ge4(0 \ 0.08 \ 0.01), \\ \Delta Z_{V+1} &= Ge5(0.2 \ 0.1 \ 0.016), \Delta Z_{V+2} = Ge6(0.4 \ 0.2 \ 0.026), \\ \Delta Z_{V+3} &= Ge7(1 \ 0.3 \ 0.042). \end{aligned}$$

The membership cloud of error  $e$  with 1000 cloud drops is shown in Fig.4. The membership cloud of the error changes  $e_c$ . We can get the membership cloud of the output  $\Delta Z_V$  in the same way.

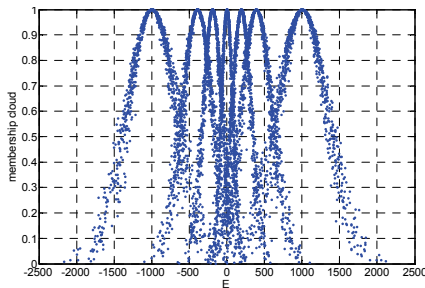

Fig. 4. Membership clouds of the error of the reactive power Q.

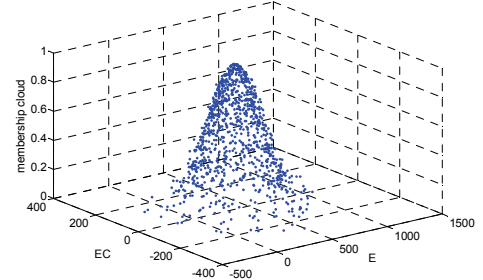

Fig. 5. Two-dimension membership cloud.

The two-dimension membership cloud is shown in Fig. 5 at “if  $E_{+2}$  and  $EC_0$ ”. Here the cloud drop number is also 1000. The two-dimension membership constructs each reasoning rule.

Cloud models of input and output signals  $e$ ,  $e_c$ , and  $\Delta Z_V$ , can be defined respectively According to corresponding each 7-cloud, as following:

$$\begin{aligned} E &= \{NB, NM, NS, Z, PS, PM, PB\} \\ EC &= \{NB, NM, NS, Z, PS, PM, PB\} \\ \Delta Z_V &= \{NB, NM, NS, Z, PS, PM, PB\} \end{aligned}$$

being NB, NM, NS, Z, PS, PM, and PB, remark negative big, negative middle, negative small, zero, positive small, positive middle, and positive big, respectively. The reasoning rules for  $\Delta Z_V$  are formed, which is given in Table I. For instance, if E is NB and EC is NB, then  $\Delta Z_V$  is PB.

TABLE I. REASONING RULES OF  $\Delta Z_V$

E	EC						
	NB	NM	NS	Z	PS	PM	PB
NB	PB	PB	NB	PM	PS	PS	Z
NM	PB	PB	NM	PM	PS	Z	Z
NS	PM	PM	NS	PS	Z	NS	NM
Z	PM	PS	Z	Z	NS	NM	NM
PS	PS	PS	Z	NS	NS	NM	NM
PM	Z	Z	NS	NM	NM	NM	NB
PB	Z	NS	NS	NM	NM	NB	NB

In the process of the cloud reasoning shown in Fig. 6,  $CG_{X_i}$ ,  $CG_{Y_i}$  and  $CG_C$  are the two-dimension membership cloud generator with X-term, the one-dimension membership cloud generators with Y-term, and the backward membership cloud generator, respectively; 3E is a rule that cloud drops at the universe of discourse  $U$ , which is mainly contributing to the qualitative conception  $C$  to be in the range  $[E_x - 3E_n, E_x + 3E_n]$ . The 3E rule is given as follows. At the universe of discourse  $U$ , any  $\Delta x$  at  $X$  which contributes to the qualitative conception  $C$  will guarantee the following approximation:

$$\Delta C \approx \frac{e^{-(x-E_x)^2 / 2E_n^2} \times \Delta x}{\sqrt{2\pi}E_n} \quad (22)$$

Obviously, there is:

$$\frac{\int_{E_x-3E_n}^{E_x-3E_n} e^{-(x-E_x)^2/2E_n^2} \times dx}{\sqrt{2\pi}E_n} = 99.74\% \quad (23)$$

So that the quantified data contributed to the qualitative conception  $C$  is mainly inside the interval  $[E_x-3E_n, E_x+3E_n]$ . The other quantified data out of the region can be neglected.

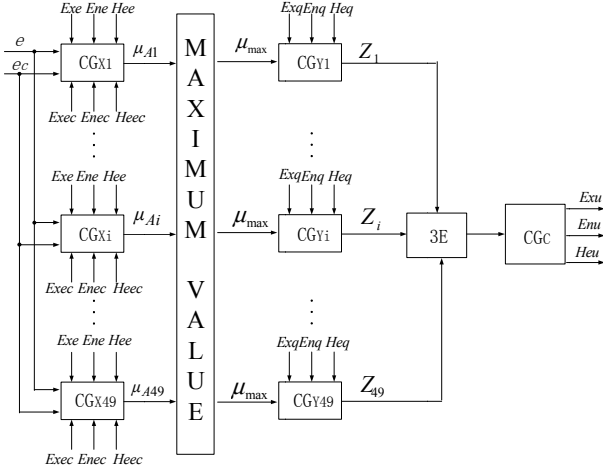

Fig. 6. Reasoning process to obtain the changing virtual impedance.

Input signals of the error  $e$  and the error change  $e_c$  are firstly transferred into natural linguistic terms, which activate the two-dimension cloud generator  $CG_{X_i}$  ( $i=1,2,\dots,n$ ; here  $n=49$ ).  $CG_{X_i}$  produces a group of random memberships  $\mu_{X_i}=\mu_{ij}$  ( $j=1,2,\dots,m$ ) here  $m=1000$ . The group of memberships represents the activating strength for corresponding rule. One of rules with membership  $\mu_{\max}$  is selected, which is the input of  $CG_{Y_i}$ . Then  $CG_{Y_i}$  produces  $Z_i$  with  $\mu_{\max}$  ( $i=1, 2, \dots, m$ ). If  $Z_i$  with  $\mu_{\max}$  satisfies the 3E rule, put  $Z_i$  belonging to  $[E_x-3E_n, E_x+3E_n]$  into  $CG_C$ . Finally, the  $E_{xu}$  is the numerical output. The wanted  $\Delta Z_V$  is actually the  $E_{xu}$ .

#### IV. SIMULATION AND ANALYSIS

A structure of the microgrid with two DGs is simulated to test the validation of the proposed control strategy in the Matlab. The DC voltage of each DG is 500V. The output voltage of each inverter is set peak value 311V with frequency 50Hz. The common load contains a resistor  $R_{Load}=10\Omega$  and an inductor  $X_{Load}=1mH$ . Each DG is terminated by an LC filter with the following values:  $L=3mH$  and  $C=150\mu F$ . The feeder impedances are  $R_{L1}=0.5\Omega$  and  $X_{L1}=1mH$  for DG1 and  $R_{L2}=0.8\Omega$  and  $X_{L2}=2.5mH$  for DG2.

We compare the proposed droop control method with the conditional droop control method with the different line impedance. Figs. 7 and 8 are the corresponding simulating results.

The proposed control has good performance according to the simulating results shown in Fig. 7. The three-phase voltages at the PCC are shown in Fig.7(a). The voltage waveforms are sinusoidal. The difference between the ideal three-phase voltage and the real three-phase voltage waveforms at the PCC is given in Fig. 7(b). Note that only small voltage differences (about 5V) can be observed. Fig. 7(c) shows  $P$  and

$Q$  waveforms from DG1 and DG2. Notice the good  $P/Q$  sharing that can be obtained by using the proposed approach.

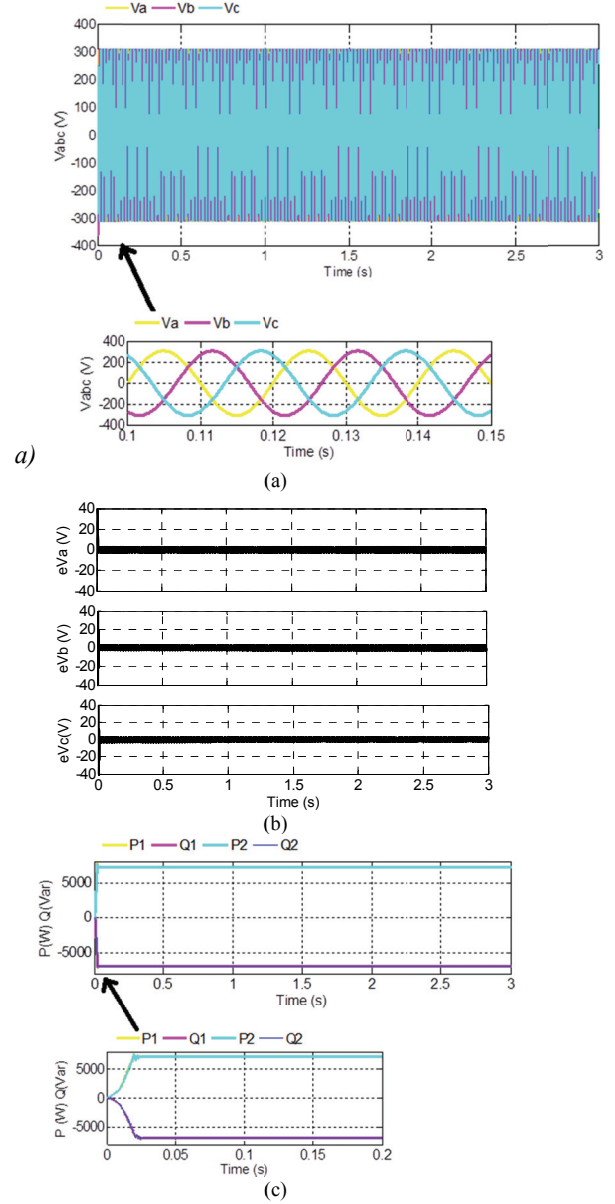
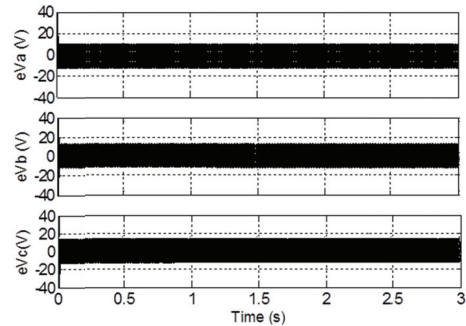

Fig. 7. Simulating results of the proposed control: (a) three-phase voltages at PCC, (b) the differences of three-phase voltages at PCC, (c)  $P$  and  $Q$  of DG1 and DG2.





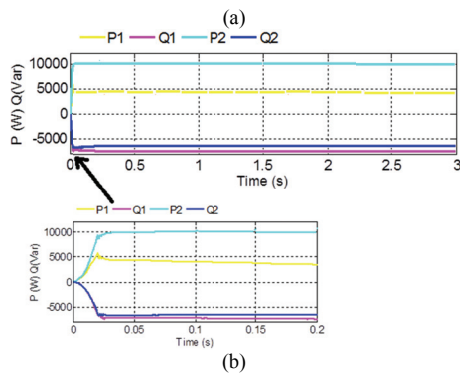

Fig. 8. Simulating results of the conventional droop control: (a) differences of three-phase voltages at PCC, (b) P and Q from DG1 and DG2.

The simulating results of the conventional droop control at the same conditions are shown in Fig.8. The three-phase voltage waveforms at PCC present a similar goodness, so they are not shown here. However, from the Fig.8(a) it can be seen that the differences between inverter voltages are bigger than these of the proposed control. As a conclusion, the performance of the proposed control method is better than that of the traditional droop control method. Note that by using this last one,  $P/Q$  cannot be properly shared due to the imbalanced feeder impedances.

From Fig.7 and 8, it can be seen that the proposed control can track the changing line impedance values and achieve good power sharing thanks to the use of the proposed tunable virtual impedance loop. Notice that in this case both the three-phase voltages at PCC and the  $P/Q$  sharing are well performed.

## V. CONCLUSION

A droop control equipped by an adjustable virtual impedance loop is proposed in this paper. The approach is based on the cloud model theory to adjust the changing virtual impedance in order to avoid  $P/Q$  coupling by compensating imbalanced line impedances. The cloud model can successfully bridge the gap between quantitative and qualitative methodologies when researching phenomenon uncertainties. Thus, the cloud model theory is applied well to adjust the

virtual impedance loop with the changing line impedances according to the reactive power  $Q$  changes. The obtained simulating results points out the superiority of the proposed control method in front of the conventional droop method.

## REFERENCES

- [1] M. C. Chandorkar, D. M. Divan, and R. Adapa, "Control of parallel connected inverters in standalone ac supply systems," *IEEE Trans. Ind. Appl.*, vol. 29, no. 1, pp. 136–143, Jan.1993.
- [2] J. Kim, J. M. Guerrero, P. Rodriguez, R. Teodorescu, and K. Nam, "Mode adaptive droop control with virtual output impedances for an inverter based flexible AC microgrid," *IEEE Trans. Power Electron.*, vol. 26, no. 3, pp. 689–701, Mar.2011.
- [3] Y. W. Li and C.-N. Kao, "An accurate power control strategy for power electronics-interfaced distributed generation units operating in a low voltage multibus microgrid," *IEEE Trans. Power Electron.*, vol. 24, no. 12, pp. 2977–2988, Dec.2009.
- [4] R. I. Bojoi, L. R. Limongi, D. Roiu, and A. Tenconi, "Enhanced power quality control strategy for single phase inverters in distributed generation systems," *IEEE Trans. Power Electron.*, vol. 26, no. 3, pp. 798–806, Mar.2011.
- [5] J. He, Y. W. Li, and S. Munir, "A flexible harmonic control approach through voltage controlled DG-grid interfacing converters," *IEEE Trans. Ind. Electron.*, vol. 59, no. 1, pp. 444–455, Jan.2012.
- [6] C. Wang, Z. Xiao, S. Wang, "Multiple feedback loop control scheme for inverters of the micro source in microgrids." *Transactions of China Electrotechnical Society*, vol.24, no.2, pp.100-107, Feb.2009.
- [7] J. M. Guerrero, J. C. Vasquez, J. Matas, et al. "Hierarchical control of droop-controlled AC and DC Microgrids-A general approach toward standardization," *IEEE Transactions on Industrial Electronics*, vol.58, no.1, pp.158-172, Jan.2011.
- [8] J. M. Guerrero, J. Matas, L. G. de Vicuna, M. Castilla, and J. Miret, "Decentralized control for parallel operation of distributed generation inverters using resistive impedance," *IEEE Trans. Ind. Electron.*, vol. 54, no. 2, pp. 994–1004, Feb.2007.
- [9] J. He, Y. W. Li, "Analysis, Design, and Implementation of Virtual Impedance for Power Electronics Interfaced Distributed Generation," *IEEE Trans. Ind. App.*, vol. 47, no. 6, pp. 2525-2538, Jun.2011.
- [10] D. Li, D. Cheung, X. Shi, "Uncertainty Reasoning Based on Cloud Models in Controllers", *Computers Mathematic Application*, vol.35, no.3, pp. 99-123, Mar.1998.
- [11] Y. Li, X. Fan, "Recursive integral proportional–integral control based on membership cloud for active power filter", *IET Power Electron.*, Vol. 7, no. 11, pp. 2870–2876, Jul.2014.