



AALBORG UNIVERSITY
DENMARK

Aalborg Universitet

Energy saving potential of a two-pipe system for simultaneous heating and cooling of office buildings

Maccarini, Alessandro; Wetter, Michael; Afshari, Alireza; Hultmark, Göran; Bergsøe, Niels Christian; Vorre, Anders

Published in:
Energy and Buildings

DOI (link to publication from Publisher):
[10.1016/j.enbuild.2016.10.051](https://doi.org/10.1016/j.enbuild.2016.10.051)

Creative Commons License
CC BY-NC-ND 4.0

Publication date:
2017

Document Version
Accepted author manuscript, peer reviewed version

[Link to publication from Aalborg University](#)

Citation for published version (APA):
Maccarini, A., Wetter, M., Afshari, A., Hultmark, G., Bergsøe, N. C., & Vorre, A. (2017). Energy saving potential of a two-pipe system for simultaneous heating and cooling of office buildings. *Energy and Buildings*, 134(January), 234-247. <https://doi.org/10.1016/j.enbuild.2016.10.051>

General rights

Copyright and moral rights for the publications made accessible in the public portal are retained by the authors and/or other copyright owners and it is a condition of accessing publications that users recognise and abide by the legal requirements associated with these rights.

- Users may download and print one copy of any publication from the public portal for the purpose of private study or research.
- You may not further distribute the material or use it for any profit-making activity or commercial gain
- You may freely distribute the URL identifying the publication in the public portal -

Take down policy

If you believe that this document breaches copyright please contact us at vbn@aub.aau.dk providing details, and we will remove access to the work immediately and investigate your claim.

Energy saving potential of a two-pipe system for simultaneous heating and cooling of office buildings

Authors

Alessandro Maccarini ^a, Michael Wetter ^b, Alireza Afshari ^a, Göran Hultmark ^c, Niels C. Bergsøe ^a
Anders Vorre ^c

^a Aalborg University, Danish Building Research Institute, A.C. Meyers Vænge 15, 2450 Copenhagen, Denmark

^b Lawrence Berkeley National Laboratory, 1 Cyclotron Road, Berkeley, CA 94720, USA

^c Lindab Comfort A/S, Lucernemarken 17, 3520 Farum, Denmark

Abstract

This paper analyzes the performance of a novel two-pipe system that operates one water loop to simultaneously provide space heating and cooling with a water supply temperature of around 22°C. To analyze the energy performance of the system, a simulation-based research was conducted. The two-pipe system was modelled using the equation-based Modelica modeling language in Dymola. A typical office building model was considered as the case study. Simulations were run for two construction sets of the building envelope and two conditions related to inter-zone air flows. To calculate energy savings, a conventional four-pipe system was modelled and used for comparison. The conventional system presented two separated water loops for heating and cooling with supply temperatures of 45°C and 14°C, respectively. Simulation results showed that the two-pipe system was able to use less energy than the four-pipe system thanks to three effects: useful heat transfer from warm to cold zones, higher free cooling potential and higher efficiency of the heat pump. In particular, the two-pipe system used approximately between 12% and 18% less total annual primary energy than the four-pipe system, depending on the simulation case considered.

Keywords

Energy saving, HVAC systems, low-exergy, simulation, Modelica, active beams

Acknowledgments

This study was financially supported by ELFORSK, a research and development program administrated by the Danish Energy Association. The work was supported by the Assistant Secretary for Energy Efficiency and Renewable Energy, Building Technologies Office, of the U.S. Department of Energy under Contract No. DE-AC02-05CH11231.

This research emerged from the Annex 60 project, an international project conducted under the umbrella of the International Energy Agency (IEA) within the Energy in Buildings and Communities (EBC) Programme. Annex 60 will develop and demonstrate new generation computational tools for building and community energy systems based on Modelica, Functional Mockup Interface and BIM standards.

Nomenclature

T_{sup}	Supply water temperature [°C]
T_{ret}	Return water temperature [°C]
k_{hea}	Offset in heating mode [°C]
k_{coo}	Offset in cooling mode [°C]
\dot{m}_{ven}	Outside air mass flow rate [kg/s]
$N_{persons}$	Number of persons [-]
A_{zone}	Area of the zone [m ²]
\dot{Q}	Thermal power [W]
\dot{m}_w	Water mass flow rate [kg/s]
cp_w	Water specific heat [J/kgK]
ΔT_w	Water temperature difference [K]
\dot{W}_{el}	Electric power [W]
a, b, c, d, e, f	Coefficients of the COP function [-]
COP	Coefficient of performance [-]
T_{LWC}	Water temperature leaving the condenser [°C]
T_{LWE}	Water temperature leaving the evaporator [°C]
T_a	External air temperature [°C]
Q_{hea}	Annual heat delivered to the water flow by the heat pump
Q_{coo}	Annual heat extracted from the water flow by the heat pump
$W_{el,hea}$	Annual electricity used in heating mode
$W_{el,coo}$	Annual electricity used in cooling mode

1. Introduction

Residential and commercial buildings require approximately 40% of the total end-use of energy [1]. Almost half of this energy is used to operate heating, ventilation and air-conditioning (HVAC) systems [2]. Such systems aim to maintain a comfortable indoor environment with room air temperatures between 20°C and 25°C. Because of the low temperature level, the exergy demand for room conditioning is low. However, in most cases this demand is satisfied with high-quality sources, such as fossil fuels or electricity [3]. However, extensive usage of fossil fuels causes several environmental and health issues, such as global warming, pollution and depletion of fossil natural resources.

Low-exergy building energy systems are defined as systems that provide heating and cooling at a temperatures close to the room temperature [4]. This allows the employment of low-valued energy, which can be delivered by sustainable energy sources such as waste heat, river/lake water, solar energy, geothermal applications and heat pumps, with a high coefficient of performance. Therefore, the use of low-exergy systems can reduce the environmental impact of buildings, and can play a crucial role in meeting the requirements for nearly zero-energy buildings. In addition, by maximizing the connection between buildings and freely available energy in the environment, the development of low-exergy systems generates new possibilities for the design of high-performance buildings [5].

Various studies about low-temperature heating systems have been carried out in the past years. Such systems are mainly based on applications with a high fraction of radiative heat distribution. Hasan et al. [6] analyzed the performance of a heating system with nominal supply/return water temperatures of 45°C/35°C. Such a system included radiators in rooms and floor heating in bathrooms. Hesaraki et al. [7] conducted an experimental study in low-temperature hydronic systems. A ventilation radiator with required supply water temperature of 30°C and a floor heating system with required supply water temperature of 33°C were compared to a baseline system. Sakellari and Lundqvist [8] modelled a low-temperature heating system in which the heat pump operated with a supply water temperature of 28°C. Afjei et al. [9][10] developed low-temperature heating systems that operate with nominal conditions around 30°C/25°C.

Several works have also been carried out in relation to high-temperature radiative cooling systems. Bejček [11] simulated the performance of an absorption solar cooling system connected to radiant-

cooled ceiling elements with chilled water temperature of 10-12°C. Miriel et al. [12] developed a ceiling-panel system model that operates with a temperature at 16°C. Zhao et al. [13] analyzed the performance of a radiant cooling system with supply water temperature of 18°C in a large-space building in China. Lehmann et. al [14] presented application range and functionality of thermal-activated building systems (TABS) with supply water temperature of about 19°C.

In the context of convective technologies, some works have been reported regarding the use of active beams, in particular for high-temperature cooling systems. Stein and Taylor [15] conducted a simulation-based investigation to predict the energy use of an active beam system installed in an office building in the US. Water supply temperature was maintained at 14°C. Rumsey and Weale [16] analyzed the functioning of a cooling system for laboratories in which chilled water between 13°C and 16°C was delivered to active beam units. Fong et al. [17] studied the performance of a solar hybrid cooling system that integrated active beams with a supply water temperature of 18°C. No relevant literature was found on the application of active beams for heating purposes, but common guidelines suggest a hot water temperature of about 35-45°C [18]. It is noticed that, in general, a minimum temperature of 28-30°C is used in low-temperature heating applications, and a maximum temperature of 18-19°C is found in high-temperature cooling applications. A comprehensive study of low-exergy systems was carried out by the Annex 49; a task-shared international research project developed within the framework of the International Energy Agency (IEA) programme on Energy Conservation in Buildings and Community Systems (ECBCS). This project aimed at improving, both on a community and building level, the design of energy-use strategies which include the analysis and optimization of exergy demand in heating and cooling systems [19].

As previously mentioned, the use of operating temperatures close to room air temperatures facilitates the integration of sustainable energy sources and therefore reduces total emissions of CO₂. By lowering the hot water temperature even more in heating systems, and raising the chilled water temperature even more in cooling systems, further advantages could be achieved in terms of maximizing the use of sustainable energy sources. This practice is not currently exploited, mainly due to the fact that the use of water temperatures extremely close to room conditions would require large heat exchanger areas. However, new technological developments in active beam devices have recently made it possible to use water temperature very close to room conditions while keeping a reasonable amount of heat transfer area [20]. The limiting case of lowering heating water temperature, and raising cooling water temperature, can be seen as a system where heating and

cooling circuits have the same water temperature, somewhere between the indoor comfort limits of 20°C and 25°C. The design, modeling and energy savings potential of a system with such a characteristic are studied in this article.

An added benefit of operating heating and cooling systems at temperatures close to room temperature is that their rate of heat transfer is very sensitive to changes in room temperature. This is known as a self-regulation effect [9], which can be explained as follows. For simplicity, consider a heating system, but a similar explanation applies for a cooling system. The heat transferred between the heating system and the space is

$$\dot{Q} = \dot{Q}_0 \left(\frac{\theta}{\theta_0} \right)^n, \quad (1)$$

where the subscript 0 denotes design conditions, \dot{Q} is the transferred heat, n is the heat transfer exponent and θ is the mean logarithmic temperature difference

$$\theta = \frac{T_2 - T_1}{\ln \left(\frac{T_2 - T}{T_1 - T} \right)}, \quad (2)$$

where T is the room temperature, T_1 is the supply water temperature and T_2 is the return water temperature of the heat exchanger. Taking the derivative of (1) yields

$$\frac{d\dot{Q}}{d\theta} = n \left(\frac{\dot{Q}_0 \theta^{n-1}}{\theta_0^n} \right), \quad (3)$$

Normalizing (3) by dividing it by (1) yields

$$\frac{d\dot{Q}}{d\theta} \frac{1}{\dot{Q}} = \frac{n}{\theta}, \quad (4)$$

Fig.1 shows this relation for the temperature range encountered in space heating systems for $n=1.1$, which is typical for radiant floors, and for $n = 1.2 \dots 1.4$, which is typical for radiators.

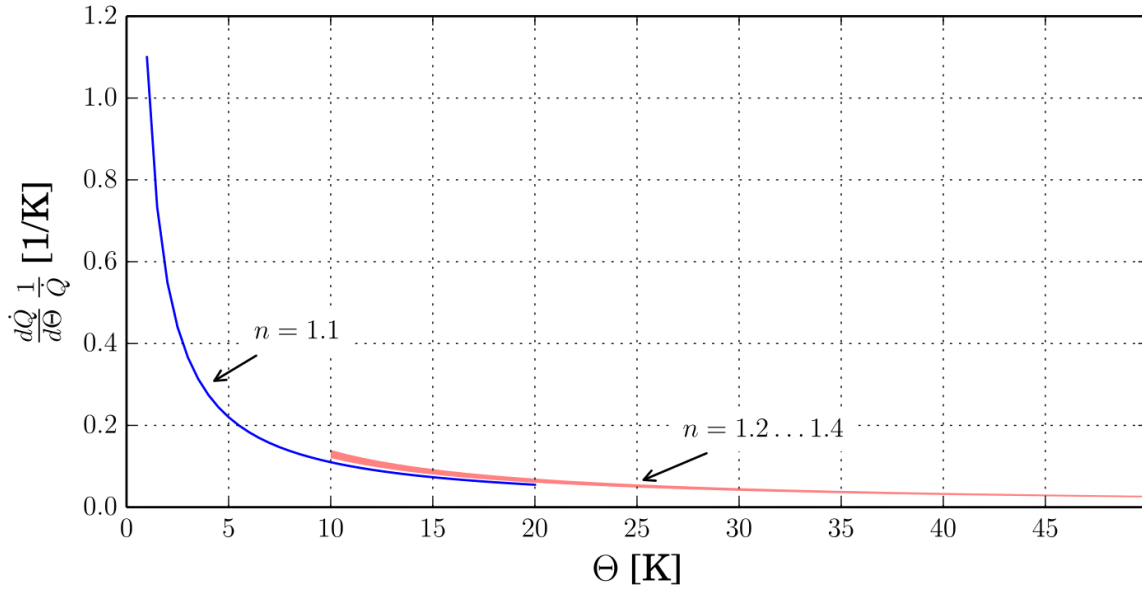

Fig. 1 Self-regulation effect of a heating system. Blue is the typical operating range of low-temperature heating systems, whereas red is the operating range for conventional systems.

In our design, as we shall see below, the supply and return water design conditions are 45/35°C for the conventional system, while for the novel two-pipe system these temperatures are 23/21°C, both at a room temperature of 20°C. Therefore, the novel two-pipe system operates with a typical temperature difference of around 1 K to 2 K, whereas the conventional system has a mean logarithmic temperature difference of 20 K at design conditions, or 10 K at half load, which is its usual operating load. Hence, a change in room temperature by a mere 0.5 K leads to a 50% reduction in transferred heat for the low exergy system, but only to a 5% reduction for the conventional system. This effect can be exploited to simplify the room temperature control, as shown in [9][10]. In some jurisdictions, the energy code takes this into account. For example, in Basel Stadt, Switzerland, automatic temperature control for each room is only required if the supply water temperature at design conditions is higher than 30°C [21]. Thus, by using lower supply temperatures, system cost and control complexity can be reduced, as individual room-temperature feedback-control systems are no longer required.

The article is organized as follows: Section 2 describes the physical concept behind the novel two-pipe system; Section 3 illustrates the simulation-based research adopted to investigate the energy performance of the system; the results and discussions, in respect to a comparison with a traditional four-pipe system are shown in Section 4; Section 5 concludes the article by summarizing the main findings.

2. Concept

The need for simultaneous heating and cooling occurs quite frequently in office buildings. During a cold day, a north-oriented room needs heating to maintain an indoor temperature level above 21°C. At the same time, in the same building, a south-oriented room may need cooling to maintain an indoor temperature below 24°C. Traditional two-pipe systems cannot deal with this situation, as they are in either heating mode or cooling mode. A four-pipe system is the common layout to provide heating to one zone and cooling to another zone by operating with two, separate water loops.

The characteristic of the novel two-pipe system is its ability to provide simultaneous heating and cooling through a water loop that is near the room temperature. Supply water temperature of about 22°C is delivered to all the thermal zones in the building, no matter whether a single zone needs heating or cooling. Outlet water from the zones is mixed together, and as a result the system only has to cool or heat the water to stabilize the supply temperature. The overall effect is that the system is able to distribute the excess heat from warm to cold zones when simultaneous heating and cooling demand occurs in the building. In addition, due to high operating water temperatures in cooling mode and low operating water temperatures in heating mode, the system can take advantage of the integration of sustainable energy sources and vapor-compression engines operating with high coefficients of performance (COP). Fig. 2 shows a schematic diagram of the novel two-pipe system.

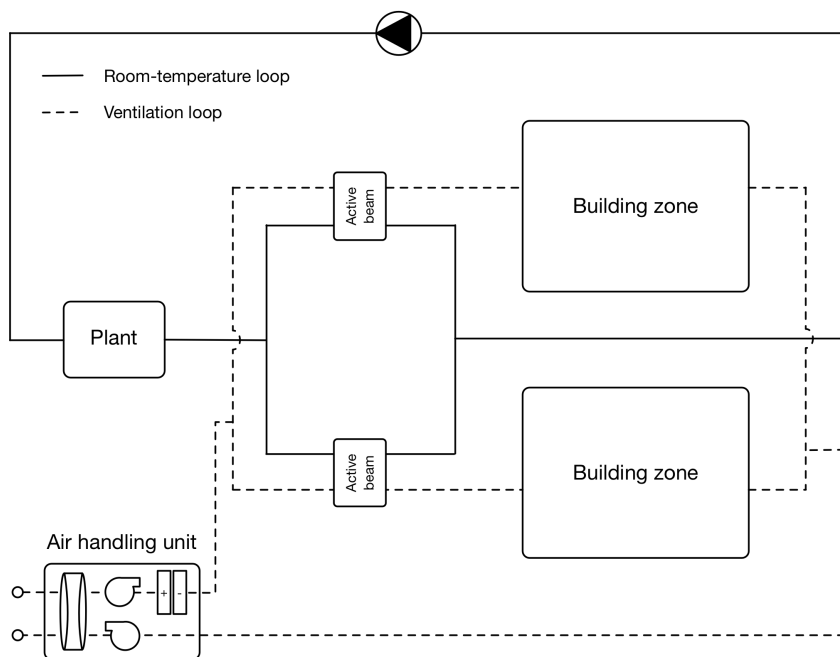

Fig. 2 Schematic diagram of the two-pipe system

3. Methodology

3.1 Previous studies and Modelica

Computer modeling and simulation is a powerful technology for calculating energy performance in buildings. For the past 50 years, a variety of Building Performance Simulation tools (BPS) have been developed and used by the building energy research community and by building designers. These tools perform simulations and calculate the energy performance of a building by solving a system of equations that describes the thermal behavior of the envelope and the HVAC system. Climate, schedules of operation and internal loads are the boundary conditions of simulations [22].

Previous preliminary studies were carried out by the authors in order to analyze the energy performance of the two-pipe system. Energy simulations were performed by using common BPS tools. Afshari et al. [23] developed a model of the system with BSim, a program for calculating indoor climate conditions and energy demands in buildings. The use of BSim showed two key limitations. First, BSim does not include any terminal unit clearly defined as active beam. Therefore, the system was simplified by modeling fan coils for cooling and radiators for heating. Second, BSim treated heating and cooling as two separate processes. Therefore, the energy performance of the system could only be calculated by making some assumptions in a post-processing analysis. Maccarini et al. [24] investigated the possibility of modeling the system in EnergyPlus; a whole building energy simulation program. Simulations with EnergyPlus allowed a wider understanding of the energy behavior of the system, primarily because EnergyPlus includes a specific terminal unit, defined as active beam. However, also EnergyPlus considered heating and cooling as two separate processes. In addition, limitations were found in respect to the modelling of the controller for the regulation of the supply water temperature in the room-temperature loop.

It became clear that a more flexible modeling tool was necessary for a comprehensive investigation of the two-pipe system. Therefore, Dymola, a commercial simulation environment for Modelica models, was chosen for this study.

Modelica [25], developed by the Modelica Association, is a freely available, object-oriented equation-based language for modeling large, complex, and heterogeneous physical systems. It has been used for almost two decades, especially in the design of multi-domain engineering systems such as mechatronic, automotive and aerospace applications involving mechanical, electrical, hydraulic and control subsystems. The use of Modelica has only recently extended to the building

energy research community, because of the upcoming need for more complex and efficient energy systems and the availability of open-source libraries for building HVAC applications.

Currently, several Modelica libraries exist for building components and HVAC systems, and these are continuously being upgraded [26]–[29]. Moreover, the International Energy Agency (IEA) has undertaken a large-scale international project (IEA ECB Annex 60, <http://iea-annex60.org/>) with the aim to develop a new generation of computational tools for building energy systems based on Modelica.

Models from the *Buildings* library v2.1.0 were used in this work. In conclusion, the use of Modelica has allowed the development of a detailed and comprehensive model of the two-pipe system.

3.2 Description of the building model

The energy performance of the two-pipe system was evaluated through its integration in a reference building model. The geometry of the building model is illustrated in Fig. 3. It consists of four perimeter thermal zones and one core thermal zone. The total floor area is 1660 m² with an aspect ratio of 1.5. This five-zone model is representative of one floor of the medium office building prototype, as described in the report, *U.S. Department of Energy Commercial Reference Building Models of the National Building Stock* [30]. The report characterizes 16 prototype buildings for 16 climate zones covering the majority of the US commercial building stock. These building models have been developed to serve as a starting point for energy efficiency research, as they represent fairly realistic buildings and typical construction practices.

Since the publication of the report, the Pacific Northwest National Laboratory (PNNL) has made numerous enhancements to the original prototype models that are now compliant with 2004, 2007, 2010 and 2013 editions of ASHRAE standard 90.1 [31].

In this work, a comparison of the energy performance of the two-pipe system was made by considering two cases in respect to two construction sets of the building envelope, compliant with ASHRAE 90.1 2004 and 2013 standards. Table 1 illustrates the thermal properties of the building elements for the two construction sets. The roof and the external walls were exposed to the outdoor environment while the floor to a set of monthly average ground temperatures. These twelve temperature values were retrieved from the prototype office building model and range between 20.34 °C (January) to 23.22 °C (August). The glazing surfaces were evenly distributed along all facades with a window-to-wall ratio of 0.33 and consist of double pane windows with solar control

properties. In accordance with the prototype office building models, no shading devices were applied to the windows. The weather conditions of Copenhagen (Denmark) were used.

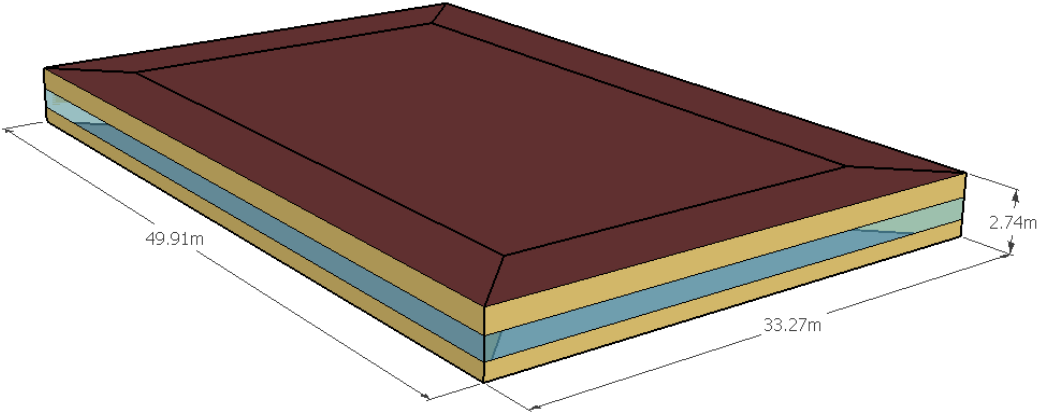

Fig. 3 Geometry of the building model adopted as the case study

Table 1

Thermal properties of the building elements for ASHRAE 90.1 2004 and 2013 prototype models (Climate zone 5C, cool marine)

Building element	U-value (W/m ² K)
ASHRAE 90.1 2004	
External Walls	0.48
Roof	0.35
Floor	1.83
Windows	3.05 (SHGC=0.43)
ASHRAE 90.1 2013	
External Walls	0.31
Roof	0.18
Floor	1.83
Windows	2.37 (SHGC=0.4)

The need for simultaneous heating and cooling of thermal zones not only depends on the heat exchanged with the outside and the HVAC system, but also on the heat transferred between the zones. In the limiting case of no heat transfer between zones, the differences in room temperature can be large, whereas if there is very high air flow between zones, such as through open doors, all rooms would be at a similar temperature. Therefore, two cases for inter-zone air flows were considered to take into account different inter-zone heat transfers. The first case allowed only heat transfer between thermal zones through internal walls. Therefore, no air exchange occurred through the rooms. Internal walls consisted of two gypsum boards with a thickness of 0.013 m each. In the second case, internal doors were included in the model. The doors were evenly distributed along the internal walls every 4 m and assumed to be always open.

The door model allows for bi-directional air flows through adjacent zones. The bi-directional air flow is modeled based on the differences in static pressure between adjacent rooms at a reference height plus the difference in static pressure across the door height as a function of the difference in air density. A comprehensive description of this Modelica model can be found in [32]. It is worth mentioning that no relevant literature was found by the authors regarding patterns of opening-

closing doors in office buildings. The two conditions simulated in this work can be seen as the two extreme, but realistic, limiting cases.

Internal heat gains and infiltration rates were selected according to the medium office prototype building previously mentioned. In particular, an average infiltration rate of 0.13 and 0.08 ACH was applied to the perimeter zones, respectively, for the ASHRAE 90.1 2004 and 2013 case. Internal gains due to people, lighting and equipment were, respectively, 6.5 W/m², 10.8 W/m² and 8 W/m² for ASHRAE 90.1 2004. The internal heat gain due to lighting is reduced to 8.8 W/m² for ASHRAE 90.1 2013. Working hours were assumed to be between 8 AM and 5 PM on weekdays. Table 2 summarizes the four cases simulated.

Table 2
Description of the cases

Case	Construction set / heat gains / ACH	Inter-zone air flow
1	ASHRAE 90.1 2004	No doors
2	ASHRAE 90.1 2013	No doors
3	ASHRAE 90.1 2004	With doors open
4	ASHRAE 90.1 2013	With doors open

3.3 HVAC system modeling

The graphic layout of the system modelled in Dymola is shown in Fig. 4. It consists of a room-temperature water loop for space heating and cooling and an air loop for ventilation. The pump circulates a constant water mass flow rate in the room-temperature loop. Heating and cooling loads are met by adjusting the supply water temperature through a feedback controller. The plant provides energy to the return water flow to track the supply temperature set-point. Water enters the active beam terminal units in which, together with the primary air delivered by the air handling unit (AHU), it exchanges heat with the rooms.

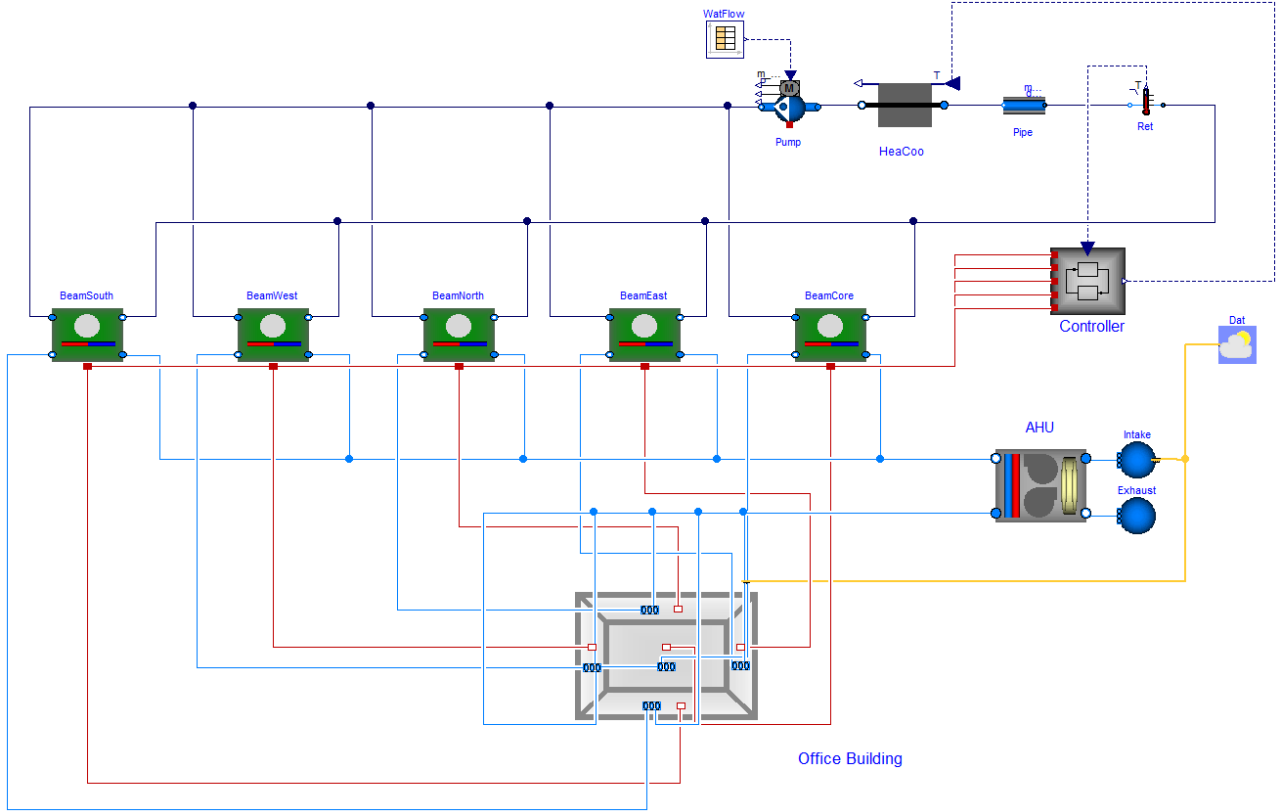

Fig. 4 Layout of the Modelica system model. Light-blue lines represent air streams, dark-blue lines represent water streams, red lines represent convective heat exchange and temperature signals, and dashed blue lines represent control signals.

Exhaust air from the rooms is distributed to a heat recovery device in the AHU. The AHU also consists of heating and cooling coils that control the primary air temperature. A fan supplies a constant air mass flow rate to the building. The key components of the system are described in the following sections.

3.3.1 Supply water temperature controller

As previously mentioned, the system is able to simultaneously provide heating and cooling to the building. Therefore, the supply water should have temperature levels similar to indoor thermal comfort conditions. A feedback controller takes as inputs the room temperatures, their set-points and the return water temperature, and outputs a set-point for the supply water temperature. The set-point for the supply water temperature is

$$T_{sup} = T_{ret} + k_{hea} - k_{coo}, \quad (5)$$

where T_{ret} is the return water temperature and k_{hea} and k_{coo} are offsets used to adjust the supply water set-point temperature based on current room air temperatures and their heating and cooling set-points. Fig. 5 shows the Modelica model of the controller. The block *MinMax* outputs the minimum and maximum room air temperature among the five rooms. The minimum room air temperature is an input for the block *PIhea*, where it is compared with the heating temperature set-point. If the minimum room air temperature is above the set-point, k_{hea} is equal to 0. Otherwise, the PI controller increases the value of k_{hea} to meet the heating set-point. The maximum room air temperature is an input for the block *PIcoo*, where it is compared with the cooling temperature set-point. If the maximum room air temperature is below the set-point, k_{coo} is equal to 0. Otherwise, the PI controller increases the value of k_{coo} to meet the cooling set-point. Heating set-point temperatures were 15.6°C and 21°C, respectively, for non-operating and operating hours. Cooling set-point temperatures were 26.7°C and 24°C, respectively, for non-operating and operating hours. These values were chosen according to the medium office prototype model. The upper limit for k_{hea} and k_{coo} was 10 K.

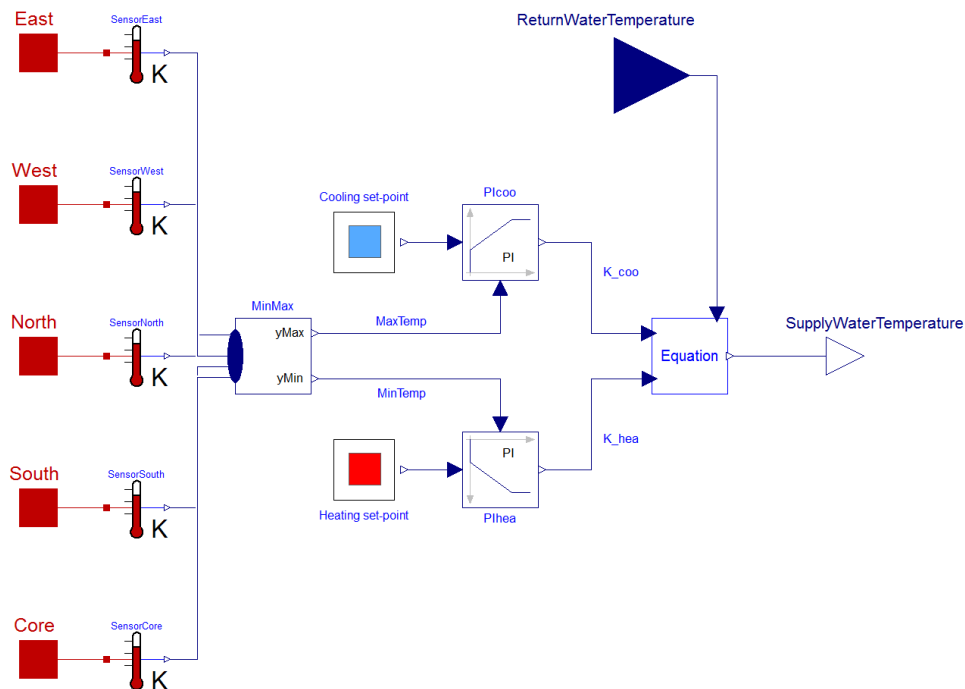

Fig. 5 Modelica model of the controller for supply water temperature set-point.

3.3.2 Active beam unit and air handling unit (AHU)

Fig. 6 shows a schematic diagram of a general active beam unit. It consists of a primary air plenum, a mixing chamber, a heat exchanger and several nozzles.

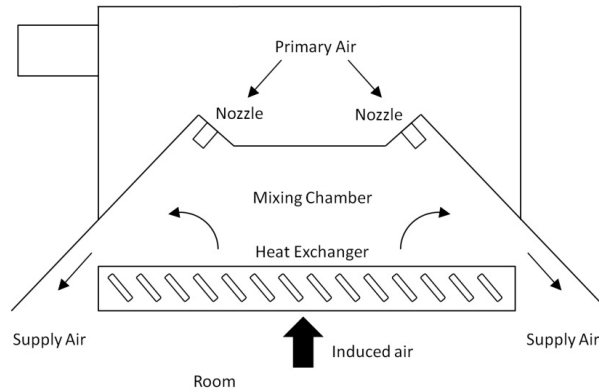

Fig. 6 Diagram of an active beam unit

The heat exchanger is served by a water circuit. The primary air is discharged to the mixing chamber through the nozzles. This generates a low-pressure region which induces air from the room up through the heat exchanger. The conditioned induced air is then mixed with primary air, and the mixture descends back into the space.

A comprehensive description and validation of the active beam model used in this work is provided in [33]. The model encapsulates empirical equations derived by a novel active beam terminal unit that operates with low-temperature heating and high-temperature cooling systems [20].

The AHU used in our experiments consists of supply and return fans and two coils. Heating and cooling coils are connected to secondary plants in order to maintain a constant supply air temperature of 19°C. A heat recovery unit (HRU) with maximum efficiency of 0.9 pre-heats the outdoor air. The HRU was modelled as a rotary heat exchanger with a PI controller regulating the efficiency of the unit. The actual efficiency, and therefore the actual heat transferred between supply and return air streams, is modulated between 0 and 0.9 according to the actual needs.

3.3.3 Sizing

Heating and cooling peak loads of the building were pre-calculated by running dedicated simulations in Dymola. Two sizing calculations were performed in respect to the two construction sets. The number of active beams placed in each thermal zone was a consequence of the pre-

calculated loads, chosen design parameters and ventilation requirements. The maximum specific capacity installed in the perimeter zones was equal to approximately 60 W/m² and 50 W/m², respectively, for AHSRAE 90.1 2004 and 2013 constructions. For the core zone, a maximum specific capacity of approximately 30 W/m² was installed for both constructions. Table 3 shows the design parameters for the heating and cooling mode. The values of these parameters were chosen according to the REHVA chilled beam application guidebook [18] and manufacturer's recommendations. The ventilation requirements were selected according to the Danish standard DS/EN 15251 [34] and were calculated according to

$$\dot{m}_{ven} = 0.0084 * N_{persons} + 0.00084 * A_{zone}, \quad (6)$$

where \dot{m}_{ven} is the outside air mass flow rate in [kg/s], $N_{persons}$ is the number of persons in the zone and A_{zone} is the area of the zone in [m²].

To reduce the energy use of fans and pumps, but still keep a sufficient thermal capacity to meet the set-points, the total air and water mass flow rates were multiplied by a factor 0.5 and 0.25, respectively, during non-operating hours (10 PM-6 AM).

Table 3

Design parameters. These values refer to a single active beam unit

	Cooling	Heating
Room air temperature	24 °C	20 °C
Primary air temperature	19 °C	19 °C
Supply water temperature	20 °C	23 °C
Nozzle pressure	100 Pa	100 Pa
Primary air mass flow rate	0.026 kg/s	0.026 kg/s
Water mass flow rate	0.038 kg/s	0.038 kg/s
Length	3.0 m	3.0 m
Total capacity	507 W	252 W

3.3.4 System configurations

The four cases previously described were analyzed for three configurations of the system. Each configuration aimed to highlight a different aspect of the energy savings of the two-pipe system. The three configurations were defined as:

- Ideal configuration
- Ideal configuration with dry cooler
- Real configuration

The ideal configuration included Modelica models of ideal plants for both the water and air loops. This means that the energy use has to be considered as useful energy use, which can be defined as the energy required once all the losses have been deducted from the delivered amount of energy. These ideal plants calculated the thermal power delivered to the water stream as

$$\dot{Q} = \dot{m}_w cp_w \Delta T_w, \quad (7)$$

where \dot{m}_w is the water mass flow rate, cp_w is water specific heat capacity and ΔT_w is the water temperature difference between supply and return.

This ideal configuration allowed prediction of the actual energy savings related to the useful heat transferred from warm to cold rooms by the room-temperature loop when simultaneous heating and cooling occurred.

In the second system configuration, a dry cooler was added to take advantage of free cooling. The dry cooler was dimensioned to be able to cool the return water to the design temperature condition of 20°C with a temperature difference of 6 K between water and outside air. Therefore, whenever the outside air temperature was below 14°C, no cooling energy was required by the water plant in the room-temperature loop.

In the third system configuration, the ideal models were replaced by more realistic components. In particular, a reversible air-to-water heat pump model was integrated into the room-temperature loop. Furthermore, the AHU heating coil was supplied by a heat pump with a supply water temperature of 45°C, while the cooling coil was connected to a chiller with a supply water temperature of 7°C. Average efficiencies for pumps and fans were set to 0.8.

At the full flow rate, the total pressure drop in the water loop was assumed to be 35 kPa, as recommended in [18], and the total pressure drop in the ventilation loop was assumed to be 500 Pa. This value was based on the author's expertise. For lower flow rates, e.g. during night operation,

these values are reduced, as the simulation model computes flow friction as a function of the flow rate. Assuming that the thermal losses of hydronic parts, such as pipes and valves, are small in comparison to the total energy transferred to the active beams, these were neglected in the model.

3.3.5 Heat pump model

It is worth mentioning that the Modelica *Buildings* library v2.1.0 does not include any model specifically defined as an air-to-water heat pump. Therefore, a new model was developed by the authors. The model was based on performance curves related to the Maroon 2 unit by Swegon [35]. The heat pump was assumed to be designed to deliver 100% of the thermal power required by the system. At every time-step, the electric power used by the heat pump was calculated as

$$\dot{W}_{el} = \frac{\dot{Q}}{COP_{actual}}, \quad (8)$$

where COP_{actual} is the actual COP calculated as a function of the evaporator and condenser temperatures for heating and cooling mode, using

$$COP_{actual,hea} = a + b T_{LWC} + c T_{LWC}^2 + d T_a + e T_a^2 + f T_{LWC} T_a, \quad (9)$$

$$COP_{actual,coo} = a + b T_a + c T_a^2 + d T_{LWE} + e T_{LWE}^2 + f T_a T_{LWE}, \quad (10)$$

where T_{LWC} is the water temperature leaving the condenser in [°C], T_{LWE} is the water temperature leaving the evaporator in [°C] and T_a is the external air temperature in [°C]. Table 4 shows the value of the coefficients expressed in Eq. (9) and Eq. (10). These were obtained by using a curve-fitting approach based on a set of performance data retrieved from the technical documentation of the heat pump. Fig. 7 shows the COP curves of the heat pump in heating and cooling mode for three reference values of the water temperature.

Table 4

Coefficients used in Eq. (5) and Eq. (6)

	a	b	c	D	e	f
Heating	5.959E+00	-6.883E-02	1.426E-01	4.465E-05	8.681E-04	-1.808E-03
Cooling	6.705E+00	1.036E-01	-1.563E-01	-1.428E-03	9.500E-04	-5.979E-04

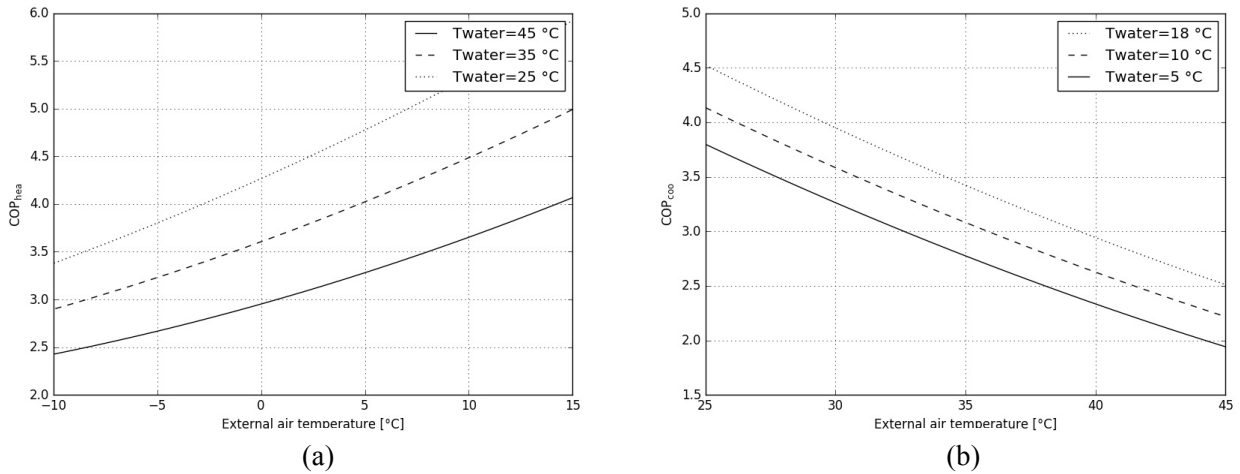
**Fig. 7** COP curves of the heat pump in heating (a) and cooling (b) mode

4. Results and discussion

In order to compare the energy savings of the two-pipe system (2PS), a comparative study was conducted in respect to a conventional four-pipe system (4PS). Yearly dynamic simulations were run in Dymola version 2016 on a Windows machine. The annual energy use was calculated for both the 2PS and the 4PS for the four cases. These simulations were done three times, one for each configuration of the system.

4.1 Conventional four-pipe system

The conventional four-pipe system presented two separate water circuits, one for heating and one for cooling. Supply water temperature for heating and cooling was set to 45°C and 14°C,

respectively. Each thermal zone was equipped with the same number of active beams as for the two-pipe system. However, due to the higher temperature difference between water and room air, the beam length was reduced from 3 m to 0.7 m. The same air-to-water heat pump and dry cooler models were integrated into the water circuits.

To present a fair energy comparison, the 4PS was forced to maintain the same indoor air temperatures as calculated by the simulation with the 2PS during operating hours. This was done by implementing water flow controllers with room air temperature set-points equal to the room air temperature values obtained in the corresponding simulation with the 2PS. To avoid chattering of the mode-switching of the controller, a dead band of 0.2 K was used. Therefore, the 4PS was supposed to reach temperatures 0.1°C colder than the 2PS in heating mode, and 0.1°C warmer in cooling mode.

The ventilation loop of the 4PS had the same characteristics as the loop implemented into the 2PS in terms of temperatures and air flow rates. Therefore, since air temperatures in the rooms were approximately the same, and ventilation parameters were exactly the same, it can be concluded that the two systems will use approximately the same amount of energy for ventilation purposes. This has made it possible to focus attention on the water side of the system.

4.2 Simulation results

Figs. 8-11 show the annual heating and cooling energy use for the three configurations of the system. To clearly visualize the energy savings of the room-temperature loop, the ventilation energy use was omitted from these graphs.

The overall annual energy use (including ventilation) is shown in Fig. 12. The indoor air temperatures of the five thermal zones are shown in Figs. 13-14 for a typical winter and summer day. Figs. 13-14 also illustrate the supply and return water temperatures.

4.2.1 Ideal configuration - energy savings due to heat transfer through rooms

Fig. 8 shows the comparison of the annual heating and cooling useful energy use for the first system configuration. As illustrated, the 2PS required less useful heating and cooling energy than the 4PS in all four cases. This means that the room-temperature loop was able to remove heat from the warm core zone and release it to the cold perimeter zones. In particular, energy savings of approximately 17%, 21%, 4% and 6% were achieved, respectively, for cases 1, 2, 3 and 4. Note that the cases with doors open present a significantly lower potential for energy savings when

compared with the cases with no doors. By having inter-zone air flow, heat is passively transferred from the core zone to perimeter zones by density differences in the rooms. This also explains why cases with doors open require less energy than the cases without doors.

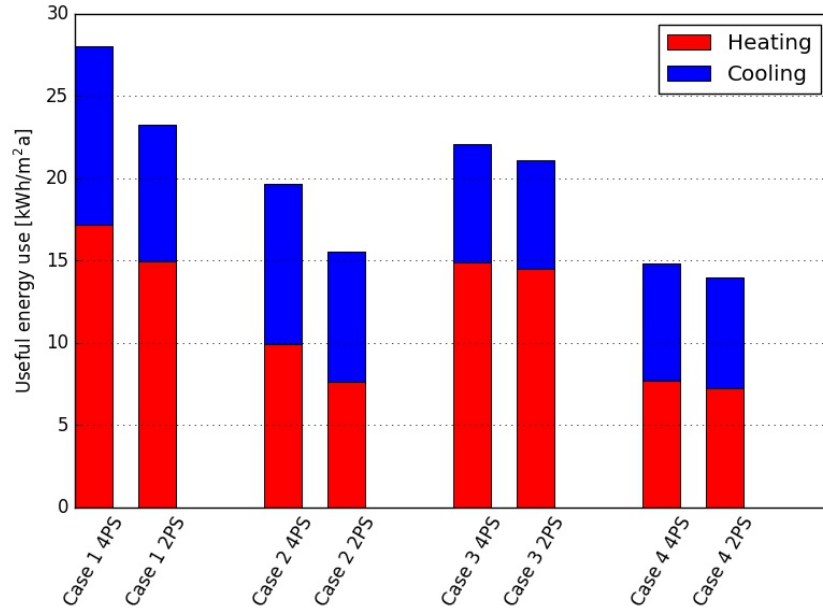

Fig. 8 Useful energy use – Ideal configuration

When comparing cases with the same inter-zone air flow condition, it can be seen that the thermal properties have little influence on the energy savings. The absolute amount of heat transferred in cases with poorer insulation and higher internal loads (cases 1 and 3) is slightly higher than in cases with better insulation and lower internal loads (cases 2 and 4). However, since the system requires more energy to meet set-point temperatures, the relative difference is lower.

The energy savings due to heat transfer between rooms can be illustrated by comparing the total heating and cooling thermal power provided by the central plant for a typical winter day, as shown in Fig. 9. At the beginning and at the end of the day, due to the absence of internal heat gains, the building only needs heating. Therefore, both systems present the same profile. In the middle of the day, while the 4PS has to provide separate heating to perimeter zones and cooling to the core zone, the 2PS is able to provide heating and cooling simultaneously. As a consequence, almost no energy is required.

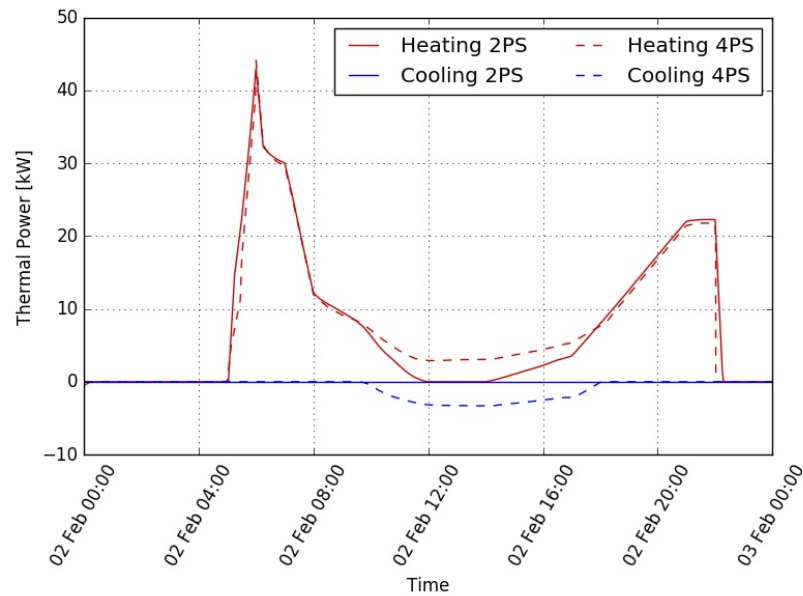

Fig. 9 Thermal power provided by the plant for a typical winter day – Case 1

4.2.2 Ideal configuration with dry cooler - energy savings due to free cooling

Fig. 10 illustrates the annual heating and cooling useful energy use for the second system configuration. In this configuration, a dry cooler was added to the two systems. The heat removed by the dry cooler is also shown in Fig. 10 for each simulation case. Due to a higher supply water temperature than the 4PS, the 2PS was able to take better advantage of free cooling conditions. The 2PS presents a significantly higher value of heat removed in all four cases. In particular, the dry cooler in the 2PS removed approximately 67%, 70%, 65% and 69% of cooling demand versus 31%, 33%, 16% and 18% in the 4PS, respectively, for cases 1, 2, 3 and 4. No significant difference is seen between cases with the 2PS. When considering the 4PS, cases with open doors have significantly lower heat removal potential than cases with closed doors. This can be explained by noticing that the dry cooler in the 4PS mainly operates during the cold season, when the outside temperature is below 8°C. However, when the outside air temperature is that cold, the inter-zone air flows suffice to transfer excess heat among zones, thereby avoiding the need to provide free cooling with the dry cooler.

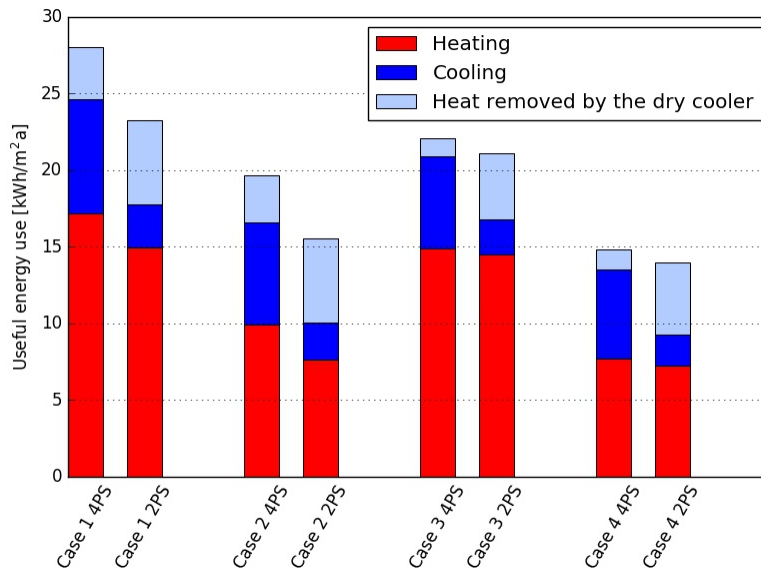

Fig. 10 Useful energy use – Ideal configuration with dry cooler

4.2.3 Real configuration - energy savings due to higher COP of the heat pump

Fig. 11 shows the annual heating and cooling primary energy use for the third system configuration. Here, the ideal plants were replaced by heat pump and chiller models. A factor of 2.5 was assumed for the conversion of electricity into primary energy. This is a typical value for the Danish energy market [36].

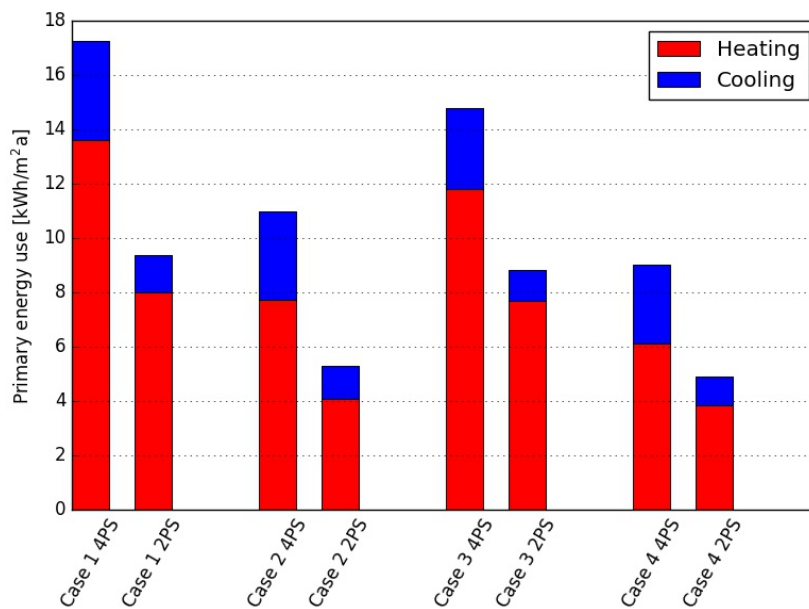

Fig. 11 Primary energy use – Real configuration

Additional energy savings were achieved thanks to the larger temperature difference between evaporator and condenser. The 2PS used approximately 46%, 52%, 40% and 45% less primary

energy than the 4PS, respectively, for cases 1, 2, 3 and 4. Table 5 shows the Heating Seasonal Performance Factor (HSPF) and the Cooling Seasonal Performance Factor (CSPF) for the four cases, defined as

$$HSPF = \frac{Q_{hea}}{W_{el,hea}}, \quad (7)$$

$$CSPF = \frac{Q_{coo}}{W_{el,coo}}, \quad (8)$$

where Q_{hea} is the annual heat delivered to the water flow by the heat pump, Q_{coo} is the annual heat extracted from the water flow by the heat pump, $W_{el,hea}$ is the annual electricity used in heating mode and $W_{el,coo}$ is the annual electricity used in cooling mode.

All the cases present similar values for both the HSPF and CSPF. An average HSPF value of 3.16 and 4.69 was found, respectively, for the 4PS and 2PS. This means that the air-to-water heat pump integrated in the 2PS achieved approximately 48% better performance than the pump integrated in the 4PS thanks to lower supply water temperatures in the water loop. An average CSPF value of 5.08 and 5.03 was found, respectively, for the 4PS and 2PS. No significant difference was noted due to the low average outside air temperatures in Copenhagen.

Table 5

Heating Seasonal Performance Factor (HSPF) and Cooling Seasonal Performance Factor (CSPF)

	Case 1		Case 2		Case 3		Case 4	
	CS	NS	CS	NS	CS	NS	CS	NS
HSPF	3.16	4.69	3.22	4.68	3.15	4.71	3.14	4.69
CSPF	5.09	5.04	5.08	5	5.05	5.04	5.09	5.02

4.2.4 Real configuration - total energy savings

Fig. 12 and Table 6 show the total annual primary energy use for the four cases. Energy use for ventilation and pumps was added to the values obtained in Fig. 11. When comparing the total primary energy, the 2PS used approximately 18%, 17%, 13% and 12% less energy than the 4PS. As illustrated, fans account for a large share of the total energy, reducing the relative energy savings

achieved due to the room-temperature loop. Since the 2PS circulated water continuously, pumps have higher energy use than the 4PS.

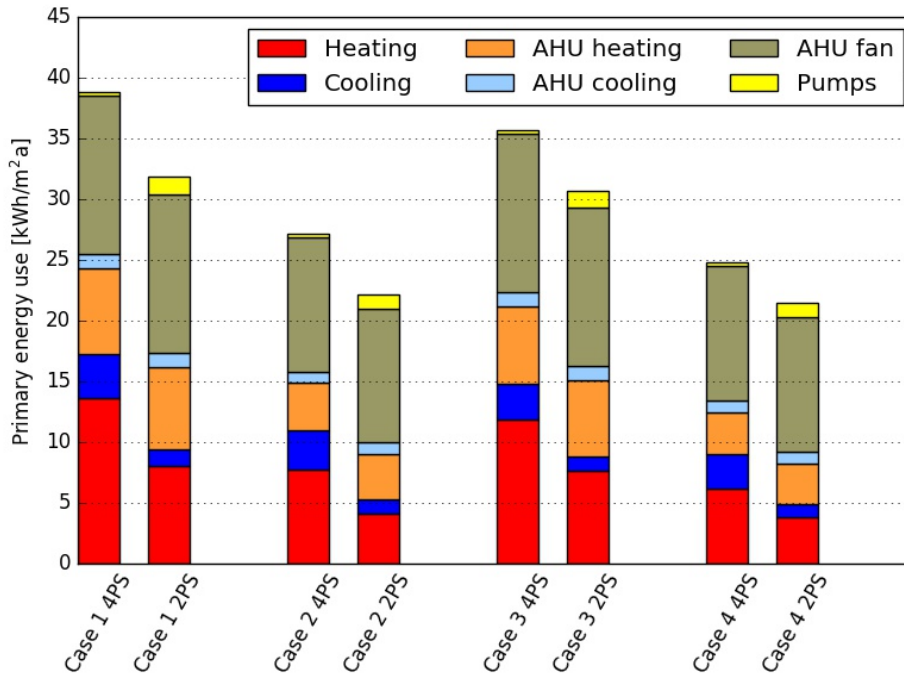

Fig. 12 Total annual primary energy use – Real configuration

The comparative behavior between the cases reflects the previously described pattern. Cases with the doors open achieved lower energy savings than the cases without doors, and no significant influence was noted between cases with different thermal properties of the building envelope.

Table 6

Annual total primary energy use by service [kWh/(m² a)]

	Case 1		Case 2		Case 3		Case 4	
	4PS	2PS	4PS	2PS	4PS	2PS	4PS	2PS
Heating	13.7	7.98	7.7	4.08	11.8	7.68	6.13	3.85
Cooling	3.65	1.38	3.28	1.2	2.98	1.15	2.88	1.03
AHU hea	7.06	6.83	3.86	3.72	6.36	6.22	3.47	3.39
AHU coo	1.17	1.17	0.97	0.97	1.17	1.17	0.97	0.97
AHU fan	13.05	13.05	11	11	13.05	13.05	11	11
Pumps	0.03	1.4	0.018	1.2	0.02	1.43	0.015	1.2
Total	38.66	31.8	26.83	22.17	35.38	30.69	24.46	21.44

It is worth mentioning that due to lower temperature differences between room air and water in the active beam, the 2PS requires approximately 4-times more heat transfer area than the 4PS. On the other hand, the 2PS needs only one water pump, fewer pipes and no control valves.

Figs. 13 and 14 illustrate the indoor air temperatures of the five rooms for a typical winter and summer day.

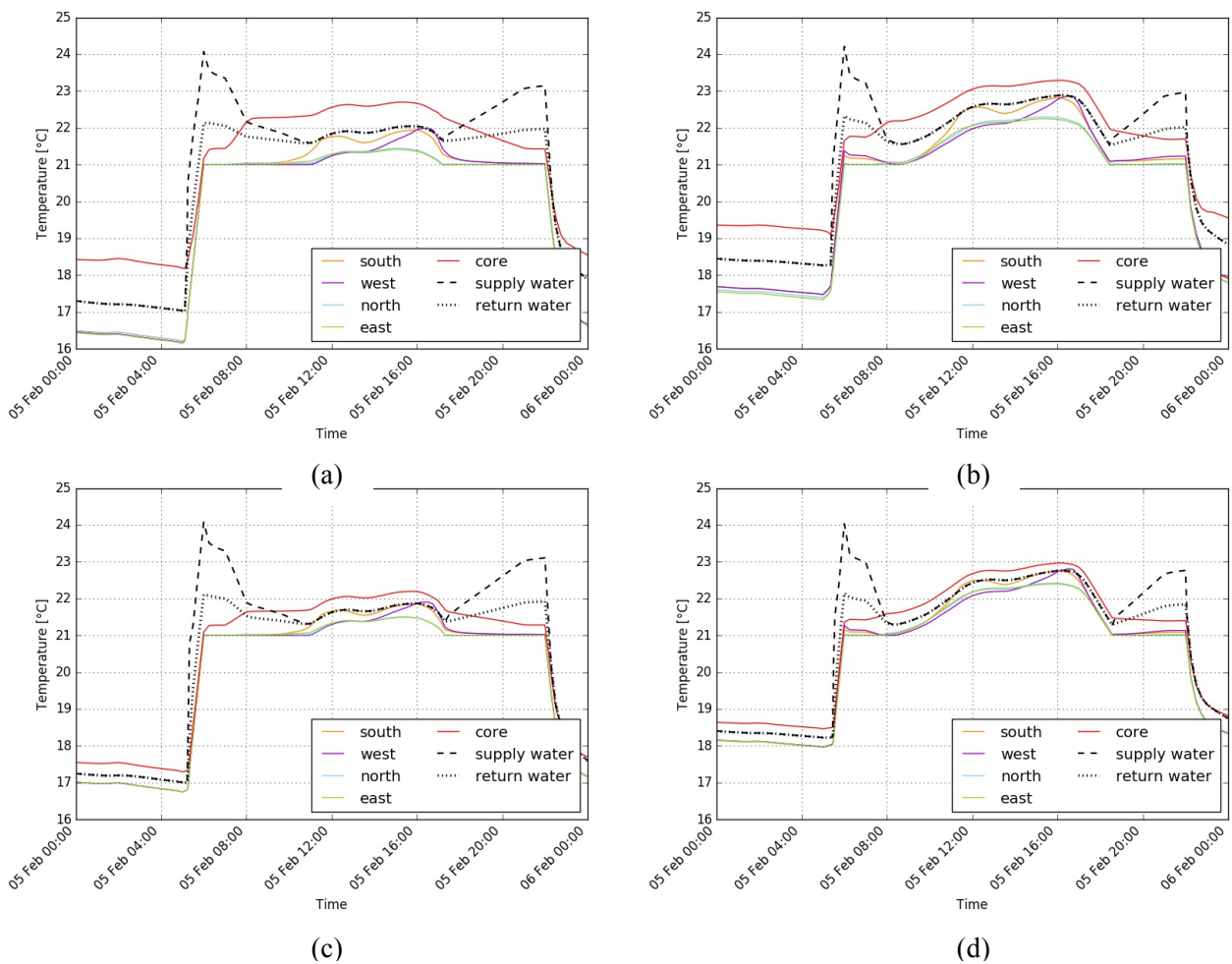

Fig. 13 Indoor air temperatures and supply and return water temperatures for a typical winter day, respectively, for case 1 (a), 2 (b), 3 (c) and 4 (d)

Supply and return water temperatures are also depicted in the graphs. Note that the controller for the supply water temperature set-point was able to maintain the room temperatures within the room temperature set-points. For the winter day, supply and return water temperatures at the central plant, after the return water of the beams is mixed, overlap during almost all of the working hours, leading

to very little energy use. Relative high supply water temperatures were needed in the early morning and evening in order to meet the set-points. This is due to the absence of internal heat gains at the beginning and at the end of the operating hours. As expected, cases with better insulation show higher air temperatures than cases with poor insulation. Due to inter-zone air flows, cases with open doors show air temperatures that are closer together than cases without doors.

For the summer day, the supply water temperature is almost always lower than the return water temperature. This means that no energy savings due to heat transfer among zones occurred in the summer.

It is worth mentioning that the design of the two-pipe system does not allow individual control of the air temperature in the thermal zones. The supply water temperature is adjusted by taking into account only the zone temperature corresponding to the maximum or minimum temperature among all the zones in the building at the current time. However, as shown in Figs. 13 and 14, proper dimensioning and control of the system ensures that air temperatures are always within the set-point values.

Real-life implementation of the two-pipe system is currently under development in an office building in Sweden. This will provide the possibilities for further investigations on energy performance, indoor thermal comfort and cost estimation.

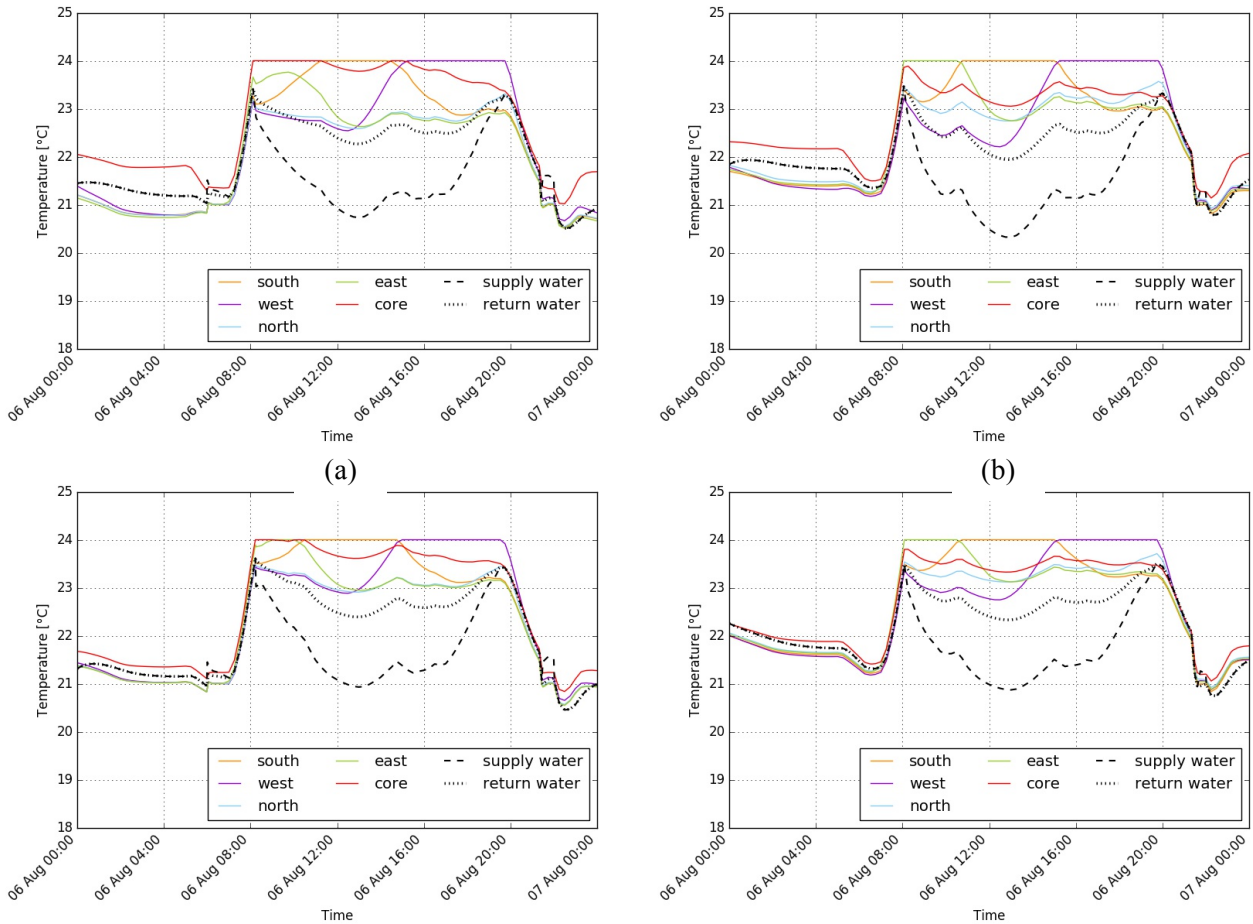

Fig. 14 Indoor air temperatures and supply and return water temperatures for a typical summer day, respectively, for case 1 (a), 2 (b), 3 (c) and 4 (d)

5. Conclusion

Using a room-temperature loop with supply water temperature of about 22°C, together with active beams, enabled the 2PS to meet room temperature set-points even though, simultaneously, some rooms required heating whereas others required cooling. The use of Modelica made it possible to develop a detailed and comprehensive energy and control model of the system. Simulation results showed that the two-pipe system was able to use less energy than the four-pipe system due to three effects: useful heat transfer from warm to cold zones, higher free cooling potential and higher efficiency of the heat pump. The following conclusions can be drawn:

- Due to the room-temperature loop layout, heat was transferred from the core zone to the perimeter zones. When considering only the energy use for space heating and cooling, savings between 4% and 21% occurred depending on the case considered. The presence of inter-zone air flow limited the energy savings of the room-temperature loop.
- Due to the higher supply water temperature in cooling mode, the dry cooler in the two-pipe system was able to remove more heat than the dry cooler in the four-pipe system. In particular, the dry cooler in the two-pipe system removed approximately between 65% and 70% of cooling demand versus approximately between 16% and 33% in the four-pipe system.
- Due to the lower supply water temperature in heating mode, the heat pump in the two-pipe system achieved a value of the HSPF 48% higher than the heat pump in the four-pipe system. This allowed for a significant reduction of primary energy use for space heating.
- When comparing the total annual primary energy use, the two-pipe system used approximately 12% to 18% less total primary energy (including ventilation) per year than the four-pipe system, depending on the case considered.
- The controller for the regulation of the supply water temperature was able to meet heating and cooling set-points in all the five rooms.

References

- [1] International Energy Agency, *Transition to Sustainable Buildings - Strategies and opportunities to 2050*. 2013.
- [2] L. Pérez-Lombard, J. Ortiz, C. Pout, A review on buildings energy consumption information, *Energy Build.* 40 (3) (2008) 394–398.
- [3] D. Schmidt, Benchmarking of low ‘exergy’ buildings, *Int. J. Exergy* 11 (4) (2012) 473.
- [4] A. Hepbasli, Low exergy (LowEx) heating and cooling systems for sustainable buildings and societies, *Renew. Sustain. Energy Rev.* 16 (1) (2012) 73–104.
- [5] F. Meggers, V. Ritter, P. Goffin, M. Baetschmann, H. Leibundgut, Low exergy building systems implementation, *Energy* 41 (1) (2012) 48–55.
- [6] A. Hasan, J. Kurnitski, K. Jokiranta, A combined low temperature water heating system consisting of radiators and floor heating, *Energy Build.* 41 (5) (2009) 470–479.

- [7] A. Hesaraki, E. Bourdakis, A. Ploskic, S. Holmberg, Experimental study of energy performance in low-temperature hydronic heating systems, *Energy Build.* 109(2015) 108–114.
- [8] D. Sakellari, P. Lundqvist, Modelling The Performance Of A Domestic Low- Temperature Heating System Based On A Heat Pump, in: *International Refrigeration and Air Conditioning Conference*, 2002.
- [9] T. Afjei, W. Betschart, R. Bircher, H. P. Geering, S. Ginsburg, W. Hässig, M. Wetter, D. Wittwer, G. Zweifel, Low-cost low-temperature heating with heat pump. Phase 1: Feasibility analysis, problem analysis and preparation for the construction of a function specimen. Research Programme of the Swiss Federal Office of Energy, 1996, in German.
Kostengünstige Niedrigtemperaturheizung mit Wärmepumpe. Phase 1: Machbarkeits- und Problemanalyse. Forschungsprogramm Umgebungs- und Abwärmenutzung, Wärme-Kraft-Kopplung (UAW) des Bundesamt für Energiewirtschaft (BEW). ENET-Nr. 9655701, Bern, 1996.
- [10] T. Afjei, W. Betschart, R. Bircher, G. Doka, H. P. Geering, T. Giger, S. Ginsburg, A. Glass, A. Huber, E. Shafai, M. Wetter, D. Wittwer, G. Zweifel, Low-cost low-temperature heating with heat pump. Phase 2: Measurements of a function specimen, conception of an intelligent controller and ecological and economical comparison with conventional heating systems. Research Programme of the Swiss Federal Office of Energy, 1998, in German.
Kostengünstige Niedrigtemperaturheizung mit Wärmepumpe. Phase 2: Ökologischer und ökonomischer Vergleich des Gesamtsystems, Systemoptimierung, Konzeption einer intelligenten Regelung und Versuche an Testanlagen. Forschungsprogramm Umgebungs- und Abwärmenutzung, Wärme-Kraft-Kopplung (UAW) des Bundesamt für Energiewirtschaft (BEW), 1998.
- [11] M. Bejček, Alternative cooling systems for nearly zero-energy buildings, in: *The 4th Climate Change Technology Conference*, 25–27 May, 2015, Montreal, Canada.
- [12] J. Miriel, L. Serres, a. Trombe, Radiant ceiling panel heating-cooling systems: Experimental and simulated study of the performances, thermal comfort and energy consumptions, *Appl. Therm. Eng.* 22 (16) (2002) 1861–1873.
- [13] K. Zhao, X.-H. Liu, Y. Jiang, Application of radiant floor cooling in a large open space building with high-intensity solar radiation, *Energy Build.* 66(2013) 246–257.
- [14] B. Lehmann, V. Dorer, M. Koschenz, Application range of thermally activated building systems tabs, *Energy Build.* 39 (5) (2007) 593–598.
- [15] B. J. Stein, S. T. Taylor, VAV Reheat Versus Active Chilled Beams & DOAS S, *ASHRAE J.* 55 (5) (2013)

18–32.

- [16] P. Rumsey, J. Weale, Chilled Beams in Labs: Eliminating Reheat & Saving Energy on a Budget, ASHRAE J. 49 (1) (2007) 18–25.
- [17] K. F. Fong, T. T. Chow, C. K. Lee, Z. Lin, L. S. Chan, Solar hybrid cooling system for high-tech offices in subtropical climate – Radiant cooling by absorption refrigeration and desiccant dehumidification, Energy Convers. Manag. 52 (8)–(9) (2011) 2883–2894.
- [18] M. Virta, D. Butler, J. Gräslund, J. Hogeling, E. Kristiansen L., M. Reinikainen, G. Svensson, Chilled Beam Application Guidebook. REHVA, 2004.
- [19] D. Schmidt, Low exergy systems for high-performance buildings and community - Annex 49 summary report, (2011).
- [20] Supply air beam Solus, (2014). Lindab A/S.
<https://itsolution.lindab.com/lindabwebproductsdoc/pdf/documentation/comfort/lindab/technical/solus.pdf>
- [21] Kanton Basel Stadt, Verordnung zum Energiegesetz 72.110, Feb 9, 2010, §21.
<http://www.gesetzessammlung.bs.ch/frontend/versions/2250>.
- [22] J. L. M. Hensen, R. Lamberts, Building Performance Simulation for design and operation. Routledge, 2011.
- [23] A. Afshari, R. G. Norouzi, G. Hultmark, C. Niels, Two-Pipe Chilled Beam System for Both Cooling and Heating of Office Buildings, in: 11th REHVA World Congress and 8th International Conference on Indoor Air Quality, Ventilation and Energy Conservation in Buildings, 16–19 June, 2013, Prague, Czech Republic.
- [24] A. Maccarini, A. Afshari, N. C. Bergsøe, G. Hultmark, M. Jacobsson, A. Vorre, Innovative two-pipe active chilled beam system for simultaneous heating and cooling of office buildings, in: 13th International Conference on Indoor Air Quality and Climate, 7–12 July, 2014, Hong Kong.
- [25] S. E. Mattsson, H. Elmqvist, M. Otter, Physical system modeling with Modelica, Control Eng. Pract. 6 (4) (1998) 501–510.
- [26] M. Wetter, W. Zuo, T. S. Noudui, X. Pang, Modelica Buildings library, J. Build. Perform. Simul. 7 (4) (2014) 253–270.
- [27] B. J. Van Roy, B. Verbruggen, J. Driesen, Ideas for Tomorrow, IEEE Power Energy Mag. 11 (5) (2013) 75–81.

- [28] Institute for Energy Efficient Buildings and Indoor Climate (EBC) at RWTH Aachen University, AixLib, , 2014. [Online]. Available: <https://github.com/RWTH-EBC/AixLib>.
- [29] C. Nytsch-Geusen, J. Huber, M. Ljubijankic, J. Rädler, Modelica BuildingSystems – eine Modellbibliothek zur Simulation komplexer energietechnischer Gebäudesysteme, *Bauphysik* 35 (1) (2013) 21–29.
- [30] M. Deru, K. Field, D. Studer, K. Benne, B. Griffith, P. Torcellini, B. Liu, M. Halverson, D. Winiarski, M. Rosenberg, M. Yazdanian, J. Huang, D. Crawley, U.S. Department of Energy commercial reference building models of the national building stock, (2011).
- [31] B. Thornton, M. Rosenber, E. Richman, W. Wang, Y. Xie, J. Zhang, H. Cho, V. Mendon, R. Athalye, B. Liu, Achieving the 30% Goal: Energy and Cost Savings Analysis of ASHRAE Standard 90.1-2010, (2011).
- [32] M. Wetter, Multizone airflow model in Modelica, , in: 5th International Modelica Conference, 4–5 Sep, 2006, Vienna, Austria.
- [33] A. Maccarini, G. Hultmark, A. Vorre, A. Afshari, N. C. Bergsøe, Modeling of active beam units with Modelica, *Build. Simul.* 8 (5) (2015) 543–550.
- [34] Dansk Standard, DS/EN 15251:2007: Indoor environmental input parameters for design and assessment of energy performance of buildings addressing indoor air quality, thermal environment, lighting and acoustics, , (2007).
- [35] Maroon 2, Swegon <http://www.swegon.com>, .
- [36] K. E. Thomsen, Danish plans towards Nearly Zero Energy Buildings, *REHVA J.* 51 (3) (2014) 6–8.