



Aalborg Universitet

AALBORG UNIVERSITY  
DENMARK

## A review of internet of energy based building energy management systems

### *Issues and recommendations*

Hannan, Mahammad A.; Faisal, Mohammad; Ker, Pin Jern; Mun, Looe Hui; Parvin, Khadija; Mahlia, Teuku Meurah Indra; Blaabjerg, Frede

*Published in:*  
IEEE Access

*DOI (link to publication from Publisher):*  
[10.1109/ACCESS.2018.2852811](https://doi.org/10.1109/ACCESS.2018.2852811)

*Publication date:*  
2018

*Document Version*  
Publisher's PDF, also known as Version of record

[Link to publication from Aalborg University](#)

### *Citation for published version (APA):*

Hannan, M. A., Faisal, M., Ker, P. J., Mun, L. H., Parvin, K., Mahlia, T. M. I., & Blaabjerg, F. (2018). A review of internet of energy based building energy management systems: Issues and recommendations. *IEEE Access*, 6, 38997-39014. Article 8403212. <https://doi.org/10.1109/ACCESS.2018.2852811>

### **General rights**

Copyright and moral rights for the publications made accessible in the public portal are retained by the authors and/or other copyright owners and it is a condition of accessing publications that users recognise and abide by the legal requirements associated with these rights.

- Users may download and print one copy of any publication from the public portal for the purpose of private study or research.
- You may not further distribute the material or use it for any profit-making activity or commercial gain
- You may freely distribute the URL identifying the publication in the public portal -

### **Take down policy**

If you believe that this document breaches copyright please contact us at [vbn@aub.aau.dk](mailto:vbn@aub.aau.dk) providing details, and we will remove access to the work immediately and investigate your claim.

Received May 18, 2018, accepted June 30, 2018, date of publication July 4, 2018, date of current version July 30, 2018.

Digital Object Identifier 10.1109/ACCESS.2018.2852811

# A Review of Internet of Energy Based Building Energy Management Systems: Issues and Recommendations

MAHAMMAD A. HANNAN<sup>1</sup>, (Senior Member, IEEE), MOHAMMAD FAISAL<sup>1</sup>,  
PIN JERN KER<sup>1</sup>, LOE HUI MUN<sup>2</sup>, KHADIJA PARVIN<sup>1</sup>, TEUKU MEURAH INDRA MAHLIA<sup>3,4</sup>,  
AND FREDE BLAABJERG<sup>5</sup>, (Fellow, IEEE)

<sup>1</sup>Department of Electrical Power Engineering, College of Engineering, Universiti Tenaga Nasional, Kajang 43000, Malaysia

<sup>2</sup>TNB Research Sdn. Bhd., Kawasan Institusi Penyelidikan, Kajang 43000, Malaysia

<sup>3</sup>Department of Mechanical Engineering, College of Engineering, Universiti Tenaga Nasional, Kajang 43000, Malaysia

<sup>4</sup>Faculty of Engineering and Information Technology, University of Technology Sydney, NSW 2007, Australia

<sup>5</sup>Department of Energy Technology, Aalborg University, 9220 Aalborg, Denmark

Corresponding author: Mahammad A. Hannan (hannan@uniten.edu.my)

This work was supported by the Universiti Tenaga Nasional Internal Grant (UNIIG 2017) under Grant J510050691.

**ABSTRACT** A building energy management system (BEMS) is a sophisticated method used for monitoring and controlling a building's energy requirements. A number of potential studies were conducted in nearly or net zero energy buildings (nZEBs) for the optimization of building energy consumption through efficient and sustainable ways. Moreover, policy makers are approving measures to improve building energy efficiency in order to foster sustainable energy usages. However, the intelligence of existing BEMSs or nZEBs is inadequate, because of the static set points for heating, cooling, and lighting, the complexity of large amounts of BEMS data, data loss, and network problems. To solve these issues, a BEMS or nZEB solution based on the Internet of energy (IoE) provides disruptive opportunities for revolutionizing sustainable building energy management. This paper presents a critical review of the potential of an IoE-based BEMS for enhancing the performance of future generation building energy utilization. The detailed studies of the IoE architecture, typical nZEB configuration, different generations of nZEB, and smart building energy systems for future BEMS are investigated. The operations, advantages, and limitations of the existing BEMSs or nZEBs are illustrated. A comprehensive review of the different types of IoE-based BEMS technologies, such as energy routers, storage systems and materials, renewable sources, and plug-and-play interfaces, is then presented. The rigorous review indicates that existing BEMSs require advanced controllers integrated with IoE-based technologies for sustainable building energy usage. The main objective of this review is to highlight several issues and challenges of the conventional controllers and IoE applications of BEMSs or nZEBs. Accordingly, the review provides several suggestions for the research and development of the advanced optimized controller and IoE of future BEMSs. All the highlighted insights and recommendations of this review will hopefully lead to increasing efforts toward the development of the future BEMS applications.

**INDEX TERMS** Internet of energy (IoE), building energy management system, nearly or net zero energy building, sustainable energy.

## I. INTRODUCTION

Presently, the concept of energy security has become a significant challenge for sustainable economic development worldwide [1]. According to the International Energy Agency, the global electricity demand is expected to increase by more than two-thirds by the year 2035 [2]. Moreover, scientists agreed that global warming on Earth has become a challenging issue by this time [3]–[5]. “Energy trilemma”

(energy security, environment, and economy) has become a concerning element of the modern world [6]. The increasing demand for electricity considerably leads to power quality degradation and network congestion problems. Moreover, the extensive use of fossil fuel has a severe environmental impact. Therefore, replacing fossil fuel with renewable energy sources has been proposed [7]. Renewable sources are expected to account for 80% of the total energy by the

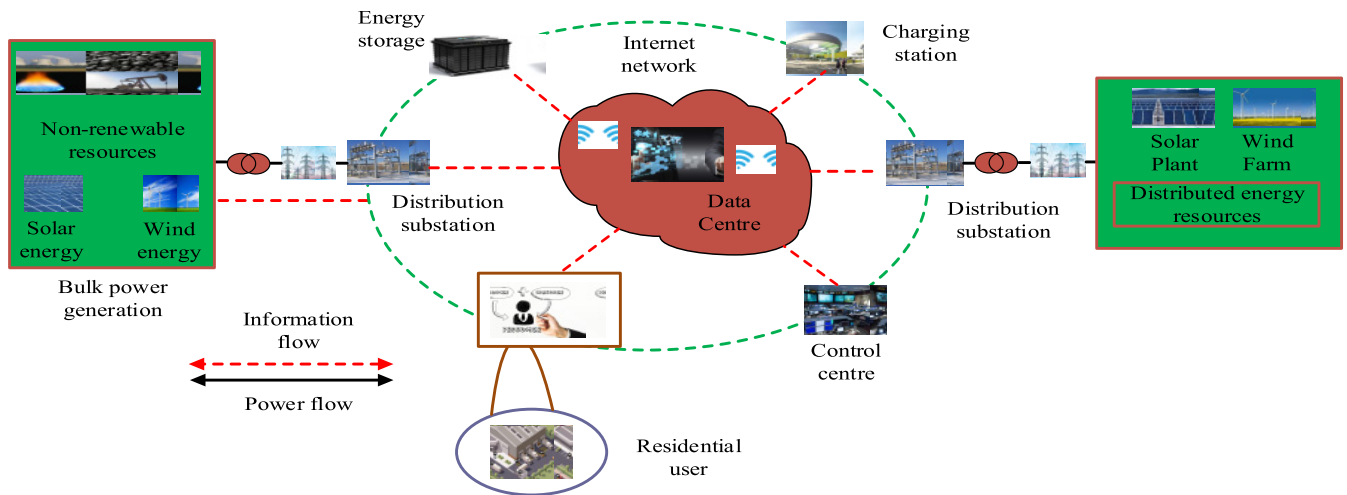

FIGURE 1. Overall architecture of the IoE based EMS [10].

year 2100 [8]. Thus, many researchers have investigated the concept of smart grid, which can supply reliable and secure electricity to consumers [9]. In [10], the authors reported that 22% of the total world demand in 2013 had been mitigated with renewable sources, and this value is expected to increase to approximately 26% by 2020 because of increased awareness energy utilization. However, the integration of renewable sources into utility grids faces the challenge of controlling mechanism with storage facility [11], [12]. Furthermore, the efficient utilization of generated electricity is an essential consideration in the development of the economy. Hence, an Internet-style solution called the Internet of energy (IoE; or energy internet) has been proposed as an extension of the smart grid for the investigation of the bidirectional information and power flow of electricity [13].

IoE combines the features of the smart grid and Internet of things (IoT) [14]. The IoT refers to the Internet-based architecture that facilitates the exchange of services, information, and data among the billions of smart objects. The IoT can be extensively used in different sectors, such as smart grid monitoring, power distribution, telemetric services, military applications, and weather forecasting. By contrast, a smart grid can provide two-way communication between a grid and energy management system and monitors and controls energy-generating units. Therefore, the IoE has been increasingly used in buildings, electric vehicles (EVs), distributed energy sources, and domestic and industrial sectors. The Internet can be used for monitoring and controlling energy networks. Similar to the routing of information on the Internet, energy is transferred from a source to a load when it is needed. A comprehensive architecture of the described IoE technology is depicted in Fig. 1 [10], [15], [16].

The building sector is currently the leading energy-consuming sector [17]–[19]. Therefore, energy management in buildings has become an international aim for modern technology [20]. Research showed that approximately 40%

of the total energy in the world is consumed by buildings, which constituted one-third of greenhouse gas (GHG) emission [21]–[24]. Another research indicated that 49% of the total energy was consumed by buildings in 2014 [1] and 60% of the energy consumption of buildings is due to heating and cooling purposes [19]. Therefore, energy consumption and its effect on climate change are the most challenging issues in the building sector [25]–[28]. Many researchers have investigated building energy management systems (BEMSs) by using the IoE. Thus, maximizing energy efficiency by minimizing losses and environmental impact is the definite goal of sustainable energy development in buildings [29].

The building energy system discussed previously can also be called a zero energy building (ZEB) [30] or net zero energy building (nZEB). ZEB is generally called nZEB because the balance between generation and consumption needs to follow this architecture [31]. ZEB is defined on basis of different parameters, such as energy use, renewable supply facility, connections with utility grid, and requirements [32]. The ZEB is a more attractive concept than other low-energy and passive building structures because it is a probable solution that addresses the previously mentioned challenges [17], [33]. Accordingly, many developed countries are now implementing the ZEB concept for future development [1], [33]–[38]. Holopainen et al. (2016) described the feasibility studies of energy retrofits of typical ZEBs where the crediting system of energy consumption and emission has become a net zero balance between energy import and export, as shown in Fig. 2 [36], [39].

Wells et al. (2018) presented a review on ZEB against different generations of energy efficiencies and demands, such as 1G as green building, 2G as nearly zero energy building (nZEB), 3G as net zero energy building (NZEB), 4G as new generation NZEB, and 5G as future generation of ZEB, as shown in Fig. 3 [40]. The ZEB has equal energy generation and consumption, zero, nearly zero, or net zero

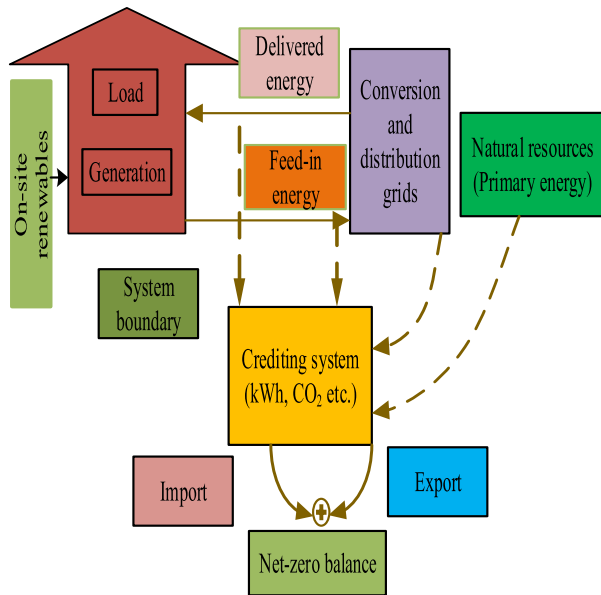

**FIGURE 2.** Schematic of a typical nZEB [39].

GHG emission, and reduced energy demand and cost [41], [42]. Furthermore, data processing and smart metering can provide valuable information on the building energy system [43]. Thus, the IoE, with its robust characteristics of exchanging power between consumers, can significantly drive acceptable energy usage by limiting energy loss, thus leading to sustainable energy development worldwide. Fig. 4 illustrates the energy flow of a typical building where electric chillers, pumps, fans, and appliances consume electricity from a hybrid energy storage system (ESS) consisting of photovoltaic (PV), wind turbing (WT), and biodiesel generator (BDG). Here, the grid acts a reserve power supplier and receiver for the buildings [21].

Accordingly, many studies of BEMS based on real-time data optimization and collection, carbon reduction, and cost-benefit analysis models have been conducted. The details of the features of the BEMS and their methodological framework are explained in Section II. In the past few years, researchers around the world have been investigating the performance of IoE-based BEMSs. However, those techniques are still in the development stage. Accordingly, the focus of this review is to highlight the different applications of IoE and its key technologies, which may contribute to the future development of IoE-based BEMSs. The remainder of this review is organized as follows: Section II describes the features of BEMS. Sections III and IV illustrate the key technologies of IoE-based BEMS and the applications of IoE in BEMS, respectively. Section V highlights the existing issues and challenges of IoE-based BEMS implementation and presents the recommendations for future development of IoE in BEMS.

## II. BUILDING ENERGY MANAGEMENT SYSTEM

A BEMS is a sophisticated technique used for monitoring and controlling the energy consumption of buildings [44].

Poorly managed and improperly controlled equipment may significantly increase the amount of wasted energy in a building energy economy. Obtaining detailed information on the energy consumption of different building equipment is difficult. A conceptual framework has been proposed for BEMSs, as shown in Fig. 5 [45], where weather-responsive control and occupant's influence were considered the key parameters. A building information model (BIM) stores the building geometric information, physical properties, and component information that can be used for the calculation of the lighting intensity and thermal efficiency of a building. The energy efficiency of the building can be measured by creating set points for the reference energy model.

A methodological framework of future BEMSs with various types of energy sources has been proposed for overcoming the issues in management, control, and BIM, as shown in Fig. 6. In this proposed method, energy efficiency and energy savings can be optimized considering the energy consumption and cost-benefit analysis.

In general, a BEMS reduces heating and cooling energy requirements through optimization and integration of passive heating and cooling systems. To do so, BEMS must enhance the energy efficiency of an existing system to reduce GHG emission and save energy [46], [47]. A five-step process was also proposed in [48] for achieving the benefits of energy savings. Several key features have been identified for BEMSs, as follows:

### A. ENERGY CONSUMPTION MANAGEMENT

Energy saving is the main goal of an IoE-based BEMS. The application of IoE-based BEMSs depends on two key techniques, namely, refurbishment of existing buildings and construction of new buildings. Compared with the construction of new buildings, the renovation of existing buildings can save more energy and materials and reduce emissions and wastes. Therefore, the renovation of existing buildings is the preferred method for BEMSs because it deals with climate change mitigation for environmental development [49]. Fig. 7 depicts the direct benefits and co-benefits from a building renovation system [50].

However, this process has some challenges [51]. Some buildings may exhibit physical and moral depreciation, and some buildings may be regarded as architectural heritage and geographical and boundary conditions, depending on the different goals of decision makers [52]. For these shortcomings, a systematic approach assessing the efficacy of various strategies with the demand of stakeholders is essential. An extended multi-attribute decision-making method has been proposed in [53]. In [54], a BEMS architecture in which optimization balances envelope retrofits with renewable and high-efficiency energy supply technology was described through an epsilon-constrained mixed integer linear programming method. This technique was implemented in residential buildings for the evaluation of trade-offs between cost and GHG emission. In [55] and [56], the authors proposed

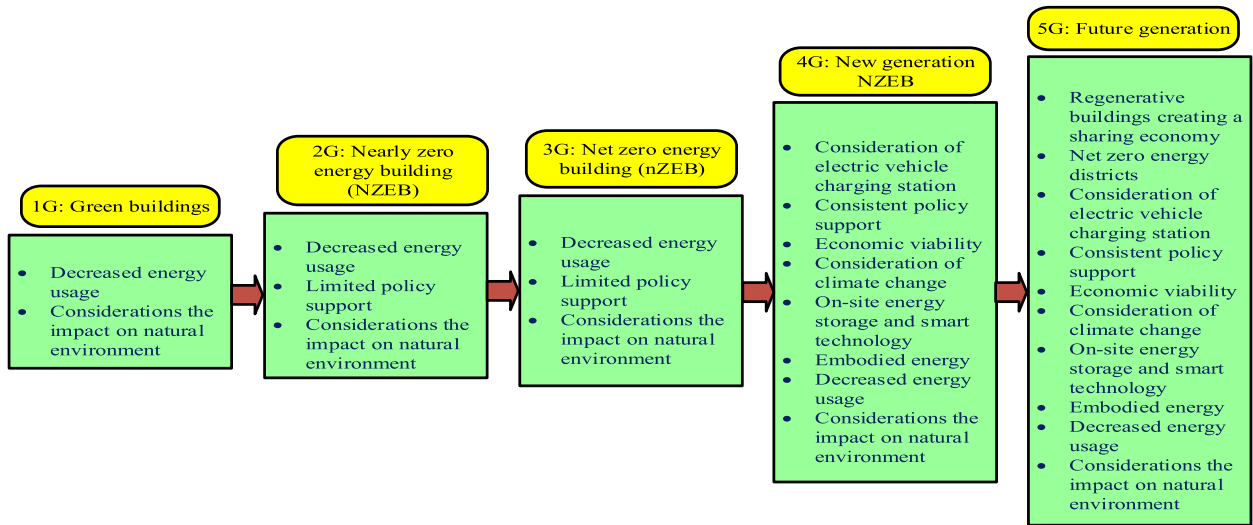

FIGURE 3. Generation of ZEB [40].

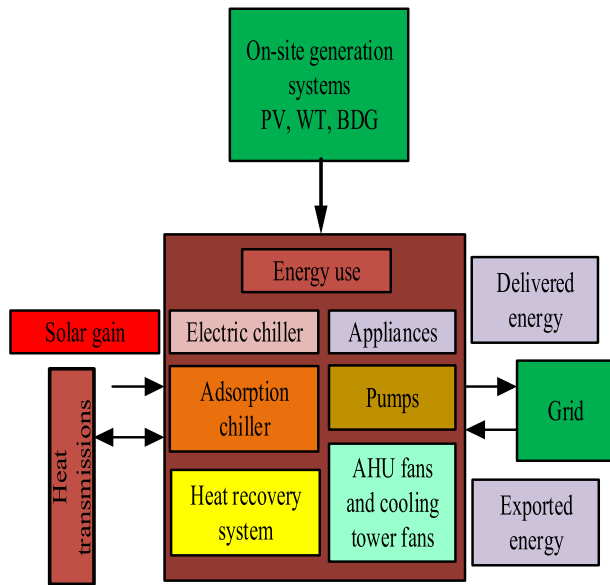

FIGURE 4. Energy flow of a building energy system [21].

that ZigBee can be a good alternative for BEMS. However, the cost is the main barrier to this technology.

According to the report of the European Commission Recommendation (EU) 2016/1318 (July 29, 2016), building energy performance is measured on the basis of primary energy consumption considering building operation [57]. Agdas et al. [58] 2015 analyzed 24 educational buildings considering this criterion. In [59], the authors reported that yearly energy saving has increased from 11.39% to 16.22% with the application of BEMSs. Dashen et al., 2016 proposed a model of future energy management system for smart homes/buildings where various types of control, such as human intention feedforward control, scheduling control, and tariff control, are considered for energy savings (Fig. 8).

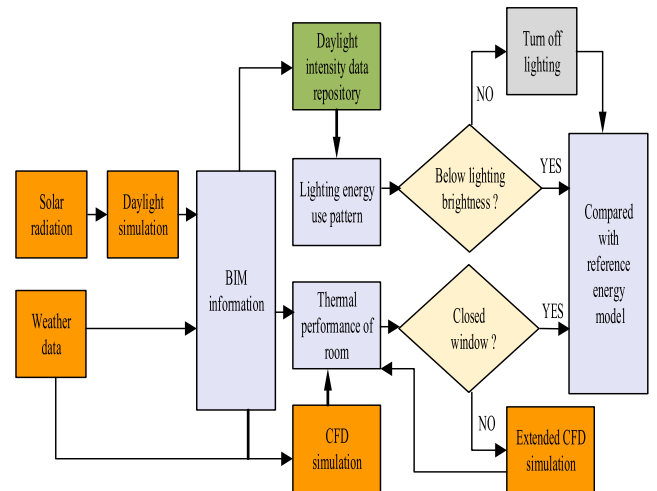

FIGURE 5. Conceptual framework of the smart BEMS [45].

Management functions also have a strong influence on energy savings by reducing the waste.

### B. TRENDING AND BENCHMARKING

Trending determines building performance by analyzing the energy bills and usage. This information can be obtained from energy meters. Therefore, extreme usage can be identified, and the optimum settings can be adjusted according to weather and maintenance data. It can indicate whether an equipment needs to be replaced or upgraded. The cost of energy consumption may be justified using Eq. (1).

$$\left[ \left( \frac{\text{Installed Simple}}{\text{Desired Simple Payback}} \right) \right] + \text{Annual Cost} \\ \text{\% Annual Cost} \\ = \text{Minimum Annual Electric Bill} \quad (1)$$

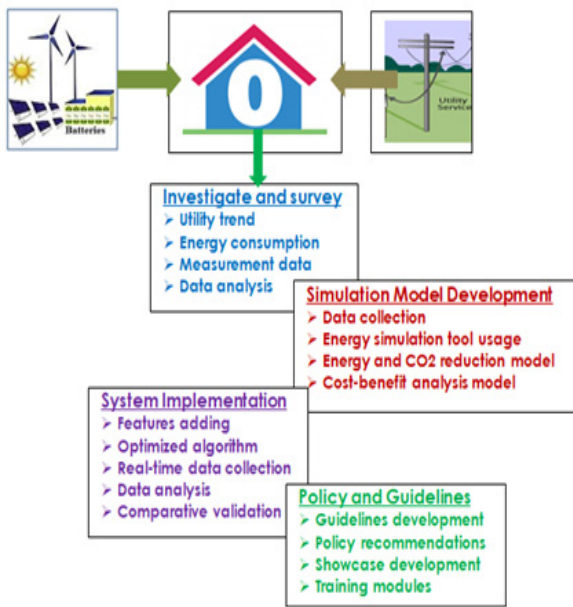

FIGURE 6. Recommended methodological framework of future BEMS.

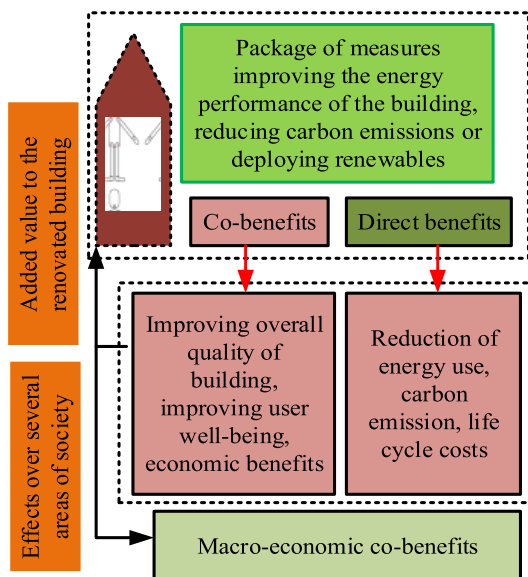

FIGURE 7. Direct benefits and co-benefits from a building renovation system [50].

Here, the desired simple payback is the total number of years it took to produce cost savings equal to the system installation cost [60].

The potential of a building to improve its efficiency on the basis of process, places, and outputs of energy usage can be determined by benchmarking a trend. Successful benchmarking supports a BEMS, depending on the accuracy of the goals, scope, and metrics. However, benchmarking may encounter many challenges because of the increasing data centers [61]. Several key steps and benefits of benchmarking are categorized in Table 1 [62].

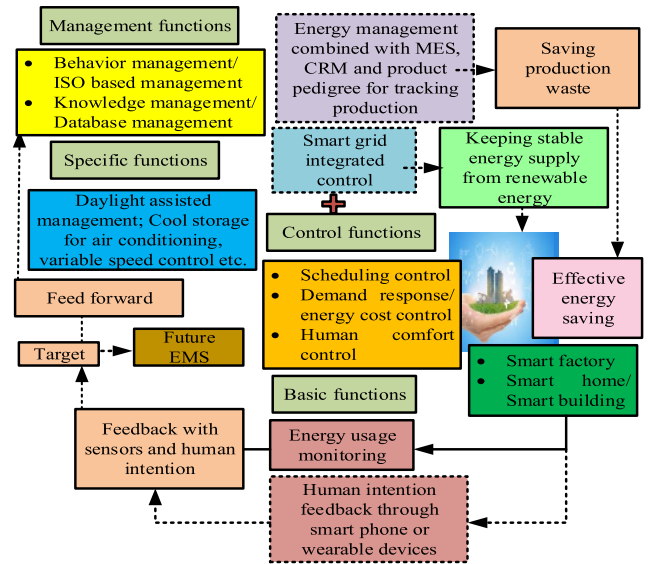

FIGURE 8. EMS strategy for smart homes/buildings and factories [59].

TABLE 1. Benchmarking steps and benefits [62].

Steps	Benefits
Supporting management	<ul style="list-style-type: none"> <li>Initiates continuous improvement in energy performance</li> <li>Ensures the level playing comparison for facilities or buildings</li> </ul>
Assessing performance	<ul style="list-style-type: none"> <li>Determines the energy consumption patterns and key drivers</li> <li>Quantifies the performance of buildings and plants</li> <li>Evaluates the organization's position</li> </ul>
Evaluating the results	<ul style="list-style-type: none"> <li>Provides tools to diagnose problems</li> <li>Identifies the drives for superior performance</li> </ul>

### C. FAULT DETECTION AND DIAGNOSIS

Fault detection and diagnosis (FDD) is an automatic process of sensing and isolating faults in BEMS for the protection of a system from further damage or loss. FDD is challenging but provides opportunities for the system. Several FDD applications of BEMS were developed and investigated on the basis of the relationships among temperature, pressure, and thermodynamics for the detection and diagnosis of faults. For instance, in the mid-1990s, a whole-building diagnostic tool was developed by the US Department of Energy to detect and minimize energy consumption. Subsequently, different scholars focused their research on FDD in BEMS. In [63], a generic application of FDD was investigated, where four steps of FDD were identified, namely, monitoring and detection, fault diagnostic, fault evaluation, and decision-making stage. Fault detection and fault diagnosis comprise the FDD process. Fig. 9 depicts the complete FDD analysis of the application in an engineered system.

Different models, such as the fuzzy model [64], physical model [65], and neural-network-based FDD technique [66],

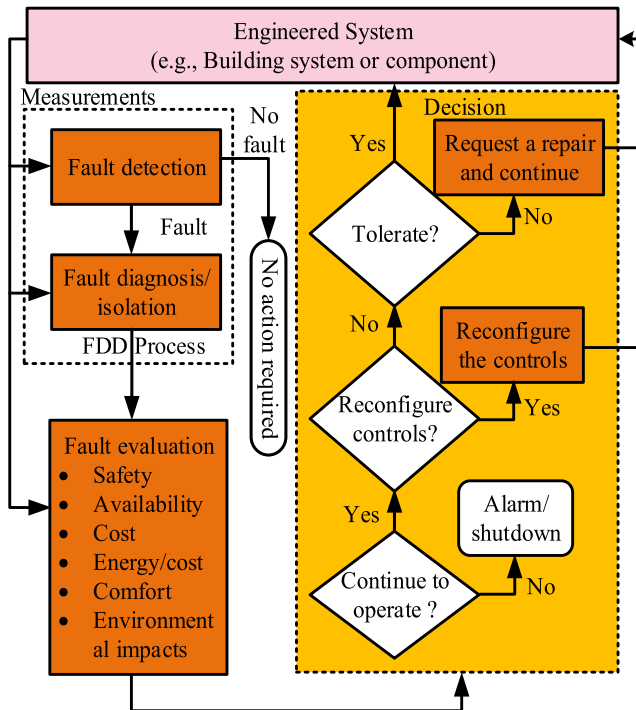

FIGURE 9. Generic application of FDD in an engineered system [63].

have been developed for FDD. Based on the measurement process of faults, FDD methods can be classified as model-based FDD, signal-based FDD, knowledge-based FDD, active FDD, and hybrid FDD. In model-based FDD, the output is constantly monitored and compared with predicted data for fault detection. The model-based FDD is the most accurate method because it depends on the first principles method in physics [67] or it may be completely driven by the Black–Cox model [68]. In signal-based FDD, time and frequency domain techniques are used. Here, if a fault occurs in a system, then the measured output signal of the faulty system differs from the output of the original system. The knowledge-based FDD method uses the artificial intelligence method to evaluate real-time data and extract knowledge from historical data. In active FDD, a test signal is injected for increasing the fault detectability. Meanwhile, the hybrid FDD combines model-driven and data-driven methods. In most existing FDD techniques, sensors used for implementing decisions are selected according to human expertise [69].

However, data management, cost, and scalability are the major limitations of FDD techniques. A statistical analysis of energy consumption by different end users was performed in [70]. Previous studies on FDD methods showed the size, maintenance, and calibration, and heating, ventilation, and air conditioning (HVAC) systems of buildings must be heavily considered when reducing wasted energy [70]–[73].

**D. MEASUREMENT AND VERIFICATION**

The main aim of a building data management system is to identify opportunities for saving energy and evaluate the

energy performance of a building [74]. Measurement and verification (M&V) of data evaluates energy efficiency and considers the energy demand and consumption of various building equipment. Measurement can be accomplished by considering a complete system or a part of a system. An effective M&V plan consists of the following parameters: operating hours, existing controls, light level, site selection, and HVAC effects [75]. In [76], M&V in different countries have been discussed. In China and the United States, the M&V process has been implemented for the past three decades. In India, the adoption of the technique is relatively in the early stage of implementation. The sophistication, robustness, and stringency of energy-efficient M&V vary considerably by region. The International Performance Measurement and Verification Protocol (IPMVP) provides the opportunity for verifying the results of energy efficiency and other renewable projects [77]. Four general approaches with the options of the IPMVP have been identified for the M&V plan in [78]. In Table 2, the options are indicated with the approaches mentioned.

TABLE 2. Approaches of measurement and verification [78].

Approaches	Description
Key parameter measurement (IPMVP option A)	<ul style="list-style-type: none"> <li>• Savings are calculated for an individual measurement</li> <li>• Only key parameters are measured</li> <li>• Several parameters are estimated</li> </ul>
All parameter measurement (IPMVP option B)	<ul style="list-style-type: none"> <li>• Savings are calculated for an individual measurement</li> <li>• All parameters are measured</li> </ul>
Whole-facility or meter approach (IPMVP option C)	<ul style="list-style-type: none"> <li>• Net savings for all measurements are calculated</li> <li>• Regression model is used to create the baseline</li> </ul>
Calibrated simulation approach (IPMVP option D)	<ul style="list-style-type: none"> <li>• Individual and net savings of all parameters are calculated</li> <li>• Building modeling software used to predict the energy usage with or without measures</li> </ul>

**E. MODEL-BASED BEMS CONTROL**

When the control parameter of the building system is expressed mathematically and incorporated into BEMS, it is called a model-based BEMS control system. Existing control strategy, such as on–off control, PID control, and rule-based control, have some limitations of adjustment or flexibility. In the 1990s, digital control devices were introduced for control. However, no standard is set for digital communication. Therefore, advanced control strategies, such as intelligent control and advanced fuzzy logic controller, have been introduced [79]. A model predictive control (MPC) approach for BEMS is discussed in this review, where three aspects of MPC, namely, problem formulation, control architecture, and implementation type are identified. At different weather conditions, the MPC showed better performance than other

conventional control strategies. Moreover, a BEMS containing structured multi-MPC layers and considering the advanced interface between building and grid was introduced (Fig. 10). This approach is a structuring approach for building control and can integrate the global network challenges for energy consumption.

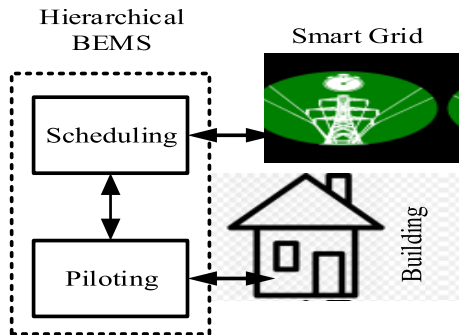

FIGURE 10. Hierarchical BEMS scheme [79].

BEMS installation depends on the sensing of variables, such as temperature and flow rate [80]. Therefore, an estimation of overall energy performance can be predicted on the basis of energy consumption. A global model-based BEMS was investigated in [81], which can help in making decisions regarding day-ahead best CANOPEA building configurations. In [82], a model-based HVAC control system with a mathematical programming and optimal algorithm was discussed. The energy consumption of HVAC systems varies based on the weather condition. If the temperature is hot and humid, then the HVAC system consumes more energy. By contrast, if the weather condition is comfortable, then the HVAC system consumes less energy. Therefore, the optimum operation in terms of energy savings is calculated by adjusting the operational set points.

### F. CONSTRUCTION OPERATION BUILDING INFORMATION EXCHANGE

Construction operation building information exchange (COBie) may be defined as the specific set of building information that can be delivered to owners or operators in a standard manner [83]. Therefore, this system develops a building information transformation model by BIM, building information management, and facilities information management. This system saves time, solves the data interoperability problem, and ensures the quality by automatic checking, searching, reformatting, and recreating of data against product specification [84]. Fig. 11 shows a schematic model of building design and operation. In the design stage, the required materials, products, and equipment are specified.

Standard formats of COBie depends on the demand of the client. COBie eliminates paper-based communication, thus reducing the operating costs [85]. The data can be arranged in .xlsx, .ifc, or .xml formats. All BIM software may not support

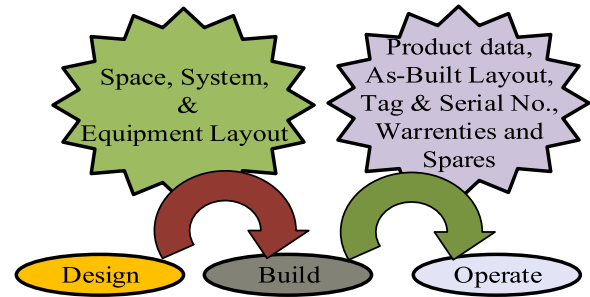

FIGURE 11. Schematic model of building design and operation [85].

the COBie. Therefore, attention needs to be addressed when the software is installed for BEMS.

### III. KEY TECHNOLOGY OF THE INTERNET OF ENERGY

The IoE has some similarities and differences between the features of the Internet and IoE. The similarities can be categorized into two sectors, namely, structural and functional similarities. Structural similarity depicts that the Internet and IoE comprise three parts, namely, generation, transmission, and distribution. Similar to the Internet, the IoE has many control nodes and a router that can be used for various degrees of control. These similarities are called the functional similarities of the Internet and IoE [86]. In case of the Internet, the point-to-point flow of information between two nodes can be possible. Moreover, information is constantly created, replicated, and stored here. However, the IoE cannot replicate energy. Therefore, supplied energy needs to be balanced by the demand. A commonly secured solution can be applied in the case of the Internet. Meanwhile, various types of securities are needed in the IoE because network-based or security-based solution is difficult to adopt here. Table 3 shows a comprehensive review of the key technologies for IoE [10]. The details of the technologies are presented in the following subsections.

#### A. ENERGY ROUTER

The energy router is an essential element of the IoE [87]. The energy router consists of a solid-state transformer, a distributed grid intelligent control system, and a communication unit. The router can receive, process, and transmit the information of the grid. The router is capable of increasing the system reliability, efficiency, and security of the power network, and thus, can optimize the energy usage by balancing the supply and demand. If the supply of energy exceeds the demand, then the energy router transfers the surplus energy to the utility grid [89].

#### B. STORAGE SYSTEM AND MATERIALS

The ESS in the IoE can significantly improve grid efficiency, stability, and reliability. The detailed application of the ESS has been investigated in [90]–[92]. A storage device can reduce the stress of a grid and store energy for later use, thus ensuring the smooth supply of electricity [93].



**TABLE 3.** Key technologies for the IoE [10].

Technologies	Features	Functions	Advantages	Concerning issues
Energy router	Solid-state transformer, grid control, and communication tools	Data management with the grid	Increase the system reliability, efficiency, and security Optimize the energy use	Data security, transmission, and receiving process
Storage system	Different types, such as fuel cell and battery	Store energy for future use	Improve grid efficiency, stability, and reliability Reduce the stress of the grid	Cost, temperature, and discharge power
Renewable sources	Solar and wind	Generate power	Improve power stability Reduce GHG emission	Intermittent nature and power quality
PE converter	DC/AC or others	Convert the power in the required form	Control the harmonic injection at the point of common coupling	Reduce the harmonics and affect the power quality
Plug-and-play interfacing		Facilitates RES connection and storage with a computer	No physical device is required Recognize immediately when the energy storage or energy-generating device is connected	Reliability and security
Home appliance	Refrigerator, vacuum cleaners, television, and cooker	Balancing the demand and supply for the efficient operation of the IoE		Connecting with the Internet
Heating-cooling balanced [88] Construction quality	Comfortability		Helps in developing the nZEB Thermal comfort Comfortable and climate sensitive, which will be helpful in attaining an efficient IoE-based BEMS	Weather of the area High-tech specified components, climate, shape, orientation, and shading

The ESS can improve power quality [94] and solve the problem of voltage fluctuation [95]. Commonly used storage devices are batteries, supercapacitors, fuel cell, flywheel, compressed air, and pumped hydro.

Thermal storage systems (TSS) provide an efficient and environment-friendly storage with reduced energy consumption and GHG emission [96]. In [19], the application and advances in TSS (along with their materials) toward ZEB have been illustrated. According to this study, a sensible heat storage system is a widely used method for building structures. Its material can be solid or liquid [97]. A sensible heat storage system stores and releases heat according to temperature increase or decrease characteristics. A latent heat storage system can store a large amount of heat in a short temperature range around the phase change temperature. Here, phase change materials may be classified into three categories, namely, organic compounds, inorganic compounds, and eutectic mixtures [98], [99]. However, phase change materials require specific climate conditions for improving the efficiency of BEMS. A thermochemical heat storage system has a high energy density with negligible heat loss [100]. Thermochemical storage materials (TSMs) can be classified into physical adsorption, liquid adsorption, or chemical reaction [101], [102]. However, the main barriers of TSMs in building applications are their high cost and inappropriate operating temperature and discharge power. Therefore, advanced research on ESS with efficient materials for building applications along with the intermittent nature of renewable sources, such as solar and wind, is the most applicable effort in this context [103].

### C. RENEWABLE SOURCES

As mentioned previously, for sustainable development, safety, and environment, the IoE consists of various interconnected renewable sources, such as solar and wind. Renewable technologies with ESS systems have become the widely accepted solutions to achieve this stable and reliable green environment [7], [104]–[106]. In [21], the performance of each of the four hybrid energy systems (HES) for nZEB was evaluated with regard to the cost, CO<sub>2</sub> emission, and grid interaction index. The Monte Carlo simulation technique and exhaustive search method were employed to select the optimal HES. The integration of renewable technologies requires power converter topologies and control technique. However, power electronic converters have nonlinear characteristics and inject the harmonic component at the point of common coupling. Therefore, an advanced research might overcome the challenges of reducing the harmonics, and thus, improve the power quality of the system.

### D. PLUG-AND-PLAY AND APPLIANCE INTEGRATION

The plug-and-play interface of the IoE facilitates the connection of renewable sources and storage devices. The plug-and-play interface may have different interfacing techniques (AC/DC) given that either AC or DC microgrid (MG) can connect through its interface. The integration of home appliance or any other load is also important as the demand and supply need to be balanced for the efficient operation of the IoE. However, the environmental impact of different appliances, such as refrigerators [107], [108], vacuum cleaners [109], televisions [110], and cooker hoods [111], has been

presented in the corresponding research. Hence, advanced studies on using home appliances can reduce the demand for electricity and GHG emission.

#### IV. APPLICATION OF THE INTERNET OF ENERGY

Different researchers have described numerous applications of the IoE, as shown in Fig. 12. In [112], IoE implementation in the smart grid communication sector has been illustrated. Here, the energy management center works to assess the operating status of renewable sources. An H-infinity-based dynamic estimation method was used in this application. Fig. 13 illustrates the potential architecture of the IoE communication network by which the physical objects may be sensed, monitored, and controlled at anytime from anyplace. The figure shows that smart devices are connected through the Internet network. The control center collects the measured data from the various sources and transmits them through this network. In [113], an IoE-based smart sensor network for the smart grid has been described. Smart sensor networks have the advantages of low cost and easy access, thus having the opportunity for large-scale implementation in the smart grid. Another research in 2013 focused on the mobile smart services over the IoE [114]. The main objective of this study was to assist in the operation of EVs [115]. The detailed application of the IoE in BEMS is explained in the following subsections.

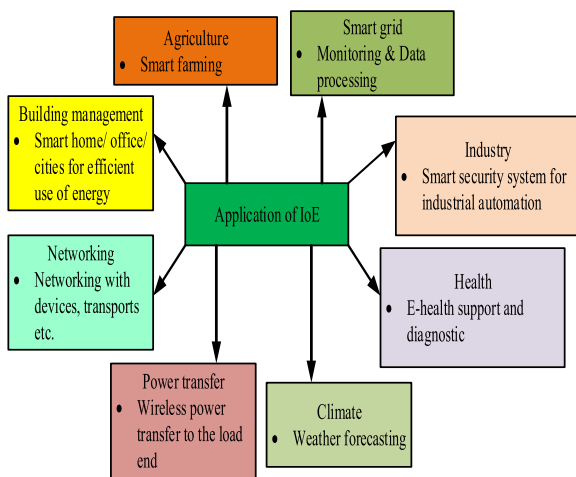

FIGURE 12. Application of the IoE.

#### A. APPLICATIONS OF THE INTERNET OF ENERGY IN BEMS

IoE-based BEMS helps in reducing the building energy consumption by exchanging the information of energy demand and supply, thus helping in CO<sub>2</sub> reduction for sustainable intelligent buildings [116]. Fig. 14 depicts the application of BEMS in nZEB previously presented in [117]. Another research [118] also identified the ZEBs as a solution to ensure energy-efficient energy consumption. Different approaches toward ZEBs by 10 OECD countries were analyzed in [119], and the basic design principle was described in detail in [120]. Then, a nZEB school was analyzed in the

Netherlands in 2013 [38]. The design of this kind of building is different from conventional buildings [121]. This research proposed that the current design practice of nZEB schools needs to be changed compared with ordinary buildings. Fig. 15 depicts the graphical representation of the nZEB, where the reference building represents the performance of a new building. The nZEB can be determined from the balance between load and generation, between exported and delivered energy, or between monthly net values of load and generation. The nZEB can be expressed as follows:

$$nZEB = |\text{weighted supply}| - |\text{weighted demand}| = 0. \quad (2)$$

An optimization model for making decisions regarding BEMS was presented in [122]. This model can successfully reflect the energy flow of the building. However, this model has some inherent uncertainties (such as cost, price, and demand), which may affect the building energy performance. A case study of ZEB has been conducted in China [35]. Energy savings, cost, and ecological analysis were the key issues in this study. Nondominated sorting genetic algorithm II has been proposed as a preferred algorithm for cost and energy optimization. Moreover, the combined gray correlation multilevel comprehensive evaluation method was applied to optimize the efficiency, economy, and energy conservation of renewable sources. Several researchers [123] also investigated the optimization technique for ZEBs.

However, Russian researchers started to develop the concept of ZEB with nearly zero energy consumption of passive houses [124]. In 2016, the feasibility of nZEB renovation was examined based on the technical, environmental, economic, and social points of view. This study proved the advantages of nZEB over the traditional renovation technique in the target countries by saving fossil fuel, and thus, reducing GHG emission [36]. Moreover, a feasibility study of a restaurant (McDonald's) in Chicago, IL, USA has been conducted using the leadership in energy and environmental design prototype. The feasibility study showed that 21% of energy load can be reduced with the most significant energy savings [125].

In [126] and [127], PCMs have been proposed for the development of an efficient BEMS. Life cycle energy analysis (LCEA) is a technique used to estimate the energy flow through the life cycle of a building [128], [129]. Materials are the main components for determining the life cycle. However, the boundaries of LCEA are still not clearly identified [130]. Fig. 16 illustrates the inputs and outputs of LCEA, where embodied energy and operational energy provides the total energy intensity of the system [131].

Energy consumption in a building decreases through the course of its life cycle. Therefore, a significant share of functional energy can be justified from the influence of the recycling potential [132] and materials of a building [133]. In Europe, several projects, such as Smart Energy Efficient Middleware for Public Spaces (SEEMPubS), District Information Modeling and Management for Energy Reduction, and A Novel Architecture for Modeling, Virtualizing and

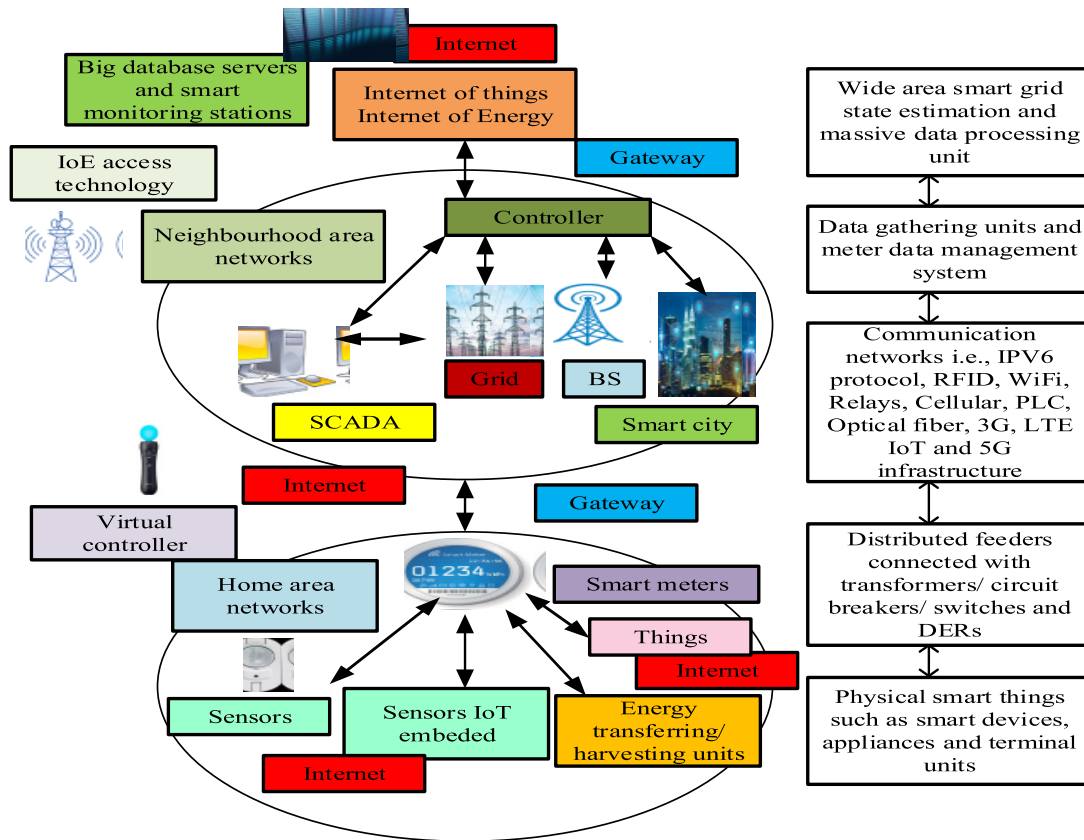

FIGURE 13. The potential architecture of the IoE communication network [112].

Managing the Energy Consumption of Household Appliances, have been introduced for IoE-based BEMS. In the SEEMpubS system, a new computer-based energy management and control system, which can be applied to various historical buildings, was used [134]. The HVAC system uses software and hardware technologies to ensure a safe environment (temperature, humidity, and CO<sub>2</sub>) and the comfort of its inhabitants [135]. Natural ventilation systems for near zero energy school buildings were designed in [136]. This research proved that 18% to 33% of energy could be saved in this process, keeping the classroom comfortable. In Italy, an office building was selected for achieving BEMS with GHG reduction. The study indicated that 40% of GHG emission was reduced by the proposed HVAC system and improved thermal insulation envelope [137].

In [138], manual and automatic modes of BEMS were described. Both methods comprise three options, namely, high, medium, and low priority. This model showed the appropriate response in a building with Wi-Fi coverage regarding cost, reliability, and efficiency. This model also responds rapidly to recover load shedding in the case of renewable energy sources [139]. In Hong Kong, research on school buildings conducted with the building energy package QUEST indicated that a zero energy school building is achievable in the worst climate condition through the

intelligent use of appliances [34]. The energy saving method of a university building in Greece was examined in [24]. In this study, the contribution of passive heating and cooling systems were considered in transforming the university building into a ZEB.

### V. ISSUES AND CHALLENGES

The main aim of the IoE-based BEMS is to reduce energy consumption by balancing the demand and supply and reduce the significant amount of GHG emission to develop a sustainable environment. Therefore, the balance between retrofit and building system depends on reliable strategic decisions. However, climate change may significantly influence the efficiency of BEMS [140]. In [141], several key issues that affect the BEMS has been observed. According to this study, 34% of global residential heating demand would decrease and 72% of cooling demand would increase by 2100. In [88], the authors proposed that an active heating and cooling system needs to be incorporated based on the weather conditions. Therefore, the IoE-based BEMS has become a significant issue in the modern society [122]. An efficient BEMS needs to be reliable, secure, scalable, and cost-effective [142]–[144]. Some identified key issues and challenges of IoE-based BEMS are discussed in the following subsections.

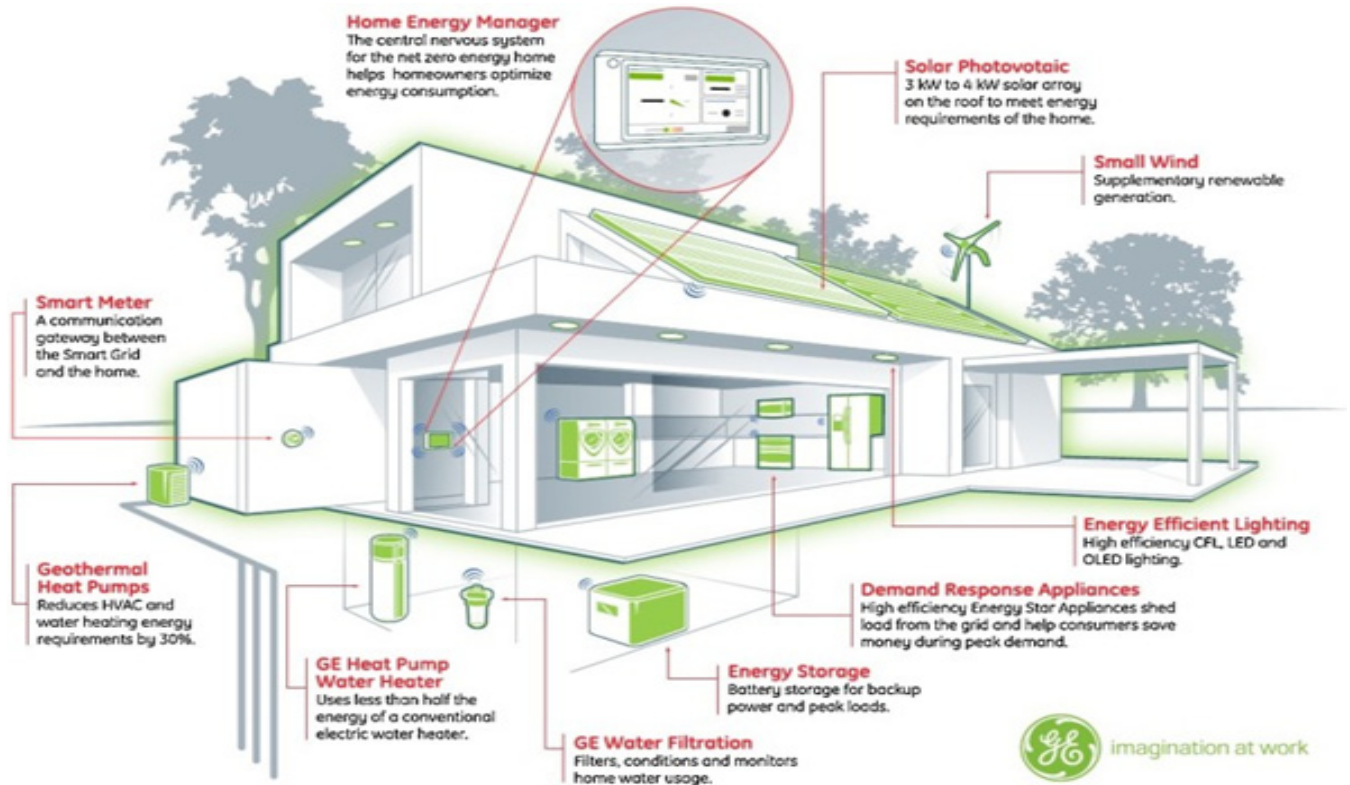

FIGURE 14. Application of BEMS in nZEB [117].

**A. RELIABILITY**

A reliable IoE-based BEMS can attract the consumer’s attention, and thus, can ensure the achievement of the sustainable development goal. Inaccurate information and incorrect decision in IoE-based BEMS may lead to increased confusion and irrecoverable damages. Moreover, the energy production level varies depending on the weather condition, and the existing power network system suffers from unreliability because of the lack of an efficient monitoring, fault diagnosis, and maintenance system [113]. However, the power supply to the consumer needs to be stable and reliable with acceptable power quality. An efficient ESS with renewable sources can supply uninterrupted power to the load by balancing power with the grid and keeping the power quality unchanged [145]. Therefore, material selection of the ESS and intelligent power infrastructure along with the monitoring and control system for the IoE architecture can expedite the development of an efficient BEMS.

**B. SECURITY FOR DATA ACCESS IN IOE-BASED BEMS**

Data collection and analysis is a fundamental part of the BEMS. In this stage, various types of data, such as maintenance or replacement schedules of the equipment, human resources, meter data, billing information, and costs of the energy consumption of different building equipment, are collected at a regular interval. These data can then be used to identify the energy-efficient building management system, such as lighting, heating, and cooling.

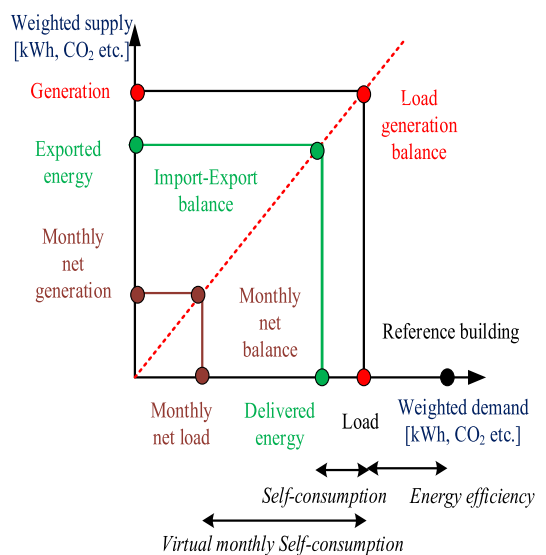

FIGURE 15. Graphical representation of nZEB [42].

Presently, an advanced data management system has been introduced, where sensors, submeters, and smart meters are incorporated to assess the building performance. Hence, equipment selection, circuit identification, equipment placement, data verification, and metering equipment removal are responsible for the effective metering system.

No standard common security for IoE-based (both wired and wireless network systems) BEMS exists [146]. In this

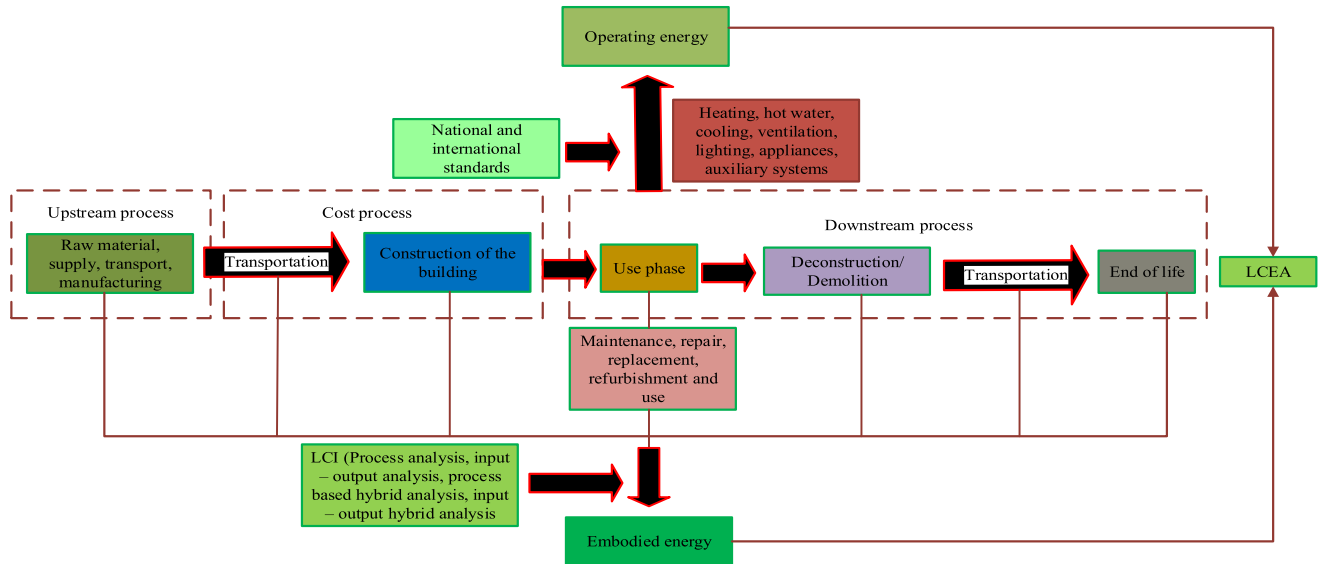

FIGURE 16. Inputs and outputs of LCEA [131].

type of technology, high-level security needs to be ensured as this system stores a large amount of information and employs numerous keys and passwords [147]. According to [148]–[150], authentication, integrity, privacy, consistent and uncorrupted data tracking and recording, and collection and exchange without missing data are the security requirements for this type of application. Moreover, using the Internet with a smart grid or MG can increase the occurrence of a cyber attack, which is a significant threat to national security [151]. This technology requires the storage of a large amount of data, which may be processed later for efficient management of the system. Software and smart devices (sensor nodes) can be designed for artificial control [137] and monitoring of BEMS functions, such as switching on/off the air conditioners, dishwashers, television, lights, fans, and PCs and alarming the operators (interaction between human and devices), to attain an efficient building data management system. Therefore, advance research on security, privacy, and cloud computing [152]–[154] for IoE-based BEMS can be the good choice for saving money and improving the quality of life of consumers [155].

### C. SCALABILITY

Scalability represents the system stability when new devices, services, or applications are added to the existing system [156]. The power quality of the system must be ensured in this situation. A nonscalable system means it cannot be expanded in the future, which is not expected from the consumer point of view. As consumers want to obtain new services every time, the IoE-based BEMS needs to be scalable for future improvement.

### D. COST

The costs of IoE-based BEMS includes the energy costs, operating costs, costs of the materials of ESS, costs of

smart appliances, building construction or renovation costs, technological costs, and maintenance costs. Previous studies of the integration of renewable sources indicated that the costs of the integration of solar energy vary from medium to high [157]–[161], whereas the integration of wind [162]–[164] and geothermal [165] energy is still high. Hence, the cost of these technologies has a strong effect on IoE-based BEMS. Moreover, the low cost of materials of ESS for storing the energy of renewable sources to ensure their availability can be a good alternative for this system [19]. Therefore, a suitable balance between the costs of IoE-based BEMS and GHG emission needs to be maintained to ensure an efficient BEMS [18]. Different researchers conducted optimal cost analysis of nZEB [166]–[169]. If the costs become too high, then it will lead to the negative attitude of the prosumers. Public education and advanced research concerning the environmental factors might change the trend in this regard [170]. Therefore, achieving a cost-effective and sustainable IoE-based BEMS with the integration of renewable sources is a significant challenge for further development of this technology [171].

### E. WEATHER

Climate and geographical location are the most sensitive issues in an IoE-based building management system [172]. Heating and cooling [88], ventilation, telecommunications, Internet supply, thermal comfortability, and GHG emission are significantly influenced by climate change. If the temperature varies, then the energy consumption based on the load will also vary; therefore, weather is an important determinant for designing an efficient BEMS [25]. Signal interference mostly depends on the environmental condition of the building. Wireless devices may not work efficiently in harsh environments. Moreover, solar radiation and wind velocity vary rapidly, which may be the essential parts of the power supply

of this management system. This technology is also significantly affected by the weather situation. Storage devices can mitigate the challenge of uninterrupted power supply. Therefore, a power-efficient and climate-sensitive BEMS is still a significant challenge for future development.

## VI. CONCLUSION AND RECOMMENDATIONS

A BEMS that focuses on various IoE technologies and their applications for the reduction of building energy consumption and GHG emission and minimization of existing issues is critically highlighted in this review paper. The review forecasted that energy security and utilization have become important issues in sustainable economic development. However, maximizing energy efficiency by minimizing losses, energy consumption, and its effect on climate change are the most challenging issues in BEMS. For these issues, the IoE concept is investigated such that a building's energy utilization is monitored and controlled through bidirectional communication between the smart grid and BEMS. Accordingly, the types of nearly or net zero energy buildings have been investigated on the basis of different parameters, such as energy use and retrofit, renewable supply facility, connections with the utility grid, and requirements. Different generations of energy efficiencies and demands have been investigated, in which the IoE, with its robust characteristics of exchanging power with an acceptable energy usage by limiting energy loss, enables sustainable energy development. However, some challenges, such as building depreciation, architectural heritage, geographical and boundary conditions, real-time data optimization and collection, carbon reduction, and cost–benefit analysis models, need to be addressed. Based on literature survey, this review highlights the different applications of IoE-based BEMS with its key technologies to contribute to future advanced BEMS implementation. Accordingly, the authors recommended an improved methodological framework of future BEMS strategies. This review also investigates the key technologies of IoE-based BEMS, which are characterized by different elements, such as energy routers, energy storage devices, renewable sources interconnection, and plug-and-play interfacing and integration. However, building energy efficiency and optimization, specific climate conditions, energy storage materials, nonlinear electronic interface, and power quality are significant issues in implementing the available IoE-based BEMS technologies. IoE-based BEMS are applied for ZEB, nZEB, and mobile smart services using advanced algorithms to reduce building energy consumption and CO<sub>2</sub> reduction by exchanging the information of energy demand and supply for sustainable intelligent buildings. This study also indicates that a significant amount of energy savings and GHG emission reduction could be achieved using IoE-based BEMS. This review highlights some issues in ensuring the sustainability of future BEMS in ensuring energy efficiency and security and solving economic and environmental problems, as follows:

- The reliability of ESS features, RES integration, and intelligent power infrastructure along with the optimal

control and monitoring system for the IoE architecture can expedite the sustainable development of efficient BEMS.

- Missing data values, corrupted values, and inconsistencies can complicate the process of energy management, including security and privacy. Therefore, an advanced platform for security assessment and handling, collection, and processing of a large amount of data would ensure an efficient building data management system.
- The IoE-based BEMS needs to be a scalable, stable, and localized system for future improvement in building energy utilization.
- In general, users prefer to shift loads from high-price to low-price hours. However, uncoordinated shifts add to its volatility. Thus, the cost-effective and efficient IoE-based BEMS with the integration of RES has considerable potential for further development of this technology.
- Building energy technologies are significantly affected by the weather situation. The stochasticity of RES due to changes in cloud cover and wind speed increases the unpredictability of the load imposed on the electric grid, complicating the scheduling of power generation. Accordingly, an energy-efficient and climate-sensitive BEMS would be a significant challenge for future development.

Thus, in this review, the ultimate challenges and issues in the development of IoE-based BEMS technologies that will lead the future research and development toward advanced BEMS in building applications are highlighted.

The main contribution of this study is the comprehensive analysis of the IoE-based BEMS for sustainable energy buildings. The findings provide a concrete idea for researchers and manufacturers on existing BEMS technologies and their advancement for future development of IoE-based BEMS. This review also raises several significant and selective points to be observed for further development of the IoE-based BEMS, as follows:

- Energy supply and demand mechanism;
- ESS aids in smoothening out cyclical and stochastic power flows;
- Weather forecasting;
- Costs of materials and construction for building;
- GHG emission;
- Integrity of cabling and connections;
- Inputs and controlled device operate correctly;
- Supplies are adequate or not;
- Data management efficiency;
- Optimization of building performance to maintain the record of all changes;
- Size, cost, shape, and complexity of BEMS;
- Emergency alarming system;
- Energy savings.

The highlighted IoE technologies and its applications, issues, and challenges would lead researchers and builders to deliberate the possibilities of the modification, improvement,

and innovation in IoE-based BEMS development, to facilitate technologies for overcoming challenges, and to ensure advancement toward sustainable BEMS development. Therefore, we can conclude that these highlighted issues and suggestions would have remarkable contributions toward the maturity of IoE-based BEMS to dominate building sustainable energy efficiency in the future.

## REFERENCES

- [1] F. Harkouss, F. Fardoun, and P. H. Biwole, "Multi-objective optimization methodology for net zero energy buildings," *J. Building Eng.*, vol. 16, pp. 57–71, Mar. 2018.
- [2] *World Energy Outlook 2013 Factsheet How Will Global Energy Markets Evolve to 2035? World Energy Outlook 2013 Factsheet*, IEA, Paris, France, 2013, p. 5.
- [3] A. S. Fidirikova, O. S. Grishina, A. P. Marichev, and X. M. Rakova, "Energy-efficient technologies in the construction of school in hot climates," *Appl. Mech. Mater.*, vols. 587–589, pp. 287–293, Jun. 2014.
- [4] Z. A. Gayevskaya and X. M. Rakova, "Modern building materials and the concept of 'sustainability project,'" *Adv. Mater. Res.*, vols. 941–944, pp. 825–830, Jun. 2014.
- [5] N. S. Bolshakov, S. A. Krivoy, and X. M. Rakova, "The 'comfort in all respects' principle implementation by the example of an elementary school," *Adv. Mater. Res.*, vols. 941–944, pp. 895–900, Jun. 2014.
- [6] *World Energy Trilemma: Time to Get Real—the Case for Sustainable Energy Policy*. World Energy Council, London, U.K., 2012.
- [7] J. G. J. Olivier, G. Janssens-Maenhout, M. Muntean, and J. A. H. W. Peters, "Trends in global CO<sub>2</sub> emissions: 2016 report," PBL Netherlands Environmental Assessment Agency, The Netherlands, Tech. Rep., 2016, p. 86.
- [8] A. Al-Sharafi, B. S. Yilbas, A. Z. Sahin, and T. Ayar, "Performance assessment of hybrid power generation systems: Economic and environmental impacts," *Energy Convers. Manag.*, vol. 132, pp. 418–431, Jan. 2017.
- [9] M. G. Molina, "Distributed energy storage systems for applications in future smart grids," in *Proc. 6th IEEE/PES Transmiss. Distrib., Latin Amer. Conf. Expo. (T&D-LA)*, Sep. 2012, pp. 1–7.
- [10] Y. R. Kafle, K. Mahmud, S. Morsalin, and G. E. Town, "Towards an Internet of energy," in *Proc. IEEE Int. Conf. Power Syst. Technol. (POWERCON)*, Oct. 2016, pp. 1–6.
- [11] J. Han, S. K. Solanki, and J. Solanki, "Coordinated predictive control of a wind/battery microgrid system," *IEEE J. Emerg. Sel. Topics Power Electron.*, vol. 1, no. 4, pp. 296–305, Dec. 2013.
- [12] X. Tan, Q. Li, and H. Wang, "Advances and trends of energy storage technology in microgrid," *Int. J. Elect. Power Energy Syst.*, vol. 44, no. 1, pp. 179–191, 2013.
- [13] J. Rifkin, *The Third Industrial Revolution: How Lateral Power is Transforming Energy, the Economy, and the World*. New York, NY, USA: St. Martin's Press, 2011.
- [14] N. Bui, A. P. Castellani, P. Casari, and M. Zorzi, "The Internet of energy: A Web-enabled smart grid system," *IEEE Netw.*, vol. 26, no. 4, pp. 39–45, Jul. 2012.
- [15] N. Kampelis et al., "Evaluation of the performance gap in industrial, residential & tertiary near-Zero energy buildings," *Energy Buildings*, vol. 148, pp. 58–73, Aug. 2017.
- [16] O. Vermesan et al., "Internet of energy—Connecting energy anywhere anytime," in *Advanced Microsystems for Automotive Applications*. Berlin, Germany: Springer-Verlag, 2012, pp. 33–34.
- [17] M. Jain, T. Hoppe, and H. Bressers, "Analyzing sectoral niche formation: The case of net-zero energy buildings in India," *Environ. Innov. Soc. Transitions*, vol. 25, pp. 47–63, Dec. 2017.
- [18] K. Loukaidou, A. Michopoulos, and T. Zachariadis, "Nearly-zero energy buildings: Cost-optimal analysis of building envelope characteristics," *Procedia Environ. Sci.*, vol. 38, pp. 20–27, 2017.
- [19] J. Lizana, R. Chacartegui, A. Barrios-Padura, and J. M. Valverde, "Advances in thermal energy storage materials and their applications towards zero energy buildings: A critical review," *Appl. Energy*, vol. 203, pp. 219–239, Oct. 2017.
- [20] D. H. W. Li, L. Yang, and J. C. Lam, "Zero energy buildings and sustainable development implications—A review," *Energy*, vol. 54, pp. 1–10, Jun. 2013.
- [21] Z. Huang, Y. Lu, M. Wei, and J. Liu, "Performance analysis of optimal designed hybrid energy systems for grid-connected nearly/net zero energy buildings," *Energy*, vol. 141, pp. 1795–1809, Dec. 2017.
- [22] D. Kolokotsa, D. Rovas, E. Kosmatopoulos, and K. Kalaitzakis, "A roadmap towards intelligent net zero- and positive-energy buildings," *Sol. Energy*, vol. 85, no. 12, pp. 3067–3084, 2011.
- [23] A. Robert and M. Kummert, "Designing net-zero energy buildings for the future climate, not for the past," *Building Environ.*, vol. 55, pp. 150–158, Sep. 2012.
- [24] C. K. Mytafides, A. Dimoudi, and S. Zoras, "Transformation of a university building into a zero energy building in Mediterranean climate," *Energy Buildings*, vol. 155, pp. 98–114, Nov. 2017.
- [25] M. Santamouris, "Innovating to zero the building sector in Europe: Minimising the energy consumption, eradication of the energy poverty and mitigating the local climate change," *Sol. Energy*, vol. 128, pp. 61–94, Apr. 2016.
- [26] Y. Sun, G. Huang, X. Xu, and A. C.-K. Lai, "Building-group-level performance evaluations of net zero energy buildings with non-collaborative controls," *Appl. Energy*, vol. 212, pp. 565–576, Feb. 2018.
- [27] X. Cao, X. Dai, and J. Liu, "Building energy-consumption status worldwide and the state-of-the-art technologies for zero-energy buildings during the past decade," *Energy Build.*, vol. 128, pp. 198–213, Sep. 2016.
- [28] H. A. Özkan, "A new real time home power management system," *Energy Buildings*, vol. 97, pp. 56–64, Jun. 2015.
- [29] S. Deng, R. Z. Wang, and Y. J. Dai, "How to evaluate performance of net zero energy building—A literature research," *Energy*, vol. 71, pp. 1–16, Jul. 2014.
- [30] S. Kosai and C. Tan, "Quantitative analysis on a zero energy building performance from energy trilemma perspective," *Sustain. Cities Soc.*, vol. 32, pp. 130–141, Jul. 2017.
- [31] *European Parliament and the Council, European Performance of Buildings Directive*, Brussels, Belgium, 2010.
- [32] A. J. Marszal et al., "Zero energy building—A review of definitions and calculation methodologies," *Energy Buildings*, vol. 43, no. 4, pp. 971–979, 2011.
- [33] A. Kylili and P. A. Fokaides, "European smart cities: The role of zero energy buildings," *Sustain. Cities Soc.*, vol. 15, pp. 86–95, Jul. 2015.
- [34] S. Lou, E. K. W. Tsang, D. H. W. Li, E. W. M. Lee, and J. C. Lam, "Towards zero energy school building designs in Hong Kong," *Energy Procedia*, vol. 105, pp. 182–187, May 2017.
- [35] W. Wu, J. Guo, J. Li, H. Hou, Q. Meng, and W. Wang, "A multi-objective optimization design method in zero energy building study: A case study concerning small mass buildings in cold district of China," *Energy Buildings*, vol. 158, pp. 1613–1624, Jan. 2017.
- [36] R. Holopainen, A. Milandru, H. Ahvenniemi, and T. Häkkinen, "Feasibility studies of energy retrofits—Case studies of nearly zero-energy building renovation," *Energy Procedia*, vol. 96, pp. 146–157, Sep. 2016.
- [37] E. Perlova, M. Platonova, A. Gorshkov, and X. Rakova, "Concept project of zero energy building," *Procedia Eng.*, vol. 100, pp. 1505–1514, 2015.
- [38] W. Zeiler and G. Boxem, "Net-zero energy building schools," *Renew. Energy*, vol. 49, pp. 282–286, Jan. 2013.
- [39] A. Joanna, I. Sartori, A. Napolitano, A. J. Marszal, S. Pless, and P. Torcellini, "Criteria for definition of net zero energy buildings," Tech. Rep., 2010.
- [40] L. Wells, B. Rismanchi, and L. Aye, "A review of net zero energy buildings with reflections on the Australian context," *Energy Buildings*, vol. 158, pp. 616–628, Jan. 2018.
- [41] P. Seljom, K. B. Lindberg, A. Tomasgard, G. Doorman, and I. Sartori, "The impact of zero energy buildings on the scandinavian energy system," *Energy*, vol. 118, pp. 284–296, Jan. 2017.
- [42] I. Sartori, A. Napolitano, and K. Voss, "Net zero energy buildings: A consistent definition framework," *Energy Buildings*, vol. 48, no. 1, pp. 220–232, 2012.
- [43] D. Kolokotsa, "The role of smart grids in the building sector," *Energy Buildings*, vol. 116, pp. 703–708, Mar. 2016.
- [44] J. A. Clarke et al., "Simulation-assisted control in building energy management systems," *Energy Buildings*, vol. 34, no. 9, pp. 933–940, 2002.
- [45] J. Ock, R. R. A. Issa, and I. Flood, "Smart building energy management systems (BEMS) simulation conceptual framework," in *Proc. Winter Simulation Conf.*, Dec. 2016, pp. 3237–3245.
- [46] S. Attia et al., "Overview and future challenges of nearly zero energy buildings (nZEB) design in Southern Europe," *Energy Buildings*, vol. 155, pp. 439–458, Nov. 2017.

- [47] P. Singh and R. Verma, "Zero-energy buildings—A review," *SAMRID-DHI, J. Phys. Sci., Eng. Technol.*, vol. 5, no. 2, pp. 143–150, 2014.
- [48] H. B. K. Gvozdenovic, W. Maassen, and W. Zeiler, "Roadmap to nearly zero energy buildings," Roy. HaskoningDHV, Eindhoven Univ. Technol., Eindhoven, The Netherlands, Tech. Rep., 2014.
- [49] F. Ascione, N. Bianco, R. F. De Masi, G. M. Mauro, and G. P. Vanoli, "Energy retrofit of educational buildings: Transient energy simulations, model calibration and multi-objective optimization towards nearly zero-energy performance," *Energy Buildings*, vol. 144, pp. 303–319, Jun. 2017.
- [50] M. Ferreira, M. Almeida, and A. Rodrigues, "Impact of co-benefits on the assessment of energy related building renovation with a nearly-zero energy target," *Energy Buildings*, vol. 152, pp. 587–601, Oct. 2017.
- [51] K. Wang, J. Bao, M. Wu, and W. Lu, "Research on security management for Internet of Things," in *Proc. Int. Conf. Comput. Appl. Syst. Modeling (ICCSM)*, vol. 15, Oct. 2010, pp. V15-133–V15-137.
- [52] Z. Ma, P. Cooper, D. Daly, and L. Ledo, "Existing building retrofits: Methodology and state-of-the-art," *Energy Buildings*, vol. 55, pp. 889–902, Dec. 2012.
- [53] E. K. Zavadskas, J. Antucheviciene, D. Kalibatas, and D. Kalibatiene, "Achieving nearly zero-energy buildings by applying multi-attribute assessment," *Energy Buildings*, vol. 143, pp. 162–172, May 2017.
- [54] R. Wu, G. Mavromatidis, K. Orehounig, and J. Carmeliet, "Multiobjective optimisation of energy systems and building envelope retrofit in a residential community," *Appl. Energy*, vol. 190, pp. 634–649, Mar. 2017.
- [55] D.-M. Han and J.-H. Lim, "Smart home energy management system using IEEE 802.15.4 and ZigBee," *IEEE Trans. Consum. Electron.*, vol. 56, no. 3, pp. 1403–1410, Aug. 2010.
- [56] J. Han, C.-S. Choi, W.-K. Park, I. Lee, and S.-H. Kim, "Smart home energy management system including renewable energy based on ZigBee and PLC," *IEEE Trans. Consum. Electron.*, vol. 60, no. 2, pp. 198–202, May 2014.
- [57] P. Muñoz, P. Morales, V. Letelier, L. Muñoz, and D. Mora, "Implications of life cycle energy assessment of a new school building, regarding the nearly zero energy buildings targets in EU: A case of study," *Sustain. Cities Soc.*, vol. 32, pp. 142–152, Jul. 2017.
- [58] D. Agdas, R. S. Srinivasan, K. Frost, and F. J. Masters, "Energy use assessment of educational buildings: Toward a campus-wide sustainable energy policy," *Sustain. Cities Soc.*, vol. 17, pp. 15–21, Sep. 2015.
- [59] D. Lee and C.-C. Cheng, "Energy savings by energy management systems: A review," *Renew. Sustain. Energy Rev.*, vol. 56, pp. 760–777, Apr. 2016.
- [60] J. Plourde, "Making the case for energy metering," *ASHRAE J.*, vol. 53, no. 4, pp. 20–27, 2011.
- [61] M. Donnelly, "Building energy management: Using data as a tool," 2012.
- [62] U.S. Environmental Protection Agency, "Benchmarking to Save Energy", 2006.
- [63] S. Katipamula and M. R. Brambley, "Methods for fault detection, diagnostics, and prognostics for building systems—A review, part 1," *HVAC&R Res.*, vol. 11, no. 1, pp. 3–25, 2005.
- [64] A. L. Dexter and D. Ngo, "Fault diagnosis in air-conditioning systems: A multi-step fuzzy model-based approach," *HVAC&R Res.*, vol. 7, no. 1, pp. 83–102, 2001.
- [65] L. K. Norford, J. A. Wright, R. A. Buswell, D. Luo, C. J. Klaassen, and A. Suby, "Demonstration of fault detection and diagnosis methods for air-handling units," *HVAC&R Res.*, vol. 8, no. 1, pp. 41–71, Jan. 2002.
- [66] E. Sobhani-Tehrani and K. Khorasani, *Fault Diagnosis of Nonlinear Systems Using a Hybrid Approach*, vol. 383. Berlin, Germany: Springer, 2009, pp. 21–50.
- [67] S. Lazarova-Molnar and N. Mohamed, "A framework for collaborative cloud-based fault detection and diagnosis in smart buildings," in *Proc. 7th Int. Conf. Modeling Simulation, Appl. Optim.*, 2017, pp. 1–6.
- [68] K. K. Andersen and T. A. Reddy, "The error in variables (EIV) regression approach as a means of identifying unbiased physical parameter estimates: Application to chiller performance data," *HVAC&R Res.*, vol. 8, no. 3, pp. 295–309, Jul. 2002.
- [69] K. Mittal, J. P. Wilson, B. P. Baillie, S. Gupta, G. M. Bollas, and P. B. Luh, "Supervisory control for resilient chiller plants under condenser fouling," *IEEE Access*, vol. 5, pp. 14028–14046, 2017.
- [70] S. Lazarova-Molnar, H. R. Shaker, N. Mohamed, and B. N. Jørgensen, "Fault detection and diagnosis for smart buildings: State of the art, trends and challenges," in *Proc. IEEE Int. Conf.*, Mar. 2016, pp. 1–7.
- [71] J. W. Kim, Y. K. Jeong, and I. W. Lee, "Automatic sensor arrangement system for building energy and environmental management," *Energy Procedia*, vol. 14, pp. 265–270, 2012.
- [72] L. M. B. Restoy, A. Costa, N. Rehaut, and M. Keane, "Integration of fault detection and diagnosis with energy management standard ISO 50001 and operations and maintenance of HVAC systems," in *Proc. CLIMA*, Jul. 2014, pp. 1–11.
- [73] S. Katipamula and M. R. Brambley, "Review Article: Methods for fault detection, diagnostics, and prognostics for building systems—A review, part II," *HVAC&R Res.*, vol. 11, no. 2, pp. 169–187, 2005.
- [74] E. Burman, D. Mumovic, and J. Kimpian, "Towards measurement and verification of energy performance under the framework of the European directive for energy performance of buildings," *Energy*, vol. 77, pp. 153–163, Dec. 2014.
- [75] E. E. Richman, "Measurement and verification of energy savings and performance from advanced lighting controls," Tech. Rep., 2016.
- [76] S. Slote, M. Sherman, and D. Crossley, "Energy efficiency evaluation, measurement, and verification," Tech. Rep., Mar. 2014.
- [77] *Concepts and Options for Determining Energy and Water Savings*, vol. 1, U.S. Dept. Energy, Oak Ridge, TN, USA, 2002, pp. 1–93.
- [78] J. Kummer, O. Nix, and K. Drees, "Measurement and verification of energy savings," Tech. Rep., Nov. 2011.
- [79] A. Lefort, "A smart grid ready building energy management system based on a hierarchical model predictive control," Tech. Rep., 2014.
- [80] D. L. Loveday, G. S. Virk, and J. M. Cheung, "Advanced control for BEMS: A model-based predictive approach," *Building Services Eng. Res. Technol.*, vol. 13, no. 4, pp. 217–223, 1992.
- [81] Y. H. Said et al., "A global model based energy management system applied to the CANOPEA building," in *Proc. 13th Conf. Int. Building Perform. Simulation Assoc.*, Chambéry, France, Aug. 2013, pp. 2185–2193.
- [82] D. Murayama, K. Mitsumoto, Y. Takagi, Y. Iino, and S. Yamamori, "Smart grid ready BEMS adopting model-based HVAC control for energy saving," in *Proc. IEEE PES Transm. Distrib. Conf. Expo. (T&D)*, May 2012, pp. 1–6.
- [83] B. Foster, "Construction operations building information exchange," BIM Smart Foundation, National BIM Standard, USA, 2014, pp. 1–37.
- [84] *National BIM Standard—United States*, 2015.
- [85] E. East, "Construction operations building information exchange (COBie)," Tech. Rep., Jun. 2007.
- [86] S. Keshav and C. Rosenberg, "How Internet concepts and technologies can help green and smarten the electrical grid," *ACM SIGCOMM Comput. Commun. Rev.*, vol. 41, no. 1, p. 109, 2011.
- [87] K. Wang, H. Li, Y. Feng, and G. Tian, "Big data analytics for system stability evaluation strategy in the energy Internet," *IEEE Trans. Ind. Inform.*, vol. 13, no. 4, pp. 1969–1978, Aug. 2017.
- [88] V. Badescu, N. Rotar, and I. Udrea, "Considerations concerning the feasibility of the German *Passivhaus* concept in Southern Hemisphere," *Energy Efficiency*, vol. 8, no. 5, pp. 919–949, 2015.
- [89] Y. Xu, J. Zhang, W. Wang, A. Juneja, and S. Bhattacharya, "Energy router: Architectures and functionalities toward energy Internet," in *Proc. IEEE Int. Conf. Smart Grid Commun. (SmartGridComm)*, Oct. 2011, pp. 31–36.
- [90] M. A. Hannan, M. M. Hoque, A. Mohamed, and A. Ayob, "Review of energy storage systems for electric vehicle applications: Issues and challenges," *Renew. Sustain. Energy Rev.*, vol. 69, pp. 771–789, Mar. 2017.
- [91] O. Palizban and K. Kauhaniemi, "Energy storage systems in modern grids—Matrix of technologies and applications," *J. Energy Storage*, vol. 6, pp. 248–259, May 2016.
- [92] R. Xiong, J. Cao, Q. Yu, H. He, and F. Sun, "Critical review on the battery state of charge estimation methods for electric vehicles," *IEEE Access*, vol. 6, pp. 1832–1843, 2017.
- [93] A. S. Subburaj, B. N. Pushpakaran, and S. B. Bayne, "Overview of grid connected renewable energy based battery projects in USA," *Renew. Sustain. Energy Rev.*, vol. 45, pp. 219–234, May 2015.
- [94] J. Mundackal, A. C. Varghese, P. Sreekala, and V. Reshmi, "Grid power quality improvement and battery energy storage in wind energy systems," in *Proc. Annu. Int. Conf. Emerg. Res. Areas, Int. Conf. Microelectron., Commun. Renew. Energy*, Jun. 2013, pp. 1–6.
- [95] G. Huff et al., "DOE/EPRI 2013 electricity storage handbook in collaboration with NRECA," Tech. Rep., Jul. 2013, p. 340.
- [96] D. Bosseboeu, "Energy efficiency trends and policies in the household and tertiary sectors an analysis based on the ODYSSEE and MURE databases," Tech. Rep., 2015.



- [97] R. Parameshwaran and S. Kalaiselvam, *Thermal Energy Storage Technologies for Sustainability: Systems Design, Assessment and Applications*, 1st ed. New York, NY, USA: Academic, 2014.
- [98] S. E. Kalnæs and B. P. Jelle, "Phase change materials and products for building applications: A state-of-the-art review and future research opportunities," *Energy Buildings*, vol. 94, no. 7491, pp. 150–176, 2015.
- [99] D. Zhou, C. Y. Zhao, and Y. Tian, "Review on thermal energy storage with phase change materials (PCMs) in building applications," *Appl. Energy*, vol. 92, pp. 593–605, Apr. 2012.
- [100] J. H. Davidson et al., "Development of space heating and domestic hot water systems with compact thermal energy storage. Compact thermal energy storage: Material development for system integration," Tech. Rep., Dec. 2012.
- [101] N. Yu, R. Z. Wang, and L. W. Wang, "Sorptions thermal storage for solar energy," *Prog. Energy Combustion Sci.*, vol. 39, no. 5, pp. 489–514, 2013.
- [102] K. E. N'Tsoukpoe, H. Liu, N. L. Pierrés, and L. Luo, "A review on long-term sorption solar energy storage," *Renew. Sustain. Energy Rev.*, vol. 13, no. 9, pp. 2385–2396, 2009.
- [103] P. Tatsidjoudoung, N. Le Pierrés, and L. Luo, "A review of potential materials for thermal energy storage in building applications," *Renew. Sustain. Energy Rev.*, vol. 18, pp. 327–349, 2013.
- [104] A. Kostevšek, J. J. Klemš, P. S. Varbanov, L. Čuček, and J. Petek, "Sustainability assessment of the locally integrated energy sectors for a slovenian municipality," *J. Cleaner Prod.*, vol. 88, pp. 83–89, Feb. 2015.
- [105] 2014CAR: United States Climate Action Report 2014, Six Nat. Commun. USA United Nations Framework Convention Climate Change, U.S. Dept. State, Washington, DC, USA, 2014.
- [106] G. Boukettaya and L. Krichen, "A dynamic power management strategy of a grid connected hybrid generation system using wind, photovoltaic and flywheel energy storage system in residential applications," *Energy*, vol. 71, pp. 148–159, Jul. 2014.
- [107] M. Xue, N. Kojima, L. Zhou, T. Machimura, and A. Tokai, "Dynamic analysis of global warming impact of the household refrigerator sector in Japan from 1952 to 2030," *J. Cleaner Prod.*, vol. 145, pp. 172–179, Mar. 2017.
- [108] R. Xiao, Y. Zhang, X. Liu, and Z. Yuan, "A life-cycle assessment of household refrigerators in China," *J. Cleaner Prod.*, vol. 95, pp. 301–310, May 2015.
- [109] S. Bobba, F. Ardenne, and F. Mathieux, "Technical support for environmental footprinting, material efficiency in product policy and the European platform on LCA—Durability assessment of vacuum cleaners," JCR Sci. Policy Rep., Nov. 2015.
- [110] R. Hischer and I. Baudin, "LCA study of a plasma television device," *Int. J. Life Cycle Assessment*, vol. 15, no. 5, pp. 428–438, 2010.
- [111] F. Reale et al., "Dealing with LCA modeling for the end of life of mechatronic products," *Environ. Eng. Manage. J.*, vol. 14, pp. 1691–1704, 2015.
- [112] M. M. Rana, "Architecture of the Internet of energy network: An application to smart grid communications," *IEEE Access*, vol. 5, pp. 4704–4710, 2017.
- [113] M. Jaradat, M. Jarrah, A. Boussehelam, Y. Jararweh, and M. Al-Ayyoub, "The Internet of energy: Smart sensor networks and big data management for smart grid," *Procedia Comput. Sci.*, vol. 56, no. 1, pp. 592–597, 2015.
- [114] L. Bedogni et al., "An interoperable architecture for mobile smart services over the Internet of energy," in *Proc. IEEE 14th Int. Symp. World Wireless, Mobile Multimedia Netw. (WoWMoM)*, Jun. 2013, pp. 1–6.
- [115] T. Liu, R. Yuan, and H. Chang, "Research on the Internet of Things in the automotive industry," in *Proc. Int. Conf. Manage. e-Commerce e-Government*, Oct. 2012, pp. 230–233.
- [116] C. Wei and Y. Li, "Design of energy consumption monitoring and energy-saving management system of intelligent building based on the Internet of Things," in *Proc. Int. Conf. Electron., Commun. Control (ICECC)*, Sep. 2011, pp. 3650–3652.
- [117] T. Chan, "GE says 'net zero energy home' achievable by 2015," Tech. Rep., 2009.
- [118] J. S. Bourrelle, "Zero energy buildings and the rebound effect: A solution to the paradox of energy efficiency?" *Energy Buildings*, vol. 84, pp. 633–640, Dec. 2014.
- [119] A. J. Marszal et al., "North European understanding of zero energy/emission buildings," in *Proc. Renew. Energy Res. Conf.*, 2010, pp. 167–178.
- [120] I. Sartori, A. Napolitano, A. J. Marszal, S. Pless, P. Torcellini, and K. Voss, "Criteria for definition of net zero energy buildings," in *Proc. Int. Conf. Solar Heating, Cooling Buildings*, Sep./Oct. 2010, pp. 1–8, doi: 10.18086/eurosun.2010.06.21.
- [121] H.-J. Kang, S.-Y. Kang, J.-C. Park, and E.-G. Rhee, "A study on the design process of zero emission buildings," *J. Korean Sol. Energy Soc.*, vol. 30, no. 2, pp. 39–45, 2010.
- [122] E. L. Cano, M. Groissböck, J. M. Moguerza, and M. Stadler, "A strategic optimization model for energy systems planning," *Energy Buildings*, vol. 81, pp. 416–423, Oct. 2014.
- [123] S. Bucking, A. Athienitis, and R. Zmeureanu, "Multi-objective optimal design of a near net zero energy solar house," *ASHRAE Trans.*, vol. 120, no. 1, pp. 224–235, 2014.
- [124] A. S. Gorshkov, P. P. Rymkevich, D. V. Nemova, and N. I. Vatin, "Methods of calculating the return on investment to renovate the facades of existing buildings," *Stroitelstvo unikalnykh zdaniy i sooruzheniy*, vol. 2, no. 17, pp. 82–106, 2014.
- [125] M. R. Millan, L. Wallace, and E. Conner, "Net zero energy building analysis for McDonalds," M.S. thesis, Nicholas School Environ. Earth Sci., Duke Univ., Durham, NC, USA, 2014.
- [126] E. Solgi, R. Fayaz, and B. M. Kari, "Cooling load reduction in office buildings of hot-arid climate, combining phase change materials and night purge ventilation," *Renew. Energy*, vol. 85, pp. 725–731, Jan. 2016.
- [127] M. Kenisarin and K. Mahkamov, "Passive thermal control in residential buildings using phase change materials," *Renew. Sustain. Energy Rev.*, vol. 55, pp. 371–398, Mar. 2016.
- [128] P. Nunes, M. M. Lerer, and G. C. Da Graça, "Energy certification of existing office buildings: Analysis of two case studies and qualitative reflection," *Sustain. Cities Soc.*, vol. 9, pp. 81–95, Dec. 2013.
- [129] R. J. Fang, Y. B. Zhang, D. M. Shen, Y. He, and L. W. Zhang, "Whole life cycle energy-saving measures of large-scale public building," *Appl. Mech. Mater.*, vols. 71–78, pp. 4923–4926, 2011.
- [130] B. Berggren, M. Hall, and M. Wall, "LCE analysis of buildings—Taking the step towards net zero energy buildings," *Energy Buildings*, vol. 62, pp. 381–391, Jul. 2013.
- [131] P. Chastas, T. Theodosiou, D. Bikas, and K. Kontoleon, "Embodied energy and nearly zero energy buildings: A review in residential buildings," *Procedia Environ. Sci.*, vol. 38, pp. 554–561, 2017.
- [132] A. Takano, S. K. Pal, M. Kuittinen, and K. Alanne, "Life cycle energy balance of residential buildings: A case study on hypothetical building models in Finland," *Energy Buildings*, vol. 105, pp. 154–164, Oct. 2015.
- [133] K. I. Praseeda, B. V. V. Reddy, and M. Mani, "Embodied and operational energy of urban residential buildings in India," *Energy Buildings*, vol. 110, pp. 211–219, Jan. 2016.
- [134] I. Khajenasiri et al., "Design and implementation of a multi-standard event-driven energy management system for smart buildings," in *Proc. IEEE 3rd Global Conf. Consum. Electron. (GCCE)*, Oct. 2014, pp. 20–21.
- [135] I. Khajenasiri, J. Virgone, and G. Gielen, "A presence-based control strategy solution for HVAC systems," in *Proc. IEEE Int. Conf. Consum. Electron. (ICCE)*, Jan. 2015, pp. 620–622.
- [136] M. Gil-Baez, Á. Barrios-Padura, M. Molina-Huelva, and R. Chacartegui, "Natural ventilation systems in 21st-century for near zero energy school buildings," *Energy*, vol. 137, pp. 1186–1200, Oct. 2017.
- [137] S. Ferrari and M. Beccali, "Energy-environmental and cost assessment of a set of strategies for retrofitting a public building toward nearly zero-energy building target," *Sustain. Cities Soc.*, vol. 32, pp. 226–234, Jul. 2017.
- [138] A. J. Abid, "Internet of energy: A design to manage energy consumption for limited resources building," *Int. J. Open Inf. Technol.*, vol. 5, no. 6, pp. 20–25, 2017.
- [139] G. Yun, K. C. Yoon, and K. S. Kim, "The influence of shading control strategies on the visual comfort and energy demand of office buildings," *Energy Buildings*, vol. 84, pp. 70–85, Dec. 2014.
- [140] H. Wang and Q. Chen, "Impact of climate change heating and cooling energy use in buildings in the United States," *Energy Buildings*, vol. 82, pp. 428–436, Oct. 2014.
- [141] M. Isaac and D. P. van Vuuren, "Modeling global residential sector energy demand for heating and air conditioning in the context of climate change," *Energy Policy*, vol. 37, no. 2, pp. 507–521, 2009.
- [142] J. Favaro, "Strategic research challenges in the Internet of Things," Tech. Rep., p. 6630.
- [143] R. Billure, V. M. Tayur, and V. Mahesh, "Internet of Things—A study on the security challenges," in *Proc. IEEE Int. Adv. Comput. Conf. (IACC)*, Jun. 2015, pp. 247–252.
- [144] D. Blaauw et al., "IoT design space challenges: Circuits and systems," in *Symp. VLSI Technol. Dig. Tech. Papers*, Jun. 2014, pp. 1–2.
- [145] J. Cao and M. Yang, "Energy Internet—Towards smart grid 2.0," in *Proc. Int. Conf. Netw. Distrib. Comput. (ICNDC)*, Dec. 2014, pp. 105–110.

- [146] K. Wang, X. Hu, H. Li, P. Li, D. Zeng, and S. Guo, "A survey on energy Internet communications for sustainability," *IEEE Trans. Sustain. Comput.*, vol. 2, no. 3, pp. 231–254, May 2017.
- [147] A. Al-Fuqaha, M. Guizani, M. Mohammadi, M. Aledhari, and M. Ayyash, "Internet of Things: A survey on enabling technologies, protocols, and applications," *IEEE Commun. Surveys Tuts.*, vol. 17, no. 4, pp. 2347–2376, 4th Quart., 2015.
- [148] T. Xu, J. B. Wendt, and M. Potkonjak, "Security of IoT systems: Design challenges and opportunities," in *Proc. IEEE/ACM Int. Conf. Comput. Design (ICCAD)*, Nov. 2014, pp. 417–423.
- [149] S. Fries, H. J. Hof, T. Dufaure, and M. Seewald, "Security for the smart grid—Enhancing IEC 62351 to improve security in energy automation control," *Int. J. Adv. Secur.*, vol. 3, no. 3, pp. 169–183, 2011.
- [150] K. Wang, M. Du, S. Maharjan, and Y. Sun, "Strategic honeypot game model for distributed denial of service attacks in the smart grid," *IEEE Trans. Smart Grid*, vol. 8, no. 5, pp. 2474–2482, Feb. 2017.
- [151] Y. Yang, T. Littler, S. Sezer, K. McLaughlin, and H. F. Wang, "Impact of cyber-security issues on smart grid," in *Proc. IEEE PES Innov. Smart Grid Technol. Conf. Eur.*, Dec. 2011, pp. 1–7.
- [152] M. Armbrust et al., "A view of cloud computing," *Commun. ACM*, vol. 53, no. 4, pp. 50–58, 2010.
- [153] C. Zhu, H. Zhou, V. C. M. Leung, K. Wang, Y. Zhang, and L. T. Yang, "Toward big data in green city," *IEEE Commun. Mag.*, vol. 55, no. 11, pp. 14–18, Nov. 2017.
- [154] G. Jia, G. Han, J. Jiang, N. Sun, and K. Wang, "Dynamic resource partitioning for heterogeneous multi-core-based cloud computing in smart cities," *IEEE Access*, vol. 4, pp. 108–118, 2016.
- [155] P. Padmanabhan and G. R. Waissi, "Cloud-based home energy management (HEM) and modeling of consumer decisions," *Int. J. Smart Home*, vol. 10, no. 8, pp. 213–232, 2016.
- [156] I. Khajenasiri, A. Estebasari, M. Verhelst, and G. Gielen, "A review on Internet of Things solutions for intelligent energy control in buildings for smart city applications," *Energy Procedia*, vol. 111, pp. 770–779, Mar. 2017.
- [157] J. Khan and M. H. Arsalan, "Solar power technologies for sustainable electricity generation—A review," *Renew. Sustain. Energy Rev.*, vol. 55, pp. 414–425, Mar. 2016.
- [158] A. K. Pandey, V. V. Tyagi, J. A. Selvaraj, N. A. Rahim, and S. K. Tyagi, "Recent advances in solar photovoltaic systems for emerging trends and advanced applications," *Renew. Sustain. Energy Rev.*, vol. 53, pp. 859–884, Jan. 2016.
- [159] P. K. Ng and N. Mithraratne, "Lifetime performance of semi-transparent building-integrated photovoltaic (BIPV) glazing systems in the tropics," *Renew. Sustain. Energy Rev.*, vol. 31, pp. 736–745, Mar. 2014.
- [160] C. Good, I. Andresen, and A. G. Hestnes, "Solar energy for net zero energy buildings—A comparison between solar thermal, PV and photovoltaic-thermal (PV/T) systems," *Sol. Energy*, vol. 122, pp. 986–996, Dec. 2015.
- [161] T.-C. Cheng, C.-H. Cheng, Z.-Z. Huang, and G.-C. Liao, "Development of an energy-saving module via combination of solar cells and thermoelectric coolers for green building applications," *Energy*, vol. 36, no. 1, pp. 133–140, 2011.
- [162] A. S. Al Busaidi, H. A. Kazem, A. H. Al-Badi, and M. F. Khan, "A review of optimum sizing of hybrid PV-Wind renewable energy systems in Oman," *Renew. Sustain. Energy Rev.*, vol. 53, pp. 185–193, Jan. 2016.
- [163] I. Abohela, N. Hamza, and S. Dudek, "Effect of roof shape, wind direction, building height and urban configuration on the energy yield and positioning of roof mounted wind turbines," *Renew. Energy*, vol. 50, pp. 1106–1118, Feb. 2013.
- [164] D. Ayhan and A. Sağlam, "A technical review of building-mounted wind power systems and a sample simulation model," *Renew. Sustain. Energy Rev.*, vol. 16, no. 1, pp. 1040–1049, 2012.
- [165] X. Tian, M. J. Yang, J. W. Zhao, S. M. He, and J. Zhao, "A study on operational strategy of ground-source heat pump system based on variation of building load," *Energy Procedia*, vol. 75, pp. 1508–1513, Aug. 2015.
- [166] C. Becchio, P. Dabbene, E. Fabrizio, V. Monetti, and M. Filippi, "Cost optimality assessment of a single family house: Building and technical systems solutions for the nZEB target," *Energy Buildings*, vol. 90, pp. 173–187, Mar. 2015.
- [167] M. Bojić, M. Miletić, and L. Bojić, "Optimization of thermal insulation to achieve energy savings in low energy house (refurbishment)," *Energy Convers. Manage.*, vol. 84, pp. 681–690, Aug. 2014.
- [168] M. Hamdy, A. Hasan, and K. Siren, "A multi-stage optimization method for cost-optimal and nearly-zero-energy building solutions in line with the EPBD-recast 2010," *Energy Buildings*, vol. 56, pp. 189–203, Jan. 2013.
- [169] J. Kurnitski, A. Saari, T. Kalamees, M. Vuolle, J. Niemelä, and T. Tark, "Cost optimal and nearly zero (nZEB) energy performance calculations for residential buildings with REHVA definition for nZEB national implementation," *Energy Buildings*, vol. 43, no. 11, pp. 3279–3288, 2011.
- [170] M. P. Deuble and R. J. de Dear, "Green occupants for green buildings: The missing link?" *Building Environ.*, vol. 56, pp. 21–27, Oct. 2012.
- [171] H. Liang, A. Abdrabou, and W. Zhuang, "Stochastic information management for voltage regulation in smart distribution systems," in *Proc. IEEE Conf. Comput. Commun.*, Apr./May 2014, pp. 2652–2660.
- [172] J. C. Ciscar et al., "Climate impacts in Europe: The JRC PESETA II project," Tech. Rep., 2014.



**MAHAMMAD A. HANNAN** (M'10–SM'17) received the B.Sc. degree in electrical and electronic engineering from the Chittagong University of Engineering and Technology, Chittagong, Bangladesh, in 1990, and the M.Sc. and Ph.D. degrees in electrical, electronic, and systems engineering from Universiti Kebangsaan Malaysia, Bangi, Malaysia, in 2003 and 2007, respectively. He is currently a Professor of intelligent systems with the Department of Electrical Power Engineering, College of Engineering, Universiti Tenaga Nasional, Malaysia. His research interests include intelligent controllers, power electronics, hybrid vehicles, energy storage systems, image and signal processing, and artificial intelligence. He received numbers of gold awards for his innovative research in ITEX, MTE, INNOFEST, SIIF, and PERINTIS. He is an Associate Editor of the IEEE Access.



**MOHAMMAD FAISAL** received the B.Sc. degree in electrical and electronic engineering from the Chittagong University of Engineering and Technology, Chittagong, Bangladesh, in 2010. He is currently pursuing the M.Sc. degree with the Universiti Tenaga Nasional, Malaysia. He was appointed as a Lecturer with International Islamic University Chittagong, Bangladesh, in 2010, where he is currently an Assistant Professor. His research interests include power electronics and power system, energy storage systems, energy management, and intelligent controller.



**PIN JERN KER** received the B.Eng. degree (Hons.) in electrical and electronic engineering from the Universiti Tenaga Nasional (UNITEN), Malaysia, in 2009, and the Ph.D. degree in electronic and electrical engineering from The University of Sheffield, U.K. He is currently a Senior Lecturer with the Department of Electrical Power Engineering, UNITEN. He is also the Head of Unit (Electronics and IT) with the Institute of Power Engineering, a research institute of UNITEN. His research interests are the simulation and characterization of photodetectors, optical sensing, design of monitoring, and control system for energy-related applications.



**LOOE HUI MUN** received the B.Eng. (Hons) and Ph.D. degrees from the Department of Electrical Engineering and Electronics, University of Liverpool, U.K., in 1997 and 2004, respectively. He was a Post-Doctoral Research Associate with the University of Liverpool, where he was with the Centre for Intelligent Monitoring System. He is currently a Principal Researcher with the Smart Grid Unit, TNB Research Sdn. Bhd. His research interests include the development of data-driven diagnostic methods for industrial and electrical engineering applications, smart substation technology, and sensor management and analytics.



**KHADIJA PARVIN** received the B.Sc. degree in electrical and electronic engineering from the University of Asia Pacific, Bangladesh, in 2017. She is currently pursuing the M.Sc. degree (by research) from the Universiti Tenaga Nasional, Malaysia. Her research interests include power electronics and power system, energy storage systems, energy management, and intelligent controller.



**TEUKU MEURAH INDRA MAHLIA** received the B.Sc. degree in mechanical engineering from Syiah Kuala University, Banda Aceh, Indonesia, and the M.Sc. degree in engineering and the Ph.D. degree from the University of Malaya in 1997 and 2003, respectively. He was a Professor with the University of Malaysia. In 2012, he joined the College of Engineering, Universiti Tenaga Nasional, as a Senior Professor. His research interests renewable energy, energy policy, energy modeling, energy efficiency, and energy management. He is one of the top researchers in Malaysia in terms of research citation.



**FREDE BLAABJERG** (S'86–M'88–SM'97–F'03) received the Ph.D. degree in power electronics from Aalborg University, Aalborg, Denmark. He was with ABB-Scandia, Randers, Denmark, from 1987 to 1988. He is currently a Professor with Aalborg University. His current research interests include power electronics and its applications, such as in wind turbines, PV systems, reliability, harmonics, and adjustable speed drives. He received 18 IEEE Prize Paper Awards, the IEEE PELS Distinguished Service Award in 2009, the EPE-PEMC Council Award in 2010, the IEEE William E. Newell Power Electronics Award in 2014, and the Villum Kann Rasmussen Research Award in 2014. He was the Editor-in-Chief of the IEEE TRANSACTIONS ON POWER ELECTRONICS from 2006 to 2012. He is nominated in 2014, 2015, and 2016 by Thomson Reuters to be between the most 250 cited researchers in engineering in the world.

• • •