



Aalborg Universitet

AALBORG UNIVERSITY
DENMARK

Use of a Pre-Insertion Resistor to Minimize Zero-Missing Phenomenon and Switching Overvoltages

Bak, Claus Leth; da Silva, Filipe Miguel Faria; Gudmundsdottir, Unnur Stella; Wiechowski, Wojciech Tomasz; Knardrupgård, M. R.

Published in:

Proceedings of the IEEE Power and Energy Society General Meeting

DOI (link to publication from Publisher):

[10.1109/PES.2009.5275992](https://doi.org/10.1109/PES.2009.5275992)

Creative Commons License

CC BY-NC-ND 4.0

Publication date:

2009

Document Version

Accepted author manuscript, peer reviewed version

[Link to publication from Aalborg University](#)

Citation for published version (APA):

Bak, C. L., da Silva, F. M. F., Gudmundsdottir, U. S., Wiechowski, W. T., & Knardrupgård, M. R. (2009). Use of a Pre-Insertion Resistor to Minimize Zero-Missing Phenomenon and Switching Overvoltages. In *Proceedings of the IEEE Power and Energy Society General Meeting* (pp. 1-7). IEEE. <https://doi.org/10.1109/PES.2009.5275992>

General rights

Copyright and moral rights for the publications made accessible in the public portal are retained by the authors and/or other copyright owners and it is a condition of accessing publications that users recognise and abide by the legal requirements associated with these rights.

- Users may download and print one copy of any publication from the public portal for the purpose of private study or research.
- You may not further distribute the material or use it for any profit-making activity or commercial gain
- You may freely distribute the URL identifying the publication in the public portal -

Take down policy

If you believe that this document breaches copyright please contact us at vbn@aub.aau.dk providing details, and we will remove access to the work immediately and investigate your claim.

Use of a Pre-Insertion Resistor to Minimize Zero-Missing Phenomenon and Switching Overvoltages

F. Faria da Silva, C. L. Bak, U. S. Guðmundsdóttir, W. Wiechowski and M. R. Knardrupgård

Abstract--With the increasing use of High-Voltage Cables, which have different electric characteristics from Overhead Lines, phenomenon like current zero-missing start to appear more often on the transmission systems. Methods to prevent zero-missing phenomenon are still being studied and compared to see which countermeasure works the best. Technically the best way to avoid zero-missing phenomenon produces very high switching overvoltages, making the operator to choose to either avoid the zero-missing phenomenon or to minimize the switching transients. This paper presents a method of determining an optimal value of the resistance of the pre-insertion resistor that results in minimizing both the zero-missing phenomenon and switching overvoltages simultaneously.

Index Terms--Cables, Circuit Breaker, Pre-Insertion Resistor, Shunt Reactor, Switching Transients, Level-crossing problems

I. INTRODUCTION

The increase of public pressure regarding the devastation of areas of natural beauty by Overhead Lines (OHL), drove to increase demand for the substitution of the OHL by underground cables.

The Danish Transmission System Operator (Energinet.dk) is studying a possible expansion of the high-voltage system using AC underground cables instead of OHL. One of the problems that must be studied when using systems with underground cable is zero-missing phenomenon.

Electrically the main difference between an OHL and an Underground Cable is the much higher capacitance of the last ones, which can be dozens of times superior to the capacitance of OHL [2].

Because of this high capacitance, it is required to connect

shunt reactor(s) in parallel to the cables, in order to compensate the reactive power generated by them.

If the shunt reactors are compensating all the reactive power generated by the cable, the AC component of the current in the cable has opposite phase angle to AC component of the current into the shunt reactors, and therefore they cancel out each other. As the transient of the shunt's reactor current contain both AC and DC components, during transient conditions (as for instance energization of a cable compensated with shunt reactors) under ideal conditions only DC component would remain.

During energizing, the cable has no load and it is open in the far end. As the resistance of the system (cables+shunt reactors) is very small, it may take several seconds for the DC component to be damped. As the current does not cross zero during those seconds, it is not possible to open the circuit breaker without risking damaging it, unless it is prepared to interrupt DC currents or currents with several amperes [3][4].

If in the meanwhile, a single-phase or two-phase fault occurs on the cable, the circuit breaker will be able to open the faulted phases but not the healthy phase(s) because of the lack of zero-crossings of the current. This can lead to a damage of the circuit breaker.

A method that can be used to damp the DC component in just half of cycle, is to use circuit breakers equipped with pre-insertion resistors.

II. ZERO-MISSING PHENOMENON AND SWITCHING OVERVOLTAGES

An easy way to understand zero-missing phenomenon is to analyze the transient behaviour of an inductor in parallel with a capacitor of equal impedance.

In this situation the currents in each one of the elements have equal amplitude and are in phase opposition. But in transient conditions the current in the inductor also has a DC offset, whose value depends on the voltage value at the connection moment.

There is a 90° difference between the phases of the current and the voltage in an inductor, therefore if the inductor is connected in a voltage peak the current should be zero. If it is connected when the voltage is zero the current should have a peak value. As the current in the inductor must maintain its continuity, and it was zero before the connection of the

This work was supported in part by the Danish Transmission System Operator, Energinet.dk.

F. F. da Silva is a PhD student at the Institute of Energy Technology, Aalborg University, 9220 Aalborg, Denmark (e-mail:ffs@iet.aau.dk).

C. L. Bak is with the Institute of Energy Technology, Aalborg University, 9220 Aalborg, Denmark (e-mail: clb@iet.aau.dk).

U. S. Guðmundsdóttir is a PhD student at the Institute of Energy Technology, Aalborg University, 9220 Aalborg, Denmark (e-mail: usg@iet.aau.dk).

W. Wiechowski is a Senior System Analyst at the Planning Department of Energinet.dk (e-mail: wwi@energinet.dk)

M. R. Knardrupgård is with the Planning Department of Energinet.dk (e-mail: mra@energinet.dk)

inductor, if the voltage is not at a peak value in the connection moment, a DC current equal to minus the value of the AC component in the connection moment, appears to maintain its continuity [5].

If the system does not have any resistive element the DC component can not be damped and it will be maintained infinitely, as in reality there is always some resistance the DC component disappears after some time.

Fig. 1 shows the currents of an inductor in series with a resistor both in parallel with a capacitor. The resistance is 100 times smaller than the inductor's reactance and the reactance is equal to the capacitor's reactance. The circuit breaker is closed when the voltage is zero, resulting in a maximum DC component. As can be seen in Fig. 2, both the inductive and capacitive AC components cancel out (I_L and I_C) and the resultant remaining current contains only a decaying DC component of the inductance.

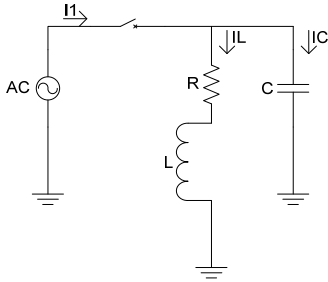

Fig. 1 Diagram of an inductor in series with a resistor, both in parallel with a capacitor

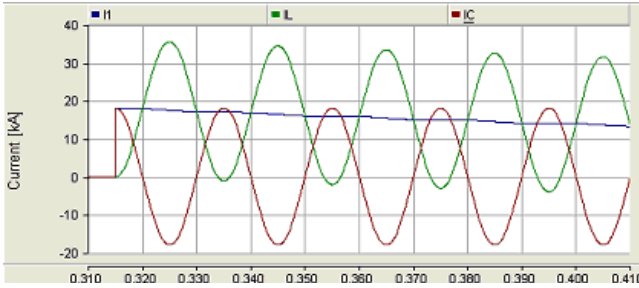

Fig. 2 Current in the inductor (I_L), in the capacitor (I_C) and the sum ($I_1=I_L+I_C$)

The behaviour of a system consisting of a shunt reactor and a cable is not very different from the one of Fig. 1. The shunt reactor can be modelled as an inductor in series with a resistor, and the cable's capacitance is much larger than its series resistance and inductance, making the cable mainly a capacitive shunt element [6]. Of course there are differences between the behaviour of a simple RLC circuit and a physical cable/reactor system, as for instance switching overvoltages if the cable is connected when the voltage is at a peak value.

Like in the case of zero-missing phenomenon, the value of switching overvoltages depend on the value of the voltage at the instant of connecting the cable/reactor system, however while to avoid zero-missing phenomenon the connection should be made when the voltage is at a peak, to avoid switching overvoltages the connection should be made when the voltage is zero [4][7].

According to [1] it is not possible to avoid both situations at the same time, but as this paper shows, the use of a pre-insertion resistor solves both problems.

III. SIMULATION MODEL

The model used for mathematical calculations is shown in Fig. 3, where the cable is represented by its equivalent pi-model and the shunt reactor by an inductor in series with a resistor.

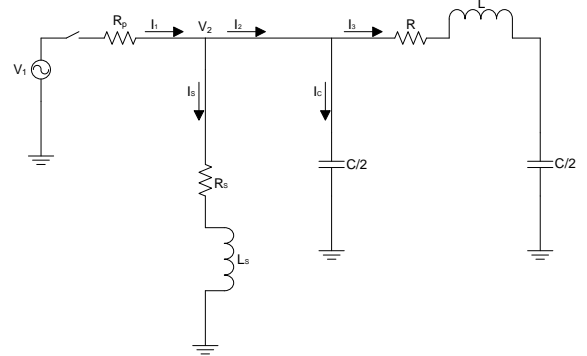

Fig. 3 System model: V_1 -Voltage Source; R_p -Pre-insertion resistor; R_s -Shunt reactor resistor; L_s -Shunt reactor inductor; R -Cable's series resistor; L -Cable's series inductor; C -Cable's shunt capacitor

If there is no pre-insertion resistor ($R_p=0$), the current I_1 is the sum of I_s , I_c and I_3 , whose mathematical solution can be easily found in a circuits theory book. But when using a pre-insertion resistor the mathematical resolution is much more complicated, as the system is described by more complex differential equations (1).

$$\left\{ \begin{array}{l} V_2 = L_s \frac{dI_s}{dt} + R_s I_s \\ V_2 = \frac{1}{C} \int I_c dt \\ V_2 = R \cdot I_3 + L \frac{dI_3}{dt} + \frac{1}{C} \int I_3 dt \\ I_1 = I_2 + I_3 + I_c \\ V_2 = V_1 \cos(\omega t) - R_p \cdot I_1 \end{array} \right. \quad (1)$$

If V_2 is known the currents are calculated on the same way as when $R_p=0$. So the objective is to calculate V_2 , but the system is a too complex *Differential Algebraic Equations System*, and it is not possible to solve it analytically in the time domain [8].

Instead of using a numerical method to solve the system, it was decided to do a Laplace transform and pass the equations to the frequency domain. Due to the complexity of the equations, it is advisable to use partial fraction before do the inverse Laplace transform. In appendix is a part of the equation solution on the frequency domain.

Usually the degree of reactive power compensation of a cable line is between 60% and 80% [9], but in this paper in order to have a simplified case, it is considered that the shunt reactor compensates all the reactive power generated by the cable. For another degree of reactive power compensation the

equations are the same just changing the values of L_s and R_s .

IV. CALCULATION OF THE PRE-INSERTION RESISTOR VALUE

A pre-insertion resistor consists of resistor blocks that are connected in parallel with the circuit breaker's breaking chamber, and close the circuit 8-12ms before the arcing contacts [10] (in this paper the time considered is 10ms).

The choice of the pre-insertion resistor can not be a random process. If it is too small the DC component will not be all damped within the first 10ms, if it is too large it would be almost like having an open circuit and so when the pre-insertion resistor is by-passed it would be like the shunt reactor was being connected for the first time, and it will have a DC component with a value similar to the one it would have if no pre-insertion resistor was used. This is illustrated in Fig. 4, where are the simulations for the three different situations: Pre-insertion resistor too large, too small or not used.

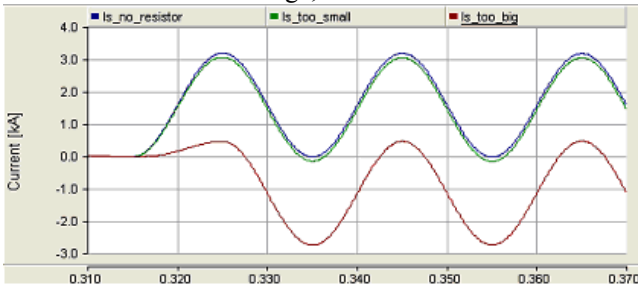

Fig. 4 Current in the shunt reactor when no pre-insertion resistor is used, when it is too large and when it is too small

To calculate the pre-insertion resistor value, there are two techniques that can be used:

- Use the Energy Equations;
- Use the Differential Equations;

A. Energy Equations

This method is based on some approximations and it is not 100% accurate, but by other hand it is much easier and faster than solve the differential equations.

The energy equations method calculates the energy that should be dissipated on the pre-insertion resistor, in order to damp the DC component (2):

$$W = \frac{1}{2} L_s (I_s^{DC})^2 \quad (2)$$

The energy dissipated in the pre-insertion resistor is calculated by the integral on (3), whose limits are the time during which the pre-insertion resistor is connected, 0s to 10ms:

$$W = \int P dt \Leftrightarrow \int_0^{0.01} R_p I_1^2 dt \quad (3)$$

The objective is to calculate R_p , but since I_1 and I_s^{DC} depend on the connection moment their values are unknown. But, as for a situation of 100% reactive power compensation the AC components of the shunt's and cable's currents cancel each other out, the current I_1 is equal to I_s^{DC} in the connection moment, and both should be zero after 10ms.

Considering that the current I_1 decreases linearly (this is an

approximation, but as R_p is large the error is small), and neglecting R_s (it is dozens of times smaller than R_p), (3) can be substituted by (4), and the value of R_p is calculated using (6).

$$W = 0.01 R_p \left(\frac{I_1(0)}{2} \right)^2 \quad (4)$$

$$0.01 R_p \left(\frac{I_1(0)}{2} \right)^2 = \frac{1}{2} L_s (I_s^{DC})^2 \Leftrightarrow 0.01 R_p \left(\frac{1}{2} \right)^2 = \frac{1}{2} L_s \quad (5)$$

$$R_p = \frac{2L_s}{0.01} \quad (6)$$

Because of the simplifications made this method is not very accurate, and while for a situation of maximum DC component the error is not very big, when the DC component is reduced the error increases.

B. Differential Equations

Unlikely in previous method, in the method based on the differential equations no simplifications are made. The system is modelled by (1), and the equations presented in appendix are used in the calculations.

To calculate the value of R_p a Matlab code was written. It consists on an iterative process, where in each iteration R_p is increased, until it reaches a value for which the DC component is damped in 10ms.

To verify that the DC component was damped, it is calculated the peak value of I_s 10ms after the connection. To that value be equal to the amplitude of the AC current, it is required to have the DC component equal to zero, so if the calculated value is equal to (7) plus a small tolerance the iterative process stops.

$$I_s^{peak} = \frac{V_2}{\sqrt{R_s^2 + (\omega L_s)^2}} \quad (7)$$

The value of the pre-insertion resistor depends on the initial value of the DC component, but the DC component depends of the connection moment, which is unknown. So it was decided to solve the equations for the worst case scenario, maximum DC component, to that case the calculated value of R_p is ideal, to the other cases there is a small error.

V. SIMULATIONS

A. Simulation settings

Two types of simulations are presented ahead, a first group for a single-phase circuit and a second one where the reasoning is generalized for a three-phase system. In both cases, the pre-insertion resistor is calculated using the differential equations.

Simulations are performed in EMTDC/PSCAD, using the frequency dependent phase model to simulate the cable, as it is at the present the more accurate method of simulate cables [11].

To use the frequency dependent phase model on PSCAD, it is required to draw the several layers of the cable and give the

cables geometry, and using that information PSCAD calculates the cable characteristics (resistance, capacitance, etc...). As the manufacturer datasheet does not provide all the details that the software requires, there is a difference between the data provided by the datasheet and the one used by PSCAD to simulate the cable. Also, some of the parameters depend on the layout conditions, some examples are the cable's inductance and resistance changing with the proximity of other conductors [5]. As the efficiency of the pre-insertion resistor will be tested using PSCAD simulations, in the Matlab code used to calculate the resistor value it should be used PSCAD data instead of the one from the manufacturer.

The Matlab code was written using an equivalent pi-model, therefore the electrical parameters of the cable (resistance, inductance and capacitance to the ground) must be known, and the cable is a 50km, 400kV single-core cable from SAGEM [11].

The value of the shunt reactor inductance is related with the cable's capacitance and desired degree of compensation of the reactive power generated by the cable. The value of the shunt reactor resistance was considered proportional to the inductance and the relation used was 0.2328Ω per 1H [13]. In reality the relation between these two values is non-linear, but due to the difficulty in obtain trustful values it was decided to use the above-mentioned relation.

The cable is considered to be connected to an ideal voltage source of 400kV if single-phase, and 230kV if three-phase.

B. Single-phase system

The system used in the simulations is equal to the one of Fig. 3, with the difference that the cable is not modelled by its pi-model. The parameters of the simulated system are: $C/2=3.929\mu\text{F}$; $L=25.7\text{mH}$; $R=15.05\Omega$; $L_S=1.29\text{H}$; $R_S=0.3003\Omega$.

To calculate the value of the pre-insertion resistor it was used the method of the differential equations. Using this method it was obtained the value of 295Ω for R_p , if instead of using differential equations (6) was used, the value of R_p would be 258Ω , what gives an error of 12.5%.

As explained before the DC component and the value of the switching overvoltage depend of the voltage value in the connection moment. As the cable is not ideal, it has impedance, when there is an overvoltage in its end there is also an overcurrent.

In Fig. 5 is shown the current through the circuit breaker and the voltage at the cable's end for a maximum DC component (no switching overvoltage), whereas in Fig. 6 are shown the current and the voltage for a maximum switching overvoltage (no DC component). Both figures are for a situation where no pre-insertion resistor is used.

If the circuit breaker has a pre-insertion resistor there are substantial differences in the transients. Fig. 7 shows the current I_1 when using a circuit breaker with pre-insertion

resistor and connected for a situation of maximum DC component. As can be observed the DC component is totally damped in 10ms.

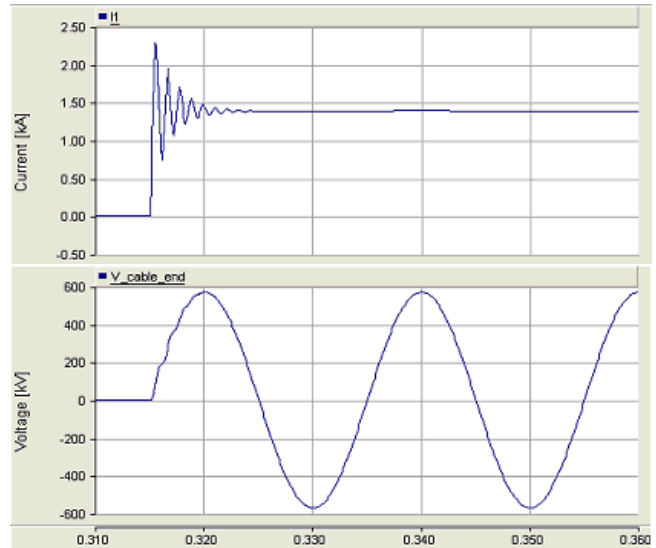

Fig. 5 Current on the circuit breaker and voltage on the end of the cable for a situation of maximum DC component

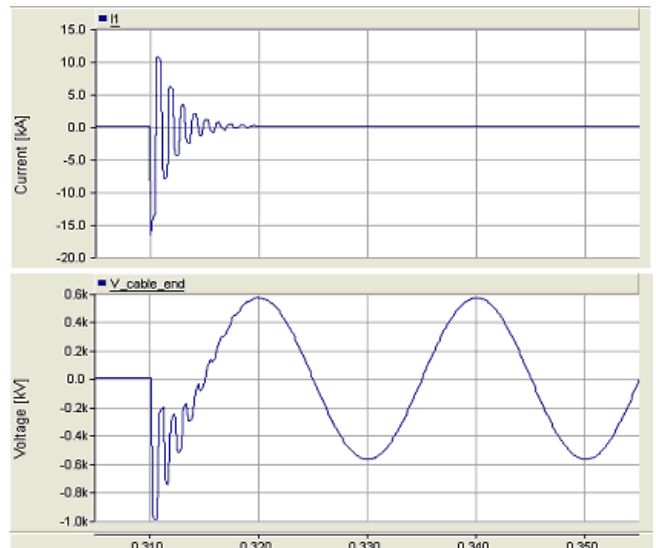

Fig. 6 Current in the circuit breaker and voltage on the end of the cable for a situation of maximum switching overvoltage

The method used to calculate the pre-insertion resistor value was made for the worst case scenario (maximum DC component), and therefore for the other situations the DC component is not entirely damped in 10ms, and something unexpected happens. If the shunt reactor was connected when the voltage is at a peak value and no pre-insertion resistor is used there would not exist DC component in the system (Fig. 6), but when using the pre-insertion resistor that is the situation for which the DC component is larger (see current on Fig. 8 and compare it with the current on Fig. 6).

But even in this case the DC component is not very big when compared with the cases where the pre-insertion resistor is not used. The maximum value of the DC component when using pre-insertion resistor is 8.5 times smaller than the

maximum value when it is not used, and the switching overvoltage is much attenuated, with no pre-insertion resistor the peak voltage was 1.75pu but when using it is 1.12pu.

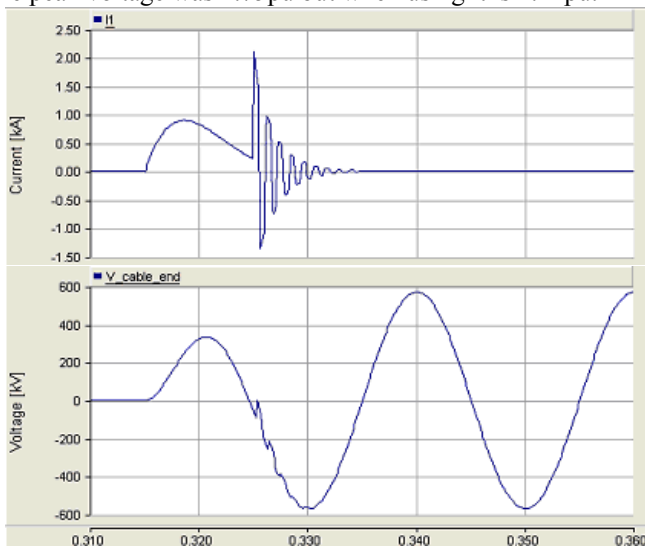

Fig. 7 Current on the circuit breaker and voltage on the end of the cable for a situation of maximum DC component, using a pre-insertion resistor

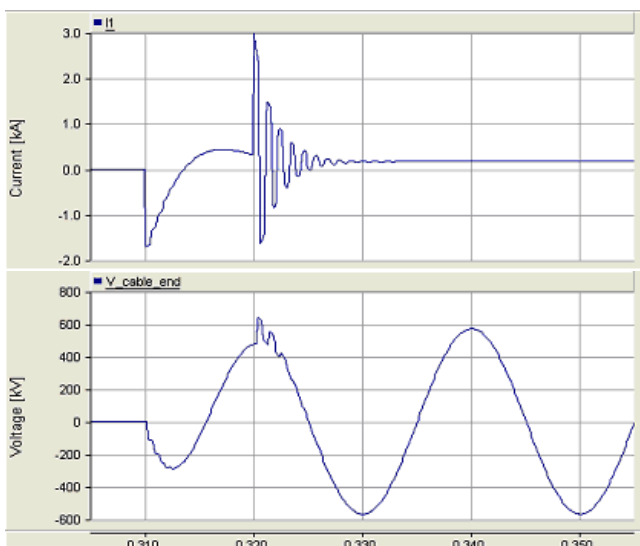

Fig. 8 Current in the circuit breaker and voltage on the end of the cable for a situation of maximum switching overvoltage, using a pre-insertion resistor

The results indicate that the best solution is to connect the cable when the voltage is zero. In this situation the pre-insertion resistor damps the DC component in 10ms and therefore there is not possible to have zero-missing phenomenon, as the cable is connected when the voltage is zero there is also no switching overvoltage.

But even if the circuit breaker is closed on another moment, the use of the pre-insertion resistor strongly attenuate the DC component and the switching overvoltages.

All the simulations presented are for situations where all the reactive power generated by the cable is compensated by the shunt reactor, but even for different compensation levels the behaviour is the same, with the difference that the current also has an AC component.

Another possible situation is to have a pre-insertion resistor with a non-ideal value. In that case the DC component will not be zero after 10ms, but it will be always lower than a given maximum. The value of the DC component after 10ms for different pre-insertion resistor values is shown in Fig. 9.

The curve in Fig. 9 is non linear, and to values of pre-insertion resistor close to the ideal one the DC component is very small. If for example the value of the pre-insertion resistor was calculated using the energy equations instead of the differential equations, the initial DC current would be about 100A, what is 14 times inferior to the value of the initial DC component when no pre-insertion resistor is used (1400A). So it is concluded that the method of the energy equations is a good method that can be used to obtain a first approximation of the final resistor value.

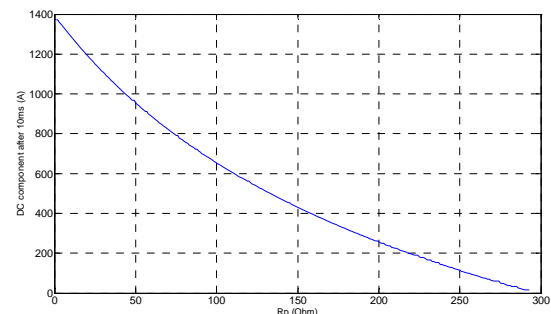

Fig. 9 Initial value of the DC component after bypass the pre-insertion resistor for different R_p values

C. Three-phases system

For a three-phase system the cable used for the single-phase system, is used again.

The shunt reactor is connected in star with a grounded neutral, and the values of the inductance (L_S) and resistance (R_S) are equal to the ones of a single-phase system. There is a small variation on the cable's inductance because of the proximity of the other cables, but it is too small to make any substantial difference on the cables behaviour.

Two different types of circuit breakers can be used. A first type that closes/opens all the phases at the same time, or a second type called single-pole mode, where the three phases can close on different moments [10] (this system is very usual for autoreclose on OHL).

Since the phases are closed/opened sequentially, having a circuit breaker operating in single-pole mode is like have three different single-phase breakers. In Fig. 10 is an example of the closing of circuit breaker operating on this mode, the phase R closes at 0ms, the phase T 3.3ms later and phase S 6.7ms after phase R.

Obviously that the method used to close the circuit breaker affects the system behaviour, on Fig. 11 and Fig. 12 are two examples (Phase R-Blue, Phase S-Green, Phase T-Red). On the first all the phases close when the voltage is zero in the particular phase, and therefore the DC component is maximum and the switching transient minimum on all the

phases. In the second figure all the three phases are closed at the same time, when phase R has maximum DC component, and therefore the other phases have lower DC components but also larger switching overvoltages.

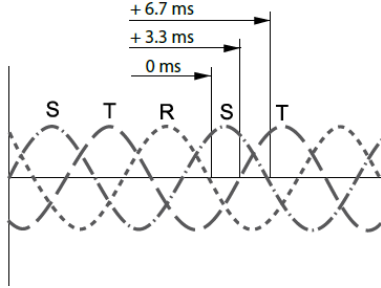

Fig. 10 Example of a single-pole mode operation [10]

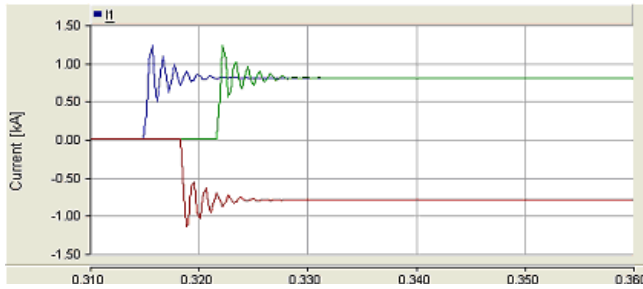

Fig. 11 Circuit Breaker operating in single-pole mode

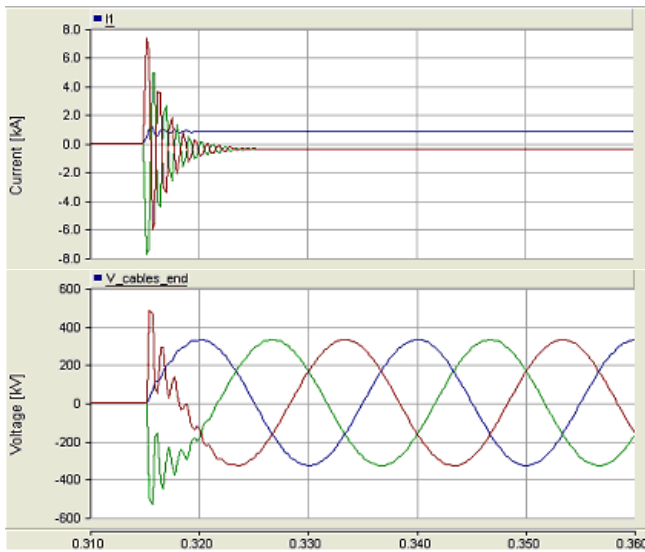

Fig. 12 Circuit Breaker closing the three phases at the same time

Using the Matlab code to calculate the value of the pre-insertion resistor is obtained a value of 295Ω for R_p .

In Fig. 13 is a simulation for a circuit breaker operating in single-pole mode. As the behaviour of a three-phase system with a circuit breaker operating in single-pole mode is very similar to have three different single-phase systems, the reasoning is equal to the one made on the previous section.

As it was explained before in single-phase systems section, the Matlab code was written for a situation of maximum DC component, so if the three phases are connected at the same time, it is not possible to completely cancel the DC component on all the phases. In Fig. 14 this can be confirmed, the simulation is the same of Fig. 12 but now using a pre-insertion

resistor. The DC component of phase R is completely damped, but it still remains some small DC component on the other two phases. In all phases the switching overvoltage is attenuated, confirming the efficiency of use a pre-insertion resistor.

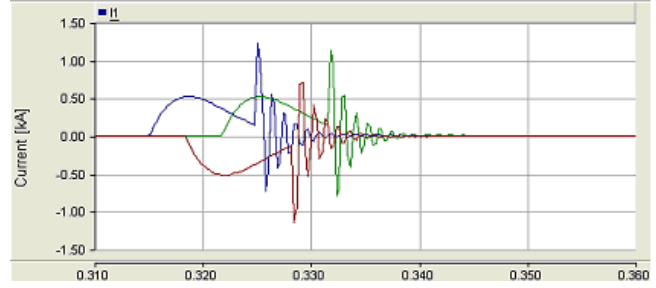

Fig. 13 Simulation of the cable energizing, for a circuit breaker operating in single-pole mode and using pre-insertion resistor

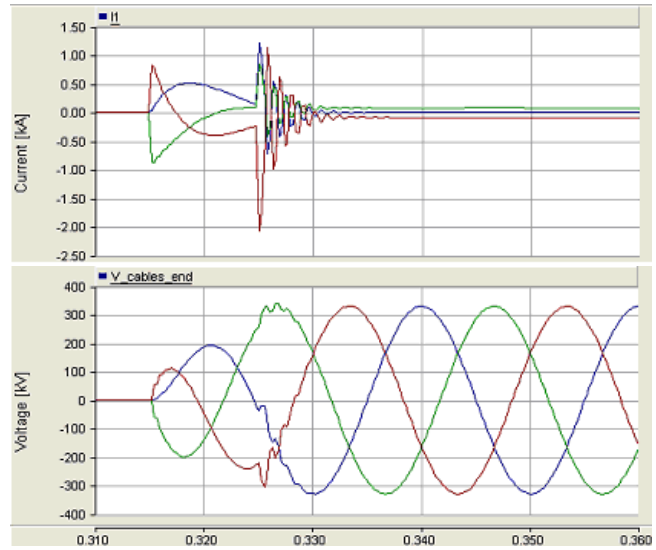

Fig. 14 Current in the circuit breaker and voltage on the end of the cable for a situation of maximum switching overvoltage, using a pre-insertion resistor

VI. CONCLUSIONS

Switching overvoltages and zero-missing phenomenon are non-desirable phenomena that can happen when energizing cable lines.

The use of a pre-insertion resistor in the circuit breaker is an effective countermeasure to both overvoltage problems and existence of DC-component in the current of the circuit breaker. Furthermore using a pre-insertion resistor does not introduce any non-desirable effects on the system.

As the value of the pre-insertion resistor depends of the closing moment of the circuit breaker it is not possible to have an ideal value for all possible cases. But independently of the closing moment the use of the pre-insertion resistor always substantially reduces the DC component responsible for zero-missing phenomenon, and the switching overvoltages.

It is also concluded that if it is possible to control the closing moment of the circuit breaker and it can operates in single-pole mode, it is possible to completely avoid both phenomenon. For that it is required to use a pre-insertion resistor with an accurate value that must be precisely calculated, and use a circuit breaker closing its phases

independently when the voltage in each one of them is crossing zero.

VII. APPENDIX

Equation required to calculate V_2 , having this variable the currents in the system are easily obtained.

$$V_1 = V_2 \left(\frac{A}{N} + \frac{B(1) + B(2)}{N} \right) \quad (8)$$

$$A = s^5 LL_s C \omega^2 + s^4 \left(L_s RC \omega^2 + LCR_s \omega^2 \right) + s^3 \left(L_s \omega^2 + RCR_s \omega^2 + LL_s C \omega^4 \right) + s^2 \left(L_s RC \omega^4 + LCR_s \omega^4 + R_s \omega^2 \right) + s \left(L_s \omega^4 + RCR_s \omega^4 \right) + R_s \omega^4 \quad (9)$$

$$B(1) = s^4 LC \omega^2 + s^3 RC \omega^2 + s^2 \left(\omega^2 + LC \omega^4 \right) + s RC \omega^4 + \omega^4 \quad (10)$$

$$B(2) = s^6 LC^2 L_s \omega^2 + s^5 \left(LC^2 R_s \omega^2 + RL_s C^2 \omega^2 \right) + s^4 \left(RR_s C^2 \omega^2 + 2CL_s \omega^2 + LL_s C^2 \omega^4 \right) + s^3 \left(2CR_s \omega^2 + LR_s C^2 \omega^4 + RL_s C^2 \omega^4 \right) + s^2 \left(RR_s C^2 \omega^4 + 2CL_s \omega^4 \right) + s 2R_s C \omega^4 \quad (11)$$

$$N = s^3 LL_s C \omega^3 + s^2 \left(L_s RC \omega^3 + LCR_s \omega^3 \right) + s \left(L_s \omega^3 + RCR_s \omega^3 \right) + R_s \omega^3 \quad (12)$$

VIII. REFERENCES

- [1] I. U. S. Hutter, M. Krepela, B. F. Grčić, F. Jakl, "Transients Due to Switching of 400kV Shunt Reactor"
- [2] R. Bartnikas, K. D. Srivastava. "Power and Communication Cables: Theory and Applications", IEEE Press: Power Engineering Series, 2000
- [3] GE Power Systems Energy Consulting, "Connecticut Cable Transient and Harmonics Study for Phase 2: Final Report", November 2003
- [4] Tokyo Electric Power Company, "Joint Feasibility Study on the 400kV Cable Line Endrup-Idomlund: Final Report", April 2008
- [5] J. F. Borges da Silva, "Electrotecnia Teórica - 1ª Parte", 2nd edition, AEIST, 1995
- [6] J. H. R. Enslin, Yi Hu, R. A. Wakefield, "System Considerations and Impacts of AC Cable Networks on Weak High Voltage Transmission Networks"
- [7] Y.H. Fu, G. C. Damstra, "Switching Transients During Energizing capacitive Load by a Vacuum Circuit Breaker", *IEEE Transactions on Electrical Insulation*, vol. 28 No.4, pp. 657-666, August 1993
- [8] S. Schulz, "Four Lectures on Differential-Algebraic Equations", Humboldt Universität zu Berlin, June 2003
- [9] M. V. Escudero, M. Redfern, "Effects of transmission line construction on resonance in shunt compensated EHV lines", *IPST05-109*, June 2005
- [10] ABB, "Live Tank Circuit Breakers: Buyer's Guide", 4th edition, May 2008
- [11] B. Gustavsen, A. Morched, M. Tartibi, "A universal model for accurate calculation of electromagnetic transients on overhead lines and

underground cables," *IEEE Transactions on Power Delivery*, 14(3), p.1032–1038, July 1999.

[12] SAGEM, "1200mm² Al XLPE 400kV datasheet"

[13] C.L. Bak, W. Wiechowski, K. Søgaard, S. D. Mikkelsen, "Analysis and simulation of switching surge generation when disconnecting a combined 400kV cable/overhead line with shunt reactor", 2007

IX. BIOGRAPHIES

Filipe Faria da Silva was born in Portugal in 1985 and received is B.S.E. and M.S.E. in Electrical and Computers Engineering in 2008 from Instituto Superior Técnico (IST), Portugal.

He is currently working for the Danish TSO (Energinet.dk) and doing a PhD in the Institute of Energy Technology of Aalborg University, where he studies High-Voltage Transmissions Systems with Underground Cables.

Claus Leth Bak was born in Århus in Denmark, on April 13, 1965. He graduated from High School in Århus and studied at the Engineering College in Århus, where he received the B.Sc. with honors in Electrical Power Engineering in 1992. He pursued the M.Sc. in Electrical Power Engineering with specialization in High Voltage Engineering at the Institute of Energy Technology (IET) at Aalborg University (AAU), which he received in 1994. After his studies he worked with Electric power transmission and substations with specializations within the area of power system protection at the NV Net transmission company. In 1999 he got employed as an assistant professor at IET-AAU, where he is holding an associate professor position today. His main research areas include corona phenomena on overhead lines, power system transient simulations and power system protection. He is the author/coauthor of app. 30 publications and IEEE Senior Member.

Unnur Stella Gudmundsdottir was born in Reykjavik in Iceland, on February 15, 1980. She graduated from High School in Reykjavik, Iceland, and received her B.Sc. degree in Electrical and Computer engineering in 2003 from The University of Iceland. She studied for the M.Sc. in Electric Power Systems at the institute of Energy Technology, Aalborg University in Denmark and received her degree in 2007 with speciality in state estimation and observability analysis. She received an honours prise for her M.Sc. final thesis. Currently she is studying PhD. at the Institute of Energy Technology, Aalborg University, in cooperation with the Danish Transmission system operator (Energinet.dk), where she also supervises students pursuing their M.Sc. degree in energy technology. Her PhD studies are focused on modelling of underground cable system at the transmission level.

Wojciech Wiechowski received the M.Sc. degree from Warsaw University of Technology in 2001 and the Ph.D. degree from Aalborg University, Denmark in 2006. From 2001 to 2002 he worked for HVDC SwePol Link as a Technical Executor. In the period from 2002 to 2006 he was with the Institute of Energy Technology, Aalborg University, first as a PhD Student and later as an Assistant Professor. Since 2006 he has been employed in the Planning Department of the Danish TSO Energinet.dk. His current responsibilities include various power system analysis tasks related to the planning of the transmission network with extensive use of long AC cable lines and wind power generation. He is a Senior Member of IEEE.

Martin Randrup Knardrupgård was born in Copenhagen 1978, and received his M.Sc. E.E. 2003 from the Technical University of Denmark.

From 2003 to 2006 he worked for the Swedish electric power company Sydkraft/E.ON where he was involved in the planning of the regional transmission grid in southern Sweden. Since 2006 he joined the planning department of the Danish TSO Energinet.dk. His current responsibilities include long term planning of the Danish transmission grid, especially interconnections with UCTE and Nordel, aspects and feasibility studies of 400 kV cabling and the connection of the offshore wind farms Horns Reef 2, Rødsand 2 and Anholt.