



Aalborg Universitet

AALBORG UNIVERSITY
DENMARK

A novel modulation for Adaptive Control Issue-Based Optimization Techniques

Balloon Effect

Abubakr, Hussein; Guerrero, Josep M.; Vasquez, Juan C.; Mohamed, Tarek Hassan

Published in:

22nd International Middle East Power Systems Conference, MEPCON 2021 - Proceedings

DOI (link to publication from Publisher):

[10.1109/MEPCON50283.2021.9686253](https://doi.org/10.1109/MEPCON50283.2021.9686253)

Publication date:

2021

Document Version

Early version, also known as pre-print

[Link to publication from Aalborg University](#)

Citation for published version (APA):

Abubakr, H., Guerrero, J. M., Vasquez, J. C., & Mohamed, T. H. (2021). A novel modulation for Adaptive Control Issue-Based Optimization Techniques: Balloon Effect. In *22nd International Middle East Power Systems Conference, MEPCON 2021 - Proceedings* (pp. 412-415). IEEE Signal Processing Society. <https://doi.org/10.1109/MEPCON50283.2021.9686253>

General rights

Copyright and moral rights for the publications made accessible in the public portal are retained by the authors and/or other copyright owners and it is a condition of accessing publications that users recognise and abide by the legal requirements associated with these rights.

- Users may download and print one copy of any publication from the public portal for the purpose of private study or research.
- You may not further distribute the material or use it for any profit-making activity or commercial gain
- You may freely distribute the URL identifying the publication in the public portal -

Take down policy

If you believe that this document breaches copyright please contact us at vbn@aub.aau.dk providing details, and we will remove access to the work immediately and investigate your claim.

A novel modulation for Adaptive Control Issue-Based Optimization Techniques: Balloon Effect

Hussein Abubakr^{1, 2*}, Josep M. Guerrero¹, Juan C. Vasquez¹, Tarek Hassan Mohamed²

¹Center for Research on Microgrids (CROM), AAU Energy, Aalborg University, 9220 Aalborg, Denmark.

²Department of Electrical Engineering, Faculty of Energy Engineering, Aswan University, Aswan 81528, Egypt.

*Corresponding Author: Hussein Abubakr [e-mail: haha@energy.aau.dk]

Abstract— this paper provides a comprehensive discussion of the balloon effect method, which is a new tool for optimization techniques. There exist two broad categories of algorithms called metaheuristics and heuristics that are: evolutionary algorithms and swarm intelligence. The performance of these algorithms relies heavily on the parameters used which need to be broadly tuned during computational experiments to attain eminent performance. The balloon effect idea can assist the optimization algorithms to solve the discrete, constrained, and unconstrained issues and to be more sensitive and trackable during any sudden disturbances. Recently, it has been proposed for adaptively tuning the system parameters for achieving the optimal solution. The main objective of this work is to discuss the idea of the balloon effect and how it can be used for various power system applications. The authors believe that this work shall be helpful for exploring the balloon effect potential on the general audience working for the optimization in different aspects.

Keywords— *balloon effect, optimization techniques, adaptive control, power systems, load frequency control.*

I. INTRODUCTION

Recently, some attempts have been made for optimization approaches to tune the controllers' gains because of their ability to treat disturbances and uncertainties. Sharing optimization techniques were used for on-line tuning manner of adaptive LFC parameters as in [1], [2], and tuning the PID controller in an off-line manner as in [3], [4].

The weak point of these approaches is their complex structure. Two steps are considered for adjusting the control unit: the optimizer is utilized first to tune the parameters of neural network or fuzzy; the next step consists of the neural or fuzzy approach, which is used to adjust the LFC controller's gain, as shown in Fig. 1.

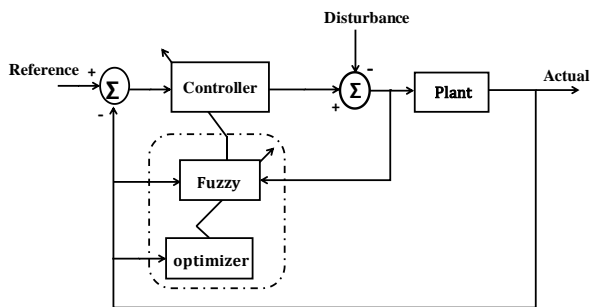

Fig. 1. Two-part adaptive control block diagram.

To simplify and minimize system complexity, soft computing methods are applied directly to tune the controller gains, resulting in mimicking the computation time as shown in Fig. 2, which is an important factor in evaluating the controller [1], [5], [6].

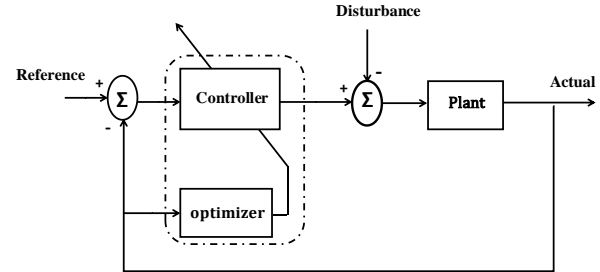

Fig. 2. One-part adaptive control block diagram.

For further clarifications, the Electro-Search optimizer (ESO) has been implemented to enable the tuning of the LFC controller in an online manner for single and multi-area microgrids MGs. However, the optimizer relies only on the frequency deviation as an input signal, and thus reduces the control efficiency in the face of uncertainty or changes in the parameter as well as the communication delay due to signal transmission between the area control centers for interconnected multi-area MGs. Several research works have shed light on the above-mentioned issue in [7], [8].

This paper gives the shed on adding balloon effect (BE) to standard optimizers to raise its sensitivity based on the variations that affect the system, such as the event of load disturbances and changes in the parameters. It represents the variations effect on the open-loop transfer function at a given time, which is comparable to the air effect on the volume of the balloon.

II. GENERAL IDEA OF BALLOON EFFECT FOR OPTIMIZATION TECHNIQUES

The concept of BE was primarily introduced by M. Abdelhamid and Tarek H. M. in [9] to assist the Jaya algorithm to be more sensitive and trackable which is used for controlling the position of a DC motor in an adaptive manner.

Balloon Effect (BE) is designed to enable the algorithms to adjust the controller parameters individually and raise its capability to accord with the system issues such as uncertainty and load disturbance. BE has been suggested for the first time for LFC applications in [10], Plug-in electric vehicles PEVs applications [11] to tune the integral controller gain, and also be applied to control the position of a cart moved by a DC motor in [12], [13]. The objective function relies solely on the controller's gain value [1], [2], [10]. This means that there is no direct changes that can affect the objective function, resulting in weakness in optimizer reaction towards system issues. BE was designed to address this weak point. It carries the meaning of how the system variations can affect the objective function value and optimizer performance. Fig. 3 shows a mini-system scheme used for any optimizers supported by BE in an adaptive control manner.

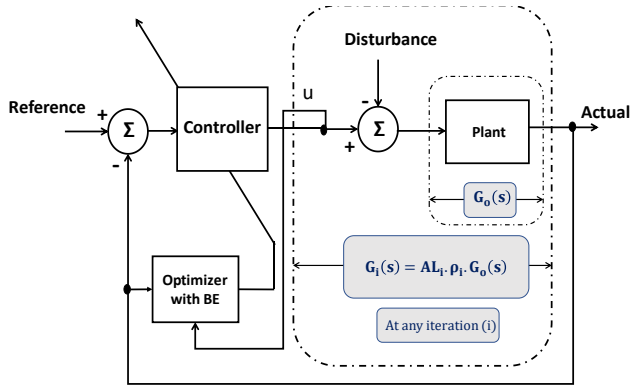

Fig. 3. Reduced system model supported by balloon effect in an adaptive manner.

The idea of BE is discussed in Fig. 4. It is observed at any iteration- i , the output $Y_i(s)$ and input $U_i(s)$ are fed to the optimizer to compute the actual transfer function as:

$$G_i(s) = \frac{Y_i(s)}{U_i(s)} \quad (1)$$

In addition, $G_i(s)$ can be described using its old value $G_{i-1}(s)$ as:

$$G_i(s) = AL_i \cdot G_{i-1}(s) \quad (2)$$

AL is again, and $G_{i-1}(s)$ can be expressed using the nominal transfer function $G_o(s)$ as:

$$G_{i-1}(s) = \rho_i \cdot G_o(s) \quad (3)$$

where

$$\rho_i = \prod_{n=1}^{i-1} AL_n$$

So, from (2) and (3) it can be noted that:

$$G_i(s) = AL_i \cdot \rho_i \cdot G_o(s) \quad (4)$$

The expression of ‘Balloon Effect’ is demonstrated by this fact: system difficulties impact such as disturbance and uncertainty on $G_i(s)$ is similar to the effect of income/outcome air on the balloon size. As a result at iteration (i), the objective function will rely on the gain’s values and variations in $G_i(s)$.

The steps of the standard optimizer algorithm are described in Fig. 5. It is observed that the candidate solutions move toward the optimal solution and seek to keep away from the worst solution.

After each iteration (i), the best and worst values of the proposed candidate solution were calculated by making a comparison between the new solution with the old one. This process will be repeated to reach the optimal value or to finish the iterations threshold.

In the proposed technique, for any plant, the controller is designed to make the total closed-loop system in the standard second-order system (directly or using system model reduction):

$$\Delta f = \frac{\omega_n^2}{S^2 + 2\zeta\omega_n S + \omega_n^2} \quad (5)$$

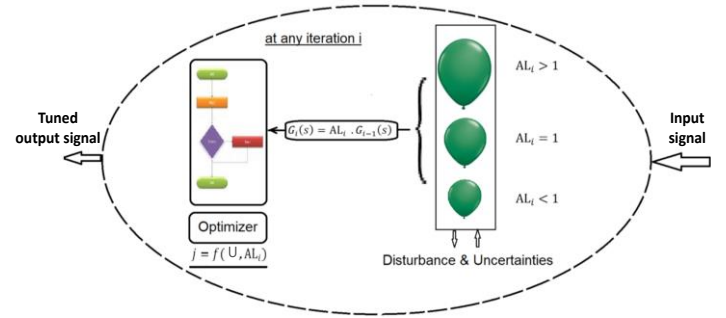

Where, U is the controller gain parameters.

Fig. 4. Balloon effect concept for any optimizers at iteration (i).

Therefore, classical optimizers that are used to tune the gains of the adaptive controller, the objective function can be chosen as:

$$J = \min \sum T_r^2 + T_s^2 + M_p^2 \quad (6)$$

Where T_r , T_s and M_p are functions in ω_n which can be represented as a function in $G_o(s)$, as a result of this situation, any change of system parameters or system disturbance will not make any effect on the objective function or the total controller consequently.

But in the case of adding BE to the optimization method, according to (4), (5), and (6): at any iteration $\omega_{n,i}$ will be functioning in both of $(G_o(s), AL_i \cdot \rho_i)$, so the system variation will appear in $\omega_{n,i}$ and the object function J and this will increase the efficiency of the suggested adaptive controller.

III. WHY BALLOON EFFECT MODULATION?

- Before Balloon Effect can assist optimization algorithms to solve discrete, constrained, and unconstrained issues and to be more sensitive and traceable during any sudden disturbances.
- The concept of BE concept is entirely intended to recognize the I/O signals of the plant to define the actual transfer function at each iteration (i).
- The objective function with BE will strongly be affected by any changes in the system such as parameter variations and load perturbations.

IV. VALIDATION AND SIMULATION

In general, the main tool for the efficiency measurement tool of the optimization algorithm is how fast it takes to reach the optimum value. Comparative performance analysis for balloon effect-based HHO with classic ESO, PSO, and HHO is described in Fig. 6. A similar quantity of candidate solutions and iterations have been applied for a Matyas test function to solve the optimization issues. A total of 50 independent running processes, No. of decision variables=5, and lower and upper bound = [0, +10] are performed for all algorithms.

Fig. 6 illustrates the optimal value of the J_{min} against the number of J-evaluation using Matyas test function. It was noticed that the suggested modulation ‘balloon effect’ helps the classic HHO optimizer to converge rapidly than other classic ones.

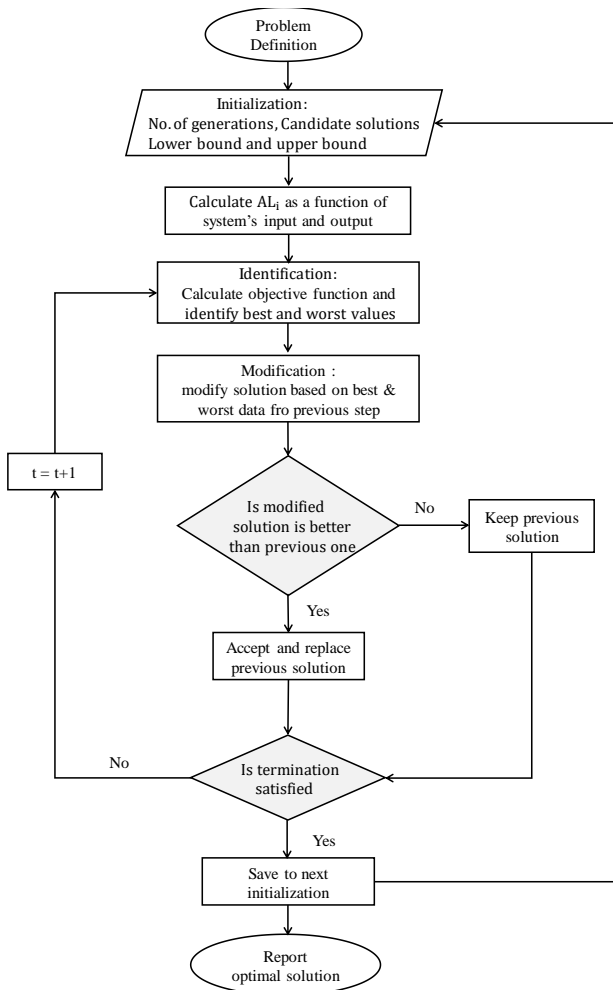

Fig. 5. General Flow chart for any optimizer with the help of balloon effect BE.

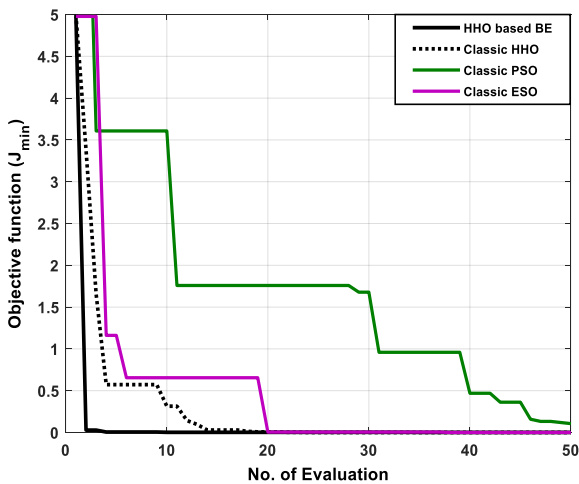
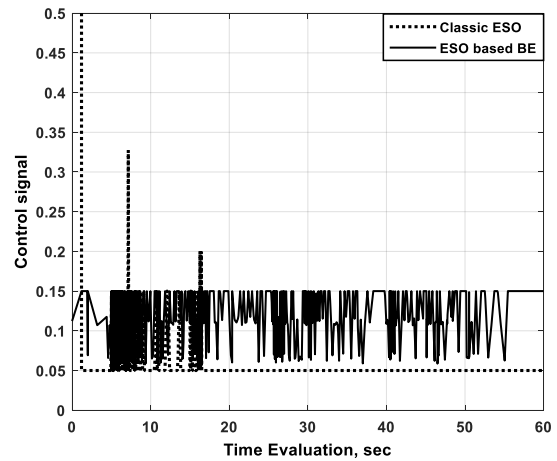

Fig. 6. Speed convergence characteristics of classic PSO, ESO, HHO, and HHO based BE for a sphere benchmark test function using Matyas test function.

In Fig. 7, the output control signals (for application presented in [10]) of a) ESO (electro-search); b) PSO (particle swarm); c) HHO (Harris Hawks) with BE are good compared to the classic ones due to their action to deal with any external disturbances and parameter uncertainties at any moment. This means that it exerted more efforts to improve the overall system response during the simulation period.

A 20 MW isolated MG is proposed to examine the new modulation tool “BE” using Matlab (m-file + Simulink) environment for simulations. System nominal parameters are taken from [10]. The system is tested under the effect of step load perturbation (35% changes in ΔP_L) at 1 s. A comparison is made to the system with classic PSO, ESO, HHO, and system with HHO based BE. Fig. 8 shows the frequency deviation for the system with fixed integral controller and other proposed ones. It is clear that the system with HHO in presence of BE gives lower oscillations and higher performance (less max. overshoot and settling time) as compared to other controllers.



(a) with ESO

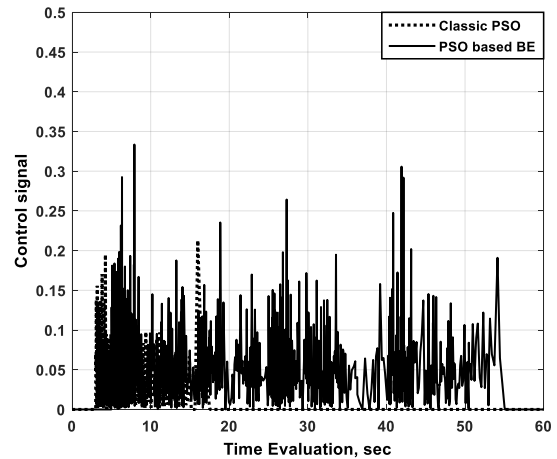

(a) with PSO

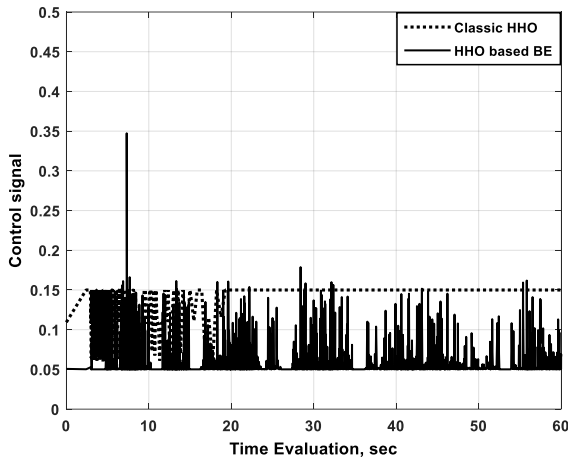

(a) with HHO

Fig. 7. The output control signal for classic ESO, PSO, and HHO optimizers with/without the effect of balloon BE.

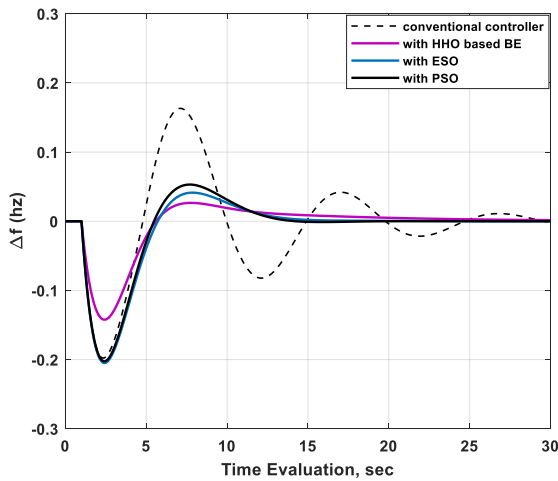

Fig. 8. System frequency response for conventional controller, classic ESO, PSO and HHO based BE.

V. CONCLUSION

In this paper, the author discussed a novel modulation called balloon effect BE that could help the internal characteristics of the optimization algorithms to be more traceable. Recently, this method has been validated and tested with several classic algorithms such as Jaya, ESO, PSO, WCA, and HHO to increase their sensitivity to see how well it responds to dealing with any sudden disturbance within the system. This paper does not aim to prove that one algorithm is "better" than the other. Instead, the purpose of this paper is to increase the awareness of using balloon effect modulation in the field of optimization.

So far, the BE still hasn't been applied sufficiently to solve more real-life issues. Therefore, it will be very interesting to see the impact of BE in solving optimization problems in the real world. The authors think that this paper sheds the light on the advantages of the balloon effect, which will increase its use in the future.

REFERENCES

- [1] T. H. Mohamed, H. Abubakr, M. M. Hussein, and G. S. Salman, "Adaptive Load Frequency Control in Power Systems Using Optimization Techniques," in *AI and Learning Systems - Industrial Applications and Future Directions*, IntechOpen, 2021, pp. 201–215.
- [2] T. Mohamed, H. Abubakr, M. M. Hussein, and G. Shabib, "Load Frequency Controller Based on Particle Swarm Optimization for Isolated Microgrid System," *Int. J. Appl. Energy Syst.*, vol. 1, no. 2, pp. 69–75, Jul. 2019.
- [3] S. M. Nosratabadi, M. Bornapour, and M. A. Gharaei, "Grasshopper optimization algorithm for optimal load frequency control considering Predictive Functional Modified PID controller in restructured multi-resource multi-area power system with Redox Flow Battery units," *Control Eng. Pract.*, vol. 89, pp. 204–227, Aug. 2019.
- [4] M. Bošković, T. B. Šekara, and M. R. Rapaić, "Novel tuning rules for PIDC and PID load frequency controllers considering robustness and sensitivity to measurement noise," *Int. J. Electr. Power Energy Syst.*, vol. 114, p. 105416, Jan. 2020.
- [5] H. Abubakr, M. M. Hussein, and T. H. Mohamed, "Frequency stabilization of two area power system interconnected by AC/DC links using Jaya algorithm," *Int. J. Adv. Sci. Technol.*, vol. 29, no. 1, 2020.
- [6] T. Hassan Mohamed and M. M. Hussein, "Online Gain Tuning of Conventional Load Frequency Controller for Microgrid Power System," in *2018 20th International Middle East Power Systems Conference, MEPCON 2018 - Proceedings*, Feb. 2019, pp. 424–428.
- [7] H. Abubakr, T. H. Mohamed, M. M. Hussein, and G. Shabib, "ESO-Based Self Tuning Frequency Control Design for Isolated Microgrid System," in *21st International Middle East Power Systems Conference (MEPCON) 2019, Cairo, Egypt, 2019*, pp. 589–593.
- [8] H. Abubakr, T. H. Mohamed, M. M. Hussein, and G. Shabib, "Adaptive Frequency Regulation in Interconnected Two Area Microgrid System," in *IEEE Conference on Power Electronics and Renewable Energy, CPERE 2019, Oct. 2019*, pp. 284–289.
- [9] M. Abdelhamid, and T. H. Mohamed, "Adaptive and Intelligent Position Control of Car Moved by DC Motor Drive," *MSC thesis, Faculty of Energy Engineering, Aswan University, Egypt 2019*.
- [10] Y. A. Dahab, H. Abubakr, and T. H. Mohamed, "Adaptive load frequency control of power systems using electro-search optimization supported by the balloon effect," *IEEE Access*, vol. 8, pp. 7408–7422, 2020.
- [11] H. Abubakr, T. H. Mohamed, M. M. Hussein, J. M. Guerrero, and G. Agundis-Tinajero, "Adaptive frequency regulation strategy in multi-area microgrids including renewable energy and electric vehicles supported by virtual inertia," *Int. J. Electr. Power Energy Syst.*, vol. 129, pp. 106814, Jul. 2021.
- [12] T. H. Mohamed, M. A. M. Alamin, and A. M. Hassan, "Adaptive position control of a cart moved by a DC motor using integral controller tuned by Jaya optimization with Balloon effect," *Comput. Electr. Eng.*, vol. 87, pp. 106786, Oct. 2020.
- [13] T. H. Mohamed, H. Abubakr, M. A. M. Alamin, and A. M. Hassan, "Modified WCA-Based Adaptive Control Approach Using Balloon Effect: Electrical Systems Applications," *IEEE Access*, vol. 8, pp. 60877–60889, 2020.