



Aalborg Universitet

AALBORG UNIVERSITY
DENMARK

Hydraulic Response of Caisson Breakwaters in Multidirectional Breaking and Non-Breaking Waves

Grønbech, J.; Kofoed, Jens Peter; Hald, Tue; Burcharth, H. F.; Frigaard, Peter

Published in:
Dynamics of Structures 1993-1997

Publication date:
1998

Document Version
Publisher's PDF, also known as Version of record

[Link to publication from Aalborg University](#)

Citation for published version (APA):
Grønbech, J., Kofoed, J. P., Hald, T., Burcharth, H. F., & Frigaard, P. (1998). Hydraulic Response of Caisson Breakwaters in Multidirectional Breaking and Non-Breaking Waves. In *Dynamics of Structures 1993-1997: description of the projects in the research programme* (pp. 103-115). Dept. of Building Technology and Structural Engineering, Aalborg University.

General rights

Copyright and moral rights for the publications made accessible in the public portal are retained by the authors and/or other copyright owners and it is a condition of accessing publications that users recognise and abide by the legal requirements associated with these rights.

- Users may download and print one copy of any publication from the public portal for the purpose of private study or research.
- You may not further distribute the material or use it for any profit-making activity or commercial gain
- You may freely distribute the URL identifying the publication in the public portal -

Take down policy

If you believe that this document breaches copyright please contact us at vbn@aub.aau.dk providing details, and we will remove access to the work immediately and investigate your claim.

C.2 Hydraulic Response of Caisson Breakwaters in Multidirectional Breaking and Non-breaking Waves

GRØNBECH J., KOFOED J. P., HALD T.,
FRIGAARD P. and BURCHARTH H. F.
Hydraulics and Coastal Engineering Laboratory
Dept. of Civil Engineering, Aalborg University, Denmark

ABSTRACT

The present paper concerns the results and findings of a physical study on wave impacts on vertical caisson breakwaters situated in irregular, multidirectional breaking seas. The study has taken place as part of the framework programme "Dynamics of Structures" financially supported by the Danish Technical Research Council, during the period of January 97 to December 97. The tests were carried out in the 3D wave basin at the Hydraulics and Coastal Engineering Laboratory, Aalborg University. The objective of the study was to assess the effects of wave obliquity and multidirectionality on the wave induced loading and overtopping on caisson breakwaters situated in breaking seas. Regarding the wave forces only minor differences between breaking and non breaking waves in deep water were observed, and it was found that the prediction formula of Goda also seems to apply well for multidirectionally breaking waves at deep water. The study on wave overtopping showed that the 3D wave overtopping formula suggested by Franco et al., 1995b, predicts the wave overtopping reasonable well for both non breaking and breaking waves at deep water.

1. INTRODUCTION

Attention has been addressed to the effects of wave obliquity and multidirectionality on wave loads and wave overtopping on vertical caisson breakwaters situated in non-breaking seas. Within the joint European (MAST-LIP-TAW) research project, a 3D model investigation was carried out at Delft Hydraulics to assess these effects. The results have been published by several researchers, among them Franco et al., 1995a and Franco et al., 1995b. Several researchers have

investigated the effects of wave breaking and impact forces on vertical structures in the past, and it is still generally acknowledged that the impact loading of vertical structures is the main damage source, see Oumeraci et al., 1995. The research work on impact forces has mainly been based on 2D breaking waves. So far, no attention has been paid to the effects of wave obliquity and multidirectionality on the wave loads and wave overtopping on caisson breakwaters placed in deep water breaking seas. The effects

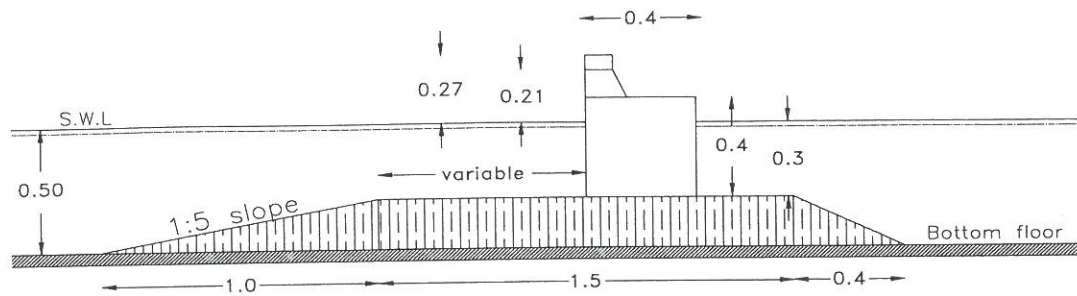

Figure 1 - Cross section of caisson model(s).

of wave obliquity and multidirectionality on the wave loads were investigated by measuring the wave induced pressure at 50 locations on a 6.0 meter wide caisson breakwater model, enabling determination of the horizontal force in one section as well as the lateral distribution of the horizontal force. The results and findings on the effects on the lateral distribution of the horizontal force are not included in this paper, but is published in the test report Results of Caisson Breakwater Tests in Multidirectional Breaking Seas. The present paper intends to stress the effects of wave obliquity and multidirectionality on the horizontal force in one vertical section.

The wave overtopping was measured on a 1.0 meter wide section of the caisson breakwater model, and the findings regarding the effects of wave obliquity and multidirectionality of the waves are presented in terms of the mean average overtopping discharge.

2. EXPERIMENTAL SETUP

The caisson breakwater model was constructed in plywood and placed on a smooth one layer foundation berm. Since the wave induced uplift pressures at the caisson bottom was not considered in the study, the foundation

berm was constructed in concrete. The cross section of the model is seen in Figure 1, and as it appears a crest element is placed on the top of the model in order to vary the crest height. The size of the model does not refer to any particular prototype structure, however, a Froude scaling of 1:20 - 1:25 seems appropriate for this type of structures. In order to generate a sea state representing breaking waves in deep water in front of the caisson model, a relatively short 1:5 slope was constructed and placed as seen in Figure 1.

For harbor type structures situated at deep water, the percentage of breaking waves in a storm event depends on the structure location and at the wave climate at this location, however, for this study it is decided to keep the number of breaking waves at about 5 to 10 per cent of the total number of waves. Using the numerical wave transformation model "MildSim", developed at the Hydraulics Laboratory at Aalborg University, tests with 2D irregular waves with a significant wave height of 0.18 m and a peak period at 1.2 s showed that about 6 to 7 per cent of the waves are breaking.

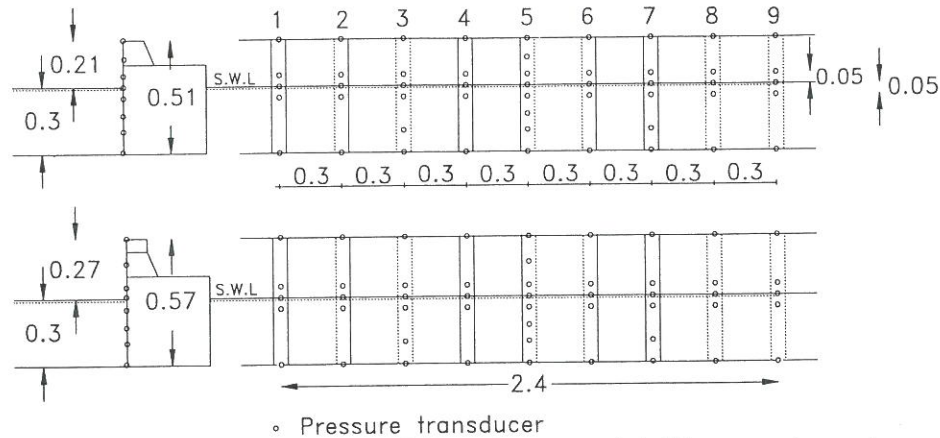

Figure 3 - Instrumentation of the caisson model. Measures in meters.

processes, and to obtain a width of the test section corresponding to one wavelength, the total width of the model should be about 6 meter.

The experiments were carried out in the 3D deep water wave basin at Aalborg University. The wave basin is capable of generating irregular multidirectional waves. A plan view of the wave basin and the caisson model is seen in Figure 2. Although the amount of wave energy passing through the gabs between the caissons and the side walls of the basin is small compared with the reflected wave energy, the rear end of the basin is equipped with a spending beach constructed of gravel material. Along the side walls of the basin, vertical steel absorbers are placed to damp any cross modal activity occurring during the tests. Due to limitations in the wave generation, the obliquity of the generated waves should be kept less than 30° , and therefore the model was placed under 60° with the wave paddles of the wave generator, as seen in Figure 2. Due to the high reflection from the caissons, a three dimensional active wave absorption system is ap-

plied to avoid too much re-reflected wave energy in front of the caissons. The active absorption system operates on-line by digital filtering of surface elevations measured in 16 individual positions in the wave field in front of the wave paddles, as seen in Figure 2. The wave absorption system is in its complete form outlined in Hald and Frigaard, 1997. In front of the model the wave field is measured by an array of 7 wave gauges, see Figure 2. The wave gauges are placed at deep water, i.e. in front of the 1:5 slope, which is about 1.5 meter, seaward the model. The incident wave field was estimated based on the Bayesian Directional spectrum estimation Method (BDM). Furthermore, the caisson has been instrumented with two wave gauges on the front. Thus, by assuming full reflection and therefore neglecting that some water is overtopping the water height can also be estimated at the structure.

The wave pressures were measured by a set of 50 pressure transducers placed as shown in Figure 3. The position of the pressure transducers enables the study of the vertical distribution of the

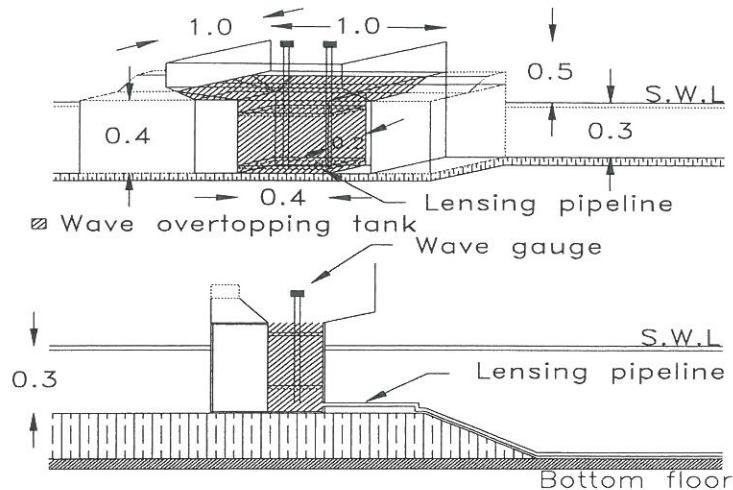

Figure 4 - Wave overtopping measuring device. Measures in meters.

horizontal pressure in different sections along the caisson model. By means of these vertical distributions of the horizontal pressures, the lateral distribution of the horizontal forces can be studied, and not only the lateral distribution of the horizontal pressures. This is important due to the unknown correlation between the lateral distribution of the horizontal pressure and the lateral distribution of the horizontal force.

Sideways, the pressure transducers are placed within a distance of 0.3 m enabling the study of the vertical distribution of the horizontal pressure in 9 sections along the 2.4 meter wide test section. A row of pressure transducers is placed at still water level. Furthermore, a row of transducers is placed 5 cm above and 5 cm below the still water level.

The wave overtopping measurements concern the determination of the mean discharge of a test sequence, the number of wave overtopping events and finally the determination of the water volume in each of the individual

overtopping events. In this study, the wave overtopping is determined by recording the water level in a water tank, in which all the overtopping water is collected. The collected overtopping water corresponds to a width of 1.0 m of the test section. The amount of water collected in the tank is determined by recording the water level in the tank during the tests. The water level is measured by a set of two wave gauges placed in the water tank. Due to the irregularity of the waves, the amount of overtopping water varies from wave to wave, and in order to obtain reasonable increments of the water level in the tank even for the smallest wave overtopping events, the cross section area of the tank must be kept relatively small.

3. TEST CONDITIONS

As the main objective of the study was to assess the effect of wave obliquity and multidirectionality the changes on test conditions were mainly the incident mean direction of the waves and the directional spreading of the waves, i.e. the energy distribution around the mean direction of the waves. The

Wave spectrum	JONSWAP, $\gamma = 3.3$
Peak period, T_p	1.2 sec
Significant wave height	0.16 m to 0.18 m
Crest freeboard, R_c	0.21 and 0.27
Water depth, h_d	0.3 m
Angle of wave attack, θ	$0^\circ, 15^\circ, 30^\circ, 45^\circ, (60^\circ)$
Type of spreading	Cosine squared, with $s=10$ and $s=29$

Table 1 - Wave parameters.

mean direction or the incident angle of wave attack was varied from 0° (head on waves) to 50° for some of the tests. A cosine squared ($\cos^{2s}(\theta/2)$) spreading function with fixed s -values of 10 and 29 was used in the tests, which corresponds to standard deviations of 25° and 15° , respectively. See Frigaard et al., 1997. The incident target significant wave height was fixed at 0.16 m for the non breaking waves and 0.18 m for the breaking waves. A JONSWAP wave spectrum with a peak enhancement factor of 3.3 and a peak period of 1.2 sec was applied in all the tests, giving a steepness at 0.07 for non breaking waves and 0.08 for breaking waves. To obtain an adequately statistically validity of the test results, rather long test series were performed with no test series having less than 1800 waves. In table 1, the various target parameters of the test series are shown.

Regarding this paper, the results are all based on the test cases listed below and with a crest freeboard of 0.27.

- 3D non breaking waves,
 $H_s = 0.16$ m, $\sigma = 15^\circ$, $\theta = 0^\circ$ to 40°
- 3D non breaking waves,
 $H_s = 0.18$ m, $\sigma = 25^\circ$, $\theta = 0^\circ$ to 40°
- 3D breaking waves,
 $H_s = 0.16$ m, $\sigma = 15^\circ$, $\theta = 0^\circ$ to 48°
- 3D breaking waves,
 $H_s = 0.18$ m, $\sigma = 25^\circ$, $\theta = 0^\circ$ to 40°

4. WAVE FORCE ANALYSIS

The horizontal wave forces are determined by a linear integration of the measured pressure time series. The horizontal forces presented below are all based on the pressure measurements of section 5, see Figure 3, where 8 pressure measurement positions are used representation of the vertical distribution of the horizontal pressure. In Figure 5, a plot of the measured horizontal pressures are shown along with the calculated force time series. The plot shows 10 sec of the test series with head on breaking waves and a spreading corresponding to $\sigma = 25^\circ$.

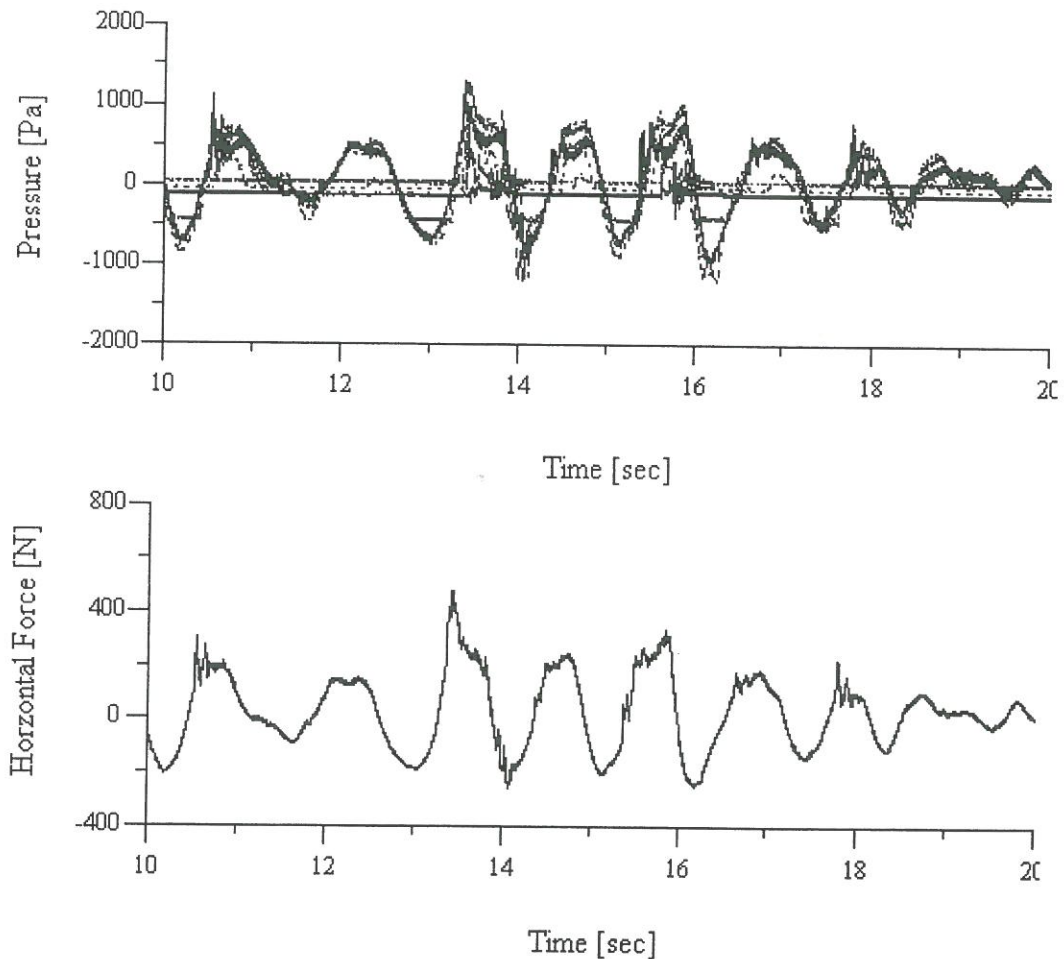

Figure 5 - Pressure record with corresponding force time series.

The pressure time series are sampled at 800 Hz, and only the maximum peaks within one wave period are used for the determination of the probability distribution of the horizontal forces.

In order to compare the results with the prediction formula of Goda, the statistical force parameter $F_{1/250}$ are calculated from the force time series. Due to the applied number of waves this force is calculated as an average value of the 7 largest forces found by the analysis of the force time series. In order to compare the results of the tests with non breaking waves with the tests with breaking waves, the calculated $F_{1/250}$ forces are normalized by

the predicted Goda force corresponding to the actual wave obliquity and wave height measured by the wave gauges placed at deep water. Such normalization is however not unambiguous because due to shoaling the waves at the model structure are quite different from the recorded waves at deep water, whereas this was not the case in the tests of Goda. For this reason, alternative normalization is presented in Section 6 of this paper.

The results of the normalization based on the recorded non shoaling waves are shown in Figure 6. Deeper interpretation of the results should not be done because of the normalization as

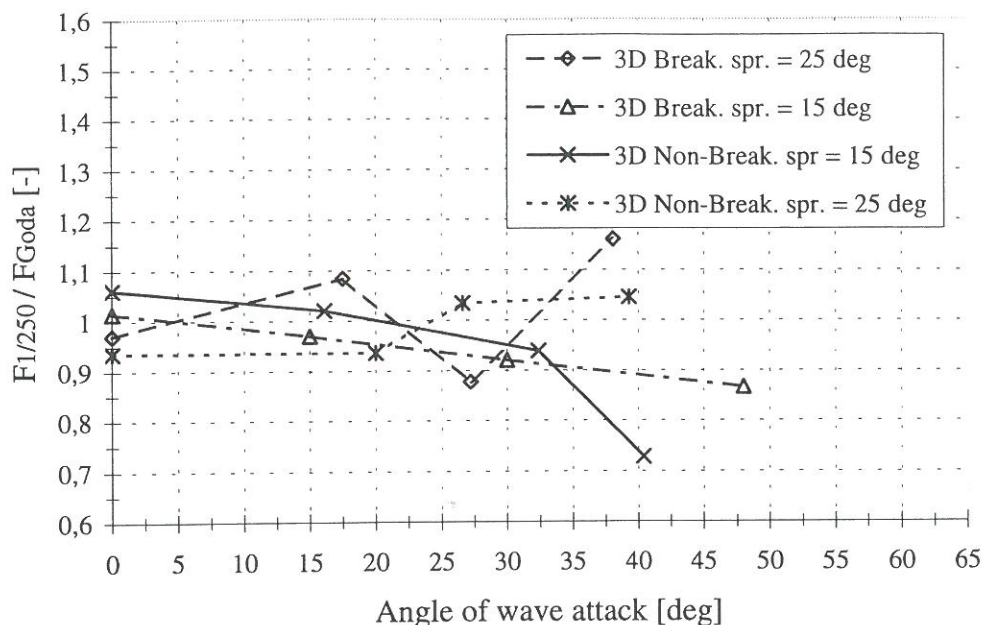

Figure 6 - Comparison with Goda predicted forces based on recorded non shoaling waves at a distance from the structure.

discussed above. However, if this is disregarded it can be seen that the formula of Goda seems to apply well for both the non breaking as well as the breaking waves. Most of the calculated forces are seen to deviate less than 10% from the Goda predicted forces. Apparently, the Goda formula applies best in case of waves within the range of 0 to 35 degrees. However, the pronounced scatter for waves with larger obliquity than 35 degrees could also be due to the relative error of these forces.

Franco et al. 1995a found for non breaking waves that the forces predicted by the formula of Goda, which does not take into account the multidirectionality of the waves, should be reduced with about 10%. This trend is, however, not seen in the results of this study.

One would expect the breaking waves to produce higher forces than the non breaking waves due to the impact forces. This is also seen if the shoaling waves at the structure are used as reference waves instead of the non shoaling waves, cf. Section 6.

5. WAVE OVERTOPPING ANALYSIS

For each test series, the wave overtopping was determined by recording the water level in the overtopping tank. The water levels were measured by a set of two wave gauges during the tests, and each of the overtopping events were recorded as a small (or large) increase in water level. In Figure 7 the measured overtopping rate is shown for the test with head on non breaking waves, and a spreading corresponding to $\sigma = 25^\circ$. The total amount of water collected in the water tank during a complete time series is determined by calculating the water

volume of each of the individual overtopping events.

The non dimensional mean overtopping discharge is defined as:

$$Q = \frac{q}{\sqrt{gH_s^3}}$$

where q is the average wave overtopping discharge per meter structure length, H_s is the significant wave height and g is the gravity acceleration.

The basic assumption, confirmed by many researchers, is that the main parameters influencing the wave overtopping performance, i.e. the significant wave height, the crest height and the average wave overtopping discharge are related through a exponential function as:

$$Q = ae^{\left(-b \frac{R_c}{H_s}\right)}$$

Based on more than 80 hydraulic model tests performed in the directional wave basin at Delft Hydraulics,

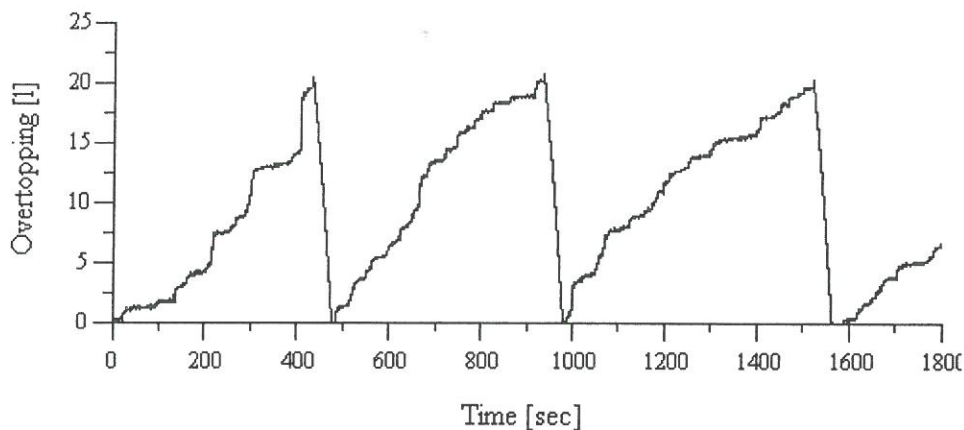

Figure 7 - Recorded wave overtopping time series.

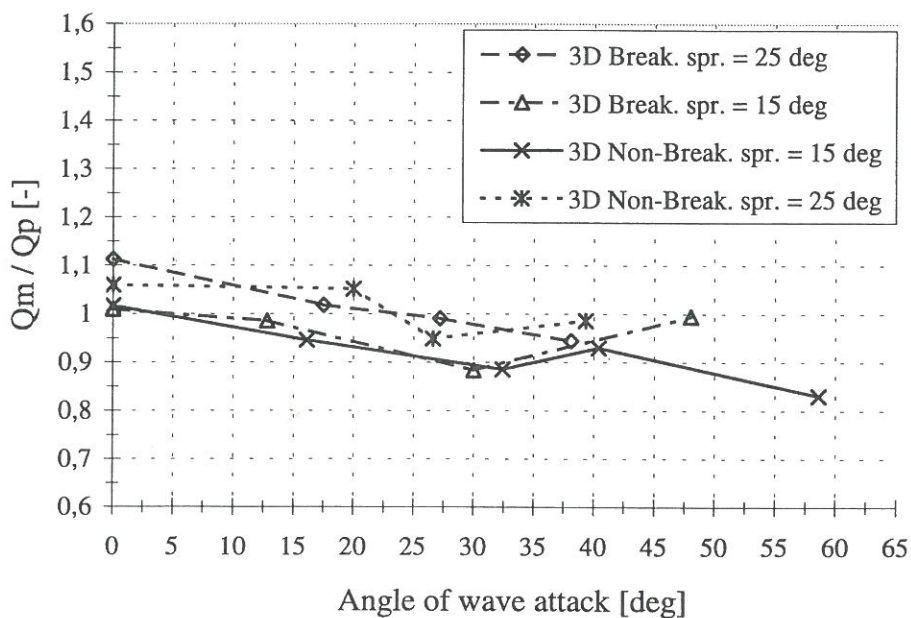

Figure 8 - Comparison of measured and predicted wave overtopping based on non shoaling waves at a distance from the structure.

Franco et al., 1995b, suggested the use of $a = 0.082$ and $b = 3.0$ for plain vertical structures exposed to head on waves. To take into account the effects of wave obliquity and multidirectionality a reduction factor was introduced to the non dimensional expression.

$$Q_p = ae^{\left(\frac{b R_c}{\gamma H_s}\right)}$$

Through best fit regression analysis Franco et al., 1995b suggested the following relation between γ and the wave obliquity for multidirectional waves.

$$\begin{aligned} \gamma &= 0.83 && \text{for } 0^\circ \leq \theta \leq 20^\circ \\ \gamma &= 0.83 \cos(20^\circ - \theta) && \text{for } \theta \geq 20^\circ \end{aligned}$$

In Figure 8 the results of the 4 test cases are shown. The wave overtopping is expressed in terms of the measured average overtopping discharge Q_m normalized by the predicted average wave overtopping discharge Q_p .

As it appears, the suggested prediction formula of Franco et al., 1995b seems to apply well with most of the compared data deviating less than 10%. It is, however, observed that for angles of wave attack smaller than approximately 20° , the predicted wave overtopping tends to be smaller than the measured wave overtopping, whereas, the wave overtopping seems to be over

predicted for angles of wave attack larger than approximately 20° .

Comparing the results of non breaking waves to the results of breaking waves, it is seen, that no apparent difference exist, indicating that in terms of 3D waves, it is not necessary to distinguish breaking waves from non breaking waves. However, it was visually observed during the tests with breaking waves that the breaking process causes a significant increase in spray, which of course should be considered in the prototype case.

6. RESULTS BASED ON WAVE HEIGHTS AT THE STRUCTURE

As described in Section 2 it is the sloping bottom in front of the caisson that introduces the wave breaking in the breaking waves test series. This means that the wave height in these tests varies as the waves approaches the caisson. Thus, the wave heights determined by the BDM analysis of the waves measured at the deep water is not the wave heights of the breaking waves as they reach the caisson. This wave height at the structure is very difficult to estimate, due to the high amount of reflection. But by using the wave gauges placed on the front of the caisson, the wave height at the structure has been estimated. Using these wave heights Figures 6 and 8 will change into the plots shown in Figure 9 and Figure 10.

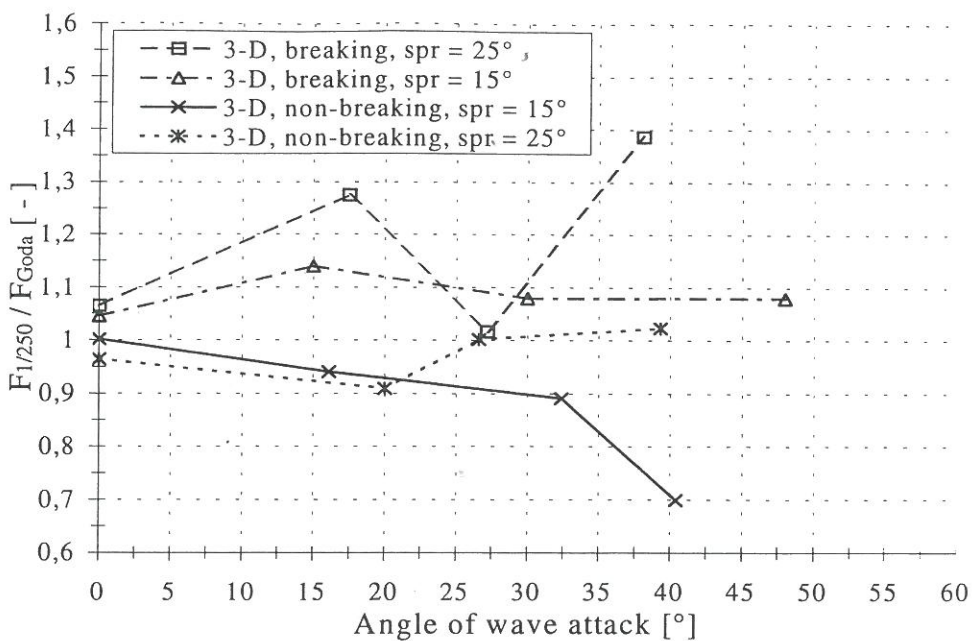

Figure 9 – Comparison with Goda predicted forces (wave heights at the structure).

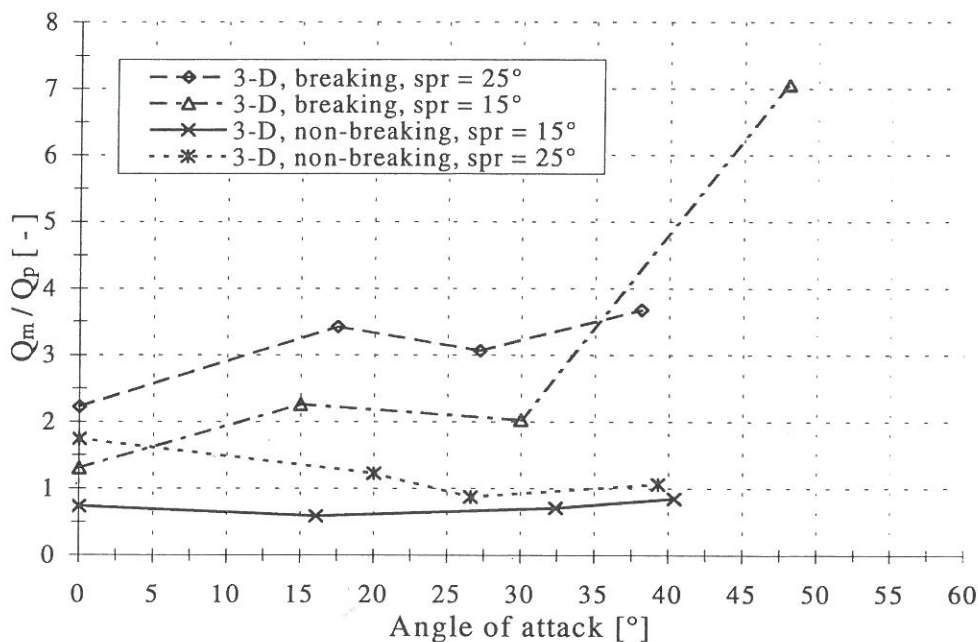

Figure 10 – Comparison of measured and predicted wave overtopping (wave heights at the structure).

The new plots show more scatter than the previous plots due to the poorer estimation of wave heights. As expected the breaking waves loose more energy on the slope than the non breaking waves, and the normalized forces and overtopping rates are therefore increased for the breaking waves compared to the previous plots, while

the rates for the non breaking waves are relatively unaltered. Thses results seems more logic than those presented in Figure 6.

7. CONCLUSION

Regarding the effects of wave obliquity and multidirectionality on wave loading and wave overtopping on caisson breakwaters only minor differences were observed between breaking and non breaking waves when the results were normalized with deep water wave heights. In the case where the forces were normalized with wave heights at the structure larger wave force rates were observed for the breaking waves.

Despite the observed amount of spray during the tests, the measured overtopping rates for breaking waves seem to agree well with the prediction formula for 3D non breaking waves given by Franco et al., 1995b as long as the deep water wave heights were used. Using the wave heights at the structure results in significantly larger overtopping rates for the breaking waves, than predicted by the overtopping formula by Franco for non breaking waves. The rates for the non breaking waves were better predicted by the Franco formula.

8. ACKNOWLEDGEMENTS

This work has been carried out with support from the frame work programme *Dynamics of Structures* of the *Danish Technical Research Council*.

8. REFERENCES

Battjes, J. A. and Jansen, J. P. F. M. (1978). *Energy loss and set-up due to breaking of random waves*, Proceedings of the 16th International Conference on Coastal Engineering, Hamburg.

Hald, T. and Frigaard, P. (1997). *Alternative Method for Active Absorp-*

tion in Multidirectional Waves. IAHR seminar on Multidirectional Waves and their Interaction with Structures, 27th IAHR Congress, San Francisco, 10-15 August 1997.

Franco, C., Franco, L., Passoni, G., Restano, C., van der Meer, J.W. (1995a). *The effect of wave obliquity and short-crestedness on the horizontal and uplift forces on caisson breakwaters*. Final proceedings, MAST II, (MAS2-CT92-0047), MCS-Project: Monolithic (Vertical) Coastal Structures, Paper 4.8, 22 pp.

Franco, C., Franco, L., Restano, C., van der Meer, J.W. (1995b). *The effect of wave obliquity and short-crestedness on the overtopping rate and volume distribution on caisson breakwaters*. Final proceedings, MAST II, (MAS2-CT92-0047), MCS-Project: Monolithic (Vertical) Coastal Structures, Paper 4.9, 37 pp.

Frigaard, P., Helm-Petersen, J., Klopman, G., Stansberg, C. T., Benoit, M., Briggs M. J., Miles, M., Santas, J., Schäffer, H.A., Hawkes, P.J. (1997). Grønbech J., Hald, T. and Frigaard, P., Burcharth H. F. (1997). *Wave Loading and Overtopping on Caisson Breakwaters in Multidirectional Breaking Seas*. IAHR seminar on Multidirectional Waves and their Interaction with Structures, 27th IAHR Congress, San Francisco, 10-15 August 1997.

IAHR List of Sea State Parameters. IAHR seminar on Multidirectional Waves and their Interaction with Structures, 27th IAHR Congress, San Francisco, 10-15 August 1997.

Oumeraci, H., Hewson, P., Juhl, J. and van der Meer, J.W. (1995). MCS-Project: *Multi-Disciplinary Research on Monolithic Coastal Structures*, Final proceedings, MAST II, (MAS2-CT92-0047), MCS-project: Monolithic (Vertical) Coastal Structures. Papers Task 1-2.

Results of Caisson Breakwater Tests in Multidirectional Breaking Seas (Internal Laboratory Test Report). Hydraulics and Coastal Engineering Laboratory, Dept. of Civil Engineering, Aalborg University, Denmark, December 1997.