



AALBORG UNIVERSITY
DENMARK

Aalborg Universitet

Energy Efficiency and Routing in Sensor Networks

Cetin, Bilge Kartal

Publication date:
2011

Document Version
Early version, also known as pre-print

[Link to publication from Aalborg University](#)

Citation for published version (APA):
Cetin, B. K. (2011). *Energy Efficiency and Routing in Sensor Networks*. Institut for Elektroniske Systemer, Aalborg Universitet.

General rights

Copyright and moral rights for the publications made accessible in the public portal are retained by the authors and/or other copyright owners and it is a condition of accessing publications that users recognise and abide by the legal requirements associated with these rights.

- Users may download and print one copy of any publication from the public portal for the purpose of private study or research.
- You may not further distribute the material or use it for any profit-making activity or commercial gain
- You may freely distribute the URL identifying the publication in the public portal -

Take down policy

If you believe that this document breaches copyright please contact us at vbn@aub.aau.dk providing details, and we will remove access to the work immediately and investigate your claim.

ENERGY EFFICIENCY AND ROUTING IN SENSOR
NETWORKS

A DISSERTATION
SUBMITTED TO THE DEPARTMENT OF
ELECTRONIC SYSTEMS
OF
AALBORG UNIVERSITY
IN PARTIAL FULFILLMENT OF THE REQUIREMENTS
FOR THE DEGREE OF
DOCTOR OF PHILOSOPHY

Bilge Kartal Çetin
Center for TeleInFrastruktur
Department of Electronic Systems
Aalborg University

Supervisor:

Associate Professor Neeli Rashmi Prasad, Aalborg University, Denmark

The examination committee:

Prof. Frank Li, University of Agder, Norway

Prof. Gregory Yovanof, Athens Information Technology, Greece

Assoc. Prof. Albena Mihovska, Aalborg University, Denmark (Chair)

Moderator:

Assoc. Prof. Zheng-Hua Tan, Aalborg University, Denmark

Date of defence: August 3, 2011

ISSN: *** - ****

ISBN: **_ **** - *** - *

Copyright © 2012 by Bilge Kartal Çetin

Center for TeleInFrastruktur

Department of Electronic Systems

Aalborg University

All rights reserved. No part of the material protected by this copyright notice may be reproduced or utilized in any form or by any means, electronic or mechanical, including photocopying, recording or by any information storage and retrieval system, without written permission from the author.

Abstract

Wireless sensor networks (WSNs) consist of tiny devices, which have a battery, a sensor, a microprocessor and a radio transmitter component. Due to a large range of application area, performance metrics in sensor network are strictly application-specific. However, 'unattended operation of the network for long time' or 'long network lifetime' can be determined as a common performance requirement for the most of the applications. Energy depletion of the nodes can interrupt communication and, in a worse case, it could cause network partitioning which leads the interruption of monitoring. Unlike ad-hoc networks, recharging or replacing of the sensors battery may be inconvenient, or even impossible in some monitoring environments. Therefore, the key challenge in the design of wireless sensor network protocols is how to maximize the network lifetime, which is limited by battery energy in sensor nodes, while providing the application requirement.

In sensor networks, there are two important energy consuming processes, the first is transmission-reception phase and the second is listening the radio for any possible event. Therefore, there are two strategies for energy saving. The first is reducing the networking activities, which means

less packet exchanging between the nodes or balanced load allocation. The second is avoiding the idle waiting time for packet arrivals. The first strategy covers routing techniques for resource constraints networks and the second covers duty-cycling techniques.

In this thesis, firstly mathematical characterization of networking in sensor network is studied by considering network dynamics and duty cycling of sensor nodes. Then energy efficiency techniques in sensor network are investigated. Secondly, a mathematical tool in which maximum lifetime routing can be investigated for different network parameters is developed by considering a duty-cycling mechanism in the network. Upper bound on network lifetime is sought by considering idle and sleep mode energy consumption as well as energy consumption in transmission and reception for sensor networks. The solution of the developed optimization problems gives an analytical benchmark for designing of maximum lifetime routing algorithms by giving the most energy balanced traffic allocation between the possible routes in the network by considering a duty-cycling mechanism. Lastly, an energy efficient routing protocol is proposed and evaluated by using the developed mathematical tool.

Dansk Resume

Trådløse sensornetværk (WSNs) består af små enheder, som har et batteri, en sensor, en mikroprocessor og en radiosenderkomponent. På grund af den store vifte af anvendelsesområder er effektivitetsmålinger i sensornetværk strengt applikationsspecifikke. Men "uovervåget drift af nettet i lang tid" eller "lang netværkslevetid" kan bruges som et fælles performancekrav for de fleste applikationer. Hvis noderne løber tør for strøm, kan det afbryde kommunikationen og - i værste fald - forårsage opsplitning af netværket, der fører til afbrydelse af overvågningen. I modsætning til ad-hoc-netværk kan genopladning eller udskiftning af sensorbatterier være besværligt eller endog umuligt i nogle overvågningmiljøer. Derfor er den vigtigste udfordring i designet af trådløse sensornetværksprotokoller, hvordan man kan maksimere netværkslevetid, som er begrænset af batteriets kapacitet i sensornoder, men som samtidig opfylder applikationens krav.

I sensornetværk er der to vigtige energikrævende processer; den første er transmissionen-modtagelse fasen, og det andet er at lytte til radioen efter mulige hændelser. Derfor findes der to strategier for energibesparelser; den første er at reducere netværksaktiviteter, hvilket betyder mindre

pakkeudveksling mellem noder eller symmetrisk fordeling af belastning. Den anden er at undgå tomgang i ventetiden mellem pakkeankomster. Første strategi dækker routingteknikker i ressourcemæssigt begrænsede netværk, og den anden dækker duty cycling teknikker.

I denne afhandling er der først studeret matematisk karakterisering af sensornetværk ved at betragte netværkets dynamik og duty cycling af sensornoder. Så undersøges teknikker til forbedring af energieffektivitet i sensornetværk. Derefter udvikles et matematisk værktøj, hvor routing efter optimal levetid kan undersøges for forskellige netværksparametre ved at overveje en duty cycling mekanisme i netværket.

Den øvre grænse for netværkets levetid undersøges ved at overveje energiforbruget i tomgang og sleep mode samt energiforbrug ved transmission og modtagelse for sensornetværk. Løsning af de udviklede optimeringsproblemer giver en analytisk benchmark for udformningen af ”maksimal levetid” routingalgoritmer. Det opnås ved at allokere trafik til de energiforbrugsmæssigt bedst afbalancerede ruter i netværket ved hjælp af en duty cycling mekanisme. Endelig foreslås en energieffektiv routingprotokol, som evalueres ved hjælp af det udviklede matematiske værktøj.

Acknowledgments

This thesis is the achievement of a long and hard journey. Although I faced many novelties and challenges during this journey, finally I made it with the help and encouragements of all people who surrounded me, in each stage of my life.

Thanks to my Supervisor, Dr. Neeli R. Prasad, for all technical support and advice she gave me.

Thanks to Prof. Ramjee Prasad who helped me to come here and introduced me to the professional academic world in such a prestigious and international environment.

Thanks to all my colleagues in Aalborg University for their friendship and collaboration. Thanks to the city of Aalborg where I felt my home and met with so many special people who come from so different places around the world.

I am deeply grateful to my parents who gave me trust and love during my life. I am immensely grateful to my husband, Kamil, who gave me strength and motivation during my Ph. D. study. I dedicate this thesis to

my husband, who have unconditionally supported and encouraged me all these years, and my daughter Mavisu, who will be born soon.

Table of Contents

| | |
|--|-------------|
| Abstract | iii |
| Dansk Resume | v |
| Acknowledgments | vii |
| List Of Figures | xv |
| List Of Tables | xvii |
| 1 Introduction | 1 |
| 1.1 Problem Definition | 3 |
| 1.2 Contributions of this Dissertation | 4 |
| 1.3 Dissertation Structure | 6 |
| 2 Background and State of the Art | 9 |
| 2.1 Wireless Sensor Networks Overview | 9 |
| 2.2 Energy Efficiency in Wireless Sensor Network | 14 |
| 2.2.1 Main energy dissipations in sensor network | 14 |
| 2.2.2 Duty Cycling | 17 |
| 2.2.3 Power Aware Routing in Wireless Sensor Networks . | 18 |

| | | |
|----------|---|-----------|
| 2.2.4 | Energy Efficient MAC Protocols for Wireless Sensor Networks | 22 |
| 3 | Mathematical Programming of Maximum Lifetime Routing Problem in Sensor Network | 31 |
| 3.1 | Introduction | 31 |
| 3.2 | System Model and Parameters | 32 |
| 3.2.1 | Data Generation Scheme and Data Flow Pattern . . . | 33 |
| 3.2.2 | Energy Consumption Model for Sensor Nodes | 33 |
| 3.2.3 | Individual Node Lifetime and Network Lifetime . . . | 34 |
| 3.2.4 | Duty cycling | 35 |
| 3.3 | Mathematical Model For The Maximum Lifetime Routing . | 36 |
| 3.3.1 | Problem Definition | 36 |
| 3.3.2 | Problem Formulation | 36 |
| 3.4 | A Numerical Example | 42 |
| 3.5 | Conclusion | 47 |
| 4 | Minimum Duty Cycling for Maximum Lifetime Routing | 51 |
| 4.1 | Introduction | 51 |
| 4.2 | Related Work | 52 |
| 4.3 | System Model and Parameters | 54 |
| 4.3.1 | Energy Consumption Model for Sensor Nodes | 55 |
| 4.3.2 | Duty Cycling | 55 |
| 4.4 | Mathematical Programming of the Maximum Lifetime Routing Problem in Duty Cycling Sensor Network | 57 |
| 4.4.1 | Problem Definition | 57 |
| 4.4.2 | Problem Formulation | 58 |
| 4.4.3 | Numerical Examples | 62 |
| 4.4.4 | Example I | 63 |

TABLE OF CONTENTS

| | | |
|----------|--|------------|
| 4.4.5 | Example II | 73 |
| 4.5 | Extension of the Mathematical Programming with Cycle Time | 81 |
| 4.6 | Conclusions | 83 |
| 5 | Numerical Analysis and Validation with A Design of Max- imum Lifetime Routing Algorithm | 85 |
| 5.1 | Introduction | 85 |
| 5.2 | System Model and Parameters | 87 |
| 5.2.1 | Residual Energy Aware Routing Mechanism | 88 |
| 5.2.2 | Sleep Wake Up Mechanism | 92 |
| 5.3 | Results | 92 |
| 6 | Conclusions and Future Work | 103 |
| 6.1 | Future Research Directions | 105 |
| A | List of Publications Produced during the Ph.D. Study | 109 |
| A.1 | Journals | 109 |
| A.2 | Conference Papers | 110 |
| A.3 | Technical Reports | 111 |
| B | List of Abbreviations | 113 |
| | References | 117 |
| | Curriculum Vitae | 127 |

List of Figures

| | | |
|-----|--|----|
| 2.1 | Typical Structure of Wireless Sensor Network | 11 |
| 2.2 | Typical Wireless Sensor Node Components | 15 |
| 2.3 | S-MAC protocol overview [56] | 24 |
| 2.4 | RMAC protocol overview [16] | 27 |
| 3.1 | Example network topology with 7 nodes and 1 sink node . . | 43 |
| 3.2 | Maximum network lifetime versus data generation periods for the case (i) | 44 |
| 3.3 | Maximum network lifetime versus data generation periods for the case (ii) | 45 |
| 3.4 | Maximum network lifetime versus data generation periods for the case (iii) | 46 |
| 3.5 | Individual node lifetime versus data generation periods for the case (i) | 47 |
| 3.6 | Total transmission-reception time versus data generation periods for the case (i) | 48 |
| 3.7 | Total idle time of the nodes versus data generation periods for the case (i) | 49 |
| 4.1 | Duty-cycling mechanism for any node in the network | 57 |

| | | |
|------|---|----|
| 4.2 | Example Network | 64 |
| 4.3 | Network lifetime versus data generation period | 66 |
| 4.4 | Total transmission and reception time for 0.1 percent duty cycle | 68 |
| 4.5 | Total transmission and reception time for 1 percent duty cycle | 69 |
| 4.6 | Total transmission and reception time for 10 percent duty cycle | 69 |
| 4.7 | Network lifetime vs duty cycling parameter range 1 | 70 |
| 4.8 | Network lifetime vs duty cycling parameter range 2 | 71 |
| 4.9 | Network lifetime vs duty cycling parameter range 3 | 72 |
| 4.10 | Network lifetime vs duty cycling parameter | 74 |
| 4.11 | Total amount of data during the network lifetime | 75 |
| 4.12 | Network for example 2 | 76 |
| 4.13 | Network lifetime versus duty cycling parameter | 78 |
| 4.14 | Total amount of data versus duty cycling parameter | 79 |
| 4.15 | For two different transmission range network lifetime vs duty cycling | 80 |
| 5.1 | Network Lifetime Over Varying Traffic Density $e_{idle}=e_{rx}$ | 94 |
| 5.2 | Network Lifetime Over Varying Traffic Density $e_{idle}=0$ | 95 |
| 5.3 | Network Lifetime Over Varying Traffic Density for %90 Duty Cycling Parameter | 96 |
| 5.4 | Network Lifetime Over Varying Traffic Density for %50 Duty Cycling Parameter | 97 |
| 5.5 | Network Lifetime Over Varying Traffic Density for %30 Duty Cycling Parameter | 98 |

LIST OF FIGURES

| | | |
|-----|--|-----|
| 5.6 | Network Lifetime Over Varying Traffic Density for %20 Duty Cycling Parameter | 99 |
| 5.7 | Latency Performance of Residual Energy Aware Routing Scheme for Different Duty Cycling Parameters | 100 |
| 5.8 | Success Rate of Residual Energy Aware Routing Scheme for Different Duty Cycling Parameters | 101 |
| 5.9 | Energy Efficiency of Residual Energy Aware Routing Scheme for Different Duty Cycling Parameters | 102 |

List of Tables

| | | |
|-----|---|----|
| 3.1 | Energy Consumption Characteristics for CC2420 Radio . . . | 34 |
| 3.2 | Feature and Units of the Symbols | 41 |
| 3.3 | Total Traffic Load Allocation to the Links For Maximum Lifetime | 50 |
| 4.1 | Energy Consumption Characteristics for CC2420 Radio . . . | 56 |
| 4.2 | Distance-Power Level Matching For CC2420 Radio | 63 |
| 4.3 | Total Flow Allocation to the Links For Maximum Lifetime- dc=0.01 | 77 |

1

Introduction

Wireless sensor networks (WSNs) consist of tiny devices, which have a battery, a sensor, a microprocessor and a radio transmitter component. The application area of WSNs can be classified into two general classes: monitoring applications and tracking applications [58]. While the first class of applications includes habitat monitoring, building monitoring, machinery monitoring and greenhouse monitoring etc., the second class includes animal tracking, vehicle tracking and goods tracking in supply chains etc. Due to this large range of application area, performance metrics in sensor network are strictly application-specific. However, 'unattended operation

of the network for long time' or 'long network lifetime' can be determined as a common performance requirement for the most of the applications.

In general, network lifetime can be defined as time span until the network is considered nonfunctional. In fact, as in performance metrics, perception of no functionality is also application-specific for sensor networks. A sensor network can be considered as nonfunctional if data delivery delay exceeds a threshold, or if the coverage of the monitoring area is less than the desired level, or if the network is partitioned due to the energy deficiency of some bottleneck nodes. This thesis focuses on no functionality of the network due to energy deficiency.

Energy depletion of nodes can interrupt communication and, in a worse case, it could cause network partitioning which lead the interruption of monitoring. Unlike ad-hoc networks, recharging or replacing the sensors battery may be inconvenient, or even impossible in some monitoring environments. Therefore the key challenge in the design of wireless sensor network protocols is how to maximize the network lifetime, which is limited by battery energy in sensor nodes, while providing the application requirement. The network lifetime is a strictly application-specific metric in sensor network performance and depends on many parameters: the topology of the sensor network [10]; the data aggregation regime in the network (raw data transmission or processed data transmission, periodic or event triggered data gathering [38]); the channel access (MAC) schemes [14]; the routing protocols [30], [3]; and the energy model for transmission (based on the channel model). This thesis focuses on maximizing the lifetime of a sensor network from the routing protocols point of view.

This thesis is that a mathematical tool in which maximum lifetime routing problem can be investigated for different network parameters must

be developed and a maximum lifetime routing protocol must be designed based on the observation of this tool.

1.1 Problem Definition

Objective of this PhD study is to create a mathematical framework which will be utilized to study on performance of sensor network from energy efficiency point of view with the varying networking parameters.

In order to prolong the network lifetime, the energy consumption of individual sensor nodes should be minimized while still providing application requirements. The radio transmitter component of the sensor node consumes more energy than the other components. Therefore, to reduce energy consumption, the number of communications should be minimized even if it has computational costs. When considering the minimization of the number of communications per node, routing packets from source nodes to the sink node through multi hop communication is an important challenge. Because, nodes will have different relay loads for different routing strategies and residual energy of the nodes should be considered in routing decisions in order to avoid network partition due to overloaded nodes. For maximum lifetime, the routing algorithm should provide fair relay load distribution between the nodes. On the other side, the energy consumed when the radio is in idle mode (neither receiving nor transmitting) has a big portion in the total energy consumption due to low traffic density in sensor network. Therefore, putting the radio in the low power mode when there is no data to transmit or receive is another effective way of reducing the node energy consumption and named duty-cycling.

To summarize, the energy consumption of the nodes in the network can be minimized in two ways; by minimizing the total amount of energy consumed during the idle time with duty-cycling and minimizing the number of communications per node with a load fair routing mechanism. Nevertheless, currently there is no mathematical tool, in which maximum lifetime routing problem and effect of duty-cycling on network lifetime can be investigated together.

Following problems will be addressed in this thesis:

- Determining optimum total amount of packets to be routed on each link of network for maximum network lifetime by considering idle mode energy consumption.
- Creating a mathematical programming formulation to investigate the minimum duty-cycling and optimum routing for maximum network lifetime in duty-cycling sensor network.
- Investigating an energy efficient routing algorithm for maximum network lifetime for validation of developed mathematical models.

1.2 Contributions of this Dissertation

The results of this research show that in sensor network there are two important energy consuming process, first is transmission/reception phase and second is listening the radio for any possible event. Therefore there are two strategies for energy saving. The first one is to reduce the networking activities, which means less packet exchanging between the nodes. The second one is to avoid the idle waiting time for packet arrivals. The

1.2. Contributions of this Dissertation

first strategy covers routing techniques for resource constraints networks (in terms of energy and processing power) and second covers sleep-wake up scheduling techniques. Firstly mathematical characterization of networking in sensor network is studied by considering network dynamics and sensor node states (sleep-awake). From the theoretical point of view, basic mathematical analysis methodology for maximum network lifetime routing is chosen as the Optimization Theory. After analytical analysis of the defined challenges, obtained results are used to determine the design constraints for maximum lifetime routing protocol. Then, this protocol is evaluated with help of a simulation tool and used for validation of the developed mathematical models.

In general, the main energy dissipations and energy efficiency techniques in sensor network are investigated. Firstly, it is focused on routing challenge for prolonging network lifetime and later the routing problem in duty-cycling sensor networks is tackled. Maximum lifetime routing problem is formulated as a mathematical programming problem firstly for a sensor network in which nodes are always awake and secondly for duty cycling sensor network in which nodes follow a sleep-wake up schedule to save energy. A maximum lifetime routing algorithm is tested for minimum duty-cycling parameter based on the observation of the analytical studies.

Strengths of developed mathematical programming formulations are as follows;

- These are the first mathematical programming formulations of the maximum lifetime routing problem that considers the all operation modes of the node.

- It provides a mathematical tool that can be used to study the routing strategy for the maximum lifetime.
- It can also be used to investigate the relationship between individual node lifetimes and network lifetimes in a mathematical framework for efficient node deployment strategy.
- Since the idle time of the individual nodes can be investigated based on the different data generation rates and the location of the node, it serves as a mathematical framework for future studies on the investigation of the allowable duty cycle parameter for a given data generation rate.
- The optimal solution provided by these mathematical frameworks can be used as a theoretical benchmark for designing new heuristic routing algorithms for duty-cycling sensor network for maximum lifetime.
- The lower bound of duty-cycling parameter that is allowed for maximum lifetime can be determined.

1.3 Dissertation Structure

Chapter 2 starts with an overview on wireless sensor networks and introduce the main characteristics of sensor network design. Based on the these characteristics some common performance metrics are determined for the majority of applications. Then, energy efficiency techniques in sensor networks are introduced by considering the main energy dissipations in sensor networks. Power aware routing and medium access control is investigated by giving an state of the art and challenges.

1.3. Dissertation Structure

Chapter 3 presents a mathematical programming formulation for maximum lifetime routing problem for sensor network. Upper bound on network lifetime is sought by considering idle mode energy consumption as well as energy consumption in transmission and reception. Solution of the optimization problem gives an analytical benchmark for designing of maximum lifetime routing algorithms by giving the most energy balanced traffic allocation between the possible routes in the network.

Chapter 4 presents a mathematical programming formulation for maximum lifetime routing problem for duty cycling sensor network. This chapter is extend the study in Chapter 3 for duty-cycling sensor networks. A new system model and design parameters are defined for duty-cycling sensor network and maximum lifetime routing problem is redefined by considering the duty-cycling. This formulation allows to determine the minimum duty-cycling parameter for a given network by guarantying the optimum routing for maximum lifetime. There is also an extension of the formulation by considering the energy consumption for RF initialization when the nodes switch between active and passive states. This extension allows to investigate the trade off between energy consumption and reliable data delivery. Because, high duty-cycling provide more reliable data delivery and low latency however RF initialization cost need to be considered in the design of duty-cycling MAC protocols.

Chapter 5 introduces the residual energy aware routing protocol. Mathematical formulations are validated with the help of this routing protocol. Performance of the proposed protocol is presented at the analytical minimum duty-cycling which is observed by solving the optimization problems.

Chapter 6 presents the conclusions of this PhD research and discussions on future works.

2

Background and State of the Art

2.1 Wireless Sensor Networks Overview

In recent years, wireless sensor networks (WSNs) have gained a big attention from the research community due to growing application area that is natural result of the technological advances in sensors, batteries, low-power analog-digital electronic devices and RF design. The application area of WSNs can be classified into two general classes as monitoring and tracking

applications [58]. Based on the type of monitoring or tracking environment or assets, sensor nodes may be deployed unstructured or structured based. An example for the unstructured WSN may be dropping sensor nodes from an airplane for surveillance of a field. In this type of WSN, network maintenance such as managing connectivity is difficult since there are large number of nodes. If all or some of the sensor nodes are deployed in a pre-planned manner as in structured WSNs, network maintenance is easier since fewer nodes are placed at specific locations: an example may be a structural monitoring such as buildings or bridges. However, unattended operation requirement may exist in both scenarios once they are deployed.

Main characteristics of wireless sensor networks can be summarized as follow;

- Large number of nodes in the network
- Mostly many to one communication pattern (Figure 2.1)
- Limited resources (battery powered, processing capability etc.)
- Difficult network maintenance especially in unplanned deployment of sensor nodes in the area (eg. throwing from an airplane)
- Once they are deployed, there exists a requirement of unattended operation and organization of the network for long time.

Resource limited feature of WSN distinguish sensor networks from other ad hoc networks and from the performance point of view, unlike ad hoc networks, performance metrics is strictly application specific for

2.1. Wireless Sensor Networks Overview

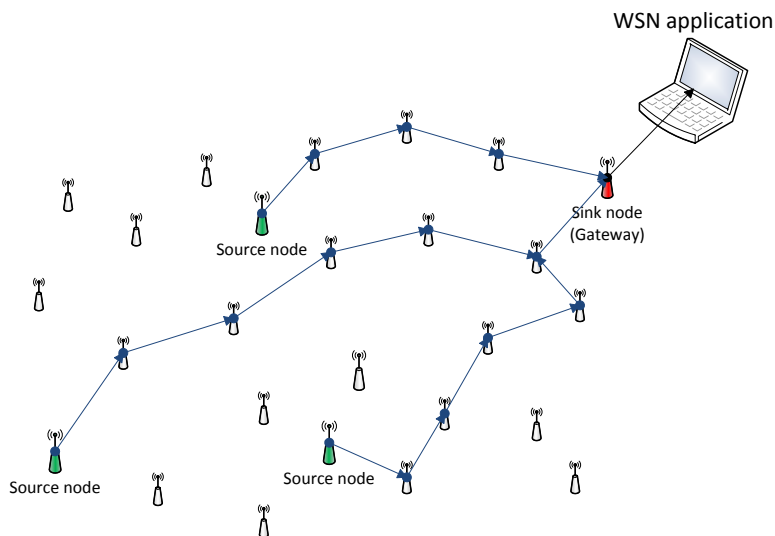

Figure 2.1: Typical Structure of Wireless Sensor Network

sensor networks. However, in the light of above characteristics, some common performance metrics can be listed as follow:

- Network Lifetime;

In general, network lifetime can be defined as time span until the network is considered nonfunctional. In fact, perception of no functionality changes based on the application requirements. A sensor network can be considered as nonfunctional if data delivery delay exceeds a threshold, or if the coverage of the monitoring area is less than the desired level, or if the network is partitioned due to the energy deficiency of some bottleneck nodes [15]. This thesis focuses on no functionality due to energy deficiency. From this point, the

lifetime of the sensor network is defined as the time period until the first node runs out of battery (minimum individual node lifetime), as in [9], [25], [34], or a certain percentage of the network nodes go flat (n_{th} minimum individual node lifetime), as in [6], [55]. However, in this thesis, different than the existing definitions in the literature the network lifetime is defined as time span which allows maximum amount of data delivery to the sink node and achievable maximum amount is restricted by the nodes' initial energy level. The reason for our definition differing from the existing studies is because we define the individual node lifetime as sum of the time spend in all operation modes and consider the energy consumption of idle and sleep modes as well as data transmission and reception modes. Therefore, for the measure of no functionality of the network, we consider the networking activity as well as battery level. Keeping this in mind, we define the network lifetime as the time span which allows nodes to deliver the maximum amount of data to the sink node. Maximum amount of data delivery meant that nodes spend most of their time in reception and transmission modes instead of idle and sleep mode. For example, if there is no networking activity (transmission and reception), the battery lifetime of the nodes will be longer (their battery last in longer time) due to lower energy consumption of idle mode, but network lifetime will be zero because transmitted data to the sink node will be zero.

- Reliability;

The common used definition of reliability is the probability that the system will perform its intended function under specified working condition for a specified period of time. Generally, in Mobile Ad Hoc Networks (MANET) connectivity has been evaluated as a measure

of reliability [33]. In sensor network, reliability term is generally used in the means of successful data delivery from node to the sink node. In this thesis, the reliability term is also used in this mean and the reliability of the network is measured by means of success rate.

- Time Efficiency;

Time efficiency is ability of the sensor network to perform its duty under the required time limits. In fact, this performance metrics have broad range to be considered as fulfilled. While for some application such as monitoring of intruder time efficiency has big importance, for others like temperature monitoring it does not have that importance.

- Sink Oriented Connectivity;

In ad hoc networks, connectivity is considered as a metric that shows the ability to transmit data from any source nodes of network to a given destination node. Therefore, the size of the largest connected component in the network represents an important performance metric in ad hoc networks. However, in sensor network where connectivity around a based station is the most important, the size of the connected component is not sufficient. Therefore, for distinguishing from the ad hoc networks, it is called as "sink oriented connectivity". It should be noted that this definition assumes that the basic communication model of wireless sensor network is many-to-one type. In case of clustered network, the size of the largest connected component can be taken as a performance metric to ensure data delivery.

- Scalability;

Scalability is the ability for the network to accept new nodes without impacting the application requirement. Communication algorithms or protocols for sensor network need to provide scalability. Due to energy restriction of sensor network, new nodes need to be added to extend the network lifetime or provide higher level of reliability.

2.2 Energy Efficiency in Wireless Sensor Network

In most applications, sensor nodes are restricted in energy supply. Although energy harvesting from environment is also possible in some applications [44], this is out of scope of this study. Therefore, it is only focused on sensor nodes with non rechargeable batteries and without energy harvesting capabilities. Due to limited energy resources and requirement of long operation time, innovative communication techniques need to be developed that consider to eliminate energy inefficiencies in all networking layers. In order to achieve the primary goal of energy efficiency in design of wireless sensor networks, the main energy dissipation sources are identified in a sensor node component and sensor networks.

2.2.1 Main energy dissipations in sensor network

To investigate the main energy dissipation in sensor network, a single sensor node is considered in detail. As shown in the Figure 2.2, typical wireless sensor node components consist of the following subsystems [45];

- A sensing Subsystem (sensor + ADC);

2.2. Energy Efficiency in Wireless Sensor Network

- Processing Subsystem (MCU + Memory);
- Radio Subsystem (Communication Interface);
- Power supply unit (Battery).

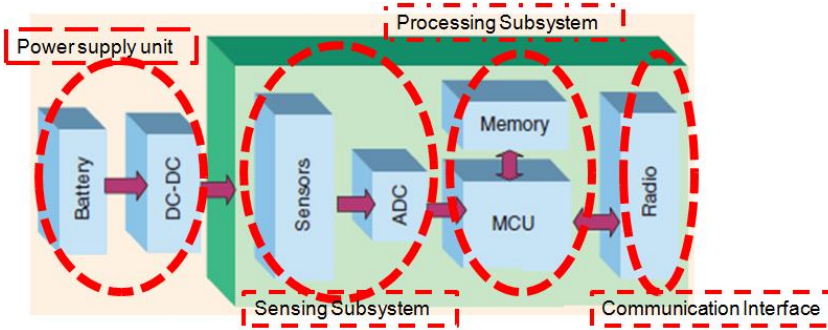

Figure 2.2: Typical Wireless Sensor Node Components

Although power breakdown heavily depends on the specific node, there are some common characteristics of power dissipation as follows;

- The radio subsystem is the component that consumes the largest energy. A study about comparison of computation and communication costs has shown that transmitting one bit over a distance 100 m consumes approximately the same energy as executing 3000 instructions [43]. Therefore, to reduce energy consumption the number of communications should be minimized, even if it costs extra data processing.
- Due to the small transmission distance, the power consumed for receiving may be greater than the power consumed for transmitting [7], [47]. However, if a packet is sent by a node, all nodes in the

radio range receive this packet even it is not addressed to them. This is called overhearing and needs to be minimized to decrease energy waste.

- The power consumption of the sensor node radio subsystem depends on the operational mode. Many sensor node device vendors provide low-power mode option for the radio. A radio can be typically in four different modes of operation; transmission, reception, idle, and low-power(sleep) mode. Aim of the low-power mode is putting the radio in this mode when node is not participating any networking activities. In fact, when a node is in idle mode (neither receiving nor transmitting), power consumption is the same as in reception mode. However, sensor nodes perform a cooperative task in the network as relaying the traffic to the base station as well as sending their own data. Therefore, sensor nodes need to listen to the radio channel for any possible relaying task.
- Collision is another major source of energy waste, if more than one node send packet at the same time, the transmitted packet is corrupted and discarded. Consequently, the retransmission of packets is needed and that increases energy consumption. Therefore, collision-free channel access is an important goal in the design of sensor network.
- In organization of the nodes for cooperative tasks, there is a need for control packet exchange. This should be kept as low as possible to use the energy for useful data packets.

2.2. Energy Efficiency in Wireless Sensor Network

As a conclusion, energy consumption of a node can be classified as communication related and computation related. In this thesis, only communication related energy consumption is considered.

2.2.2 Duty Cycling

In the view of the general remarks of energy dissipation sources given in the previous section, several approaches can be developed for energy efficiency in sensor networks. Since the radio component is the most energy consuming part, the most effective way is putting the radio transceiver in the sleep (low- power) mode whenever communication is not required. Nodes switch between radio active (awake) and radio passive (sleep) modes depending on the networking activity. This is called as duty cycling [24], [23], [22] and duty cycle is defined as the fraction of time nodes spend in active mode in one duty cycling period and consequently during their lifetime.

Duty cycling is an efficient power saving mechanism to prolong network lifetime. However, it brings extra challenges into the sensor network design in all network layers. Active(wake up)-passive(sleep) schedules of the nodes need to be coordinated for uninterrupted networking activity. Many kinds of sleep-wake up scheduling algorithms have been proposed in the literature. They can be classified in three broad classes as synchronized [29], [52], [54], [20], [12], [57] asynchronous [26], [41], [42], [7] and wake up channel based. In the synchronized sleep-wake up scheduling, nodes periodically or aperiodically exchange control packets with neighboring nodes to share synchronization information. This procedure results in additional control packet overhead and consumes additional energy. Therefore, a trade-off between cost of control packet overhead and saving

energy by duty-cycling needs to be considered in the design. In asynchronous sleep-wake up scheduling algorithms, nodes sleep and wake up independently of neighboring nodes. Due to this independency, additional delays are incurred in data transferring to the sink node [28]. Because, each node needs to wait for one of its next hops along the path to the sink node to wake up before it can transmit the packet. In the last sleep-wake up scheme, there is a low power wake up channel beside the regular data channel. The nodes turn off their high power radio and listen the low power wake up channel for wake up calls from neighboring nodes for relaying their packets. However, this scheme increases the sensor node device complexity and cost since it needs another receiver circuit.

2.2.3 Power Aware Routing in Wireless Sensor Networks

Main task of a routing protocol is to deliver the sensed data from source sensor nodes to a single or a few sink nodes. Due to ad hoc nature of the sensor networks, there is no fixed network infrastructure and the nodes have many possible paths to maintain connectivity to the sink node. Therefore, energy consideration plays an important role choosing the optimum path to access the sink node. In networking, the routing problem can generally be interpreted as a flow problem. In conventional ad hoc networks, the shortest path is chosen as the optimum data forwarding path. However, for energy limited networks, the shortest path routing paradigm is replaced with energy efficient routing approaches [51], [49]. The approach in these papers involves trying to minimize the total energy consumed in reaching the destination, thus minimizing the energy consumed per unit flow or packet. Instead of trying to minimize the total consumed energy on the path, many studies related to sensor networks

2.2. Energy Efficiency in Wireless Sensor Network

address the task of maximizing the lifetime of the network by considering residual energy of the nodes in the routing decision or focusing the load balancing between the nodes [2], [40], [5], [39], [34]. As mentioned in the previous section, although there are several definitions of network lifetime, this thesis focuses on the network lifetime definition in terms of energy deficiency of the nodes.

Many existing sensor node devices provide the transmission at different power levels, hence it is possible to choose between multi-hop or direct communication. In general, multi-hop routing will consume less energy than direct communication because transmission power of a wireless radio is proportional to distance squared or even higher order based on the type of the environment. However, there might be some bottleneck nodes in the multi-hop paths which may create the network partition since their battery will be exhausted earlier. In addition, in [19] authors show that energy consumption in electronics of the sensor node needs to be considered on the preference of multi-hop or direct communication for saving energy. For designing power aware routing protocols, one basic method is to integrate the energy consumption into the link cost and to apply a shortest path algorithm. Hence, energy consumption model plays a key role on defining the link costs. There is one mostly used energy consumption model in the literature [50].

$$e(x) = a.x^\alpha + c \tag{2.1}$$

where $e(x)$ represents the power required for transmission across a distance x . α is the path loss exponent and gets the value of 2 for free space and 4 for fading channel, a and c are constants.

Note that, this model indicates that shorter distance communication consumes less energy therefore multi-hop should be preferred to save energy. Integrating energy consumption into the link cost and simply applying shortest path algorithm causes to use a subset of the nodes. Consequently, the battery of those nodes may drain earlier and results in network partition. However, to prolong the network lifetime, energy efficient routing protocols should use the node energy in a more balanced way. In other words, data traffic should be routed through the paths, which have nodes with more residual energy, instead of the paths with minimum energy costs. In fact, if energy consumption is ignored, it is possible that a route consuming more energy may be used and this can also lead a shorter network lifetime by consuming more energy in the network. Therefore, researchers study on hybrid metrics that combine maximizing network lifetime with a balanced energy consumption and minimizing energy consumption per packet. Here, this thesis gives a brief overview of these metrics and routing protocols based on these metrics in the literature.

In Minimal Battery Cost Routing (MBCR) [51], authors use a cost function based on the residual energy of the nodes. Battery cost is B_r for the route r with P_i nodes are defined as;

$$B_r = \sum f_i(c_i^t) \quad (2.2)$$

where

$$f_i(c_i^t) = \frac{1}{c_i^t} \quad (2.3)$$

2.2. Energy Efficiency in Wireless Sensor Network

and c_i^t is the residual battery capacity of node i at time t . The best route is the route which has the minimal battery cost.

Authors noted that when the summation of the battery cost function is used, a route with a little residual energy can be selected if other nodes in the routing path have more residual energy. Therefore, they propose Min-Max Battery Cost Routing (MMBCR) [51], in which the battery cost for route r is;

$$B_r = \max_{i \in \text{router}} f_i(c_i^t) \quad (2.4)$$

In this way, the route with nodes, which have minimum residual energy, will not be chosen.

In the study of Minimum Drain Rate (MDR) mechanism [27], authors use battery drain rate together with residual battery capacity. The drain rate of a node is the rate at which energy is dissipated. A cost function based on the drain rate is defined as follow;

$$C_i = \frac{RBP_i}{DR_i} \quad (2.5)$$

where DR_i is the drain rate and RBP_i is the residual battery power. If a node has more residual power, it will be used to route huge traffic. However, its drain rate will increase too. Each node computes its drain rate based on the changes in its energy level and adjusts the cost accordingly. The lifetime of an L_P of a routing path P is the minimum value of C_i along the path. Minimum drain mechanism will choose the path with the highest lifetime value.

Authors in [31] propose max-min zP_{min} algorithm. This algorithm finds a path that maximizes the minimal residual energy of the nodes within the path under the constraint that the power consumed is at most zP_{min} , where $z \geq 1$ is an adjustable constant and P_{min} is the minimum power consumption. The algorithm firstly finds the path with the minimum power consumption P_{min} , then removes the nodes with minimal residual power from the path. Next, the algorithm finds the rest alternative paths without nodes which are just removed. The algorithm performs this process until the minimum power consumption of such a path exceeds zP_{min} . For accurately running the algorithm, power levels of all nodes need to be known. Therefore, it is difficult to implement. To address this problem, authors propose zone based routing where the network is divided into geographical zones. The algorithm runs in each zone separately and a global controller manages all zones.

2.2.4 Energy Efficient MAC Protocols for Wireless Sensor Networks

One fundamental task of medium access control (MAC) protocols is to prevent collisions in the shared medium by many nodes. MAC protocols for sensor network can be classified as two broad classes as contention-based and time division multiple access (TDMA) protocols. Both classes have their own drawbacks. For example, in TDMA protocols there is a need for a tight synchronization between nodes which restrict the scalability of the network and these protocols have additional control packet overhead for maintaining synchronization. However, there is no collision and so no energy waste due to retransmissions. On the other side, contention based MAC protocols are better in scalability compared to TDMA based MAC

2.2. Energy Efficiency in Wireless Sensor Network

protocols and they need less control packet exchange, however, collisions and following retransmissions might be a considerable energy waste and delay.

There have been many studies to develop duty-cycling MAC protocols for wireless sensor networks. Although duty cycling MAC protocols are more energy efficient than traditional MAC protocols, they have one major drawback as end-to-end data delivery latency. Below, a brief summary of existing duty-cycle MAC protocols for sensor network with their advantages and drawbacks is given.

S-MAC [56]: This duty-cycling MAC protocol is contention based and has the synchronized duty-cycle scheme. Each sensor node follows a periodic sleep-wake up schedule and goes to sleep for some time, and then wake up and listens to hear if any other node wants to talk to it. During sleep mode, the node turns off its radio, and sets a timer to wake itself up later. The sleeping and listening time duration is selected beforehand based on application scenarios. This scheme requires a synchronization among neighbor nodes to remedy their clock drift. Authors use two techniques to minimize the synchronization errors. First, all exchanged timestamps are relative rather than absolute. Second, the listen period is significantly longer than clock error or drift. Nodes exchange their schedules by broadcasting it to all neighbor nodes. The contention mechanism is the same as in IEEE 802.11 use RTS(Request to Send) and CTS (Clear to Send). The node, which first sends out the RTS packet, wins the medium, and the receiver will reply with a CTS packet. An overview of the operation of S-MAC protocol is shown in Figure 2.3.

In order for a node to receive both SYNC packets and data packets, listening period is divided into two parts as a SYNC period and a

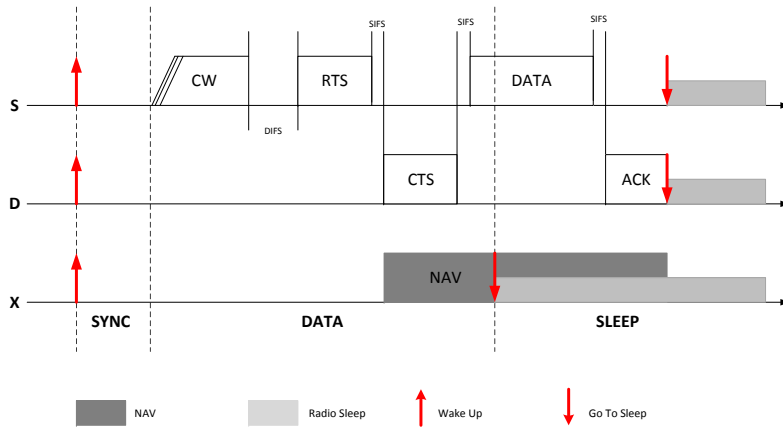

Figure 2.3: S-MAC protocol overview [56]

DATA period. Each part has a contention window with many time slots for senders to perform carrier sense. During the SYNC period, an independent synchronization protocol is used to synchronize the clocks of the sensor nodes. As in IEEE 802.11, nodes maintain a Network Allocation Vector (NAV) for virtual carrier sensing. For example, node C is the neighbor of node B and when it overhears the CTS sent by node B, it sets its NAV to indicate this virtual carrier and will not send any traffic while its NAV is not zero. SMAC uses NAV to avoid overhearing and preventing collisions. As in IEEE 802-11, Short Inter-Frame Spacing (SIFS) and Distributed Inter-Frame Spacing (DIFS) are also used in S-MAC. There is a trade off between energy saving and throughput. Because only active part of the duty-cycling period is used for data communication. If nodes

2.2. Energy Efficiency in Wireless Sensor Network

generate data during the sleep periods, they are queued until the beginning of the next active period. This results in latency on data delivery to the sink node. In [56], the authors introduce an adaptive listening to reduce latency. When a node hears an RTS or CTS transmission from its neighbor, it will wake up shortly at the end of the transmission and if it is the next hop on the data flow path, this will reduce the latency as it can immediately forward the packet without waiting the next scheduled awake period.

T-MAC [52]: This is another contention-based MAC protocol for wireless sensor networks. It also has a synchronized duty-cycling scheme. As in S-MAC, nodes synchronize themselves at the beginning of the duty-cycling period. Instead of using a fixed-length active period as in S-MAC, T-MAC uses a time-out mechanism to dynamically determine the end of the active period. If a node does not detect any networking activity within this timeout (TA) interval, it assumes that none of its neighbor wants to communicate with it and the node goes to sleep mode. If the node overhears a communication, it will stay in active state and fire a new TA after the communication ends. This time-out mechanism allows an adaptive duty-cycling for each node based on the network load they have. However, the main drawback of T-MAC is early sleeping problem. When a node A wants to send a message to B , but loses the contention to a third node C , which is not a common neighbor of B . Node A remains silent and consequently node B cannot hear anything and goes to sleep. After C 's transmission finished, node A will send an RTS to the sleeping B and cannot get a CTS and has to wait until the next duty-cycling period start. This problem reduces the total possible throughput of T-MAC to less than half of the maximum throughput of S-MAC. Authors propose two techniques to avoid this problem. However, due to the somewhat higher overhead of

this techniques, energy consumption also increase and hence they propose to use these mechanism only in reasonably high load case. Overhearing avoidance is also possible in T-MAC protocol. However, authors obtain that if they apply overhearing avoidance with a similar mechanism as in S-MAC, collision overhead becomes higher. A node may miss other RTS and CTS packets while sleeping and disturbing some communication when it wakes up. Consequently, the maximum throughput decrease.

RMAC [16]: In S-MAC, in each operational cycle, a packet can be forwarded over only a single hop since an intermediate relaying node has to wait for its next hop along the path to the sink to wake up to receive the packet. Instead of RTS-CTS mechanism, RMAC uses a small control frame called PION for a transmission request and an acceptance of the transmission request. PION packet has dual function. A node transmits a single PION to confirm the receipt of a PION packet from its upstream node and to simultaneously request communication from a downstream node. When a node has data to send, it initiates PION transmission. In RMAC, an operation cycle of a node can be divided into three stages: SYNC, DATA, and SLEEP. Similar to S-MAC protocol, RMAC also assumes that a synchronization between neighboring nodes is provided by a separate protocol during the SYNC period. The DATA period is only used to send and receive the PION packets. All data frames are transmitted in the SLEEP period. The nodes which have sent or relayed a PION must wake up at some specific time to transmit or forward the data packets. During a SLEEP period, nodes wake up to relay data packets. These wake up time are set by the PION packets. RMAC protocol has capable of multihop data delivery in a single operational cycle therefore it provides considerable decrease in end-to-end latency compared to SMAC.

2.2. Energy Efficiency in Wireless Sensor Network

The NAV is also used in RMAC. Its usage is slightly different than as in IEEE 802.11. An overview of RMAC protocol can be seen in Figure 2.4.

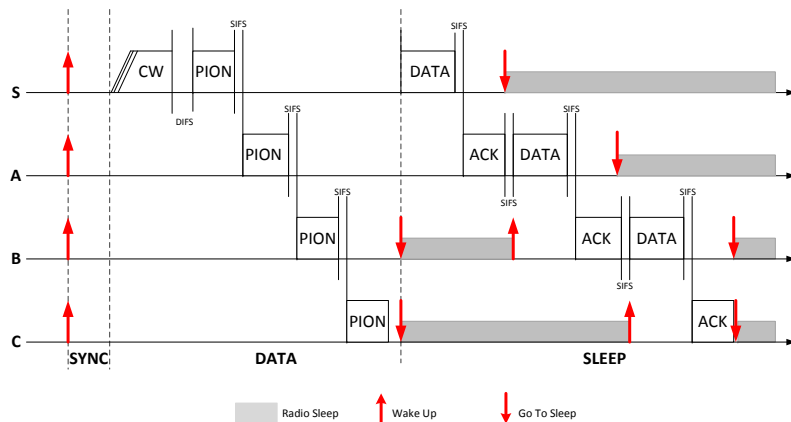

Figure 2.4: RMAC protocol overview [16]

B-MAC [42]: It is a CSMA-based MAC protocol for wireless sensor network. It uses asynchronized duty-cycling scheme and duty cycles the radio through periodic channel sampling. This periodic channel sampling named as Low Power Listening (LPL). Each node has a sleep and an active period and can have an independent schedule. Nodes send a preamble before sending the actual data packets. Each time a node wakes up, it turns on the radio and checks for channel activity. If it detects a preamble, it stays awake for the time required to receive the packet. After reception, the node switches to the sleep mode. The preamble length must be at least as long as a channel check interval. An idle listening mode occurs when the node wakes up to sample the channel and there is no an activity. Even if

the receiver immediately hears the preamble after channel sampling, data-ack exchange cannot start before the preamble finished. B-MAC does not have the RTS-CTS mechanism or synchronization requirement of S-MAC and T-MAC. The implementation is simpler and smaller in RAM and ROM size. However, B-MAC suffers the overhearing problem: receivers which are not destination also wake up and have to stay active until the end of the preamble to find out if the packet is destined for them.

XMAC [7]: This protocol is very similar to B-MAC. It proposes a new approach to low power listening in B-MAC. Basically, it employs a short preamble to further reduce energy consumption of the idle listening and to reduce latency. It also solves the overhearing problem by embedding the destination address in the preamble so that non-target receivers can go back to sleep. If a node wants to send a packet, it transmits a short preamble with a short pause between them. This allows the target receiver sending an acknowledgment and data exchange can start without waiting until the end of a long preamble period. In order to guarantee the preamble reception, the length of the total preamble sequence must be greater than the sleep period. The protocol allows designers to choose maximum and minimum sleep periods to bound the latency and energy consumption, respectively.

Concluding Remarks on MAC protocols for WSNs;

Synchronized protocols [56, 52, 16], such as S-MAC, T-MAC, R-MAC, agree on a schedule that specifies when the nodes are in active mode in a duty-cycling period and in this way they reduce the idle listening. On the other side, asynchronous protocols [42, 7], such as B-MAC and X-MAC, employ a preamble sampling also called low power listening to reduce

2.2. Energy Efficiency in Wireless Sensor Network

the idle listening without synchronization between the nodes. However, latency in asynchronous protocols is higher than synchronized ones.

A comparison of duty-cycling MAC protocols for WSNs is presented in [24]. They compare T-MAC, S-MAC and combination of low power listening with these protocols. They show that T-MAC in combination with low power listening provides very low power consumption. However, T-MAC performs worse than Low Power Listening and S-MAC in case of the heavy load. For many WSN applications, the latency requirements are loose. Therefore, asynchronous duty-cycling schemes are more preferable than synchronized schemes in terms of energy consumption. Because they do not incur synchronization overhead. In asynchronous protocols, to reduce latency and to increase throughput, nodes wake up more often with a very short active period. However, none of the studies considers the transition energy of radio from sleep mode to active mode or vice versa. In fact, the cost of turning off the radio is the same for all protocols. However, the difference between protocols is how long the radio is in active mode after it has been turned on and how many times the radio switches between on and off states. There is a trade off between energy consumption and network performance parameters such as latency and throughput. The type of duty-cycling MAC scheme should be chosen based on the design goals and constraints.

3

Mathematical Programming of Maximum Lifetime Routing Problem in Sensor Network

3.1 Introduction

The lifetime of the sensor network is defined as the time period until the first node runs out of battery (minimum individual node lifetime), as in [9], [25], [34], or a certain percentage of the network nodes go flat

(n_{th} minimum individual node lifetime), as in [6], [55]. In the scope of this study, different than existing definition in the literature the network lifetime is defined as time span which allows maximum amount of data delivery to the sink node and achievable maximum amount of data is restricted by the nodes' initial energy level.

In this chapter, the main focus is how to route the packets in energy balanced way so that it leads to maximum lifetime of the network. In other words, for a given data rate and battery capacity, the upper bound on the network lifetime that can be achieved by routing the flows between the links is sought. To do this, the problem is formulated as a linear programming problem (LP). All studies in the literature [9], [10], [53], [21], [36], [13], which try to formulate the maximum lifetime routing problem focus only on the operational lifetime by assuming that nodes spend no energy in idle mode or sleep mode. However, the novel mathematical programming formulation, which is introduced here, considers the data transmission and reception time, the idle time, the individual lifetime of the nodes as well as their relationship with the network lifetime.

A numerical example is given to illustrate the application of the LP to a simple network and to show the effect of idle mode energy consumption on to the network lifetime.

3.2 System Model and Parameters

To be able to identify the networking process variables and to state the specific characteristics of interest, the system model for the sensor network is described under the following four subsections.

3.2.1 Data Generation Scheme and Data Flow Pattern

In this thesis, a monitoring application of the sensor networks is considered. Sensor nodes monitor the environment and generate data periodically. There is a many-to-one data flow scheme, which means that there will be only one sink node to collect the data from N numbers of sensor nodes. Sensor nodes have two tasks to be handled in the network: sending their own sensed data and relaying the data from their neighbors. If a sensor is located far from the sink node (gateway), it transmits the data to the nodes in its communication range to be sent to the sink. There are many paths to access the sink node and it is assumed that packet delivery up to the networking layer is guaranteed by the PHY and the MAC layer mechanisms.

3.2.2 Energy Consumption Model for Sensor Nodes

Operation modes of a sensor node are data generation, data processing, data transmission, data reception, sleeping and idle (neither transmitting nor receiving). In this study, only the energy consumption when the transceiver is in transmission (Tx), reception (Rx), and idle mode is considered since radio has the major part on energy consumption of a sensor node. Table 3.1 shows the energy consumption characteristics for the CC2420 radio [1].

CC2420 radio has three power-saving levels: low power mode 1, 2 and 3 (LPM1, LPM2 and LPM3 respectively) [1]. LPM1 saves energy by turning off the radio frequency synthesizer which controls channel selection and up/down RF conversion. In addition to the frequency synthesizer, LPM2

power down mode also turns off the crystal oscillator which provides the timing reference for the entire radio chip. The final power-saving level is the LMP3 power off mode. This mode turns off the voltage regulator which powers the radio chip. Turning off the crystal oscillator in LPM2 with receive data waiting in the radio receive buffer would delay the data transfer to the microcontroller. The radio needs the timing signal generated from the crystal oscillator circuit to clock the data onto the system bus. The received data would be delayed in LPM2, but not lost. However, turning off the voltage regulator in LPM3 with data in either the receive or the transmit buffer would cause the data to be lost in the radio RAM memory.

| Mode of Operation | Energy per second |
|-------------------|----------------------|
| Tx@ 0 dBm | $e_{tx}=31.32$ mW |
| Rx | $e_{rx}=35.46$ mW |
| Idle Listening | $e_{idle}=35.46$ mW |
| LPM1 | $e_{LPM1}=0.7668$ mW |
| LPM2(sleep) | $e_{LPM2}=0.036$ mW |
| LPM3(power off) | $e_{LPM3}=0.001$ mW |

Table 3.1: Energy Consumption Characteristics for CC2420 Radio

3.2.3 Individual Node Lifetime and Network Lifetime

In the scope of this study, the network lifetime is defined different than the existing definitions in the literature in the context of energy deficiency; network lifetime is not the time until the first or few nodes of the network runs out of their battery, neither it is equal to the minimum of individual node lifetime values. The reason for this definition differing from the

3.2. System Model and Parameters

existing studies is because the individual node lifetime is defined as sum of the time spend in all operation modes and it considers the energy consumption of idle modes as well as data transmission and reception modes. Therefore, for the measure of no functionality of the network, the networking activity is considered as well as battery level. Keeping this in mind, the network lifetime is defined as the time span which allows nodes to deliver the maximum amount of data to the sink node. For example, if there is no networking activity (transmission and reception), the lifetime of the nodes will be longer (their battery last in longer time) due to lower energy consumption of idle mode, but network lifetime will be zero because transmitted data to the sink node will be zero. Until the network lifetime, all nodes in the network communicate with each other to deliver the data to the sink node. However, nodes, whose individual lifetime is longer than network lifetime, spend their rest of the energy in idle mode. Because, it is assumed that no networking activity like exchanging data between nodes is possible after the network lifetime.

3.2.4 Duty cycling

Duty cycling is the most important way of saving energy in sensor networks. In this way, sensor nodes are forced to sleep when they are not transmitting or receiving. In this chapter, duty cycling is considered only in the numerical example, by assuming that nodes will spend the whole idle time in sleep mode. The energy saving rate of sleep mode is shown analytically.

3.3 Mathematical Model For The Maximum Lifetime Routing

3.3.1 Problem Definition

Each node n of the network has an initial energy $E_{initial}^n$, and they generate data with a predefined rate g_n . The problem is to determine the optimum total amount of flow f_L on each link \check{L} for the maximum lifetime. The network lifetime is defined as the time in which all nodes of the network are communicating and alive (enough energy in their battery), and determine its relationship with the individual node lifetime, data generation rates and, idle time, in a linear programming framework [37].

3.3.2 Problem Formulation

The wireless sensor network is modeled as a directed graph $G(N, \check{L})$ where N is the set of all nodes, and \check{L} is the set of the links between them. If two nodes n and m are connected by a directed link, they can communicate with each other. Direction of the link is determined from farther node to the closer one to the sink node. For the connection of node n with any node m , a variable is defined to represent the total flow on an outgoing links of n as $f_{l_{nm}}$ and this variable also represents the total flow on an incoming link of m .

3.3. Mathematical Model For The Maximum Lifetime Routing

For the sake of notation, let variables $f_L^{O_n}$ and $f_L^{I_n}$ represent the total amount of flow (f_l) during the network lifetime on the outgoing (O_n) and incoming (I_n) links of a node n , respectively, and depicted as follows:

$$f_L^{O_n} = \sum_{l_{nm} \in O_n} f_{l_{nm}} \quad n, m \in N, L \in \check{L} \quad (3.1)$$

$$f_L^{I_n} = \sum_{l_{mn} \in I_n} f_{l_{mn}} \quad n, m \in N, L \in \check{L} \quad (3.2)$$

The lifetime, T_n , of the individual node n is formulated as being the sum of the time spent in transmission, reception, and idle mode of operation, and it is depicted as follow;

$$T_n = f_L^{O_n} \cdot t_{tx} + f_L^{I_n} \cdot t_{rx} + t_{idle}^n \quad n, m \in N, L \in \check{L} \quad (3.3)$$

In equation (3.3), t_{tx} and t_{rx} are constant and represent the transmission time and the reception time of a data packet respectively, hence $f_L^{O_n} \cdot t_{tx}$ represent the total transmission time and $f_L^{I_n} \cdot t_{rx}$ represent the total reception time for a node n at the end of its lifetime. Note that t_{tx} and t_{rx} will differ based on the data packet size and speed of the transceiver. t_{idle}^n is a variable and represents the total idle time of the node spent in its whole lifetime.

The objective function of the linear programming model is the network lifetime parameter T_{net} . Based on the network lifetime definition, all nodes in the network need to be alive until the network lifetime T_{net} ,

this relationship between individual node lifetimes and network lifetime is depicted as follows:

$$T_n \geq T_{net} \quad n \in N \quad (3.4)$$

To provide the optimization constraints and determine the relationship between these constraints and the objective function, two set of mathematical expressions are derived for the flow variables. The first set of expressions is for the conservation of the flow in each node n : Total flow out of a node n is the sum of the total generated data at the node n and the total flow into the node n during the lifetime of the network and is depicted as follows:

$$f_L^{O_n} = g_n \cdot T_{net} + f_L^{I_n} \quad n \in N, L \in \check{L} \quad (3.5)$$

Note that, if a node generates data packets at a rate of g_n , it generates a total of $g_n \cdot T_{net}$ data packets during the network lifetime T_{net} . Equation.(3.5) provides an optimization constraint on the flow variable as well as it determines the network lifetime T_{net} as a function of the flow variables. There is a number of N flow conservation equations in total.

The second set of expressions for the flow variables is derived to state the energy limitation of the nodes: the total energy consumption of a node throughout the lifetime of the network is the sum of the energy

3.3. Mathematical Model For The Maximum Lifetime Routing

consumption in the transmission, reception and idle mode of operation, and cannot exceed its initial energy. This is depicted below:

$$e_{tx} \cdot f_L^{O_n} \cdot t_{tx} + e_{rx} \cdot f_L^{I_n} \cdot t_{rx} + e_{idle} \cdot t_{idle}^n \leq E_{initial}^n \quad n \in N, L \in \check{L} \quad (3.6)$$

Where e_{tx} , e_{rx} and e_{idle} are the energy consumed per unit time when the radio is in the transmission, reception and idle mode of operation respectively. For a node n , while the first component on the left side of Equation.(3.6) represents the total consumed energy in transmission, second and third components represent the total consumed energy in reception and idle mode respectively during the whole lifetime of the node n . Note that, this equation is valid for each node n of the network, so there is a number of N energy related equations in total.

In the following, it is shown that, the problem of maximizing the network lifetime, given the data generation rate g_n , is equivalent to a linear programming problem. Features and units of the symbols which are used in the linear programming are shown in Table 3.2.

Objective function :

$$\begin{aligned} & \text{maximize} \quad T_{net} \\ & \text{subject to} \end{aligned} \quad (3.7)$$

1st constraint : Flow Conservation Law;

$$f_L^{O_n} - f_L^{I_n} = g_n \cdot T_{net} \quad (3.8)$$

2nd constraint : Energy constraint;

$$e_{tx} \cdot f_L^{O_n} \cdot t_{tx} + e_{rx} \cdot f_L^{I_n} \cdot t_{rx} + e_{idle} \cdot t_{idle}^n \leq E_{initial}^n \quad (3.9)$$

3rd constraint : Lifetime of the individual node n ;

$$T_n = f_L^{O_n} \cdot t_{tx} + f_L^{I_n} \cdot t_{rx} + t_{idle}^n \quad (3.10)$$

4th constraint : Non – negativity of the flows;

$$f_L^{O_n}, f_L^{I_n} \geq 0 \quad (3.11)$$

5th constraint : Relationship between T_n and T_{net} ;

$$T_n \geq T_{net} \quad (3.12)$$

$n \in N, L \in \check{L}$ for all above equations and inequalities.

Note that the first constraint also models the fairness principle between the nodes. Heuristically, one can say if each node of the network avoids being the relay node for its neighbors as much as possible, this individual selfish behavior of each node would lead to the maximization of individual node lifetime. Since energy consumption for reception appears explicitly in the second set of constraints, the optimization model provides fair distribution of the relay traffic (traffic on incoming links of each node) between the nodes. This can be interpreted as reducing selfish behavior of each node simultaneously. Note that, the first constraint formulates the network lifetime definition, because maximizing T_{net} also provides the maximization of the total generated traffic in the network. However, left side of the first constraint provides the data delivery to the sink node with a flow conservation at the each node.

3.3. Mathematical Model For The Maximum Lifetime Routing

| Symbol | Feature | Unity |
|-----------------|--|---------------------|
| T_{net} | Network lifetime | <i>Second</i> |
| O_n | Set of outgoing links of node n | - |
| I_n | Set of incoming links of node n | - |
| $f_L^{O_n}$ | Total amount of data flow on O_n during the lifetime of the network | - |
| $f_L^{I_n}$ | Total amount of data flow on I_n during the lifetime of the network | - |
| e_{tx} | Energy consumed per unit time when the radio is in the transmitting mode independent from the link | <i>Joule/Second</i> |
| e_{rx} | Energy consumed per unit time when the radio is in the reception mode independent from the link | <i>Joule/Second</i> |
| e_{idle} | Energy consumed per unit time when the sensor node is in idle mode | <i>Joule/Second</i> |
| g_n | Data generation rate of node n | $1/s$ |
| t_{rx} | Time consumed to receive a packet | <i>Second</i> |
| t_{tx} | Time consumed to transmit a packet | <i>Second</i> |
| t_{idle}^n | Idle time of a node n | <i>Second</i> |
| T_n | The individual lifetime of node n | <i>Second</i> |
| $E_{initial}^n$ | The initial energy of node n | <i>Joule</i> |

Table 3.2: Feature and Units of the Symbols

3.4 A Numerical Example

In this section, the application of the LP is demonstrated in an example network. A simple example is chosen in an attempt to gain insight from the optimization model. Using the optimization model, the effect of consideration of idle mode energy consumption and power saving levels on the network lifetime is shown.

For the numerical values, we use the following settings: each node has 1.8V AA batteries with 2200mAh current capacity hence 14256 joule initial energy. Nodes have CC2420 radio [1] (Table 3.1), data transmission rate is 250kbps, packet size is 100 bytes, and each node has the same packet generation rate. Packet transmission and reception take 3.2ms (t_{tx} and t_{rx} are 3.2ms).

For this numerical example, the topology in Figure 3.1 is used. There is no special reason for choosing this topology; it is only used for illustration purposes. There are 10 directed links between the nodes and total 18 variables for the optimization model (f_L flow variables (10) + t_{idle} variables (7) + T_{net} (1)). These links show the possible next hop neighbor to access the sink node and it is assumed that they are determined by a route discovery process. All nodes of the network are generating data at the same rate. By solving the LP, the total amount of routed traffic through each link and idle time of each node in the network for the objective of maximization of the network lifetime are obtained.

Firstly, the LP problem is solved for different data generation rates. Three cases are considered: (i) nodes are always awake and does not switch any power saving mode. (ii) nodes switch to LPM1 while they are not

3.4. A Numerical Example

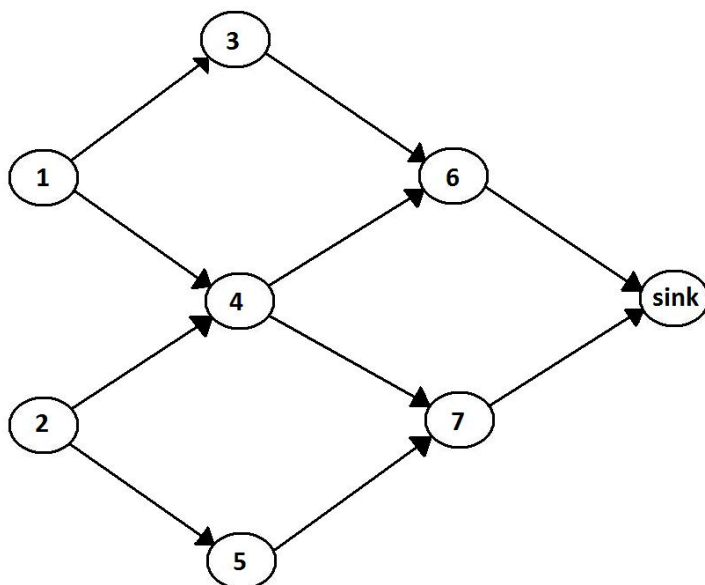

Figure 3.1: Example network topology with 7 nodes and 1 sink node

transmitting or receiving. (iii) nodes switch to LPM2 while they are not transmitting or receiving.

For the case (i), the effect of data generation rate on network lifetime is too small since idle listening has the major part of whole energy consumption (energy consumption when node is in idle listening mode is same as in reception mode). However, for the case (ii) and (iii), when data generation period is increased, nodes spend less time for the transmission and the reception and more time in low power modes (see Table 3.1). Therefore, network lifetime is expected to be higher for the case of longer data generation period (lower data generation rates). As

it can be seen from the Figure 3.2, Figure 3.3 and Figure 3.4, results obtained based on the LP formulation are compatible with this behavior of the network for all three cases. For the sake of illustration, instead of data generation rates, data generation periods is used in the figures: $datagenerationrate = 1/datagenerationperiod$.

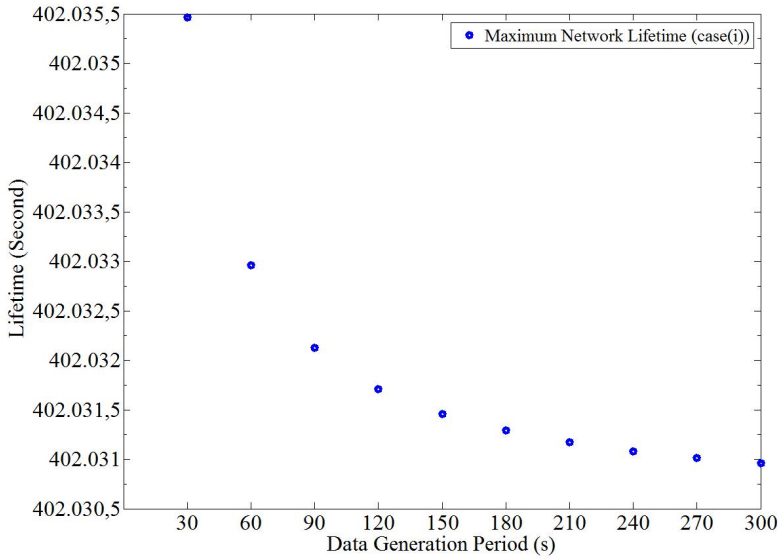

Figure 3.2: Maximum network lifetime versus data generation periods for the case (i)

Note that, for the case(ii) and (iii), it is assumed that nodes switch on low power modes after each transmission and reception. However, in practice nodes need time to listen to the channel for transmission and reception also they have to be coordinated to pursue the communication, but here this is ignored. The aim is to investigate the energy saving rate of different power saving levels in an analytical framework. These scenarios

3.4. A Numerical Example

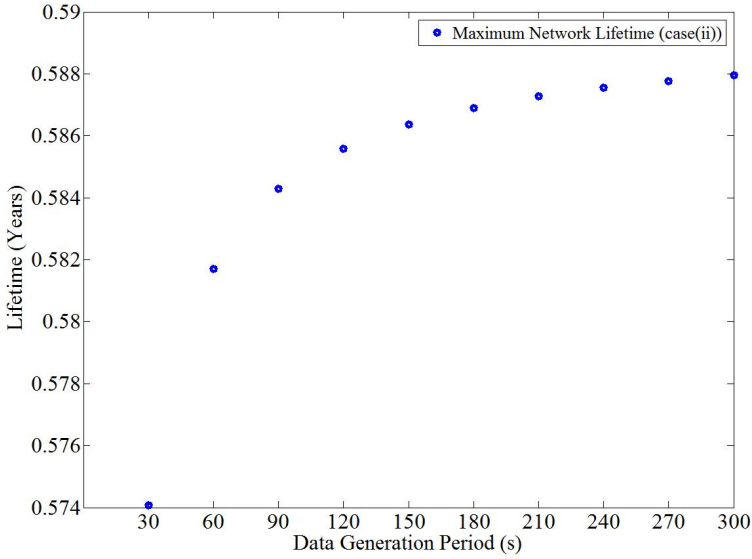

Figure 3.3: Maximum network lifetime versus data generation periods for the case (ii)

corresponds to use e_{LPM1} , e_{LPM2} (Table 3.1) in the 2^{nd} constraint of the optimization problem instead of using e_{idle} (Table 3.1) ($e_{idle} = e_{LPM1}$ in the Figure 3.3 and $e_{idle} = e_{LPM2}$ in Figure 3.4). If nodes switch on LPM3 their data in receiver buffer is lost. Therefore, only LPM1 and LPM2 are investigated. If the results are compared with the case (i), it is seen that putting the nodes in low power modes substantially extends the network lifetime. However, ignoring the idle mode energy consumption results an enormous difference on calculated maximum network lifetime.

In the following, for the case(i), the individual node lifetime values in Figure 3.5, idle time values in Figure 3.7 and total transmission and reception times for the nodes in Figure 3.6 are shown. As it is seen from

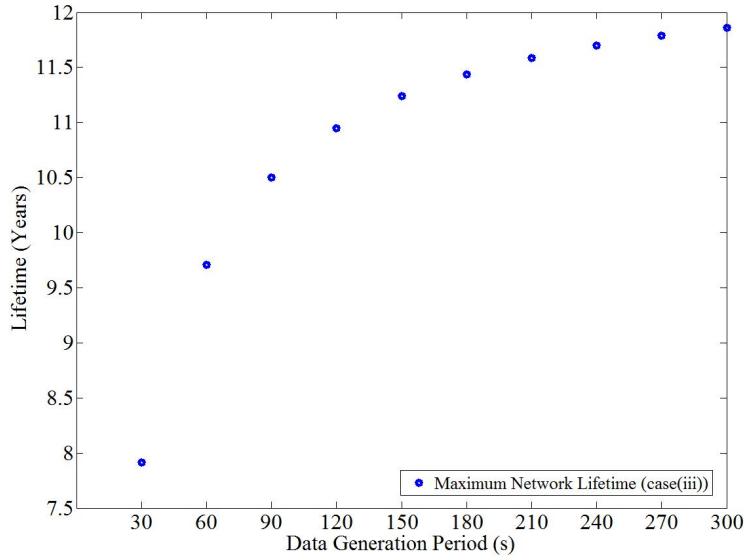

Figure 3.4: Maximum network lifetime versus data generation periods for the case (iii)

the figures these values are compatible with the traffic load of nodes in the network.

In the following, for the 30 second data generation period, Table 3.3 shows the total traffic allocation to the links for the maximum lifetime. In this topology, node number one, two and four have two possible routes for the destination, and rest of the nodes have only one route option to access the sink node. For the energy fairness, it might be expected that nodes, which have same length route choices, allocate their outgoing traffic equally between these routes for the fair load distribution. However, for the maximum network lifetime it is straightforward that load distribution

3.5. Conclusion

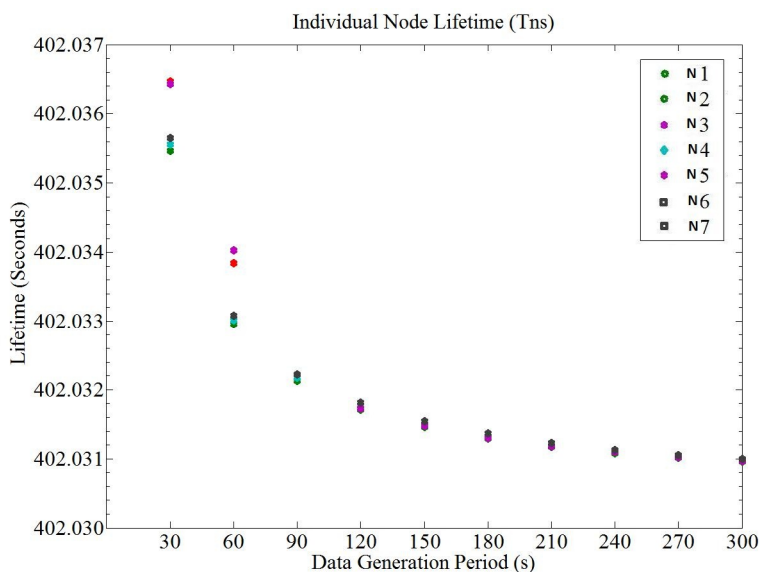

Figure 3.5: Individual node lifetime versus data generation periods for the case (i)

should follow the symmetry in the network as shown in Table 3.3 as it is also obtained by the solution of LP.

3.5 Conclusion

In this chapter, the problem of maximum lifetime routing is investigated. The main objective was to determine the optimum total amount of flow for each link, to be assigned by a routing algorithm, which leads to the maximization of the network lifetime. To do this, the routing problem is formulated for maximizing the network lifetime as a linear programming problem. By solving this linear programming problem, upper bound on

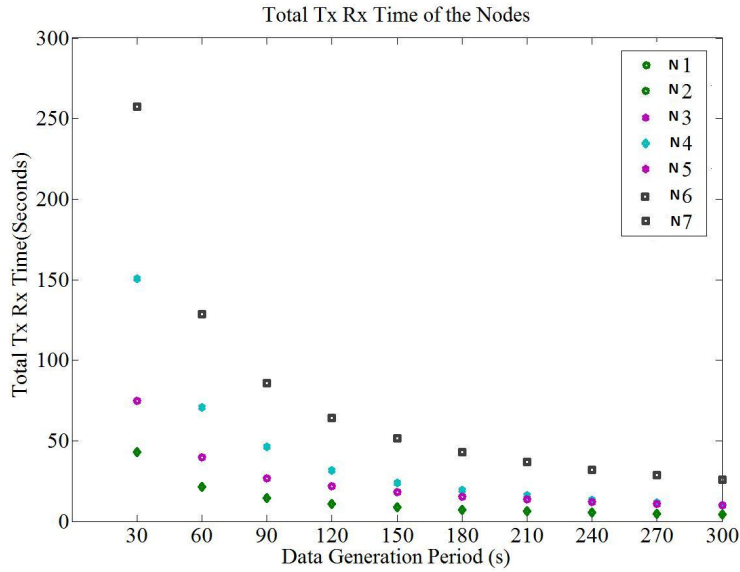

Figure 3.6: Total transmission-reception time versus data generation periods for the case (i)

the network lifetime, lifetimes of the individual nodes, idle time for each nodes and total flow on each links of the network can be calculated.

This is the first mathematical programming of the maximum lifetime routing problem that considers the operation modes of the node. Therefore, it serves as an analytical tool to study the effect of energy consumption of the idle or sleep mode on the network lifetime as well as investigation of allowable duty cycle parameter for a given data generation rates. In addition, since individual node lifetime can be analyzed respect to different data generation rates, it provides to study efficient node deployment strategies to prevent routing holes.

3.5. Conclusion

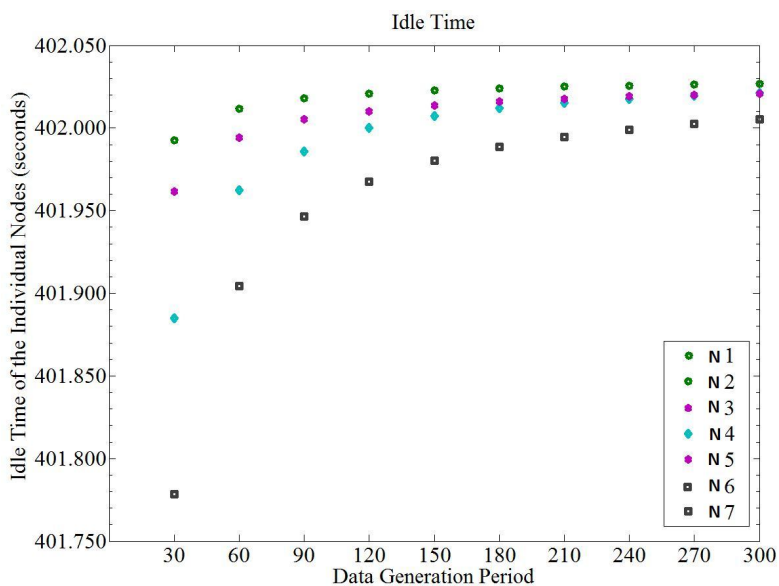

Figure 3.7: Total idle time of the nodes versus data generation periods for the case (i)

Currently, proposed linear programming approach is centralized. In other words, neighbor nodes of each node of the network need to be known to determine the links (flow variables). However, for the practical use of the optimization model, there is a need of distributed solution of the problem.

| Link (node n to m) | Flow values (packet) awake | Flow values (packet) LPM1 | Flow values (packet) LPM2 |
|-----------------------------------|---------------------------------------|--------------------------------------|--|
| L_{13} | $4.97 * 10^3$ | $20.75 * 10^4$ | $2.99 * 10^4$ |
| L_{14} | $8.42 * 10^3$ | $39.58 * 10^4$ | $828.85 * 10^4$ |
| L_{24} | $8.42 * 10^3$ | $39.58 * 10^4$ | $828.85 * 10^4$ |
| L_{25} | $4.97 * 10^3$ | $20.75 * 10^4$ | $2.99 * 10^4$ |
| L_{36} | $18.37 * 10^3$ | $81.10 * 10^4$ | $834.84 * 10^4$ |
| L_{46} | $15.128 * 10^3$ | $69.76 * 10^4$ | $1244.8 * 10^4$ |
| L_{47} | $15.128 * 10^3$ | $69.76 * 10^4$ | $1244.8 * 10^4$ |
| L_{57} | $18.37 * 10^3$ | $81.10 * 10^4$ | $834.84 * 10^4$ |
| L_{6-Sink} | $46.90 * 10^3$ | $211.21 * 10^4$ | $2911 * 10^4$ |
| L_{7-Sink} | $46.90 * 10^3$ | $211.21 * 10^4$ | $2911 * 10^4$ |

Table 3.3: Total Traffic Load Allocation to the Links For Maximum Lifetime

4

Minimum Duty Cycling for Maximum Lifetime Routing

4.1 Introduction

In this chapter, linear programming formulation of the maximum lifetime routing problem is extended for duty-cycling sensor network. For a given data rate, duty-cycling parameter and battery capacity, the upper bound on the network lifetime, which can be achieved by a routing mechanism,

is sought. Note that this formulation does not address the coordination of duty cycling of each node based on the routing decision; instead it provides upper bound value on the network lifetime which can be achieved by a routing mechanism on top of a duty-cycling scheme which is already coordinated by a synchronization mechanism.

The existing studies in the literature [9], [10], [53], [21], [36], [13], which try to formulate maximum lifetime routing problem focus only on operational lifetime by assuming that nodes spend no energy in idle mode or sleep mode. In addition, none of them considers the duty cycling in the sensor networks. However, this new mathematical programming formulation considers the idle time and the sleep time as well as operational time. This is the first mathematical programming formulation of maximum lifetime routing problem that considers energy consumption in idle mode and sleep mode and tackle the problem in duty-cycling sensor network. By solving the problem, total time, which each node spend in transmission, reception, idle and sleep modes, total traffic on each link of the network, and nodes' expected relay load for maximum lifetime can be obtained. Therefore, the formulation provides a mathematical tool that can be used to study the routing strategy in duty-cycling sensor network for the maximum lifetime, and optimal solution provided by this formulation can be used as a benchmark for designing new heuristic routing algorithms.

4.2 Related Work

In this section, related research efforts are briefly summarized on formulation of maximum lifetime routing problem.

4.2. Related Work

Chang and Tassiulas [9] formulated the problem of maximum network lifetime routing as a Linear Programming (LP) problem and defined the lifetime as the time until the first node runs out of the energy. In fact, the authors of [9] were the first to treat this problem as an LP problem. The solution of the LP problem corresponds to the flow rates allocated to each link. It is important to note that the network lifetime variable T in the objective function of the LP problem should be considered as an independent variable in order to see formulation as an LP problem. Following the study in [9], there have been several studies, [34], [46] which develop distributed or centralized algorithms to attempt to solve this LP numerically. Since, the LP formulation in [9] does not propose any strategy that would indicate how a routing protocol policy can provide the required flow rates for each link for the maximum lifetime, many studies develop heuristic routing algorithms by taking solution of the LP as a theoretical upper bound to compare the performance of their heuristic routing algorithms [25], [39]. However, in [13], the authors introduce a theory for maximizing the lifetime and present an optimal centralized solution to form an iterative algorithm. The algorithm attempts to find a Pareto Optimal (PO) solution. In the first iteration of the algorithm, the minimum lifetime of the network is maximized. If the solution is not PO, a second iteration is performed which maximizes the second minimum lifetime, subject to the minimum lifetime being maximum. In fact, running the algorithm in [13] for the first iteration is identical with [9] and it is expected that the maximum lifetime value will be equal, but the algorithm in [13] is able to attain higher first minimum lifetimes than the LP described in [9]. The reason behind this is the assumption of independency of the network lifetime from the flow rates values in the formulation of [9]. It should be noted that, in fact this is the fundamental assumption which

makes the problem to be formulated as an LP. In the studies [10], [53], [21] and [36], network lifetime is considered jointly with other problems, such as delay, bandwidth, energy allocation and node deployment problems.

All these studies on formulation of maximum lifetime routing problem focus only on the operational lifetime by assuming that nodes spend no energy in idle or sleep mode. However, a novel mathematical programming formulation, which is introduced in this chapter, considers the idle and the sleep time. In the formulation, unlike the LP in [9], network lifetime is formulated as a function of flow values on each link. Another important feature of the formulation is that the maximum lifetime routing problem is formulated by considering the existing synchronized duty-cycling mechanism in the sensor network, so it also makes possible to analyze the relationship between the duty-cycling and the maximum lifetime routing.

4.3 System Model and Parameters

In this chapter, except from the duty-cycling and energy consumption model system model is similar to the model in previous chapter. Data generation scheme and data flow pattern, and also definition of individual node lifetime and network lifetime is the same. In the following, modification in the energy consumption model and duty-cycling scheme is presented in two subsection.

4.3.1 Energy Consumption Model for Sensor Nodes

As it is in previous chapter only communication related energy consumptions (when radio is in transmission (Tx), reception (Rx), idle and sleep mode) are considered and energy consumption for data generation and processing is ignored. Different than previous chapter, it is assumed that each transceiver is able to adjust its power level for transmission based on the distance from the next hop destination and the predefined RSSI value [1]. However, each node has the same power consumption when they are in reception, idle and sleep mode. Table 4.1 shows the energy consumption characteristics for the CC2420 transceiver [1] for different modes of operation and different transmission and power saving levels. Note that, turning off the voltage regulator in LPM3 with data in either the receive or the transmit buffer would cause the data to be lost in the radio RAM memory. Therefore, for the sleep state the power down mode is chosen as the power-saving level not the power off mode.

4.3.2 Duty Cycling

In duty-cycling sensor network, the node is either in active mode (transceiver is on) or sleep mode (transceiver is off) based on predetermined duty-cycling parameter. The active time of a transmitter consists of transmission time, reception time and idle listening time (as shown in Figure 4.1). In sleep mode, only radio component of the node is off, the node continues to monitor the environment, hence generates data. In this chapter, a duty-cycling sensor network is considered in which the synchronization between nodes already exists. Nodes in a routing path are active at the same time

| Mode of Operation | Energy per second |
|-------------------|-------------------------|
| $Tx@0dBm$ | $e_{tx}=31.32$ mW |
| $Tx@ - 5dBm$ | $e_{tx}=25.2$ mW |
| $Tx@ - 10dBm$ | $e_{tx}=19.8$ mW |
| $Tx@ - 15dBm$ | $e_{tx}=17.82$ mW |
| $Tx@ - 25dBm$ | $e_{tx}=15.3$ mW |
| Rx | $e_{rx}=35.46$ mW |
| $Idle$ | $e_{idle}=35.46$ mW |
| $LPM1$ | $e_{idle}=0.7668$ mW |
| $LPM2(sleep)$ | $e_{sleep}=0.036$ mW |
| $LPM3(poweroff)$ | $e_{poweroff}=0.001$ mW |

Table 4.1: Energy Consumption Characteristics for CC2420 Radio

to pursue the communication. All nodes in the network have fixed duty-cycling parameters. Individual node lifetime consists of k numbers of duty cycling period. In each duty-cycling period, sleep time and active time of the node are fixed based on a predetermined duty-cycling parameter (as shown in Figure 4.1). Duty-cycling parameter gets value between 0 and 1. For instance if a node works at 0.1 *percent* of duty-cycling parameter, this means that the node will be active for 1*second* in each 1000*s* duty-cycling period, hence will be in active mode for 0.1 *percent* of its whole lifetime.

In the first part of the formulation, it is not interested in duration of each duty cycling period or number of these periods. On the other hand, it is focused on the total time that node spent in each operation mode at the end of network lifetime. Later, the formulation is extended to investigate the effect of duration of each duty-cycling period (Cycle Time).

4.4. Mathematical Programming of the Maximum Lifetime Routing Problem in Duty Cycling Sensor Network

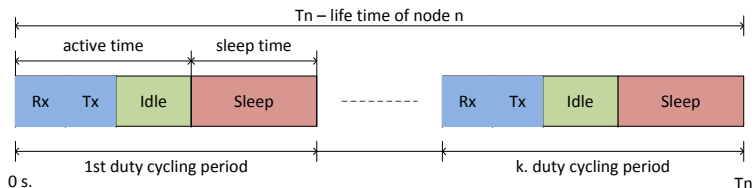

Figure 4.1: Duty-cycling mechanism for any node in the network

4.4 Mathematical Programming of the Maximum Lifetime Routing Problem in Duty Cycling Sensor Network

4.4.1 Problem Definition

Each node n of the network has an initial energy $E_{initial}^n$ (joule), generates data with a predefined rate g_n (packet/second) and performs a duty-cycling scheme. The problem is to determine the total routed flow f_L on each link L for the maximum lifetime in duty-cycling sensor network. The network lifetime is defined as the time period in which all nodes of the network are communicating and alive (enough energy in their

battery). Relationship between the network lifetime, the individual node lifetime, data generation rates, sleep time and idle time is determined in a linear programming framework [37].

4.4.2 Problem Formulation

Wireless Sensor Network is modeled as a directed graph $G(N, \check{L})$ where N is the set of all nodes, and \check{L} is the set of the links between them. If two sensor nodes n and m are in each other's communication range, they are connected and there is one directed link between them from n to m . For the connection of node n with any node m , a variable is determined to represent the total flow on an outgoing link of n as $f_{l_{nm}}$ and this variable represent also the total flow on an incoming link of m . However, all data generated by the nodes is aggregated in a single sink node and the communication link between sink node and sensor nodes are directed from sensor nodes to the sink node. Therefore, for the connection of a node n with the sink node, only one variable is defined to represent the flow on an outgoing link of n . For the sake of notation, let $f_L^{O_n}$ and $f_L^{I_n}$ represent the total amount of flow during the network lifetime on the outgoing links (O_n) and incoming links (I_n) of a node n respectively and are depicted as follow;

$$f_L^{O_n} = \sum_{l_{nm} \in O_n} f_{l_{nm}} \quad n, m \in N, L \in \check{L} \quad (4.1)$$

$$f_L^{I_n} = \sum_{l_{mn} \in I_n} f_{l_{mn}} \quad n, m \in N, L \in \check{L} \quad (4.2)$$

4.4. Mathematical Programming of the Maximum Lifetime Routing Problem in Duty Cycling Sensor Network

The lifetime of the individual node n is formulated as being the sum of the time spent in transmission, reception, idle and sleep mode (see Figure 4.1), depicted as follow;

$$T_n = f_L^{O_n} \cdot t_{tx} + f_L^{I_n} \cdot t_{rx} + t_{idle}^n + t_{sleep}^n \quad n, m \in N, L \in \check{L} \quad (4.3)$$

In Equation 4.3, t_{tx} and t_{rx} are constants and represent the transmission time and the reception time of a data packet respectively, hence $f_L^{O_n} \cdot t_{tx}$ represent the total transmission time and $f_L^{I_n} \cdot t_{rx}$ represent the total reception time for a node n at the end of its lifetime. Note that t_{tx} and t_{rx} will differ based on the data packet size and speed of transceiver. t_{idle}^n and t_{sleep}^n are variables and represent the total idle time and total sleep time of the node spent in its whole lifetime respectively. Note that, on the right side of Equation 4.3, t_{sleep}^n represents the total sleep time of node n while the rest of the terms represents the total active time of node n . The relationship between active time and sleep time is determined by a constant duty-cycling parameter dc and is depicted as follows:

$$T_n - dc \cdot T_n = t_{sleep}^n \quad n \in N, dc \in [0,1] \quad (4.4)$$

Objective function of the linear programming is the network lifetime variable T_{net} . Based on the network lifetime definition, all nodes in the

network need to be alive until the network lifetime T_{net} , this relationship between individual node lifetimes and network lifetime is depicted as follows:

$$T_n \geq T_{net} \quad n \in N \quad (4.5)$$

To provide the optimization constraints and determine the relationship between these constraints and the objective function, two sets of mathematical expressions are derived for the flow variables. The first set of expressions is for the conservation of the flow in each node n : Total flow out of a node n is the sum of the total generated data at the node n and the total flow into the node n during the lifetime of the network and is depicted as follows:

$$f_L^{O_n} = g_n \cdot T_{net} + f_L^{I_n} \quad n \in N, L \in \check{L} \quad (4.6)$$

Note that, if a node generates data packets at a rate of g_n , it generates a total of $g_n \cdot T_{net}$ data packets during the network lifetime T_{net} . Equation 4.6 provides an optimization constraint on the flow variables as well as it determines the network lifetime T_{net} as a function of the flow variables. There is a number of N flow conservation equations in total.

The second set of expressions for the flow variables is derived to state the energy limitation of the nodes: the total energy consumption of a node

4.4. Mathematical Programming of the Maximum Lifetime Routing Problem in Duty Cycling Sensor Network

throughout the lifetime of the network is the sum of the energy consumption in the transmission, reception, sleep and idle mode of operation, and cannot exceed its initial energy. This is depicted below;

$$e_{tx} \cdot f_L^{O_n} \cdot t_{tx} + e_{rx} \cdot f_L^{I_n} \cdot t_{rx} + e_{idle} \cdot t_{idle}^n + e_{sleep} \cdot t_{sleep}^n \leq E_{initial}^n \quad n \in N, L \in \check{L} \quad (4.7)$$

Where e_{tx} , e_{rx} , e_{sleep} , and e_{idle} are the energy consumed per unit time (*joule/second*) when the radio is in the transmitting, reception, sleep and idle mode of operation respectively. For a node n , while the first component on the left side of Equation 4.7 represents the total consumed energy in transmission, second, third, and fourth components represent the total consumed energy in reception, idle and sleep mode respectively (during the whole lifetime of the node n). Note that this equation is valid for each node n of the network, so there is a number of N energy related equations in total.

In the following, with the above derivation it is shown that the problem of maximizing the network lifetime is equivalent to a linear programming problem;

Objective Function : Maximize T_{net}

1st constraint : Flow Conservation Law;

$$f_L^{O_n} - f_L^{I_n} = g_n \cdot T_{net} \quad (4.8)$$

2nd constraint : Energy constraint;

$$e_{tx} \cdot f_L^{O_n} \cdot t_{tx} + e_{rx} \cdot f_L^{I_n} \cdot t_{rx} + e_{idle} \cdot t_{idle}^n + e_{sleep} \cdot t_{sleep}^n \leq E_{initial}^n \quad (4.9)$$

3rd constraint : Lifetime of the individual node n ;

$$T_n = f_L^{O_n} \cdot t_{tx} + f_L^{I_n} \cdot t_{rx} + t_{idle}^n + t_{sleep}^n \quad n, m \in N, L \quad (4.10)$$

4th constraint : Non – negativity of the flows and time;

$$f_L^{O_n}, f_L^{I_n}, t_{idle}^n, t_{sleep}^n, T_{net} \geq 0 \quad (4.11)$$

5th constraint : Relationship between T_n and T_{net} ;

$$T_n \geq T_{net} \quad (4.12)$$

6th constraint : Duty – Cycling of each node n ;

$$T_n - dc \cdot T_n = t_{sleep}^n \quad n \in N, dc \in [01] \quad (4.13)$$

$n \in N, L \in \check{L}$ for all above equations and inequalities.

It should be noted that the first five constraints were already explained in the previous chapter. Furthermore, the sixth constraint formulates that the relationship between active and sleep time with dc parameter.

4.4.3 Numerical Examples

In this section, an application of the LP is demonstrated in two example networks. Simple examples are chosen in an attempt to gain insight from optimization model. Using the optimization model, the minimum duty-cycling parameter, which is allowed for maximization of the network lifetime, is determined. For the numerical values, the following settings are used: each node has 1.8V AA batteries with 2200mAh current capacity

4.4. Mathematical Programming of the Maximum Lifetime Routing Problem in Duty Cycling Sensor Network

hence 14256 *joule* initial energy. Nodes have CC2420 radio [1] (Table 4.1), data transmission rate is 250*kbps*, packet size is 100 *bytes*, and each node has the same packet generation rate. Packet transmission and reception take 3.2*ms* (t_{tx} and t_{rx} are 3.2*ms*). The sensor nodes can work at different power levels based on the distance of the next hop. The observation in an empirical study in the literature [35] is used to set the distance-power level matching for minimum 92.5 *dB* received signal strength value as shown in Table 4.2.

| Power Level | Output Power (dBm) | Power Draw (mW) | Distance (m) | RSSI (dB) |
|-------------|--------------------|-----------------|--------------|-----------|
| 1 | 0 | 31.32 <i>mW</i> | 60 | -91.9 |
| 2 | -5 | 25.2 <i>mW</i> | 35 | -92 |
| 3 | -10 | 19.8 <i>mW</i> | 20 | -92.1 |
| 4 | -15 | 17.82 <i>mW</i> | 15 | -92.4 |
| 5 | -25 | 15.3 <i>mW</i> | 10 | -92.3 |

Table 4.2: Distance-Power Level Matching For CC2420 Radio

4.4.4 Example I

In this example, the LP is applied to a simple network in Figure 4.2. The aim is to show how the variables are determined and the constraints are derived for the optimization model. Then the relationship between network parameters and network lifetime is investigated.

The distances between nodes are set as 35*m* and transmission ranges of all nodes are 35*m*. Hence, nodes work at power level 2 (-5*dBm*) for the

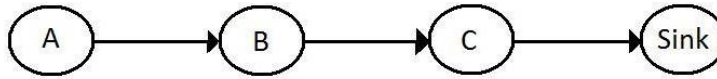

Figure 4.2: Example Network

transmission. The data generation period is the same for all nodes. In this topology, each node has only one available path to access the sink node, so there is only a single possible routing choice for each node. Therefore, in this example only upper bound on network lifetime is obtained for a given duty-cycling parameter and data generation rates, and then the lowest duty-cycling parameter is found for the maximum lifetime.

Optimization model has 10 variables and it is shown below;

Maximize T_{net}

1st constraint : Flow Conservation Law;

$$f_{AB} = g_A \cdot T_{net}$$

$$f_{BC} - f_{AB} = g_B \cdot T_{net}$$

$$f_{CS} - f_{BC} = g_C \cdot T_{net}$$

(4.14)

4.4. Mathematical Programming of the Maximum Lifetime Routing Problem in Duty Cycling Sensor Network

2nd constraints : Energy constraints;

$$\begin{aligned}
 e_{tx} \cdot f_{AB} \cdot t_{tx} + e_{idle} \cdot t_{idle}^A + e_{sleep} \cdot t_{sleep}^A &\leq E_{initial}^A \\
 e_{tx} \cdot f_{BC} \cdot t_{tx} + e_{rx} \cdot f_{AB} \cdot t_{rx} + e_{idle} \cdot t_{idle}^B + e_{sleep} \cdot t_{sleep}^B &\leq E_{initial}^B \\
 e_{tx} \cdot f_{CS} \cdot t_{tx} + e_{rx} \cdot f_{BC} \cdot t_{rx} + e_{idle} \cdot t_{idle}^C + e_{sleep} \cdot t_{sleep}^C &\leq E_{initial}^C
 \end{aligned}$$

3rd constraints : Lifetime of the individual node n ;

$$\begin{aligned}
 T_A &= f_{AB} \cdot t_{tx} + t_{idle}^A + t_{sleep}^A \\
 T_B &= f_{BC} \cdot t_{tx} + f_{AB} \cdot t_{rx} + t_{idle}^B + t_{sleep}^B \\
 T_C &= f_{CS} \cdot t_{tx} + f_{BC} \cdot t_{rx} + t_{idle}^C + t_{sleep}^C
 \end{aligned} \tag{4.15}$$

4th constraint : Non – negativity of the flows and time;

$$f_{AB}, f_{BC}, f_{CS}, t_{idle}^A, t_{sleep}^A, t_{idle}^B, t_{sleep}^B, t_{idle}^C, t_{sleep}^C, T_{net} \geq 0$$

5th constraint : Relationship between T_n and T_{net} ;

$$T_A, T_B, T_C \geq T_{net}$$

6th constraint : Duty – Cycling of each node n ;

$$\begin{aligned}
 T_A - dc \cdot T_A &= t_{sleep}^A & n \in N, dc \in [01] \\
 T_B - dc \cdot T_B &= t_{sleep}^B & n \in N, dc \in [01] \\
 T_B - dc \cdot T_A &= t_{sleep}^B & n \in N, dc \in [01]
 \end{aligned} \tag{4.16}$$

In Figure 4.3, network lifetime versus different data generation periods is plotted for 4 different duty-cycling parameters. Network lifetime is expected to be higher for the case of lower data generation rates (longer data generation period), as it is seen in Figure 4.3. For the sake of illustration, instead of data generation rate, data generation period is used: data generation rate=1/data generation period. On the other side, at higher duty-cycling parameters, nodes spend more time in high power active modes and less time in low power sleeping mode. Therefore, network lifetime would be shorter for bigger duty-cycling parameters as shown in Figure 4.3: at each data generation period, network lifetime gets smaller values for bigger duty-cycle parameters. Note that these network lifetime values represent the time span which allows the achievable maximum total amount of data delivery to the sink node for the given duty-cycling.

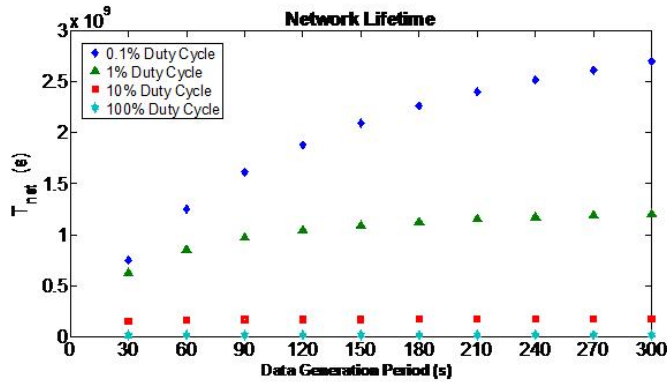

Figure 4.3: Network lifetime versus data generation period

4.4. Mathematical Programming of the Maximum Lifetime Routing Problem in Duty Cycling Sensor Network

In Figure 4.4, Figure 4.5 and Figure 4.6, the staggered relationship between total transmission and reception time of the node A, B and C is shown for 0.1 percent, 1 percent and 10 percent duty-cycling parameters respectively. It is expected that nodes, which are closer to the sink node, would have a higher relay load, hence the total amount of time spent in reception and transmission at the end of the lifetime will be higher compared to the farther nodes. For the topology in Figure 4.2, node C will have the highest amount of time for transmission and reception followed by node B and A. If these three figures are compared, for higher duty-cycling, the total time spent in transmission and reception is getting smaller. The result is a decrease in network lifetime for higher duty-cycling parameters. The higher duty cycling causes a lower network lifetime and inherently lower network lifetime results in lower total transmission and reception time. The nodes farther from the sink node would have less traffic to relay, so it might be expected that they will have longer individual node lifetimes as they have less transmission and reception time. Because, when the transceiver is in reception and transmission mode, energy consumption per unit time is higher than it is in the idle mode. However, time spent in transmission and reception modes is too short due to small packet size. Therefore, the effect of the relay load (amount of packets) on the network lifetime is minor in case of long stay in idle mode. This can be extracted from the linear programming formulation as the difference between coefficient of the variables $f_L^{O_n}$, $f_L^{I_n}$, and t_{idle}^n ; the coefficients of variables $f_L^{O_n}$, $f_L^{I_n}$ and t_{idle}^n are $(e_{tx} \cdot t_{tx})$, $(e_{rx} \cdot t_{rx})$ and e_{idle} respectively. $(e_{tx} \cdot t_{tx})$ and $(e_{rx} \cdot t_{rx})$ are quite small compared to e_{idle} , so this difference results in minor effect of amount of transmitted $f_L^{O_n}$ or received data $f_L^{I_n}$ on network lifetime for the case of long stay in idle mode. Therefore, relationship between individual node lifetimes does not necessarily depend on the relay

load of the nodes. This means that a farther node to the sink node can live shorter than a closer one by spending its rest of the life in idle or sleep mode after the network lifetime.

In the following, it is shown how the network lifetime changes with small change of duty cycling parameter at the different data generation periods. The network lifetime is plotted for three different ranges of duty-cycling: the first range is $[0.001, 0.002, \dots, 0.009, 0.01]$ and shown in Figure 4.7, the second range is $[0.01, 0.02, \dots, 0.09, 0.1]$ and shown in Figure 4.8 and last range is $[0.1, 0.2, \dots, 1]$ and shown in Figure 4.9. Note that at 100 percent duty-cycling (or $dc = 1$), the nodes do not switch on the sleep mode at all. In Figure 4.7, Figure 4.8, and Figure 4.9, the network lifetimes decrease for all data generation rates with increasing duty cycling, in addition the network lifetime curves for different data generation rates get closer to each other as duty-cycling increases. At high duty-cycling parameters, the nodes spend most of their lifetime in idle

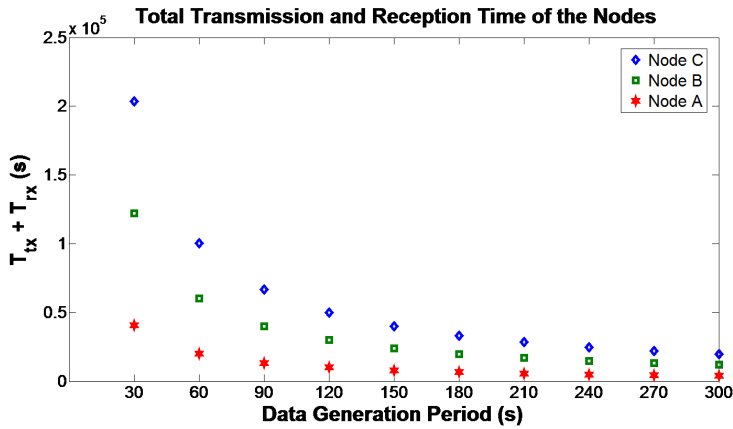

Figure 4.4: Total transmission and reception time for 0.1 percent duty cycle

4.4. Mathematical Programming of the Maximum Lifetime Routing Problem in Duty Cycling Sensor Network

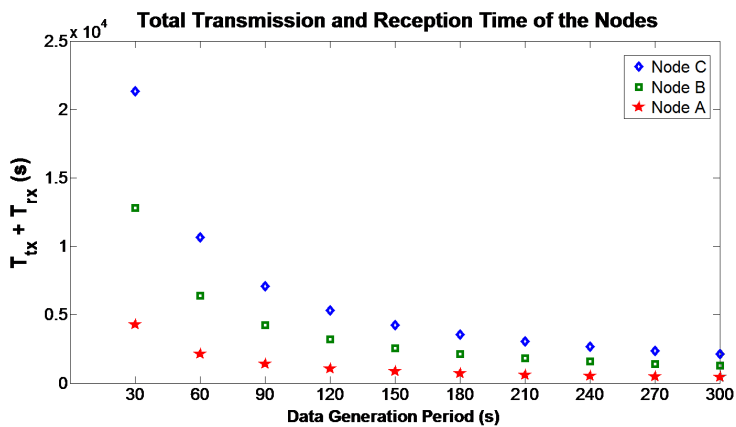

Figure 4.5: Total transmission and reception time for 1 percent duty cycle

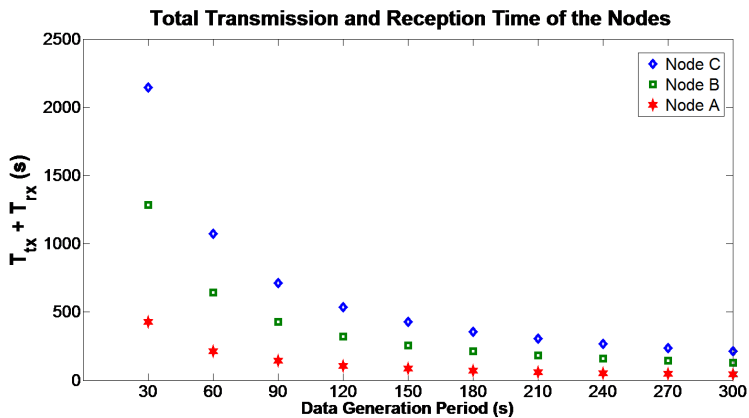

Figure 4.6: Total transmission and reception time for 10 percent duty cycle

mode. Therefore, the effect of data generation rates on network lifetime becomes less visible due to higher energy consumption of long idle mode. This behavior results in small variations in network lifetime values with the varying data generation periods at high duty-cycling parameters.

Lastly, the lower bound of duty-cycling parameter, which is allowed for maximum lifetime, is investigated. As observed from Figure 4.7, Figure 4.8 and Figure 4.9, when duty-cycling parameter decreases, network lifetime increases. Because nodes spend less time in high power active modes compared to the low power sleep mode. Here there are two questions to be answered;

- Does network lifetime always increase with decreasing duty-cycling?

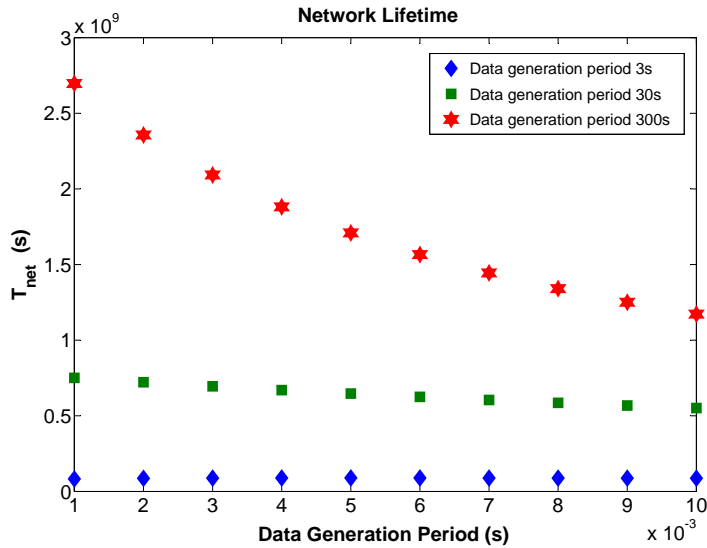

Figure 4.7: Network lifetime vs duty cycling parameter range 1

4.4. Mathematical Programming of the Maximum Lifetime Routing Problem in Duty Cycling Sensor Network

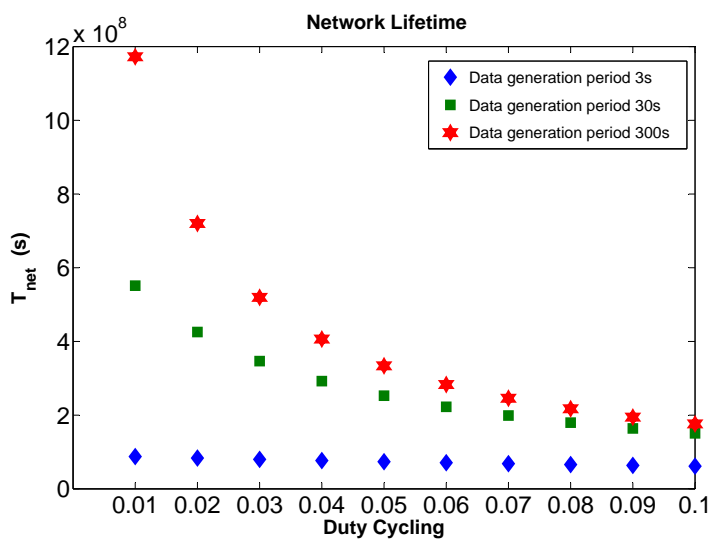

Figure 4.8: Network lifetime vs duty cycling parameter range 2

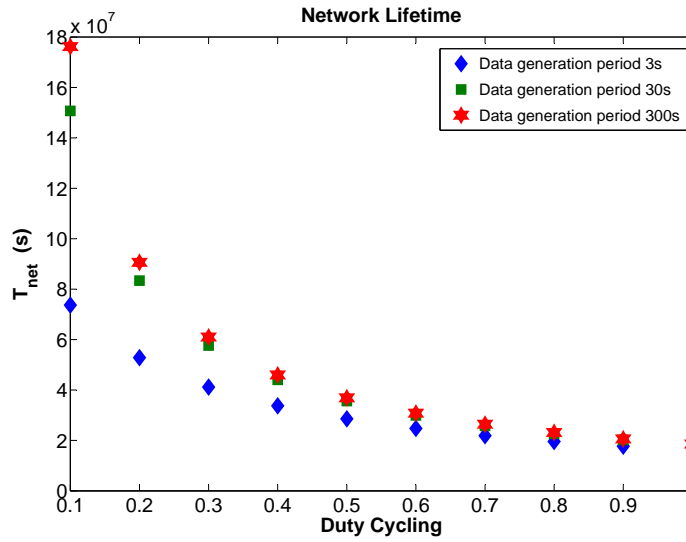

Figure 4.9: Network lifetime vs duty cycling parameter range 3

4.4. Mathematical Programming of the Maximum Lifetime Routing Problem in Duty Cycling Sensor Network

- What is the lowest duty-cycling that gives the maximum lifetime?

When duty-cycling decreases, nodes' battery lasts longer because they will spend more time in low power sleep mode. Since the network lifetime is defined as the time that allows maximum amount of data delivery to the sink node, nodes should have enough active time to handle the maximum network traffic. Therefore, duty-cycling parameters should not be too small; otherwise the nodes, which are closer to the sink node, do not have enough active time to handle the relaying of the traffic and this causes a decrease in total amount of data delivery to the sink node hence a decrease in network lifetime. Figure 4.10 and Figure 4.11 show network lifetime and total amount of data to the sink node versus duty-cycling parameter for three different data generation periods.

As shown in Figure 4.11, after a certain value of duty-cycling parameter, total amount of flow starts to decrease and so does network lifetime as shown in Figure 4.10. For better illustration, in Figure 4.11, maximum network lifetime values are signed with a square for each data generation period.

4.4.5 Example II

In this example, the LP is applied to a symmetric network as shown in Figure 4.12 to illustrate the fair load distribution on links for maximum network lifetime. The distance between nodes are set as $10m$ and transmission range is fixed to this distance hence nodes work at power level 5 ($-25dBm$). The data generation period is 3 *seconds* for all nodes. The

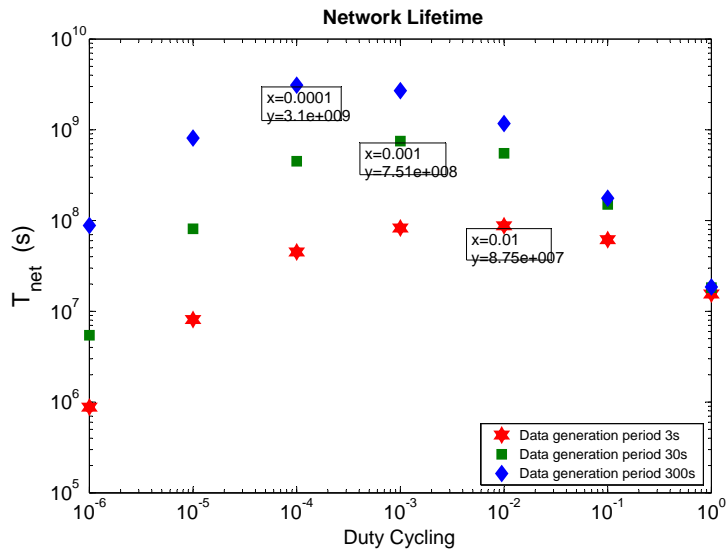

Figure 4.10: Network lifetime vs duty cycling parameter

4.4. Mathematical Programming of the Maximum Lifetime Routing Problem in Duty Cycling Sensor Network

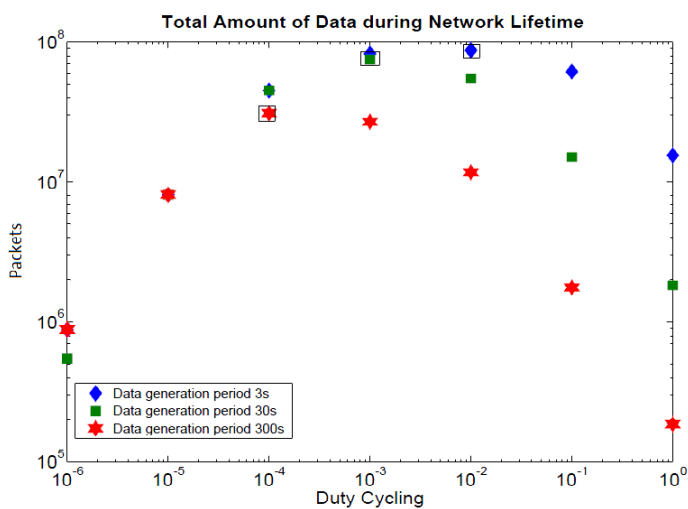

Figure 4.11: Total amount of data during the network lifetime

number of links is 13 and the number of optimization variables is 34 for these settings.

In this topology, node number one, two and seven have two possible routes for the destination, and rest of the nodes have only one route option to access the sink node. For the energy fairness, it might be expected that nodes, which have same length route choices, allocate their outgoing traffic equally between these routes for the fair load distribution. However, for the maximum network lifetime it is straightforward that load distribution should follow the symmetry in the network as shown in Table 4.3.

As mentioned in the previous example, network lifetime can be increased by decreasing duty-cycling parameter since higher duty-cycling parameter means longer stay in low power sleep mode. However, it is not acceptable if the total amount of data collected during the network lifetime decreases

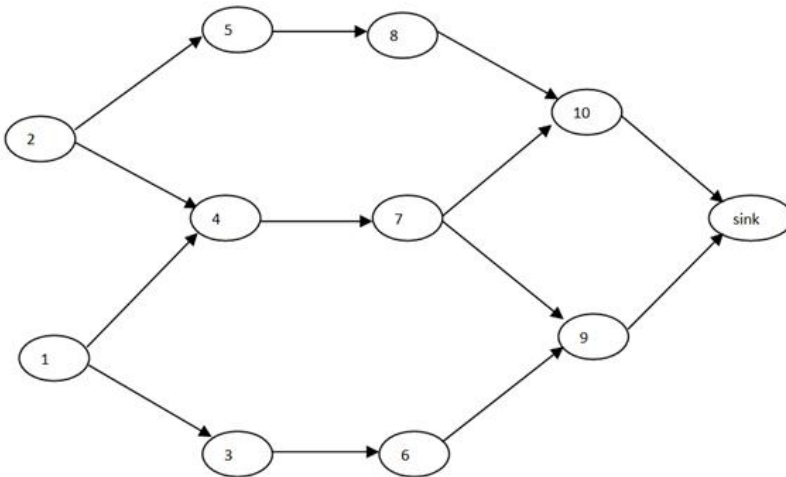

Figure 4.12: Network for example 2

4.4. Mathematical Programming of the Maximum Lifetime Routing Problem in Duty Cycling Sensor Network

| Link(node n to m) | Flow values(packet) |
|-------------------|---------------------|
| L_{1-3} | 1, 64.10^7 |
| L_{1-4} | 3, 68.10^6 |
| L_{2-4} | 3, 68.10^6 |
| L_{2-5} | 1, 64.10^7 |
| L_{3-6} | 3, 65.10^7 |
| L_{4-7} | 2, 79.10^7 |
| L_{5-8} | 3, 65.10^7 |
| L_{6-9} | 5, 66.10^7 |
| L_{7-9} | 2, 38.10^7 |
| L_{7-10} | 2, 38.10^7 |
| L_{8-10} | 5, $66 * 10^7$ |
| L_{9-Sink} | 1, 006.10^8 |
| $L_{10-Sink}$ | 1, 006.10^8 |

Table 4.3: Total Flow Allocation to the Links For Maximum Lifetime- $dc=0.01$

due to too long sleep periods of the nodes. In Figure 4.13, the network lifetime versus duty-cycling parameter is plotted to determine the minimum duty-cycling parameter. Figure 4.14 shows the total amount of data collected in the network with varying duty-cycling parameter. From the Figure 4.13 it is observed that $dc = 0.01$ is the minimum duty-cycling parameter which gives the maximum network lifetime for this example. When the duty-cycling parameter is smaller than this value, achievable maximum network lifetime is decreasing due to the decrease in total amount of data collected during the network lifetime as shown in Figure 4.14. The reason is that smaller than 0.01 value of dc , the nodes which are closer

to the sink node will not have enough active time to handle the relaying traffic of whole network.

In the following, the optimization model is used to investigate the effect of power adjustment on network lifetime. The transmission range of the nodes is set as 35 *meter* and it is allowed that the nodes choose a power level for transmission to different distances. Therefore, each node of the network can reach to each other. Thus, the number of links becomes 59 and the number of variables becomes 80. As it can be seen from Figure 4.15, power adjustment results in a considerable increase in the network lifetime. When the transmission range is increased, the network lifetime is increased because the number of possible routes to the destination (number of links) is increased. However, at the higher transmission range, although the

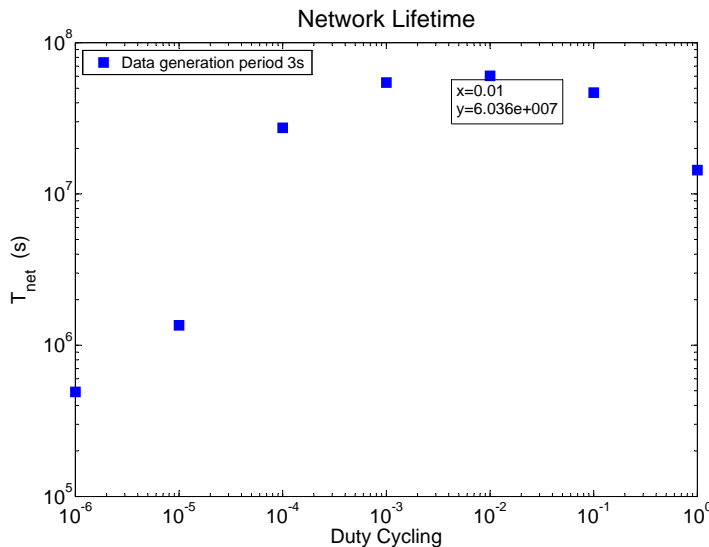

Figure 4.13: Network lifetime versus duty cycling parameter

4.4. Mathematical Programming of the Maximum Lifetime Routing Problem in Duty Cycling Sensor Network

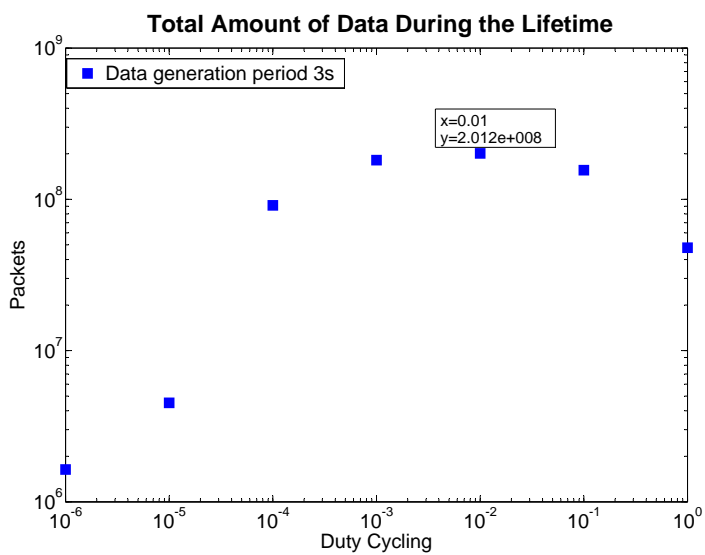

Figure 4.14: Total amount of data versus duty cycling parameter

nodes can set their power level based on the distance and use multi hop route to the sink, they prefer to use the direct route to the sink node. This is an inherent result since reception energy is considered as well as transmission energy and as it is seen from Table 3.1, reception energy is higher than transmission energy for all power levels.

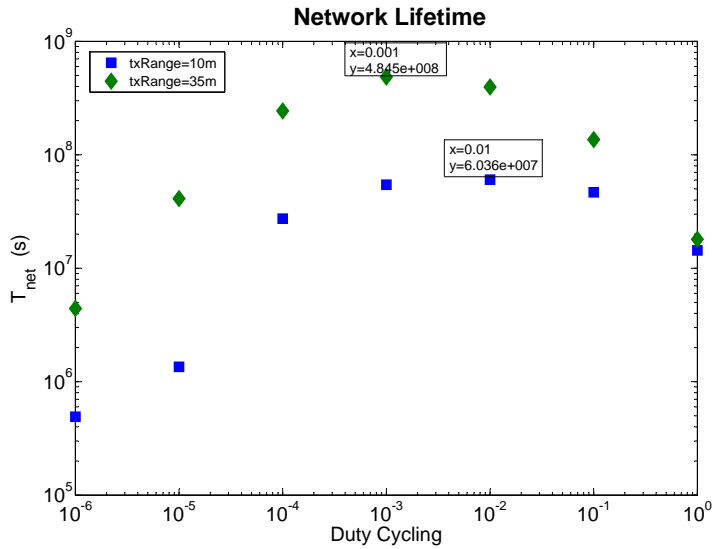

Figure 4.15: For two different transmission range network lifetime vs duty cycling

4.5 Extension of the Mathematical Programming with Cycle Time

Data generation and data flow pattern is the same with the previous formulation. However, energy consumption and duty-cycling parameters differ. In energy consumption model, besides the transmission, reception, listening and sleeping energy, here, RF initialization cost or the cost of switching between active and passive states is considered. Regarding the duty-cycling, here besides the duty-cycling parameter, the length of one duty-cycling period of cycle time is considered in the formulation. Individual node lifetime consists of a number of k_n duty-cycling periods or cycle time. The length of the cycle time is t_{cycle} and energy spent for RF initialization or switching is e_{switch} .

With the above modifications, a new linear programming is formulated as follow;

Objective Function : Maximize T_{net}

1st constraint : Flow Conservation Law;

$$f_L^{O_n} - f_L^{I_n} = g_n \cdot T_{net} \quad (4.17)$$

2nd constraint : Energy constraint;

$$e_{tx} \cdot f_L^{O_n} \cdot t_{tx} + e_{rx} \cdot f_L^{I_n} \cdot t_{rx} + e_{idle} \cdot t_{idle}^n + e_{sleep} \cdot t_{sleep}^n + k_n \cdot e_{switch} \leq E_{initial}^n \quad (4.18)$$

3rd constraint : Lifetime of the individual node n ;

$$T_n = f_L^{O_n} \cdot t_{tx} + f_L^{I_n} \cdot t_{rx} + t_{idle}^n + t_{sleep}^n \quad n, m \in N, L \quad (4.19)$$

4th constraint : Non – negativity of the flows and time;

$$f_L^{O_n}, f_L^{I_n}, t_{idle}^n, t_{sleep}^n, T_{net} \geq 0 \quad (4.20)$$

5th constraint : Relationship between T_n and T_{net} ;

$$T_n \geq T_{net} \quad (4.21)$$

6th constraint : Duty – Cycling of each node n ;

$$T_n - dc \cdot T_n = t_{sleep}^n \quad n \in N, dc \in [01] \quad (4.22)$$

7th constraint : Relationship between CycleTime and Lifetime of the individual node n ;

$$T_n = k_n \cdot t_{cycle} \quad n \in N, dc \in [01] \quad (4.23)$$

$n \in N, L \in \check{L}$ for all above equations and inequalities.

Currently, in sleep-scheduling schemes duty-cycling parameter and cycle time is defined by application designers without any analytical studies. None of the existing duty-cycling MAC scheme investigates the effect of specific value of duty-cycling parameter [8], [4], [11], [18], [17]. As it is mentioned in the Section 2.2.4, how many times a node turns on and off is important due to radio initiation cost. However, especially in an asynchronized duty-cycling scheme, network connectivity and low latency are achieved by shortening the duty-cycling parameter and increasing the frequency of switching between on-off modes [28]. This modification in the formulation provides to investigate the effect of switching frequency of nodes (between active and passive states) on network lifetime.

4.6 Conclusions

In this chapter, the problem of the maximum lifetime routing in duty-cycling sensor network is investigated in a mathematical programming framework. The main objective was to determine achievable network lifetime with a routing mechanism on top of an existing synchronized duty-cycling scheme. To do this, the problem has been formulated as an LP problem. By solving the LP formulation, total time spent by each node in transmission, reception, idle and sleep mode, total traffic on each link of the network and expected relay load of nodes for maximum lifetime can be obtained.

Furthermore, this chapter introduced a mathematical tool which can be used to study the routing strategy in duty-cycling sensor network for the maximum lifetime. Specifically, the optimal solution provided by this framework can be used as a theoretical benchmark for designing new heuristic routing algorithms for duty-cycling sensor network for maximum lifetime.

In addition, the formulation models the staggered relationship between transmission time and reception time of the nodes based on the distance between the node and the sink node; hence it provides a theoretical guide for designing coordination schemes for sleep-wake up mechanisms.

Lastly, mathematical programming problem is extended to investigate the effect of switching energy consumption on network lifetime.

5

Numerical Analysis and Validation with A Design of Maximum Lifetime Routing Algorithm

5.1 Introduction

In this chapter, in order to validate the mathematical models, a maximum lifetime routing algorithm is designed considering duty-cycling mechanism in the network. For maximum network lifetime, research efforts

can be classified into two classes. The first is energy efficient or maximum lifetime routing algorithms, which balance the traffic load in the network equally, hence balance the energy usage and extend the network lifetime. The second is duty-cycling MAC protocols run a sleep-scheduling scheme to save the energy waste when the nodes are in idle mode. In literature, these two energy saving methods are separately tackled since they address different network layers. One is considered and optimized assuming that. The other one is pre-determined and perfectly support the required setting. One of the main reasons behind this is that, joint routing and sleep-scheduling is a non-convex optimization problem which is difficult to solve [32]. Currently, there is only one study addresses this optimization problem by transforming it into an equivalent Signomial Program (SP) through relaxing the flow constraints and then solving this by an iterative Geometric Programming (GP) method [32]. It gives a near optimal routing and sleep-scheduling scheme to maximize the network lifetime. However, in the previous chapter maximum lifetime routing problem for duty-cycling sensor networks is formulated as a linear programming problem. One of the main observations on this formulation is that although it does not address the joint routing and sleep-scheduling optimization, it allows to determine the minimum duty-cycling parameter, which is essential for sleep-scheduling, while finding the optimal data routing for maximum network lifetime.

In this chapter, a simple routing protocol, which provides a balanced energy usage in the network and leads to the network maximization at the existing of an underlying duty-cycling scheme, will be investigated for validation of mathematical formulations in the previous two chapters. For the simulations, a free simulation tool set PROWLER [48], which is written in MATLAB, is used. The MAC layer in PROWLER simulates a

CSMA MAC protocol similar to that of the Berkeley notes. This channel access protocol features random waiting time, channel idle checking, and back-off intervals.

5.2 System Model and Parameters

A monitoring application of sensor network is assumed. The nodes are not mobile and the topology of the network is static. Sensor nodes periodically sense the environment and send the data on multihop basis. There is many to one communication pattern that there are many source nodes and there exists only one sink node to collect the data. Both reception and transmission energy consumption are considered in the mathematical model and simulation studies. However, the energy consumption due to overhearing is not included in the mathematical model and this is applied in the simulation as well by running a similar mechanism to Network Allocation Vector (NAV) in 802.11. Note that energy consumption due to route table set up and maintenance are not included in the model or the simulation since a situation is assumed where the energy consumption is dominated by the data packet transmissions. Energy consumption when the transmitter in transmission, reception, idle (listening) and sleep (low-power) mode is considered and computational (e.g. data generation and processing) energy consumption is ignored. All nodes in the network work with the same fixed duty-cycling parameter and periodically switch between active and passive states based on an existing energy efficient MAC protocol. The nodes in a routing path are in active state at the same time to pursue the communication. There exists a synchronization mechanism by exchanging periodic control packets between neighbor nodes to avoid

the error due to clock drift. The nodes periodically generate data even if their transmitter is in sleep state. The data generated during the sleep period is queued and transmitted when the node switch the active state.

The same network lifetime definition in previous chapters is used. Individual node lifetime consists of k number of duty cycling period and based on predetermined duty cycling parameter, in each duty cycling period sleep time and active time of the nodes are fixed. At the end of the the network lifetime, each node will have different number of duty cycling period.

5.2.1 Residual Energy Aware Routing Mechanism

Residual Energy Aware Routing Mechanism has two phases; the first is the route setup phase and the second is the route choosing phase. After the route setup phase, each node chooses the next hop based on its residual energy level. After each packet transmission, receiver node sends a small packet with a field of residual energy. This packet has two functions as acknowledgment of packet reception and updating the residual energy level of receiver node in the route table of sender node.

Route Setup Phase; In this phase, sink node broadcasts a route setting packet (*rSetPkt*). Route setting packet includes the following information fields;

- msgID: indicates the type of packet, for instance currently it indicates that it is a *rSetPkt* (it is for future usage since currently sink node send only *rSetPkt*).

5.2. System Model and Parameters

- *source*: indicates the sink node address in case of existing of multiple sink nodes in the network.
- *rSetPktID*: indicates the number of route set packet. Sink node repeats broadcasting of this packet periodically to update the routes.
- *numHops*: value is set to zero when sink node broadcasts it and each node increases it when it rebroadcasts the packet, so it indicates how many hops this packet has travelled.
- *address*: a value of zero indicates a broadcast packet.
- *from*: indicates the relay node's address who have just rebroadcasted the packet.
- *residualEnergy*: indicates the relay node's residual energy.

Creating Routing Table;

Route Setting Packet broadcasting process continues until all nodes get the route setting packet. A node stops rebroadcasting the packet if it has already got the packet with the same *numHops* field. Different *numHops* field indicates different possible paths to access the sink node. When the nodes got the *rSetPkt*, it increases the *numHops* field and fills its address and residual energy level into the *from* and *residualEnergy* fields respectively. At the end of route setting process each node would have created a routing table by using the information in the received *rSetPkt*. It uses the *from* field to fill the next hop address in the routing table. In this way, a virtual reverse path is set up from each node to the sink node. Note that each node is only aware of the next hop to access the sink node and how many hops it is away from the sink node. It records the address of the node which just broadcasts the *rSetPkt* packet. Although

the topology is randomly created for each simulation, only the connected graph is chosen so that all nodes has at least one path to access the sink node.

Each node, which gets this broadcast packet, creates a route table that has the following field of information;

- source: indicates the sink node address in case of existing of multiple sink nodes in the network.
- msgID: reserved for future use.
- destSeq: reserved for future use.
- numHops: indicates how many hops away is the next hop from the sink node.
- nextHopResidualEnergy: residual energy of the next hop.
- deadEnd: In case of that a node does not have a route other than the node which just sends the packet, it informs the sender by sending a small error packet and allows the sender to update its routing table by setting this field. However, in current setting, it lets the route setup process continues until each node has more than one route to prevent the dead end case.
- received: reserved for future use.
- lost: reserved for future use.

Routing of the data packets;

When a node wants to send a packet, it checks the routing table and chooses the next hop address based on their residual energy level. However,

5.2. System Model and Parameters

in routing table there is only information about one hop away nodes. Therefore, when the node chooses the next hop, it also checks the *path* field to prevent the loops. If the next hop is already in the path, it does not compare its residual energy level, it simply ignores that hop and compares the energy level of the remaining possible next hops.

A data packet has the following field of information;

- forward: used for travelling of data between the networking layers.
- value: sensed data from the environment.
- source: addresses for the data.
- msgID: indicates the sink node.
- seqID: sequences ID to avoid the duplications.
- rate: data rate of the source node.
- startTime: starts time of sending the data packet from source used to calculate the latency.
- path: this field records the path the data packet travel until reaching to the sink node.
- numHops: number of hops that data packet travels.
- from: the address of last node which sends the data packet.
- address: the address of next hop where data will be sent based on the information in the routing table.

5.2.2 Sleep Wake Up Mechanism

Time is divided into Cycle Time slots. All nodes switch between active and sleep states in each cycle time. Each cycle time has active and passive periods. The ratio of active time to the cycle time determines the duty-cycling parameter. The duty-cycling parameter and the length of the cycle time is defined before the design and the constant during the network lifetime. In passive period of each cycle time, the nodes decide if it is going to switch into the sleep state or not. If it has data to send in its memory, it will not switch to sleep state, otherwise it switches into the sleep state and sets a wake up timer to wake itself up in the active period of cycle time.

5.3 Results

In this section, numerical validations of each mathematical formulation are shown in different scenarios through the simulation. Residual energy aware routing mechanism is evaluated by comparing achieved network lifetime with the optimal network lifetime obtained by the linear programming problem solutions.

In the simulation network setup, there are 35 nodes randomly located in a $50m-by-50m$ area. The sink node lies at the one corner of the square area. The power consumption model of CC2420 transceiver is used. The nodes are working at $0dBm$ power level and RF range of each node is 20 meters. Each node has $1.8V$ AA batteries with $2200mAh$ current capacity hence 14256 *joule* initial energy. All source nodes have the same data generation rate. Ten different network topologies are randomly generated

5.3. Results

according to the above setup. Note that there may be cases where no path available between a source node and the sink, however that topologies are discarded and at the same time route setup process continues until all nodes have at least one path to access the sink node.

Firstly, the mathematical model which is defined in Chapter 3 is validated with simulation results. In this model, nodes do not switch between sleep and active states. This can be simulated setting the duty cycling parameter as 1 (nodes are %100 active) in the system model which is described above. Individual node lifetime values consist of the time spent in idle (channel listening), transmit and reception mode of operation. Power consumption model of CC2420 transceiver is used (see Table 3.1). The performance of residual energy aware routing scheme is compared with solution of linear programming problem under different network traffic density by changing the node data generation periods. The results are shown in Figure 5.1, in which network lifetime is plotted versus the packet generation period at each node. Each point in the figure is an average of 10 different network topologies. It is not surprising to see that the higher the packet generation period, the less energy that is needed to transmit the generated packets to the sink node, and hence the longer the network lifetime. At longer data generation period, since we have fewer transmissions and receptions, the effect of idle mode energy consumption on the network lifetime is dominant. This can be seen from the graph as decrease of the slope at the longer data generation periods.

To be able to see the effect of idle mode energy consumption, the validation of the LP is repeated setting the idle mode energy consumption as zero. The results are shown in Figure 5.2. The first observation from this simulation is that the slope of the curve is the same for all data generation

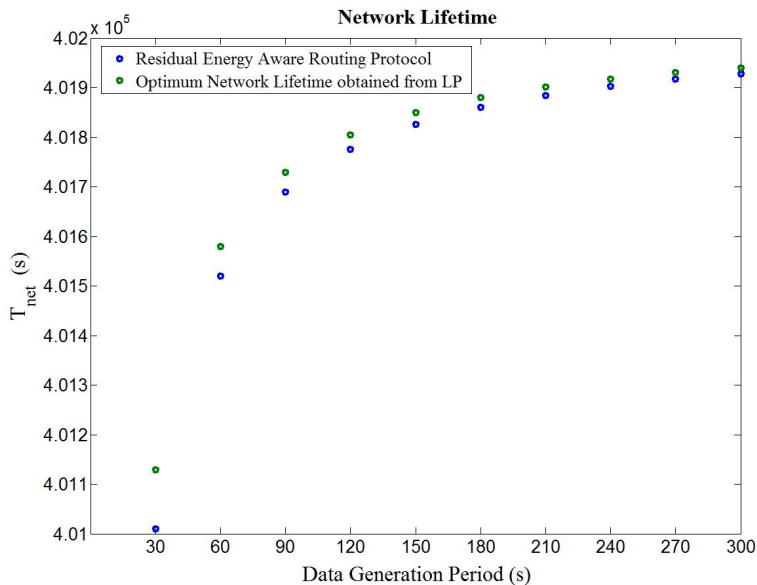

Figure 5.1: Network Lifetime Over Varying Traffic Density $e_{idle}=e_{rx}$

periods since only the effect of transmission and reception is considered for calculation of network lifetime. The second interesting result is that difference between residual energy aware routing mechanism and optimal solution is bigger when idle mode energy consumption is ignored. This is because the linear programming solution provides the best balanced load distribution between the routes, whereas the residual energy aware routing mechanism performs badly in that respect. The reason is that the solution of linear programming provides non integer values for the number of packets on each link while in simulation packets cannot be divided into small pieces.

Secondly, the mathematical model for duty cycling sensor network, which is defined in Chapter 4, is validated through the simulation. For

5.3. Results

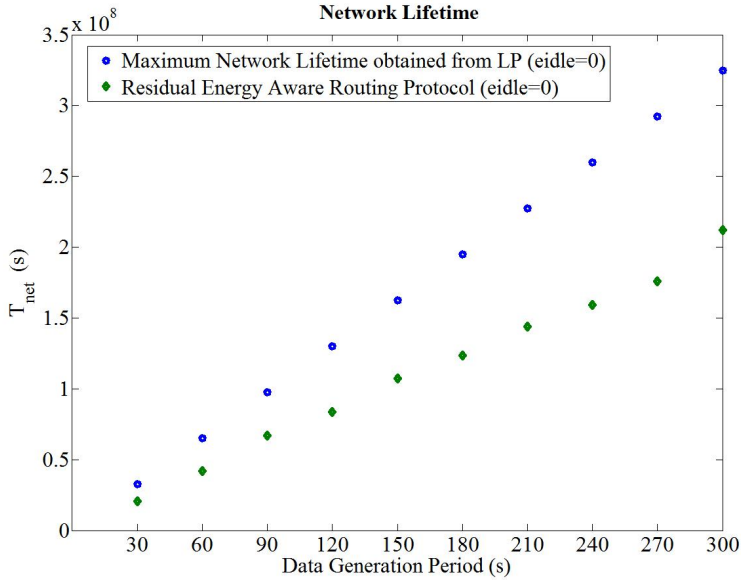

Figure 5.2: Network Lifetime Over Varying Traffic Density $e_{idle}=0$

this validation two sets of simulation will be run. Firstly, performance of residual energy aware routing scheme is compared with solution of linear programming problem under different network traffic density by changing the node data generation periods at the different duty-cycling parameter values. Secondly, latency and data success rate of the residual energy aware routing scheme are evaluated at the minimum duty-cycling parameter which is determined by solving the linear programming formulation. Except the duty-cycling parameter all settings are the same with previous simulation. In this model, nodes switch between sleep and active states based on the predetermined duty-cycling parameter, which gets value between $[0 - 1]$. In Figure 5.3, 5.4, 5.5, 5.6 network lifetime is plotted versus the packet generation period at the different duty-cycling parameter values

for residual energy aware routing scheme and linear programming. Each point in the figure is an average of 10 different network topologies. Residual energy aware routing scheme performs very well in all data generation periods.

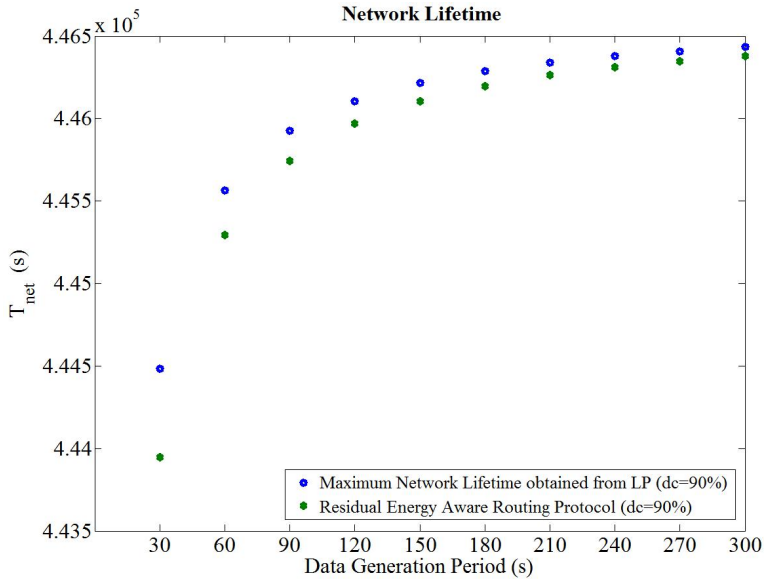

Figure 5.3: Network Lifetime Over Varying Traffic Density for %90 Duty Cycling Parameter

In Figure 5.7, latency of residual energy aware routing scheme is shown for different duty-cycling parameters. As expected the higher duty-cycling parameter causes the higher latency. Latency is defined as time to send a packet from source to the sink node. The latency of the network is averaged by the number of source nodes. Latency metric consists of the number of hops, the length of transmission queues and the random delays at the MAC layer.

5.3. Results

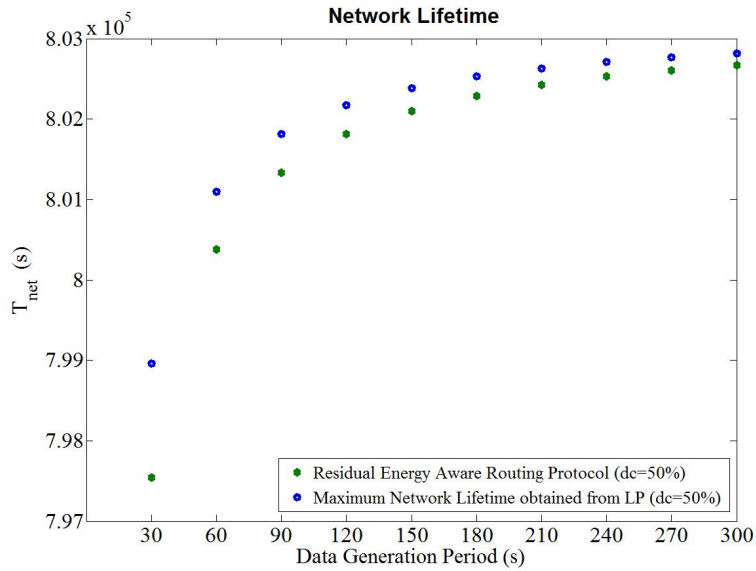

Figure 5.4: Network Lifetime Over Varying Traffic Density for %50 Duty Cycling Parameter

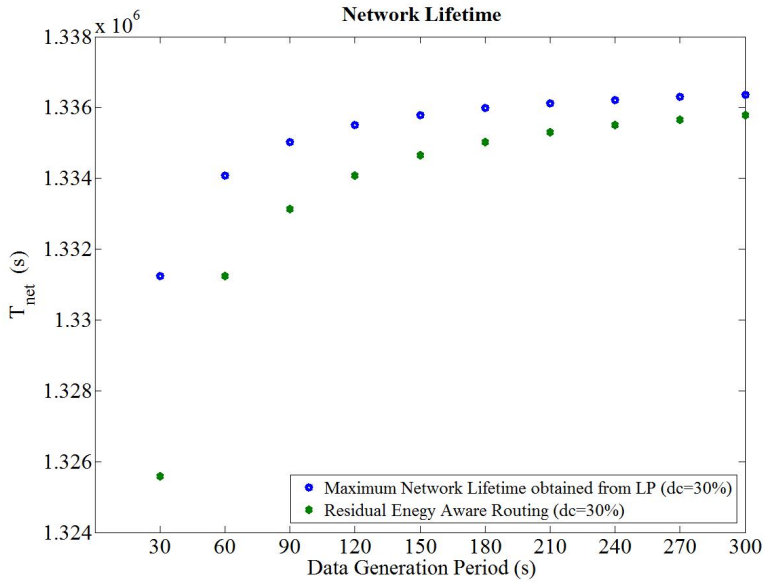

Figure 5.5: Network Lifetime Over Varying Traffic Density for %30 Duty Cycling Parameter

5.3. Results

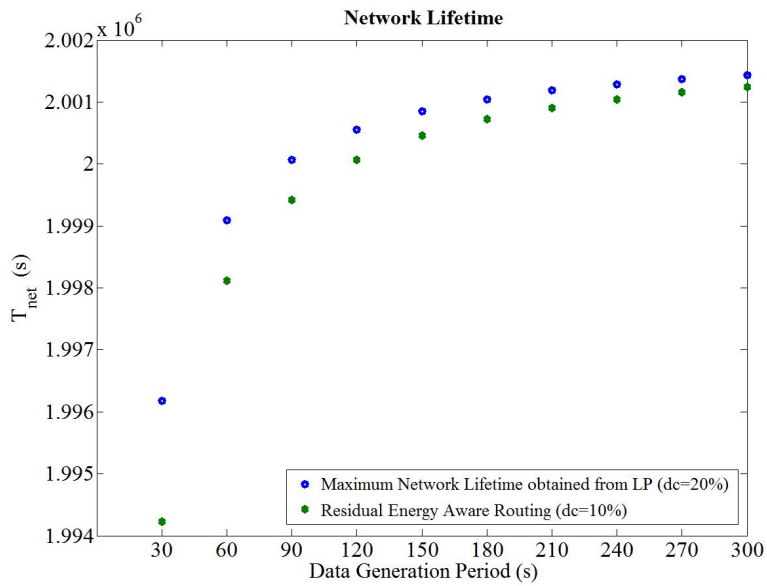

Figure 5.6: Network Lifetime Over Varying Traffic Density for %20 Duty Cycling Parameter

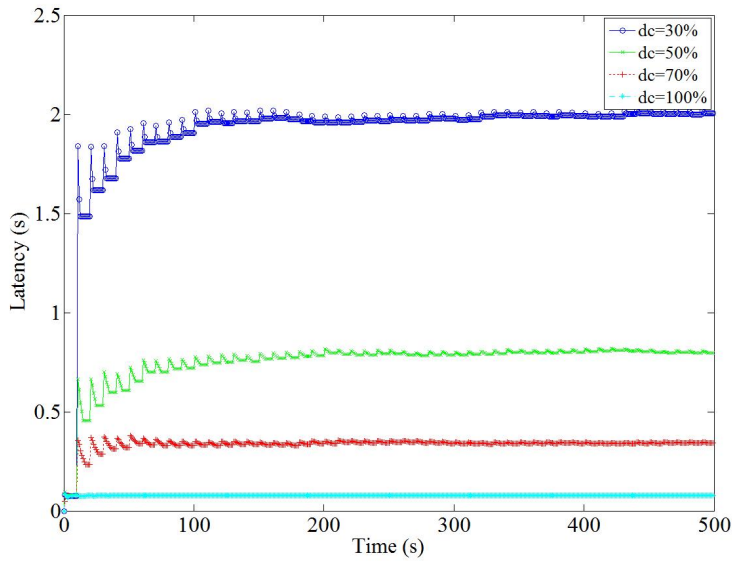

Figure 5.7: Latency Performance of Residual Energy Aware Routing Scheme for Different Duty Cycling Parameters

In Figure 5.8, the success rate of residual energy aware routing scheme is shown for different duty-cycling parameters. The success rate is the total number of packets received at the sink node versus the total number of packets sent by all the sources. This metric measures the overall success of the network.

In Figure 5.9, energy efficiency of residual energy aware routing scheme is shown for different duty-cycling parameters. Energy efficiency is the ratio of the total energy consumption in the network over the total number of packets received at the destinations.

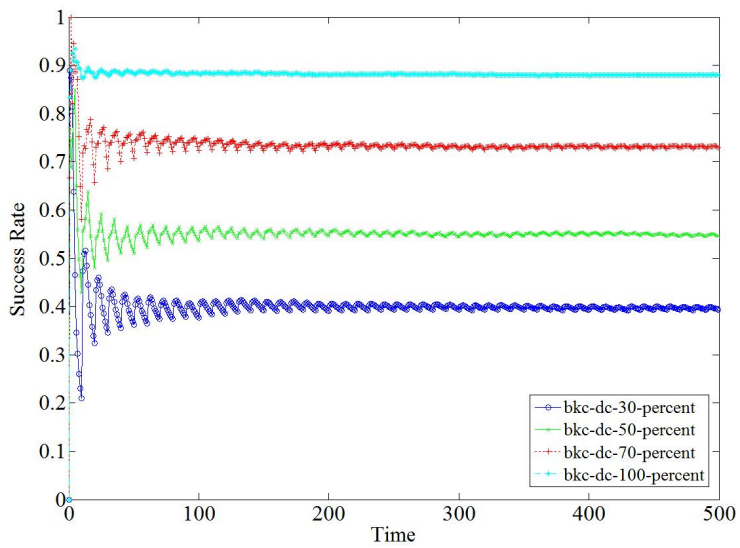

Figure 5.8: Success Rate of Residual Energy Aware Routing Scheme for Different Duty Cycling Parameters

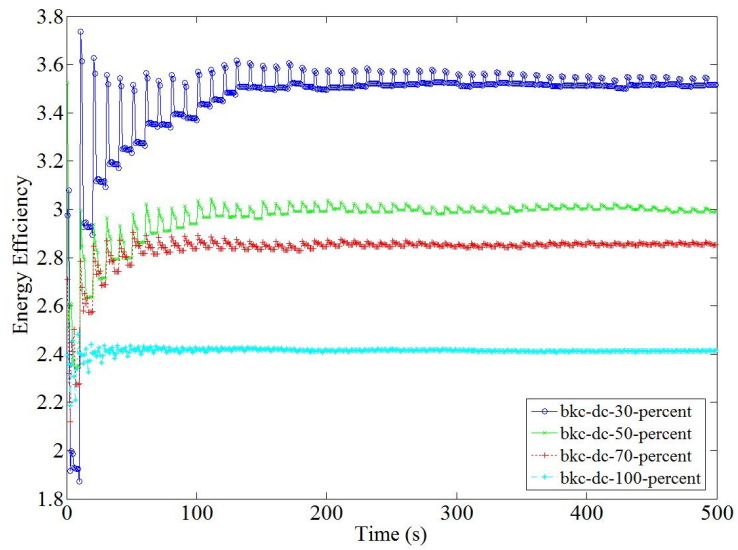

Figure 5.9: Energy Efficiency of Residual Energy Aware Routing Scheme for Different Duty Cycling Parameters

6

Conclusions and Future Work

In this thesis, two important energy consuming processes of WSNs are discussed; the first is transmission/reception phase and the second is listening the radio for any possible event. Therefore, there are two strategies for energy saving. The first is reducing the networking activities, which means less packet exchanging between the nodes. The second is avoiding the idle waiting time for packet arrivals. The first strategy covers routing techniques for resource constraints networks (in terms of energy and processing power) and the second strategy covers sleep-wake up scheduling techniques.

In this thesis, the network lifetime maximization of wireless sensor networks have been studied through developing a mathematical model especially in the design of routing protocols by jointly considering a duty-cycling mechanism in the network.

The strong points of the developed mathematical programming formulations are as follows;

- These are the first mathematical programming formulations of the maximum lifetime routing problem which takes into consideration all operation modes of the node. Therefore, for any energy consumption model, data generation rate and battery capacity, it is possible to calculate the real upper bound on the network lifetime.
- In general, it provides a mathematical tool which can be used to study the routing strategy for the maximum lifetime. For instance, observing the optimum flow/load distribution between the links, the routing strategy can be determined to decide between multi-hop or single-hop communications using a suitable power control mechanism.
- It can also be used to investigate the relationship between individual node lifetimes and network lifetimes in a mathematical framework. In this way, the node deployment strategy can be made in an efficient way to avoid routing holes due to energy depletion.
- Since the idle time of the individual nodes can be investigated based on the different data generation rates and the location of the node, it serves as a mathematical framework for future studies on the investigation of the allowable duty cycle parameter for a given data generation rate.

6.1. Future Research Directions

- Specifically, the optimal solution provided by these mathematical frameworks can be used as a theoretical benchmark for designing new heuristic routing algorithms for duty-cycling sensor network for maximum lifetime.
- The lower bound of duty-cycling parameter which is allowed for maximum data delivery to the sink node can be determined by providing the most load balanced routing for the maximum network lifetime.
- Analytical investigation of the trade off between duty-cycling period (cycle time) and sleep-wake up switching frequency is possible with the developed mathematical programming in 4.

Lastly, a residual energy aware routing protocol is proposed and evaluated by using the developed mathematical tools. It is shown that protocol provides a load balanced delivery of the traffic without need of global energy map of the network.

6.1 Future Research Directions

Energy efficiency is the most important design criterion for developing WSN protocols. Very large application areas make hard to design standard network protocols for these networks. Generally, different function of the WSN networks are tackled separately from each other by assuming that the rest support perfectly the current function. The developed mathematical formulation of the maximum lifetime routing problem offers the potential of advancing the research and development of innovative techniques for energy efficient network protocols. While many of the issues have been

dealt with in this thesis, the following areas will be explored further in the next stage of the research.

- Distributed solution of the optimization problem: Proposed linear programming problems are centralized. To determine the links(flow variables), neighbor nodes of each node of the network need to be known in advance. However, for the practical use of the optimization model, there is a need of distributed solution of the problem.
- Routing with an asynchronized sleep scheduling algorithm: Throughout this work, it is assumed that there exists an underlying synchronized duty-cycling mechanism. Therefore, it would be interesting to evaluate the impact of an incorporating asynchronized duty-cycling scheme into the model.
- Routing and duty-cycling with a variable data generation rate: When formulating the maximum lifetime routing problem, it is assumed that the nodes periodically sense the environment and periodically generate data. In other words, this study covers only the monitoring application of WSN. Therefore, the study can be extended in the case of event driven application of sensor network that is designed to monitor any alarm situation.
- Maximum lifetime routing with an adaptive duty cycling: Since the idle time of the individual nodes can be investigated based on the different data generation rates and the location of the node, it serves as a mathematical framework for future studies on the investigation of the allowable duty cycle parameter for a given data generation rate. Nevertheless, this thesis addresses a network with the same

6.1. Future Research Directions

fixed duty-cycling scheme for all nodes. However, it would be interesting to formulate the same problem in a nonlinear programming problem that allows each node to have its own duty-cycling rate based on its location in the routing paths. The effect of an adaptive duty-cycling onto network lifetime extension needs to be evaluated.



List of Publications Produced during the Ph.D. Study

A.1 Journals

1. Bilge Kartal Cetin, Neeli R. Prasad, Ramjee Prasad, "A Mathematical Programming Formulation of Maximum Lifetime Routing Problem in Duty-Cycling Sensor Networks", *Springer Journal* (in preparation), Fall 2011.

2. Kwang-Cheng Chen, Bilge Kartal Cetin, Yu-Cheng Peng, Neeli Prasad, Jin Wang and Songyoung Lee, "Routing for cognitive radio networks consisting of opportunistic links", *Wireless Communication and Mobile Computing, journal published online in Wiley InterScience*, August 2009, DOI:10.1002/wcm.776.
3. Nuno Pais, Bilge Kartal Cetin, Nuno Pratas, Fernando J. Velez, Neeli R. Prasad, Ramjee Prasad, "Cost-benefit Aware Routing Protocol for Wireless Sensor Networks with Hybrid Energy Storage System", *Journal of Green Engineering*, Volume 1 Issue 2, January 2011.

A.2 Conference Papers

4. Bilge Kartal Cetin, Neeli Prasad, Ramjee Prasad, "A Novel Linear Programming Formulation of Maximum Lifetime Routing Problem in Wireless Sensor Networks", *Proceedings of the 7th International Wireless Communications and Mobile Computing Conference, IWCMC 2011*, Istanbul, Turkey, July 2011.
5. Bayu Anggorojati, Kamil Cetin, Bilge Kartal Cetin, Neeli R. Prasad, "An implementation study for creating a research platform for tele-homecare and Easy Life" , *1st International Conference on Wireless Communication, Vehicular Technology, Information Theory and Aerospace and Electronic Systems Technology*, Conference Abstract, Book of Abstract, May 2009.

A.3 Technical Reports

6. Bilge Kartal Cetin, Carlo Galiotto, Kamil Cetin, Neeli R. Prasad "Reading reliability report : WP5 - Ubiquitous, added value sensing", ASPIRE (Advanced Sensors and lightweight Programmable middleware for Innovative Rfid Enterprise applications) Project Deliverable 5.3, April 2010.
7. Neeli R. Prasad, Bilge Kartal Cetin, Humberto Moran, Sofyan M. Yousuf, John Soldatos, Ramiro Samano Robles, Panos Dimitropoulos, Nikos Zarokostas, Ioannis Kolokouris, Jean-Philippe Leclercq, "Detailed Report on Planning of Pilots", SPIRE (Advanced Sensors and lightweight Programmable middleware for Innovative Rfid Enterprise applications) Project WP6 (Application Integration, Trials and Evaluation Deliverable) D6.1, April 2009.

B

List of Abbreviations

| | |
|-------------|-------------------------------|
| WSN | Wireless Sensor Network |
| MAC | Medium Access Control |
| TDMA | Time Division Multiple Access |
| CSMA | Carrier Sense Media Access |

| | |
|----------------|---|
| MANET | Mobile Ad Hoc Networks |
| ADC | Analog Digital Converter |
| MCU | Microcontroller Unit |
| MBCR | Minimal Battery Cost Routing |
| MMBCR | Min-Max Battery Cost Routing |
| MLR-MDC | Maximum Life-time Routing with Minimum Duty-Cycling |
| MDR | Minimum Drain Rate |
| RTS | Request to Send |
| CTS | Clear to Send |
| NAV | Network Allocation Vector |
| SIFS | Short Inter-Frame Spacing |
| DIFS | Distributed Inter-Frame Spacing |
| TA | Timeout Interval |
| LPL | Low Power Listening |

| | |
|-------------|-----------------------------------|
| LP | Linear Programming |
| PO | Pareto Optimal |
| RSSI | Receive Signal Strength Indicator |
| SP | Signomial Programming |
| GP | Geometric Programming |
| SMAC | Sensor MAC |
| TMAC | Timeout MAC |
| BMAC | Berkeley MAC |
| RMAC | Randomized MAC |
| XMAC | A low power MAC |

References

- [1] Chipcon as smartrf® cc2420 preliminary datasheet. <http://inst.eecs.berkeley.edu/~cs150/Documents/CC2420.pdf>.
- [2] Kemal Akkaya and Mohamed Younis. A survey on routing protocols for wireless sensor networks. *Ad Hoc Networks*, 3:325–349, 2005.
- [3] Jamal N. Al-karaki and Ahmed E. Kamal. Routing techniques in wireless sensor networks: A survey. *IEEE Wireless Communications*, 11:6–28, 2004.
- [4] G. Anastasi, M. Conti, and M. Di Francesco. Extending the lifetime of wireless sensor networks through adaptive sleep. *Industrial Informatics, IEEE Transactions on*, 5(3):351–365, aug. 2009.
- [5] A. Bachir and D. Barthel. Localized max-min remaining energy routing for wsn using delay control. In *Communications, 2005. ICC 2005. 2005 IEEE International Conference on*, volume 5, pages 3302 – 3306 Vol. 5, may 2005.
- [6] Douglas M. Blough and Paolo Santi. Investigating upper bounds on network lifetime extension for cell-based energy conservation techniques in stationary ad hoc networks. In *in Proceedings of the*

- ACM/IEEE International Conference on Mobile Computing and Networking (MOBICOM)*, pages 183–192. ACM Press, 2002.
- [7] Michael Buettner, Gary V. Yee, Eric Anderson, and Richard Han. X-mac: A short preamble mac protocol for duty-cycled wireless sensor networks. In *in SenSys*, pages 307–320, 2006.
- [8] Q. Cao, T. Abdelzaher, T. He, and J. Stankovic. Towards optimal sleep scheduling in sensor networks for rare-event detection. In *Information Processing in Sensor Networks, 2005. IPSN 2005. Fourth International Symposium on*, pages 20 – 27, april 2005.
- [9] Jae-Hwan Chang and L. Tassiulas. Maximum lifetime routing in wireless sensor networks. *Networking, IEEE/ACM Transactions on*, 12(4):609 – 619, 2004.
- [10] M. Cheng, Xuan Gong, and Lin Cai. Joint routing and link rate allocation under bandwidth and energy constraints in sensor networks. *Wireless Communications, IEEE Transactions on*, 8(7):3770 –3779, july 2009.
- [11] Kyong-Tak Cho and Saewoong Bahk. Duty cycle optimization for a multi hop transmission method in wireless sensor networks. *Communications Letters, IEEE*, 14(3):269 –271, march 2010.
- [12] Reuven Cohen and Boris Kapchits. An optimal wake-up scheduling algorithm for minimizing energy consumption while limiting maximum delay in a mesh sensor network. *IEEE/ACM Trans. Netw.*, 17:570–581, April 2009.

REFERENCES

- [13] Joseph C. Dagher, Michael W. Marcellin, and Mark A. Neifeld. A theory for maximizing the lifetime of sensor networks. *Communications, IEEE Transactions on*, 55(2):323 –332, feb. 2007.
- [14] I. Demirkol, C. Ersoy, and F. Alagoz. Mac protocols for wireless sensor networks: a survey. *Communications Magazine, IEEE*, 44(4):115 – 121, april 2006.
- [15] Isabel Dietrich and Falko Dressler. On the lifetime of wireless sensor networks. *ACM Trans. Sen. Netw.*, 5:5:1–5:39, February 2009.
- [16] Shu Du, A.K. Saha, and D.B. Johnson. Rmac: A routing-enhanced duty-cycle mac protocol for wireless sensor networks. In *INFOCOM 2007. 26th IEEE International Conference on Computer Communications. IEEE*, pages 1478 –1486, may 2007.
- [17] A. El-Hoiydi and J.-D. Decotignie. Wisemac: an ultra low power mac protocol for the downlink of infrastructure wireless sensor networks. In *Computers and Communications, 2004. Proceedings. ISCC 2004. Ninth International Symposium on*, volume 1, pages 244 – 251 Vol.1, june-1 july 2004.
- [18] S.C. Ergen, C. Fischione, D. Marandin, and A. Sangiovanni-Vincentelli. Duty-cycle optimization in unslotted 802.15.4 wireless sensor networks. In *Global Telecommunications Conference, 2008. IEEE GLOBECOM 2008. IEEE*, pages 1 –6, 30 2008-dec. 4 2008.
- [19] S.C. Ergen and P. Varaiya. On multi-hop routing for energy efficiency. *Communications Letters, IEEE*, 9(10):880 – 881, oct. 2005.

-
- [20] S.C. Ergen and P. Varaiya. Pedamacs: power efficient and delay aware medium access protocol for sensor networks. *Mobile Computing, IEEE Transactions on*, 5(7):920 – 930, july 2006.
- [21] Sinem Ergen and Pravin Varaiya. Energy efficient routing with delay guarantee for sensor networks. *Wireless Networks*, 13:679–690, 2007. 10.1007/s11276-006-8149-y.
- [22] Deepak Ganesan, Alberto Cerpa, Wei Ye, Yan Yu, Jerry Zhao, and Deborah Estrin. Networking issues in wireless sensor networks. *Journal of Parallel and Distributed Computing*, 64(7):799 – 814, 2004. Computing and Communication in Distributed Sensor Networks.
- [23] Rick W. Ha, Pin-Han Ho, X. Sherman Shen, and Junshan Zhang. Sleep scheduling for wireless sensor networks via network flow model. *Comput. Commun.*, 29:2469–2481, August 2006.
- [24] G. P. Halkes, T. van Dam, and K. G. Langendoen. Comparing energy-saving mac protocols for wireless sensor networks. *Mob. Netw. Appl.*, 10:783–791, October 2005.
- [25] Y.T. Hou, Y. Shi, J. Pan, and S.F. Midkiff. Maximizing the lifetime of wireless sensor networks through optimal single-session flow routing. *Mobile Computing, IEEE Transactions on*, 5(9):1255 –1266, 2006.
- [26] R. Jurdak, P. Baldi, and C.V. Lopes. Adaptive low power listening for wireless sensor networks. *Mobile Computing, IEEE Transactions on*, 6(8):988 –1004, aug. 2007.
- [27] Dongkyun Kim, J.J. Garcia-Luna-Aceves, K. Obraczka, J.C. Cano, and P. Manzoni. Power-aware routing based on the energy drain rate for mobile ad hoc networks. In *Computer Communications and*

REFERENCES

- Networks, 2002. Proceedings. Eleventh International Conference on*, pages 565 – 569, oct. 2002.
- [28] Jaehyun Kim, Jeongseok On, Seoggyu Kim, and Jaiyong Lee. Performance evaluation of synchronous and asynchronous mac protocols for wireless sensor networks. In *Sensor Technologies and Applications, 2008. SENSORCOMM '08. Second International Conference on*, pages 500 –506, aug. 2008.
- [29] Young Ik Kim, Bum-Gon Choi, Chang Seup Kim, and Min Young Chung. A synchronized mac protocol considering packet generation intervals in wireless sensor networks. In *TENCON 2009 - 2009 IEEE Region 10 Conference*, pages 1 –5, jan. 2009.
- [30] Jiageng Li, D. Cordes, and Jingyuan Zhang. Power-aware routing protocols in ad hoc wireless networks. *IEEE Wireless Communications*, 12:69–81, 2005.
- [31] Qun Li, Javed Aslam, and Daniela Rus. Online power-aware routing in wireless ad-hoc networks. In *Proceedings of the 7th annual international conference on Mobile computing and networking, MobiCom '01*, pages 97–107, New York, NY, USA, 2001. ACM.
- [32] Feng Liu, Chi-Ying Tsui, and Ying Jun Zhang. Joint routing and sleep scheduling for lifetime maximization of wireless sensor networks. *Wireless Communications, IEEE Transactions on*, 9(7):2258 –2267, july 2010.
- [33] P.K.K. Loh, Y. Pan, and Hsu Jing. Performance evaluation of efficient and reliable routing protocols for fixed-power sensor networks. *Wireless Communications, IEEE Transactions on*, 8(5):2328 –2335, may 2009.

- [34] R. Madan and S. Lall. Distributed algorithms for maximum lifetime routing in wireless sensor networks. *Wireless Communications, IEEE Transactions on*, 5(8):2185–2193, aug. 2006.
- [35] M. Mallinson, P. Drane, and S. Hussain. Discrete radio power level consumption model in wireless sensor networks. In *Mobile Adhoc and Sensor Systems, 2007. MASS 2007. IEEE International Conference on*, pages 1–6, 2007.
- [36] H. Nama, M. Chiang, and N. Mandayam. Optimal utility-lifetime trade-off in self-regulating wireless sensor networks: A distributed approach. In *Information Sciences and Systems, 2006 40th Annual Conference on*, pages 789–794, 2006.
- [37] Stephen G. Nash and Ariela Sofer. *Linear and Nonlinear Programming*. McGrawHill, 1996.
- [38] D Niculescu. Communication paradigms for sensor networks. *IEEE Communications Magazine*, 43(3):116–122, 2005.
- [39] J. Park and S. Sahni. An online heuristic for maximum lifetime routing in wireless sensor networks. *Computers, IEEE Transactions on*, 55(8):1048–1056, 2006.
- [40] Joongseok Park and Sartaj Sahni. Maximum lifetime routing in wireless sensor networks, 2005.
- [41] Vamsi Paruchuri, Shivakumar Basavaraju, Arjan Durrezi, Rajgopal Kannan, and S. S. Iyengar. Random asynchronous wakeup protocol for sensor networks. In *Proceedings of the First International Conference on Broadband Networks, BROADNETS '04*, pages 710–717, Washington, DC, USA, 2004. IEEE Computer Society.

REFERENCES

- [42] Joseph Polastre, Jason Hill, and David Culler. Versatile low power media access for wireless sensor networks. In *Proceedings of the 2nd international conference on Embedded networked sensor systems*, SenSys '04, pages 95–107, New York, NY, USA, 2004. ACM.
- [43] G. J. Pottie and W. J. Kaiser. Wireless integrated network sensors. *Commun. ACM*, 43:51–58, May 2000.
- [44] V. Raghunathan, S. Ganeriwal, and M. Srivastava. Emerging techniques for long lived wireless sensor networks. *Communications Magazine, IEEE*, 44(4):108 – 114, april 2006.
- [45] V. Raghunathan, C. Schurgers, Sung Park, and M.B. Srivastava. Energy-aware wireless microsensor networks. *Signal Processing Magazine, IEEE*, 19(2):40 –50, mar 2002.
- [46] V. Shah-Mansouri and V.W.S. Wong. Distributed maximum lifetime routing in wireless sensor networks based on regularization. In *Global Telecommunications Conference, 2007. GLOBECOM '07. IEEE*, pages 598 –603, 2007.
- [47] C. Shanti and A. Sahoo. Dgram: A delay guaranteed routing and mac protocol for wireless sensor networks. *Mobile Computing, IEEE Transactions on*, 9(10):1407 –1423, oct. 2010.
- [48] G. Simon. Probabilistic wireless network simulator. <http://www.isis.vanderbilt.edu/projects/nest/prowler>, 2003.
- [49] Suresh Singh, Mike Woo, and C. S. Raghavendra. Power-aware routing in mobile ad hoc networks. In *Proceedings of the 4th annual*

-
- ACM/IEEE international conference on Mobile computing and networking*, MobiCom '98, pages 181–190, New York, NY, USA, 1998. ACM.
- [50] I. Stojmenovic and X. Lin. Power-aware localized routing in wireless networks. *Parallel and Distributed Systems, IEEE Transactions on*, 12(11):1122–1133, nov 2001.
- [51] C.-K. Toh. Maximum battery life routing to support ubiquitous mobile computing in wireless ad hoc networks. *Communications Magazine, IEEE*, 39(6):138–147, June 2001.
- [52] Tijs van Dam and Koen Langendoen. An adaptive energy-efficient mac protocol for wireless sensor networks. In *Proceedings of the 1st international conference on Embedded networked sensor systems*, SenSys '03, pages 171–180, New York, NY, USA, 2003. ACM.
- [53] Chu-Fu Wang, Jen-Wen Ding, and Chun-Chia Lee. Joint optimization of energy allocation and routing problems in wireless sensor networks. *Wirel. Commun. Mob. Comput.*, 10:171–187, February 2010.
- [54] Yanwei Wu, Xiang-Yang Li, YunHao Liu, and Wei Lou. Energy-efficient wake-up scheduling for data collection and aggregation. *Parallel and Distributed Systems, IEEE Transactions on*, 21(2):275–287, feb. 2010.
- [55] Ya Xu, John Heidemann, and Deborah Estrin. Geography-informed energy conservation for ad hoc routing. In *Proceedings of the 7th annual international conference on Mobile computing and networking*, MobiCom '01, pages 70–84, New York, NY, USA, 2001. ACM.

REFERENCES

- [56] Wei Ye, John Heidemann, and Deborah Estrin. An energy-efficient mac protocol for wireless sensor networks. In *Proceedings of the IEEE Infocom*, pages 1567–1576, New York, NY, USA, June 2002. USC/Information Sciences Institute, IEEE.
- [57] Wei Ye, John Heidemann, and Deborah Estrin. Medium access control with coordinated adaptive sleeping for wireless sensor networks. *IEEE/ACM Trans. Netw.*, 12:493–506, June 2004.
- [58] Jennifer Yick, Biswanath Mukherjee, and Dipak Ghosal. Wireless sensor network survey. *Computer Networks*, 52(12):2292 – 2330, 2008.

Curriculum Vitae

Bilge Kartal Cetin was born in Sivas, Turkey, on March 6, 1981. In August 2006, she received a M. Sc. Degree in Electrical and Electronic Engineering, from the Graduate School of Natural and Applied Sciences, Ege University, Turkey.

From December 2004 to December 2007 she was a research assistant in the Department of Electrical and Electronic Engineering at the Faculty of Engineering, Ege University, Turkey. From March 2007 to November 2007 she was a guest scientific researcher at the Department of Electronic Systems, Aalborg University, Denmark.

From March 2008 to August 2011 she was a Ph. D. student at the Department of Electronic Systems, Aalborg University. During her Ph. D. studies she also worked within the ASPIRE project, a collaborative FP7 project funded by EU.

Her research interests include energy efficiency in sensor network, routing algorithms, optimization, and cognitive radio technology.