



Aalborg Universitet

AALBORG UNIVERSITY
DENMARK

Classification of electroencephalography for pain and pharmaco-EEG studies

Graversen, Carina

Publication date:
2011

Document Version
Publisher's PDF, also known as Version of record

[Link to publication from Aalborg University](#)

Citation for published version (APA):
Graversen, C. (2011). *Classification of electroencephalography for pain and pharmaco-EEG studies*. Aalborg Universitetsforlag.

General rights

Copyright and moral rights for the publications made accessible in the public portal are retained by the authors and/or other copyright owners and it is a condition of accessing publications that users recognise and abide by the legal requirements associated with these rights.

- Users may download and print one copy of any publication from the public portal for the purpose of private study or research.
- You may not further distribute the material or use it for any profit-making activity or commercial gain
- You may freely distribute the URL identifying the publication in the public portal -

Take down policy

If you believe that this document breaches copyright please contact us at vbn@aub.aau.dk providing details, and we will remove access to the work immediately and investigate your claim.

Classification of Electroencephalography for Pain and Pharmaco-EEG Studies

**Ph.D. thesis
Carina Graversen, M.Sc.E.E.**



Mech-Sense, Department of Gastroenterology and Radiology,
Aalborg Hospital, Aarhus University Hospital, Aalborg, Denmark

Center for Sensory-Motor Interactions (SMI), Department of Health Science and Technology,
Aalborg University, Aalborg, Denmark

ISBN (print edition): 978-87-7094-123-5
ISBN (electronic edition): 978-87-7094-122-8

List of papers

This Ph.D. thesis is partly based on four studies, which have been carried out in the period from 2006 to 2011 at Mech-Sense, Department of Gastroenterology and Radiology, Aalborg Hospital, Aarhus University Hospital, Aalborg, Denmark in collaboration with Center for Sensory-Motor Interactions (SMI), Aalborg University, Aalborg, Denmark.

The studies are referred to by Roman numerals in the text:

- I: Graversen C, Drewes AM, Farina D
Support vector machine classification of multi-channel EEG traces: A new tool to analyze the brain response to morphine treatment.
ConfProc IEEE Eng Med Biol Soc. 2010; 1:992-5
- II: Graversen C, Olesen AE, Staahl C, Drewes AM, Farina D
Classification of single-sweep evoked brain potentials for pharmaco-EEG by multivariate matching pursuit and support vector machine.
Submitted to IEEE Trans Inf Tech in Biomed
- III: Graversen C, Brock C, Drewes AM, Farina D
Biomarkers for visceral hypersensitivity identified by classification of electroencephalographic frequency alterations.
Journal of Neural Engineering. 2011. In press.
Doi: 10.1088/1741-2560/8/5/056014
- IV: Graversen C, Olesen SS, Olesen AE, Steimle K, Farina D, Wilder-Smith OHG, Bouwense SAW, van Goor H, Drewes AM
The analgesic effect of pregabalin in chronic pain patients is reflected by changes in pharmaco-EEG spectral indices.
British Journal of Clinical Pharmacology. 2011. In press.
Doi: 10.1111/j.1365-2125.2011.04104.x

Acknowledgments

This Ph.D. was carried out during my employment as an engineer and Ph.D. student at MechSense, Department of Gastroenterology and Radiology, Aalborg Hospital, Aarhus University Hospital, Aalborg, Denmark from 2006 to 2011. The thesis is based on four experimental investigations conducted at Aalborg Hospital, and includes patients and healthy volunteers.

During my Ph.D. I had the privilege to have three excellent supervisors to whom I owe my most sincere gratitude. My main supervisor, Professor, MD, Ph.D., DMSc Asbjørn Mohr Drewes, who created a working environment enabling advanced experimental studies and constantly pointed the work into a clinical relevant direction. My second supervisor, Professor, Ph.D. Dario Farina, who inspired me with comments and suggestions on the development of signal processing methods and support whenever frustrations grew high. During my employment at the Department of Radiology I was also greatly inspired by my third supervisor, MD, Ph.D. Jens Brøndum Frøkjær with whom I conducted a diabetes study in Denmark and Norway.

During my Ph.D. I was also greatly inspired by my colleagues and the always ongoing interdisciplinary discussions in the office. My colleagues taught me the challenge of explaining advanced signal processing in a simple manner, and demonstrated a lot of patience when they were teaching pain physiology and pharmacology to me. For practical assistance in the laboratories and recruitment of subjects for the experiments, I would also like to thank the excellent research nurses Birgit Koch-Henriksen and Isabelle M. Larsen. I also have a special thank to all the patients and volunteers who participated in the studies. Without their contribution, the research projects would not have been possible.

Last but not least I would like to thank my family for the never failing support and constant interest in my research. I also owe my really good friends a special thank, they taught me the value of true friendship and support whenever it was needed.

The work has received financial support from the Danish Agency for Science Technology and Innovation, Karen Elise Jensen Foundation, det Obelske Familiefond and the European Commission (Seventh Framework Programme, "DIAMARK" 223630). All contributions have been of great value.

Aalborg, Denmark, 27th of December 2011.

Carina Graversen

Abbreviations

BC	Bayesian classifier
BCI	Brain-computer interface
CNS	Central nervous system
CWT	Continuous wavelet transform
DTI	Diffusion tensor imaging
DWT	Discrete wavelet transform
EEG	Electroencephalography
EMG	Electromyography
EP	Evoked potential
fMRI	Functional magnetic resonance imaging
FT	Fourier transform
HRV	Heart rate variability
IASP	International Association for the Study of Pain
LDA	Linear discriminant analysis
MEG	Magnetoencephalography
MMP	Multivariate matching pursuit
MP	Matching pursuit
MRA	Multi resolution analysis
MRI	Magnetic resonance imaging
MWF	Mother wavelet function
NMDA	N-methyl-D-aspartate
NN	Neural network
NNC	Nearest neighbor classifier
PET	Positron emission tomography
RBF	Radial basis function
SPECT	Single photon emission computed tomography
STFT	Short-time Fourier transform
SVM	Support vector machine
TMP	Temporal matching pursuit
VVH	Viscero-visceral hyperalgesia
WHO	World Health Organization
WVD	Wigner-Ville distribution

Table of contents

1.	Introduction	8
1.1.	Clinical pain	8
	<i>Pain mechanisms</i>	8
	<i>Analgesic mechanisms</i>	9
1.2.	Experimental pain	9
1.3.	Objective pain measurements	10
1.4.	Extraction and classification of EEG	11
1.5.	Hypothesis	12
1.6.	Aims	13
2.	Pain physiology	14
2.1.	Peripheral afferents	14
2.2.	Spinal cord pain processing	15
2.3.	Supra-spinal pain processing	15
	<i>Primary and secondary somatosensory cortices</i>	16
	<i>Insula</i>	16
	<i>Cingulate cortex</i>	16
	<i>Prefrontal cortex</i>	17
2.4.	Visceral pain	17
2.5.	Facilitory and inhibitory pain mechanisms	17
	<i>Central sensitization</i>	19
2.6.	Pain disorders	20
	<i>Chronic pancreatitis</i>	20
	<i>Diabetes mellitus</i>	20
3.	Pain treatment	21
3.1.	Opioids	21
3.2.	Pregabalin	23
4.	Electroencephalography	24
4.1.	EEG recordings in visceral pain studies	24
4.2.	Pain assessment with EEG	25
4.3.	Frequency characteristics	27
5.	Feature extraction	28
5.1.	Time-frequency algorithms	28
5.2.	Wavelet transform	29
	<i>Continuous wavelet transform (CWT)</i>	29
	<i>Discrete wavelet transform (DWT)</i>	30
5.3.	Matching pursuit	31
	<i>Multivariate matching pursuit (MMP)</i>	32
	<i>Temporal matching pursuit (TMP)</i>	33

6.	Classification.....	35
6.1.	Classification algorithms	35
6.2.	Support vector machine	36
	<i>Kernel methods</i>	37
6.3.	Support vector machine regression.....	38
7.	System development	40
7.1.	Single-channel versus multi-channel recording	40
7.2.	Selection of feature extraction method	42
7.3.	Selection of input features to the support vector machine	44
8.	Ongoing studies	46
8.1.	Frequency analysis of diabetes mellitus patients	46
8.2.	Source localization in diabetes mellitus patients.....	48
9.	Conclusions	51
10.	Future perspectives	53
11.	Danish summary.....	54

1. Introduction

Pain is the most common cause for patients seeking medical attendance [1]. It is estimated that approximately 19% of adults in Europe suffer from chronic pain, which has major impact on quality of life for the patients and economical consequences for the society. However, pain treatment is a major challenge in the clinic, and nearly half of the patients are influenced by inadequate treatment [2]. The challenge to treat patients is among other factors caused by lack of indebt knowledge of pain and analgesic mechanisms in *individual patients*. To gain such knowledge, improved methods to identify biomarkers for the mechanisms on a single subject basis are warranted.

1.1. Clinical pain

Pain is a multi-dimensional and highly individual perception comprised of sensory-discriminative, affective-motivational, and cognitive-evaluative factors [3]. Furthermore, pain can be generated in multiple ways at different levels of the neuraxis coexisting to the overall pain perception, which makes identification of pain mechanisms difficult in clinical settings [4]. Especially in *visceral pain*, clinicians are often limited to base pain treatment on a simple trial-and-error principle depending on the symptoms reported by the patient. However, the symptoms and subjective pain description does not identify the underlying mechanisms of the abnormal pain processing, as well as the perception is not always confirmed by pathological investigation of the diseased organs [5]. Furthermore, patients diagnosed with the same disease experience different efficacy of the same compounds, often due to multiple mechanisms contributing to the pathogenesis of pain [6].

Pain mechanisms

The general understanding of pain is associated with an intense noxious peripheral stimulus conducted to the brain via spinal cord neurons. However, in most chronic pain patients, pain often arises either as spontaneous pain in the absence of any peripheral input or in response to an innocuous stimulus [7]. These pain states are mediated by various input channels including modulation in the spinal cord, and although previous studies have identified which mechanisms are sufficient to produce chronic pain, the challenge is to identify which mechanisms are present in each individual patient.

Some of the pain mechanisms which can lead to painful sensations are: 1) nociceptive pain; 2) peripheral sensitization; 3) peripheral nerve injury; 4) central sensitization; 5) synaptic reorganization; 6) disinhibition; and 7) spontaneous activity in the central neurons [7].

One mechanism of utmost importance in visceral pain is *central sensitization (III and IV)*, which arises when the central nervous system (CNS) is triggered by a nociceptive input, and the neural hyperexcitability persists after the input diminishes or disappears [8]. Consequently, pain perception of a subsequent innocuous stimulus is perceived as painful (allodynia), while a painful stimulus is amplified to increased intensity (hyperalgesia).

Analgesic mechanisms

To target the different underlying pain mechanisms, several types of analgesics have been developed. The analgesic effect is often obtained by activation or blocking of specific receptors within the CNS or reduction in the release of neurotransmitters [9-12]. For patients who exhibit central sensitization, typical prescribed analgesics include opioids such as morphine and adjuvant drugs such as gabapentinoids.

Morphine (**I** and **II**) is a strong analgesic used to treat moderate to severe pain with the effect related to binding to the μ -receptors in the CNS [13]. Although morphine is a strong opioid, the efficacy of the drug is highly individual with major variation in adverse effects, and it is estimated that on average only 30% of patients exhibit adequate pain relief [14;15]. To improve pain treatment, several attempts have been made to predict the responsiveness of morphine, which has included assessment of genetic and immunological factors for subjects exposed to different modalities of painful stimulations [16]. However, at the time being no reliably methods have been developed for clinical use.

A gabapentinoid which has recently been validated to be effective for patients who exhibit central sensitization is pregabalin (**IV**) [17]. Pregabalin exerts its main analgesic effect by selectively binding to the alpha-2-delta subunit of voltage-dependent calcium channels. This blocks the calcium influx into the presynaptic nerve terminals, and hence reduces the pool of excitatory neurotransmitters such as glutamate, noradrenalin and substance P [11;18]. As the efficacy of pregabalin is also highly individual, biomarkers to predict and monitor the clinical pain relief are sought.

1.2. Experimental pain

As clinical pain is biased by cognitive and emotional factors and coexisting pain mechanisms, assessment of basic pain manifestations in chronic pain patients is complicated. To overcome this issue, experimental pain evoked in healthy volunteers establishes a platform to study pain processing in a standardized manner with reproducible results (Figure 1) [19]. In these models acute painful stimuli are controlled precisely with respect to localization, intensity, duration and modality [20]. To mimic clinical pain, long-lasting painful sensations can be applied by infusion of chemicals to initiate some of the inflammatory processes seen in chronic pain patients [21-23]. The pain and analgesic mechanisms may then be assessed by subjective or objective scores.

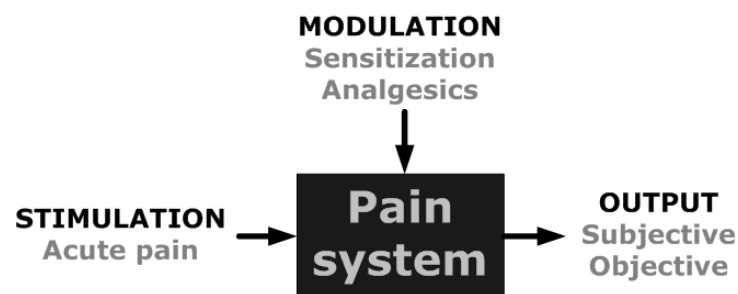

Figure 1. Schematic overview of experimental pain models. The pain system is considered a black box, which can be activated by a controlled stimulus or chemicals to mimic clinical pain. Furthermore, administration of analgesics enables studies of the analgesic effect of various compounds. The output reflects the pain response in a standardized and reproducible manner.

1.3. Objective pain measurements

As typical pain mechanisms cannot be assessed by questionnaires and subjective pain symptoms reported by the patient, objective methods assessing the central nervous system response are needed. To base the analysis for this thesis on the most suitable technology, which is also feasible in clinical setups, we carefully considered the neuro-imaging methods and published our recommendations in a review [24]. In brief, the methods can be split into electroencephalography (EEG), magnetoencephalography (MEG), magnetic resonance imaging (MRI), positron emission tomography (PET), and single photon emission computed tomography (SPECT). Furthermore, pain assessment can be based on nociceptive withdrawal reflex responses and autonomic parameters such as heart rate variability (HRV) etc.

EEG (I, II, III, and IV) is used to image the electrical activity in the brain generated by neuronal firing between various brain centers. The firing is usually randomly distributed in time when a person is in resting state, but the neural networks can be synchronized and activated sequentially and in parallel as a response to an external stimulus. The *resting state EEG* has been used to reflect the pathophysiology of pain in chronic pain patients and alterations in the CNS during pharmacological intervention [25;26]. In contrary, the *evoked brain potentials* (EPs) following an external painful stimulus has been used to study the nociceptive response to acute pain in patients or after modulation of the CNS by drugs or chemicals [23;27-29]. EEG has the advantage of high temporal resolution, relatively low-cost and *feasibility in clinical settings*, which were the main reasons to choose this method for all four studies in the present thesis. In contrary, the most important limitation of EEG is the relatively poor spatial resolution in respect to identification of activated brain centers. However, as source localization was not expected to be the main feature in describing pain and analgesic mechanisms, this limitation was not considered important.

MEG is used to image the magnetic fields produced by the electrical activity in the brain. MEG and EEG share many common features with regard to recording and analysis techniques, although MEG has mainly been applied in studies of association between pain and cortical reorganization in somatic and neuropathic pain studies [30]. MEG has the advantage of high spatial resolution and minimum distortion of the signals. On the other hand, MEG is limited by its incapability to record magnetic fields from deep brain structures due to shielding of the magnetic fields by volume currents. As the deep brain structures play a key role in brain processing of pain, MEG was not considered suitable for the study of pain and analgesic mechanisms.

MRI is used to image brain structures, which enables analysis of diffusion tensor imaging (DTI) including tractography, volumetry of brain structures and measurement of grey matter density. These features give valuable information about neural structures and connections between brain centers involved in pain processing [31;32]. Furthermore, MRI can be used to measure the functional brain activity (fMRI) by quantification of changes in local blood flow due to neural activity [33]. The advantage of MRI is its excellent spatial resolution, and the non-invasive and non-radioactive properties of the recording technique. However, MRI is highly limited by poor temporal resolution in the range of seconds, which to some extent discards important information on how

brain centers interact by various oscillations. Furthermore, MRI is expensive and not suitable in general clinical settings such as outpatients visits.

PET and SPECT images radiolabeled molecules injected into the blood stream, which can be used to gain further knowledge of organization of functional networks in the brain, receptor sites and enzyme function [34]. The main advantages of PET are the spatial resolution and the ability to study receptor distribution. The main advantage of SPECT is the utilization of isotopes with a long half life, which enables imaging several hours or even days after administration of pharmacological drugs. The limitations of both PET and SPECT are mainly that subjects receive a considerable dose of radiation, which makes it less suitable for continuous monitoring of progression of pain mechanisms and how these are targeted by analgesics. Furthermore, the temporal resolution is in general poor and group analysis involving several subjects are typically needed to obtain meaningful results.

Nociceptive withdrawal reflexes mainly measure how a nociceptive input is processed in the spinal cord. The reflex is typically evoked by stimulation of the sural nerve at the ankle, and recorded by electromyography (EMG) at the tibial or biceps muscle. The reflex threshold and velocity provides the output measurement [35]. These features have been correlated to the stimulus-response curves for pain intensity, and provide a robust measure for small sample sizes influenced by confounding parameters. In contrary, the reflexes only represent a part of the complex sensory and affective experience of pain, which invalids them to stand alone as output measurements [36].

Autonomic parameters provide a measure of the physiological stress response during pain, which affects the autonomic nervous system by increased sympathetic activity and decreased parasympathetic activity. Consequently, the blood pressure and HRV are increased, which have been correlated to the presence of pain, and hence provide an output measurement which is easy and inexpensive to obtain [37-39]. On the other hand, the measurements are limited as they only reflect if pain is present without identifying which mechanisms contribute to the subjective pain experience.

1.4. Extraction and classification of EEG

Experimental pain models based on objective EEG outputs have been used in several previous pain studies. The EEG signals may be assessed in many different ways depending on the type of recording and which aspects of the CNS are addressed. Resting EEG is typically assessed by frequency analysis, and presented by features such as power distribution in predefined frequency bands, peak frequency, mean dominant frequency, and spectral edge frequency [40]. For example Sarnthein *et al.* did a study on chronic pain patients with neurogenic pain, and found that patients were characterized by increased frequency oscillations in the theta band (4 – 9 Hz), and that this characteristic was reversible 12 month after a therapeutic lesion in the thalamus [41]. EPs are typically analyzed with respect to amplitude and latency of the main peaks, frequency characteristics and location of the dipolar sources [29;42-44]. However, all these studies on both resting EEG and EPs have aimed at describing common alterations in pain patients and after pharmacological intervention. This has shed new light over basic mechanisms to develop new drugs and test them,

but have minor relevance in the clinic in respect to establishing an approach to obtain *individualized medicine*.

In other areas of neuroscience research, biomarkers reflecting various conditions and diseases are extracted from the EEG signals and in its infancy to be used to diagnose and optimize treatment in clinical practice. These biomarkers are characteristics that are objectively measured and evaluated as in indicator of normal or abnormal biologic processes [45]. To detect subjects with probable Alzheimer's disease, power distributions of spectral indices and measures of spatial synchronization have been used as input to classification algorithms such as the *support vector machine* (SVM) [46]. EEG features have also been extracted from patients diagnosed with schizophrenia to detect neurocognitive markers of the condition. These features were also classified by a SVM, and demonstrated the potential of an algorithm to identify biomarkers independently of clinical assessment [47]. Furthermore, features extracted and classification of EEG characteristics has been implemented in real-time to monitor incidences of hypoglycemia (blood glucose level below 3.8) in diabetic patients [48].

Feature extraction followed by classification is also commonly used to develop applications for brain-computer interfaces (BCI) [49]. BCI applications provide an alternate communication pathway for patients with motor dysfunction, and BCI is a research area with highly developed signal processing methodologies. In BCI research, the feature selection has been demonstrated to be of utmost importance, and extraction of time-frequency coefficients by an algorithm adapted to the actual data has been proposed [50]. Furthermore, Bai *et al.* did a study where they compared the computational methods for classification of single sweeps of the EPs, and found the SVM to be superior to other classifiers [51].

1.5. Hypothesis

To develop a system to identify biomarkers for the underlying pain and analgesic mechanisms in individual patients, several methods need to be developed and validated. To identify pain mechanisms, the first approach could be to classify EEG alterations after sensitization of the nervous system in healthy volunteers (III). This would mimic clinical pain due to central sensitization but bypasses the possibility of other pain mechanisms contributing to the pain experience, as well as confounding psychological factors would be avoided. After establishing this model, the robustness should be tested in patients with chronic pain (ongoing study).

Likewise, to assess the analgesic mechanisms and pain relief after pharmaceutical intervention, the methods could be developed by first classifying the EEG alterations after drug administration in healthy volunteers. This could be achieved by first performing a group analysis to validate whether the EEG reflects measurable changes (I), followed by an individual analysis to assess the level of alteration (II).

To validate the developed methods and their usability in clinical settings, the system should be applied to chronic pain patients treated with analgesics (IV).

Based on this possible workflow, we *hypothesized* that abnormal visceral pain processing and the altered pain processing after administration of CNS active analgesics would be identifiable by classification of EEG responses in individual subjects.

This would be a major step towards mechanisms-based pain diagnosis and treatment, where pain mechanisms are identified and used to select appropriate treatment, followed by a measure of the analgesic efficacy (Figure 2) [7]. This approach includes the possibility that a single etiological factor may induce pain by diverse serial and parallel mechanisms.

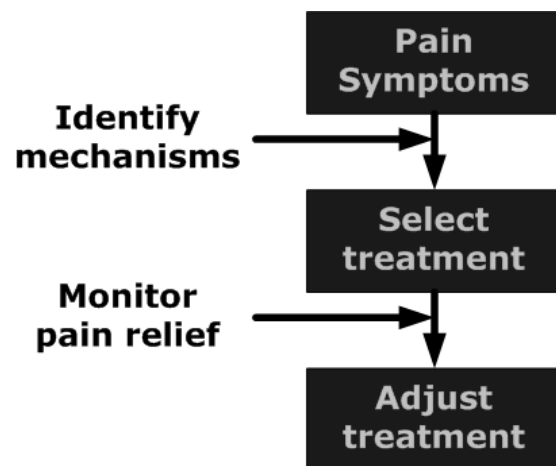

Figure 2. The ultimate goal in mechanisms-based pain treatment is to develop a reliable system to identify the underlying pain mechanisms in each individual patient, as this enables selection of appropriate treatment. To further optimize the pain treatment, the analgesic effect should be monitored to adjust doses or analgesic compound to obtain maximum analgesic effect with minimum dose of drug.

1.6. Aims

To test the hypothesis that classification of EEG features can be used to identify biomarkers for abnormal visceral pain processing due to central sensitization and chronic pain, and that the pain relief from analgesics can be monitored by EEG, the aims of the project were:

- 1) To optimize EEG recording techniques for visceral pain studies, including both resting EEG and EPs obtained during electrical stimulation of the oesophagus and rectosigmoid colon.
- 2) To develop methods to classify EEG from healthy volunteers on a group level to identify both pain and analgesic mechanisms.
- 3) To develop methods to classify EEG from healthy volunteers on a single subject basis to assess the individual alteration of the CNS response to pain after treatment with analgesics.
- 4) To verify the developed methods by monitoring the analgesic effect in patients with chronic pain by classification of the altered EEG response before and after treatment.

2. Pain physiology

According to the International Association for the Study of Pain (IASP), pain is defined as “an unpleasant sensory and emotional experience associated with actual or potential tissue damage, or described in terms of such damage”. As pain involves both sensory and emotional experiences, several components are involved in a complex network of neurons within the CNS, which can be split into peripheral afferents, the spinal cord, and the supra-spinal level (Figure 3).

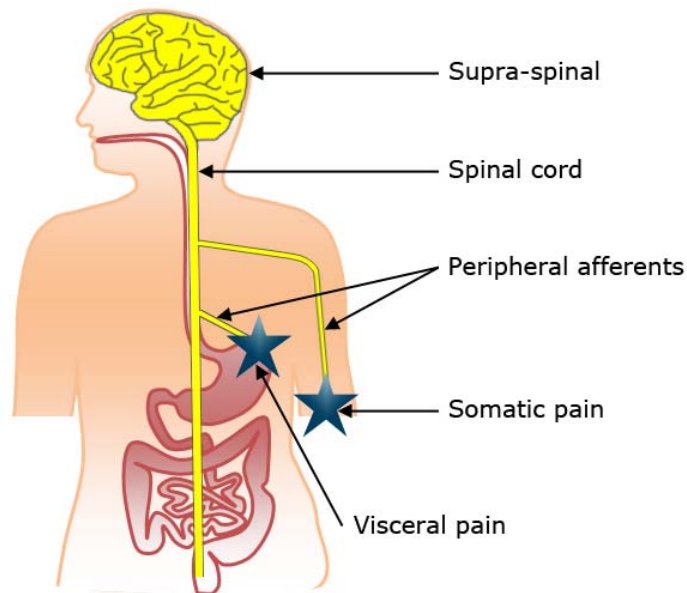

Figure 3. The pain system, which can be divided into peripheral afferents, the spinal cord and the supra-spinal (brain) level.

2.1. Peripheral afferents

Peripheral afferents (also termed first-order neurons) respond to different types of noxious and sensory stimuli, and transmit the information to the dorsal horn of the spinal cord. The afferents can be split into three main types of nerve fibers with different properties in respect to type of stimuli they respond to and nerve conduction velocity [52]:

- A β -fibers are thick myelinated fibers responding to light touch and convey tactile information. They conduct the information from the periphery to the CNS quickly.
- A δ -fibers are thin myelinated fibers responding to noxious mechanical, thermal or chemical stimuli. They conduct the information from the periphery to the CNS with medium speed.
- C-fibers are thin non-myelinated fibers, and respond to the same type of stimuli as A δ -fibers but with slower conduction properties.

Hence, painful responses are mediated by activation of A δ - and C-fibers with the information conducted by action potentials reflecting the stimulus intensity [53]. The communication between nerve fibers takes place via release of neurotransmitters, which can either *facilitate* or *inhibit* the neuronal activity [54]. Among these neurotransmitters are glutamate, noradrenalin, and substance P, which are all facilitating synaptic activity (IV).

2.2. Spinal cord pain processing

The peripheral afferents terminate primarily at the dorsal horn of the spinal cord through the dorsal root ganglion. For most tissue the A δ fibers project to both superficial layers (laminae I-II) and deeper layers (lamina V), while C-fibers terminate only at superficial layers, and the information is then conveyed by interneurons to deeper layers. From lamina V, the neurons mainly project to the thalamus (forming the spinothalamic tract).

In the spinal cord, the transmission of the incoming sensory and nociceptive input may undergo modulation to enhance or reduce the signal intensity transmitted to the brain [52]. One possible modulation to reduce pain intensity by pharmacological intervention is by blocking the N-methyl-D-aspartate (NMDA) receptor, as this receptor has been shown to play a key role in developing central sensitization [52;55]. As the spinal cord activity plays a vital role in analgesic intervention, imaging the spinal activity before and after drug administration would be of great interest. However, at the moment no reliable model has been established although several attempts have been tried for both fMRI and EEG. In a pilot study we tested a new model based on one patient with chronic pain due to irritated bowel syndrome. This patient had an epidural electrode implemented in the spinal cord for electrical stimulation as pain relief, and with the connecting wires available from the skin (Figure 4a). By stimulation of the tibial nerve, we recorded the action potential at T12, and were able to record trustful evoked potentials (Figure 4b). This approach have some limitations due to the fact that only chronic pain patients with the device implanted for clinical purposes can be enrolled in studies recording the spinal activation before and after drug administration. However, even with this limitation further development of the system would be a major step towards developing the *ultimate pain model*, which could be used to identify underlying analgesic mechanisms at the spinal cord level.

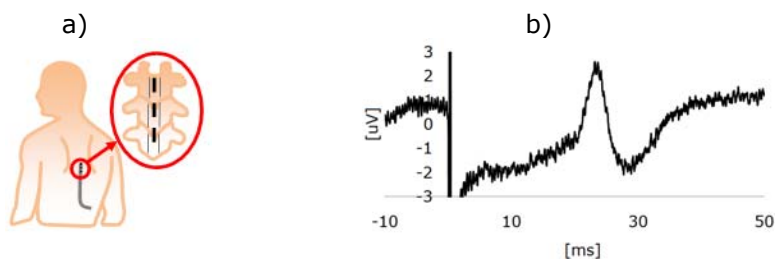

Figure 4. Recording of spinal evoked potential in a patient with chronic pain. a) The epidural electrode was placed at T12, and the wires were accessible from the skin due to a temporary placement of the electrodes. b) Spinal evoked potential averaged over 1000 sweeps.

2.3. Supra-spinal pain processing

The output from the dorsal horn of the spinal cord is transmitted to the brain by spinal projection neurons along ascending pathways [52]. It has been shown that cells in lamina I project to thalamus, the pariaqueductal grey (PAG), and parabrachial area (PB) in the brain [56;57]. In contrary, the lamina V neurons mainly innervate the thalamus which activates the higher cortical centers such as primary and secondary somatosensory cortex, insula, anterior cingulate cortex, and prefrontal cortex (Figure 5).

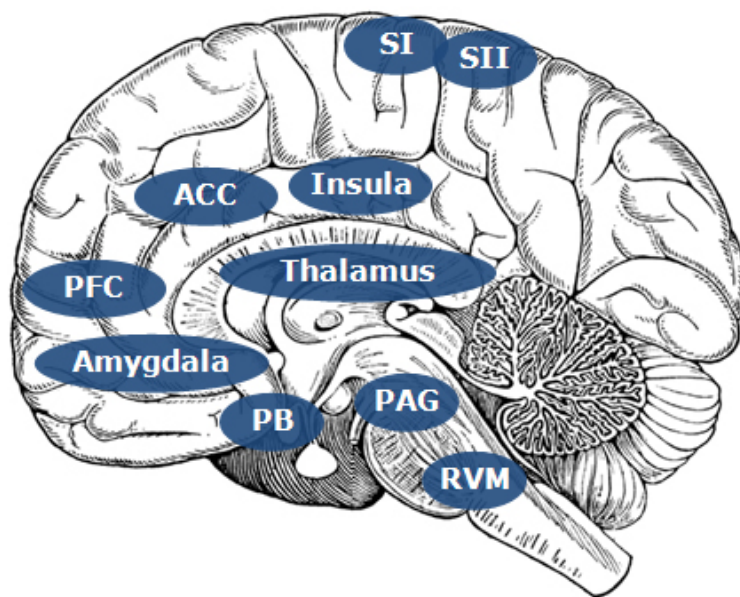

Figure 5. Schematic representation of the brain and the centers involved in pain processing: thalamus, insula, amygdala, prefrontal cortex (PFC), anterior cingulate cortex (ACC), primary and secondary somatosensory cortices (SI and SII, respectively), parabrachial area (PB), periaqueductal gray (PAG), and rostral ventromedial medulla (RVM).

Primary and secondary somatosensory cortices

The primary and secondary somatosensory cortices (SI and SII, respectively) receive nociceptive input from the thalamus to encode the sensory-discriminative aspect of pain. Hence, both SI and SII are involved in recognition, learning and memory of painful experiences [58].

Insula

The insula receives projections from SII and thalamus, and has been shown to be activated by visceral stimulations [59]. The insula is thought to be involved in generating the multidimensional experience of pain, since it receives direct input from affective and sensory centers [60]. However, it should be noted that in clinical pain (which has a greater affective component), the rostral anterior insula is activated more often than the caudal anterior insula mostly activated in experimental pain [61].

Cingulate cortex

The cingulate cortex is involved in processing of both visceral and somatic sensation, with the anterior midcingulate cortex involved in behavioural responses and attention to the pain perception. In contrary, the perigenual part of the cingulate cortex is connected to the brainstem and involved in visceromotor control and modulation of the autonomic and emotional responses to the external stimuli [62;63]. Furthermore, the cingulate cortex is involved in the affective-motivational aspects of pain processing [64;65]. An alteration of the pain processing in the cingulate cortex has been observed due to visceral hypersensitivity manifested as a shift in the dipolar source localization [23]. This shift may represent a change in the pain experience after sensitization, as the dipole moved to the posterior region of the cingulate cortex, which is believed to encode pain unpleasantness and cognitive processes [66]. Furthermore, in a study of the dipole sources of the EPs from study I and II, we found a shift in the brain activity in the anterior cingulate cortex [29].

Prefrontal cortex

The prefrontal cortex is activated in response to somatic and visceral sensation in interaction with the cingulate cortex. The prefrontal cortex is believed to be responsible for cognitive evaluation, self-awareness, attention and behavioral control [67]. Furthermore, the prefrontal cortex plays a key role in the pain inhibitory matrix by among other factors endogenous opioids [68;69].

2.4. Visceral pain

To base the studies in the healthy volunteers on pain sensations frequently reported by patients, all studies in healthy volunteers were based on visceral pain (I, II, III). The visceral pain system shares many mechanisms with somatic pain, although there are also differences in the way pain is mediated. The visceral afferents can be split into low- and high-threshold fibers. The low-threshold afferents respond to sensory levels of stimuli, while the high-threshold afferents respond to a higher level of stimuli in the noxious range [70]. The gastrointestinal tract also contain a type of receptors termed "silent nociceptors", which do not respond to normal stimulus, but may become activated if the intestine is injured or inflamed [71]. Furthermore, the anal canal is innervated with nociceptors comprising of both A δ and C visceral fibers and somatic A β fibers.

At the supra-spinal level, it has been demonstrated that the brain sources activated are different during visceral pain compared to somatic pain [20]. The activated brain areas in visceral pain are mainly secondary (SII) somatosensory cortex, the motor and frontal cortices, the insula, cingulate cortex, thalamus and the cerebellum [72]. Especially the insula has been identified to have a pivotal role in regulation and sensation of painful visceral input, and studies have demonstrated direct inter-connections between the insula and the thalamus, prefrontal cortex, cingulate cortex, and primary and secondary somatosensory cortices [72;73]. However, it should be noted that the site of stimulation does also influence the brain sources activated [74;75].

2.5. Facilitory and inhibitory pain mechanisms

The spinal cord and the brain together control a complex network of sensation and pain signaling. The pain control involves both inhibitory and facilitating phenomena in a dynamic balance of bidirectional pain-control mechanisms (Table 1).

Table 1. Inhibitory and facilitating mechanisms in pain perception.

Phenomena	Pain intensity	Description
Central sensitization [76] (III and IV)	↑	Central sensitization is characterized by an increased firing frequency and decreased activation threshold of the dorsal horn neurons. This may lead to allodynia and hyperalgesia. See also section below.
Wind-up [77]	↑	Wind-up is characterized by an increase in action potentials firing in the dorsal horn neurons during repeated stimulation with the same intensity, and has mainly been demonstrated in animal studies. The phenomenon arises due to repeated stimulation of C-fibers.
Long term potentiation [78]	↑	Long term potentiation is characterized by a persistent increase in synaptic efficacy, which may occur after a brief high frequency input stimulus.
Temporal summation [79;80]	↑	Temporal summation is characterized by increased pain perception to repeated stimulations with a low inter-stimulus interval [81]. The phenomenon is thought to be the human correlate to the early phase of wind-up and sensitization in chronic pain patients.
Spatial summation [82]	↑	Spatial summation is characterized by increased pain perception and decreased pain threshold obtained by converging signals from several nociceptors from an increased site of stimulation area.
Gate control [83]	↓	The gate control theory of pain is based on the theory that large myelinated non-nociceptive A β -fibers activates inhibitory interneurons, which stabilizes the nociceptor and prolongs the period for depolarization of the pain-coding afferents.
Conditioned pain modulation [84]	↓	Conditioned pain modulation (previously termed diffuse noxious inhibitory control - DNIC), is suppression of pain perception due to a counterirritating noxious (conditioning) stimuli at a distant part of the body. The effect is obtained by inhibition of some of the neurons in the dorsal horn due to the conditioning stimulus, and the pain relief of a following test stimulus is sometimes preserved several minutes after the conditioning stimulus is stopped.
Habituation [85]	↓	Habituation is an antinociceptive mechanism, which causes a decrease in pain and pain-related responses to continuous or repeated stimuli with a low inter-stimulus interval.
Endogenous opioids [86]	↓	The endogenous opioid system is involved in the regulation of the experience of pain and analgesic opioate drugs. The endogenous opioids interact with a number of cortical and subcortical regions [84]. Furthermore, endogenous opioids are believed to be involved in the placebo effect.

Central sensitization

Central sensitization alters the pain processing in such a way, that the intensity, duration and spatial perception does no longer present the specific qualities of the stimulus, but rather represents the particular functional state of the CNS [8]. This phenomenon occurs when incoming visceral nerve afferents converge with spinal neurons, and the increased synaptic efficacy activates pain circuits normally transmitting innocuous stimuli (allodynia) or by amplification of the pain response to a noxious stimulus (*hyperalgesia*) – Figure 6. The increased synaptic efficacy is obtained by increased release of neurotransmitters such as aspartate, glutamate, and substance P [87]. These neurotransmitters cause the NMDA receptor to open and close quickly, and hence are responsible for fast excitatory synaptic transmission in the spine [52].

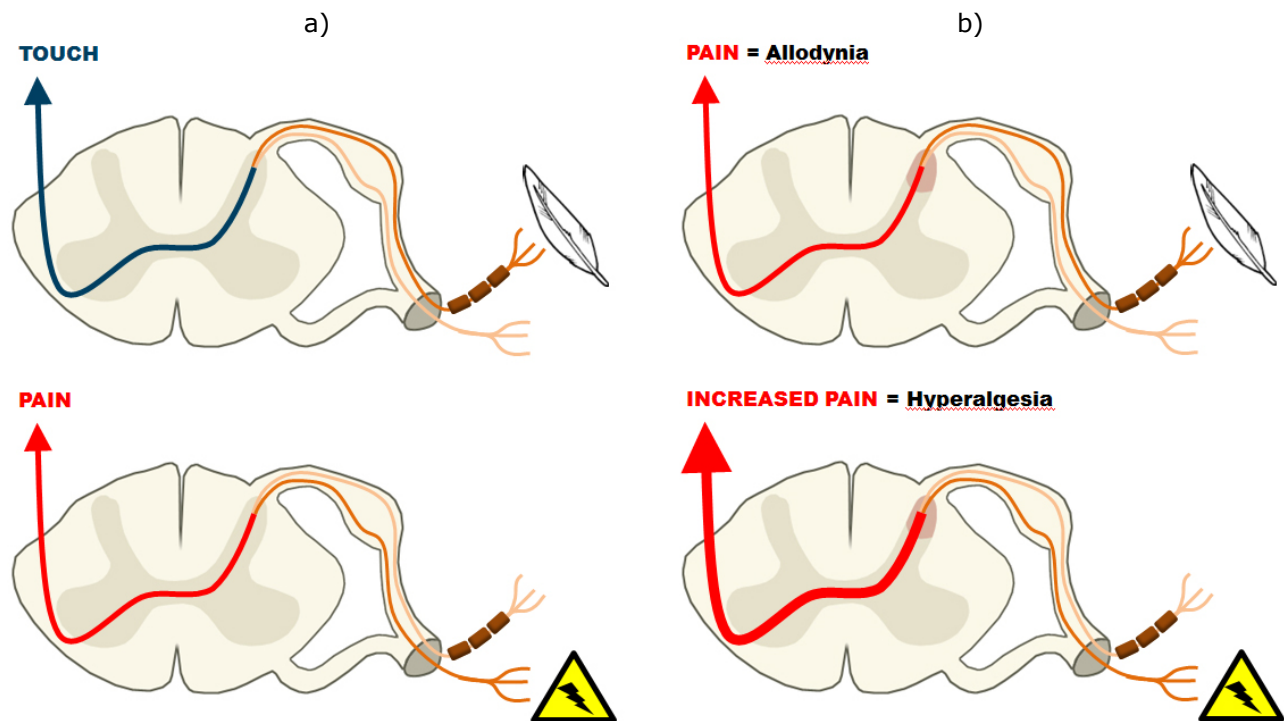

Figure 6. Normal and abnormal pain processing in the central nervous system. a) In normal pain processing, an innocuous stimulus is perceived as touch (top), and a noxious stimulus is perceived as pain (bottom). b) Abnormal pain processing due to central sensitization, where an innocuous stimulus is perceived as painful (top), and a painful stimulus is perceived as extra painful (bottom).

One instance of central sensitization is *viscero-visceral hyperalgesia* (VVH), where activation of the pain system affects sensitivity in a remote and otherwise healthy organ. To study VVH (III), we recorded EPs following electrical stimulations in the rectosigmoid colon before and after sensitization of the oesophagus with a perfusion of acid and capsaicin. In comparison to placebo, central sensitization induced an alteration in the EEG manifested as an increase in the delta (0.5 – 4 Hz), theta (4 – 8 Hz), and alpha (8 – 12 Hz) frequency bands. Furthermore, the individual alteration of the EEG was correlated to the individual subjective perception of hyperalgesia (percentage change in current to inflict moderate pain before and after perfusion). Hence, biomarkers reflecting underlying pain mechanisms can be extracted from the EEG, which might in the current form be applied to secure enriched enrollment of study subjects in pharmacology testing [88;89].

2.6. Pain disorders

The study of pain mechanisms may initially be based on healthy volunteers, where the CNS is modulated to study analgesic intervention (I and II) or mimic pain conditions (III). However, to validate the obtained results, the methods and finding must be confirmed in the environment where they are sought to have practical implications – in *chronic pain patients* (IV). To perform this validation, we investigated two distinct patient groups with chronic pain. In one study (IV) we investigated patients with chronic pancreatitis, which is a patient group who often exhibit central sensitization, and in another study (ongoing) we analyzed a patient group with neuropathic pain due to diabetes mellitus.

Chronic pancreatitis

Chronic pancreatitis (IV) is a disease characterized by chronic pain possibly arising from several mechanisms acting in symphony to cause pain in the individual patient [90]. The disease is characterized by inflammation and progressive destruction of the pancreatic gland, which may arise from damage of the pancreatic nerves along with peripheral and central sensitization. Most patients require analgesic treatment, as for example medication with anti-epileptic effects such as gabapentin and pregabalin [8;91].

To test if EEG was a suitable neurophysiological method to monitor the analgesic effect of pregabalin in chronic pain patients, we first investigated if the patients had altered brain activity in resting condition compared to healthy controls [25]. In this initial study, we saw an increase in the delta, theta, and alpha bands similar to what we observed in study III, and hence the alteration of brain oscillations was detectable in the EEG.

Diabetes mellitus

Diabetes mellitus is a disease with increasing prevalence in the global population [92]. A cardinal symptom is dysfunction of the autonomic nervous system which affects the gastrointestinal tract causing nausea, vomiting, bloating, diarrhea, and abdominal pain. Chronic pain is not a cardinal symptom in this patient group, but a portion of the patients develop diabetic autonomic neuropathy leading to progression of the dysfunction and abnormal pain processing [93;94]. To gain further knowledge of alteration of central mechanisms in diabetic patients, EEG recorded as EPs following electrical gut stimulation have been utilized previously [95-97].

3. Pain treatment

As pain is a common cause for patients seeking medical attendance, the World Health Organization (WHO) has provided a standard guideline for analgesic therapy, which follows the principles of the “pain relief ladder” (Figure 7) [98]. The principle of the ladder is to base pain treatment on the analgesic with lowest possible potency titrated to the lowest possible dose until sufficient pain relief is obtained.

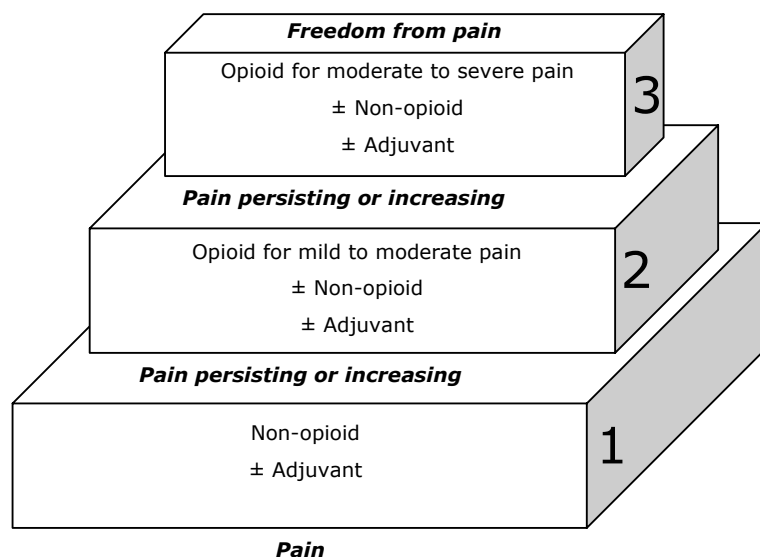

Figure 7. WHO’s pain relief ladder. The ladder is followed with serial introduction of analgesics until sufficient pain relief is obtained.

The first step of the ladder is treatment with adjuvant analgesics, which are medication developed for other purposes than pain relief, but have demonstrated analgesic efficacy in chronic pain patients [99]. The drugs include the following group of analgesics: benzodiazepines (anxiolytic effect), antidepressants (antidepressive effects), alpha-2-delta ligands (antiepileptic effects). The alpha-2-delta ligands include the analgesics gabapentin and pregabalin (IV).

The second step of the ladder is treatment with weak opioids such as codeine and tramadol. If these opioids do not lead to sufficient pain relief, treatment is continued to step 3, which includes strong opioids. One such strong opioid is morphine (I and II), which is the gold standard in clinical use.

3.1. Opioids

Opioids, such as morphine, exert their main effect in the CNS by bindings to one or more of the opioid-receptors (μ , δ , and κ) [100]. Morphine primarily activates the μ -receptors, and is therefore considered a μ -agonist [101]. The receptors are widely spread throughout the CNS at the periphery and supra-spinal level. The analgesic contribution from the brain is believed to be due to attenuation of the affective component of pain, which means that it is expected to influence the anterior cingulate cortex, insula and amygdale [102]. To verify this assumption, we did a study of brain

source localization prior to study I and II, and found an effect of morphine on the activity in the area of the anterior cingulate gyrus [29].

As morphine is known to exert its effect in the CNS and has been demonstrated to alter the EEG response, this compound was used to develop the classification system proposed in this thesis. In study I, we explored the alteration in frequency content between recordings at study start and recordings 90 minutes after morphine administration. The alterations were extracted from EPs following painful electrical oesophageal stimulation and investigated at a group level (aim 2). This analysis showed that the parietal region of the scalp had the highest degree of alteration between the conditions. Furthermore, when all electrodes were taken into consideration, two subjects were misclassified, and by further analysis these two subjects had none or only a minor effect of morphine compared to the remaining subjects. However, the frequency alterations for the subjects classified correctly were not correlated to the analgesic effect. As the identification of the non-responders was a promising result, we continued to apply the method on single-sweeps to obtain a scenario where the alteration was assessed on a single subject basis (aim 3). However, applying the methodology on the single-sweeps did not give satisfactory results (see section 7.2 for further explanation of limitations of the methods). Hence, a new methodology was developed which enabled single subject analysis of single-sweeps. This analysis (study II) showed a correlation between the degree of alteration in the EEG and the analgesic effect on a single subject level.

Furthermore, we have in a different study explored how well spectral indices in the resting EEG reflect the plasma concentration and analgesic effect in two other opioids – buprenorphine and fentanyl. Buprenorphine (partial μ -agonist and κ -antagonist with high affinity, and δ -antagonist with low affinity) is an analgesic 25-100 times more potent than morphine [103]. Fentanyl (mainly μ -agonist) is an analgesic 75-100 times as potent as morphine [101]. In this study we recorded the resting EEG from 19 healthy volunteers, took blood samples and assessed the analgesic effect at study start and 4, 24, 48, 72, and 144 hours after a transdermal patch was applied to the subject in a placebo-controlled setup. When an EEG index was introduced (summation of normalized marginal frequency distribution below 10 Hz divided by frequency distribution from 10 to 32 Hz), the index followed the plasma concentration and pain scores for buprenorphine, and the pain scores for fentanyl (figure 8) [unpublished data; manuscript under preparation].

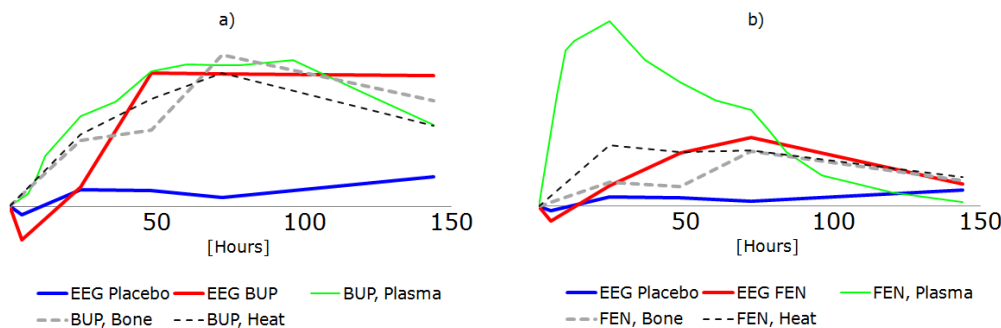

Figure 8. EEG spectral index (ratio between normalized frequency distribution below 10 Hz divided by distribution from 10 to 32 Hz) compared to plasma concentration and pain scores. All values are baseline corrected and the y-axis is scaled to have comparable levels.

3.2. Pregabalin

Pregabalin is an alpha-2-delta ligand, which is believed to exert its effect by modulation of the spinal cord neural activity by reducing the release of glutamate (and hereby also indirectly reduce the NMDA activity) [11]. Pregabalin is gaining focus in the treatment of underlying pain mechanisms such as central sensitization and neuropathic pain [104]. To verify the clinical efficacy of the analgesic in the study population in study IV, a clinical study was performed only based on subjective pain scores before and after three weeks of treatment with pregabalin in comparison to a control group treated with placebo in a double-blinded setup [17]. This analysis demonstrated significant clinical pain relief in the patients treated with pregabalin. Furthermore, before treatment we verified that the patients had altered resting state EEG compared to healthy volunteers, evident as increased delta, theta and alpha activity [25].

To study the effect of pregabalin in the CNS, a group analysis was performed to explore the spectral alterations before and after pregabalin in comparison to alterations in a placebo treated group (IV). This analysis showed an increase in the theta band comparable to alterations previously reported due to ketamine treatment [52;105]. The analysis was then expanded to include classification of each individual patient by applying the SVM in regression mode, which besides from the categorical output also outputs an estimate of the level of alteration for each patient. This regression value representing the overall alteration of the EEG was positively correlated to the analgesic effect of the compound (aim 4).

Additionally, we have in parallel to study IV analyzed the analgesic effect of pregabalin during experimental pain inflicted by electrical stimulation of the rectosigmoid colon [106]. This study showed an effect of pregabalin on the evoked pain by a reduction in pain threshold, although the EPs following the electrical stimulation remained unchanged and hence no shift in dipole localization was observed.

Brought together, the results suggest that pregabalin has an effect on chronic pain patients with alterations comparable to central sensitization, and the analgesic effect of the chronic pain can be monitor by alterations of the EEG, while the underlying mechanisms during acute pain may be a predominant spinal effect by reduction of the excitatory spinal neurotransmitters [107].

4. Electroencephalography

EEG is a technique used to record the electrical activity in the brain generated by firing between neurons. The main advantage of EEG is the high temporal resolution, which makes sampling rates up to 20 kHz and more possible. For the EPs, this enables analysis of which brain centers are activated sequentially and in parallel within the first 500 ms after the stimulus onset (pain specific response) and how they interact. In contrary, the spatial resolution of the EEG is in general poor in respect to precisely locating the activated brain sources. However, as the location of the brain sources may be less relevant than highly accurate frequency measurement in order to identify the underlying characteristics of chronic pain and pharmacological intervention, EEG was the method of choice for this thesis. Furthermore, the method is well established in pain and pharmacology research, and has several advantages in respect to developing a clinical feasible bed-site system [108-110].

4.1. EEG recordings in visceral pain studies

Recording of EPs in visceral pain studies may require extra attention. When painful electrical stimulations are inflicted in the oesophagus, the artifact is transmitted to the surface of the scalp by volume conduction, which results in a large stimulus artifact with the same shape as the applied stimulus. The applied stimulus is sought to be as short as possible to activate the nerve momentarily, which may be obtained by a short mono-polar square-wave. However, to compensate for the noise induced by the electrical power supply, a notch filter has to be applied to filter out the 50 Hz noise. This notch filter is a bandstop filter with very narrow cut-off frequencies of for example 49 to 51 Hz.

When the short square-wave is filtered by the default notch filter in the software (Neuroscan 4.3.1, Compumedics, El Paso, Texas, USA), it results in an EEG trace with large 50 Hz ringings (Figure 9a). This showed up to be caused by the analog filter in Neuroscan, which does not have a constant group delay for all frequencies [111-113]. To overcome this problem, several attempts were tested including hardware deblocking of the sample-and-hold device in the Neuroscan recording system, which however did not solve the problem to a sufficient degree. Consequently, the applied stimulus was switched to consist of 5 square-pulses of 1 ms duration with a frequency of 200 Hz, which was still perceived as one single stimulus. As this stimulus artifact does not mimic a dirac delta function, the notch filter does not induce ringings (Figure 9b). Due to this phenomenon, we used a 5 pulse stimulation paradigm when recording data for study **I** and **II**, and also in several other previous studies [23;74;114]. However, another workaround to avoid ringings is to apply a notch filter based on the zerophase shift technique. This filter has a constant group delay for all frequencies, which is advantageous not only to avoid ringings but also to reduce distortion due to filtering [112]. When this technique was up and running, we used it for study **III** (figure 9c), and also another study in parallel to study **IV** [106].

Based on the experiences from the various studies, the optimal recording setup with the Neuroscan equipment has now been determined to be: Recording in AC mode, no online notch filter

applied, the lowest possible highpass filter except DC (typical 0.1 Hz), the highest possible lowpass filter (at a sampling rate of 1 kHz: 200 Hz for SynAmps and 300 Hz for NuAmps). The optimal post-processing settings have been determined to be: Zero-phase shift notch filter from 49 to 51 Hz with 24 dB/octave, Zero-phase shift bandpass filter from 0.5 to 100 Hz with 12 dB/octave, epoching, linear detrending of the entire time interval, baseline correction of the pre-stimulus interval, cleaning (if applicable), and averaging.

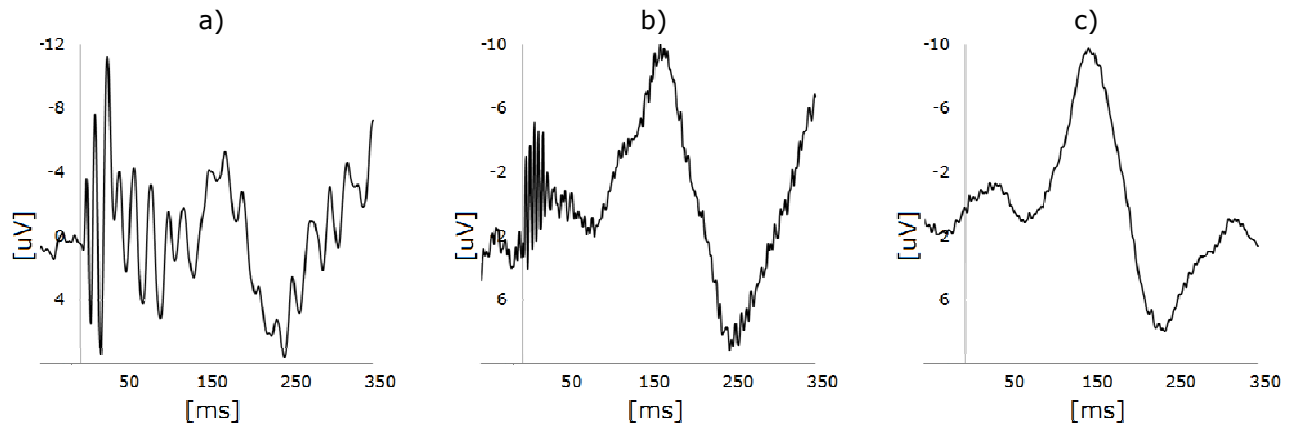

Figure 9. Optimization of recording techniques to obtain visceral evoked potentials. a) Evoked potential recorded by applying a 2ms square pulse followed by analog filtering to eliminate 50Hz noise from power supply. The stimulus artifact is large in amplitude due to volume conduction from the oesophagus, which causes major ringings and distortion. b) Evoked potential recorded by applying a stimulus consisting of 5 square pulses of 1 ms duration delivered at a frequency of 200 Hz. The analog filter does not induce ringings for this artifact. c) Evoked potential when applying a 2ms square pulse followed by filtering by a zero-phase shift notch filter, which has a constant group delay and hence does not induce ringings.

4.2. Pain assessment with EEG

The electrical activity in the brain can be recorded and analyzed by several approaches, such as resting EEG, average EPs and single-sweep EPs, each offering complimentary analysis of different aspects of pain and pharmacology intervention.

Resting EEG is recorded when the subject is relaxed in an environment without any external stimulus. This approach offers an analysis of the ongoing brain activity and the alteration during pain or after analgesic administration. We used this approach in study [IV](#), since this study was focused on a study population where we found altered resting EEG properties in comparison to healthy controls [25]. Furthermore, we demonstrated that although patients with chronic pancreatitis displayed cortical reorganization in response to acute pain, pregabalin did not change the brain sources activated during evoked pain [106;115]. In contrast, the analysis of the resting EEG in study [IV](#) showed increased normalized theta activity and decreased high frequency oscillations after three weeks of treatment with pregabalin, which taken together to one score representing the overall alteration of the EEG was correlated to the analgesic effect of pregabalin.

Opposite to the resting EEG is the approach of EPs. The EPs are recorded as a response to an external stimulus, and the traditional approach is to record EEG during several identical sweeps to obtain a sufficient signal-to-noise ratio when averaged. This procedure reveals less prominent peaks than visible in each sweep, and as a result the EPs can be assessed by visual inspection in respect to

amplitude and latency. The approach of analyzing averaged EPs is useful to explore common group alterations where the traces are compared between subjects (I and III), and to explore which brain centers are activated during an external stimulus [28;29;44].

Although the average EPs have high signal-to-noise ratio and enables comparisons between subjects, the methodology also has one major limitation. When the average EP is generated, all sweeps are summarized based on the assumption that the potential reflecting the response to the external stimulus is uncorrelated to the background EEG. However, several studies have demonstrated that the EPs occur as an event-related reorganization of the ongoing activity [116-118]. Besides, some studies have demonstrated that EPs are not to be assessed by amplitude and latency but may only be disentangled by phase resetting properties, or may only be described by phase resetting without any increase in power in the sweeps [119-121]. Furthermore, studies of pain evoked by laser stimuli have investigated oscillations that were time-locked to the stimuli but not phase-locked (and hence cancel out during the average procedure), and found that C-fiber components were not assessable in the average EPs unless the A-fiber activation was blocked [122]. Additionally, another study investigated the auditory EP during anesthesia in humans, and found that the phase jitter of the single-sweep EPs was decreased (improved phase alignment properties) after anesthesia and furthermore the power was decreased [123].

Hence, single-sweep analysis is of utmost importance in pain and pharmacology studies to identify individual alterations after analgesic administration (II) (aim 3). An example of the difference between average EPs and single-sweep EPs from study III is displayed in Figure 10. In Figure 10a, the average EPs pre- and post-treatment to sensitization with acid+capsaicin in the oesophagus are shown for the subject with the highest degree of induced hyperalgesia based on the subjective pain scores. A clear increase in amplitude is observed after sensitization in comparison to the pre-treatment condition. However, as shown in Figure 10b, the increase in signal intensity may partly be due to better alignment of the latency between sweeps after sensitization, which enhances the peak amplitudes during the average procedure.

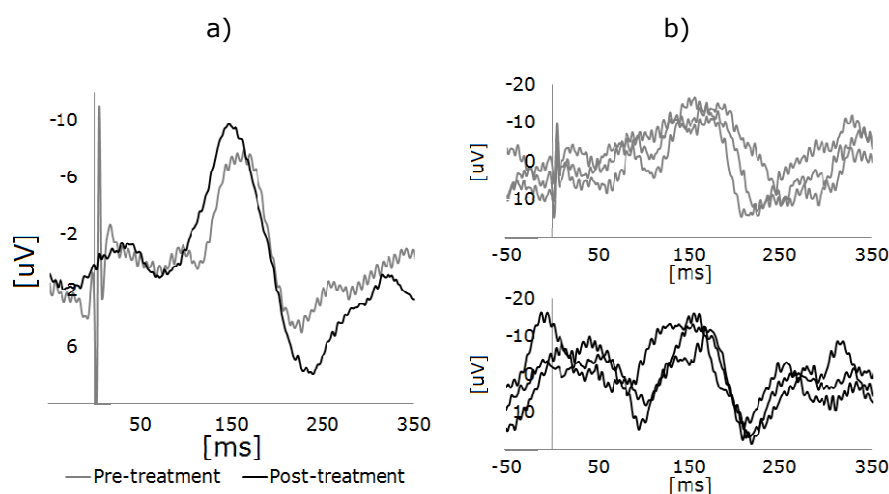

Figure 10. Brain evoked potentials presented as a) an average of 40 sweeps pre- and post-treatment to sensitization with acid+capsaicin for a representative subject in study III, and b) single sweeps contributing to the average for each of the conditions. For simplicity only the first 3 sweeps are displayed. Following sensitization (bottom, black) the latency of the polarity shift at approximately 175 ms is improved in comparison to the pre-treatment recording (top grey).

4.3. Frequency characteristics

The recorded EEG data may be analyzed in several ways. The resting EEG has traditionally been analyzed in terms of frequency characteristics, where basic parameters such as relative delta power, peak frequency, mean dominant frequency, median frequency and spectral edge frequencies have been used to describe the frequency content [40]. In contrary, the EPs have traditionally been analyzed with respect to amplitudes and latencies of the main peaks in the average traces [22;42]. However, this approach has several limitations, since it only includes the main peaks of the signals while important information may be present during the entire time interval of interest. To improve the analysis, the EEG traces may be decomposed into time-frequency parameters extracted from the entire epoch as we did in study I, II, and III, which has also been done in other previous studies [43;124;125].

The analysis of EEG traces in this thesis is based on frequency analysis described by the following standard bands: delta (0.5 – 4 Hz), theta (4 – 8 Hz), alpha (8 – 12 Hz), beta (12 – 32 Hz), and gamma (32 – 80 Hz). These bands have previously been used to describe characteristics in pain and pharmacology studies which are presented in table 2 and 3, respectively.

Table 2. Typical frequency characteristics reported in pain studies.

Frequency bands	Observation	References
Delta	Increased after tonic painful heat stimulus (resting) Increased in diabetic patients with high HbA1c level (resting)	[126] [127;128]
Theta	Increased in neurogenic pain patients (resting) Increased in patients with chronic pancreatitis (resting and EPs) Increased in diabetic patients with severe hypoglycaemia (resting) Increased during hypersensitivity in healthy controls (EPs)	[41;129] [25;43] [127;130] [131]
Alpha	Decreased by tonic painful cold stimulus (resting) Decreased in patients with irritable bowel syndrome (resting) Correlated to subjective pain perception (resting)	[132] [133] [134]
Beta	Increased in neurogenic pain patients (resting) Increased in thalamocortical dysrhythmia (resting)	[41] [129]
Gamma	Increased during attention to painful stimulus (EPs) Increased by increasing painful stimulus (EPs)	[135-137] [138]

Table 3. Typical frequency characteristics reported in pharmacology studies.

Frequency bands	Observation	References
Delta	Increased after opioid administration (resting and EPs)	[124;139]
Theta	Increased after ketamine (resting and EPs) Increased after adjuvants such as clozapine (resting)	[105;140;141] [142]
Alpha	Increased after opioids such as morphine (resting) Decreased after anxiolytics such as alpidem (resting) Decreased after benzodiazepines such as diazepam (resting)	[143] [144] [145;146]
Beta	Increased after anxiolytics such as alpidem (resting) Increased after benzodiazepines (resting) Increased after opioids such as morphine (resting)	[144] [146] [147;148]
Gamma	<i>Typically not assessed in pharmaco-EEG studies</i>	

5. Feature extraction

To extract the frequency characteristics from both resting EEG and EPs, a number of methods are available. Several previous BCI applications and studies on data from patients diagnosed with psychiatric disorders have shown that the feature extraction is of utmost importance in comparison to the selection of the classifier [50;149-151]. Hence, the selection of time-frequency algorithm was carefully considered for each study and further discussed in section 7.2.

5.1. Time-frequency algorithms

The most commonly used frequency analysis is the Fourier Transform (FT), which was used for the first time in 1932 to estimate the frequency content in EEG signals [152]. Due to its fast computational speed, the FT is still widely used in real-time implementations to monitor the debt of anesthesia, although the method has several limitations [40]. First, the algorithm assumes stationarity, which is not fulfilled as EEG data are non-stationary stochastic signals containing both oscillatory and transient characteristics [153;154]. Secondly, the algorithm requires relatively long epochs in order to provide satisfactory frequency resolution, which means it is not suitable for the short epochs used in study **I**, **II** and **III** [154]. To overcome the shortcomings of the FT, several time-frequency algorithms have been proposed in the literature, each having specific advantages and disadvantages, and with different approaches to adapt to the Heisenberg uncertainty principle. The most commonly used algorithms are presented in table 4.

Table 4. Overview of some commonly used time-frequency algorithms.

Algorithm	Description	Advantages	Disadvantages
Short-time Fourier transform (STFT) [155]	The STFT is a FT applied in consecutive time windows	<ul style="list-style-type: none"> Fast computational speed 	<ul style="list-style-type: none"> Fixed time-frequency resolution Not capable to detect frequency bursts
Wigner-Ville Distribution (WVD) [156]	The WVD is the simplest instance of Cohen's class, with the kernel set to 1	<ul style="list-style-type: none"> High temporal resolution Performs well for nonstationary multicomponent signals 	<ul style="list-style-type: none"> Largely influenced by cross-term interference Density estimate contain negative values
Wavelets [153;157-159]	The wavelet transform is a multi resolution analysis (MRA). The method can be split into: continuous wavelet transform (CWT), and discrete wavelet transform (DWT)	<ul style="list-style-type: none"> The MRA decomposition reflects EEG signal properties DWT: High computational speed 	<ul style="list-style-type: none"> Selection of mother wavelet function (MWF) based on a priori assumptions Same MWF used for all frequencies
Matching pursuit (MP) [160-162]	MP decomposes a signal into a sparse representation of atoms taken from a large and redundant dictionary	<ul style="list-style-type: none"> Optimal time-frequency resolution adapted to the signal 	<ul style="list-style-type: none"> Not all frequencies are necessarily represented, which makes comparisons to previous studies complicated

5.2. Wavelet transform

The wavelet transform is a multi resolution analysis (MRA), which has several advantages over methods such as the short-time Fourier transform (STFT) and Wigner-Ville distribution (WVD) [163-165]. The basic idea of the algorithm is to decompose the signal into time-frequency coefficients obtained by projection into subspaces by a mother wavelet function (MWF). The MWF can be selected from a dictionary of infinite number of waveforms, which are characterized by having zero mean value, finite energy over its time course, and relatively little low frequency content compared to the high frequency energy [153]. The MWF is scaled and translated to obtain the coefficients, and hence the *same MWF* is used to calculate the frequency content for all frequencies. The resulting MRA has the property of maximum frequency resolution at low frequencies, and maximum time resolution at high frequencies, which mimics properties of the EEG well (Figure 11) [165].

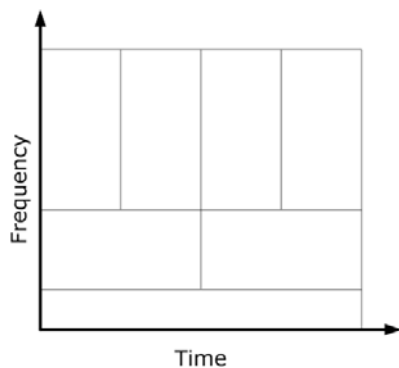

Figure 11. Schematic illustration of the basic idea of the multi resolution analysis (MRA). Due to the properties of the scaling and translation of the mother wavelet function (MWF), low frequencies are presented with high frequency resolution but low time resolution, while high frequencies are described by low frequency resolution and high temporal resolution.

The wavelet transform can in general be calculated as either a continuous wavelet transform (CWT) or a discrete wavelet transform (DWT) depending of the requirement for resolution and computational time available.

Continuous wavelet transform (CWT)

The idea behind the CWT is to scale and translate the MWF by infinitively small steps in order to calculate the time-frequency coefficients by convolution of the MWF and EEG signal. For each of the scaled MWF this gives an estimate of the center frequency at each time point (Figure 12). As seen from Figure 12a, when the wavelet is dilated it has long time duration, but also a narrow frequency distribution in contradiction to the small scale wavelet in Figure 12c, where the wavelet has a short time duration but a much wider frequency distribution.

Figure 12. The basic principle of the continuous wavelet transform is to scale and translate a wavelet function to obtain a multi resolution analysis. The large scale wavelet has a wide time distribution, but is narrow in its frequency representation. In contrary, the small scale wavelet is narrow in time distribution but has high frequency distribution. However, as the slow wave oscillations in the EEG are more stationary than high frequency burst, this resolution mimics EEG data well.

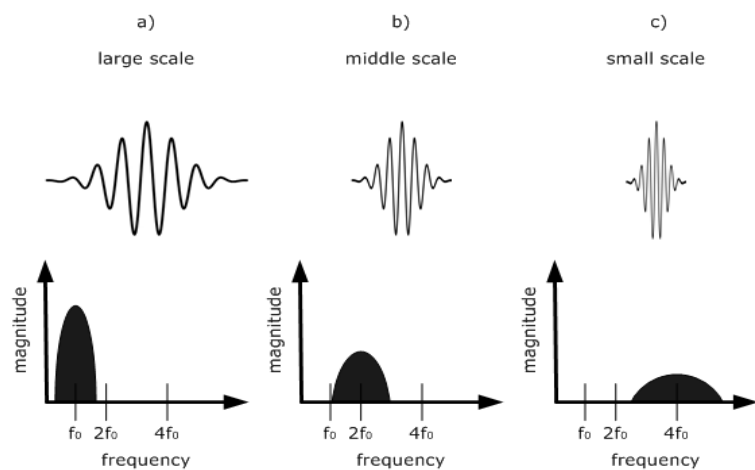

The CWT was used to extract the frequency distribution in study IV, and the MWF was chosen to be a complex Morlet wavelet since this wavelet has an optimal time-frequency distribution, and has been used in several previous studies by other research groups [125;161;166;167].

Furthermore, we have previously used the CWT with the complex Morlet wavelet function to describe the abnormalities in spectral indices in the patient group analyzed in study IV [25]. In this preceding study, we demonstrated that the method was useful to obtain a biomarker for the abnormal pain processing in comparison to age and gender matched healthy volunteers. Additionally, we have used the same methodology in a study of hepatic encephalopathy patients. These patients were also compared to healthy controls, and the method detected a slowing of the EEG rhythmicity and increased variability in the alpha and beta bands (dynamic shifts in spectral indices) in the patients, which was correlated to clinical scores [168]. Furthermore, the method has been used to study the slowing of brain oscillations as a correlate to plasma concentration and analgesic effect of the two opioids buprenorphine and fentanyl (Figure 8), which is now being analyzed in respect to PK-PD modeling [unpublished data; manuscript under preparation].

Discrete wavelet transform (DWT)

Contrary to the continuous convolution process for the CWT, the DWT is calculated as a convolution of the scaled wavelet in discrete steps to cover the entire time-interval without overlap [153;169]. By this procedure, a non-redundant highly efficient representation of the signal is calculated, consisting of as many coefficients as present in the input signal and with a bandwidth set to half of the sampling rate. As a convolution in the time domain corresponds to multiplication in the frequency domain, the algorithm may be considered as a filtering task (Figure 13). The filters are represented by the MWF, and the calculation of the coefficients is based on orthogonal wavelets to ensure that the scaled and translated wavelets are not correlated [153;158;169].

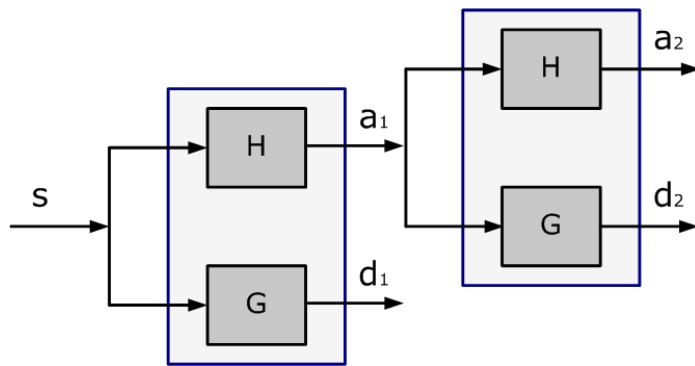

Figure 13. The basic principle of the discrete wavelet transform is to scale and translate a wavelet function to obtain a multi resolution analysis. The input signal s is filtered by a lowpass filter H to obtain the approximation coefficients and a highpass filter G to obtain the detail coefficients. The approximation coefficients are used as input to the consecutive filtering, and the algorithm continues until only one coefficient represents the final approximation. This coefficient and all the detailed coefficients represent the wavelet decomposition.

The DWT was used to extract the time-frequency coefficients in study I and III, and since the selection of the filters is crucial to obtain high classification accuracy, 30 different wavelets were tested in each of the studies. The optimal MWF was determined as the solution leading to the highest classification accuracy. This approach corresponds to pattern recognition widely used in BCI applications [50;149].

5.3. Matching pursuit

Matching pursuit is an iterative process to decompose a signal into a set of basic components (termed atoms) taken from a large and redundant dictionary [156;160]. The algorithm starts by searching the dictionary to find the atom with the highest similarity to the input. When the optimal atom has been determined, it is subtracted from the signal segment to obtain the first order residuum. In the consecutive iteration, this residuum is used as input signal, and the best matching atom is found. The algorithm continuous until a maximum number of iterations have been performed or a residuum less than a certain value of the original input energy is obtained (Figure 14) [154;156;160;162].

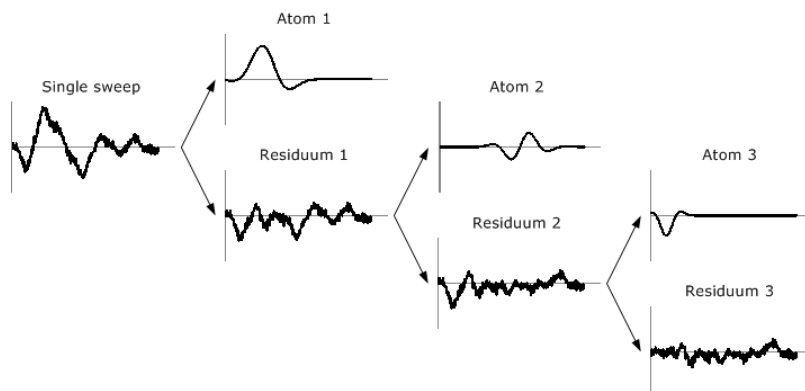

Figure 14. Decomposition by matching pursuit of a single sweep recorded in study I and II. The first iteration uses the single sweep as input to determine the best matching atom. The atom is subtracted from the sweep to obtain the first order residuum. This residuum is used as input in the next iteration. The algorithm stops when the residuum is less than a certain portion of the sweep to be decomposed.

By this procedure, the signal is described by sparse atoms which are not restricted to any resolution properties in the time-frequency plane, except they have to conform to the Heisenberg uncertainty principle. Hence, low frequency oscillations can be described in short time windows (as for example

atom 1 in Figure 14), while consistent high frequency oscillations can be described with high frequency resolution by only one coefficient even if they occur during the entire epoch. To have the most optimal time-frequency resolution, the dictionary we used was build on Gabor atoms, which are sinusoids modulated by Gaussians [154].

In order to be able to classify features extracted from the MP algorithm, the features from the conditions to be discriminated needs to be extracted from the same atoms. To accomplish such a setup, an enhanced implementation of the MP can be used, which includes multivariate matching pursuit (MMP) and temporal matching pursuit (TMP) [156;170].

Multivariate matching pursuit (MMP)

MMP is the most straightforward extension of the MP algorithm in respect to decomposing multiple traces simultaneously. The extracted atom in each iteration is found as the component with the highest simultaneously similarity to all input EEG traces, with the constraint to have *constant phase* across traces. This means, that the extracted atom is the one who is characterized by having its signal shape occurring with constant latency in several traces. Hence, the atom for all traces will have the same temporal occurrence but with different amplitudes (Figure 15) [170].

This approach has been used by Sieluzyciek *et al.* to describe a habituation phenomenon in single-sweep auditory evoked potentials, where only a few atoms were necessary to mimic the sweeps based on visual judgment [171]. Sieluzyciek concluded in his study, that MMP could be a future methodology to describe single-sweep EPs, as it only extracts the common waveforms which are believed to reflect the evoked response, while the background EEG activity and noise are more randomly distributed. He also concluded that although classification of single-sweeps is an interesting topic, ideas on how to classify data across conditions were still to emerge. In study **II** we proposed such a methodology, by suggesting the MMP should be applied to all sweeps across conditions. By applying MMP across conditions, we were able to discriminate single-sweeps before and after morphine administration with an accuracy correlated to the individual analgesic effect for each subject (aim 3). As this is a new approach to apply pattern recognition on single-sweep EPs, we initially published a pilot study on the methodology applied to one of the volunteers from study **III** [131].

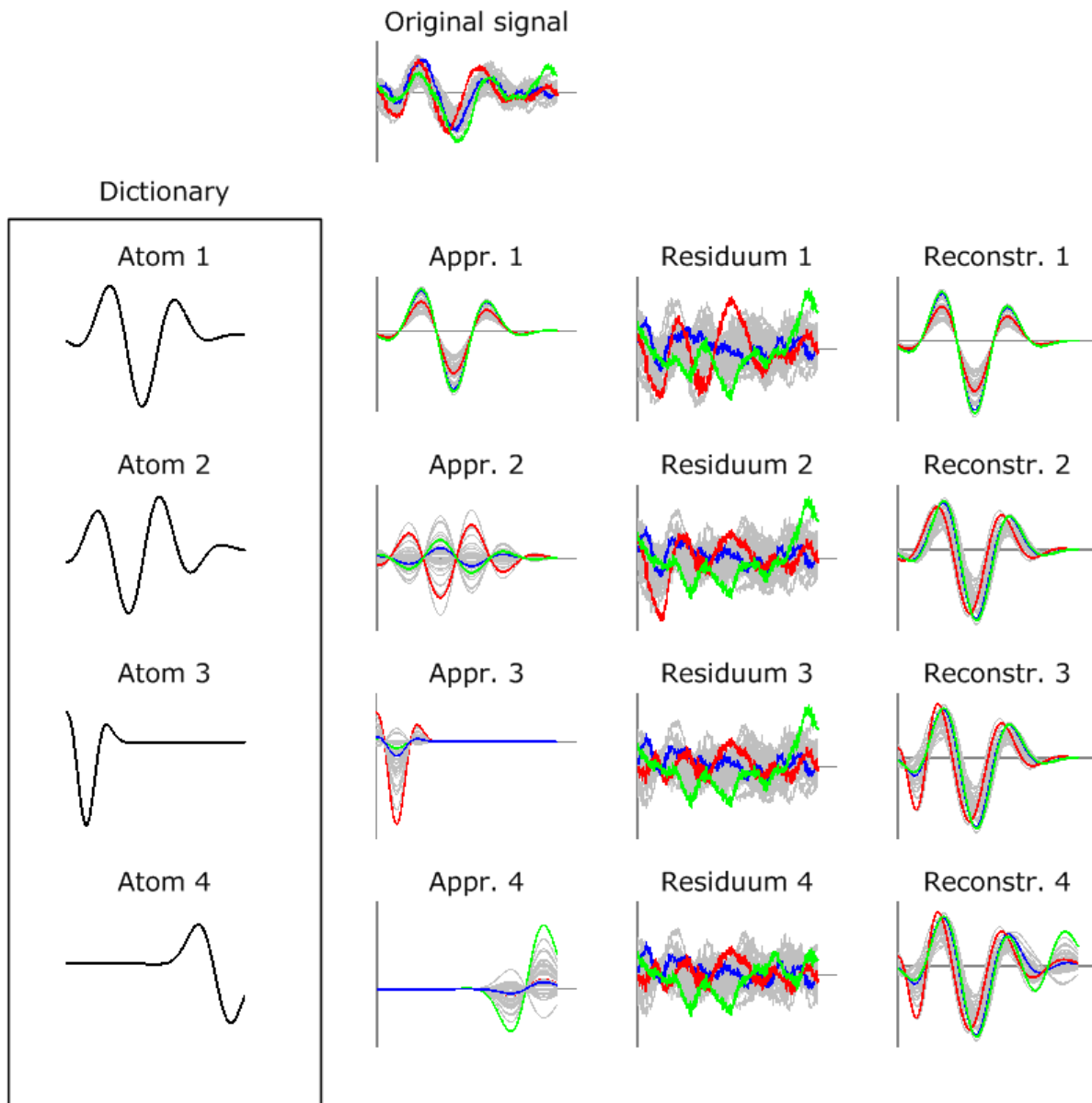

Figure 15. Schematic overview of the MMP algorithm illustrated by single-sweeps from a representative subject in study II. For illustration purposes, three random sweeps are highlighted. In each iteration the optimal atom is found in the dictionary, and the amplitude for each sweep is calculated to form the approximation and the residuum. The residuum is used as input to the consecutive iteration. For demonstrational purposes, the reconstruction of the original signal is also included. This reconstruction is calculated as the sum of all previous approximations.

Temporal matching pursuit (TMP)

The TMP algorithm is similar to the MMP algorithm with the only exception that the extracted atom in each iteration is determined independent of phase alignment over the input traces. Hence, the estimated atom is the one who has its signal content present over several traces at random time instances. Consequently, each trace is described by its *amplitude and phase* (Figure 16).

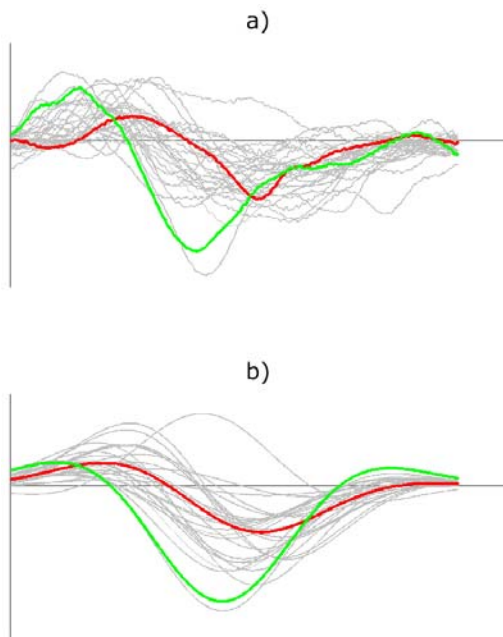

Figure 16. First iteration in a TMP decomposition of the average vertex traces recorded in patients with diabetic mellitus and age and gender matched healthy volunteers. For illustrational purposes, one of the patients is highlighted in red, and one of the healthy volunteers is highlighted in green. a) The average traces from 14 patients and 15 healthy volunteers. b) The first atom extracted when all traces are used as simultaneous input. The same atom is extracted for all subjects, but with varying amplitude and phase.

The TMP algorithm may be applied to classify single-sweeps where a phase shift is expected between conditions, which can occur during visceral hypersensitivity or after pharmaceutical intervention [23;172]. Furthermore, the algorithm may be applied to classify subjects at a group level as shown in Figure 16 (see also ongoing studies on the group analysis of patients with diabetes mellitus). By the TMP procedure, the same atoms are extracted for all subjects which enables a direct comparison of the amplitude and phase differences. The suggestion to include traces from several subjects in the same iteration is to our knowledge a new approach, and may provide a useful tool to classify subjects on a group level where a latency shift needs to be included in the analysis. This approach also provides a solution to an issue raised by Sieluzycski *et al.*, who stated that an imminent step to be pursued in respect to MP features is the application to a population of subjects, as this step would address the complex question on how to draw statistical conclusions from MP results with different Gabor functions derived for different subjects [171].

6. Classification

The second part of the pattern recognition procedure is to classify the EEG features. Classification can basically be split into two major groups: supervised and un-supervised classification. As the purposes of our studies were to see how well 2 pre-defined groups could be separated with an estimate of how well each subject belonged to the group, we focused on *supervised learning*. In supervised learning, input features for the classes are given to the classifier with a label indicating the class they belong to. Based on this information the classifier calculates a decision rule specifying how any new unknown sample should be assigned to the estimated class. Hence, an important task in classification is to calculate a decision rule to obtain *good generalization*, which means that unlabeled inputs with high probability are assigned to the correct class.

6.1. Classification algorithms

Several supervised classification algorithms exist, with some of the most commonly ones presented in table 5.

Table 5. Overview of some commonly used classification algorithms [173].

Algorithm	Description	Advantages	Disadvantages
Linear discriminant analysis (LDA) [174;175]	LDA calculates a hyperplane to separate data by maximizing the distance between the two classes means and minimizing the interclass variance	<ul style="list-style-type: none"> • Low computational requirement • Simple to use and gives in general good results 	<ul style="list-style-type: none"> • Linearity, which may provide poor results on complex nonlinear data • Based on the assumption that data is normal distributed
Neural networks (NN) [176;177]	NN assembles several artificial neurons to produce a nonlinear decision boundary	<ul style="list-style-type: none"> • Flexible and can adapt to a variety of conditions 	<ul style="list-style-type: none"> • Sensitive to overtraining
Bayesian classifiers (BC) [174;175;178;179]	BC learns the class models, and classify samples by computing the likelihood of each class and assign the sample to the one with highest probability	<ul style="list-style-type: none"> • Slow computational speed 	<ul style="list-style-type: none"> • Good dynamic classifiers in the time-domain
Nearest Neighbor classifiers (NNC) [174;180;181]	NNC assigns a feature vector to a class according to the nearest neighbor(s) by either a number of nearest neighbors or a class prototype of a distance	<ul style="list-style-type: none"> • Relatively simple • High computational speed 	<ul style="list-style-type: none"> • Very sensitive to dimensionality of the features
Support vector machine (SVM) [182-185]	SVM calculates a hyperplane to separate data by maximizing the margins. In case of non-separable data a kernel function may be applied.	<ul style="list-style-type: none"> • Good generalization capabilities due to regularization properties • May be utilized by a kernel function • May be applied in regression mode 	<ul style="list-style-type: none"> • High computational requirement and low speed of execution

As the ultimate requirement in our studies was high classification accuracy with the possibility to get an estimate of how well each individual subject belonged to the group (regression), the SVM was chosen as the preferable classification algorithm. This was further supported by the fact that the SVM has shown superior performance in several previous studies aiming at comparing classification methods [186;187].

6.2. Support vector machine

The SVM is based on ideas from *statistical learning*, and was first introduced by Vapnik and Lerner in 1963 [188]. The basic idea is to calculate a hyperplane to discriminate features from the classes in the most optimal way (Figure 17). As seen from Figure 17a, the hyperplane is linear and there are several solutions to discriminate the data. However, there is only one optimal solution, which has the maximum distance to all data points indicated by the bold green line in Figure 17a. This optimal solution is further illustrated in Figure 17b, where the data points contributing to defining the separating hyperplane are highlighted. These data points are termed the support vectors [182].

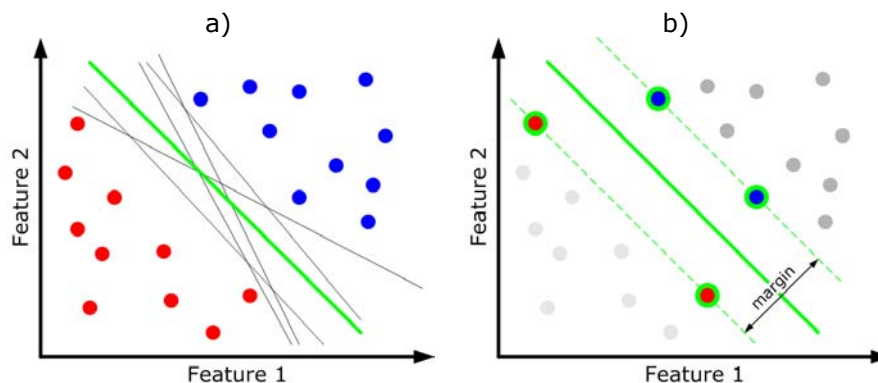

Figure 17. The basic idea of the support vector machine is to define an optimal linear separating hyperplane. a) Example with 2 classes (red and blue) each defined by 2 features. There are several possibilities to discriminate the data, although one solution has the maximum distance to data points from both classes (green). b) The optimal hyperplane and the corresponding support vectors indicated by green highlights.

In Figure 17a it is assumed that data can be perfectly separated by a linear hyperplane. However, this is not the case in most practical schemes. To overcome the issue of non-separable data, Cortes *et al.* proposed an implementation of the SVM with soft-margins [189]. In the soft-margin version a positive slack variable ξ is defined, which is a measure of the misclassification error. The summation of the misclassified trials may be considered as a penalty function which sets an upper bound for the number of errors [183]. Furthermore, a variable C is introduced to control the tradeoff between the margin and the misclassification error. This parameter is directly related to regularization of the SVM, which serves to control the complexity of the classifier to prevent overtraining [173;183]. Furthermore, regularized classifiers in general have good generalization performance and are robust to outliers [174;184]. The optimization of ξ and C is a non-trivial task, and were in all four studies optimized by 3-fold cross-validation during training of the classifier to minimize the probability of error estimated from the training set.

Kernel methods

Although the soft-bound implementation does overcome the challenge with a few outliers, it does not take into consideration that the data points might not be outliers but rather may contribute to describe a non-linear separable pattern as illustrated in Figure 18. To improve the performance in case of a non-linear distribution of the data, the accuracy can in most cases be improved by introducing a kernel function [190;191]. The kernel function maps the input data to a higher dimensional feature space which can be obtained by polynomial and Gaussian kernels etc. After mapping the data into a higher dimensional space, it may become linear separable as illustrated by a simple example with a polynomial kernel in Figure 19. In general, the kernel function which has demonstrated the best performance in many applications is the Gaussian Radial Basis Function (RBF), which are Gaussian shapes centered around each support vector [182;183;192;193]. We used this Gaussian RBF kernel function in study I and II to obtain satisfactory results. However, it should be noted that utilizing a kernel in pain and pharmacology research requires extra attention, since the scope of the studies is not to find differences, but to find physiological meaningful differences serving as a biomarker for disease or analgesic effect. Furthermore, it is recommended to start with the linear kernel, since it makes interpretation of results and extraction of biomarkers easier.

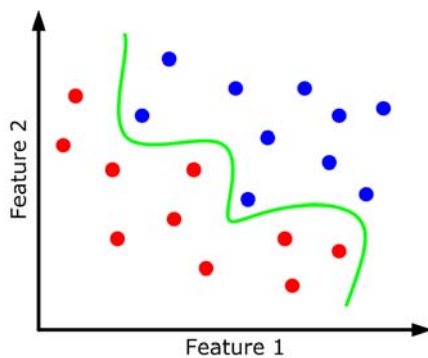

Figure 18. Data is in most applications not linear separable, but may be separated by a complex decision rule indicated by the green curve.

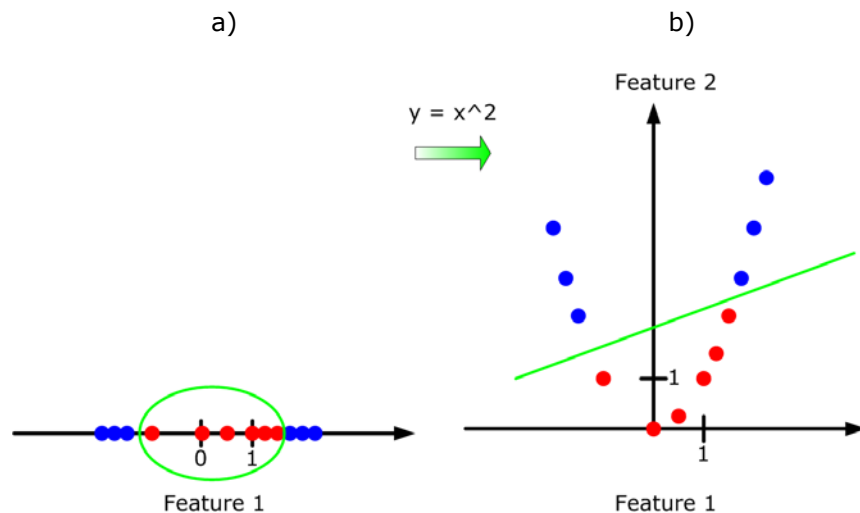

Figure 19. Example of how the kernel function (in this case a simple polynomial function) can transform a) linear non-separable data with a complex discrimination pattern into b) a linear separable scenario.

6.3. Support vector machine regression

In most pattern recognition applications, the overall purpose is to assess how well two groups can be discriminated [149;150]. This approach may be used to evaluate which subjects have different responses than common responses seen in the majority of subjects in a group analysis. We used this information in study I, where we found two subjects being misclassified after morphine administration, which were also the subjects demonstrating the lowest response to morphine treatment. These two subjects had an increase of +5% and -7% in current intensity to evoke slight pain, which we considered as being non-responders to treatment.

However, considering subjects as either responders or non-responders is a crude approximation when discussing the efficacy to treatment or pain mechanisms. A more correct approach may be to consider efficacy or sensitization as a score on a continuous scale. This however raises the question how to assess the EEG alterations on a continuous scale rather than as a categorical output as illustrated in Figure 17a (red or blue). In study I we tried to correlate the alteration in the delta frequency band to the analgesic effect, which however did not reveal a statistical significant pattern.

A completely different approach would be to apply the SVM in regression mode, where the output is a scalar on a continuous scale (Figure 20) [183;185].

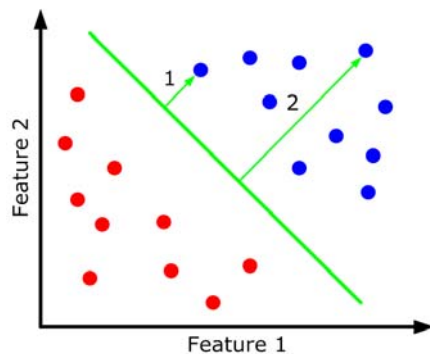

Figure 20. Applying SVM in regression mode enables an output on a continuous scale describing the distance to the separating hyperplane indicated by arrow 1 and 2. The rationale for using the regression value is based on the assumption that although the data points corresponding to 1 and 2 are assigned to the same class, they display different levels of alterations in the EEG response.

Applying SVM in regression mode to EEG data has to our knowledge only been used in a few previous studies primarily for BCI applications [194]. However, based on the results we have obtained in study III and IV, the approach may seem to be a way forward to assess the overall alterations of the CNS. This is based on the fact that we obtained correlations to pain mechanisms (III) and analgesic effect (IV) in our studies when using the regression value as a biomarker of the overall alteration of the EEG. Furthermore, in study III we saw a significant difference in spread of the regression value after sensitization (mean±SD 4.05±3.11) in comparison to after placebo treatment (mean±SD 1.48±1.30) ($P=0.02$, Student's t-Test). One could of course speculate if more basic measures could have given the same result, as for example an integral of the frequency bands which were statistical significant increased after sensitization. To investigate this further, we correlated the individual integral values of the delta, theta and alpha bands after sensitization with the subjective pain scores (Figure 21), which however did not give significant results ($R=-0.165$, $P=0.61$).

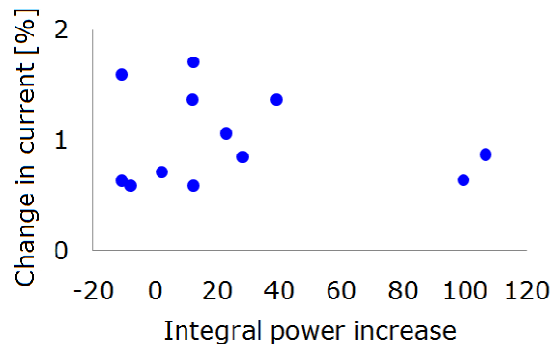

Figure 21. Correlation of the integral power increase after sensitization in individual subjects in study III and the subjective change in pain score reflecting the degree of induced hyperalgesia. No correlation is seen for the two variables.

Furthermore, in study IV we also investigated if more simple scores could be used to monitor the analgesic effect. However, although we tested all bands individually followed by a test of an EEG index of normalized theta/beta contribution we did not obtain significant results (all $P > 0.3$). Hence, applying SVM in regression mode is more sensitive to describe the overall alteration of the brain activity, which should be considered as an interaction between several frequency bands.

7. System development

To develop a system to identify biomarkers for the underlying pain and analgesic mechanisms in healthy volunteers and chronic pain patients, several methodological aspects had to be considered and tested in order to find the optimal approach for each study.

7.1. Single-channel versus multi-channel recording

The first aspect to be considered during project planning is the number of channels in the EEG setup. As the electrical activity in the brain may be generated at multiple sites simultaneously, the registration of the brain activity can be improved by recording from multiple electrodes on the scalp. In such a multi-channel setup, the positions of the electrodes are typically mounted according to the extended 10-20 system [195].

In study **I**, **II**, and **IV** we recorded EEG signals from 62 surface electrodes, and used a pattern recognition method to determine the electrode with the highest discriminative capacity between conditions. In study **I** we found the P4 electrode to be the most discriminative electrode, and when the 10 most discriminative features from the 6 best performing channels were included, a multi-channel accuracy of 92.4% was obtained. Furthermore, in the multi-channel classification we found that two subjects were misclassified in the group analysis. These two subjects were both categorized as non-responders to morphine and had an increase in the delta band in contradiction to the remaining subjects, which all displayed decreased power in the delta band. However, the decrease in the delta band for the responders was not correlated to the analgesic effect, and to investigate the individual analgesic effect in further detail, we did a single-sweep analysis in study **II**. Hence, in this study we used the same data, and found a positive correlation between classification accuracy and analgesic effect when taking all channels into consideration in the analysis by appending features from the channels. In study **IV** we found the P1 electrode to be the most discriminative channel to discriminate the alterations after pregabalin treatment from the alterations after placebo. For this channel we found that the overall alteration of the EEG was correlated to the analgesic effect in chronic pain patients.

In contrast, we only recorded EEG traces from the vertex (Cz) electrode in study **III**. This design was chosen for several reasons: 1) we did not consider a multi-channel setup as an attractive solution to develop an application to improve enriched enrollment in clinical trial units, which was one of the proposed applications for the methodology; 2) a single-channel setup is preferable to develop a bed-site application to identify underlying mechanisms of abnormal pain processing due to central sensitization; 3) the EEG recordings were only a part of a very comprehensive setup investigating many aspects of pain processing, and requiring the subject to have a multi-channel cap mounted for several hours during the other tests was not considered an option; and 4) although a multi-channel setup would have enabled additional analysis of topographical distribution of frequency alterations including source localization, we have no reason to believe that such a design would have influenced the findings obtained in the study. This is supported by a previous publication on central sensitization where EEG traces were recorded by 62 surface electrodes [23]. In this

study, the alterations of the main peaks and brain sources before and after sensitization of the oesophagus with acid were explored. The analysis displayed that the main alterations were obtained at central electrodes, and only significant changes in the location of the dipole sources were found in the anterior cingulate cortex, which mainly affects the vertex electrode.

To further test the latter argument and provide deeper insight into the issue, we analyzed EEG traces from an ongoing study on central sensitization in healthy volunteers. This study is based on a 62 channel setup to enable source localization, and consists of pre-treatment recordings followed by recordings 60 minutes after acid perfusion of the oesophagus. At the time being we have completed the study in 5 healthy volunteers, and extracted the power distribution in the frequency bands with the same wavelet method as in study III (Figure 22). As seen from figure 22, the power frequency distribution appears to be consistent over the scalp, and hence including more channels in the analysis is not expected to increase the performance of the pattern recognition method (although small improvements may occur).

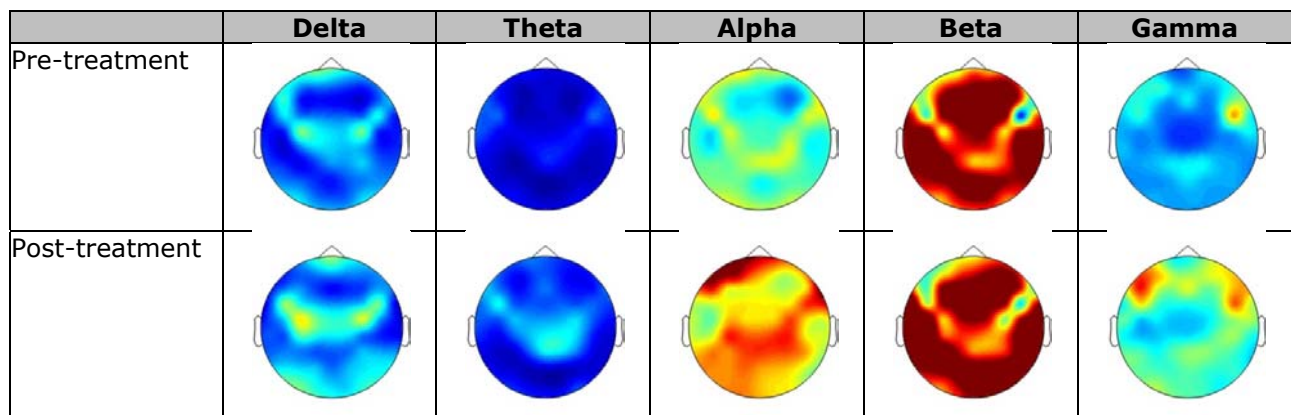

Figure 22. Topographical frequency distribution before and after sensitization of the oesophagus with acid in 5 healthy volunteers in an ongoing study. The frequency characteristics are extracted by the same wavelet function as in study III. Results are normalized and scaled equally at pre- and post-treatment: delta(0 - 50%), theta(0 - 30%), alpha(0 - 30%), beta (0 - 15%), and gamma (0 - 10%)

Taken together, we have in three studies recorded data from 62 channels and used this to discriminate the analgesic response on a group level and on a single subject level, and seen that the alteration of the EEG reflects the efficacy of the compounds in both healthy volunteers and chronic pain patients. However, it could be argued that handling of the multi-channel information could be improved by a more novel approach, as we in study II appended all features without taking into consideration that this would introduce many redundant features to the classifier, and in study IV we only used the best performing channel. Hence, improvement of the multi-channel information may in the future further improve the methodology. In contrary, we have in one study recorded EEG traces from only one electrode and used it to discriminate the pain processing on a group level and found that the overall alteration of the vertex electrode reflected the level of induced hyperalgesia.

7.2. Selection of feature extraction method

Extraction of time-frequency features to be classified in pain and pharmacology studies is a non-trivial challenge. Hence, for each study the method had to be based on an algorithm capable of extracting the desired features, which would at the same time lead to physiological meaningful results. Hence, the feature extraction had to be evaluated with respect to obtained results after classification.

As we originally expected to be able to base the pattern recognition on already developed methodologies for BCI applications, we used such an established method in study **I**. In this study, a DWT with 30 combinations of the MWF was used to calculate the frequency distribution before and after morphine administration. By this procedure we obtained satisfactory classification results for the DWT extracted features, as we were able to identify the non-responders to morphine treatment. However, the methodology was not sensitive enough to correlate the EEG parameters to the analgesic effect in each individual, which lead us to study **II**.

In study **II**, we assessed the individual alteration of EEG characteristics after morphine and placebo treatment compared to the respective pre-treatment recordings. This analysis was based on classification of single-sweeps, since we hypothesized that the modulation of the CNS could be changes in single-sweep amplitudes and non-phase locked oscillations of the evoked response [123]. However, when we applied the methodology from study **I** on the single-sweeps for each individual, several shortcomings of the approach was observed. When we classified the pre- and post-treatment responses for both morphine and placebo we obtained high accuracy for all individuals with no correlation to the analgesic effect. Consequently, to validate the approach we classified the two pre-treatment responses and the two post-treatment responses. These latter two classifications also gave high classification accuracies. Hence, the optimized DWT with 30 combinations of the MWF appeared to be too sensitive when the optimization was limited to choose the solution with the highest accuracy without any constrains on how the feature extraction should be guided to only extract pain specific responses (Figure 23, left panel). To improve the feature extraction to only extract the pain specific responses, we applied the MMP algorithm to all sweeps for all four conditions for each subject, and used the atom amplitudes as input to the classifier. By this procedure we obtained high classification accuracy when discriminating individual pre- and post-treatment responses to morphine and placebo and for the classification of the post-treatment responses, while the classification accuracy of the two pre-treatment responses was low as expected (Figure 23, right panel).

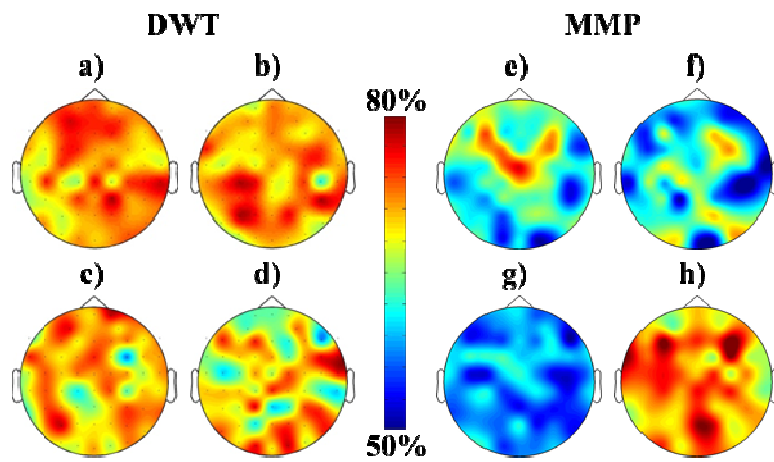

Figure 23. Classification accuracy is highly influenced by the selection of feature extraction method. When classifying single-sweeps in study II, the DWT gave high accuracy for all scenarios, while the MMP algorithm only gave high accuracy for the expected scenarios. The tested classification scenarios were: a and e) pre-treatment versus morphine; b and f) pre-treatment versus placebo; c and g) pre-treatment morphine versus pre-treatment placebo; and d and h) post-treatment morphine versus post-treatment placebo.

Based on these results, feature extraction based on MMP (or TMP in case of expected latency shifts) for single-sweep EPs in pain and pharmacology studies might be superior to the DWT. However, it should be noted that the results shown in Figure 23 are based on a normalized power distribution. By normalizing the distribution, the same signal power is expected before and after treatment, which is not a correct assumption [123;124]. Consequently, as the pain specific information is expected to decrease after morphine administration, the same noise level pre- and post-treatment will have different contribution to the normalized distribution, which may explain the results in the left panel of Figure 23. Furthermore, by normalizing the distribution, the difference in signal and noise level between days contributes to the classification accuracy. Based on these observations, an important future recommendation is to scale the EPs as we did in study II and III, since this adjusts for differences in signal intensity between days without altering the ratio in power for the pre- and post-treatment responses. However, although the scaling might have reduced some of the challenges with the DWT, it is worth to notice that feature extraction based on MMP does take the morphology of the sweeps into consideration, which is discarded by calculating the power of the DWT coefficients.

As single-sweep classification based on a combination of MMP and SVM is a new approach, we first validated and published a pilot study on the EEG traces from the subject displayed in figure 10. In this study we obtained an accuracy of 95% when discriminating the single-sweeps at pre-treatment from the single-sweeps at post-treatment [131]. When this methodology was used in study II to discriminate the single-sweeps before and after morphine administration, it gave a mean classification accuracy of 85.1%, and more interesting the accuracy was positively correlated to the individual analgesic effect of morphine based on subjective scores.

In study III, we investigated EEG alterations after sensitization with acid+capsaicin in the oesophagus and compared the response to placebo treatment. As the purpose of this study was to perform a group analysis and furthermore identify a biomarker for hypersensitivity, we used the optimized DWT for this study. This choice was primarily based on the fact that when using a DWT, the frequency content in all bands is estimated in contradiction to the MMP algorithm, where atoms in one or more bands might not be present until the residuum has been reached. Furthermore we

used the scaling procedure to calculate the frequency alterations before and after sensitization in comparison to placebo, as previous results have demonstrated increased amplitudes after sensitization [22;42]. This scaling was necessary to adjust for inter-subject variability and differences in signal level between days for the same subject.

In study **IV** we classified resting EEG, and used the CWT approach with the complex Morlet wavelet, as this methodology is well established and has given satisfactory results in previous studies, where it has demonstrated the ability to provide quantifiable information on static and dynamic parameters [25;168]. Hence, we believe the CWT method is the most optimal way to extract features from resting EEG. However, in future studies it could be considered to record the resting EEG for longer time periods, which would enable extraction of the first artifact free minute for analysis to avoid the cleaning procedure we applied.

7.3. Selection of input features to the support vector machine

The second part of the pattern recognition is classification, and in order to obtain physiological meaningful results, the SVM was optimized in regard to the parameters used to calculate the separating hyperplane and an appropriate kernel function was chosen. However, an even more important issue was to select meaningful input data. In study **I** we used the normalized marginal distribution for all subjects at pre-treatment as one class and the post-treatment responses to morphine as the second class. However, we also created three subfiles per subject for each class, which meant that during the training session we used some files from the subject under test, which is not an optimal solution. Consequently, based on the experiences we have gained from study **III** and **IV**, the methodology from study **I** is not recommended for further studies.

In study **II** we used the scaled amplitudes of the atoms on a single subject basis, which enabled an analysis of the four scenarios a) pre- versus post-treatment to morphine; b) pre- versus post-treatment to placebo; c) pre-treatment responses from morphine versus placebo; and d) post-treatment responses from morphine versus placebo. These four scenarios were tested by a leave-one-out strategy and only traces from the same subject were discriminated. We consider this scaling procedure followed by all four classification scenarios the optimal solution of the single-sweep analysis.

In study **III** and **IV** we used the individual alterations of the EEG response pre- and post-treatment to sensitization and pregabalin compared to alterations due to placebo as input to the classifier. This choice was based on the fact that the inter-individual differences were larger than the alteration of the EEG response after modulation of the CNS. Consequently it was not possible to discriminate the pre-treatment responses from the post-treatment responses to sensitization or pregabalin as we originally planned. An example of this important finding is illustrated in Figure 24 for the data used in study **IV**, with the limitation that data is presented as theta and summation of beta contribution although the featurespace consisted of seven frequency bands. As can be seen from Figure 24a, although most subjects display common alterations, it is not obvious to calculate a decision rule to discriminate the pre- and post-treatment responses. However, in Figure 24b the

alterations for the pregabalin treated group is shown as one class and the placebo treated group is shown as the other class. Although we use the limitation of two frequency bands, a much more clear discrimination of the two groups is observed.

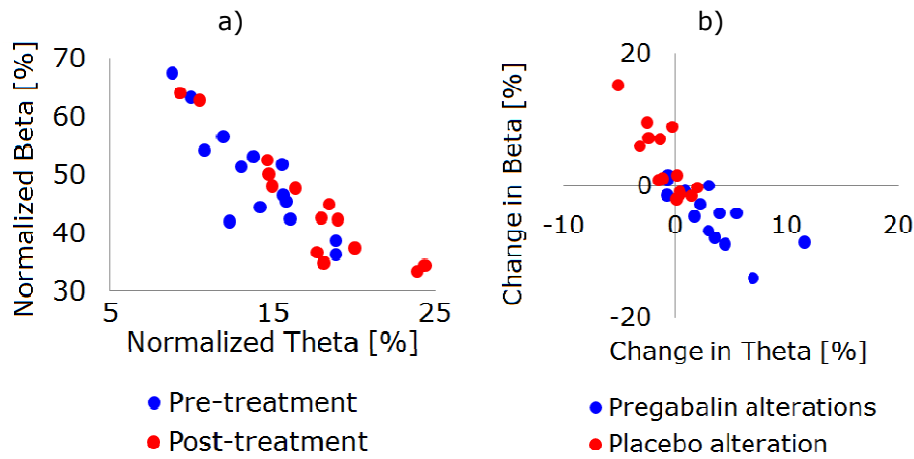

Figure 24. The selection of input features to the classifier needs to be considered in detail. a) Normalized pre- and post-treatment responses to 3 weeks of pregabalin treatment. Although a trend is observed as normalized higher theta and lower beta marginals after treatment, a linear pattern cannot be observed due to large inter-subject variability. b) When the alterations in normalized marginals are used instead, the inter-subject variability vanishes, and a trend is observed compared to placebo treatment. It should however be noted that in study *IV* the input features were split into 7 frequency bands to obtain correlations to clinical scores.

8. Ongoing studies

To assess the broadness of the developed methods, the pattern recognition methodologies are now being applied to a patient group with neuropathic pain due to diabetes mellitus.

To study central mechanisms of autonomic neuropathy, we recorded multi-channel EPs following painful electrical stimulations of the oesophagus from 14 patients clamped at a blood glucose level of 6 and 15 mmol/l and 15 age and gender matched healthy volunteers before and after clamp at 6 mmol/l. At the time being we have published results from the EEG analysis on basic features such as amplitude and latency and source localization of the grand mean traces [27;44;196;197]. One analysis compared patients and healthy volunteers (both clamped at 6mmol/l) and revealed that the diabetic patients had reduced sensitivity to electrical stimulation, increased latencies and reduced amplitude of the EPs. Furthermore, the source analysis revealed that on a group level the anatomical location of the dominating sources during acute pain were different in patients compared to healthy volunteers [44]. These results could be explained by a decrease in conduction velocity of both peripheral and central A δ -fibers and "deafferentation" of peripheral/spinal fibers being damaged. When comparing the recordings for the patients clamped at the two different glucose levels, no difference in sensitivity, latencies and amplitudes of the EPs were observed [27]. Furthermore, we have compared how clamp influences healthy volunteers, and found no changes in the evoked brain potentials in terms of latency and amplitude [197].

As the EEG findings of latency and amplitude alteration in patients correlated with the gastrointestinal symptoms, further analysis is now in progress at an individual level in terms of feature extraction and classification of the EPs and dipole analysis.

8.1. Frequency analysis of diabetes mellitus patients

To gain further insight into the EEG alterations in patients with diabetes mellitus, we have extracted time-frequency features from the average traces from all patients and healthy volunteers. Features were extracted by the TMP algorithm to obtain an estimate of both amplitude and phase for the same atoms in all subjects. Furthermore, in contradiction to the feature extraction in study II, we decomposed all channels simultaneously to have the same atoms extracted for all channels as shown in Figure 25. Additionally we investigated the residuum level per iteration to explore how traces were approximated as shown in Figure 26. The classification for each channel was run by including amplitude and phase features appended for all number of atoms ranging from 1 to 10 as shown in Figure 27, where the residuum level is also displayed. As seen from these results, the classification performance is increased with increasing number of atoms.

These results indicate that feature extraction by TMP may be a way forward to discriminate chronic pain patients from healthy volunteers.

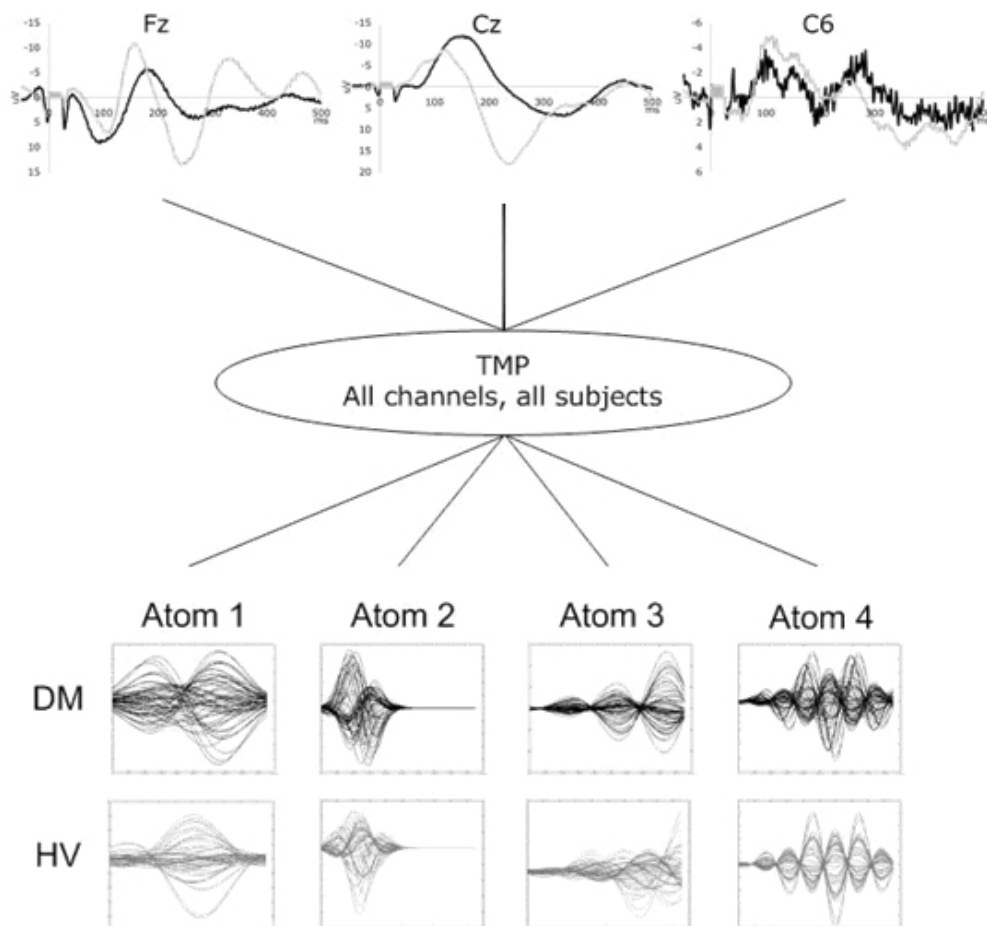
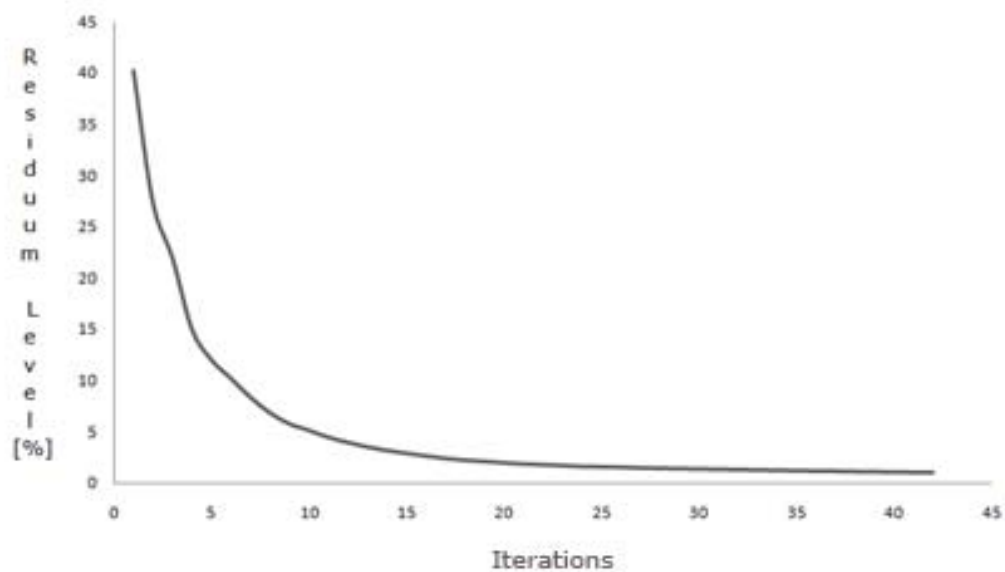

Figure 25. Decomposition of average traces from patients with diabetes mellitus and healthy volunteers. Traces from all channels and all subjects were used as simultaneously input to the algorithm. In the top row, an example of the traces from a representative patient (black) and a healthy volunteer (grey) is displayed. In the bottom two rows, the approximation by the first four atoms are presented for all channels for the patient (DM) and healthy volunteer (HV). As seen from these rows, the same atom is extracted for both subjects, but with different properties in respect to amplitude and phase characteristics. These characteristics were used as input to the SVM.

Figure 26. Residuum level for all subjects and all channels as a function of number of iterations.



No of atoms	Performance	No of atoms	Performance
1 40.3%		6 10.2%	
2 27.4%		7 8.3%	
3 22.0%		8 6.8%	
4 15.0%		9 5.6%	
5 12.0%		10 5.1%	

Figure 27. Classification performance when discriminating patients with diabetes mellitus from age and gender matched healthy volunteers. The classification is performed for each channel individually and with increasing number of atoms included in the analysis. Features for both amplitude and phase are given in the input vector to the support vector machine. The value in percentage indicate the residuum level. Results are presented on a scale from 80 to 100%.

8.2. Source localization in diabetes mellitus patients

Based on the promising results from classification of the TMP extracted features, the dataset was further analyzed to understand the pain mechanisms in individual patients. This was performed by source localization using the commercial software packet BESA® (BESA 5.3, MEGIS Software GmbH, 82166 Graefelfing, Germany). In this software, a model was established based on 5 sources consisting of the anterior cingulate cortex, left and right insula, left and right somatosensory cortex (Figure 28). These sources were based on the grand mean traces to obtain a residual variance less than 10%.

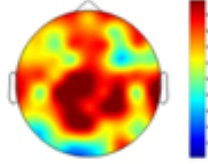
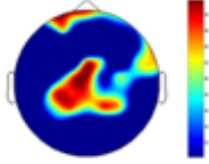
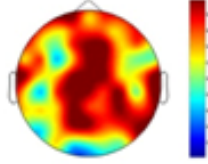
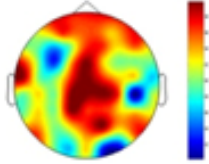
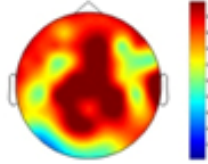
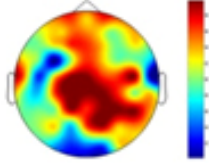
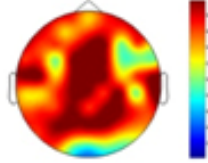
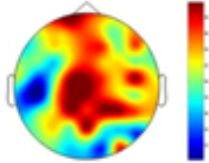
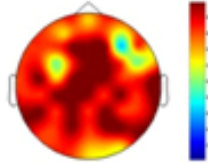
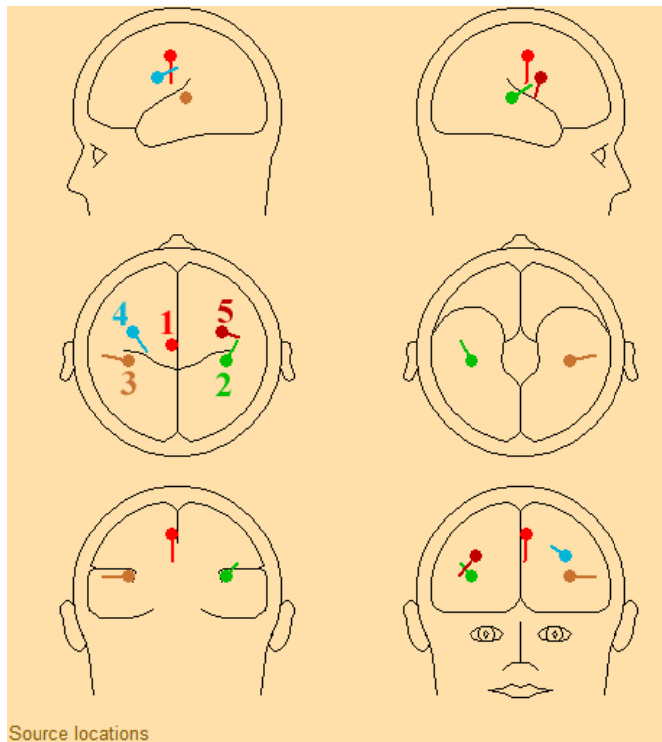

Figure 28. Source localization after painful electrical stimulations in the oesophagus in patients with diabetes mellitus and healthy volunteers. The sources are: 1) Anterior cingulate cortex; 2) Right insula; 3) Left insula; 4) Left sensorimotor cortex; and 5) Right sensorimotor cortex.

In source localization, each source is described by its location in the x,y,z plane, the orientation in the x,y,z plane, strength, latency and a source waveform. After the sources had been modeled for each individual, statistical analysis was applied to explore if there were any differences between patients and healthy volunteers. A difference in the z-coordinate for the right insula source was observed by this analysis ($P=0.002$) [unpublished data; manuscript under preparation]. As we in the future also plan to classify source features, the features were used as input to the SVM to discriminate patients from the healthy volunteers.

The SVM was applied with a linear kernel, and the input features were tested separately and in combination (Table 6).

Table 6. Selected SVM performances when classifying features from source localization.

Source	L	O	S	A	L+O	L+S	L+O+S
1) ACC	17.2%	13.8%	37.9%	51.7%	27.6%	34.5%	41.4%
2) R Ins	69.0%	62.1%	62.1%	44.8%	86.2% *	79.3% *	82.8% *
3) L Ins	69.0%	20.7%	65.5%	62.1%	69.0%	69.0%	65.5%
4) L SI	58.6%	41.4%	20.7%	44.8%	41.4%	51.7%	41.4%
5) R SI	62.1%	37.9%	13.8%	44.8%	62.1%	58.6%	58.6%

L: Location; O: orientation; S: Strength; and A: Area under curve for source waveform. ACC: anterior cingulate cortex; R Ins: right insula; L Ins: left insula; L SI: left sensorymotor cortex; R SI: right sensorimotor cortex. Significant classification accuracy compared to random classification with 50% performance is indicated by bold types and an asterisk.

As seen from Table 6, statistical significant accuracy was obtained when combining features from the right insula. The highest accuracy was obtained when including features for location and orientation. This result corresponds well with previous studies, since activation of the right caudal

anterior insula has been reported in studies of neuropathic pain conditions [198]. To further explore the clinical consequence of the altered insula activation, the individual regression value was correlated to individual pain scores. These pain scores included a Ewing score assessing the autonomic responses, a symptom score assessing symptoms such as nausea, vomiting, bloating, diarrhea, and abdominal pain. This analysis showed a correlation between the regression value and the symptom score ($P=0.048$), which is presented in figure 29.

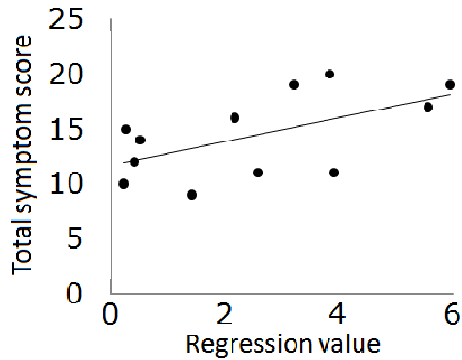

Figure 29. Correlation between regression value obtained when classifying the location and orientation of the right insula dipole source and the total symptoms score indicating to which degree the patient is influenced by nausea, vomiting, bloating, diarrhea and abdominal pain. The classification was performed by discriminating the source features for the patients from the features obtained from healthy volunteers.

Hence, classification of source features was able to detect differences between patients and healthy volunteers, which was confirmed by correlation to clinical scores. Based on this observation, we believe that classification of features from source localization may be a way forward to obtain a more sensitive interpretation of neurophysiologic findings. It should also be noted, that although this approach to our knowledge has not been applied in pain studies before, the model is already established in BCI applications [199-201].

9. Conclusions

In conclusion, we have demonstrated that it is possible to identify biomarkers for abnormal visceral pain processing as well as for altered pain processing after administration of analgesics by classification of EEG responses in individual subjects.

This was obtained by first optimizing the EEG recording techniques to be able to record resting EEG and EPs with optimal signal-to-noise ratio and minimum distortion of signals due to necessary filtering of the traces. This was obtained by recording data in raw format without any unnecessary filtering, followed by post-processing with zero-phase filters in order to have constant group delay for all frequencies.

Secondly, we developed methods to classify healthy volunteers and patients on a group level by modification of some of the methodologies from BCI applications. During the development of the methods we observed several important aspects when applying pattern recognition to pain and pharmacological studies. First, in general when classifying subjects in a group analysis, the design should take into consideration that the inter-subject variability is larger than the alterations of the CNS response due to altered pain processing or pharmacological intervention. Secondly, when classifying resting EEG, the data should be normalized in order to be able to compare alterations between subjects. Third, when classifying EPs, the data should be scaled to adjust for variability in signal level between subjects and days. By this procedure the ratio between recordings before and after modulation of the CNS is preserved, and assessment of individual alterations is comparable to other subjects. Fourth, evaluation of results from the SVM should include both assessment of misclassified subjects as well as a correlation of the regression value and clinical pain scores, as this latter analysis gives an estimate of the complex interaction between brain oscillations. After realizing the importance of these recommendations, we were able to identify biomarkers for induced hyperalgesia in healthy volunteers, combine feature from source localization to classify patients with diabetes mellitus from healthy volunteers, and monitor the analgesic effect of pregabalin in chronic pain patients.

Third, we developed a method to classify healthy volunteers on a single subject basis by classification of single-sweep EPs. During development of this method we observed that due to the low signal-to-noise ratio in the single-sweeps, the feature extraction was of utmost importance, and should to a very high degree be restricted to only extract pain specific information. To fulfill this requirement, a new methodology was developed based on a combination of MMP and SVM. By applying this new approach, where the morphology of the single-sweeps were considered without directly classifying the latency information, we were able to discriminate the pre- and post-treatment responses to morphine and placebo, and validated the method by obtaining high classification accuracy when discriminating the post-treatment responses while the accuracy was low when discriminating the pre-treatment responses. Interestingly, we were also able to correlate the individual classification accuracy for the morphine response to the analgesic effect on a single subject level.

Finally, we brought the gained experiences and methodologies from the classification of healthy volunteers together to validate the methodologies by monitoring the analgesic effect of pregabalin in patients with chronic pain. By classifying the resting EEG alterations caused by pregabalin from the alterations observed in placebo treated patients, we were able to monitor the analgesic effect in the pregabalin treated patients.

Brought together, the results obtained in this Ph.D. thesis indicate that classification of EEG responses may provide an important future perspective to develop methodologies to identify biomarkers for pain and analgesic mechanisms in individual patients, which is an important step towards mechanisms-based pain diagnosis and treatment in clinical settings.

10. Future perspectives

Based on the results obtained during this Ph.D. and several other studies on pain mechanisms and pharmacological intervention by our group, the methodologies will be adapted to a future project supported by the Danish Council for Strategic Research (MULTIPAIN).

The overall goal of this project is to develop a system to predict the individual effect of analgesics. This will be obtained by collecting various types of data to extract biomarkers for pain mechanisms and analgesic effect in healthy volunteers and chronic pain patients. Data will be collected from blood samples (PK-PD modeling), genetic profile, questionnaires assessing adverse effects, EEG (source localization, time-frequency coefficients, coherence, connectivity etc.), and MR (fMRI, DTI, volumetry, spectroscopy etc.). The features from each study will first be classified separately, and when the most discriminative and predictive features have been identified, they will be combined and used as input to the SVM to estimate the net effect of different analgesics including expected adverse effects (Figure 30). Furthermore, by analyzing data from all the studies separately, an additional spin-off is expected to be development of methodologies to be used in many other studies including genetics and analysis of PK-PD measurements obtained by advanced pharmacological analysis of blood samples.

This will be a major step towards *mechanisms-based pain treatment* [7]. Although this will not reduce the number of patients seeking medical attendance due to chronic pain, it will hopefully in the future improve quality of life for the patients and benefit the society.

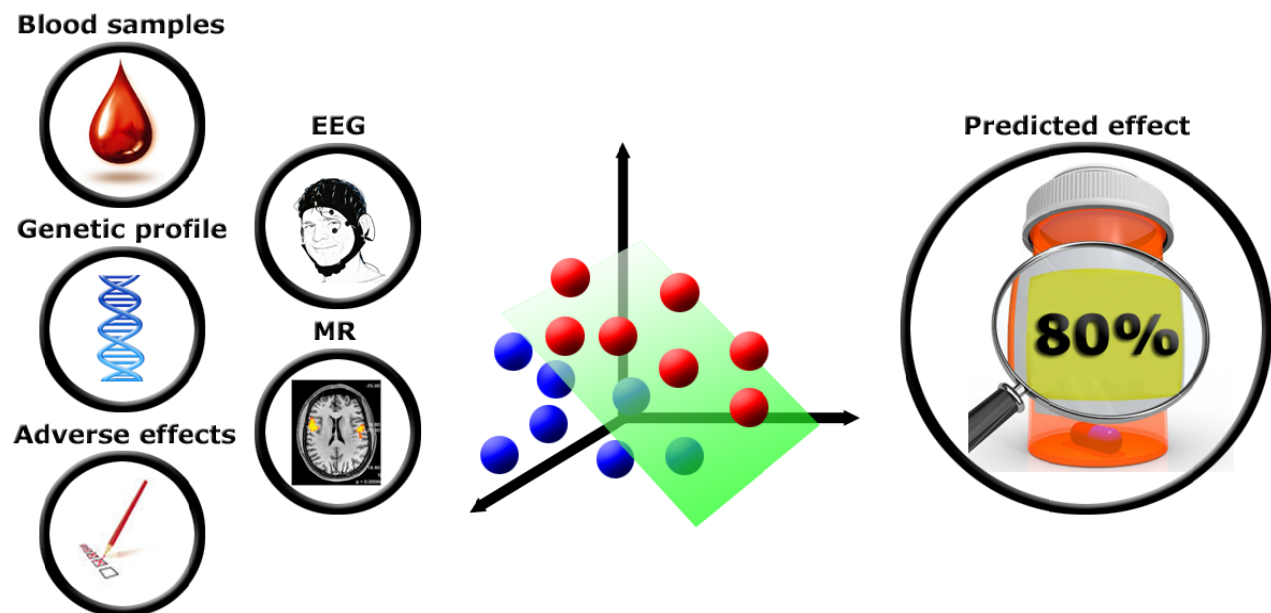

Figure 30. The future perspective of the methodologies is to apply them in a large project where data is collected from several modalities. The input features are classified by the SVM to predict the individual efficacy to various analgesics.

11. Danish summary

Smerteudredning og efterfølgende behandling er en omfattende udfordring i sundhedssektoren på verdensplan. Udfordringerne i forhold til smerteudredning skyldes blandt andet at mange af de underliggende smertemekanismer endnu ikke er klart afdækket, samtidig med at der er et presserende behov for nye metoder til at klarlægge hvilke mekanismer der optræder i den enkelte patient. Da patienter kan have smerter fra flere smertemekanismer, er der yderligere behov for metoder til at monitorere hvorledes smertestillende medikamenter påvirker lige netop den eller de smertemekanismer de er tiltænkt.

Vigtigheden af at løse disse problemstillinger skal ses i lyset af at det er estimeret at 19% af den europæiske befolkning lider af kroniske smerter, og at under halvdelen har tilfredsstillende effekt af den udskrevne smertemedicin. Dette medfører store personlige og samfundsmæssige udfordringer med forringet livskvalitet for patienterne og økonomiske konsekvenser for samfundet.

Da typiske smertemekanismer som for eksempel hypersensibilitet hidrører fra centralnervesystemet, er en mulig målemetode af smerter at anvende elektroencephalografi (EEG), der måler den elektriske aktivitet i hjernen som følge af kommunikation mellem forskellige hjernecentre. Denne aktivitet kan måles i hvile, hvilket afspejler den spontane hjerneaktivitet under kroniske smerter, samt under fremkaldte akutte smerter ("evokerede hjernepotentialer"), hvilket kan bruges til at afspejle den sekventielle og parallelle aktivering af hjernecentrene. Disse EEG målinger kan efterfølgende analyseres og ved hjælp af avancerede matematiske modeller kan karakteristika der beskriver hjernebølgenes frekvenssegenskaber bestemmes.

De beregnede karakteristika kan herefter klassificeres hvilket giver et udtryk for forskellen mellem patienter og raske kontroller samt de ændringer der sker i centralnervesystemet efter indtagelse af smertestillende lægemidler. Ved at anvende metoder baseret på optimal adskillelse af grupperne ud fra en matematisk model ("support vector maskine"), kan man desuden opnå en individuel kvantificering af i hvor høj grad det enkelte individ er karakteriseret af en bestemt smertemekanisme samt hvorledes et bestemt lægemiddel ændrer individets EEG respons.

Ved at anvende avancerede modeller til at udtrække frekvenskarakteristika fra EEG signalet på individniveau efterfulgt af klassifikation af disse parametre, har vi identificeret markører for øget følsomhed fra de indre organer induceret i raske frivillige samt for følger efter nervebetændelse hos patienter med type-1 diabetes. Derudover har vi udviklet et system til at monitorere den smertestillende effekt efter en enkelt-dosis morfin i raske frivillige samt den smertestillende effekt efter tre ugers smertebehandling med pregabalin hos patienter med kroniske mavesmerter på grund af kronisk betændelse i bugspytskirtlen.

Disse resultater indikerer at klassifikation af EEG signaler er en mulig vej frem i forhold til at opnå bedre mekanistisk-baseret smertebehandling på individniveau, samt et værktøj til at vurdere de mekanistiske ændringer i centralnervesystemet ved behandling med smertestillende medicin.

Reference List

1. Varrassi G, Muller-Schwefe G, Pergolizzi J *et al.* Pharmacological treatment of chronic pain - the need for CHANGE. *Curr.Med.Res.Opin.* 2010; **26**: 1231-1245.
2. Breivik H, Collett B, Ventafridda V, Cohen R, Gallacher D. Survey of chronic pain in Europe: prevalence, impact on daily life, and treatment. *Eur.J.Pain* 2006; **10**: 287-333.
3. Ladabaum U, Minoshima S, Owyang C. Pathobiology of visceral pain: molecular mechanisms and therapeutic implications V. Central nervous system processing of somatic and visceral sensory signals. *Am.J.Physiol Gastrointest.Liver Physiol* 2000; **279**: G1-G6.
4. Woolf CJ, Bennett GJ, Doherty M *et al.* Towards a mechanism-based classification of pain? *Pain* 1998; **77**: 227-229.
5. Azpiroz F. Hypersensitivity in functional gastrointestinal disorders. *Gut* 2002; **51 Suppl 1**: i25-i28.
6. Galer BS, Miller KV, Rowbotham MC. Response to intravenous lidocaine infusion differs based on clinical diagnosis and site of nervous system injury. *Neurology* 1993; **43**: 1233-1235.
7. Woolf CJ, Max MB. Mechanism-based pain diagnosis: issues for analgesic drug development. *Anesthesiology* 2001; **95**: 241-249.
8. Woolf CJ. Central sensitization: implications for the diagnosis and treatment of pain. *Pain* 2011; **152**: S2-15.
9. Hartrick CT, Rozek RJ. Tapentadol in pain management: a mu-opioid receptor agonist and noradrenaline reuptake inhibitor. *CNS.Drugs* 2011; **25**: 359-370.
10. Otis V, Sarret P, Gendron L. Spinal activation of delta opioid receptors alleviates cancer-related bone pain. *Neuroscience* 2011; **183**: 221-229.
11. Fink K, Dooley DJ, Meder WP, Suman-Chauhan N, Duffy S, Clusmann H, Gothert M. Inhibition of neuronal Ca(2+) influx by gabapentin and pregabalin in the human neocortex. *Neuropharmacology* 2002; **42**: 229-236.
12. Rao SG. Current progress in the pharmacological therapy of fibromyalgia. *Expert.Opin.Investig.Drugs* 2009; **18**: 1479-1493.
13. Bueno L, Fioramonti J. Action of opiates on gastrointestinal function. *Baillieres Clin.Gastroenterol.* 1988; **2**: 123-139.
14. Riley J, Ross JR, Rutter D, Wells AU, Goller K, du BR, Welsh K. No pain relief from morphine? Individual variation in sensitivity to morphine and the need to switch to an alternative opioid in cancer patients. *Support.Care Cancer* 2006; **14**: 56-64.
15. Maier C, Hildebrandt J, Klinger R, Henrich-Eberl C, Lindena G. Morphine responsiveness, efficacy and tolerability in patients with chronic non-tumor associated pain - results of a double-blind placebo-controlled trial (MONTAS). *Pain* 2002; **97**: 223-233.
16. Kindler LL, Sibille KT, Glover TL, Staud R, Riley JL, III, Fillingim RB. Drug response profiles to experimental pain are opioid and pain modality specific. *J.Pain* 2011; **12**: 340-351.
17. Olesen SS, Bouwense SA, Wilder-Smith OH, van GH, Drewes AM. Pregabalin Reduces Pain in Patients With Chronic Pancreatitis in a Randomized, Controlled Trial. *Gastroenterology* 2011.

18. Fehrenbacher JC, Taylor CP, Vasko MR. Pregabalin and gabapentin reduce release of substance P and CGRP from rat spinal tissues only after inflammation or activation of protein kinase C. *Pain* 2003; **105**: 133-141.
19. Staahl C, Reddy H, Andersen SD, Arendt-Nielsen L, Drewes AM. Multi-modal and tissue-differentiated experimental pain assessment: reproducibility of a new concept for assessment of analgesics. *Basic Clin.Pharmacol.Toxicol.* 2006; **98**: 201-211.
20. Drewes AM, Gregersen H, Arendt-Nielsen L. Experimental pain in gastroenterology: a reappraisal of human studies. *Scand.J.Gastroenterol.* 2003; **38**: 1115-1130.
21. Frokjaer JB, Andersen SD, Gale J, Arendt-Nielsen L, Gregersen H, Drewes AM. An experimental study of viscerovisceral hyperalgesia using an ultrasound-based multimodal sensory testing approach. *Pain* 2005; **119**: 191-200.
22. Brock C, Andresen T, Frokjaer JB, Gale J, Olesen AE, Arendt-Nielsen L, Drewes AM. Central pain mechanisms following combined acid and capsaicin perfusion of the human oesophagus. *Eur.J.Pain* 2010; **14**: 273-281.
23. Sami SA, Rossel P, Dimcevski G, Nielsen KD, Funch-Jensen P, Valeriani M, Arendt-Nielsen L, Drewes AM. Cortical changes to experimental sensitization of the human esophagus. *Neuroscience* 2006; **140**: 269-279.
24. Frokjaer JB, Olesen SS, Graversen C, Andresen T, Lelic D, Drewes AM. Neuroimaging of the human visceral pain system – a methodological review. *Scand.J.Pain* 2011.
25. Olesen SS, Hansen TM, Graversen C, Steimle K, Wilder-Smith OH, Drewes AM. Slowed EEG rhythmicity in patients with chronic pancreatitis: evidence of abnormal cerebral pain processing? *Eur.J.Gastroenterol.Hepatol.* 2011; **23**: 418-424.
26. Knott VJ. Quantitative EEG methods and measures in human psychopharmacological research. *Hum.Psychopharmacol.* 2000; **15**: 479-498.
27. Frokjaer JB, Softeland E, Graversen C, Dimcevski G, Drewes AM. Effect of acute hyperglycaemia on sensory processing in diabetic autonomic neuropathy. *Eur.J.Clin.Invest* 2010; **40**: 883-886.
28. Blauenfeldt RA, Olesen SS, Hansen JB, Graversen C, Drewes AM. Abnormal brain processing in hepatic encephalopathy: evidence of cerebral reorganization? *Eur.J.Gastroenterol.Hepatol.* 2010; **22**: 1323-1330.
29. Staahl C, Krarup AL, Olesen AE, Brock C, Graversen C, Drewes AM. Is Electrical Brain Activity a Reliable Biomarker for Opioid Analgesia in the Gut? *Basic Clin.Pharmacol.Toxicol.* 2011.
30. Bromm B, Scharein E, Vahle-Hinz C. Cortex areas involved in the processing of normal and altered pain. *Prog.Brain Res.* 2000; **129**: 289-302.
31. Hadjipavlou G, Dunckley P, Behrens TE, Tracey I. Determining anatomical connectivities between cortical and brainstem pain processing regions in humans: a diffusion tensor imaging study in healthy controls. *Pain* 2006; **123**: 169-178.
32. Apkarian AV, Hashmi JA, Baliki MN. Pain and the brain: specificity and plasticity of the brain in clinical chronic pain. *Pain* 2011; **152**: S49-S64.
33. May A. Neuroimaging: visualising the brain in pain. *Neurol.Sci.* 2007; **28 Suppl 2**: S101-S107.

34. Heiss WD, Herholz K. Brain receptor imaging. *J.Nucl.Med.* 2006; **47**: 302-312.
35. Willer JC. Comparative study of perceived pain and nociceptive flexion reflex in man. *Pain* 1977; **3**: 69-80.
36. Neziri AY, Andersen OK, Petersen-Felix S, Radanov B, Dickenson AH, Scaramozzino P, Arendt-Nielsen L, Curatolo M. The nociceptive withdrawal reflex: normative values of thresholds and reflex receptive fields. *Eur.J.Pain* 2010; **14**: 134-141.
37. Moltner A, Holzl R, Strian F. Heart rate changes as an autonomic component of the pain response. *Pain* 1990; **43**: 81-89.
38. Middleton C. Understanding the physiological effects of unrelieved pain. *Nurs.Times* 2003; **99**: 28-31.
39. Heller PH, Perry F, Naifeh K, Gordon NC, Wachter-Shikura N, Levine J. Cardiovascular autonomic response during preoperative stress and postoperative pain. *Pain* 1984; **18**: 33-40.
40. Tonner PH, Bein B. Classic electroencephalographic parameters: median frequency, spectral edge frequency etc. *Best.Pract.Res.Clin.Anaesthesiol.* 2006; **20**: 147-159.
41. Sarnthein J, Stern J, Aufenberg C, Rousson V, Jeanmonod D. Increased EEG power and slowed dominant frequency in patients with neurogenic pain. *Brain* 2006; **129**: 55-64.
42. Sarkar S, Hobson AR, Furlong PL, Woolf CJ, Thompson DG, Aziz Q. Central neural mechanisms mediating human visceral hypersensitivity. *Am.J.Physiol Gastrointest.Liver Physiol* 2001; **281**: G1196-G1202.
43. Drewes AM, Gratkowski M, Sami SA, Dimcevski G, Funch-Jensen P, Arendt-Nielsen L. Is the pain in chronic pancreatitis of neuropathic origin? Support from EEG studies during experimental pain. *World J.Gastroenterol.* 2008; **14**: 4020-4027.
44. Frokjaer JB, Egsgaard LL, Graversen C, Softeland E, Dimcevski G, Blauenfeldt RA, Drewes AM. Gastrointestinal symptoms in type-1 diabetes: is it all about brain plasticity? *Eur.J.Pain* 2011; **15**: 249-257.
45. Bell IR, Lewis DA, Schwartz GE, Lewis SE, Caspi O, Scott A, Brooks AJ, Baldwin CM. Electroencephalographic cordance patterns distinguish exceptional clinical responders with fibromyalgia to individualized homeopathic medicines. *J.Altern.Complement Med.* 2004; **10**: 285-299.
46. Lehmann C, Koenig T, Jelic V, Prichet L, John RE, Wahlund LO, Dodge Y, Dierks T. Application and comparison of classification algorithms for recognition of Alzheimer's disease in electrical brain activity (EEG). *J.Neurosci.Methods* 2007; **161**: 342-350.
47. Neuhaus AH, Popescu FC, Grozea C, Hahn E, Hahn C, Opgen-Rhein C, Urbanek C, Dettling M. Single-subject classification of schizophrenia by event-related potentials during selective attention. *Neuroimage.* 2011; **55**: 514-521.
48. Iaione F, Marques JL. Methodology for hypoglycaemia detection based on the processing, analysis and classification of the electroencephalogram. *Med.Biol.Eng Comput.* 2005; **43**: 501-507.
49. Wolpaw JR, Birbaumer N, McFarland DJ, Pfurtscheller G, Vaughan TM. Brain-computer interfaces for communication and control. *Clin.Neurophysiol.* 2002; **113**: 767-791.

50. Cabrera AF, Farina D, Dremstrup K. Comparison of feature selection and classification methods for a brain-computer interface driven by non-motor imagery. *Med.Biol.Eng Comput.* 2010; **48**: 123-132.
51. Bai O, Lin P, Vorbach S, Li J, Furlani S, Hallett M. Exploration of computational methods for classification of movement intention during human voluntary movement from single trial EEG. *Clin.Neurophysiol.* 2007; **118**: 2637-2655.
52. D'Mello R, Dickenson AH. Spinal cord mechanisms of pain. *Br.J.Anaesth.* 2008; **101**: 8-16.
53. Julius D, Basbaum AI. Molecular mechanisms of nociception. *Nature* 2001; **413**: 203-210.
54. Furst S. Transmitters involved in antinociception in the spinal cord. *Brain Res.Bull.* 1999; **48**: 129-141.
55. Sindrup SH, Jensen TS. Efficacy of pharmacological treatments of neuropathic pain: an update and effect related to mechanism of drug action. *Pain* 1999; **83**: 389-400.
56. Todd AJ. Anatomy of primary afferents and projection neurones in the rat spinal dorsal horn with particular emphasis on substance P and the neurokinin 1 receptor. *Exp.Physiol* 2002; **87**: 245-249.
57. Willis WD, Westlund KN. Neuroanatomy of the pain system and of the pathways that modulate pain. *J.Clin.Neurophysiol.* 1997; **14**: 2-31.
58. Schnitzler A, Ploner M. Neurophysiology and functional neuroanatomy of pain perception. *J.Clin.Neurophysiol.* 2000; **17**: 592-603.
59. Aziz Q, Thompson DG, Ng VW *et al.* Cortical processing of human somatic and visceral sensation. *J.Neurosci.* 2000; **20**: 2657-2663.
60. Craig AD. Pain mechanisms: labeled lines versus convergence in central processing. *Annu.Rev.Neurosci.* 2003; **26**: 1-30.
61. Schweinhardt P, Glynn C, Brooks J, McQuay H, Jack T, Chessell I, Bountra C, Tracey I. An fMRI study of cerebral processing of brush-evoked allodynia in neuropathic pain patients. *Neuroimage.* 2006; **32**: 256-265.
62. Devinsky O, Morrell MJ, Vogt BA. Contributions of anterior cingulate cortex to behaviour. *Brain* 1995; **118 (Pt 1)**: 279-306.
63. Vogt BA, Derbyshire S, Jones AK. Pain processing in four regions of human cingulate cortex localized with co-registered PET and MR imaging. *Eur.J.Neurosci.* 1996; **8**: 1461-1473.
64. Peyron R, Laurent B, Garcia-Larrea L. Functional imaging of brain responses to pain. A review and meta-analysis (2000). *Neurophysiol.Clin.* 2000; **30**: 263-288.
65. Davis KD, Hutchison WD, Lozano AM, Dostrovsky JO. Altered pain and temperature perception following cingulotomy and capsulotomy in a patient with schizoaffective disorder. *Pain* 1994; **59**: 189-199.
66. Tolle TR, Kaufmann T, Siessmeier T *et al.* Region-specific encoding of sensory and affective components of pain in the human brain: a positron emission tomography correlation analysis. *Ann.Neurol.* 1999; **45**: 40-47.
67. Frith C, Dolan R. The role of the prefrontal cortex in higher cognitive functions. *Brain Res.Cogn Brain Res.* 1996; **5**: 175-181.

68. Petrovic P, Kalso E, Petersson KM, Ingvar M. Placebo and opioid analgesia-- imaging a shared neuronal network. *Science* 2002; **295**: 1737-1740.
69. Bingel U. [Mechanisms of endogenous pain modulation illustrated by placebo analgesia : functional imaging findings]. *Schmerz*. 2010; **24**: 122-129.
70. Gebhart GF. Pathobiology of visceral pain: molecular mechanisms and therapeutic implications IV. Visceral afferent contributions to the pathobiology of visceral pain. *Am.J.Physiol Gastrointest.Liver Physiol* 2000; **278**: G834-G838.
71. Bueno L, Fioramonti J. Visceral perception: inflammatory and non-inflammatory mediators. *Gut* 2002; **51 Suppl 1**: i19-i23.
72. Moisset X, Bouhassira D, Denis D, Dominique G, Benoit C, Sabate JM. Anatomical connections between brain areas activated during rectal distension in healthy volunteers: a visceral pain network. *Eur.J.Pain* 2010; **14**: 142-148.
73. Mayer EA, Naliboff BD, Craig AD. Neuroimaging of the brain-gut axis: from basic understanding to treatment of functional GI disorders. *Gastroenterology* 2006; **131**: 1925-1942.
74. Drewes AM, Dimcevski G, Sami SA, Funch-Jensen P, Huynh KD, Le PD, Arendt-Nielsen L, Valeriani M. The "human visceral homunculus" to pain evoked in the oesophagus, stomach, duodenum and sigmoid colon. *Exp.Brain Res*. 2006; **174**: 443-452.
75. Hollerbach S, Tougas G, Frieling T, Enck P, Fitzpatrick D, Upton AR, Kamath MV. Cerebral evoked responses to gastrointestinal stimulation in humans. *Crit Rev.Biomed.Eng* 1997; **25**: 203-242.
76. Woolf CJ. Somatic pain--pathogenesis and prevention. *Br.J.Anaesth*. 1995; **75**: 169-176.
77. MENDELL LM, WALL PD. RESPONSES OF SINGLE DORSAL CORD CELLS TO PERIPHERAL CUTANEOUS UNMYELINATED FIBRES. *Nature* 1965; **206**: 97-99.
78. Randic M, Jiang MC, Cerne R. Long-term potentiation and long-term depression of primary afferent neurotransmission in the rat spinal cord. *J.Neurosci*. 1993; **13**: 5228-5241.
79. Coste J, Voisin DL, Luccarini P, Dallel R. A role for wind-up in trigeminal sensory processing: intensity coding of nociceptive stimuli in the rat. *Cephalalgia* 2008; **28**: 631-639.
80. Arendt-Nielsen L, Petersen-Felix S. Wind-up and neuroplasticity: is there a correlation to clinical pain? *Eur.J.Anaesthesiol.Suppl* 1995; **10**: 1-7.
81. Nie H, Graven-Nielsen T, Arendt-Nielsen L. Spatial and temporal summation of pain evoked by mechanical pressure stimulation. *Eur.J.Pain* 2009; **13**: 592-599.
82. Greenspan JD, Thomadaki M, McGillis SL. Spatial summation of perceived pressure, sharpness and mechanically evoked cutaneous pain. *Somatosens.Mot.Res*. 1997; **14**: 107-112.
83. Melzack R, WALL PD. Pain mechanisms: a new theory. *Science* 1965; **150**: 971-979.
84. Sprenger C, Bingel U, Buchel C. Treating pain with pain: supraspinal mechanisms of endogenous analgesia elicited by heterotopic noxious conditioning stimulation. *Pain* 2011; **152**: 428-439.
85. Rennefeld C, Wiech K, Schoell ED, Lorenz J, Bingel U. Habituation to pain: further support for a central component. *Pain* 2010; **148**: 503-508.

86. Zubieta JK, Stohler CS. Neurobiological mechanisms of placebo responses. *Ann.N.Y.Acad.Sci.* 2009; **1156**: 198-210.
87. Tracey DJ, De BS, Phend K, Rustioni A. Aspartate-like immunoreactivity in primary afferent neurons. *Neuroscience* 1991; **40**: 673-686.
88. Woolf CJ. Pain: moving from symptom control toward mechanism-specific pharmacologic management. *Ann.Intern.Med.* 2004; **140**: 441-451.
89. Straube S, Derry S, McQuay HJ, Moore RA. Enriched enrollment: definition and effects of enrichment and dose in trials of pregabalin and gabapentin in neuropathic pain. A systematic review. *Br.J.Clin.Pharmacol.* 2008; **66**: 266-275.
90. Lieb JG, Forsmark CE. Review article: pain and chronic pancreatitis. *Aliment.Pharmacol.Ther.* 2009; **29**: 706-719.
91. Tuchman M, Barrett JA, Donevan S, Hedberg TG, Taylor CP. Central sensitization and Ca(V)alpha delta ligands in chronic pain syndromes: pathologic processes and pharmacologic effect. *J.Pain* 2010; **11**: 1241-1249.
92. Dabelea D, Snell-Bergeon JK, Hartsfield CL, Bischoff KJ, Hamman RF, McDuffie RS. Increasing prevalence of gestational diabetes mellitus (GDM) over time and by birth cohort: Kaiser Permanente of Colorado GDM Screening Program. *Diabetes Care* 2005; **28**: 579-584.
93. Vinik AI, Maser RE, Mitchell BD, Freeman R. Diabetic autonomic neuropathy. *Diabetes Care* 2003; **26**: 1553-1579.
94. Frokjaer JB, Andersen SD, Ejskaer N, Funch-Jensen P, Arendt-Nielsen L, Gregersen H, Drewes AM. Gut sensations in diabetic autonomic neuropathy. *Pain* 2007; **131**: 320-329.
95. Kamath MV, Tougas G, Fitzpatrick D, Fallen EL, Watteel R, Shine G, Upton AR. Assessment of the visceral afferent and autonomic pathways in response to esophageal stimulation in control subjects and in patients with diabetes. *Clin.Invest Med.* 1998; **21**: 100-113.
96. Rathmann W, Enck P, Frieling T, Gries FA. Visceral afferent neuropathy in diabetic gastroparesis. *Diabetes Care* 1991; **14**: 1086-1089.
97. Tougas G, Hunt RH, Fitzpatrick D, Upton AR. Evidence of impaired afferent vagal function in patients with diabetes gastroparesis. *Pacing Clin.Electrophysiol.* 1992; **15**: 1597-1602.
98. Jadad AR, Browman GP. The WHO analgesic ladder for cancer pain management. Stepping up the quality of its evaluation. *JAMA* 1995; **274**: 1870-1873.
99. Ahmed Khan MI, Walsh D, Brito-Dellan N. Opioid and Adjuvant Analgesics: Compared and Contrasted. *Am.J.Hosp.Palliat.Care* 2011.
100. De Schepper HU, Cremonini F, Park MI, Camilleri M. Opioids and the gut: pharmacology and current clinical experience. *Neurogastroenterol.Motil.* 2004; **16**: 383-394.
101. Trescot AM, Datta S, Lee M, Hansen H. Opioid pharmacology. *Pain Physician* 2008; **11**: S133-S153.
102. Sprenger T, Valet M, Boecker H, Henriksen G, Spilker ME, Willoch F, Wagner KJ, Wester HJ, Tolle TR. Opioidergic activation in the medial pain system after heat pain. *Pain* 2006; **122**: 63-67.
103. Kress HG. Clinical update on the pharmacology, efficacy and safety of transdermal buprenorphine. *Eur.J.Pain* 2009; **13**: 219-230.

104. Finnerup NB, Sindrup SH, Jensen TS. The evidence for pharmacological treatment of neuropathic pain. *Pain* 2010; **150**: 573-581.
105. Lazarewicz MT, Ehrlichman RS, Maxwell CR, Gandal MJ, Finkel LH, Siegel SJ. Ketamine modulates theta and gamma oscillations. *J.Cogn Neurosci.* 2010; **22**: 1452-1464.
106. Olesen SS, Graversen C, Olesen AE, Frokjaer JB, Wilder-Smith O, van GH, Valeriani M, Drewes AM. Randomised clinical trial: pregabalin attenuates experimental visceral pain through sub-cortical mechanisms in patients with painful chronic pancreatitis. *Aliment.Pharmacol.Ther.* 2011.
107. Million M, Wang L, Adelson DW, Roman F, Diop L, Tache Y. Pregabalin decreases visceral pain and prevents spinal neuronal activation in rats. *Gut* 2007; **56**: 1482-1484.
108. Apkarian AV, Bushnell MC, Treede RD, Zubieta JK. Human brain mechanisms of pain perception and regulation in health and disease. *Eur.J.Pain* 2005; **9**: 463-484.
109. Staahl C, Olesen AE, Andresen T, Arendt-Nielsen L, Drewes AM. Assessing analgesic actions of opioids by experimental pain models in healthy volunteers - an updated review. *Br.J.Clin.Pharmacol.* 2009; **68**: 149-168.
110. Staahl C, Olesen AE, Andresen T, Arendt-Nielsen L, Drewes AM. Assessing efficacy of non-opioid analgesics in experimental pain models in healthy volunteers: an updated review. *Br.J.Clin.Pharmacol.* 2009; **68**: 322-341.
111. Kavanagh KT, Domico WD. High pass digital and analog filtering of the middle latency response. *Ear Hear.* 1987; **8**: 101-109.
112. Scherg M. Distortion of the middle latency auditory response produced by analog filtering. *Scand.Audiol.* 1982; **11**: 57-60.
113. Green JB, Nelson AV, Michael D. Digital zero-phase-shift filtering of short-latency somatosensory evoked potentials. *Electroencephalogr.Clin.Neurophysiol.* 1986; **63**: 384-388.
114. Drewes AM, Arendt-Nielsen L, Jensen JH, Hansen JB, Krarup HB, Tage-Jensen U. Experimental pain in the stomach: a model based on electrical stimulation guided by gastroscopy. *Gut* 1997; **41**: 753-757.
115. Olesen SS, Frokjaer JB, Lelic D, Valeriani M, Drewes AM. Pain-associated adaptive cortical reorganisation in chronic pancreatitis. *Pancreatology.* 2010; **10**: 742-751.
116. Karakas S, Erzenigin OU, Basar E. The genesis of human event-related responses explained through the theory of oscillatory neural assemblies. *Neurosci.Lett.* 2000; **285**: 45-48.
117. Luu P, Tucker DM. Regulating action: alternating activation of midline frontal and motor cortical networks. *Clin.Neurophysiol.* 2001; **112**: 1295-1306.
118. Makeig S, Westerfield M, Jung TP, Enghoff S, Townsend J, Courchesne E, Sejnowski TJ. Dynamic brain sources of visual evoked responses. *Science* 2002; **295**: 690-694.
119. Klimesch W, Schack B, Schabus M, Doppelmayr M, Gruber W, Sauseng P. Phase-locked alpha and theta oscillations generate the P1-N1 complex and are related to memory performance. *Brain Res.Cogn Brain Res.* 2004; **19**: 302-316.
120. Fuentemilla L, Marco-Pallares J, Munte TF, Grau C. Theta EEG oscillatory activity and auditory change detection. *Brain Res.* 2008; **1220**: 93-101.

121. Fuentemilla L, Marco-Pallares J, Grau C. Modulation of spectral power and of phase resetting of EEG contributes differentially to the generation of auditory event-related potentials. *Neuroimage*. 2006; **30**: 909-916.
122. Domnick C, Hauck M, Casey KL, Engel AK, Lorenz J. C-fiber-related EEG-oscillations induced by laser radiant heat stimulation of capsaicin-treated skin. *J.Pain Res*. 2009; **2**: 49-56.
123. Scheller BC, Dauser M, Pipa G. General anesthesia increases temporal precision and decreases power of the brainstem auditory-evoked response-related segments of the electroencephalogram. *Anesthesiology* 2009; **111**: 340-355.
124. Quante M, Scharein E, Zimmermann R, Langer-Brauburger B, Bromm B. Dissociation of morphine analgesia and sedation evaluated by EEG measures in healthy volunteers. *Arzneimittelforschung*. 2004; **54**: 143-151.
125. Digiaco MR, Marco-Pallares J, Flores AB, Gomez CM. Wavelet analysis of the EEG during the neurocognitive evaluation of invalidly cued targets. *Brain Res*. 2008; **1234**: 94-103.
126. Huber MT, Bartling J, Pachur D, Woikowsky-Biedau S, Lautenbacher S. EEG responses to tonic heat pain. *Exp.Brain Res*. 2006; **173**: 14-24.
127. Hyllienmark L, Maltez J, Dandenell A, Ludvigsson J, Brismar T. EEG abnormalities with and without relation to severe hypoglycaemia in adolescents with type 1 diabetes. *Diabetologia* 2005; **48**: 412-419.
128. Brismar T. The human EEG--physiological and clinical studies. *Physiol Behav*. 2007; **92**: 141-147.
129. Stern J, Jeanmonod D, Sarnthein J. Persistent EEG overactivation in the cortical pain matrix of neurogenic pain patients. *Neuroimage*. 2006; **31**: 721-731.
130. Nguyen HT, Jones TW. Detection of nocturnal hypoglycemic episodes using EEG signals. *Conf.Proc.IEEE Eng Med.Biol.Soc*. 2010; **2010**: 4930-4933.
131. Graversen C, Brock C, Drewes AM, Farina D. Combined multivariate matching pursuit and support vector machine: A way forward to classify single-sweep evoked potentials? *Conf.Proc.IEEE Eng Med.Biol.Soc*. 2011; **2011**.
132. Backonja M, Howland EW, Wang J, Smith J, Salinsky M, Cleeland CS. Tonic changes in alpha power during immersion of the hand in cold water. *Electroencephalogr.Clin.Neurophysiol*. 1991; **79**: 192-203.
133. Tayama J, Sagami Y, Shimada Y, Hongo M, Fukudo S. Effect of alpha-helical CRH on quantitative electroencephalogram in patients with irritable bowel syndrome. *Neurogastroenterol.Motil*. 2007; **19**: 471-483.
134. Nir RR, Sinai A, Raz E, Sprecher E, Yarnitsky D. Pain assessment by continuous EEG: association between subjective perception of tonic pain and peak frequency of alpha oscillations during stimulation and at rest. *Brain Res*. 2010; **1344**: 77-86.
135. Gross J, Schnitzler A, Timmermann L, Ploner M. Gamma oscillations in human primary somatosensory cortex reflect pain perception. *PLoS.Biol*. 2007; **5**: e133.
136. Babiloni C, Babiloni F, Carducci F, Cincotti F, Rosciarelli F, Arendt-Nielsen L, Chen AC, Rossini PM. Human brain oscillatory activity phase-locked to painful electrical stimulations: a multi-channel EEG study. *Hum.Brain Mapp*. 2002; **15**: 112-123.
137. Tiemann L, Schulz E, Gross J, Ploner M. Gamma oscillations as a neuronal correlate of the attentional effects of pain. *Pain* 2010; **150**: 302-308.

138. De P, V, Cacace I. Pain perception, obstructive imagery and phase-ordered gamma oscillations. *Int.J.Psychophysiol.* 2005; **56**: 157-169.
139. Scott JC, Ponganis KV, Stanski DR. EEG quantitation of narcotic effect: the comparative pharmacodynamics of fentanyl and alfentanil. *Anesthesiology* 1985; **62**: 234-241.
140. Detsch O, Kochs E. [Effects of ketamine on CNS-function]. *Anaesthesist* 1997; **46 Suppl 1**: S20-S29.
141. Kochs E, Scharein E, Mollenberg O, Bromm B, Schulte am EJ. Analgesic efficacy of low-dose ketamine. Somatosensory-evoked responses in relation to subjective pain ratings. *Anesthesiology* 1996; **85**: 304-314.
142. Galderisi S, Mucci A, Bucci P, Mignone ML, Maj M. Multilead quantitative EEG profile of clozapine in resting and vigilance-controlled conditions. *Psychiatry Res.* 1996; **67**: 113-122.
143. Phillips RL, Herning R, London ED. Morphine effects on the spontaneous electroencephalogram in polydrug abusers: correlations with subjective self-reports. *Neuropsychopharmacology* 1994; **10**: 171-181.
144. Saletu B, Grunberger J, Linzmayer L. Pharmacokinetic and dynamic studies with a new anxiolytic imidazo-pyridine alpidem utilizing pharmaco-EEG and psychometry. *Int.Clin.Psychopharmacol.* 1986; **1**: 145-164.
145. Saletu B, Anderer P, Saletu-Zyhlarz GM. EEG topography and tomography (LORETA) in the classification and evaluation of the pharmacodynamics of psychotropic drugs. *Clin.EEG.Neurosci.* 2006; **37**: 66-80.
146. Ohtani Y, Kotegawa T, Tsutsumi K, Morimoto T, Hirose Y, Nakano S. Effect of fluconazole on the pharmacokinetics and pharmacodynamics of oral and rectal bromazepam: an application of electroencephalography as the pharmacodynamic method. *J.Clin.Pharmacol.* 2002; **42**: 183-191.
147. Akay M, Akay YM, Szeto HH. The effects of morphine on the relationship between fetal EEG, breathing and blood pressure signals using fast wavelet transform. *Biol.Cybern.* 1996; **74**: 367-372.
148. Matejcek M, Pokorny R, Ferber G, Klee H. Effect of morphine on the electroencephalogram and other physiological and other physiological and behavioral parameters. *Neuropsychobiology* 1988; **19**: 202-211.
149. Farina D, do Nascimento OF, Lucas MF, Doncarli C. Optimization of wavelets for classification of movement-related cortical potentials generated by variation of force-related parameters. *J.Neurosci.Methods* 2007; **162**: 357-363.
150. Nielsen M, Kamavuako EN, Andersen MM, Lucas MF, Farina D. Optimal wavelets for biomedical signal compression. *Med.Biol.Eng Comput.* 2006; **44**: 561-568.
151. Kalatzis I, Piliouras N, Ventouras E, Papageorgiou CC, Rabavilas AD, Cavouras D. Design and implementation of an SVM-based computer classification system for discriminating depressive patients from healthy controls using the P600 component of ERP signals. *Comput.Methods Programs Biomed.* 2004; **75**: 11-22.
152. Dietsch, G. Analyse von elektroenzephalogrammen des Menschen. *Pflügers Arch Ges Physiol.* 230, 106-112. 1932.
153. Samar VJ, Bopardikar A, Rao R, Swartz K. Wavelet analysis of neuroelectric waveforms: a conceptual tutorial. *Brain Lang* 1999; **66**: 7-60.

154. Durka PJ. From wavelets to adaptive approximations: time-frequency parametrization of EEG. *Biomed.Eng Online*. 2003; **2**: 1.
155. Oppenheim, A. V. and Schaffer, R. W. Discrete-time signal processing. Prentice Hall Inc. 1989.
156. Durka, P. J. Matching pursuit and unification in EEG analysis. Artech house Inc. 2007.
157. Gyaw TA, Ray SR. The wavelet transform as a tool for recognition of biosignals. *Biomed.Sci.Instrum*. 1994; **30**: 63-68.
158. Mallat, S. Wavelet tour of signal processing. 1999.
159. Mallat, S. A theory for multiresolution signal decomposition: The wavelet representation. *IEEE Trans.Pattern Analysis and machine intelligence* 11, 674-693. 1989.
160. Mallat, S. and Zhang, Z. Matching pursuit with time-frequency dictionaries. *IEEE Transactions on Signal Processing* 41, 3397-3415. 1993.
161. Blinowska KJ, Durka PJ, Zygierewicz J. Time-frequency analysis of brain electrical activity--adaptive approximations. *Methods Inf.Med*. 2004; **43**: 70-73.
162. Gratkowski M, Haueisen J, Arendt-Nielsen L, Cn CA, Zanow F. Decomposition of biomedical signals in spatial and time-frequency modes. *Methods Inf.Med*. 2008; **47**: 26-37.
163. Akay M, Akay YM, Cheng P, Szeto HH. Time-frequency analysis of the electrocortical activity during maturation using wavelet transform. *Biol.Cybern*. 1994; **71**: 169-176.
164. Schiff SJ, Aldroubi A, Unser M, Sato S. Fast wavelet transformation of EEG. *Electroencephalogr.Clin.Neurophysiol*. 1994; **91**: 442-455.
165. Akin M. Comparison of wavelet transform and FFT methods in the analysis of EEG signals. *J.Med.Syst*. 2002; **26**: 241-247.
166. Storti SF, Formaggio E, Beltramello A, Fiaschi A, Manganotti P. Wavelet analysis as a tool for investigating movement-related cortical oscillations in EEG-fMRI coregistration. *Brain Topogr*. 2010; **23**: 46-57.
167. Tallon-Baudry C, Bertrand O, Delpuech C, Permier J. Oscillatory gamma-band (30-70 Hz) activity induced by a visual search task in humans. *J.Neurosci*. 1997; **17**: 722-734.
168. Olesen SR, Graversen C, Hansen TM, Blauenfeldt RA, Hansen JB, Steimle K, Drewes AR. Spectral and dynamic electroencephalogram abnormalities are correlated to psychometric test performance in hepatic encephalopathy. *Scand.J.Gastroenterol*. 2011; **46**: 988-996.
169. Jensen, A. and la Cour-Harbo, A. Ripples in mathematics. Springer-Verlag Berlin Heidelberg . 2001.
170. Durka PJ, Matysiak A, Montes EM, Sosa PV, Blinowska KJ. Multichannel matching pursuit and EEG inverse solutions. *J.Neurosci.Methods* 2005; **148**: 49-59.
171. Sieluzycycki C, Konig R, Matysiak A, Kus R, Ircha D, Durka PJ. Single-trial evoked brain responses modeled by multivariate matching pursuit. *IEEE Trans.Biomed.Eng* 2009; **56**: 74-82.
172. Schmidt GN, Scharein E, Siegel M, Muller J, Debener S, Nitzschke R, Engel A, Bischoff P. Identification of sensory blockade by somatosensory and pain-induced evoked potentials. *Anesthesiology* 2007; **106**: 707-714.

173. Lotte F, Congedo M, Lecuyer A, Lamarche F, Arnaldi B. A review of classification algorithms for EEG-based brain-computer interfaces. *J.Neural Eng* 2007; **4**: R1-R13.
174. Duda, R. O, Hart, P. E., and Stork, D. G. Pattern recognition, second edition. 2001. WILEY-INTERSCIENCE.
175. Fukunaga, K. Statistical pattern recognition, second edition. 1990. ACADEMIC PRESS, INC.
176. Hiraiwa A, Shimohara K, Tokunaga Y. EEG topography recognition by neural networks. *IEEE Eng Med.Biol.Mag.* 1990; **9**: 39-42.
177. Bishop, C. M. Neural networks for pattern recognition. 1996. Oxford University Press.
178. Tavakolian, K. and Rezaei, S. Classification of mental tasks using gaussian mixture bayesian network classifiers. 2004. In Proceedings of the IEEE International workshop on Biomedical Circuits and Systems.
179. Solhjoo, S., Nasrabadi, A. M., and Golpayegani, M. R. H. Classification of chaotic signals using hmm classifiers: EEG-based mental task classification. 2005. In Proceedings of the European Signal Processing Conference.
180. Blankertz, B, Curio, G., and Müller, K. R. Classifying single trial EEG: Towards brain computer interfacing. 14, 157-164. 2002. Advances in Neural Information Processing Systems (NIPS 01).
181. Cincotti, F., Scipione, A., Tiniperi, A., Mattia, D., Marciiani, M. G., Millan, J. d. R., Salinari, S., Bianchi, L., and Babiloni, F. Comparison of different feature classifiers for brain computer interfaces. 2003. In Proceedings of the 1st International IEEE EMBS Conference on Neural Engineering.
182. Burges, C. J. C. A tutorial on support vector machines for pattern recognition. 2. 1998. Knowledge discovery and data mining.
183. Gunn, S. R. Support vector machines for classification and regression. 1998. University of southampton, Faculty of Engineering, Science and Mathematics, School of Electronics and Computer Science.
184. Cristianini, N. and Shawe-Taylor, J. Support vector machines and other kernel-based learning methods. 2010. University Press, Cambridge.
185. Smola, A. J. and Schölkopf, B. A tutorial on support vector regression. 1998. Produced as part of the ESPRIT Working Group in Neural and Computational Learning II, NeuroCOLT2 27150.
186. Renfrew M, Cheng R, Daly JJ, Cavusoglu M. Comparison of filtering and classification techniques of electroencephalography for brain-computer interface. *Conf.Proc.IEEE Eng Med.Biol.Soc.* 2008; **2008**: 2634-2637.
187. Krusienski DJ, Sellers EW, Cabestaing F, Bayoudh S, McFarland DJ, Vaughan TM, Wolpaw JR. A comparison of classification techniques for the P300 Speller. *J.Neural Eng* 2006; **3**: 299-305.
188. Vapnik, V and Lerner, A. Pattern recognition using generalized portrait method. 24. 1963. Automation and Remote Control.
189. Cortes, C. and Vapnik, V. Support vector networks. 20, 273-297. 1995. M. Learning.

190. Boser, B. E., Guyon, I. M., and Vapnik, V. A training algorithm for optimal margin classifiers. 1992. Fifth Annual Workshop on Computational Learning Theory, Pittsburgh.
191. Aizerman, M. A., Braverman, E. M., and Rozoner, L. I. Theoretical foundations of the potential function method in pattern recognition learning. 821-837. 1964. Automation and Remote Control.
192. Garrett D, Peterson DA, Anderson CW, Thaut MH. Comparison of linear, nonlinear, and feature selection methods for EEG signal classification. *IEEE Trans.Neural Syst.Rehabil.Eng* 2003; **11**: 141-144.
193. Vapnik, V. The nature of statistical learning theory. 1995. Springer, N.Y.
194. Fruitet J, McFarland DJ, Wolpaw JR. A comparison of regression techniques for a two-dimensional sensorimotor rhythm-based brain-computer interface. *J.Neural Eng* 2010; **7**: 16003.
195. Klem GH, Luders HO, Jasper HH, Elger C. The ten-twenty electrode system of the International Federation. The International Federation of Clinical Neurophysiology. *Electroencephalogr.Clin.Neurophysiol.Suppl* 1999; **52**: 3-6.
196. Frokjaer JB, Softeland E, Graversen C, Dimcevski G, Egsgaard LL, Arendt-Nielsen L, Drewes AM. Central processing of gut pain in diabetic patients with gastrointestinal symptoms. *Diabetes Care* 2009; **32**: 1274-1277.
197. Softeland, E., Dimcevski, G., Graversen, C., Nedrebø, B. G., Drewes, A. M., and Frokjaer, J. B. Effects of Isolated Hyperinsulinaemia on sensory Function in healthy adults. 2011. Experimental and clinical endocrinology & diabetes.
198. Friebel U, Eickhoff SB, Lotze M. Coordinate-based meta-analysis of experimentally induced and chronic persistent neuropathic pain. *Neuroimage*. 2011.
199. Qin L, Ding L, He B. Motor imagery classification by means of source analysis for brain-computer interface applications. *J.Neural Eng* 2004; **1**: 135-141.
200. Kamousi B, Liu Z, He B. Classification of motor imagery tasks for brain-computer interface applications by means of two equivalent dipoles analysis. *IEEE Trans.Neural Syst.Rehabil.Eng* 2005; **13**: 166-171.
201. Congedo M, Lotte F, Lecuyer A. Classification of movement intention by spatially filtered electromagnetic inverse solutions. *Phys.Med.Biol.* 2006; **51**: 1971-1989.