



Aalborg Universitet

AALBORG UNIVERSITY  
DENMARK

## Development of Next Generation micro-CHP System

*Based on High Temperature Proton Exchange Membrane Fuel Cell Technology*

Arsalis, Alexandros

*Publication date:*  
2012

*Document Version*  
Publisher's PDF, also known as Version of record

[Link to publication from Aalborg University](#)

*Citation for published version (APA):*

Arsalis, A. (2012). *Development of Next Generation micro-CHP System: Based on High Temperature Proton Exchange Membrane Fuel Cell Technology*. Department of Energy Technology, Aalborg University.

### General rights

Copyright and moral rights for the publications made accessible in the public portal are retained by the authors and/or other copyright owners and it is a condition of accessing publications that users recognise and abide by the legal requirements associated with these rights.

- Users may download and print one copy of any publication from the public portal for the purpose of private study or research.
- You may not further distribute the material or use it for any profit-making activity or commercial gain
- You may freely distribute the URL identifying the publication in the public portal -

### Take down policy

If you believe that this document breaches copyright please contact us at [vbn@aub.aau.dk](mailto:vbn@aub.aau.dk) providing details, and we will remove access to the work immediately and investigate your claim.

# **Development of Next Generation micro-CHP System**

**Based on High Temperature Proton Exchange  
Membrane Fuel Cell Technology**

**Alexandros Arsalis**

Dissertation submitted to the Faculty of  
Engineering and Science, Aalborg University  
in partial fulfillment of the requirements for the degree of

DOCTOR OF PHILOSOPHY

in

Mechanical Engineering

Department of Energy Technology  
Aalborg University  
2011

Development of Next Generation micro-CHP System: Based on High Temperature Proton Exchange Membrane Fuel Cell Technology

Alexandros Arsalis © 2011

All rights reserved. No part of the material protected by this copyright notice may be reproduced or utilized in any form or by any means, electronic or mechanical, including photocopying, recording or by any information storage and retrieval system, without the prior permission of the author.

Printed in Denmark by UniPrint, 2012

First print, January 2012

ISBN 978-87-92846-03-7

## Development of Next Generation micro-CHP System

### Abstract

Novel proposals for the modeling and operation of a micro-CHP (combined-heat-and-power) residential system based on HT-PEMFC (High Temperature-Proton Exchange Membrane Fuel Cell) technology are described and analyzed to investigate the technical feasibility of such systems. The proposed systems must provide electricity, hot water, and space heating for an average single-family household in Denmark. A complete fuel processing subsystem, with all necessary BOP (balance-of-plant) components, is modeled and coupled to the fuel cell stack subsystem. The research project is divided into five main study topics: (a) Modeling, simulation and validation of the system in LabVIEW™ environment to provide the ability of Data Acquisition of actual components, and thereby more realistic design in the future; (b) Modeling, parametric study, and sensitivity analysis of the system in EES (Engineering Equation Solver). The parametric study is conducted to determine the most viable system/component design based on maximizing total system efficiency; (c) An improved operational strategy is formulated and applied in an attempt to minimize operational implications, experienced when using conventional operational strategies; (d) Application of a GA (Genetic Algorithm) optimization strategy. The objective function of the single-objective optimization strategy is the net electrical efficiency of the micro-CHP system. The implemented optimization procedure attempts to maximize the objective function by variation of nine decision variables; (e) The micro-CHP system is optimized by formulating and applying a process integration methodology. The methodology involves system optimization targeting in net electrical efficiency maximization. Subsequently a MINLP (Mixed Integer Non-Linear Programming) problem optimization strategy is applied to minimize the annual cost of the HEN (Heat Exchanger Network). The results obtained throughout this research work indicate the high potential of the proposed micro-CHP system, since net electrical efficiencies of up to 44% were reached, which are far and away higher than heat engine-based systems. Another interesting aspect is the simplicity of the system's fuel processing subsystem, which makes it more competitive, in terms of commercialization prospects, than other fuel cell-based micro-CHP systems.



*Keywords:* Fuel cell, PEMFC, PBI, Micro-CHP system, Combined-heat-and-power, Optimization, Pinch analysis, Process integration, Fuel processing, Operational strategy

*Author's address:* Alexandros Arsalis, Aalborg University, Department of Energy Technology, Pontoppidanstræde 101, DK-9220 Aalborg Ø., Denmark

*E-mail:* aar@et.aau.dk

*Supervisors:* Associate Professor Mads Pagh Nielsen, Department of Energy Technology, Aalborg University, Aalborg Ø., Denmark (primary)

Professor Søren Knudsen Kær, Department of Energy Technology, Aalborg University, Aalborg Ø., Denmark (secondary)

*Thesis assessment committee:* Associate Professor Thomas Condra, Department of Energy Technology, Aalborg University, Aalborg Ø., Denmark (chairman)

Professor Per Alvfors, Department of Chemical Engineering and Technology, Division of Energy, KTH-Royal Institute of Technology, Stockholm, Sweden

Dr. Jeppe Grue, Vattenfall A/S Heat Nordic, Aalborg, Denmark

*Research program:* Mechanical Engineering



# Contents

<b>List of Publications</b>	<b>9</b>
Papers included in the thesis	9
Relevant papers not included in the thesis	10
<b>Acknowledgements</b>	<b>11</b>
<b>Abbreviations</b>	<b>13</b>
<b>1 Introduction</b>	<b>15</b>
1.1 Literature Review	15
1.1.1 Fuel Cell Fundamentals	15
1.1.2 Proton Exchange Membrane Fuel Cells	16
1.1.3 High Temperature PEMFC	18
1.1.4 Comparison of Fuel Cell Technologies	19
1.1.5 Combined Heat and Power	20
1.1.6 Micro-CHP Technology	21
1.1.7 Micro-CHP Classification based on the Conversion Process	23
1.2 Comparison Analysis Between the Proposed micro-CHP System and a Centralized CCGT Power Plant/Heater Combination	27
1.2.1 Efficiency	28
1.2.2 Environmental Considerations	29
1.2.3 Cost	30
1.3 Background and Motivation	30
1.4 Definition of the Research Question	31
1.5 Objectives of the Research Project	31
<b>2 Overview of Research Methodologies</b>	<b>35</b>
2.1 Design of Stationary Fuel Cell Systems	35
2.2 Modeling of Stationary Fuel Cell-based CHP Systems	36
2.2.1 Fuel Processing Subsystem	37
2.2.2 Fuel Cell Subsystem	40
2.2.3 Thermal Management Subsystem	41
<b>3 Description of Publications</b>	<b>43</b>
3.1 Paper I	43
3.2 Paper II	43
3.3 Paper III	44
3.4 Paper IV	45



3.5	Paper V	46
3.6	Overall Evolution of the Configuration Topology	48
<b>4</b>	<b>Summary of Principal Results and Discussion</b>	<b>51</b>
<b>5</b>	<b>Conclusions and Future Work</b>	<b>61</b>
5.1	Conclusions	61
5.2	Future Work	63
	<b>References</b>	<b>65</b>

# List of Publications

## Papers included in the thesis

This thesis is based on the work contained in the following five journal articles<sup>1</sup>, referred to by Roman numerals in the text:

- I Arsalis, A., Nielsen, M.P. & Kær, S.K. (2011). Modeling and off-design performance of a 1 kW<sub>e</sub> HT-PEMFC (high temperature-proton exchange membrane fuel cell)-based residential micro-CHP (combined-heat-and-power) system for Danish single-family households. *Energy* 36(2), 993-1002.
- II Arsalis, A., Nielsen, M.P. & Kær, S.K. (2011). Modeling and parametric study of a 1 kW<sub>e</sub> HT-PEMFC-based residential micro-CHP system. *International Journal of Hydrogen Energy* 36(8), 5010-5020.
- III Arsalis, A., Nielsen, M.P. & Kær, S.K. (2012). Application of an improved operational strategy for a high temperature-proton exchange membrane fuel cell-based micro-combined heat and power system for Danish single-family households. *Energy*. (submitted)
- IV Arsalis, A., Nielsen, M.P. & Kær, S.K. (2012). Modeling and optimization of a 1 kW<sub>e</sub> HT-PEMFC-based micro-CHP residential system. *International Journal of Hydrogen Energy*. (in press)

---

1. Every research study topic matches exactly with every corresponding journal article publication. Therefore the terms paper/article/study topic are used interchangeably throughout this thesis work.

- V Arsalis, A., Nielsen, M.P. & Kær, S.K. (2012). Optimization of a high temperature PEMFC-based micro-CHP system by formulation and application of a process integration methodology. *Energy Conversion and Management*. (submitted)

Articles I and II are reproduced with the permission of the publishers.

### Relevant papers not included in the thesis

- VI Arsalis, A., Nielsen, M.P. & Kær, S.K. (2009). Modeling and simulation of a residential micro-CHP system based on HT-PEMFC technology. EFC09-17045. In *European Fuel Cell Technology & Applications - "Piero Lunghi Conference"*. Rome, Italy, December 15-18.

## Acknowledgements

This PhD research project was supported by Danish companies Dantherm Power and Danfoss. It was also co-funded by the HyFC (Hydrogen Fuel Cell Academy) and Aalborg University.

Thanks to my academic supervisors Mads Pagh Nielsen and Søren Knudsen Kær for providing valuable advice, comments and suggestions throughout the research study.

Special thanks go to Anders Korsgaard for providing simulation models in the initial stages of the project, and also prompt feedback, when needed, throughout the project.

I would also like to thank my colleagues at the Fuel Cell Research Program for exchanging fruitful ideas on the research project.

Finally, I am indebted to my family who has helped me, while I devoted time and energy to this research work.

Alexandros Arsalis  
Aalborg  
October 2011



## Abbreviations

AFC	Alkaline Fuel Cell
BOP	Balance-of-Plant
CHP	Combined Heat and Power
EES	Engineering Equation Solver
GA	Genetic Algorithm
GAMS	General Algebraic Modeling System
HEN	Heat Exchanger Network
HHV	Higher Heating Value
HT	High Temperature
ICE	Internal Combustion Engine
IRR	Internal Rate of Return
LHV	Lower Heating Value
LT	Low Temperature
MCFC	Molten Carbonate Fuel Cell
MEA	Membrane Electrode Assembly
MINLP	Mixed Integer Non-Linear Programming
PAFC	Phosphoric Acid Fuel Cell
PBI	Polybenzimidazole
PEMFC	Polymer Electrolyte Membrane Fuel Cell
RC	Rankine Cycle
RE	Reciprocating Engine
RH	Relative Humidity
SC	Steam-to-Carbon ratio
SE	Stirling Engine
SMR	Steam Methane Reformer
SOFC	Solid Oxide Fuel Cell
VI	Virtual Instrument
WGS	Water Gas Shift



# 1 Introduction

This chapter presents an overall literature review on the fuel cell and micro-CHP technologies. Further on, the background and motivation for the research study are explained, and the project objectives are outlined. Finally, the research question is posed and analyzed.

## 1.1 Literature Review

Starting from the general field of fuel cell technology and combined heat and power (CHP), the literature review is narrowed down to the PEMFC (Proton Exchange Membrane Fuel Cell) type, and more specifically to the PBI type. In addition, CHP technology is analyzed and broken down to small-scale residential micro-CHP technology. The different types of micro-CHP systems are described to indicate their advantages and disadvantages. Finally an overview of the implications and prospective of micro-cogeneration technology is given.

### 1.1.1 Fuel Cell Fundamentals

Fuel cell technology is based on the principle of direct electrochemical energy conversion (Barbir, 2005; Larminie & Dicks, 2003; Mench, 2008; O'Hayre, Colella, Cha, & Prinz, 2009). In other words, fuel cells are not heat engines since no combustion takes place. Also, chemical energy input is converted to electrical energy, without the intermediate step of mechanical energy production, as in heat engines. In terms of electrochemistry, fuel cells are also related to batteries, but the difference is that fuel cells are not depleted as batteries. Figure 1 illustrates the operating principle of fuel cell technology. Two electrodes exist in a fuel cell arrangement, namely cathode and anode, which are separated by the electrolyte. The oxidant and the fuel enter the fuel cell stack through the cathode and the anode, respectively. The fuel cell



reaction typically produces water, which is at a higher temperature than the reactants. More importantly, this exothermic reaction is also associated with the production of electricity with an external load between the two electrodes. Fuel cell performance is assessed with the aid of voltage-current curves (polarization curves), plotted for different loads. These curves can also illustrate the overpotentials (losses), which are divided between activation, ohmic and concentration losses.

The five main fuel cell types are distinguished by their electrolyte material and they are the following: (a) Polymer Electrolyte Membrane Fuel Cell (PEMFC) (b) Phosphoric Acid Fuel Cell (PAFC), (c) Alkaline Fuel Cell (AFC), (d) Molten Carbonate Fuel Cell (MCFC), (e) Solid Oxide Fuel Cell (SOFC). Every fuel cell type has some distinctive characteristics in terms of operational temperature, pressure, fuel intake and tolerance, building materials (electrolyte, catalyst, cell components), and performance. These characteristics result in advantages or disadvantages, depending on the application, as it will be shown in the following sections. A summary of these characteristics is given in Table 1.

**Table 1** Description of major fuel cell types.

	PEMFC	PAFC	AFC	MCFC	SOFC
Electrolyte	Polymer membrane	Liquid H <sub>3</sub> PO <sub>4</sub>	Liquid KOH	Molten carbonate	Ceramic
Mobile ion	H <sup>+</sup>	H <sup>+</sup>	OH <sup>-</sup>	CO <sub>3</sub> <sup>2-</sup>	O <sup>2-</sup>
Operating temperature	60-200°C	205°C	65-220°C	650°C	600-1000°C
Catalyst	Platinum	Platinum	Platinum	Nickel	Nickel
Cell components	Carbon -based	Carbon -based	Carbon- based	Stainless-based	Ceramic-based
Fuel intake	H <sub>2</sub> , CH <sub>3</sub> OH	H <sub>2</sub>	H <sub>2</sub>	H <sub>2</sub> , CH <sub>4</sub>	H <sub>2</sub> , CO, CH <sub>4</sub>

### 1.1.2 Proton Exchange Membrane Fuel Cells<sup>2</sup>

The following electrochemical half reactions in the PEMFC occur simultaneously in the two electrically conductive electrodes,

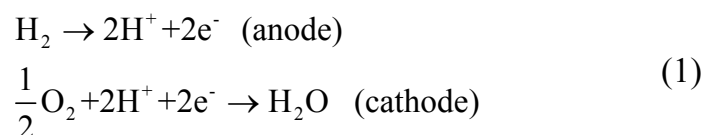

The most common material for the polymer membrane of the ionically conductive material is Nafion<sup>TM</sup> (Barbir, 2005). The membrane must be thin,

---

2. This section refers primarily to “conventional” Nafion-based PEMFCs.

flexible and coated with a platinum-based catalyst, while the electrode support material must be a porous carbon. The total assembly is a sandwich structure, namely the Membrane Electrode Assembly (MEA), connecting the anode-catalyst-membrane-catalyst-cathode components. The fuel cell operating temperature for Nafion<sup>TM</sup>-based fuel cell stacks cannot exceed 90°C, because the membrane requires continuous hydration to maintain its conductivity capabilities. Therefore a rigorous water management is required throughout the operation.

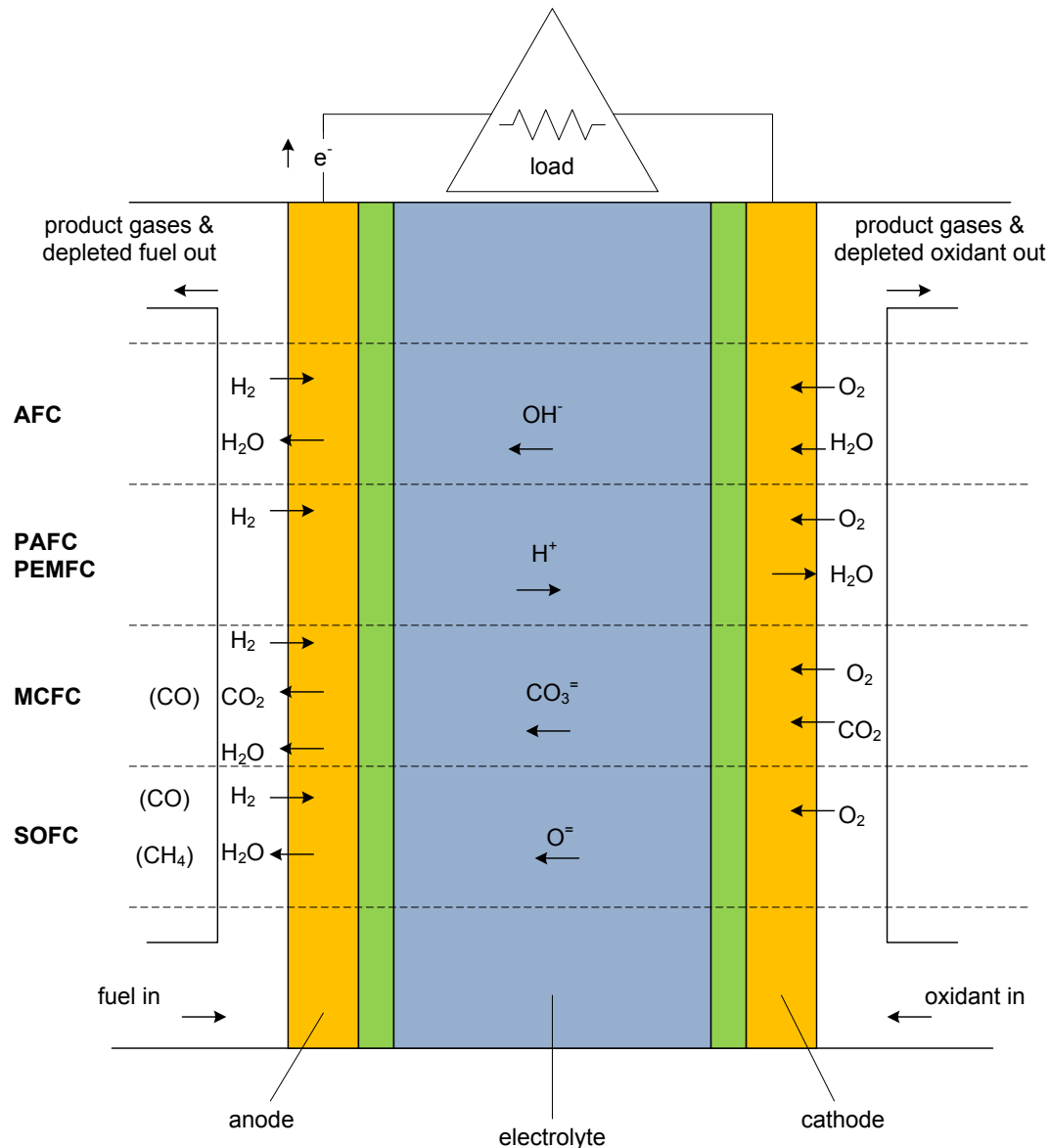

**Figure 1** Schematic of the operating principle for different fuel cell types [based on the description found in (Barbir, 2005)].

To maintain operation within this low temperature range only platinum-based catalysts and polymer membranes can be used. This means that the building

cost of this fuel cell technology will remain high. On the other hand, power densities are higher than other fuel cell types, ranging from 300 to 1000 mW/cm<sup>2</sup> (O'Hayre et al., 2009). Further on, on-off operations and start-ups are also faster than other fuel cell technologies (e.g., SOFC). For these reasons, PEMFC is the primary fuel cell technology for vehicular and portable applications (<1 kW<sub>e</sub>) (Mench, 2008). In addition, due to their high sensitivity and low tolerance to sulfur and carbon monoxide, hydrogen is usually preferred as the system fuel, although effort has been made to use other more convenient fuelling options, such as methanol. Usage of fossil fuels, such as natural gas, can add a further cost burden to the fuel cell system's capital cost, because more complicated fuel processing will be required.

### 1.1.3 High Temperature PEMFC

The previous section discussed the implications encountered when operating Nafion<sup>TM</sup>-based PEMFCs. The disadvantage of operating near the two-phase region can be alleviated with the utilization of a phosphoric acid doped polybenzimidazole (PBI) material (see Figure 2 and Figure 3). This material is doped with a strong acid, such as H<sub>3</sub>PO<sub>4</sub>, to create an ionic conductivity. This material allows operation between 120 to 200°C (Büchi, Inaba, & Schmidt, 2009; O'Hayre et al., 2009; Jianlu Zhang et al., 2006), and therefore no membrane hydration is required, leading to a relaxation of the water management requirements. More importantly the performance of the PBI membrane, in terms of conductivity, remains comparable to the one for Nafion<sup>TM</sup> membranes.



**Figure 2** High temperature PEMFC stacks from Serenergy (Serenergy, 2011).

The high operational temperature contributes in higher tolerances to sulfur and carbon monoxide, and also yields a higher quality exhaust mixture out of the fuel cell stack. Moreover PBI membranes offer increased mechanical strength, lower building costs, and thermal stability (Jianlu Zhang et al., 2006).

On the other hand, several disadvantages are associated with PBI membranes. The most significant ones include slow kinetics of the oxidant reduction reaction, membrane oxidative degeneration, challenging electrocatalyst ink catalyst blending with the PBI material, and durability issues in relation to acid-leaching (O'Hayre et al., 2009).

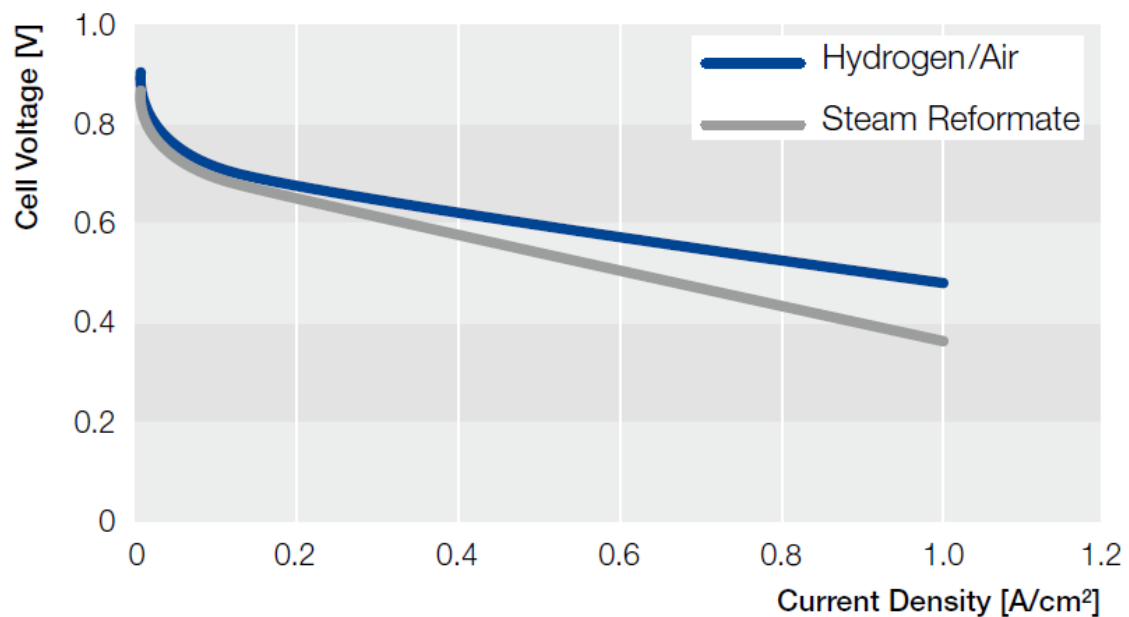

**Figure 3** HT-PEMFC MEA performance polarization curve (Stolten, 2010).

#### 1.1.4 Comparison of Fuel Cell Technologies

PAFC- and MCFC-based systems are generally applicable for larger-scale applications (e.g. 200 kWe systems) and therefore they are not suitable for micro-CHP system applications (Barbir, 2005; Barclay, 2006; Larminie & Dicks, 2003; O'Hayre et al., 2009). In particular PAFC technology is a mature technology, with proven reliability/long-term performance and low-cost electrolytes (O'Hayre et al., 2009). On the other hand, it requires expensive platinum catalysts, is susceptible to carbon dioxide and sulfur poisoning, and the electrolyte is a corrosive liquid that must be replenished during operation (O'Hayre et al., 2009). In addition, PAFC technology has reached a certain level of limitation, in regards to research improvement as indicated in the literature (Larminie & Dicks, 2003). MCFC technology requires very careful operation and complex BOP components (O'Hayre et al., 2009), including CO<sub>2</sub> recycling, corrosive molten electrolytes, and relatively expensive

materials. Also, degradation and lifetime issues have been reported in the literature (O'Hayre et al., 2009).

SOFC is a promising fuel cell technology (Zink et al., 2007) and therefore still under development. Nevertheless, current SOFC-based systems have several disadvantages, as compared to HT-PEMFC technology. These include slower start-up times (due to their higher operational temperature), need for air and fuel preheaters and more complex cooling systems (Larminie & Dicks, 2003; O'Hayre et al., 2009). Also the need for higher temperature operation suggests greater heat losses and thereby more expensive insulation is required. Finally, it requires pressurization of fuel and air, which suggests greater BOP component (e.g. air compressor) power losses. On the other hand, SOFC-based systems allow the use of carbon monoxide content in the reformat gas as fuel, with the use of an internal reforming process (without the need of a separate unit) (Arsalis, 2007; Calise, Dentice d'Accadia, Palombo, et al., 2006), which suggests a significant advantage over other fuel cell technologies. Also the high reaction rates achievable by the SOFC technology allow the use of cheaper catalysts and thereby reducing their capital cost (Larminie & Dicks, 2003).

#### 1.1.5 Combined Heat and Power

The conventional method of covering electrical, heating (e.g. hot water) and cooling (e.g. space cooling) load demands is by purchasing electricity from the electricity network grid and with a fossil fuel-fired boiler. A different method of covering these loads is combined-heat-and-power (CHP) (or cogeneration), which can aid in the reduction of running (fuel) costs and in effect increase the total efficiency. Therefore, CHP is defined as the combined generation of electrical power and heat from a single chemical energy source.

The useful recovery of the biggest portion of waste heat can increase the system efficiency from 30-40%, up to 75-90%, depending on the application and the size of the system. In addition to the efficiency increase, CHP can also lead in the reduction of emissions, since a smaller amount of fuel is required. Therefore CHP is the preferred choice of generating electricity and heat, provided the capital cost is within viable limits in terms of lifetime and payback time.

Cogeneration systems can be distinguished into two main configurations. The first configuration is the production of a high temperature fluid product, which can be used to generate electricity (e.g. gas turbine), while the exhausted heat is at a low temperature and can be used throughout several thermal processes for district heating purposes, or in some cases for additional production of electricity (Arsalis, 2008). Alternatively, the high temperature

fluid product (e.g. from a waste-to-energy power plant) can be used in a heat recovery steam generator to produce superheated steam for a Rankine cycle (steam turbine) process. In some cases it is also possible to use the hot gases directly into a Brayton cycle (gas turbine), without the need of a heat recovery boiler.

#### 1.1.6 Micro-CHP Technology

For the purposes of this research study, micro-CHP (Dentice d'Accadia, Sasso, Sibilio, & Vanoli, 2003; Ferguson, 2004; Gunes & Ellis, 2003; Hawkes & Leach, 2005a, 2005b, 2007, 2008, 2009; Hawkes et al., 2007, 2006; Hubert, Achard, & Metkemeijer, 2006; Pehnt et al., 2006) is defined as the simultaneous production of electricity and heat in a residential application for systems up to 5 kW<sub>e</sub>. Micro-CHP systems typically have (or expected to have) a lifetime of ten to twenty years, which is comparatively lower than large-scale CHP systems. They are designed to exhibit minimum total efficiencies of 75%. In order for these systems to make a breakthrough to the power and heat market, many requirements should be satisfied. The main requirements are (a) low cost, (b) compact volume and size, (c) easy installation and (d) automated operation without demanding routine maintenance checks.

Depending on the load profile, an appropriate heat-to-power ratio must be selected based on the demand. For example, a system with a high heat-to-power ratio will be inappropriate for a household requiring a high electrical load. Nowadays, most newly-built households have efficient insulation and are more 'electricity-demanding' than 'heat-demanding', as compared to the past. Therefore, in general, even lower heat-to-power ratios will be required in the future. Also the production of additional heat, if needed, can be provided by condensing gas-fired boilers, which have become very efficient in recent years, with efficiencies near or above 90% (Hawkes & Leach, 2005a). Therefore, focus is primarily given on systems exhibiting high electrical efficiencies, rather than thermal efficiencies.

For the better utilization and distribution of power and heat, micro-CHP systems must be grid-interconnected, although micro-CHP systems can also operate in a stand-alone (island) mode. The reason for grid-interconnection is that a stand-alone micro-CHP system will be required to operate continuously within an electricity-led operational strategy. As a consequence of this practice, large amounts of heat will have to be vented to the atmosphere. Otherwise a thermal storage tank of massive dimensions will be required, which is inappropriate and unacceptable for a residential design. Another consequence is also the rate of heat loss, which increases with the increasing size of the

thermal storage tank<sup>3</sup>. In addition, the benefit of importing cheap electricity (e.g. from wind power) from the network grid will not be utilized. It should be noted though, that import/export of electricity should be minimized in order for the application to conserve its on-site power generation/consumption characteristics. On-site power generation minimizes transmission losses, which can have an even greater factor if the power transmitted has a high purchase cost.

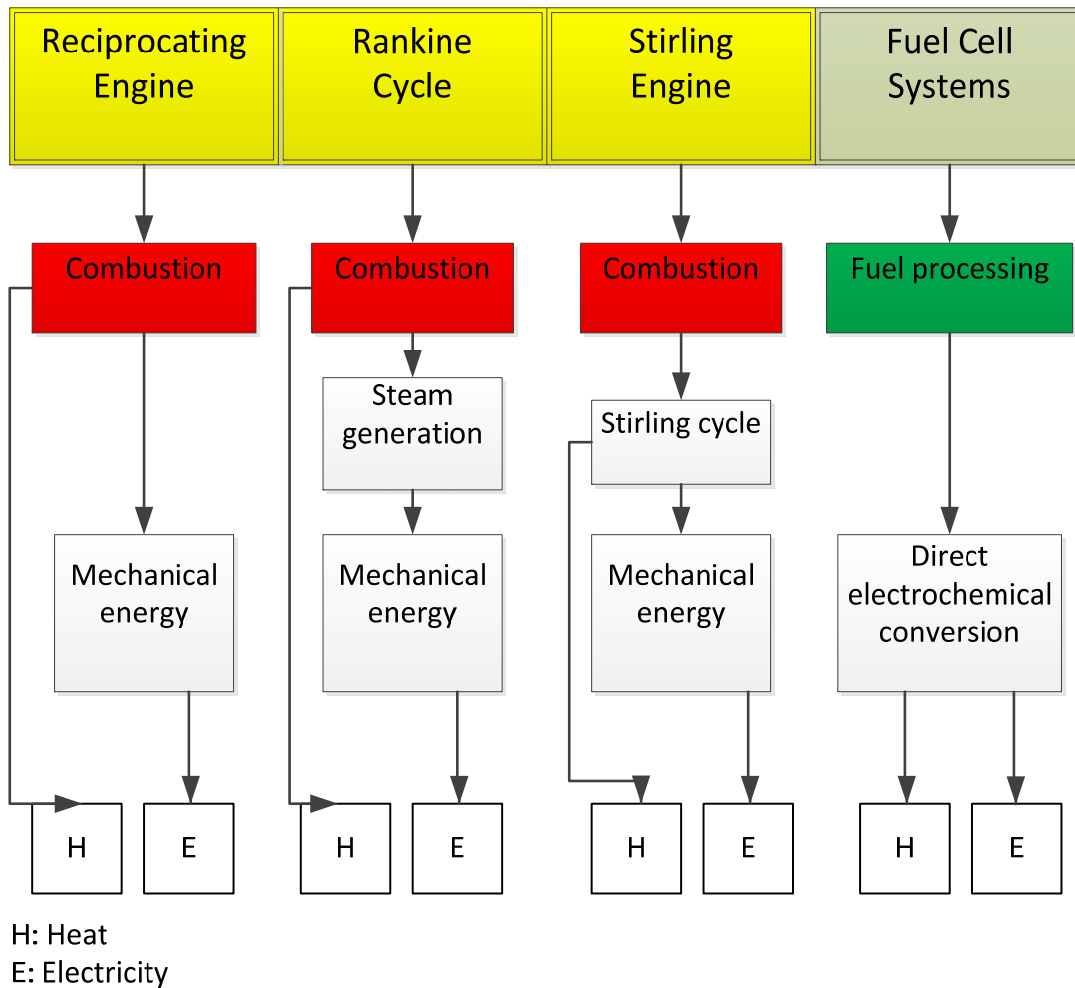

**Figure 4** Classification of micro-CHP technologies based on the conversion process.

Japan has been the leading market for micro-cogeneration in the last decade, but recently a rapid growth of the technology has also been observed in Europe. An increase in the sales of micro-CHP systems by around 25%, between 2009 and 2010, suggests that the market will grow even at higher proportions in the near future. 20,000 to 70,000 micro-CHP units are expected to be sold by 2015 (Brown, 2011).

3. Although theoretically all the heat can be recovered to cover the space heating and hot water loads, it should be noted that a realistic system will not be able to completely recover this heat.

### 1.1.7 Micro-CHP Classification based on the Conversion Process

The conversion process of a micro-CHP system can be based on fuel-air combustion or direct electrochemical conversion (Pehnt et al., 2006). The classification of micro-CHP systems in regards to their conversion process is shown in Figure 4. Combustion-based systems combust the fuel-air mixture at a high temperature and eventually mechanical energy is produced. The mechanical energy is then used to drive an electric generator and produce electrical energy. Combustion-based micro-CHP systems are based on various thermodynamic cycles, including reciprocating engines (Otto cycle), steam engines (Rankine cycle) and Stirling engines (Stirling cycle). Alternatively, the conversion process can be based on direct electrochemical conversion from chemical energy to electrical energy (i.e. fuel cell technology). As indicated in the previous section, in addition to the production of electrical energy, the conversion process also results in the production of heat, which can be recovered as needed. The status of the different technologies is discussed in the following subsections and summarized in Table 2.

#### *Reciprocating Engines*

A reciprocating engine (RE) based on a spark-ignited, internal combustion piston-cylinder engine operates on the Otto thermodynamic cycle, which includes four consecutive processes: (a) isochoric, (b) isentropic expansion, (c) isochoric, and (d) isentropic compression.

The performance of current RE-based micro-CHP systems is the most promising, as compared to other heat engine-based micro-CHP systems. This technology is also the most mature in the micro-cogeneration market, since a range of different systems have been commercially available in the last decade (Pehnt et al., 2006). Vaillant/Honda has reported electrical and total efficiencies of 26.3% and 92%, respectively, for their ecoPOWER 1 kW<sub>e</sub> unit (Energy Efficiency News, 2011; Vaillant, 2011). Japanese company Yanmar has also developed an ICE unit with an electrical power output of 5 kW<sub>e</sub> (Dijkstra, 2010). Finally, BAXI has developed a 5.5 kW<sub>e</sub> system (SenerTec Dachs) with an electrical and total efficiencies ranging at 28 and 88-91% (BAXI, 2011a; Thomas, 2008), respectively.

#### *Rankine Cycle*

A Rankine cycle-based (RC) engine is based on a thermodynamic cycle consisting of four consecutive ideal processes: (a) isobaric, (b) isentropic, (c) isobaric, and (d) isentropic. The liquid water is heated (typically with a boiler) until superheated steam is produced. The superheated steam is then used to



drive a steam expander, producing mechanical energy. The mechanical energy is then converted to electrical energy by means of an electric generator.

In 2006, German company OTAG developed a 3 kW<sub>e</sub> unit (Slowe, 2010), while in 2010, UK-based company Energetic Group has revealed a 1 kW<sub>e</sub> unit, ‘Kingston’, which is expected to have an electrical efficiency at around 10% (Energetix Group, 2010).

**Table 2** Competing micro-CHP technologies: Status and performance summary.

Company	Type	$\eta_{el,net}$ (%)	$\eta_{tot}$ (%)	Market status
Vaillant/Honda ecoPOWER 1.0	RE	26	92	CA
Yanmar	RE	N/A	N/A	CA
BAXI SenerTec Dachs	RE	28	88-91	CA
Energetix Kingston	RC	10	N/A	CA
OTAG	RC	N/A	N/A	CA
BAXI Ecogen	SE	14	90	CA
WhisperGen	SE	10-12	90	CA
Bosch ENATEC	SE	10	N/A	CA
Stirling Denmark SM5A	SE	21	85	Demo
Hexis Galileo 1000 N	SOFC	30	90	Demo
Ceres Power	SOFC	N/A	N/A	Demo
Osaka Gas-Kyocera	SOFC	N/A	N/A	Demo
Ceramic Fuel Cells	SOFC	60	N/A	Planned
ClearEdge Power	LT-PEMFC	N/A	90	Demo
Tokyo Gas/Panasonic Ene-Farm	LT-PEMFC	40	90	Demo
BAXI Innotech GAMMA 1.0	LT-PEMFC	32	83	Demo
Plug Power	HT-PEMFC	32	90	Demo
Dantherm	HT-PEMFC	40	85-90	Demo

CA: Commercially available

### *Stirling Engines*

A Stirling engine (SE) is an external combustion engine operating on the Stirling thermodynamic cycle, which includes four consecutive processes: (a) isothermal expansion, (b) isochoric cooling, (c) isothermal compression, and (d) isochoric heating. The SE typically includes three pistons, two outer and one displacer. The latter circulates the cylinder products into the chamber, which is cooled or heated by their respective outer streams. The two outer pistons can be used to regulate the capacity of the combustion process.

The main characteristics of Stirling engines, as compared to other heat engines, include adequate part-load performances, low emission rates and low vibration and noise levels. In addition, the external combustion, closed cycle

operational nature of SE restricts the exposure of the moving parts of the engine to the products of combustion. Thereby component degradation is minimized. In addition, SEs allow greater fuel flexibility, which means that liquid or gaseous fuels, biofuels, etc. are compatible (Pehnt et al., 2006).

SE is not a mature technology in the micro-cogeneration marketplace, when compared to RE-based systems. Nevertheless, because of the advantages outlined above, the technology has attracted a significant interest in recent years. BAXI develops a 1 kW<sub>e</sub>/6 kW<sub>th</sub> unit, so-called Ecogen, which is capable of achieving electrical and total efficiencies of 14% and 90%, respectively (Gummert, 2008). WhisperGen develops a 1.2 kW<sub>e</sub>/8 kW<sub>th</sub> unit, which is capable of achieving electrical and total efficiencies of 10-12% and 90%, respectively (Pehnt et al., 2006). Bosch develops a 1 kW<sub>e</sub>/6 kW<sub>th</sub> unit, so-called ENATEC, which is capable of achieving an electrical efficiency of 10% (Beckers, 2006). Finally, Stirling Denmark has developed a larger-scale demonstration unit (9 kW<sub>e</sub>/25 kW<sub>th</sub>), which has been tested to perform electrical and total efficiencies at 21% and 85%, respectively (Thomas, 2008).

### *Fuel Cells Systems*

Fuel cell-based micro-CHP systems (see Figure 5) are either based on the PEMFC or SOFC types (Inui, Yanagisawa, & Ishida, 2003). Fuel cells are currently the least mature technology in the area of micro-CHP systems, when compared to heat engine-based applications. Nevertheless, because of their promising features, primarily low emissions and high net electrical efficiencies, these systems have attracted a lot of interest for research and development. In addition, some justification also comes from synergies with other renewable energy sources (e.g. wind power). In this sense, a PEMFC-based system is capable of providing fast regulation services to the grid responsible.

BAXI has developed a 1 kW<sub>e</sub>/1.7 kW<sub>th</sub> LT-PEMFC-based unit (Innotech GAMMA 1.0), which is capable of achieving electrical and total efficiencies of 32% and 83%, respectively (BAXI, 2011b). Korean company ClearEdge Power has been developing a 5 kW<sub>e</sub> LT-PEMFC-based unit with a total system efficiency reaching 90% (ClearEdge Power, 2011). Tokyo Gas, in association with Panasonic, has been developing a 0.75 kW<sub>e</sub> LT-PEMFC-based unit capable of achieving an electrical efficiency of 40%, while the total system efficiency is expected to reach 90% (Tokyo Gas Ltd., 2011).

Hexis has developed a 1 kW<sub>e</sub>/2 kW<sub>th</sub> SOFC-based unit (Galileo 1000 N), which is capable of achieving electrical and total efficiencies of 30% and 90%, respectively (Callux, 2009). Some other companies, namely Osaka Gas-Kyocera, Ceres Power and Ceramic Fuel Cells are also in the process of developing SOFC-based micro-CHP units (Delta Energy & Environment Ltd,

2010). In particular, Ceramic Fuel Cells is planning to develop an SOFC-based unit ( $1.5 \text{ kW}_e/0.5 \text{ kW}_{th}$ ), with a remarkable electrical efficiency reaching up to 60% (Ceramic Fuel Cells Ltd., 2010). Plug Power has developed a 5 kW<sub>e</sub> HT-PEMFC-based unit, which is capable of achieving electrical and total efficiencies close to 32% and 90%, respectively (Vogel & Tsou, 2007).

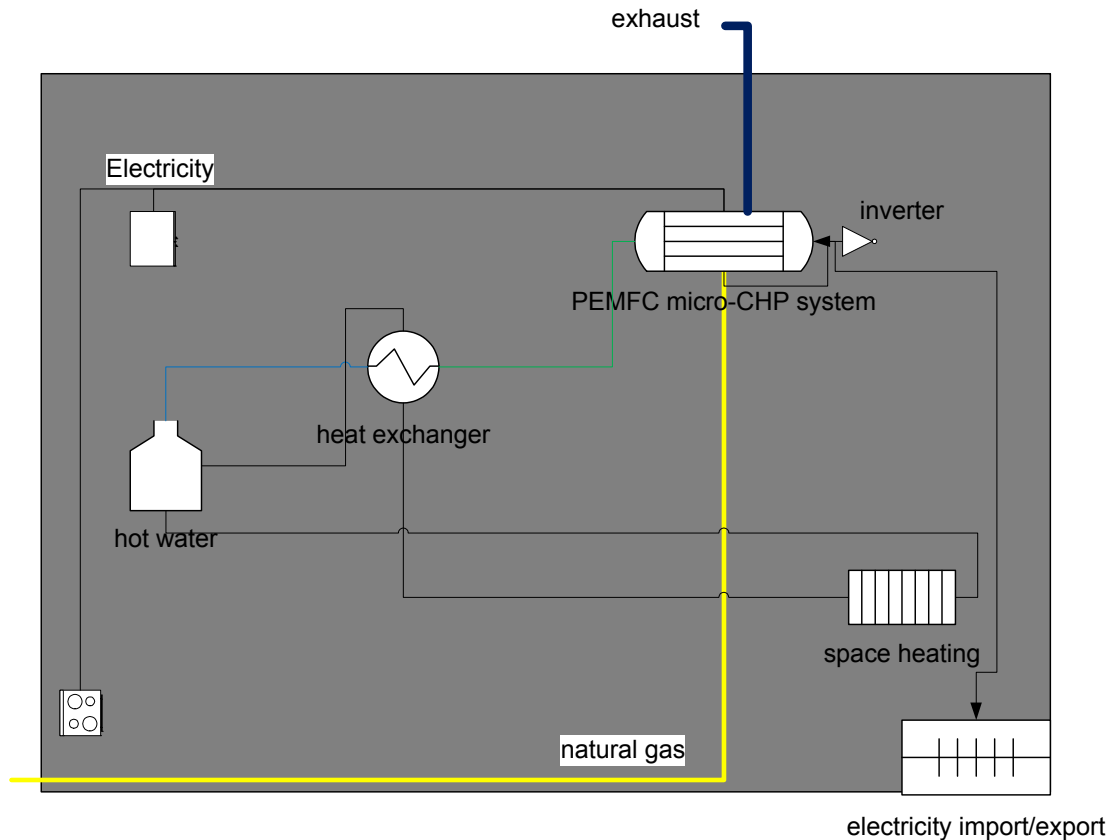

**Figure 5** Arrangement of a residential PEMFC-based micro-CHP system.

In Germany, a residential fuel cell program, named “Callux”, has been initiated in 2008, and the first phase is expected to be completed in 2012. The consortium combines the expertise of several industrial bodies and companies. The fuel cell manufacturers involved in this project include companies such as BAXI, Hexis and Vaillant (Callux, 2009). Several units have already been installed and currently, they are being tested in German households.

In Denmark, a micro-CHP project has been initiated in 2006, managed by a national consortium and consisting of nine companies and governmental bodies, such as the Danish Energy Agency. The consortium combines all the expertise necessary to develop, test, and demonstrate micro-CHP systems. The Danish Ministry of Climate and Energy finances the project by 40% of the total cost. The project is scheduled to be completed by 2012, and will test units based on various fuel cell technologies, such as Nafion<sup>TM</sup>-based PEMFC, PBI-

based PEMFC and SOFC. It is divided into three phases, and two fuel types are being tested: hydrogen and natural gas. The choice of fuel depends on the fuel cell technology and its availability at the installation site. A preliminary assumption concerning the operational control of the system, indicated that the electrical load must be fulfilled, but also the design should secure the right amount of heat will be available on demand for the space heating and hot water loads. Further on, an auxiliary burner for peak production of thermal energy is under consideration to be integrated to the end-user system (Danish Micro-CHP, 2009; Korsgaard, Nielsen, & Kær, 2008).

The HT-PEMFC-based micro-CHP units are developed by Dantherm Power and operate on natural gas. Experimental tests, with pure hydrogen fuel, showed start-up times of 30 to 60 minutes, with an electrical efficiency of 40% (hydrogen fuel, LHV-based). From the operating point of the finalized design, an efficiency of 50% is expected (hydrogen fuel, LHV-based). Further experimental tests and calculations showed a potential system efficiency of 85 to 90% (LHV-based) (Danish Micro-CHP, 2009). A fast adaption to load variations was also observed. In the first phase, Danish micro-CHP developed unit prototypes with PEMFC and SOFC technologies. In the second phase, ten micro-CHP units are scheduled to be installed and tested at selected consumer households in the municipalities of Lolland and Sønderborg. In the third and last phase, micro-CHP systems will be installed and demonstrated at around 100 households in the two aforementioned municipalities. This will allow the Danish micro-CHP system project to gather and analyze realistic experiences related to installation, operational procedures, maintenance needs and also consumer satisfaction (Danish Micro-CHP, 2009). Currently, HT-PEMFC activities are on standby, pending durability issues to be resolved.

## 1.2 Comparison Analysis Between the Proposed micro-CHP System and a Centralized CCGT Power Plant/Heater Combination

In this section the proposed HT-PEMFC-based micro-CHP system is compared to a more conventional combination of producing electricity and heat for a single-family household in Denmark. The best available technology today is analyzed and set as a suitable baseline for comparison with the proposed micro-CHP system.

It should be noted though, that combined cycle gas turbine (CCGT) and micro-CHP systems are not necessarily in competition with each other, because they can coexist ‘peacefully’ in the future. If both technologies are used in parallel, more options will be available and therefore the better utilization of

resources (e.g. natural gas) will improve. In other words, energy availability and reliability will improve, because dependency to the network grid will decrease, and therefore grid congestions and blackout events will diminish (Chicco & Mancarella, 2009; Praetorius et al., 2009). In addition, the current centralized power production system status-quo will shift towards a more competitive regime, with obvious benefits (Praetorius et al., 2009). Therefore, it should be strongly emphasized that the purpose of this research work is not the investigation of a proposed replacement of centralized CCGT power plants, but rather the replacement of aging natural gas boilers<sup>4</sup>, as already noted. Therefore the discussion below is only provided for comparison purposes.

Centralized power generation is considered more conventional and power plants are available in various configurations and based in different technologies. The most significant ones are the following: Steam turbines (ST), gas turbines (GT) and CCGT. The latter type is considered to be the most advanced technology, exhibiting overall efficiencies close to 60% (Lund, 2008; Praetorius et al., 2009). It combines the gas turbine (Brayton) and steam turbine (Rankine) thermodynamic cycles, where the former is the topping cycle and the latter the bottoming one. In addition, some other, more novel, central power plants designs have been under investigation in recent years. These include hybrid systems, which combine high temperature fuel cells with turbine cycles (i.e. SOFC-GT, SOFC-ST, SOFC-GT-ST and MCFC-GT). Therefore the following hypothetical question must be answered:

*Can the proposed system compete with centralized CCGT power plants and heat-only boilers which are in widespread use in single-family households today?*

To answer the above question, a number of comparison parameters are considered in order to distinguish the characteristics, including advantages and disadvantages, of the two technologies. The following analysis is performed in terms of efficiency, environmental considerations and cost.

### 1.2.1 Efficiency

The efficiency of a CCGT power plant is lower than the efficiency of the proposed system in many ways. At nominal load, modern CCGT systems can exhibit electrical efficiencies up to 60%<sup>5</sup> (Ang, Fraga, Brandon, Samsatli, & Brett, 2011), which is higher than the expected electrical efficiency of the

---

4. This is also the target of the Danish micro-CHP project (Danish Micro-CHP, 2009).

5. One of the most modern CCGT power plants in Denmark is the Silkeborg CHP Plant with a power output of 105 MW<sub>e</sub> and an electrical efficiency of 50% (DONG Energy, 2011).

proposed system. On the other hand, both systems must operate both at nominal and part-load. At part-load, the electrical efficiency of the CCGT will decrease<sup>6</sup> (Kehlhofer, Bachmann, Nielsen, & Warner, 1999), while the electrical efficiency of the proposed system will increase. For example, a CCGT plant with a nominal load efficiency of 60%, will have a decreased efficiency of 52% at 50% part-load (estimation based on empirical data found in (Kehlhofer et al., 1999)).

Further on, due to distribution and transmissions losses, around 6 to 10% of the efficiency is lost in the case of CCGT (Al-Sulaiman, Hamdullahpur, & Dincer, 2011; Lund, 2008), while in the case of the proposed system, there are practically no such losses, because the power is produced and consumed on-site (Raven & Verbong, 2007). It should be noted though that this assumption is only valid provided electricity is not exported by the proposed system to the grid (electricity-led operation).

In terms of overall efficiencies, the proposed system can reach efficiencies up to 91%, which is significantly higher than the corresponding efficiencies for CCGT, especially in the case where the exhausted heat of the power plant cannot be usefully utilized (Ang et al., 2011; Westner & Madlener, 2011).

Finally innovative control techniques, such as virtual control of many micro-CHP systems (virtual power plant), can aid in a more efficient operation of the micro-CHP systems, since neighboring micro-CHP systems can operate jointly, transmitting heat and power, as needed (Delta Energy & Environment Ltd, 2010; Praetorius et al., 2009; Raven & Verbong, 2007).

### 1.2.2 Environmental Considerations

Fuel cell technology features high electrical and total efficiencies, which in terms of environmental benefits translate to lower fuel consumption and decreased CO<sub>2</sub> emissions, as compared to a CCGT/boiler combination (Praetorius et al., 2009). The Kyoto agreement has prompted the EU to adopt energy policies that favor power and heat production with reduced greenhouse emissions (De Paepe & Mertens, 2007; Praetorius et al., 2009; Ropenus, Schröder, Costa, & Obé, 2010). Therefore, it is expected that the proposed system will be offered with several benefits, such as lowered taxation, subsidies, etc. Therefore energy policies can further favor the adoption of decentralized systems, such as the proposed system, even though their (actual) total cost will remain higher than CCGT/heater per kWh.

---

6. In CCGT power plants, without supplementary firing, the total plant efficiency primarily depends on the degree of heat recovery, the GT efficiency and the size of the plant (Kehlhofer et al., 1999).

The main problem with the proposed system, in terms of emission rates, is that the emissions will be exhausted in urban areas. Thereby CCGT is more emissions attractive, at least locally, in the sense that centralized power plants are typically located in rural areas (Chicco & Mancarella, 2009).

### 1.2.3 Cost

Currently fuel cell-based micro-CHP systems are not commercialized and therefore an estimation of their total cost cannot be accurately calculated. Nevertheless, the current capital cost of a fuel cell system is estimated to be very high and not competitive in terms of market diffusion (Chicco & Mancarella, 2009; Woudstra, van der Stelt, & Hemmes, 2006). A threshold point<sup>7</sup> must be reached, to allow the proposed system to compete with centralized power plants. The total cost includes the operating (fuel) cost, capital cost, maintenance cost and taxation cost. In addition the lifetime of the system must be known.

The proposed system can achieve high overall efficiencies and therefore can lead in fuel consumption reductions. Therefore, compared to the lower overall efficiencies of CCGT power plants at both full-load, and especially at part-load operation, the proposed system is more attractive in terms of fuel savings.

Finally in terms of lifetime and reliability, the proposed system has still a long way to prove itself (Delta Energy & Environment Ltd, 2010). Both the fuel cell stack and fuel processing degradation and catalyst deactivation issues have to be resolved, before the proposed system is able to match CCGT or other heat engine-based technologies.

## 1.3 Background and Motivation

The main motivations for the development of HT-PEMFC based micro-CHP systems for Danish single-family households are the following:

- The proven ability of fuel cell technology to achieve higher operational efficiencies (electrical and overall), with lower emissions as compared to other more conventional technologies (e.g. heat engines) (Barbir, 2005; Georgopoulos, 2002; Kim, von Spakovsky, Wang, & Nelson, 2010; Larminie & Dicks, 2003; O'Hayre et al., 2009);
- The need for the replacement of gas-fired furnaces in Danish single-family households with more efficient alternatives (Danish Micro-

---

7. The investment cost for a typical modern CCGT-CHP power plant is estimated at around 1200 €/kWe, with a depreciation period of 30 years and IRR of 7.4% (Westner & Madlener, 2011).

CHP, 2009; Korsgaard et al., 2008). There is an increasing demand for cleaner and more efficient energy production in conjunction with the increasing price and depletion of fossil fuels. Moreover, higher operational efficiencies suggest lower operational costs (Arsalis, 2008);

- The HT-PEMFC technology utilizes PBI membranes, operating at temperatures between 140 to 200°C. Therefore, this technology allows enhanced electrochemical kinetics, simpler water management and cooling, and also useful waste heat can be recovered (Büchi et al., 2009; Korsgaard, Nielsen, Bang, & Kær, 2006; Korsgaard, Refshauge, Nielsen, Bang, & Kær, 2006; Stolten, 2010; Jianlu Zhang et al., 2006). In addition lower quality reformed hydrogen may be used as fuel (Jianlu Zhang et al., 2006), suggesting cheaper and simpler fuel processing subsystems are required.

#### 1.4 Definition of the Research Question

Based on the literature review on micro-CHP technology, and the background and motivation, analyzed and explained in the previous sections, the main research question can be formulated:

*What are the prospects of 1 kW<sub>e</sub> HT-PEMFC-based micro-CHP systems to replace gas-fired burners in Danish single-family households in the context of a technical feasibility study?*

To answer this question, this research effort establishes the methods and framework for physical and empirical parametric modeling of the HT-PEMFC-based micro-CHP system, including its subsystems/components at a level appropriate for conceptual and preliminary design. The developed system must be validated and throughout a process of computational simulations, including design and off-design operational modes, parametric studies, sensitivity analysis, development of improved operational strategies, and application of optimization strategies (genetic algorithm, pinch analysis and process integration methods), conclusions are drawn on the proposed system potential.

#### 1.5 Objectives of the Research Project

The overall goal of this research work is to develop a HT-PEMFC-based micro-CHP system to replace natural gas heating units in Danish households. A 1 kW<sub>e</sub> (nominal power rate) grid-connected micro-CHP system can fulfill



the needs of such a household (average four person family residence in Denmark). To model and then analyze the micro-CHP system configurations as realistically as possible, detailed system and component thermodynamic, kinetic and geometric models are developed, implemented, and validated. Then by means of different studies, such as parametric studies, sensitivity analysis, genetic algorithm optimization (Chong & Zak, 2001; Ravindran, Ragsdell, & Reklaitis, 2006), and optimization using process integration techniques (pinch analysis) (Biegler, Grossmann, & Westerberg, 1997; Kemp, 2007; Sieniutycz & Jezowski, 2009; Smith, 2005), the system is thoroughly analyzed in the context of a technical feasibility study. Therefore the full advantages of such a HT-PEMFC-based micro-CHP system over more conventional systems can be extracted and analyzed.

The research project is split into five main topics/studies (shown in Figure 6), which can be summarized as follows:

- Development of the system in LabVIEW™ for future use with data acquisition hardware and laboratory tests of actual components;
- Development of the system in EES. Subsequent analysis using parametric study and sensitivity analysis methodologies;
- Investigation of the simulation model performance at different operational loads and formulation of an improved operational strategy;
- Optimization of the system by use of a genetic algorithm optimization strategy;
- Further optimization using pinch analysis and process integration techniques. Objective functions are formulated for the maximization of the net electrical efficiency and minimization of total HEN cost.

Thus, this research project includes the following tasks:

- Perform a literature review on fuel cell- and conventional-based micro-CHP systems;
- Become familiar with the previously developed HT-PEMFC-based micro-CHP system by A. Korsgaard (Korsgaard et al., 2008);
- Modify existing or develop new models/components required for the micro-CHP system. These models include: HT-PEMFC stack, SMR reactor, WGS reactor, catalytic combustor, heat exchangers, steam generator, water pump, air blower, thermal storage tank;
- Design, model and optimize the total system to implement the outlined studies;
- Examine the off-design operational behavior of the system in terms of efficiency and emissions;
- Validate the system using previously reported results;

- Analyze the results and draw conclusions.

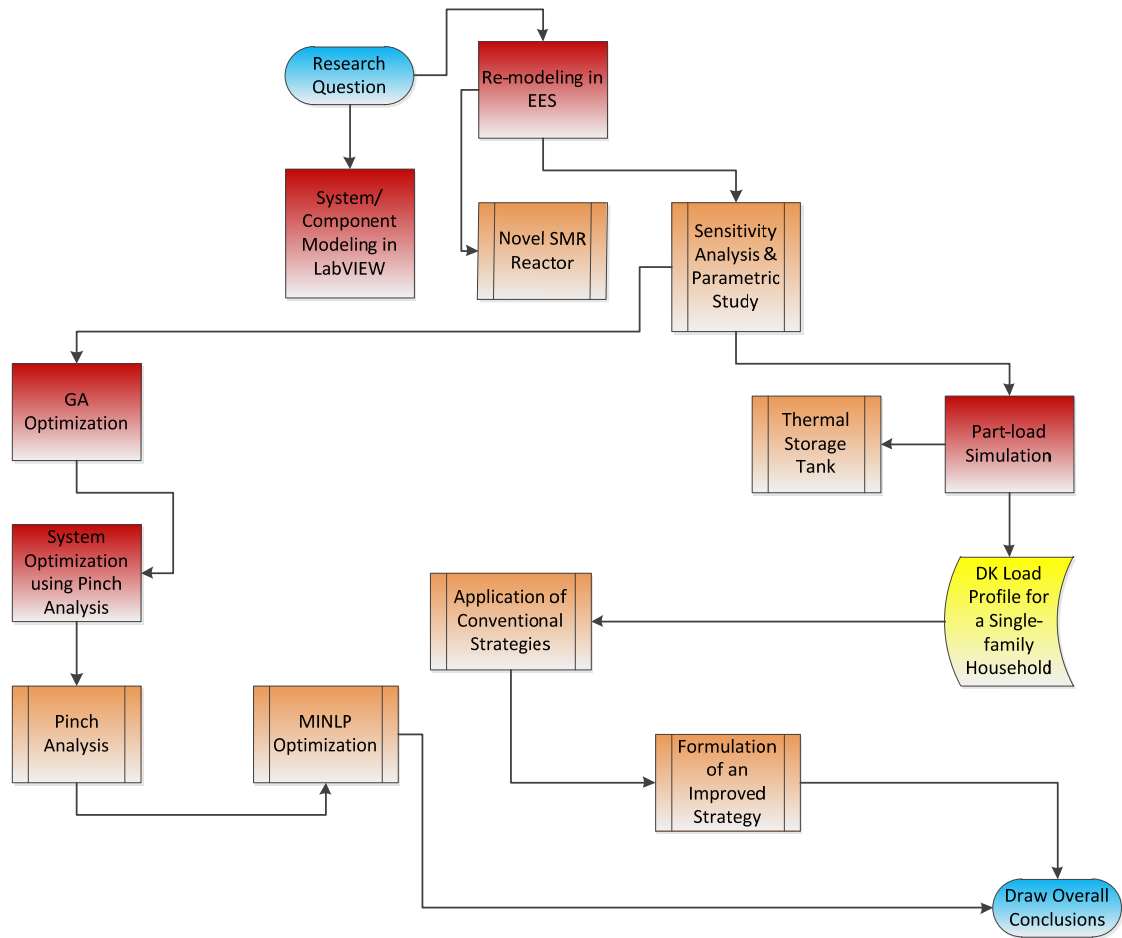

**Figure 6** Information flow within the research project effort.

To eliminate possible confusion, while reading this thesis work, the following assumptions are given:

- The fuel cell type was predetermined to be of the HT-PEMFC type. It is therefore assumed to be a fixed, non-decision variable, since no evaluation process took place to select which fuel cell technology type is more applicable (e.g. in terms of efficiency) for a fuel cell-based micro-CHP system;
- The computational model development varied throughout the project's evolution, based on decisions taken by the author and the supervising committee, or due to knowledge and information gained while developing the models.



## 2 Overview of Research Methodologies

In this chapter an overview of the development of the fuel cell system is described in detail. The analysis includes a description of the different components and subsystems needed in the development and operation of a fuel cell system.

### 2.1 Design of Stationary Fuel Cell Systems

A complete system based on fuel cell technology apart from the fuel cell stack, requires the coupling of some additional components (Barbir, 2005). Each component performs a different function, including heating, cooling, power conditioning and controlling. A fuel cell stack must be heated at start-up, but during operation, and especially during transient loads, it must be cooled to maintain normal operation. Therefore cooling is used to prevent overheating and thermal gradients within the stack (O'Hayre et al., 2009). Cooling and heating is not required only for the stack, but also for other system processes, such as fuel processing. Therefore a careful design, based on the selected application, must be utilized to perform the thermal management of the total system. This will ensure a minimum dumping of heat from the fuel cell stack and the fuel processing subsystem. In a stationary application, the additional waste heat may be suitable for recovery and use by means of cogeneration for different purposes. These may include covering part of the heating load profile (e.g. space heating) of a household (Korsgaard et al., 2008), or utilization in an absorption heat pump system (Zink, Lu, & Schaefer, 2007).

In terms of fueling, stationary fuel cell systems are usually less demanding than portable or vehicular applications. This is because they do not require fuel storage and system volume restrictions are usually more relaxed. Therefore pure hydrogen demand can be avoided, since fossil fuels, which are more

readily available<sup>8</sup>, can be instead utilized. A hydrogen-rich gas can be produced from natural gas<sup>9</sup>, throughout a series of fuel processing operations. These typically include desulfurization<sup>10</sup>, steam methane reforming and carbon monoxide cleaning (e.g. water gas shift, preferential oxidation). These steps are necessary in order to ensure different impurities and poisons have been completely removed, or at least removed at a tolerable limit, before the hydrogen-rich gas can enter the fuel cell stack anode. In the case of SOFCs, only pre-reforming is required, since internal reforming of the fuel is feasible inside the fuel cell stack, taking advantage of the high operating temperature of this fuel cell type (Calise, Dentice d'Accadia, Palombo, & Vanoli, 2006).

The fuel cell's power output requires conditioning to ensure a stable, reliable electrical output (O'Hayre et al., 2009). The power is conditioned by means of regulation and inversion. DC/AC inverters are used to transform the incoming DC power into an AC power, where DC/DC converters are used to regulate the power by stepping up or down the incoming transient voltage to an outgoing constant value. Almost all the electricity can be conserved, since both inverters and converters are very efficient, with typical values around 85-90% and 90-98%, respectively (Barbir, 2005; Larminie & Dicks, 2003). The fuel cell control unit<sup>11</sup> use feedback loops between sensors and actuators (i.e. valves, switches) to maintain operation within a desired range (O'Hayre et al., 2009). The total system efficiency is defined as the sum of the net system electrical efficiency and thermal efficiency (available for cogeneration) divided by the chemical energy input of the system fuel.

## 2.2 Modeling of Stationary Fuel Cell-based CHP Systems

A fuel cell system is divided into four main subsystems, introduced in the previous section: (a) the fuel processing subsystem, (b) the fuel cell subsystem, (c) the power electronics subsystem, and (d) the thermal management subsystem (O'Hayre et al., 2009). The fuel processing subsystem consists of chemical reactors, a burner and pipelines, where the fuel cell subsystem includes the fuel cell stack, cooling arrangements and an air blower (or air

---

8. Natural gas supply lines are usually available in most urban areas.

9. For the purpose of calculation simplicity natural gas is assumed to behave as methane. It should be noted that for a realistic operation with natural gas, the effect of higher carbons, should not be neglected. In this case more steam will be needed to address the potential problem of carbon deposition.

10. The purpose of desulfurization is the removal of sulfur compounds from a fossil fuel (e.g. natural gas) (Barbir, 2005; Kolb, 2008).

11. The control unit model lies outside of the scope of this research project and therefore it is not analyzed any further.

compressor). It should be noted that SOFCs additionally require a fuel compressor (Calise, Dentice d'Accadia, Vanoli, & von Spakovsky, 2006). The power electronics subsystem includes the electricity cabling (O'Hayre et al., 2009). Finally, the thermal management subsystem includes the heat exchange network, with the associate heat exchangers, pipelines and actuators.

### 2.2.1 Fuel Processing Subsystem

The purpose of the fuel processing subsystem is the generation of a hydrogen-rich reformat gas, with a low CO-content (composition depends on the tolerance of the fuel cell type). Additionally other poisonous substances, such as H<sub>2</sub>S must be removed. To accomplish these tasks various processes must take place in appropriate components (e.g. reactors) in a series of several steps. A simplified configuration of a typical fuel processing subsystem arrangement is shown in Figure 7. The main components include heat exchangers, chemical reactors, a burner, pipelines and extraction equipment (Jahn & Schroer, 2005; Jannelli, Minutillo, & Galloni, 2007; Kolb, 2008; O'Hayre et al., 2009). A steam generator converts liquid water into superheated steam. Steam generation is necessary for the fulfillment of the chemical reactions (e.g. steam methane reforming) in the reactors. The compressed natural gas is also preheated to accelerate and facilitate the reforming reaction. Steam generation and fuel preheating requirements are usually easily accomplished by waste heat generated by either the fuel cell stack or fuel processing. Then the methane/steam mixture enters the reformer, where it reacts at a high temperature (600-700°C), in the presence of a catalyst (to accelerate chemical kinetics), resulting in a hydrogen-rich reformat gas. The reformat gas then enters the water gas shift reactor, which increases the quantity of hydrogen in the stream and decreases the CO content.

The catalytic burner serves into the complete combustion of fuel remnants in the fuel cell exhaust exiting from the fuel cell anode and cathode. Based on the fuel processing arrangement the generated heat can be used in an endothermic reforming reaction (e.g. steam methane reforming) and/or provide heating for other system needs (e.g. steam generation). If heat is still available it can be used externally (e.g. thermal storage tank). Depending on the operating fuel utilization of the fuel cell stack, hydrogen-rich gas may be depleted at the exiting streamline of the fuel cell stack's anode and used in the burner. In some cases, the steam generated by the combustion of the hydrogen-rich gas in the burner can be reused in other parts of the system (O'Hayre et al., 2009). Finally after the burner, a condenser can be utilized to convert steam back to liquid water by cooling this stream and capturing the latent heat of condensation. In a fuel cell system, a condenser is important for both

recapturing heat and recovering liquid water to achieve *neutral system water balance*<sup>12</sup>. Finally it should be noted that very careful insulation and integration of the fuel processing components is necessary to minimize heat loss rates.

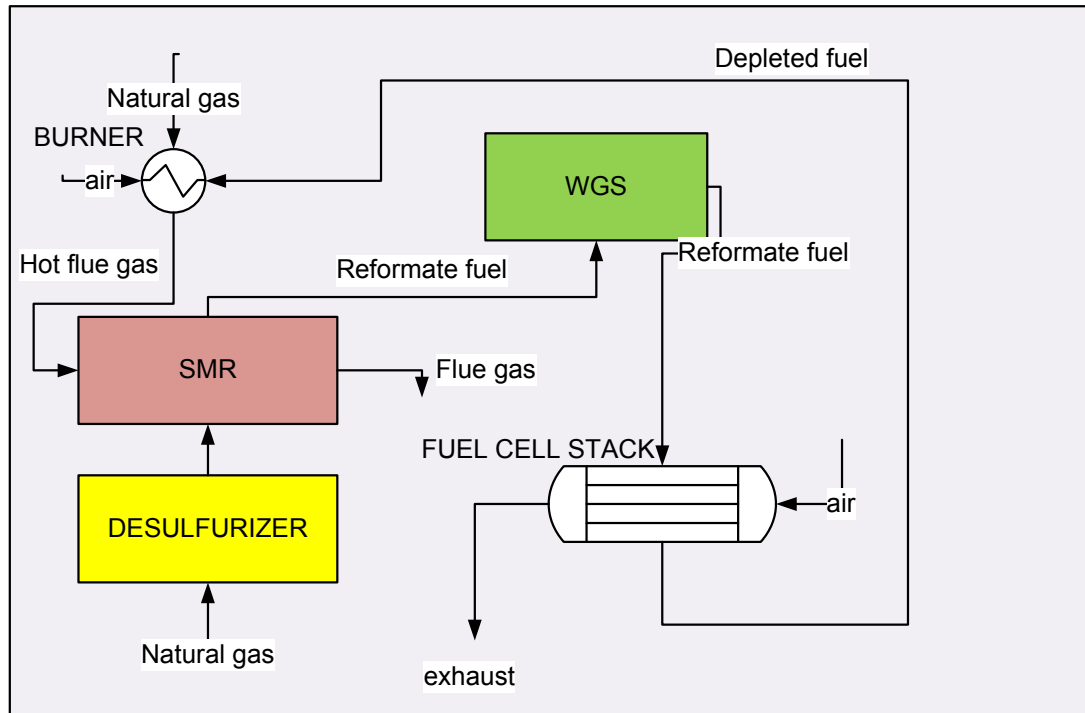

**Figure 7** Configuration of a simplified fuel processing subsystem.

### *Steam Reforming*

Steam reforming involves the reaction process of a hydrocarbon with steam. It is highly endothermic and proceeds at high temperature over a nickel catalyst (Kolb, 2008; Xu & Froment, 1989a, 1989b) as follows,

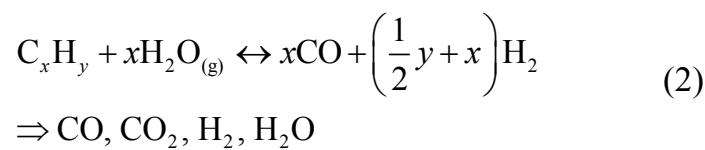

In addition, the high reaction temperature combined with high steam-to-carbon ratios can aid in the minimization of carbon formation. High pressures can also help in carbon formation minimization, but they result in lower conversion rates (Kolb, 2008). The steam reforming of methane can yield towards a H<sub>2</sub>-content of 76% on a dry molar basis (O'Hayre et al., 2009). Steam reforming is

---

12. A *neutral system water balance* describes the situation where all the water consumed by system components is produced by other system components, without any external water addition (O'Hayre et al., 2009).

the most efficient reforming option<sup>13</sup> in terms of H<sub>2</sub> generation, because of the absence of oxygen (air) in the reaction, and in turn the outlet stream does not contain nitrogen (Barbir, 2005). H<sub>2</sub> generation can be increased by operating the reaction with excess steam to help shift the reaction's equilibrium in favor of H<sub>2</sub> production (Xu & Froment, 1989b). Additional increase in H<sub>2</sub> generation can be accomplished by shifting the CO towards H<sub>2</sub> via the water gas shift reaction (O'Hayre et al., 2009):

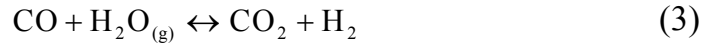

All the main chemical reactions associated with steam methane reforming are summarized in Table 3. The most common steam reforming design configuration is the tubular type (e.g. shell-and-tube) and includes a furnace containing tubes filled with catalysts, through which the steam reforming reactants flow (O'Hayre et al., 2009). In a typical shell-and-tube arrangement, the reforming reaction takes place inside the tubes (tube-side), which are heated by the hot flue gas flowing in the shell-side. Shell-and-tube is not easily applicable in low-scale fuel cell-based systems, because integration becomes more difficult in compact design applications.

**Table 3** Steam reforming reactions.

Reaction #	Reaction Type	Stoichiometric Formula	$\Delta\hat{h}_{rxn}^0$ [kJ/mol]
1	Steam reforming	$\text{CH}_4 + \text{H}_2\text{O}_{(g)} \rightarrow \text{CO} + 3\text{H}_2$	+206.4
2	Water gas shift reaction	$\text{CO} + \text{H}_2\text{O}_{(g)} \rightarrow \text{CO}_2 + \text{H}_2$	-41.2
3	Evaporation	$\text{H}_2\text{O}_{(l)} \rightarrow \text{H}_2\text{O}_{(g)}$	+44.1

### *Water Gas Shift*

The aforementioned steam reforming reaction results in the production of CO in the reformat fuel. Therefore, the second fuel reforming step involves one, or a series, of CO-cleanup processes. The initial and main CO-cleanup process involves passing of the reformat gas through a WGS reactor (Keiski, Salmi, Niemisto, Ainassaari, & Pohjola, 1996; Kolb, 2008). The CO-content  $y_{\text{CO}}$  is the mole fraction of CO in the reformat stream,

$$y_{\text{CO}} = \frac{n_{\text{CO}}}{n} \quad (4)$$

---

13. The other main reforming options are partial oxidation and autothermal reforming. Partial oxidation is less efficient than steam reforming in terms of hydrogen production. In particular for methane, it is only able to generate two moles of hydrogen per mole of methane, while steam reforming can generate three moles (Barbir, 2005).



where  $n_{\text{CO}}$  is the number of moles of CO in the reformat stream. The WGS reaction can reduce the CO-content up to around 0.2%, with the presence of a shift catalyst (Kolb, 2008).

The reversible WGS reaction is moderately exothermic. At high temperatures the balance is shifted towards the reactants (CO and H<sub>2</sub>O), where at low temperatures, the balance follows the opposite direction (CO<sub>2</sub> and H<sub>2</sub>) (O'Hayre et al., 2009). Therefore, at low temperatures, the reaction increases its H<sub>2</sub> yield (equilibrium), but on the other hand, at high temperatures the reaction kinetics proceeds faster. To accomplish both tasks, the WGS process may proceed in two (or more) stages, utilizing initially a high temperature reactor, and afterwards another low temperature reactor, downstream of the first. Typical low temperature shift (LTS) reactors and high temperature shift (HTS) reactors operate at around 200-300°C and 375-450°C, respectively (Kolb, 2008). Because of the temperature difference between the two shift reactors, an intermediate cooling heat exchanger is required to maintain the desired input temperature to the LTS reactor. The most common catalyst material for LTS reactors is copper/zinc oxide (Kolb, 2008), while HTS reactors incorporate iron oxide-based catalysts (Keiski et al., 1996; Kolb, 2008). A PBI-based PEMFC can tolerate up to 3% of CO-content, and therefore a single stage WGS reactor is usually adequate for CO-cleaning (Serenergy, 2011).

### 2.2.2 Fuel Cell Subsystem

The H<sub>2</sub>-rich reformat gas is fed to the anode side of the fuel cell stack, while simultaneously compressed air is fed to the cathode side. The fuel cell reaction produces DC electrical power and exhaust heat. The total system electrical efficiency is lower than the fuel cell electrical efficiency, due to the parasitic power required to operate pumps or compressors (O'Hayre et al., 2009). Therefore a high efficiency can be maintained, only if the system can operate near ambient pressure. The fuel cell efficiency increases with an increasing voltage, but higher voltage values result into a decrease in power density. Therefore in this case a larger fuel cell stack, with an associated higher purchase cost, must be utilized for the same power output (Barbir, 2005).

Equivalently, part-load fuel cell efficiencies are higher than the corresponding efficiencies at nominal load. It should be noted though, that a high fuel cell efficiency does not necessary correspond to a high overall system efficiency, because other system components may perform poorly under part-load conditions. For example, the SMR reactor will be less efficient at part-load due to the increase of heat losses, or balance-of-plant components may require more power input (comparatively to power output) at these conditions.

The net electrical efficiency of the fuel cell subsystem  $\eta_{R,SUB}$  is defined as the ratio of the net electrical power of a fuel cell subsystem  $P_{e,SUB}$  and the HHV of  $H_2$  in the inlet gas (O'Hayre et al., 2009),

$$\eta_{R,SUB} = \frac{P_{e,SUB}}{\Delta\dot{H}_{HHV,H_2}} \quad (5)$$

### 2.2.3 Thermal Management Subsystem

The thermal management subsystem recovers waste heat from the system for both internal (system) use and also external use (O'Hayre et al., 2009), if applicable. Therefore this subsystem must integrate the system streamlines in such a way that will allow both smooth and efficient operation. This is typically accomplished by the use of heat exchangers. The selection of a heat exchanger network can be a very difficult process, because many important parameters are involved. These parameters include the heat exchanger purchase cost, the heat exchanger type, the exchanger heat transfer area, the number of heat exchangers and also the heat exchanger integration with other system components.

A fuel cell-based system can be very demanding in terms of thermal integration, especially in the case of an integrated fuel processing subsystem (Barbir, 2005). A series of heat exchangers will be required to either heat (e.g. steam generation and fuel preheating) or cool (e.g. cooling of reformat fuel between reactors and before the fuel cell anode inlet) the various system streamlines. Typically heat can be recovered from the catalytic burner, exothermic chemical reactor, reformat cooling processes and the fuel cell stack exhaust. On the other hand, heat must be supplied to the steam generator, fuel preheater, thermal storage tank, etc.

A very rigorous process for the configuration of heat exchangers is required, in order for the system to accomplish an economically feasible operational threshold, without the need for extensive external heating and/or cooling. An optimum heat exchanger network can be designed with the aid of advanced integration techniques, such as pinch analysis and process integration, which allow the determination of an idealized configuration, based on the system designer's requirements. Therefore the objective function for such a procedure may involve cost and other parameters, usually within a constrained optimization regime (Kemp, 2007).



## 3 Description of Publications

In this chapter all published and submitted journal articles are introduced and described in terms of hypothesis, methodology and results. In addition, a description of the logical and scientific progression of the work is explained.

### 3.1 Paper I

In the first paper (I), the HT-PEMFC-based micro-CHP system is designed and modeled in LabVIEW™. A detailed literature review, including an introduction to stationary fuel cell systems, micro-CHP and HT-PEMFC technology, is outlined. Also, an introduction to the Danish micro-CHP project is given, including “state-of-the-art”, project schedule and future objectives. The system is designed and simulated in LabVIEW™, with the intention of providing easiness in user usage and control of the model, and to allow future experimental testing capabilities with Data Acquisition hardware.

A representative averaged load profile of a single-family household in Denmark is used to simulate the model within design and off-design conditions. The system is divided into subVIs (subsystems) and connected and controlled with the main VI. The model includes component models for the fuel cell stack, SMR and WGS reactors, mixers, by-pass valves, heat exchangers, combustor, steam generator and water pump. The model is then validated and results are extracted to describe its characteristics for 25 to 100% operational loads.

### 3.2 Paper II

In the second paper (II), the micro-CHP system is modeled in EES. The reason is that modeling in EES is relatively easy and most importantly it includes many built-in features, such as parametric tables, uncertainty analysis,

optimization methods, thermophysical property functions, etc. Therefore, this topic is set as the basis for the remaining three research topics (III-V) of the study plan.

A literature review on micro-CHP technology and other cogeneration systems based on fuel cell technology, as found in the literature, is given. The details on the system modeling are given in detail, including assumptions on modeling simplifications. In this paper, a novel SMR reactor model is integrated with the micro-CHP system. The compact SMR reactor (Ahlstrom-Silversand & Odenbrand, 1999) is of the plate heat exchanger type and its modeling details are explained. The other models are similar to the ones given in paper I.

The system is then validated and a sensitivity analysis, using the built-in EES uncertainty propagation tool, is applied to determine system performance trends. A parametric study is then conducted using four decision variables, found to be influential in the sensitivity analysis. These are the following: (a) fuel cell operating temperature, (b) combustor output temperature, (c) anode stoichiometric ratio, and (d) steam-to-carbon ratio. A detailed analysis of the results of the parametric study is given, including efficiency variation against different current density values. Also the variation in the chemical composition of the reformat gas is illustrated and analyzed.

### 3.3 Paper III

In the third paper (III), the simulation model developed in II is used as a basis for the study of conventional and combined improved strategies for the micro-CHP system. The paper includes a literature review on the different types of micro-CHP systems available. These include PEMFC, SOFC, ICE (Internal Combustion Engine), and SE-based systems. Their advantages and disadvantages, with emphasis on their operational behavior and efficiency, are given for each type. Further on, an introduction on the market penetration projection for micro-CHP systems is analyzed. Finally, a literature review, encompassing conventional and novel operational strategies, is explained in detail.

The system modeling and layout is given. For the purposes of this study topic (III), a thermal storage tank is modeled and coupled to the micro-CHP system (Salcines, Estébanez, & Herrero, 2004), to provide greater operational flexibility. Then, the three operational strategies used in this research study are analyzed in detail. The three strategies are the following: heat-led, electricity-led, and improved operation.

In the results and discussion section the averaged Danish load profile is fulfilled (partly or fully) by use of the three operational strategies. Based on the results from the two conventional operational strategies, the improved strategy is formulated and applied to the simulation model. Emphasis is given on constraining the system operation within high efficiency regimes, reduction of frequent interaction with the grid, and avoiding the production of excess heat that cannot be stored in the thermal storage tank. Also carbon dioxide emissions are analyzed and compared with conventional systems. In addition, heat losses from the thermal storage tank during different loads (and time periods) are analyzed. Finally, an overall analysis of the three operational strategies is presented and analyzed through comparisons.

### 3.4 Paper IV

After the development of the simulation model (paper II), and the investigation of efficient operational strategies (paper III), the system is optimized using the EES built-in GA optimization method (Godat & Marechal, 2003; Palazzi, Autissier, Marechal, & Favrat, 2007; Weber, Marechal, Favrat, & Kraines, 2006). The purpose of this research study topic is the maximization of the net electrical efficiency by variation of nine decision variables. In this system a different subsystem simulation model for the SMR reactor (Georgopoulos, 2002) is modeled and coupled to the simulation model, since the previous experimental model, used in study topics II-III does not allow simulation flexibility (discretized model) and geometrical optimization. All other components are modeled similarly as in II-III.

The paper includes the theoretical background of the optimization strategy, including the modeling and optimizing assumptions used in the simulation model, and the built-in EES min/max function. This function is based on PIKAIA, which is a public domain, general purpose GA-based optimization subroutine (Charbonneau, 2002). Internally, PIKAIA seeks to *maximize* a user-defined function  $f(x)$  in a bounded  $n$ -dimensional space,

$$x \equiv (x_1, x_2, \dots, x_n), \quad x_k \in [0.0, 1.0] \quad \forall k \quad (6)$$

Parameter values are restricted in the above range to allow greater flexibility and adaptability across problem domains. Maximization is carried out on a population made up of  $N_p$  individuals, while the population size remains fixed throughout the evolution. Instead of evolving the population until some tolerance criterion is satisfied, the evolution is carried over a user-defined, preset number of generations  $N_g$ . Since breeding involves the production of *two* offspring, the inner loop executes  $N_p/2$  times per generational iteration,

where  $N_p$  is the population size. All parameter values defining the individual members of the initial population are assigned a random number in the range above, extracted from a uniform distribution of random deviates. This ensures no initial bias is introduced by the initialization.

The values of the fixed parameters are given. Then the decision variables are described, including their initial, minimum, maximum and the calculated optimum values. The details on the optimization results including the number of the needed generations and iterations to reach the optimum value are described in detail. The behavioral pattern of the objective function and every decision variable throughout the optimization procedure is illustrated and analyzed in detail.

### 3.5 Paper V

The final study topic (paper V), includes a more advanced optimization methodology, using process integration techniques. The purpose of this study is to further increase the net electrical efficiency of the system using pinch analysis (Kemp, 2007; Linnhoff & Flower, 1978a, 1978b; Linnhoff & Hindmarch, 1983; Smith, 2005), and also redesign the HEN of the micro-CHP system, using a MINLP problem formulation (Biegler et al., 1997; Grossmann, 2004; Ponce-Ortega, Jimenez-Gutierrez, & Grossmann, 2008; Viswanathan & Grossmann, 1990; Yee & Grossmann, 1990). The objective function (Ponce-Ortega et al., 2008) is defined as the minimization of the total yearly cost, which includes the cost of utilities and the fixed and variables costs of the exchangers,

$$\begin{aligned}
& \min \sum_{i \in \text{HPS}} \text{CCU} q_{cu_i} + \sum_{j \in \text{CPS}} \text{CHU} q_{hu_j} \\
& + \sum_{i \in \text{HPS}} \sum_{j \in \text{CPS}} \sum_{k \in \text{ST}} \text{CF}_{i,j} z_{i,j,k} + \sum_{i \in \text{HPS}} \text{CF}_{i,cu} z_{cu_i} \\
& + \sum_{j \in \text{CPS}} \text{CF}_{cu,j} z_{hu_j} \quad (7) \\
& + \sum_{i \in \text{HPS}} \sum_{j \in \text{CPS}} \sum_{k \in \text{ST}} C_{i,j} \left\{ \frac{q_{i,j,k} (1/h_{i,k} + 1/h_{j,k})}{\text{LMTD}_{i,j,k} + \delta} \right\}^{\beta}
\end{aligned}$$

where  $C$  is the area cost coefficient,  $\text{CCU}$  is the unit cost of cold utility,  $\text{CHU}$  is the unit cost of hot utility,  $\text{CF}$  is the fixed charge for exchangers,  $\text{CPS}$  is the  $\{j|j\}$  cold process stream,  $\text{HPS}$  is the  $\{i|i\}$  hot process stream,  $cu$  is the cold utility,  $hu$  is the hot utility,  $h$  is the fouling heat transfer coefficient,  $q_{i,j,k}$  is the heat exchanged between hot process stream  $i$  and cold process stream  $j$  in stage

$k$ ,  $qcu_i$  is the heat exchanged between cold utility and hot stream  $i$ ,  $qhu_j$  is the heat exchanged between hot utility and cold stream  $j$ , ST is the  $\{k|k \text{ stage in the superstructure, } k=1, \dots, \text{NOK}\}$ ,  $z_{i,j,k}$  is the set of binary variables for match  $(i,j)$  in stage  $k$ ,  $zcu_i$  is the set of binary variables for the match between the cold utility and the hot stream  $i$ ,  $zhu_j$  is the set of binary variables for the match between the hot utility and the cold stream  $j$ ,  $\beta$  is the exponent for area in the cost equation and  $\delta$  is a small number. Subscripts  $i$  and  $j$  denote the hot and cold process streams, respectively, while  $k$  is the index for the stage  $(1, \dots, \text{NOK})$  and temperature location  $(1, \dots, \text{NOK}+1)$ .

A general introduction on pinch analysis and process integration techniques is given to explain the purpose of the study. Then, a literature review on fuel cell-based systems using different methods of pinch analysis and process integration (Autissier, Palazzi, Marechal, van Herle, & Favrat, 2007; Godat & Marechal, 2003; Palazzi et al., 2007; Verda & Nicolin, 2010; Wallmark & Alvfors, 2002; Weber et al., 2006) is given. Finally, the objectives of the research study topic are given in steps. The simulation model is described in detail. In general, the simulation model is the same as in IV, although there are a few changes. The first modification is the removal of the condenser from the system configuration. A condenser is not included, after personal communication with the HT-PEMFC stack manufacturer (Serenergy) and the Jülich Research Center (Korsgaard, 2011; Stolten, 2011)<sup>14</sup>. The second modification is the inclusion of heat losses considerations for the fuel cell stack, SMR reactor and combustor. This is done in order to make the system simulation closer to an actual system, and also to investigate the extent of heat loss rate from different system components.

The general pinch analysis and process integration methodology is formulated and analyzed in detail, with all necessary steps followed in the research study. The steps include definition of the cold and hot data set, removal of all heat exchangers included in the initial configuration, reevaluation of the HEN using process change techniques, and HEN optimization to obtain a minimum total annual cost. The pinch analysis results are first found for the initial stream data set. Based on these preliminary results and by means of process change, the GA optimization method in EES is used to optimize the system in terms of maximization of the net electrical efficiency. The pinch analysis is then re-applied to the optimum stream data set, and used in the MINLP optimization model in GAMS to minimize the total HEN annual cost. Based on this result, a new HEN configuration is designed with all

---

14. Regarding the steam-content in the reformat fuel, the communication concluded that steam could remain in the reformat fuel, without causing problems in the fuel cell stack operation.



necessary data (stream flows, temperatures, number of heat exchangers, costs, and heat loads).

### 3.6 Overall Evolution of the Configuration Topology

The configuration topology of the system has evolved differently in almost every research topic for various reasons. Initially, in papers I-II, the system was designed without a thermal storage tank (TST) (see Figure 8). Instead three heat exchangers (IV, V, VI), were utilized to accomplish the heat exchange for the thermal cogeneration of the system. In the third study topic (III), a TST model replaced the three heat exchangers to reflect a more realistic design and to offer operational flexibility in the effort of seeking an improved operational strategy (see Figure 9). However, the use of a mixer, in a realistic system configuration, can cause pressure drop and temperature compatibility problems when the two flows are mixed (fuel cell stack exhaust and combustor flue gas exhaust). This problem is solved in the fourth study topic (IV). In this case the fuel cell exhaust flows into the combustor, while a heat exchanger (IV), after the flue gas combustor exit, is used to increase the temperature of the fuel cell stack exhaust (see Figure 10). A high incoming temperature achieves a higher combustion efficiency (requires less extra fuel), and therefore the net electrical efficiency of the system is increased. The final change in the system configuration (paper V) was the removal of the condenser (see Figure 11), for the reasons explained in the end of the previous subsection.

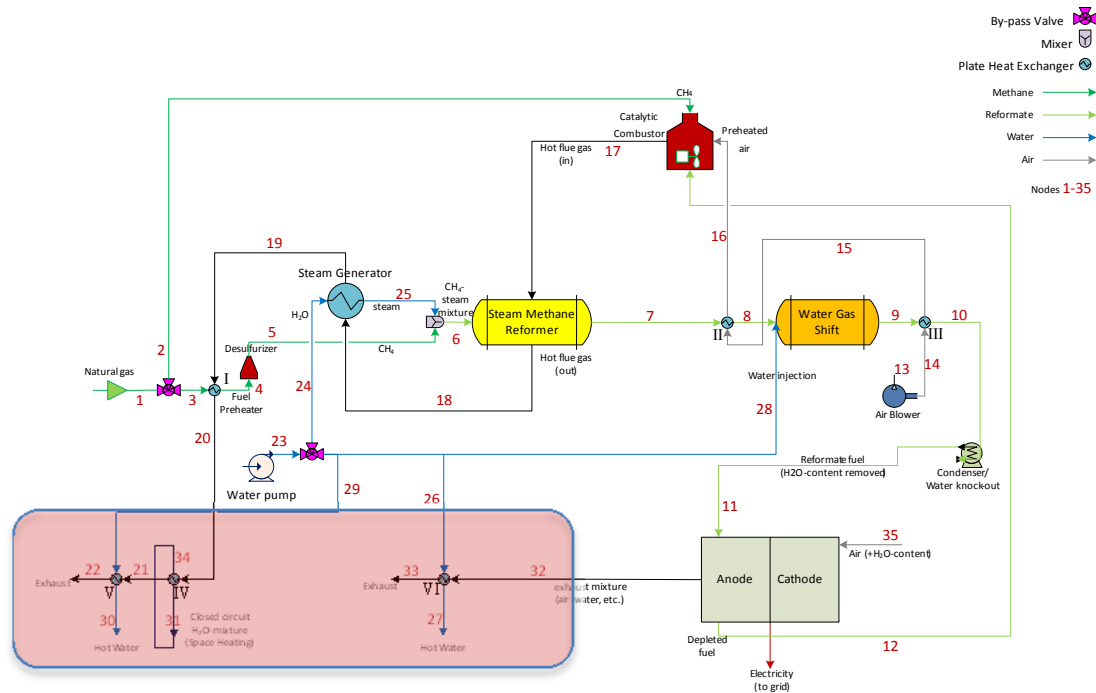

**Figure 8** System configuration used in papers I-II.

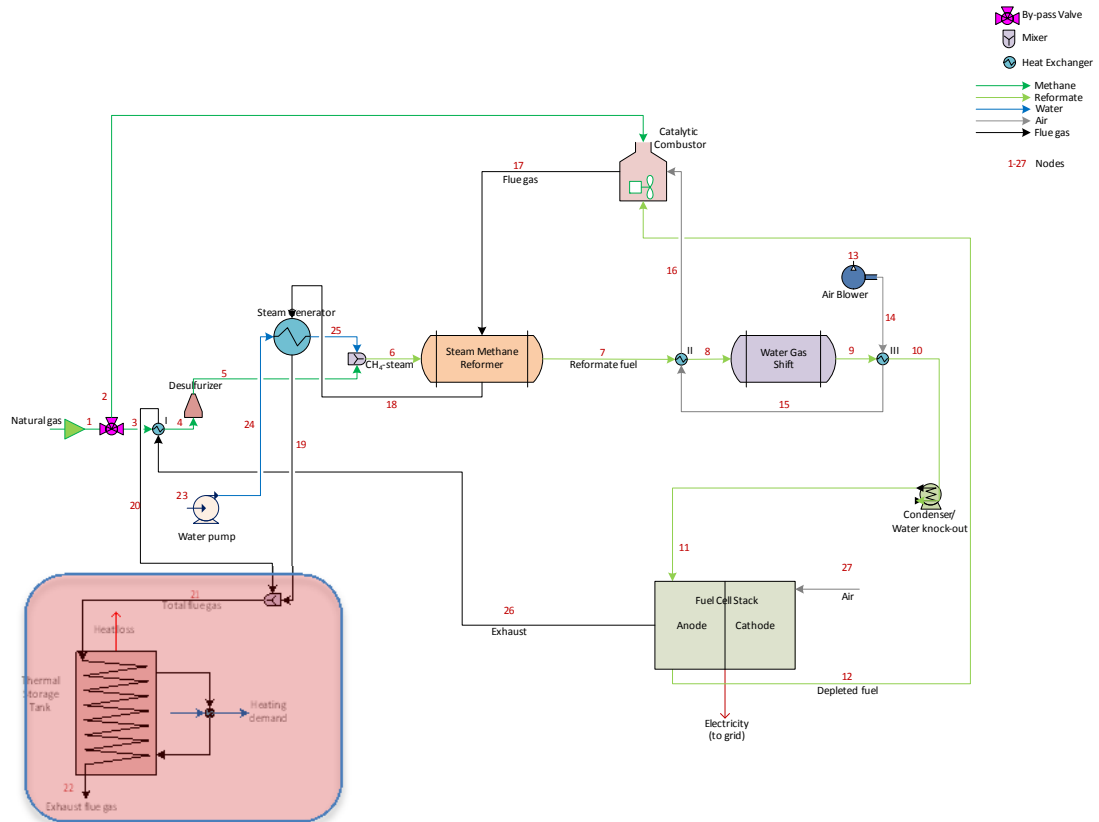

Figure 9 System configuration used in paper III.

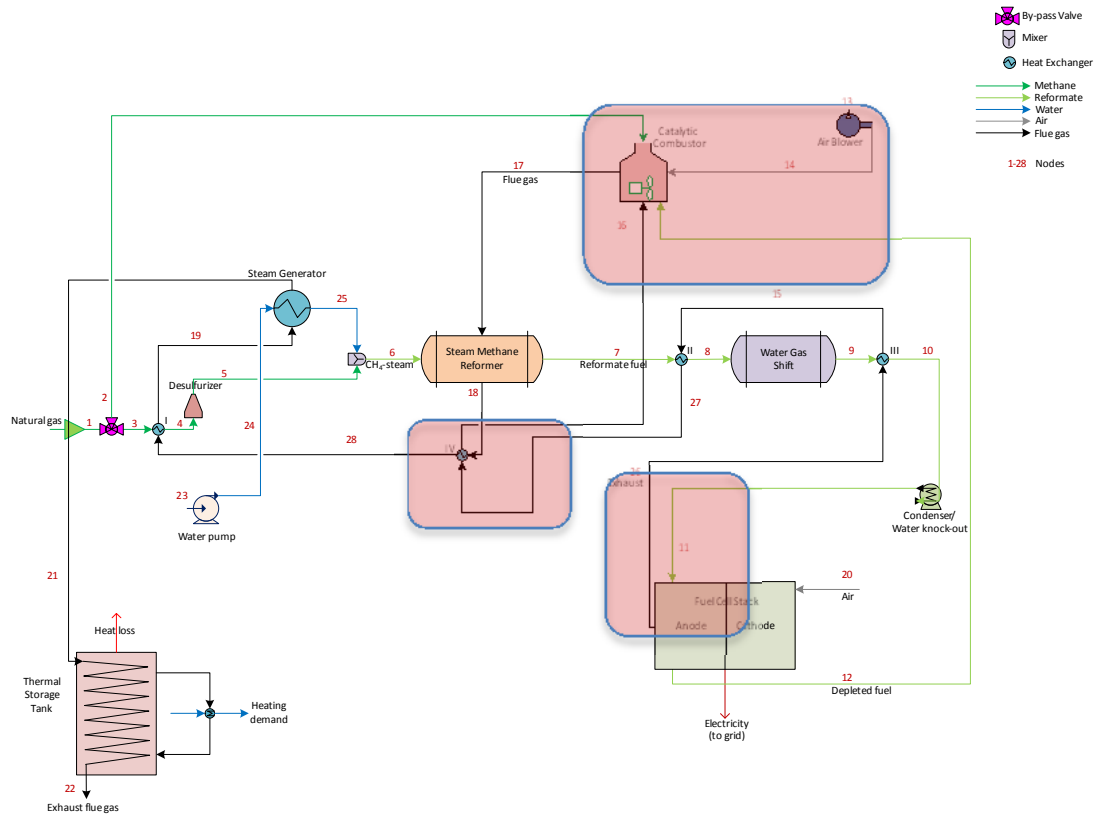
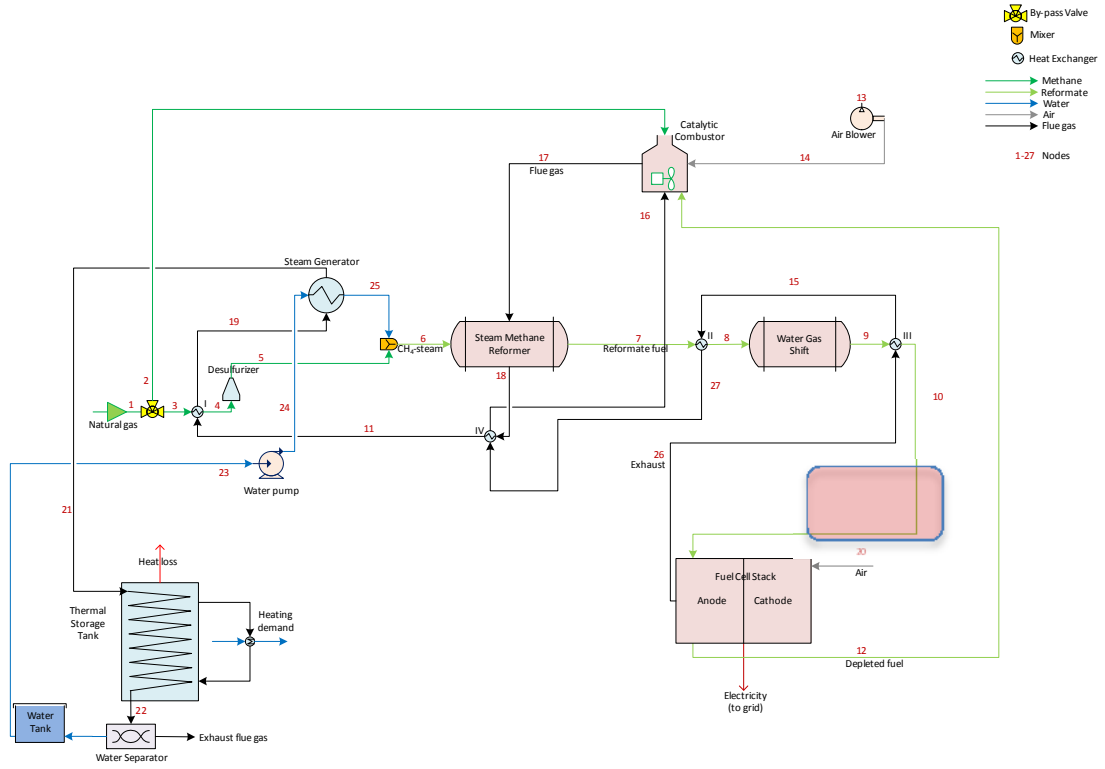

Figure 10 System configuration used in paper IV.



**Figure 11** System configuration used in paper V.

## 4 Summary of Principal Results and Discussion

In this chapter a summary of the principal results obtained throughout the evolution of the research project are given and analyzed. The analysis includes the most significant trend lines obtained by the variation of independent and dependent parameters, including decision and synthesis/design variables.

The LabVIEW™ system model (see paper I) is simulated at design and off-design conditions. An averaged load profile from Danish consumption data measurements, including the electricity and heating demand is used for comparison with the simulated system's corresponding heat and power output. These, rather rough, preliminary results were used in the subsequent publications (namely papers II-III), to perform more specific calculations and obtain more accurate results. Although the simulated model was not very realistic and accurate at this stage, the obtained efficiencies verified the great potential of the system. The maximum net electrical efficiency was calculated at 45.4% while the maximum total efficiency was 95.2%.

The same system configuration, including a novel plate heat exchanger SMR reactor, is then simulated in EES with more accurate and realistic component/subsystem models (see paper II). A sensitivity analysis and parametric study is performed to provide input for system optimization in the subsequent study topics (IV-V). Four decision variables (steam-to-carbon ratio, anode stoichiometric ratio, operating fuel cell temperature, and combustor output temperature) are varied to determine whether they can cause significant performance behavioral patterns in regards to efficiency. By observation, the optimum value of the fuel cell operating temperature is 180°C, since the fuel cell stack operates more efficiently at elevated temperatures (see Figure 12). On the other hand it should be observed that up to 160°C the efficiency increases rapidly, but beyond that value efficiency increases only slightly. Therefore, operation beyond 160°C is not justified, considering the faster

degradation of PBI-membranes at elevated temperatures (Büchi et al., 2009). A similar pattern is observed with the combustion output temperature. On the other hand, the other two parametric variables, steam-to-carbon ratio and anode stoichiometric ratio have a more linear behavioral respond. Finally, the study revealed the need to optimize geometric parameters, such as the WGS reactor length.

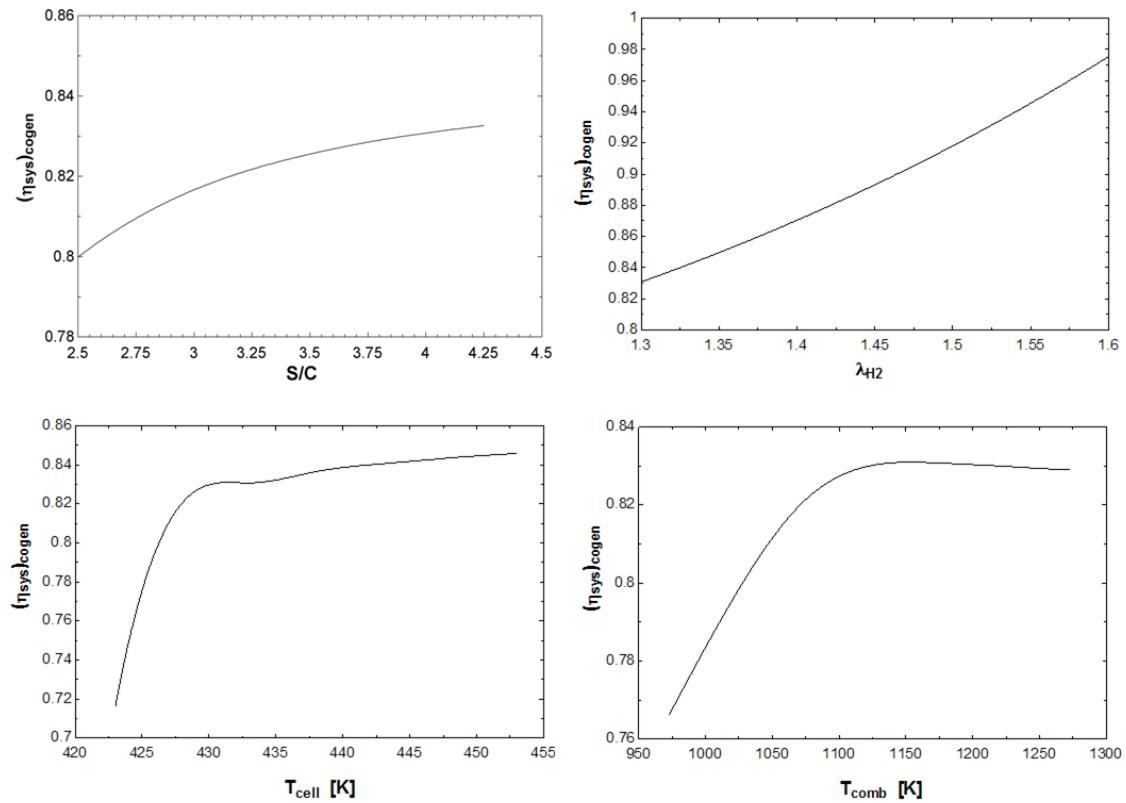

**Figure 12** Decision variables vs. combined cogeneration system efficiency.

To formulate an improved operational strategy, in terms of efficiency, the effect of the application of conventional strategies (i.e., heat-led and electricity-led) should be initially analyzed (see paper III). Then, based on the obtained results from these strategies, their shortcomings and other disadvantages can be monitored and eliminated, in the degree possible, by formulating an improved strategy. The system is constrained within high net electrical efficiency regimes, while the system must be shut-down during periods of very low demands to avoid both low efficiency regimes, but also the production of excess heat that cannot be stored in the thermal storage tank and must be exhausted (and thereby lost). The influence of operational strategies on the proportion of electricity and heating demand met by the micro-CHP system is illustrated in Figure 13. From an observation, it is obvious that the electricity/heat demand is almost coincidental with the electricity/heat production during mid-season (nodes 9-14, 22-25). During this period, only a

small amount of auxiliary heat is needed, while the import/export of electricity to the grid is also kept at a minimum rate. On the other hand, during the winter months most of the heat demand has to be fulfilled by external means.

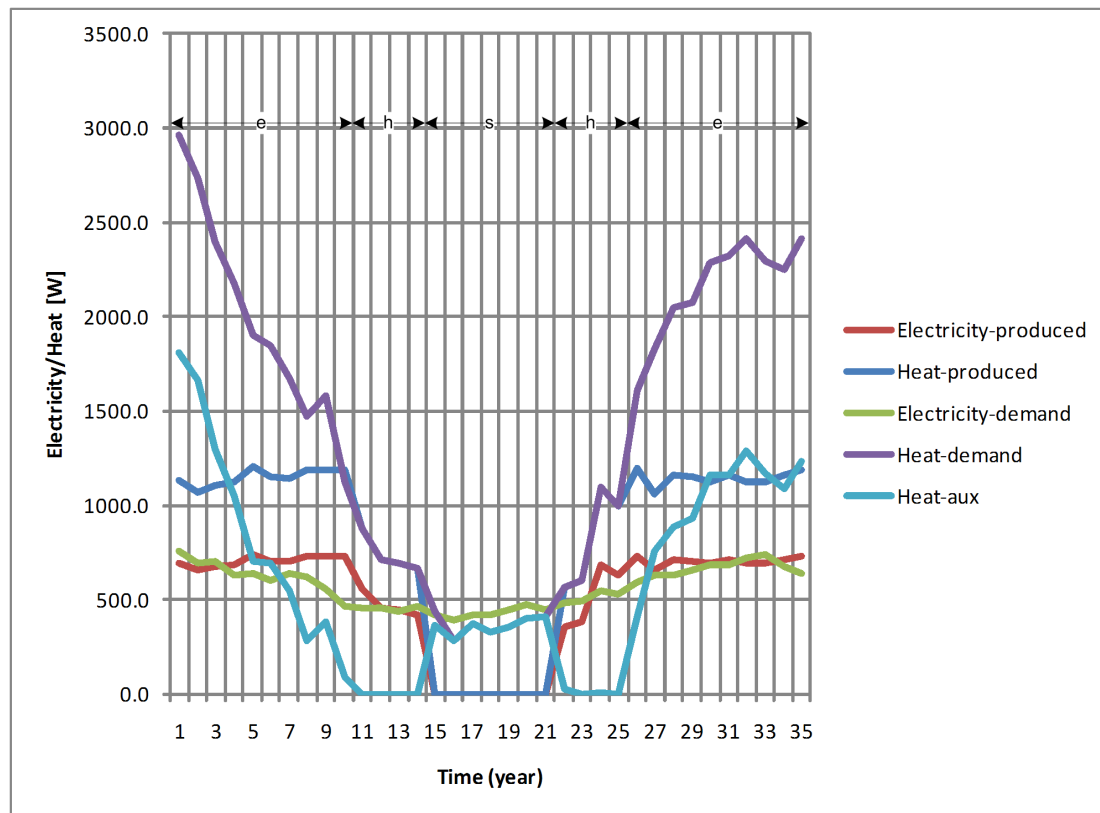

**Figure 13** Annual variation of electricity (production and demand) and heat (production, demand and auxiliary).

The performance characteristics of the three operational strategies are summarized in Table 4. Heat-led operation requires almost twice the fuel input, when compared to the improved strategy, which produces an increased amount of electricity overall. Nevertheless, electricity still has to be imported at periods of low heat demand, such as the summer season. The electricity-led operation requires significantly less fuel than the heat-led operation, but a high amount of heat dumping is required. The merits of the improved operation are obvious in all categories, although a significant amount of imported electricity is required due to the system shutdown in the summer period and the constraining of the system at a maximum load of  $1 \text{ kW}_e$ . The most important parameter of the study was the improvement of the average system efficiency, which is 85.9% for the improved operational strategy, while the respective total system efficiencies for the electricity-led and heat-led ones are 71.2 and 74.8%. It is important to observe that the thermal efficiency (and subsequently the total system efficiency) for the electricity-led operational is lowered significantly

due to the need for heat dumping. Further on, efficient operation has a positive effect on CO<sub>2</sub> emissions, which have been lowered to 2609 kgCO<sub>2</sub>, as compared to 2931 and 4653 kgCO<sub>2</sub> for the electricity- and heat-led operational strategies, respectively.

**Table 4** Performance of the three considered operational strategies: Overall comparison

Variable	Description [unit]	Electricity-led	Heat-led	Improved
$E_{LHV,in}$	Total fuel (CH <sub>4</sub> ) input [kWh]	15630	26475	13805
$E_{el,prod}$	Total annual electricity production [kWh]	4984	7164	4533
$E_{el,imp}$	Total annual electricity import from the grid [kWh]	0	753	1127
$E_{el,exp}$	Total annual electricity export to the grid [kWh]	0	2933	676
$E_{heat,prod}$	Total annual heat production [kWh]	8136	12639	7334
$E_{heat,aux}$	Total heat provided by external means [kWh]	6502	0	5305
$E_{heat,dump}$	Total annual amount of heat dumping [kWh]	1999	0	0
$\eta_{sys}$	Average total system efficiency (%)	71.2	74.8	85.9
$\eta_{el,net}$	Average net electrical system efficiency (%)	31.9	27.1	32.8
$\eta_{th}$	Average thermal system efficiency (%)	39.3	47.7	53.1
$e_{CO_2}$	Total system CO <sub>2</sub> emissions [kgCO <sub>2</sub> ]	2931	4653	2609

By means of a GA-based optimization strategy, the model is improved in terms of net electrical efficiency (see paper IV). The nine decision variables used in the optimization process, shown in Table 5, were chosen with an initial value as typically found in the literature for the kind of system under study. Their allowable range of variation is chosen on the basis of component/process operational and/or structural limitations. Therefore these constraints are based on knowledge of the solution space and on observation of the behavioral pattern of the optimization algorithm. The final optimum value of the objective function has modified the initial values of the nine decision variables. The final value of the steam-to-carbon ratio differs greatly when compared to the initial one (4.00 vs. 2.91). This deviation suggests that a high amount of steam results in significant system losses, because of the lack of heat recovery in the condenser. Another significant change was in the value of the combustor flue gas temperature, which was reduced from 1173 to 1095 K, while the SMR reformat inlet temperature was increased from 400 to 530 K. This variation results from the higher temperature in the SMR reactor inlet, which converts hydrogen more effectively in a restricted reactor area.

The objective function was improved greatly, 40.9% compared to the initial 32.6%, suggesting that there was indeed a large space of improvement, with respect to the selected objective function. The maximization evolution of the

**Table 5** Initial, minimum, maximum and optimum values of the decision variables used in the optimization procedure.

Variable	Description (unit)	Initial	Min	Max	Optimum
$S/C$	Steam-to-carbon ratio	4.000	2.500	4.000	2.908
$\lambda_{H_2}$	Hydrogen stoichiometry	1.500	1.500	1.550	1.509
$n_{tubes}^{SMR}$	Number of tubes in the SMR	275	275	300	297
$L_{reactor}^{SMR}$	SMR reactor length (m)	1.800	1.800	2.000	1.994
$L_{reactor}^{WGS}$	WGS reactor length (m)	0.350	0.350	0.500	0.465
$T_{fg,out}^{Comb}$	Combustor output temperature (K)	1173	1050	1174	1095
$T_{ref,in}^{SMR}$	SMR reformate inlet temperature (K)	400	399	530	530
$T_{ref,in}^{WGS}$	WGS reformate inlet temperature (K)	499	470	500	474
$T_{fg,in}^{FP}$	Fuel preheater flue gas inlet temperature (K)	670	550	670	620

objective function, in terms of generations, is shown in Figure 14. The improvement accelerates quickly in the beginning of the optimization process, while after the 50<sup>th</sup> generation the increase is slower. After the 280<sup>th</sup> generation the maximization is marginal and almost constant towards the end. This flat behavior indicates that the overall iterative optimization scheme has practically converged.

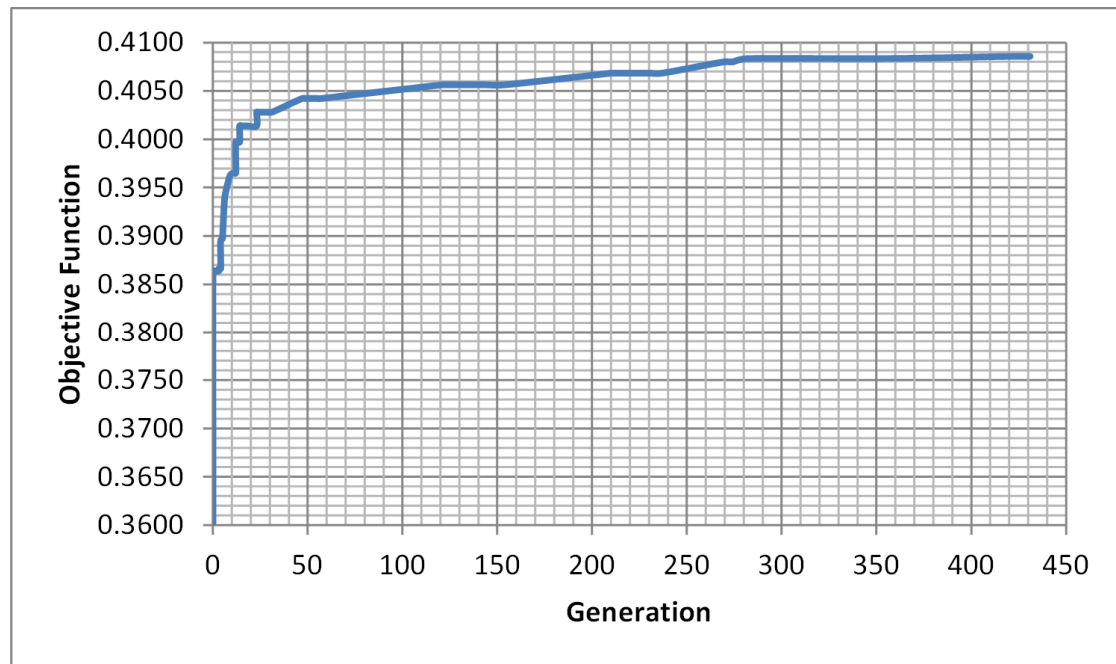

**Figure 14** Evolution of the objective function throughout the optimization procedure.



A more advanced optimization methodology, based on pinch analysis and process integration techniques, is then formulated and applied to the micro-CHP simulation model (see paper V). The new methodology combines two optimization strategies: (a) GA (see paper IV) and (b) MINLP. By means of a systematic methodology involving selection of the stream data set, pinch analysis and process change, the system is optimized in regards to net electrical efficiency maximization. Initially, basic pinch analysis techniques are applied to obtain an initial HEN configuration that encompasses the need for MER (minimum energy requirement, or equivalently, maximum energy recovery). An analysis of the CCs (composite curves) and the GCC (grand composite curve) allows the study of process modifications that will further improve the integrated system operation.

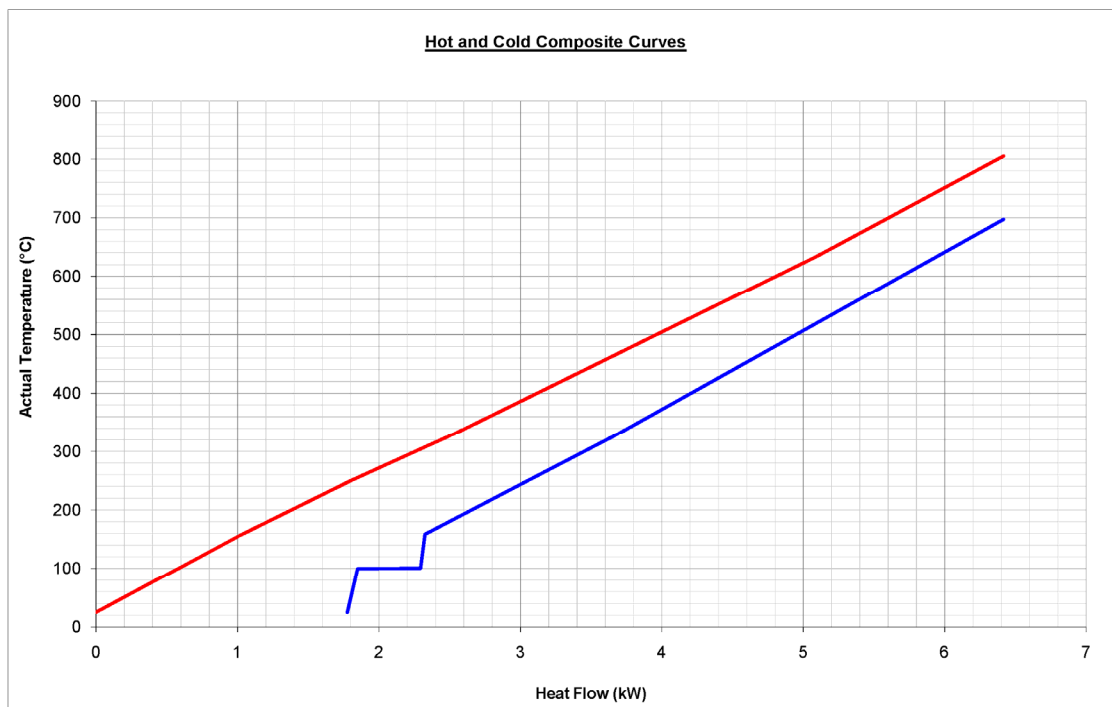

**Figure 15** Hot and cold composite curves extracted from the initial process stream data set.

The next step is the application of the simultaneous optimization algorithm, which is applied in an effort to reach an optimum HEN configuration, based on total cost considerations. The CCs (see Figure 15) describe the total heating and cooling demands of the system as a function of temperature intervals. The overlap between the two curves represents the maximum amount of heat recovery possible within the process. An observation in the upper right corner indicates no external heating is required, but on the other hand, a significant amount of cooling is required, as observed in the lower left part of the figure. Since this analysis resulted in a threshold problem with a single pinch, no

redesigning of the original HEN configuration is required if only MER is needed. On the other hand, process change techniques can be applied below the pinch to: (a) decrease the total hot stream load and (b) increase the total cold stream load. One of the streams allowing modification is the SMR reactor inlet temperature. On the contrary, the WGS reactor, combustor and fuel cell stack inlet/outlet temperature streams cannot be modified, since they are either fixed or dependent. The GA simulation includes four independent design parameters, shown in Table 6, with their range of variation.

**Table 6** Design parameters with their range of variation used in the process change optimization.

Variable	Description (unit)	Initial	Min	Max	Optimum
$T_6$	Inlet temperature of the methane-steam mixture to the SMR reactor (K)	599	400	600	587
$T_{11}$	Inlet temperature of the flue gas to the methane preheater (K)	626	500	700	597
$\dot{m}_{17}$	SMR reactor input flue gas mass flow rate (kg/s)	6.82E-3	6.50E-3	6.87E-3	6.55E-3
$S/C$	Steam-to-carbon ratio (-)	3.19	2.50	4.00	2.83

Pinch analysis is then repeated for the new stream data set obtained by the optimization strategy. The procedure accomplished minimization of the cold utility requirement from 1.78 to 1.54 kW. In a threshold problem it is necessary to distinguish its characteristics. The system performance is then tested at part-load operation to examine the response of the model at off-design conditions<sup>15</sup>. The variation of efficiency at different net electrical power outputs is shown in Figure 16. As the load decreases, the net electrical efficiency increases linearly, while the thermal efficiency and total efficiency decrease because of heat losses.

Since component<sup>16</sup> temperatures and areas remain constant at all loads, heat losses have an increasing effect at lower operational loads (see Figure 17). Therefore, system operation at low, and especially critical, loads may not be favored at periods of high demand on cogeneration heat. The greater loss is due to the SMR reactor, which although it is heavily insulated, it contributes 50% of the losses. This is due to the high temperature flows (reformat and flue gas) occurring in the SMR reactor. Finally, the MINLP model is applied using

15. In a realistic system, part-load conditions may not allow smooth operation without the use of BOP components, such as by-pass valves between heat exchangers.

16. Heat losses are considered for three components: (a) Fuel cell stack, (b) Combustor and (c) SMR reactor. Heat losses for the WGS reactor are neglected, since the process is slightly exothermic. Also, heat losses for heat exchanger units are not considered, because the HEN configuration is not known *a priori*.

GAMS. The compact nature of the micro-CHP system does not favor the use of stream splitting, and therefore this is restricted in the code. In addition to the potentially more complex operation, stream splitting would require an additional investment cost for a control valve.

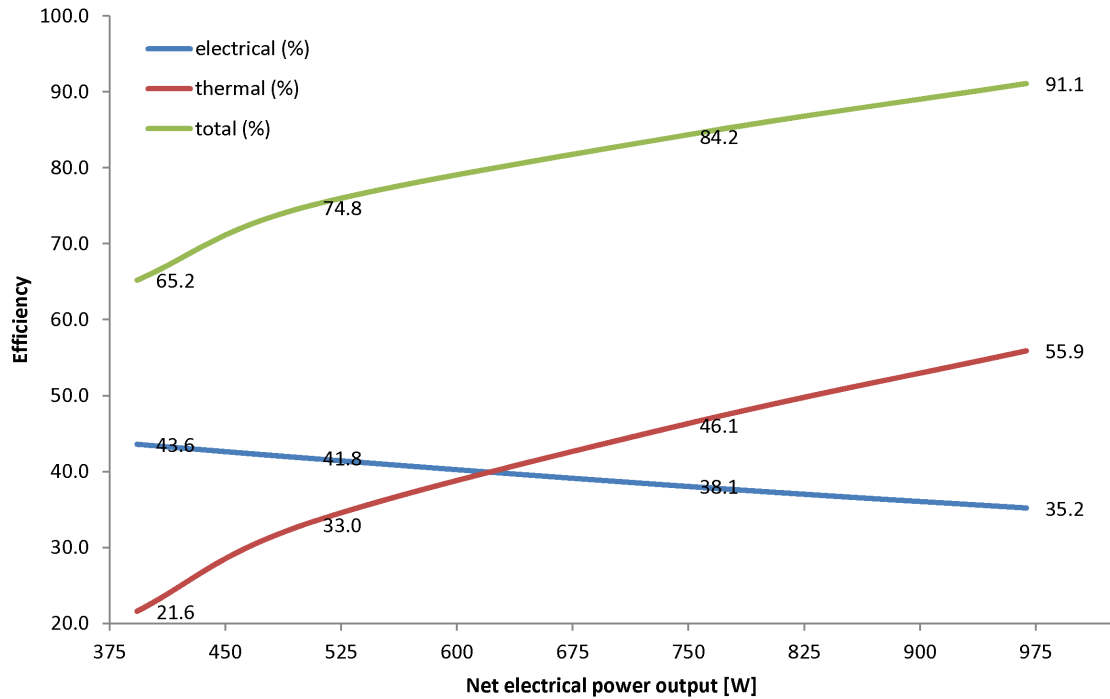

Figure 16 Variation of efficiency at different operating loads.

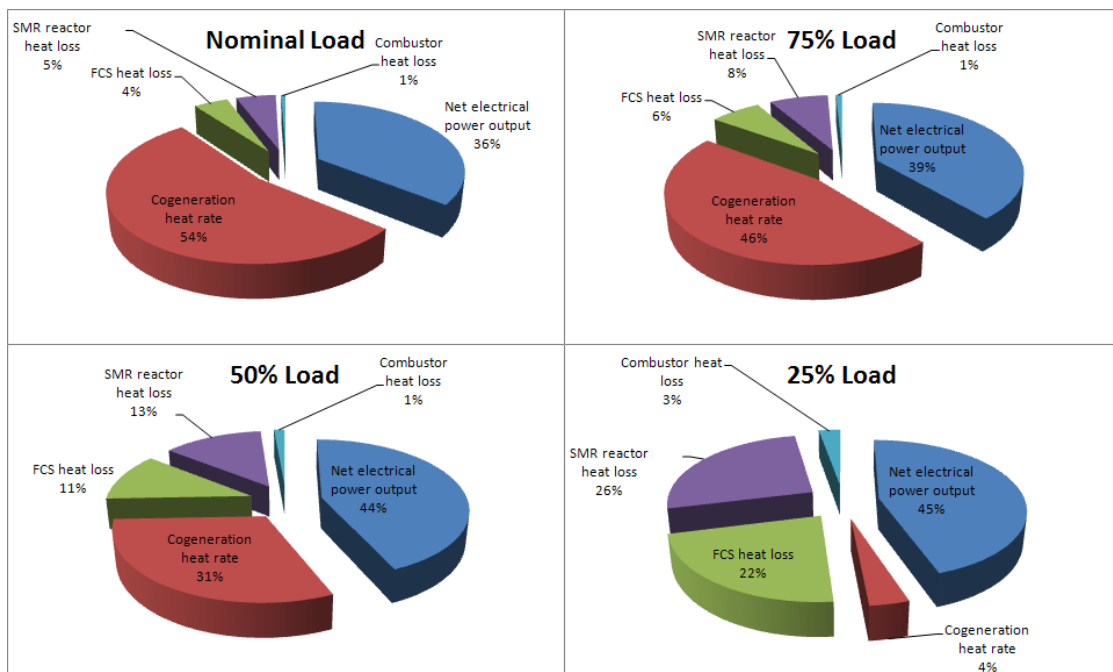
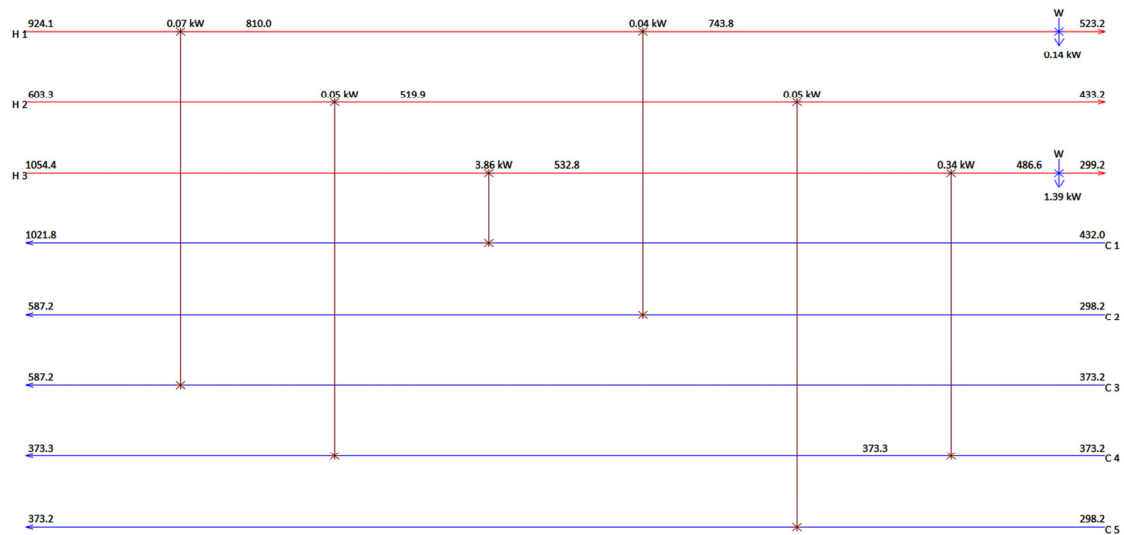
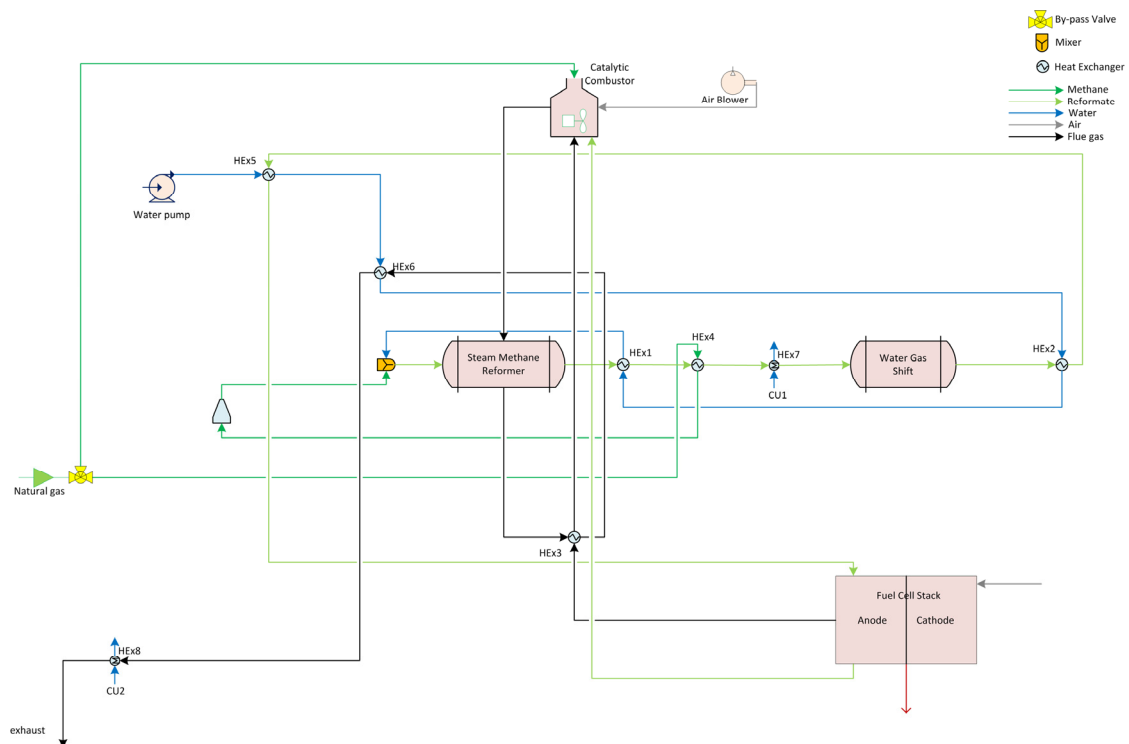

Figure 17 System power output and component heat losses.

The grid diagram representation, shown in Figure 18, shows the heat transfer operation of the optimum HEN. Hot streams are at the top running from left to right, while cold streams are located at the bottom running from right to left. Heat exchange matches are represented by vertical lines joining two arrows on the two streams being matched.



**Figure 18** Configuration after the application of the simultaneous HEN optimization.



**Figure 19** Configuration of the proposed micro-CHP system after the application of the simultaneous HEN optimization.

The coupling of the optimized HEN configuration with the micro-CHP system is shown in Figure 19. The new configuration is significantly different than the original one, due to the cost reduction requirements imposed in the objective function. Therefore, the optimum configuration encompasses the need for heat exchangers with a cheaper structure, such as a minimum heat transfer area. The heat exchangers must allow a more cost efficient heat transfer distribution along the streams, although the total number of heat exchangers remains the same.

Overall, the efficiency was improved from an initial value of 31.9% to an optimum value of 35.2% (at full-load). The highest net electrical efficiency was 43.6%, while the highest total system efficiency was 91.1%. The MINLP optimization strategy, managed to reach a minimized HEN total cost of \$8,147/year. The new HEN configuration is significantly different than the initial one, indicating the level of improvement made after the application of the optimization strategy. Finally, it should be noted that a more complete analysis should include part-load results for the new HEN configuration. This can be accomplished by modification of the original micro-CHP system simulation model, to verify that HEN operability is indeed feasible.

## 5 Conclusions and Future Work

This thesis work has defined and completed a series of tasks to address the main research question associated with the modeling, design and optimization of a HT-PEMFC-based micro-CHP system. Components and subsystems are modeled from first principles or modified previously developed models are used to build up the total simulation system model. The obtained simulation system models (see papers I-II) are validated successful using a comparable model from the literature (Korsgaard et al., 2008).

### 5.1 Conclusions

*A posteriori*, it can be concluded that the structure of the five study topics could have been completed in a slightly different order. After topic #2, topic #3 could have been left as the final topic of the research project. This is because the system is optimized during topics #4-5, suggesting that better results could have been obtained if an optimum system configuration was used to reach an improved operational strategy. Further on, the first study topic proved to be very time consuming and not so influential in the overall progression of the research project. Therefore, if the project was repeated, this part would have been omitted. If the two modeling methods, LabVIEW™ and EES-based simulations, are compared, it can be concluded that EES modeling is easier and possesses more capabilities, as illustrated throughout this research work. Moreover, although LabVIEW™ simulations can provide a high degree of easiness to the end user in terms of calculating manipulation, it is difficult to model and modify highly complicated models, due to the graphical nature of the program. Also LabVIEW™ has a limited number of parameters that can be transferred from a subVI to the main VI (Virtual Instrument). Therefore, LabVIEW™ modeling is more appropriate for single component dynamic systems.

To provide a specific answer to the main research question, the following points are used to summarize the benefits of the proposed system:

- *High efficiencies.* The simulated system provides the ability of reaching high net electrical system efficiencies 35 to 44% (see papers IV-V). Also high overall efficiencies are obtained (up to 91% when component heat losses are included). As compared to non-fuel cell-based micro-CHP systems, namely ICE and SE types, the proposed system is not a heat engine, and thereby non-Carnot-limited.
- *Low CO<sub>2</sub> emissions.* This is due to the high efficiency obtainable by the proposed system which reduces the fuel consumption requirement, while the presence of a catalytic burner ensures no traces of unburned fuel are left in the atmosphere.
- *Simplified fuel processor.* The PBI fuel cell technology allows the intake of lower quality hydrogen-rich reformat fuel. This fact suggests a simpler fuel processing subsystem can be coupled, with only a SMR and a single-stage temperature WGS reactor. This is because the PBI-based fuel cell stack allows carbon monoxide contents up to 5% (Serenergy, 2011).
- *Operational modularity.* The proposed system can operate efficiently within a wide range of operation.

Nafion-based systems can exhibit slightly higher fuel cell efficiencies. Nevertheless, very high quality reformat gas is required, which makes them less favorable when pure hydrogen is unavailable (as in the application under study). This in turn increases the capital cost for building these systems. Finally, heat engine-based systems are in general more mature technologies and possess a lower capital cost. These are their main advantages, as compared to the proposed system. Nevertheless, their heat-engine “nature”, with low operational performances makes them unattractive for future development.

Finally, the proposed micro-CHP is capable of achieving high efficiencies, which are comparable with the most efficient centralized systems (CCGT). Nevertheless, further development is needed, in terms of system reliability and realistic design. The most important barrier for the adoption of the system under study is the high lifecycle cost. It could be argued that a solution with a lower investment cost, than the proposed system, would be a purely network grid/electric heat pump combination. But, in this scenario, the electrical load demand would increase rapidly, since all the heating and electrical load demands would be satisfied with electricity. Therefore, the increased need for electricity would result in congestion of the distribution networks during peak times. The possibility for network congestion will increase in the future, since the increasing production of electricity by renewable energy sources, e.g. wind

power, is largely unpredictable and uncontrollable. In other words, there is a mismatch between generation and demand. The proposed system can diminish, or at least lower, the possibility of the aforementioned unpleasant situation, since the greatest portion of the required heating and electricity demands are produced and consumed onsite.

## 5.2 Future Work

All research study topics initially planned were completed successfully, but a number of topics can be investigated further in future studies. The most important topics are summarized below:

- A greater input on the reliability of both the fuel cell stack and the fuel processing subsystem is still needed. Great care should be given in relation to operation of the system under harsh conditions for long periods. These may include high amounts of carbon monoxide in the reformat fuel, different steam-to-carbon ratios and operational temperatures.
- The development of a dynamic simulation model, based on experimental data, for the micro-CHP system could provide input on the effect of load variation, including system start-up and shut down, on its performance.
- The effect of a possible cooling load demand could be investigated with the development of a heat pump subsystem, and subsequent coupling with the micro-CHP system (Georgopoulos, 2002; Gunes & Ellis, 2003).
- Thermo-economic optimization and exergy analysis could provide insights into the overall synthesis, design, and operational problem, since it accounts both for the quantity and quality of all energy conversions present in a process. Its objective is to analyze the judicious expenditure of exergy to reduce not just fuel costs, but also total costs (Rancruel, 2005).





## References

- Ahlstrom-Silversand, A. F., & Odenbrand, C. U. I. (1999). Modelling catalytic combustion of carbon monoxide and hydrocarbons over catalytically active wire meshes. *Chemical Engineering Journal*, 73(3), 205-216. doi:10.1016/S1385-8947(99)00029-7
- Al-Sulaiman, F. A., Hamdullahpur, F., & Dincer, I. (2011). Trigeneration: A comprehensive review based on prime movers. *International Journal of Energy Research*, (March 2010), 233-258. doi:10.1002/er
- Ang, S. M. C., Fraga, E. S., Brandon, N. P., Samsatli, N. J., & Brett, D. J. L. (2011). Fuel cell systems optimisation – Methods and strategies. *International Journal of Hydrogen Energy*, 36(22), 14678-14703. Elsevier Ltd. doi:10.1016/j.ijhydene.2011.08.053
- Arsalis, A. (2007). *Thermoeconomic modeling and parametric study of hybrid SOFC–gas turbine–steam turbine power plants ranging from 1.5 to 10 MWe*. M.S. thesis, advisor: M.R. von Spakovsky, Virginia Polytechnic Institute & State University, Blacksburg, Virginia.
- Arsalis, A. (2008). Thermoeconomic modeling and parametric study of hybrid SOFC–gas turbine–steam turbine power plants ranging from 1.5 to 10 MWe. *Journal of Power Sources*, 181(2), 313-326. doi:10.1016/j.jpowsour.2007.11.104
- Autissier, N., Palazzi, F., Marechal, F., van Herle, J., & Favrat, D. (2007). Thermo-Economic Optimization of a Solid Oxide Fuel Cell, Gas Turbine Hybrid System. *Journal of Fuel Cell Science and Technology*, 4(2), 123. doi:10.1115/1.2714564
- BAXI. (2011a). Baxi SenerTec Dachs - Internal Combustion Engine. Retrieved November 11, 2011, a from <http://www.baxi.co.uk/products/DACHS.htm>

- BAXI. (2011b). Baxi Innotech. Retrieved October 21, 2011, b from <http://www.baxi-innotech.de>
- Barbir, F. (2005). *PEM Fuel Cells: Theory and Practice*. Elsevier.
- Barclay, F. J. (2006). *Fuel Cells, Engines and Hydrogen: An Exergy Approach* (1st ed.). Chichester, UK: Wiley.
- Beckers, G. J. (2006). Development of a DCHP unit based on a Free Piston Stirling Engine. Retrieved November 20, 2011, from [http://www.dgs.de/uploads/media/06\\_Ger\\_Beckers\\_ENATEC.pdf](http://www.dgs.de/uploads/media/06_Ger_Beckers_ENATEC.pdf)
- Biegler, L. T., Grossmann, I. E., & Westerberg, A. W. (1997). *Systematic Methods of Chemical Process Design* (1st ed.). Prentice Hall.
- Brown, M. (2011). Cogeneration growth in Europe - Smaller systems have better prospects. *Cogeneration & On-Site Power Production*, (July-August), 13-17.
- Büchi, F. N., Inaba, M., & Schmidt, T. J. (2009). *Polymer Electrolyte Fuel Cell Durability* (pp. 81-82; 199-221; 447-463). New York, NY, USA: Springer. doi:10.1007/978-0-387-85536-3
- Calise, F., Dentice d'Accadia, M., Palombo, A., & Vanoli, L. (2006). Simulation and exergy analysis of a hybrid Solid Oxide Fuel Cell (SOFC)–Gas Turbine System. *Energy*, 31(15), 3278-3299. doi:10.1016/j.energy.2006.03.006
- Calise, F., Dentice d'Accadia, M., Vanoli, L., & von Spakovsky, M. R. (2006). Single-level optimization of a hybrid SOFC–GT power plant. *Journal of Power Sources*, 159(2), 1169-1185. doi:10.1016/j.jpowsour.2005.11.108
- Callux. (2009). Callux, Praxistest Brennstoffzelle fürs Eigenheim. Retrieved February 2, 2011, from <http://www.callux.net>
- Ceramic Fuel Cells Ltd. (2010). Fuel Cell Module for Highly Efficient Electricity. Retrieved November 20, 2011, from [http://www.cfcl.com.au/Assets/Files/Gennex\\_Brochure\\_\(ENG\)\\_April\\_2010.pdf](http://www.cfcl.com.au/Assets/Files/Gennex_Brochure_(ENG)_April_2010.pdf)
- Charbonneau, P. (2002). *An Introduction to Genetic Algorithms for Numerical Optimization*. Boulder, Colorado: High Altitude Observatory, National

Center for Atmospheric Research. Retrieved from  
<http://www.hao.ucar.edu/modeling/pikaia/pikaia.php>

Chicco, G., & Mancarella, P. (2009). Distributed multi-generation: A comprehensive view. *Renewable and Sustainable Energy Reviews*, 13(3), 535-551. doi:10.1016/j.rser.2007.11.014

Chong, E. K. P., & Zak, S. H. (2001). *An Introduction to Optimization* (2nd ed.). New York, NY, USA: Wiley.

ClearEdge Power. (2011). ClearEdge5. Retrieved November 20, 2011, from  
<http://clearedgepower.com/sites/default/files/Commercial DS 05.26.11 v2.pdf>

DONG Energy. (2011). Gas-fired power plants. Retrieved November 24, 2011, from <http://www.dongenergy.com>

Danish Micro-CHP. (2009). Danish Micro Combined Heat and Power. Retrieved August 3, 2011, from <http://www.dk-mchp.eu/>

De Paepe, M., & Mertens, D. (2007). Combined heat and power in a liberalised energy market. *Energy Conversion and Management*, 48(9), 2542-2555. doi:10.1016/j.enconman.2007.03.019

Delta Energy & Environment Ltd. (2010). Micro-CHP Markets – Status and Outlook. In D. Morgado (Ed.), *Danish micro-CHP Workshop*. Sønderborg, Denmark.

Dentice d'Accadia, M., Sasso, M., Sibilio, S., & Vanoli, L. (2003). Micro-combined heat and power in residential and light commercial applications. *Applied Thermal Engineering*, 23(10), 1247-1259. doi:10.1016/S1359-4311(03)00030-9

Dijkstra, S. (2010). Micro-CHP: Edging towards the mass market. *Cogeneration and On-Site Power Production*, (August 2009), 1-4.

Energetix Group. (2010). Energetix Genlec Ltd unveils “Kingston” micro-CHP boiler. Retrieved November 21, 2011, from  
[http://online.hemscottir.com/servlet/HsPublic?context=ir.access&ir\\_option=RNS\\_NEWS&publicationGroup=RNS&item=374407331581355&ir\\_client\\_id=5778](http://online.hemscottir.com/servlet/HsPublic?context=ir.access&ir_option=RNS_NEWS&publicationGroup=RNS&item=374407331581355&ir_client_id=5778)

- Energy Efficiency News. (2011). Vaillant and Honda launch micro-CHP systems for homes. Retrieved November 21, 2011, from <http://www.energyefficiencynews.com/co-generation/i/3789/>
- Ferguson, A. (2004). Fuel cell modelling for building cogeneration applications. *Journal of Power Sources*, 137, 30-42. doi:10.1016/j.jpowsour.2004.05.021
- Georgopoulos, N. G. (2002). *Application of a Decomposition Strategy to the Optimal Synthesis/Design and Operation of a Fuel Cell Based Total Energy System*. M.S. thesis, advisor: M.R. von Spakovsky, Virginia Polytechnic Institute & State University, Blacksburg, Virginia.
- Godat, J., & Marechal, F. (2003). Optimization of a fuel cell system using process integration techniques. *Journal of Power Sources*, 118(1-2), 411-423. doi:10.1016/S0378-7753(03)00107-1
- Grossmann, I. E. (2004). Part II. Future perspective on optimization. *Computers & Chemical Engineering*, 28, 1193-1218. doi:10.1016/j.compchemeng.2003.11.006
- Gummert, G. (2008). Baxi mCHP solutions: Heating and Electricity today and tomorrow. *Gas Industry mCHP Workshop*. Paris, France.
- Gunes, M. B., & Ellis, M. W. (2003). Evaluation of Energy, Environmental, and Economic Characteristics of Fuel Cell Combined Heat and Power Systems for Residential Applications. *Journal of Energy Resources Technology*, 125(3), 208. doi:10.1115/1.1595112
- Hawkes, A. D., & Leach, M. A. (2005a). Impacts of temporal precision in optimisation modelling of micro-Combined Heat and Power. *Energy*, 30(10), 1759-1779. doi:10.1016/j.energy.2004.11.012
- Hawkes, A. D., & Leach, M. A. (2005b). Solid oxide fuel cell systems for residential micro-combined heat and power in the UK: Key economic drivers. *Journal of Power Sources*, 149, 72-83. doi:10.1016/j.jpowsour.2005.01.008
- Hawkes, A. D., & Leach, M. A. (2007). Cost-effective operating strategy for residential micro-combined heat and power. *Energy*, 32(5), 711-723. doi:10.1016/j.energy.2006.06.001

- Hawkes, A. D., & Leach, M. A. (2008). The capacity credit of micro-combined heat and power. *Energy Policy*, 36(4), 1457-1469. doi:10.1016/j.enpol.2007.12.022
- Hawkes, A. D., & Leach, M. A. (2009). Modelling high level system design and unit commitment for a microgrid. *Applied Energy*, 86(7-8), 1253-1265. Elsevier Ltd. doi:10.1016/j.apenergy.2008.09.006
- Hawkes, A. D., Aguiar, P., Croxford, B., Leach, M. A., Adjiman, C., & Brandon, N. P. (2007). Solid oxide fuel cell micro combined heat and power system operating strategy: Options for provision of residential space and water heating. *Journal of Power Sources*, 164(1), 260-271. doi:10.1016/j.jpowsour.2006.10.083
- Hawkes, A. D., Aguiar, P., Hernandez-Aramburo, C., Leach, M. A., Brandon, N. P., Green, T., & Adjiman, C. (2006). Techno-economic modelling of a solid oxide fuel cell stack for micro combined heat and power. *Journal of Power Sources*, 156(2), 321-333. doi:10.1016/j.jpowsour.2005.05.076
- Hubert, C., Achard, P., & Metkemeijer, R. (2006). Study of a small heat and power PEM fuel cell system generator. *Journal of Power Sources*, 156(1), 64-70. doi:10.1016/j.jpowsour.2005.08.022
- Inui, Y., Yanagisawa, S., & Ishida, T. (2003). Proposal of high performance SOFC combined power generation system with carbon dioxide recovery. *Energy Conversion and Management*, 44, 597-609.
- Jahn, H., & Schroer, W. (2005). Dynamic simulation model of a steam reformer for a residential fuel cell power plant. *Journal of Power Sources*, 150, 101-109. doi:10.1016/j.jpowsour.2005.02.012
- Jannelli, E., Minutillo, M., & Galloni, E. (2007). Performance of a Polymer Electrolyte Membrane Fuel Cell System Fueled With Hydrogen Generated by a Fuel Processor. *Journal of Fuel Cell Science and Technology*, 4(4), 435. doi:10.1115/1.2756568
- Kehlhofer, R., Bachmann, R., Nielsen, H., & Warner, J. (1999). *Combined Cycle Gas & Steam Turbine Power Plants* (2nd ed.). Tulsa, Oklahoma: PennWell.
- Keiski, R. L., Salmi, T., Niemisto, P., Ainassaari, J., & Pohjola, V. J. (1996). Stationary and transient kinetics of the high temperature water-gas shift reaction. *Applied Catalysis A: General*, 137(2), 349-370. doi:10.1016/0926-860X(95)00315-0

- Kemp, I. C. (2007). *Pinch Analysis and Process Integration: A User Guide on Process Integration for the Efficient Use of Energy* (2nd ed.). Butterworth-Heinemann.
- Kim, K., von Spakovsky, M. R., Wang, M., & Nelson, D. J. (2010). A hybrid multi-level optimization approach for the dynamic synthesis/design and operation/control under uncertainty of a fuel cell system. *Energy*. Elsevier Ltd. doi:10.1016/j.energy.2010.08.024
- Kolb, G. (2008). *Fuel Processing for Fuel Cells* (1st ed.). Weinheim, Germany: Wiley-VCH.
- Korsgaard, A. R. (2011). Personal communication concerning water-content in the fuel cell stack anode inlet. Aalborg, Denmark.
- Korsgaard, A. R., Nielsen, M. P., & Kær, S. K. (2008). Part one: A novel model of HTPEM-based micro-combined heat and power fuel cell system. *International Journal of Hydrogen Energy*, 33(7), 1921-1931. doi:10.1016/j.ijhydene.2008.01.008
- Korsgaard, A. R., Nielsen, M. P., Bang, M., & Kær, S. K. (2006). Modeling of CO Influence in PBI Electrolyte PEM Fuel Cells. *FUELCELL2006*. Irvine, CA.
- Korsgaard, A. R., Refshauge, R., Nielsen, M. P., Bang, M., & Kær, S. K. (2006). Experimental characterization and modeling of commercial polybenzimidazole-based MEA performance. *Journal of Power Sources*, 162(1), 239-245. doi:10.1016/j.jpowsour.2006.06.099
- Larminie, J., & Dicks, A. L. (2003). *Fuel Cell Systems Explained* (2nd ed.). Chichester, UK: Wiley.
- Linnhoff, B., & Flower, J. R. (1978a). Synthesis of heat exchanger networks: I. Systematic generation of energy optimal networks. *AIChE Journal*, 24(4), 633-642. doi:10.1002/aic.690240411
- Linnhoff, B., & Flower, J. R. (1978b). Synthesis of heat exchanger networks: II. Evolutionary Generation of Networks with Various Criteria of Optimality. *AIChE Journal*, 24(4), 642-654.
- Linnhoff, B., & Hindmarch, E. (1983). The pinch design method for heat exchanger networks. *Chemical Engineering Science*, 38(5), 745-763.

- Lund, P. (2008). Analysis of advanced energy chain typologies. *International Journal of Energy Research*, (May 2007), 144-153. doi:10.1002/er
- Mench, M. M. (2008). *Fuel Cell Engines* (1st ed.). Hoboken, New Jersey: Wiley.
- O'Hayre, R., Colella, W., Cha, S.-W., & Prinz, F. B. (2009). *Fuel Cell Fundamentals* (2nd ed.). Hoboken, New Jersey: Wiley.
- Palazzi, F., Autissier, N., Marechal, F., & Favrat, D. (2007). A methodology for thermo-economic modeling and optimization of solid oxide fuel cell systems. *Applied Thermal Engineering*, 27, 2703-2712. doi:10.1016/j.applthermaleng.2007.06.007
- Pehnt, M., Cames, M., Fischer, C., Praetorius, B., Schneider, L., Schumacher, K., & Voss, J.-P. (2006). *Micro Cogeneration: Towards Decentralized Energy Systems. Cogeneration*. Springer.
- Ponce-Ortega, J., Jimenez-Gutierrez, A., & Grossmann, I. E. (2008). Optimal synthesis of heat exchanger networks involving isothermal process streams. *Computers & Chemical Engineering*, 32(8), 1918-1942. doi:10.1016/j.compchemeng.2007.10.007
- Praetorius, B., Bauknecht, D., Cames, M., Fischer, C., Pehnt, M., Schumacher, K., & Voss, J.-P. (2009). *Innovation for Sustainable Electricity Systems. Change* (1st ed.). Heidelberg, Germany: Physica-Verlag.
- Rancruel, D. F. (2005). *Dynamic Synthesis/Design and Operation/Control Optimization Approach applied to a Solid Oxide Fuel Cell based Auxiliary Power Unit under Transient Conditions*. PhD Dissertation, advisor: M.R. von Spakovsky, Virginia Polytechnic Institute & State University, Blacksburg, Virginia.
- Raven, R., & Verbong, G. (2007). Multi-Regime Interactions in the Dutch Energy Sector: The Case of Combined Heat and Power Technologies in the Netherlands 1970-2000. *Technology Analysis & Strategic Management*, 19(4), 491-507. doi:10.1080/09537320701403441
- Ravindran, A., Ragsdell, K. M., & Reklaitis, G. V. (2006). *Engineering Optimization: Methods and Applications* (2nd ed.). Hoboken, New Jersey: Wiley.



- Ropenus, S., Schröder, S. T., Costa, A., & Obé, E. (2010). Support Schemes and Ownership Structures: The Policy Context for Fuel Cell Based Micro-Combined Heat and Power. Risø, Denmark. Retrieved November 25, 2011, from [http://www.bigscience.dk/sitecore/content/Risoe\\_dk/Home/Knowledge\\_base/publications/Reports/ris-r-1730.aspx?sc\\_lang=en](http://www.bigscience.dk/sitecore/content/Risoe_dk/Home/Knowledge_base/publications/Reports/ris-r-1730.aspx?sc_lang=en)
- Salcines, D. S., Estébanez, C. R., & Herrero, V. C. (2004). Simulation of a solar domestic water heating system with different collector efficiencies and different volumen storage tanks. *International Conference on Renewable Energies and Power Quality*. Barcelona.
- Serenergy. (2011). serenergy.dk. Retrieved February 2, 2011, from <http://www.serenergy.dk/>
- Sieniutycz, S., & Jezowski, J. (2009). *Energy Optimization in Process Systems* (1st ed.). Amsterdam: Elsevier.
- Slowe, J. (2010). Can small make it big? The progress of micro-CHP in world mass markets. Retrieved November 20, 2011, from <http://www.cospp.com/articles/print/volume-7/issue-4/features/can-small-make-it-big-the-progress-of-micro-chp-in-world-mass-markets.html>
- Smith, R. (2005). *Chemical Process Design and Integration*. Chichester, UK: Wiley.
- Stolten, D. (2010). *Hydrogen and Fuel Cells: Fundamentals, Technologies and Applications* (1st ed.). Weinheim, Germany: Wiley-VCH.
- Stolten, D. (2011). Personal communication concerning water-content in the fuel cell stack anode inlet. Aalborg, Denmark.
- Thomas, B. (2008). Benchmark testing of Micro-CHP units. *Applied Thermal Engineering*, 28(16), 2049-2054.  
doi:10.1016/j.applthermaleng.2008.03.010
- Tokyo Gas Ltd. (2011). Tokyo Gas and Panasonic to Launch New Improved “Ene-Farm” Home Fuel Cell with World-Highest Generation Efficiency at More Affordable Price. Retrieved November 20, 2011, from [http://www.tokyo-gas.co.jp/Press\\_e/20110209-01e.pdf](http://www.tokyo-gas.co.jp/Press_e/20110209-01e.pdf)

- Vaillant. (2011). Vaillant Ecopower. Retrieved November 20, 2011, from [http://www.vaillant.de/Presse/Press-Releases/article/Vaillant\\_first\\_full-range\\_supplier\\_for\\_combined\\_heat\\_and\\_power\\_in\\_the\\_small\\_output\\_range.html](http://www.vaillant.de/Presse/Press-Releases/article/Vaillant_first_full-range_supplier_for_combined_heat_and_power_in_the_small_output_range.html)
- Verda, V., & Nicolin, F. (2010). Thermodynamic and economic optimization of a MCFC-based hybrid system for the combined production of electricity and hydrogen. *International Journal of Hydrogen Energy*, 35(2), 794-806. Elsevier Ltd. doi:10.1016/j.ijhydene.2009.10.104
- Viswanathan, J., & Grossmann, I. E. (1990). A combined penalty function and outer approximation method for MINLP optimization. *Computers & Chemical Engineering*, 14(7), 769-782.
- Vogel, J., & Tsou, Y.-M. (2007). *Plug Power: International Stationary Fuel Cell Demonstration*.
- Wallmark, C., & Alvfors, P. (2002). Design of stationary PEFC system configurations to meet heat and power demands. *Journal of Power Sources*, 106, 83-92. doi:10.1016/S0140-6701(03)90808-3
- Weber, C., Marechal, F., Favrat, D., & Kraines, S. (2006). Optimization of an SOFC-based decentralized polygeneration system for providing energy services in an office-building in Tōkyō. *Applied Thermal Engineering*, 26(13), 1409-1419. doi:10.1016/j.applthermaleng.2005.05.031
- Westner, G., & Madlener, R. (2011). Development of cogeneration in Germany: A mean-variance portfolio analysis of individual technology's prospects in view of the new regulatory framework. *Energy*, 36(8), 5301-5313. Elsevier Ltd. doi:10.1016/j.energy.2011.06.038
- Woudstra, N., van der Stelt, T. P., & Hemmes, K. (2006). The Thermodynamic Evaluation and Optimization of Fuel Cell Systems. *Journal of Fuel Cell Science and Technology*, 3(2), 155. doi:10.1115/1.2174064
- Xu, J., & Froment, G. F. (1989a). Methane Steam Reforming, Methanation and Water-Gas Shift: I. Intrinsic Kinetics. *AIChE Journal*, 35(1), 88-96.
- Xu, J., & Froment, G. F. (1989b). Methane Steam Reforming: II. Diffusional Limitations and Reactor Simulation. *AIChE Journal*, 35(1), 97-103.

Yee, T. F., & Grossmann, I. E. (1990). Simultaneous optimization models for heat integration-II. Heat exchanger network synthesis. *Computers & Chemical Engineering*, 14(10), 1165-1184.

Zhang, Jianlu, Xie, Z., Zhang, J., Tang, Y., Song, C., Navessin, T., Shi, Z., et al. (2006). High temperature PEM fuel cells. *Journal of Power Sources*, 160, 872-891. doi:10.1016/j.jpowsour.2006.05.034

Zink, F., Lu, Y., & Schaefer, L. (2007). A solid oxide fuel cell system for buildings. *Energy Conversion and Management*, 48(3), 809-818. doi:10.1016/j.enconman.2006.09.010