



AALBORG UNIVERSITY
DENMARK

Aalborg Universitet

From policy to practice

Regulating for sustainability in construction

de Gier, Andreas Johan

Published in:
Building a Circular Future

Publication date:
2024

Document Version
Publisher's PDF, also known as Version of record

[Link to publication from Aalborg University](#)

Citation for published version (APA):
de Gier, A. J. (2024). From policy to practice: Regulating for sustainability in construction. In D. Lysgaard Vind (Ed.), *Building a Circular Future: Insights from Interdisciplinary Research* (pp. 71-72)

General rights

Copyright and moral rights for the publications made accessible in the public portal are retained by the authors and/or other copyright owners and it is a condition of accessing publications that users recognise and abide by the legal requirements associated with these rights.

- Users may download and print one copy of any publication from the public portal for the purpose of private study or research.
- You may not further distribute the material or use it for any profit-making activity or commercial gain
- You may freely distribute the URL identifying the publication in the public portal -

Take down policy

If you believe that this document breaches copyright please contact us at vbn@aub.aau.dk providing details, and we will remove access to the work immediately and investigate your claim.

BUILDING A CIRCULAR FUTURE

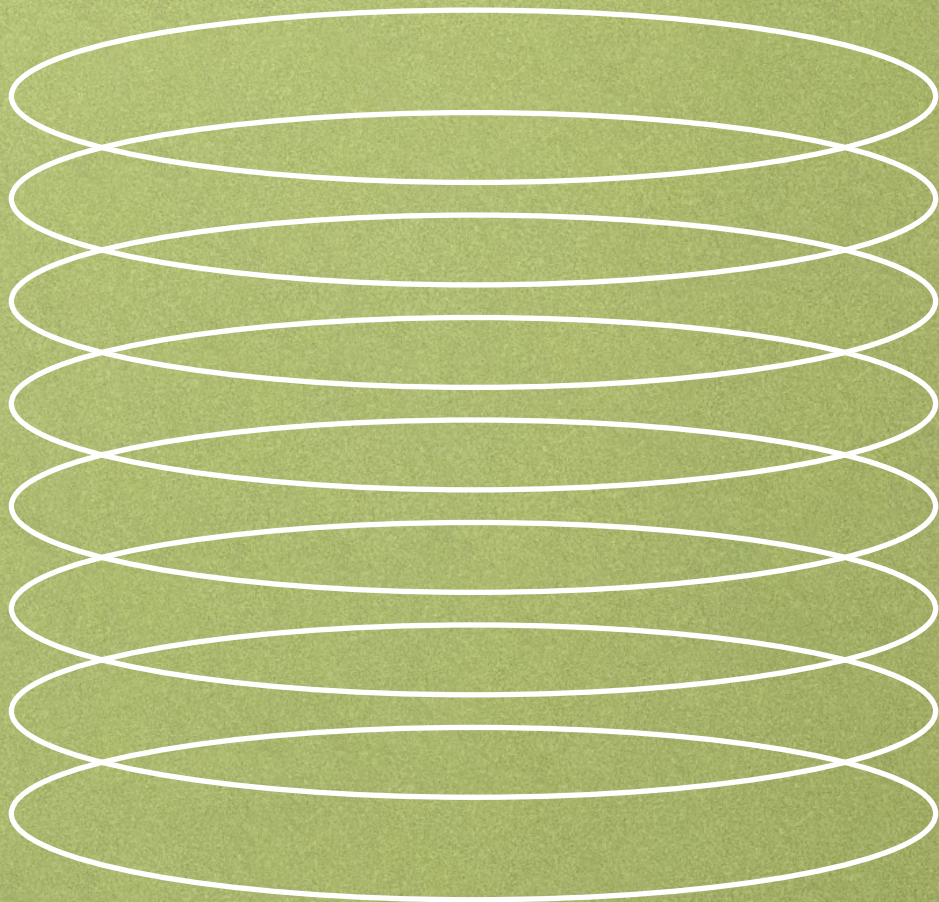

Insights from
Interdisciplinary Research

BUILDING A CIRCULAR FUTURE

Insights from
Interdisciplinary Research

Building A Circular Future
- Insights from Interdisciplinary Research

Copyright © 2024
By BLOXHUB



Scan QR code for online publication

Editor:

Ditte Lysgaard Vind, BLOXHUB

Book Design:

Louise Jacobsen, BLOXHUB

Photo credits:

Justine Høgh
(p.8-23, 182, 186)

Ditte Frisk Gidionsen, BLOXHUB
(p.78, 120, 170, 176)



/nnovationsfonden

The product is made of material from
well-managed FSC®-certified forests
and other controlled material.



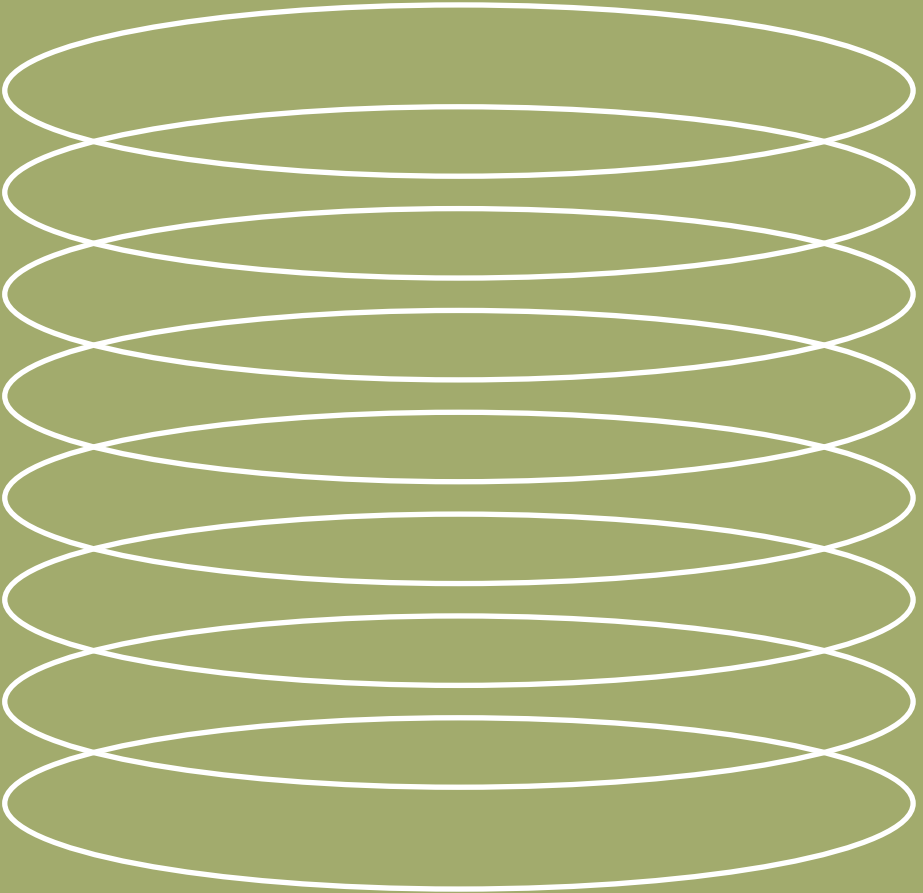

Contributors:

Andreas de Gier, Andreas Qvist Secher, Ann-Britt Elvin Andersen, Christian Gaeth, Christian Koch, Christian Thuesen, Ditte Frisk Gidionsen, Ditte Lysgaard Vind, Gunhild Askehave Rasso, Hanna Liv Leanderdal, Heidi Sørensen Merrild, Ingvild Reine Assmann, Jacob Blak, Jule Rumpel, Julia Köhler, Karoline Fogh Gustafsson, Kiel Moe, Lene Damsbo Brix, Lin Engholm Kjerulf, Lisbeth M. Ottosen, Lise Hvid Horup Sørensen, Lise Røjskjær Pedersen, Louise Jacobsen, Lotte Nystrup Lund, Martine Buser, Maxime Ranger, Maya Færch, Mia Kruse Rasmussen, Nicolaj Frederiksen, Nicolas Ramirez Ortiz, Ole Sinkjær, Olga Popovic Larsen, Robert Haff-Jensen, Sara Sofie Vestergaard, Sarah C. Andersen, Simon Kofod-Svendsen, Simon Sjøkvist, Stefan Christoffer Gottlieb, Thomas Bo Jensen, Thomas Fabian Delman, Vibeke Grupe Larsen, Viktoria Klansø, Xan Browne

CONTENTS

1. WHY A CIRCULAR BUILT ENVIRONMENT NETWORK

Joint intro from Realdania and the Danish Innovation Fund	13
Preface & reading guide	17
10 key insights from the publication	23

2. ECONOMY & SOCIETAL STRUCTURES

Introduction by Maya Færch.....	29
Articles	
Quantifying or qualifying the circular economy?	33
Standardization for the circular economy: Is there a sweet spot between standardization and individualization of construction?.....	37
Voluntary standards and standardization: A necessity or threat to the circular economy?.....	43
Abstracts.....	47
Interview with Anders Strange Sørensen, Enemærke & Petersen.....	79

3. TRANSFORMATION & STRATEGIC RESEARCH

Introduction by Christian Gaeth 87

Articles

- Regenerating circularity 91
- Focus on the living – a paradigm shift 97
- The sweet spot of knowledge in circular decision-making:
Balancing deep knowledge and best practices in the age of
data and real-world experiments..... 101

Abstracts..... 107

Interview with Thomas Bo Jensen,
Aarhus School of Architecture 120

4. MATERIALS & ENERGY

Introduction by Kiel Moe..... 128

Articles

- Maximizing the reuse of wood in construction..... 133
- Supporting circular and sustainable decision-making in
the construction sector through digital innovation..... 137
- Towards a multi-scalar approach to circular economy 141

Abstracts..... 144

5. WHERE DO WE GO FROM HERE

Interview with Simon Kofod-Svendsen, Realdania and
Ole Sinkjær, the Danish Innovation Fund 171

Interview with Jacob Blak, Cobe..... 177

Call to action 183





WHY A
CIRCULAR BUILT
ENVIRONMENT
NETWORK

12345

WHAT IS CBEN?



The Circular Built Environment Network (CBEN) consists of 15 industrial PhD projects, two Grand Solutions projects and two research projects. The purpose was to create new knowledge, explore synergies and share learnings with each other and the industry at large. All projects share a vision of contributing to a shift from the conventional construction industry to a circular resource economy. During a 3-year period the network had ongoing meetings, conducted international study tours, visited conferences, produced joint articles, and formed new company collaborations. The network was facilitated by BLOXHUB and generously co-funded by Realdania and The Innovation Fund Denmark.

Academic institutions involved in the network are Aalborg University, Aarhus

School of Architecture, Aarhus University, Royal Danish Academy, Technical University of Denmark (DTU), and University of Southern Denmark (SDU).

Industrial partners are AART architects DK A/S, Adsbøll Renovering A/S, Udviklings-selskabet By og Havn I/S, CB Nordic ApS, Cobe, Danica Ejendomme, Danish Association of Architectural Firms, Danish Technological Institute, Dansk Standard, Enemærke & Petersen A/S, Freja Ejendomme A/S, Friis & Moltke A/S, Gate 21, HD Lab, J Jensen, Lejerbo, Lendager Arkitekter ApS, Matter bybrix, Middelfart Kommune, ODICO A/S, Rambøll Danmark A/S, Roskilde Kommune, Tredje Natur, Twentyfifty, and The Danish Road Directorate.

Building tomorrow: Empowering sustainable construction via applied science and circular economy

Simon Kofod-Svendsen, Project Chief, Realdania
& Ole Sinkjær, COO, Danish Innovation Fund

Welcome to this exploration of applied science's pivotal role in re-shaping the construction landscape through the lens of the Circular Built Environment Network (CBEN). This publication is a beacon illuminating the journey of innovation and sustainability within the construction sector, underscoring the synergy between applied science and industry. It is, in fact, a way to futureproofing the Danish built environment.

Recognizing the industry's important role in addressing climate crises and resource scarcity, CBEN is a testament to the power of partnerships and integration of applied science to fundamentally reshape construction practices. CBEN's formation stems from our shared commitment to research-driven innovation, aiming to enhance circular economy practices and position research as a key ally in overcoming broader industry hurdles. As a dynamic network

for collaborative knowledge exchange, CBEN breaks free from traditional industry constraints, fostering a community where collaboration and applied science become the cornerstone of sustainable construction practices with new results to share.

"We were driven by a two-fold aim when deciding to instigate the CBEN: first, to catalyze a fundamental shift in construction by emphasizing research and collaboration as essential tools for innovation, addressing the sector's need for more commitment to applied research. Secondly, to enhance research on using circular economy principles in the built environment, aiming to go beyond mere intentions and create a network capable of delivering commercially viable circular solutions – actively turning vision into reality by ensuring scaling possibility while fostering cross-pollination and collaboration".

Distinguished by a strategic fusion of traditional industrial research and an expansive networking layer, CBEN's Industrial Researcher program with 15 industrial PhD's and the four major research projects involved emerged as vital instruments for nurturing talent and aligning academia with the industry's real-world needs.

As CBEN's three-year journey draws to a close, its significant influence echoes. The network has catalyzed change, contributing to a growing knowledge bank beyond individual research projects. This publication presents the collective influence of CBEN, spotlighting individual projects and their diverse insights.

Each article reflects the collective impact of CBEN, encapsulating unique approaches, collaborative methods, and the transformative power of applied science in diverse projects. From circular solutions to regenerative practices, the insights shared here echo the journey of a network committed to navigating challenges and redefining industry norms.

Building on the results from CBEN, we gear up for a new initiative in 2024, expanding the reach of the network to promote the innova-



tive methods and approaches on how we can and should work with the resources available to support a regenerative movement for both the planet and its population with a focus on 'moving toward the regenerative'.

Join us on this explorative journey within this publication, where sustainability, research, and visionary leadership converge to forge a path toward a regenerative future in construction.



Collective Insights for the Circular Built Environment

Discuss & identify 5 collective insights across your separate roles related to the track. Label them in a single lettered headline.

- Discuss the following for each insight, and code on separate post-its:
- A) Impact - what does this insight mean for how we think about and act on circularity in the built environment?
 - B) Enablers - does this insight point towards or require a change in practices in the built environment?
 - C) Barriers - are there systemic barriers or dependencies related to this insight and how can the built environment address them?



#1

#3

#4

Forging tomorrow: Advancing circular construction through applied science & collective wisdom

By Ditte Lysgaard Vind,
Chief Innovation & Science Officer, BLOXHUB

We can and should build better than we do today. So why don't we?

The construction sector grapples with a dual challenge: transforming its practices to shift from a significant emitter to a positive contributor to sustainable change. Simultaneously, the industry must embrace new knowledge, particularly through research and innovation, to implement scalable practices. In essence, the construction sector needs to acquire new skills to deliver value within planetary boundaries while cultivating the ability to adapt to new skills.

This necessitates a comprehensive cultural shift where learning, innovation, and cross-sector collaboration become fundamental values. This way, ongoing successful pilot projects can be scaled effectively, becoming the new norm. In recent years, both in Denmark and internationally, innovative methods on how to build and provide value within ecological constraints have emerged.

However, much of this thinking remains confined to a small part of the research world, specialized organizations, and very few companies. There is a need for a deeper understanding and broader anchoring in practice for these new approaches to truly transform how value is created within the built environment. At BLOXHUB, we believe that a crucial part of the regenerative transition is to closely link research and business, across disciplines and sectors.

Our objective is to serve this transformation by helping ensure that the commendable initiatives already underway, as well as those set to commence, are facilitated, and promoted effectively – with a clear call to action to implement them. Through cross-pollination, we aim to enhance research utilization within the industry.

READING GUIDE

This publication compiles the collective findings of the Circular Built Environment Network (CBEN). The network consists of fifteen industrial PhDs and four major research projects at the intersection of industry and academia. They focus on opportunities and barriers for the circular economy to drive positive change in the built environment.

The network has delved into the threats posed by the historical and continued exploitation of nature, leading to the environmental crisis of the Anthropocene era. Their research underscores the built environment's central role in global carbon emissions, biodiversity loss, and waste production, while stressing the need for a fundamental reevaluation of the industry. The concept of circular building is introduced as part of a solution, but inherent challenges and the call for a more comprehensive and systemic approach are also highlighted. CBEN advocates for a holistic approach that includes considerations of climate, society, nature, and the global economy.

The publication comprehensively explores the circular economy's transformative potential across three thematic tracks: Economy &



Societal Structures, Transformation & Strategic Research, and Materials & Energy. Each section unveils a unique facet of the circular construction landscape, offering insights and innovations on how circularity and applied science can reshape the built environment.

By weaving together abstracts, articles, and interviews, the publication identifies challenges, presents opportunities, and offers solutions for advancing the circular economy's value within the broader context of the construction industry.

The text underscores the essential need for collaborative efforts and the application of scientific principles to revolutionize construc-



tion, ensuring its resilience within planetary boundaries and fostering value for both human beings and other species.

By illuminating the intricate connections between societal inequalities, financial motivations, and environmental sustainability, the text reveals the comprehensive nature of the challenges we face. The findings advocate for systemic transformation, and introducing practical solutions within the projects becomes a pivotal aspect of navigating this complex web of issues. The projects provide hope and offer actionable plans for a sustainable future, while pointing to issues that still require innovation and research to resolve.

We invite you to critically assess existing paradigms within the construction sector and to actively participate in the collective effort in effecting fundamental change. This call for collaboration, applied science, and systemic reinvention seeks to resonate as a powerful rallying cry, encouraging all stakeholders to come together and contribute to the fundamental beneficial evolution of the industry.

We hope you will embark with us on this green odyssey, where sustainability, applied science, and visionary leadership converge to forge a path toward a circular future in construction. Consider this text as the starting point, and we encourage you to extend the journey by connecting with the researchers and implementing their insights in the field. You may even choose to initiate your own applied science project, future-proofing your work through the cross-pollination of research and industry. Your active involvement is vital to shaping a resilient and innovative future for construction.



10 key insights from the publication

↘ **REVISED UNDERSTANDING OF RESOURCES AND ECONOMY IN CIRCULAR ECONOMY**

Advocate for a paradigm shift, developing a critical understanding of 'economy' and 'resources,' emphasizing material revaluation and reuse.

↘ **INTERDISCIPLINARY COLLABORATION**

Balance deep knowledge, utilize real-world experiments, and adopt a holistic approach, emphasizing continuous learning and comprehensive data analysis for sustainable decision-making.

↘ **QUANTITATIVE SUSTAINABILITY ASSESSMENTS IN CONSTRUCTION**

Rely on quantifiable metrics but challenge decision rationality, integrating qualitative methodologies to address limitations in capturing true sustainability effects.

↘ **NATURE-INSPIRED URBANISM**

Recognize imbalanced nature, shift focus to "the living,"

and embrace complexity in urban development with acknowledgment of intricate connections between buildings and living organisms.

↘ **REGULATING FOR SUSTAINABILITY
IN CONSTRUCTION**

Explore practical implications of sustainability regulations, analyze impacts at multiple levels, and acknowledge the gap between policy and practice.

↘ **STRATEGIES FOR SCALING CIRCULAR ECONOMY**

Explore platforms and integrate digital solutions for overcoming obstacles and fostering circular business models.

↘ **ROLE OF STANDARDIZATION**

Strive for a delicate "sweet spot" between standardization and individualization, acknowledging uniqueness and addressing biases for ambitious circular economy objectives.

↘ **MATERIAL REVALUATION AND REUSE**

Emphasize revaluing and reusing materials, introducing adaptable design concepts for structures easily modified, reducing waste.

↘ **CHALLENGES IN THE CONSTRUCTION SECTOR
AND BALANCING STRATEGIES**

Acknowledge the construction industry's role in global emissions, advocate for dynamic evaluations, and explore challenges in integrating sustainability solutions during tendering.

↘ **CONTINUOUS ADAPTATION
AND COLLABORATION**

Navigate the complex journey toward circular decision-making, emphasizing the necessity for continuous learning, adaptation, and industry-wide collaboration.



ECONOMY &
SOCIETAL
STRUCTURES

12345

Economy and societal structures

Navigating the interconnected realms of climate, society, nature, and finance

Intro by
Maya Færch

It's 2050, cities worldwide are not only thriving and inclusive but have undergone radical decarbonization, making a 1.5°C-aligned lifestyle second nature through access to community living and working, green spaces and sustainable infrastructure. Led by visionary planners, architects, and businesses, this transformation is rooted in inclusive policies and citizen engagement, creating proud communities deeply connected to each other and our surroundings.

The built environment stands at the nexus of a complex interplay of factors that shape our world, from climate impact and societal structures to their profound effects on both people and nature. As we traverse the 21st century, the imperative to transform the way we conceive, construct, and inhabit our buildings and infrastructure has never been more urgent. This introduction delves into the multifaceted dimensions of the built environment, unraveling its far-reaching

consequences on the climate, society, nature, and the global economy.

Buildings, indispensable components of human habitation, contribute significantly to climate change.

Accounting for a staggering 37% of global energy and process-related emissions, they loom large on the horizon of environmental challenges . The trajectory is ominous – with an anticipated 75% growth in floor area from 2020 to 2050, both operational and embodied carbon emissions are set to escalate dramatically. A pressing need emerges to adapt the existing built environment, enhancing resilience to the climate changes already underway.

Within the concrete jungle, stark inequalities and challenges persist. Over a billion urban residents find themselves in slums, grappling with inadequate living conditions . Household air pollution, a silent killer, claims 3.2 million lives annually, with over 237,000 of these being children under the age of 5 . Moreover, the construction sector, employing 7% of the global workforce , lacks just transition plans among the 50 most influential built environment companies.

The toll on nature is equally profound. The built environment bears the weight of responsibility for over half of global virgin resource extraction and 40% of global waste streams. A staggering 30% of fresh water is consumed within its confines. As urban areas burgeon, expanding by the size of South Africa by 2030, the implications for nature and biodiversity become increasingly ominous.

Within the labyrinth of the built environment, finance emerges as a critical protagonist. Real estate and infrastructure constitute two-thirds of global wealth, a colossal asset class exceeding \$300 trillion, also representing a significant source of wealth creation. The construction sector, contributing 13% to global GDP , demands attention. Notably, a colossal \$1.7 trillion annual investment until 2050 is deemed necessary to effect the transition required in the building stock, with the lion's share – 80-90% – expected to be driven by private investment.

To grapple with the magnitude of challenges posed by the built environment, **a call for systemic transformation resonates.** The three-horizon model, guiding us from the present (horizon one) through innovation and change

(horizon two) towards sustainable, regenerative futures (horizon three), becomes imperative. Business as usual is losing its fit for purpose, compelling us to navigate through innovations in products, processes, incentives, and systems with the goal to grow the third horizon where we operate within planetary boundaries, fostering a regenerative approach that ensures equity, inclusion, and well-being for all.

In this intricate tapestry, the transformation of the built environment becomes not only a necessity but a moral imperative. **The choices we make today will echo through generations, shaping the world we bequeath to those who follow.** The journey ahead demands collective action, innovation, and a resolute commitment to forging a sustainable, equitable, and harmonious built environment for the future.

The PhD projects within the stream Economy and Societal Structures not only bring hope, but also solutions that take us forward towards the futures we need.

REFERENCES:

[racetozero.unfccc.int/wp-content/uploads/2021/09/2030-breakthroughs-upgrading-our-systems-together.pdf](https://www.racetozero.unfccc.int/wp-content/uploads/2021/09/2030-breakthroughs-upgrading-our-systems-together.pdf)
unfccc.int/climate-action/marrakech-partnership/reporting-tracking/pathways/human-settlements-climate-action-pathway#Climate-Action-Pathway-2021
iea.blob.core.windows.net/assets/d7e6b848-6e96-4c27-846e-07bd3aef5654/THEBREAKTHROUGHAGENDAREPORT2023.pdf
unstats.un.org/sdgs/report/2019/goal-11/
www.who.int/news-room/fact-sheets/detail/household-air-pollution-and-health
icedfacility.org/wp-content/uploads/2018/08/Report_Construction-Sector-Employment-in-LICs_Final.pdf
worldbenchmarkingalliance.org/news/2023-buildings-benchmark-press-release/
drive.google.com/file/d/12IemF7on6PenC8YBa5iUtMARdx1HG/SgI/view
bauhausearthbackend.com/wp-content/uploads/2023/10/Building_for_the_Future_Series1_1_2941-7171.pdf
wbcasd.org/content/wbc/download/17485/245100/1
mckinsey.com/~/media/mckinsey/business%20functions/sustainability/our%20insights/the%20net%20zero%20transition%20what%20it%20would%20cost%20what%20it%20could%20bring/the-net-zero-transition-what-it-would-cost-and-what-it-could-bring-final.pdf
https://youtu.be/_5KfRQJqpuPU?si=Gak-6uT26CFSh-Zx

Quantifying or qualifying the circular economy?

AUTHORS

Stefan Christoffer
Gottlieb¹
Nicolaj Frederiksen¹
Lise Hvid Horup
Sørensen^{2,3}
Lin Engholm Kjerulf^{1,4}
Andreas Qvist Secher³
Andreas de Gier^{1,4}

ORGANIZATIONS

⁽¹⁾ Department of the
Built Environment,
Aalborg University,
Copenhagen, Denmark

⁽²⁾ Technical University
of Denmark (DTU)

⁽³⁾ Rambøll Danmark A/S

⁽⁴⁾ Enemærke & Petersen
A/S

The transition to the circular economy (CE) in the built environment seems to rest on the development of professional expertise in quantifying the world. CO2 emissions, Life Cycle Costs, material flows, and the amount of waste recovered and fed back into the economy are all important indicators of the CE and metrics to which the industry is held accountable. These calculations have become a basis for decision-making, as well as a necessity for documenting compliance to legally binding commitments in transnational, national, and sectoral regulation, as well as being evaluated by stakeholders in the market and the wider society.

Calculations and quantifications are often favored by politicians and other decision-makers for their ability to provide a structured and systematic approach to decision-making, mainly due to their presumed objective nature reducing the potential for subjective biases or personal preferences to influence decisions. Moreover, quantifiable criteria and data are purported to increase transparency and enable comparative analyses of different options, leading to informed and logical decisions.

While this may be theoretically true, the use of deceptively precise numerical values as a basis for decision-making rests on assumptions that may be highly problematic if they are not acknowledged – or more so, are obscured by decision-makers promoting the objectivity of the inputs to those decisions. According to organizational theorist James G. March, any putatively rational decision is based on improbable assumptions about the nature and quality of the data that informs them. Rational decisions thus presume that we have complete information about (1) all alternative courses of action when we make the decision,

(2) future consequences of those alternatives, and (3) future preferences for the consequences of current actions.

The improbability of comprehensiveness arises from institutional, technical, and cognitive factors. At any time, there are limits to how much information can be processed and how many alternatives decision-makers can consider. Moreover, calculation tools are constrained by the availability and quality of data, modelling assumptions, and the methodologies employed, and different political objectives and industry standards influence the criteria that are included in the calculations. Uncertainty also impacts our ability to predict the future consequences of different alternatives. These predictions will, at best, reflect the inherent rationales and limitations of existing analytical tools and thus be bounded by current best practices and perceptions.

While calculations supporting decisions for the future are often based on status quo assumptions about society or predictions regarding technological developments, growth etc., the inherent uncertainty of the future should be included as a strong caveat. However, reporting often falls short of clearly stating these complexity-induced uncertainties, which introduces the risk of using the results inappropriately. This is probably the most dangerous feature of calculation tools. While the decision basis they offer is alluring and powerful due to their (necessary) simplifications of reality and the opportunities for comparisons they enable, the fact is that inconsistencies and uncertainties may be hidden under a veil of calculative rationality. Below, two illustrative examples of this issue are provided.

Construction tendering involves the selection of a contractor based on a quantitative assessment of the price and/or other qualitative requirements (e.g., sustainability services, process and organization and architectural quality), which are calculated as a weighted percentage to enable a comparative evaluation on a scale from 1-10. In the terms of French sociologist Michel Callon, this quantifiable valuation of a good or service is based on an 'objectification' of its properties and a 'singularization' that recontextualizes it into the buyers' world. In the case of tendering CE services, objectification takes place as bidders interpret the tender requirements in defining the good or service, for example the specific type of materials or products to be delivered;

and singularization involves highlighting a factor such as the potential CO2 savings for the client.

In tendering, and in the construction industry generally, CO2 savings are often calculated with life cycle assessments (LCA) following the EN15978 standard. The building regulations prescribe which phases of a building's life cycle should be accounted for and which building parts should be included. This enables comparability across buildings, but also results in the nullification of what is not included. One example is construction site energy consumption, which is not yet included in a standard LCA. At the same time, LCAs suffer from uncertainties regarding future emission such as those associated with energy supply, material replacements during the lifespan of the building, and waste handling. Another important point is that the industry regulates per square meter, which applies to both the energy frame calculations and the CO2 limits introduced in 2023. This does not incentivize building fewer and/or more efficient square meters but rather rewards large buildings with a higher CO2 budget. Instead, it could be argued that the CO2 budget should be based on the function the building serves to society, such as the provision of a number of residences, office spaces, hospital beds etc.

Thus, while quantitative assessments have several strengths, we emphasize the necessity of challenging quantitative methodologies and partnering them with qualitative. It is essential to recognize that a calculative rationality does not capture all relevant considerations in decision-making. It is, therefore, most effective when used in conjunction with other decision-making approaches that address a broader range of factors.

Standardization for the circular economy: Is there a sweet spot between standardization and individualization in construction?

AUTHORS

Julia Köhler ¹
Karoline Fogh
Gustafsson ²
Christian Thuesen ¹
Stefan Christoffer
Gottlieb ³
Nicolaj Frederiksen ³
Andreas de Gier ^{3,4}

ORGANIZATIONS

⁽¹⁾ Technical University of Denmark (DTU)

⁽²⁾ Lendager Arkitekter ApS

⁽³⁾ Aalborg University

⁽⁴⁾ Enemærke & Petersen A/S

Standardization has been proposed as a solution to bridge the construction industry's fragmentation and allows the reuse of designs, the repetition of processes, and the creation of organizational learning (Jones et al., 2022). At the same time, standardization has been argued to introduce uniformity and monotonous design to products. In facilitating repetition, standardization presents a potential avenue to promote circularity in construction by reusing processes, designs, and materials, thereby reducing the overall use of resources. The question is whether there is a sweet spot between standardization and individualization that allows us to align with schedules, budgets, and the resource availability while maintaining a sufficient level of customization.

Construction has evolved in constant adaptation to society's needs. After the Second World War, we saw an urgent need to build as much housing as possible in a short amount of time, while keeping costs low. The outcome was highly standardized buildings (picture 1 – see *next page*).

Since that time, housing increasingly became an artifact for architectural expression. Buildings evolved from standardized to individualized, while architecture moved from 'form follows function' to 'form follows fiction'. This development was in many ways linked to the standardization



of project management tools and knowledge that enabled the realization of increasingly complex projects (Garel, 2013). At the same time, significant scope creep, in addition to frequent budget and time overruns became the new normal. An example is the Sydney Opera House (picture 2), which was supposed to be opened in 1963 but was eventually finalized 10 years after the deadline, with the original budget exceeded by approximately 1,000%.

Today, concerns about the availability of resources add to the complexity of construction. This gives rise to a new paradigm in architecture – ‘form follows availability’. This brings the circular economy into the discussion, and considerations on how to minimize the use of resources in construction.

Modularization has been connected to the circular economy, as it allows standardization on the one hand and



Picture 1:

Highly standardized housing block in Macau. (Source: Unsplash, by Gleb Mishin, 2020)

Picture 2:

Sydney Opera House (Source: Unsplash, by Ivan Tsaregorodtsev, 2021)



reconfiguration of parts on the other, giving rise to circularity solutions such as design for disassembly (Machado & Marioka, 2021). Product platforms adopt principles of standardization and modularization by structuring products, processes, knowledge, and relationships into a standardized core with variable elements (Meyer & Lehnerd, 1997). While the standardized core enables economies of scale and repetition, the variable elements cater to individualization, and a stable interface maintains the modularizability between the two. Considering the system as a whole, product platforms attempt to minimize industry fragmentation and maximize standardization, while catering to the most value-creating preferences for individualization.

Can product platforms increase resource efficiency, repetition, and learning in the construction sector in order to ultimately scale the circular economy? Ideally and theoretically, yes; though we are facing the fact that reused materials are unique to their use and context, which can be a potential barrier to standardizing them.





Picture 3:

Wooden shed made of reclaimed wood using principles of standardization and modularization by Næste (Source: Næste)

An example of a company applying these principles is Næste, a Danish producer of sheds built of reclaimed wood. Næste transforms the variation of their input resources into standardized modules and assembles them into a shed that can be individualized according to customers' preferences (picture 3). Process design and a function-based approach become especially relevant, as they leverage repeatable elements. Structural Reuse is a project that includes both strategies by focusing on the process of qualifying component properties of used elements with a function-based approach. The project seeks to scale the reuse of structural elements in concrete, steel, and timber by defining non-destructive test (NDT) methods to determine the key (function-based) properties early in the decision-making process to ensure that elements can live up to the requirements of an intended secondary use case. The creation of Danish Standard documents (DS/INFs) enables a broad range of stakeholders to repeat the process.

REFERENCES:

Garel, G. (2013). A history of project management models: From pre-models to the standard models. *International Journal of Project Management*, 31(5), 663-669.

Jones, K.; Mosca, L.; Whyte, J.; Davies, A.; & Glass, J. (2022). Addressing specialization and fragmentation: product platform development in construction consultancy firms. *Construction Management and Economics*, 40(11-12), 918-933. <https://doi.org/10.1080/01446193.2021.1983187>

Machado, N.; Morioka, S. N. (2021). Contributions of modularity to the circular economy: A systematic review of literature. *Journal of Building Engineering*, 44, 103322.

Meyer, M. H.; Lehnerd, A. P. (1997). *The power of product platforms.* Simon and Schuster.

Voluntary standards and standardization: A necessity or threat to the circular economy?

AUTHORS

Stefan Christoffer
Gottlieb ¹
Nicolaj Frederiksen ¹
Andreas de Gier ^{1,4}
Julia Köhler ²
Karoline Fogh
Gustafsson ³
Christian Thuesen ²

ORGANIZATIONS

- ⁽¹⁾ Aalborg University
⁽²⁾ Technical University
of Denmark (DTU)
⁽³⁾ Lendager Arkitekter ApS
⁽⁴⁾ Enemærke & Petersen A/S

The Danish construction industry has historically relied on legislative measures to drive technological development and the uptake of new practices and methods. While legislation is a significant tool at the disposal of policymakers, policymaking is becoming increasingly polycentric, involving a range of participants, such as industry boards, NGOs, social movements, companies, and national as well as supranational organizations, that all exert influence on the functioning and trajectory of the industry. This development is tied into the decentralization and devolution wave that has spread across societal sectors over the last three or four decades, leading to profound changes in the governance of most industries, with critical implications for their coherence and functioning (Gottlieb and Frederiksen, 2020). Consequently, policymakers have begun to rely on hybrid approaches to regulation, where traditional ‘hard law’ and legally binding instruments constitute only one measure among several in a policy mix of instruments. In addition to hard legislative measures, ‘soft law’ — such as recommendations, industry-developed guidelines, codes of practice, and rules of conduct — is increasingly used as a basis for regulatory efforts. In particular, standards, in the form of norms and voluntary agreements, play a prominent role in policymakers’ efforts to govern industry development and direct companies toward a particular political agenda.

The reliance on standards is evident when obser-

ving that Danish building regulations contain references to close to 100 DS/EN standards. Also, policies on the circular economy refer to voluntary standards as a basis for the implementation of political ambitions. The recent national circular economy action plan, highlighting measures for the prevention and handling of waste, exhibits a strong reliance on voluntary standards and recommendations. For example, the use of the waste hierarchy encourages prioritization of waste types to promote increased circularity. Furthermore, an explicit indicator of the efforts to reduce the environmental impact of construction activities is the designation of projects according to labels and certification schemes such as the Nordic Swan Ecolabel, DGNB, BREEAM, or LEAD. Moreover, to encourage the use of climate-friendly building materials, there is a recognized need to create awareness about the embodied CO₂ emissions of building materials through the implementation of a voluntary sustainability class in the Danish building regulations.

These are examples of how standards are used to inform and implement policymaking at an industry level and to promote the circular economy, which has at least two important repercussions. First, standards and certification schemes are often developed at the industry level by representatives from different companies who are members of committees under the auspices of a standardization organization or an industry council. As such, the design of standards is heavily influenced by private interests that may be directed more towards business opportunities and competitive advantage than concerns for the environment and the common good. Second, measures to change industry practices take the form of what political scientists (e.g., Bemelmans-Vidéc et al., 2011) would refer to as “sermons” rather than “sticks” or “carrots”. Sermons are informational policy tools that use knowledge, arguments, advice, etc. to influence a target group to act, or not act, in a given way. As such, they differ significantly from the traditional command and control policy instruments that either incentivize or enforce action.

Informational policy instruments rely on voluntary compliance, meaning that the effectiveness of such regulation depends on the willingness of individuals and companies to follow prescriptions. This is especially problematic if the

changes necessitated by a policy are significant, or if the policy aims at achieving substantial transformations. In such cases, there may be resistance among the target population, meaning that informational instruments may have limited impact due to the lack of credible enforcement behind them. This means that policies that can support more radical changes, such as the move toward the circular economy, but rely on voluntary standards, may risk being less ambitious, as market players arguably often follow, rather than challenge, existing market relations (Flynn and Hacking, 2019).

REFERENCES:

- Bemelmans-Videc, M. L.; Rist, R. C., Vedung, E. O. (Eds.). (2011).** Carrots, sticks, and sermons: Policy instruments and their evaluation. Transaction Publishers, New Brunswick.
- Flynn, A.; Hacking, N. (2019).** Setting standards for a circular economy: a challenge too far for neoliberal environmental governance? *Journal of Cleaner Production*, 212, 1256-1267.
- Gottlieb, S. C.; Frederiksen, M. (2020).** Deregulation as socio-spatial transformation: Dimensions and consequences of shifting governmentalities in the Danish construction industry. *Environment and planning C: politics and space*, 38(3), 484-502.

Evaluating mitigation strategies against absolute sustainability targets: Focus on the built environment

PROJECT

Industrial PhD

AUTHOR

Lise Hvid Horup
Sørensen

ORGANIZATIONS

Rambøll Danmark A/S

Technical University
of Denmark (DTU)

Aalborg University

The construction industry faces significant challenges in meeting the future demand for buildings while mitigating the environmental impact of their construction and operation. To effectively address these challenges, it is crucial to make informed decisions. One valuable tool is the use of quantitative sustainability assessments, such as LCAs, to enable decision-makers to identify the most effective sustainability strategies. Traditional assessments, however, often fall short in capturing true sustainability effects. Commonly used relative assessment methods, such as benchmarking against industry standards or comparing building designs, are useful to a certain degree but fail to provide a measure of the buildings environmental performance in relation to the carrying capacity of the 'earth system' (Giesekam, Tingley and Cotton, 2018).

This research explores the key dimensions and principles of 'absolute sustainability' and provides insights into its practical implementation in the building industry. The project addresses both how absolute climate targets can be calculated for a single building (Horup, Birgisdóttir and Ryberg, 2023), and also shows how mitigation strategies for a building stock can be evaluated in terms of complying with global sustainability targets such as the Paris Agreement goal of keeping temperature increases below 1.5 degrees (UNFCCC, 2015).

Absolute Environmental Sustainability Assessments

(AESA) compares the environmental impact of an anthropogenic system such as a building to a share of the carrying capacity of the earth system, e.g. a calculation derived from the 1.5-degree climate limit (Bjørn et al., 2020). This method assigns a share of the allowable global “budget” to an activity by applying sharing principles rooted in ethical choices on which activities should be allowed to produce emissions and by whom (Ryberg et al., 2020). Since there is currently no consensus around how this metric should be derived, it is essential to transparently communicate the principles that have been employed.

The results of this project demonstrate that absolute sustainability assessments can indeed play a role in the transformation of the building industry, while suggesting conclusions such as aligning the Danish building sector with global climate targets will require much less (or even no) construction of new buildings and for the existing building stock, savings on operational energy consumption are key.

In conclusion, this abstract highlights the significance of absolute sustainability as a key element in communicating that it is not enough to think about how we can “do less harm” – we need to change our mindsets towards finding ways we can operate within the limits of the earth.

Picture 1:

Allocating a share
of the global
allowable budget to an
anthropogenic system.

DOWNSCALING THE PARIS AGREEMENT TO BUILDING ACTIVITIES IN A COUNTRY

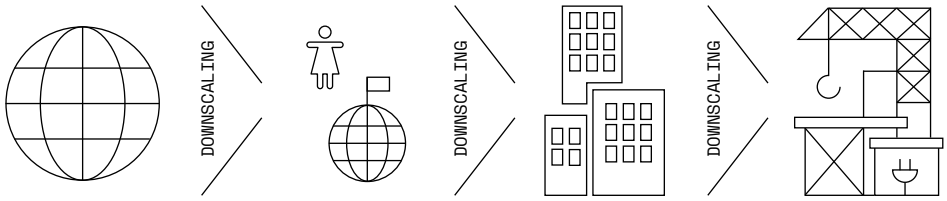

1.
DEFINIE A GHG
BUDGET COSISTENT
WITH 15°C TAGET

2.
EXTRA NATIONAL
BUDGETS

3.
DEFINE SHARE FOR
BUILDINGS

4.
DEFINE SHARE
FOR BUILDING
ACTIVITIES

REFERENCES:

Bjorn, A. et al. (2020) 'Review of life-cycle based methods for absolute environmental sustainability assessment and their applications', Environmental Research Letters [Preprint]. Available at: <https://doi.org/10.1088/1748-9326/ab89d7>.

Giesekam, J.; Tingley, D.D.; Cotton, I. (2018) 'Aligning carbon targets for construction with (inter) national climate change mitigation commitments', Energy and Buildings, 165, pp. 106-117. Available at: <https://doi.org/10.1016/j.enbuild.2018.01.023>.

Horup, L.H.; Birgisdóttir, H.; Ryberg, M.W. (2023) 'Defining dynamic science-based climate change budgets for countries and absolute sustainable building targets', Building and Environment, 230 (September 2022). Available at: <https://doi.org/10.1016/j.buildenv.2022.109936>.

Ryberg, M.W. et al. (2020) 'Downscaling the planetary boundaries in absolute environmental sustainability assessments - A review', Journal of Cleaner Production, 276. Available at: <https://doi.org/10.1016/j.jclepro.2020.123287>.

UNFCCC (2015) The Paris Agreement, Towards a Climate-Neutral Europe: Curbing the Trend. Available at: <https://doi.org/10.4324/9789276082569-2>.

Evaluating frameworks for decision support regarding sustainability of circular economy within the built environment

PROJECT

Industrial PhD

AUTHOR

Sarah C. Andersen

ORGANIZATIONS

Danish Technological
Institute

University of Southern
Denmark (SDU)

Aalborg University

The use of Life Cycle Assessments (LCAs) has led to a paradox in the construction industry. As the industry gains more experience with the application of LCAs, the complexity of the questions need to be addressed by LCAs rises, thereby increasing the scale and complexity of the systems under assessment. As a result, large systems like CE models for the built environment are often evaluated in the same way as individual buildings and building components, even though CE models have a higher potential to produce feedback effects. This means that the system being evaluated changes due to the entity/service being evaluated.

Questioning the assessment methodology's viability for environmental decision support in the built environment, considering LCAs in particular, this project investigates how the current framework for environmental assessments might be insufficient for the transitional agenda, and whether other theoretical LCA approaches could overcome these limitations.

Hypothesizing that current assessments methods may not uncover impacts or consequences caused by new circular designs when scaling solutions to industry/sector scale, a proof-of-concept shows how alternative LCA approaches change decisions support and conclusions. While presenting

assessments of shortcomings in revealing environmental implications and in assessments methods more generally, the project also presents case studies that illustrate how the applied LCA method and system boundaries impact coherent decision support and its.

This project also delves into the questions: Why do we evaluate nearly all systems in a 'static' way despite being fully aware that we live in a dynamic world; and are we adequately addressing the need to improve the accuracy of the models we develop within LCAs in a practical and sufficient way?

The project, preliminarily, shows that other LCA approaches, and system boundaries can enhance decision support, highlighting issues and aspects not addressed in our current assessments in the built environment.

Circular transition of affordable housing

PROJECT

Industrial PhD

AUTHOR

Vibeke Grupe Larsen

ORGANIZATIONS

Danish Association of Architectural Firms

University of Southern Denmark (SDU)

Landsbyggefonden, Danmarks Almene Boliger

The construction and real estate industry is directly and indirectly responsible for approximately 40% of global greenhouse gas emissions. Therefore, it is relevant to consider the industry as a focal point for the necessary transition to a circular economy, as described by the EU Commission through the European Green Deal as a growth strategy and, subsequently in the EU's Circular Economy Action Plan.

Understanding the circular processes related to buildings and their lifecycle is essential to ensure the successful implementation of the transformation of the Danish construction industry into a circular economy. However, the construction industry still largely adheres to a linear approach.

The research project, "Circular transition of affordable housing – Generating Social, Environmental and Economic value by Design", examines the contextual prerequisites for necessary systemic change in the industry. Starting with affordable housing, a significant area within Denmark's construction sector, this initiative charts a course for future endeavors. Affordable housing constitutes 20% of Denmark's housing and accommodates 1 million residents within a population of 5.8 million. It is noteworthy that housing organizations within affordable housing own and operate properties, which should incentive a transition to the circular economy. The fundamental argument is that transforming operational paradigms within affordable housing can set an example that can be applied to the broader construction sector.

The research comprises four scholarly articles, assessing contemporary tools and methods for facilitating the CE transition (Larsen et al., 2022b) and revealing fundamental

Building owners
 End users/consumers
 Local communities
 Designers
 Demolition experts
 Other value chain actors

Building owners
 Developers
 End users/consumers
 Designers/consultants
 Demolition experts
 Local communities



OTHER STAKEHOLDERS

- Present society
- Policy makers
- NGO's
- Internal clients
- External clients
- Public / media
- Future society

- Phase model, Circular procurement (74)
- Phase model, RIBA (64)
- Phase model, products
- Crucial activities for planning and designing social housing
- Crucial milestones for planning and designing social housing (existing application proces)

insights for exploring obstacles and drivers (Larsen et al., 2022a). Systematic studies target architectural consultants, examining their competencies as well as their commitment to societal value-creation and the principles of circular transformation (Larsen et al., 2023a). Additionally, stakeholders in the public sector are engaged through interviews, shedding light on factors that influence and hinder CE adoption (Larsen et al., 2023b).

These multifaceted investigations culminate in a decision framework that integrates the principles of the circular economy into the development of the affordable housing sector and outlines critical areas requiring structural and contractual adjustments, while leveraging these findings to influence the direction of Denmark's broader construction sector.

Valuation of sustainability in tendering from a contractor perspective

PROJECT

Industrial PhD

AUTHORS

Lin Engholm Kjerulf

ORGANIZATIONS

Enemærke & Petersen
A/S

Aalborg University

Copenhagen Business
School

My research has shifted from initially examining the factors that both hamper and promote 'circular tendering strategies in contractor firms' to investigating how contractors make sense of sustainability in the tendering process. This change in focus stems from various factors, one being the realization that tendering projects to include 'circularity requirements' cannot easily be separated from other sustainability demands. Even if one were to attempt such separation, it is evident that 'circularity requirements' in tendering are at an early stage. Consequently, we must first comprehend the current sequence of sustainability priorities in tendering. Therefore, my research project aims to encompass 'environmental' sustainability requirements as a whole to better understand the path forward.

The tendering process contains a wide range of 'persuasion inscriptions', which help determine whether the client and the bidding team can find a common ground for action, namely, to join a unified project team to achieve the common task of 'realizing the construction project'. In my research project, I have identified three 'persuasion inscriptions' which I refer to as 'devices for the translation of interests'. These devices act as mediators in aligning the priorities of both sides of the client-contractor relationship. The three devices are 'DGNB', 'References', and 'Value Packages'. 'DGNB' has inevitably found its way into my empirical data due to its extensive use in the Danish construction industry. I explore how DGNB's framework influences both a contractor's tendering practices and clients

act in tendering, and how contractors choose to react to and make sense of DGNB. 'References' are part of showcasing the bidder's project history to get prequalified and, consequently, be eligible to bid on the project. The project examines how contractors continually work towards 'having convincing references' to bid in sustainability-related market segments and how references in the form of four prior projects account for sustainability initiatives. 'Value Packages' encompass the responses to qualitative requirements that are submitted by the tendering team alongside the bid price. The focus is particularly on how a contractor's tendering team 'crafts' narratives about sustainable construction. The analysis was built upon two 'Value Package' cases where sustainability requirements were a significant part of the clients' award criteria.

Through my research, I aim to depict 'what happens up close' from the perspective of potential contractors when clients demand 'sustainability initiatives' in tendering. By gaining an improved understanding of how contractors specifically work, and produce value, from 'sustainability requirements', we can move closer to helping tendering documents better facilitate frameworks that favor the integration of sustainability solutions.

REFERENCES:

Larsen, v. G.; Antonucci, v.; Tollin, n., Sattrup, p. A.; Jens, k.; Birkved, m.; Holmboe, t.; Marella, g. 2023a. A methodological framework to foster social value creation in architectural practice. *Sustainability*, 15, 25.

LARSEN, V. G.; TOLLIN, N.; ANTONIUCCI, V.; BIRKVED, M.; SATTRUP, P. A.; HOLMBOE, T.; MARELLA, G. 2022A. Filling the gaps - circular transition of affordable housing. Sbe22 berlin d-a-ch conference: built environment within planetary boundaries (sbe berlin) 20/09/2022 - 23/09/2022, volume 1078.

Larsen, v. G.; Tollin, n.; Rasmussen, m. K.; Entwhistle, j.; Brøgger, k. 2023b. Circular transition of the construction industry. Rethinking organisational conditions in the affordable housing sector. X ed.

Larsen, v. G.; Tollin, n.; Sattrup, p. A.; Birkved, m.; Holmboe, t. 2022b. What are the challenges in assessing circular economy for the built environment? A literature review on integrating lca, lcc and s-lca in life cycle sustainability assessment, lcsa. *Journal of building engineering*.

Building platforms to scale the circular economy in the construction sector

PROJECT

Industrial PhD
CircOP

AUTHORS

Julia Köhler

ORGANIZATIONS

Technical University
Denmark (DTU)

The pressure on the global construction sector is two-fold: the growing population increases the need for affordable living space while global resource scarcity drives rising construction costs. At the same time, current construction practices contribute to the exceedance of absolute environmental boundaries. Reaching international goals of remaining within planetary boundaries requires reducing the consumption footprint (European Union, 2020), which in turn gives rise to attempts to implement the circular economy (CE) in the construction sector. The CE offers not only potential financial benefits, but also a lessening of ecological burdens. This research project sets out to investigate whether platforms can help overcome the difficulties of implementing at scale a systematic approach like the CE in a highly fragmented industry such as the construction sector.

Both practitioners and academics point to the importance and challenges of implementing CE in construction (e.g. Styles et al. 2018, Osobajo et al., 2020, Ottosen et al., 2021). Difficulties and opportunities related to value-chain integration (Osobajo et al., 2020, Ottosen et al., 2021) and documentation (Styles et al 2018) are currently not covered by systematic research and development. Today, value chains follow an institutionalized division of labor organized in short-term projects as the primary mode of production, which leads to a fragmented construction industry (Sheffer and Levitt 2010). The adoption of an inclusive approach to implementing circularity is hampered by fragmentation along three dimensions: (1) Vertical fragmentation represents

the lack of knowledge exchange between various project phases. (2) Horizontal fragmentation describes the lack of synchronization between various stakeholders at the same project stage, and (3) longitudinal fragmentation results from knowledge dissipating as project teams dissolve (Jones et al., 2021).

Platforms are generally described from either a technical or ecosystem perspective. The technical perspective (Baldwin & Woodard 2008) views a platform as “a set of stable components that support variety and evolvability in a system by constraining the linkages among the other components”. The ecosystem perspective focuses on the actors around the platform ecosystem and creates infrastructures for organizational learning and innovation that enable specialization and optimization across the value chain. By carefully optimizing products, processes, and the division of labor, platforms facilitate the pursuit of value while minimizing waste, and have proven to be successful tools (Gawer 2011) for achieving long-term strategic benefits in such industries as automotive, aerospace and defense. Since their current application in construction is limited (Thuesen & Hvam 2011, Jones et al. 2021), even more so in terms of sustainability and the CE, this project sets out to unlock both the industrial and academic potential for developing platforms that systematically improve the competitiveness of circular products and services in the construction sector, and thereby help to reduce the construction sectors’ absolute impact on the environment.

Circular construction platforms (CircOp) – preliminary findings from four case studies

PROJECT

Grand Solution,
CircOP

AUTHORS

Christian Thuesen

Julia Köhler

ORGANIZATIONS

Technical University
of Denmark (DTU)

Platforms belong not just to the realm of IT, they are also powerful tools for specialization and scaling in organizations. The success of Tesla in scaling electric cars and the ambition of Ørsted to industrialize offshore wind are based on platforms and CircOp aims to do the same for circular construction.

Over the last two years, the CircOp program has utilized platform-thinking to accelerate the transformation of construction towards circularity by de-risking investments in circular solutions. Through action-oriented research in four complementary platforms, the partner companies RGS Nordic, Næste, E&P, and GXN work with CircOp to further four societal goals: climate action, responsible production, economic growth, and job creation. The complementarity is based on two dimensions: market/value propositions for linking supply and value chains of different complexities, and key capabilities for leveraging unique organizational strengths from fast local prototyping to industrialized production (see table 1).

The preliminary findings from four case studies show that platform-thinking enables six aspects of circularity transformation in construction, specifically:

1. Platforms enable detailed documentation of circular solutions and create shared standards for organizing products, processes, and organizations across projects enabling documentation and sharing of information across materials, projects, and value chains.
2. Platforms enable variance of circular solutions and secondary materials. Platform adaptability in managing customization and leveraging project similarities tackles the high-variability and low-volume of secondary materials. This platform also challenges the conventional targeting of different "end users" which in a circular economy is a problematic concept as materials have no defined end to their usefulness.
3. Platforms enable productivity development of circular solutions that are relevant over time. Existing circular solutions compete in markets that prioritize short-term gains over long-term value. In contrast, the long-term perspective of platforms drives incentives to optimize value and cost to enhance productivity and competitiveness of secondary materials to meet future needs.
4. Platforms enable effective decision-making on circular solutions. Circular construction introduces high levels of uncertainty and ambiguity, challenging decision-making. Platforms enable a better understanding of how decisions cascade along the value chain, and thereby help develop more scalable, innovative, and holistic solutions.
5. Platforms enable organizational specialization towards complex circular solutions. A fragmented industry squanders project knowledge, hampers communication and decision-making, and limits the sharing of best practices. Platforms enable value-adding repetitions driving specialization in complex circular solutions.

6. Industry-wide scaling of circular solutions. Circular solutions often fail to make the leap from prototypes to industry-wide adoption. Platforms enable industrialized production and scaling in local and global markets.

Yet, while platform-thinking represents a core enabler for the transformation of construction towards a circular economy, it faces certain challenges. These include, among others: clarifying the understanding of platforms, changing the typical project-based mindset in the industry, overcoming the lack of a one-size-fits-all strategy, defining the right balance between flexibility and standardization, and adapting platform-thinking to fit the circular economy in construction. We plan to extend CircOp with new partners/platforms and research activities to address these issues and further develop platform-thinking for the circular economy in construction.

PLATFORM	CUSTOMERS	CAPABILITIES	STRATEGIC AMBITION	
Material Supplier RGS Nordic	Næste, GXN, EP, Moelven	Reversed supply chain for production of reused & recycled materials	1. Transformation from waste handler to resource provider supplying documented materials for manufacturing of circular construction products.	
Manufacturer Næste	Lejerbo, KAB, Boligkontoret DK, DEAS	Circular supply chain, agile work, LivingLab, standardization of production under variance, new business models	1. Scaling sustainable business & value chain by using C&DW for secondary buildings (sheds). 2. Creation of new architectural typologies. 3. Scaling of model via local partners.	
Contractor Enemærke Petersen	KAB, City of CPH, Cevica...	Refurbishment, lean processes, strategic partnerships, long-term thinking	1. Use of strategic partnerships TRUST and 80s as a platform to implement circular construction 2. Integrate KAB's sustainability strategy inspired by Nordic Built Charter as a component of refurbishment and new buildings.	
Consultancy GXN Innovation	Upcycled commercial projects in UK, Belgium, Australia: e.g. British Land, Nextensa, Stockland	Circular design & construction, upcycled materials and products, strategic client advising, innovation processes, new construction, digitalization, global mindset	1. Expansion and leverage of first-mover advantage. 2. Establishment of new capabilities and supply chain partnerships.	

Figur 1:

Platform overview of CircOp



	CIRCULAR BARRIERS	PLATFORM ENABLERS	IMPACT TARGETS
	<p>1. Lack of common language and standards in procurement and processes</p> <p>2. Comprehensive assessment concepts for the recycling of C&DW.</p>	<p>1. Overview of material flow with-in the organisation</p> <p>2. ABC Analysis of materials</p> <p>3. Relational Model for Reused Concrete</p>	<p>2030: Saving 300.000 t CO2-eq</p> <p>Year 5: Saving 400.000 t of primary materials Increase revenue by 15-30 M DKK 30-50 jobs created directly indirectly</p>
	<p>1. Transparency of circular solutions and data in the reverse supply chain</p> <p>2. Lack of information on the quality and availability of materials</p> <p>3. The right model with prefab for growing business with a reversed supply chain</p>	<p>1. Overview of financial-, information-, and material flows of reclaimed wood throughout the value chain around Næste</p> <p>2. Development from A-Shed-a-Month to A-Shed-A-Week</p> <p>4. Prototyping service concept "shed as a service"</p> <p>5. Innovative mounting table for producing standardized modules out of non-standard materials.</p>	<p>2030: Saving of 155 t CO2- eq Saving 150 t of primary materials</p> <p>Year 5: Increase revenue by 40-50 M DKK 40-50 jobs created directly and indirectly</p>
	<p>1. Inefficient circular processes making circular solutions uncompetitive in the marketplace</p> <p>2. Reuse of buildings is prioritized in society, meaning refurbishment instead of demolition</p>	<p>1. Mapping flow of materials from procurement to waste</p> <p>2. Purchasing parts of Genbyg</p> <p>3. Data Dashboard including ABC Analysis for reused goods in storage (Genbyg)</p>	<p>Not estimated yet.</p> <p>Contract value on 7 B DKK 30-40 projects</p> <p>5-10.000 apartments 15-20.000 tenants</p>
	<p>1. Ability to transition to circularity in the various scenarios client cases represent, which demands agile and easy tools for, e.g. mapping and analysis of material potentials in existing buildings as well as strategic analysis and decision making at a real estate portfolio level.</p>	<p>1. Mapping and standardization of interfaces with external partners</p> <p>2. Documentation of GXNs consulting services on upcycling processes</p>	<p>2030: Saving of 15.000 t CO2-eq Saving 100.000 t of primary materials</p> <p>Year 5: Increase revenue by 15-30 M DKK 10-20 jobs created directly and indirectly</p>

Towards a revised understanding of resources and economy in the circular economy

PROJECT

Grand Solution,
RECIpe

AUTHORS

Stefan Christoffer
Gottlieb

Nicolaj Frederiksen

Christian Koch

Martine Buser

ORGANIZATIONS

Aalborg University

Chalmers University
of Technology

While the circular economy (CE) is gaining political traction, with steps being taken to embrace CE principles at European and national levels, practical progress remains elusive. One reason for this is that the transition to the CE is predicated on the need to decouple economic activities from the consumption of finite resources. Yet most initiatives treat the notion of economy as a mere contextual backdrop for proposed actions, an aspirational outcome rather than a realized process of consumption and production. More critically, policymaking, research, and practical efforts to adopt CE principles often draw on dogmatic neoclassical economic assumptions that markets and the economy work as naturalized phenomena that are disembedded from other societal functions. Moreover, these approaches crucially fail to recognize that the concept of the/an 'economy' is not a pre-given entity, but a construct shaped by social, political, and not least, material processes in the form of the very resources that are the central focus of the CE.

This results in an underdeveloped understanding of the relationship between economic activities and processes of production and consumption. Drawing on insights from the sociology of economics, our project aims at addressing this by developing a dialectical understanding of two pivotal constructs within the circular economy namely 'economy' and 'resources'. Thus, rather than seeing CE as a question of how to decouple economic activity from the consumption

of finite resources, we consider consumption and production processes as economic activities per se that contribute to shaping the boundaries of markets.

We do so by studying how ‘non-economic’ aspects of the circular economy, such as new design and production methods, recycling, and reuse, are translated into economic terms, thereby making them subject to valuation, calculations, and decision-making. This translation reveals deeper insights into how specific consumption and production practices may be realized, and how to create a new performative economics of circular consumption. We apply a similar understanding in our study of resources. Instead of seeing resources as tangible and fixed goods that are innately valuable, we advocate an approach that emphasizes the processes through which a potential resource is transformed into a ‘resource in use’. This entails a focus on the relationship between resources and the existing institutionalized rules, norms, and conventions which constitute a framework of. This perspective enables us to understand how frameworks for action can be altered to accommodate the use of certain resources instead of others.

We pursue these understandings in a study of how alternative forms of economic organization, business models, and market mechanisms can be developed to support the circulation of products and services that mobilize new resources or new types of resource use in the construction industry. In doing so, the project provides a more critical perspective on the dynamics and processes involved in the transition to the circular economy compared previous efforts in the Danish and international contexts.

From policy to practice: Regulating for sustainability in construction

PROJECT

Industrial PhD

AUTHORS

Andreas de Gier

ORGANIZATIONS

Enemærke & Petersen
A/S

Aalborg University

Chalmers University
of Technology

Global environmental conditions are degrading at an alarming pace, leading the Intergovernmental Panel on Climate Change (IPCC) to shift its narrative with additional warnings and critical consequences of global warming. This crisis calls for immediate action, prompting both global policymakers and the European Union to introduce a series of regulatory initiatives and agreements. Within the European Union, the Commission has presented an extensive array of legislation and action plans designed to align with these political ambitions and pave the way for a climate-neutral continent by 2050. A specific portion of the European engagement in sustainability laws focuses on sustainable finance. This entails new economic demands on private market participants, encouraging them to find economic advantages in investing in sustainability. These laws are intended to incentive all levels of the value chain, encompassing investors, building clients and construction companies, to embrace sustainability as a common objective.

However, there is limited qualitative research examining the practical implications of sustainability regulations and the link between policy and practice in the construction industry. This research project seeks to bridge that chasm by exploring how the industry tackles new laws and regulations and examining their impact at multiple levels, from construction clients to organizational structures and on-site practices. Specifically, the research explores three different perspectives, an industry, a company, and a project level of analysis, to understand how different areas are affected by

sustainability-focused laws.

The first level (industry) focuses on the dynamics of construction as a field, examining how different types of construction clients (public, private, and third sector), with varying operational practices, economic focuses, and business structures, are differently affected by sustainability regulation. As construction clients are typically dominant in defining the degree of sustainability in construction projects, they often set the tone for the industry's response to sustainability demands. This part of the analysis thus seeks to unravel how clients of various profiles influence the construction industry's approach to sustainability leading to a new common ground or divergent clients demands.

The second level (company) zooms in on the internal policies of a large construction organization as it seeks to comply with the EU taxonomy. It explores how interorganizational dynamics and competing priorities within the organization create challenges when implementing strategies and internal policies to comply with regulatory demands. For example, on-site management finds it difficult to balance compliance with EU taxonomy requirements with the need to meet project timelines and cost-efficiency targets.

The third level (project) examines a construction site to study the direct implications of waste laws and internal policies aimed at increasing recycling percentages. Here, the study identifies various issues as well as the on-site management's practical focus and lack of access to waste data and statistics. Furthermore, the classification of waste categories faces some practical limitations for the contractor as large amounts of mixed waste leave the construction site unnoticed.

The overarching implication of this study is that the downstream impacts of political sustainability laws are complex and protracted, and implementation is impeded by similar issues across the three levels of analysis, highlighting similar issues as policies undergo an array of industry-specific processes, norms, and routines. The nature of environmentally-oriented regulations and these industry-specific dynamics creates and sustains a gap between policy and practice that could limit political ambitions and obligations around sustainability.

Driving toward circular business models: Conditions and strategies in the built environment

PROJECT

Industrial PhD

AUTHORS

Ingvild Reine Assmann

ORGANIZATIONS

Rambøll Danmark A/S

Technical University of Denmark (DTU)

Copenhagen Business School

The first article being covered is based on research which uncovered a collection of determinants that drive or hinder firms' adoption of circular business models (CBMs). Through a systematic literature review, 54 different categories of determinants were identified, which were grouped into eight separate macro categories: culture, regulation, market, strategy, business case, collaboration, operations, and knowledge. This research found one of the determining factors to be "Conservatism and reluctance of the industry when it comes to the green transition" (Assmann et al., 2023, p. 3; Rizos et al., 2016). The built environment industry has been characterized as slow to change (Gambatese & Hal-lowell, 2011), and multiple scholars report a lack of innovativeness (Brockmann et al., 2016; Koskela & Vrijhoef, 2001; Laborde & Sanvido, 1994).

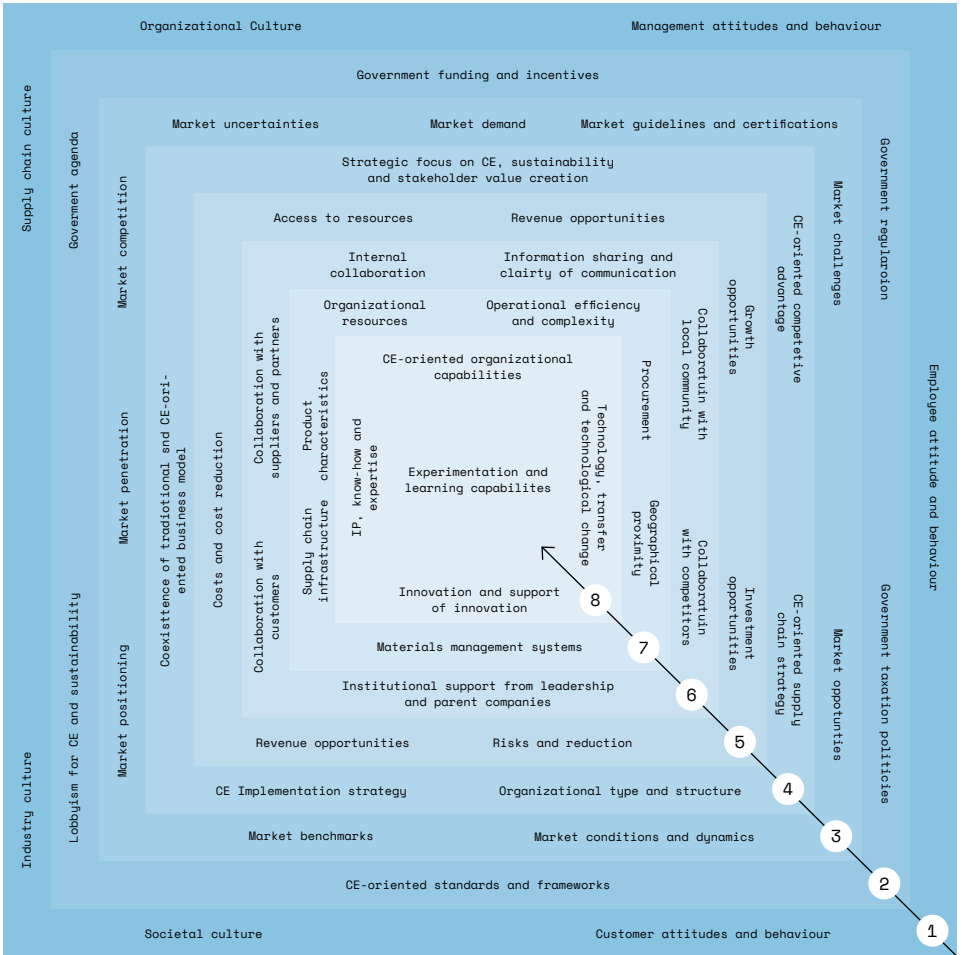

- 1 Culture
- 2 Regulation
- 3 Market
- 4 Strategy
- 5 Business case
- 6 Collaboration
- 7 Operations
- 8 Knowledge

Figure 1:

Category map of the determinants of circular business model adoption, ranging from most external to most internal category

The second article therefore set out to investigate the connection between innovation and lack of innovativeness, using the built environment as its research context. The article revealed that although the built environment was still considered by experts to be conservative, there were a plethora of drivers toward circular business model innovation (CBMI), and experts argued that CBMI was increasing due to number of drivers. As there has been limited research on the application of CBMI in the context of the built environment, particularly studies that provide strategic recommendations for practitioners to apply to their own business models and organizations (Adams et al., 2017), this article aimed to fill this gap by conducting a Delphi study with 25 international experts on the circular economy, CBMs, and the built environment. The data gathered through the study allowed the authors to identify the barriers and drivers that the experts considered imminent in the industry, and 34 strategies that can be used to account for these and stimulate CBMI in the built environment. Next, we classified these strategies into four categories for closing resource loops: 'Understanding the loop', 'Facilitating the loop', 'Promoting the loop', and 'Regulating the loop'.

The third article examined how circular and linear startups in the built environment nurture their entrepreneurial ecosystems to increase resilience in response to crises. Specifically, we used the context of the impending material crisis in the built environment. Our findings highlight how the startups that actively nurture their ecosystems are gaining resilience. We found that the circular startups explicitly nurtured each ecosystem to the point of treating it as a living organism in need of food and care to be in optimal health; sharing data and projects, and dividing roles and opportunities for commercial purposes, and fostering a "give and take" mentality. We argue that cross-collaboration is the essence of circularity, and that startups with CBMs can thus be more likely and able than linear startups to strengthen resilience by being intimately connected with and nurturing of their ecosystems.

Figure 2:

Circular business model innovation strategies

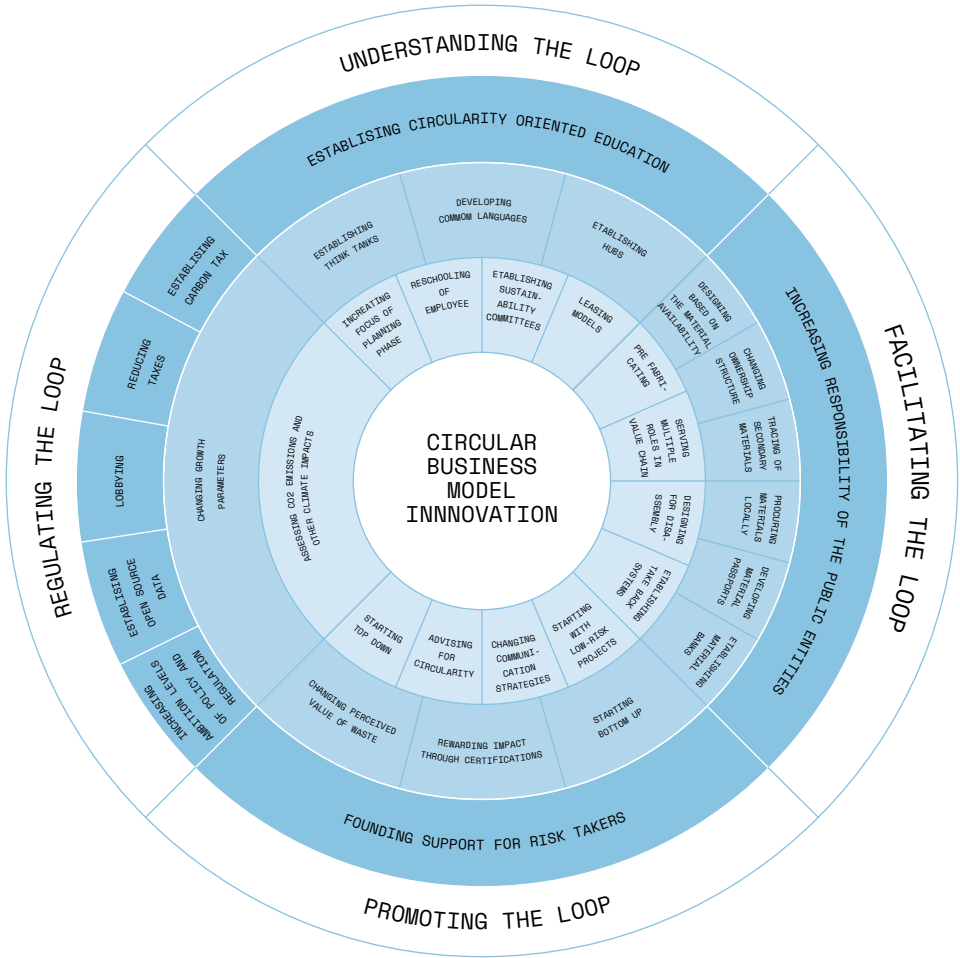

- Company
- Industry
- Policy

Economy & Societal Structures

Abstract



Gaining a competitive edge: The influence of PhDs in Enemærke & Petersen

In a competitive construction industry, subject to EU taxonomy and sustainability regulations, one of Denmark's foremost entrepreneurial firms is leveraging PhD expertise to position itself as a powerhouse in sustainable construction.

Enemærke & Petersen (EP) has been integral to the Circular Built Environment Network (CBEN) since the network's inception in 2017. The initial success of the engagement led to the hiring of two new industrial PhD candidates, Lin Engholm Kjerulf and Andreas de Gier, who joined the company in 2020 when the current network was launched. As CBEN prepares for its third iteration in 2024, EP is again planning to welcome one or more new PhD candidates, thereby solidifying its commitment to network-based sharing of results and circular, research-driven entrepreneurship.

Intrigued by their dedication to CBEN, we inquired EP's sustainability manager, Anders Strange Sørensen, to discover why PhD candidates play a pivotal role in the enterprise.

Q *Why is CBEN of interest to you?*

A Being a part of CBEN offers us extensive insights into the expansive research landscape within the circular economy field. This knowledge is a tremendous asset for our company and me personally in my daily work. I am now knowledgeable about the endeavors of researchers and where the industry is heading. The network provides exposure and fosters valuable synergy, offering a substantial advantage. Moreover, it has expanded my professional network and is a valuable resource for reaching out to potential partners for new projects.

Q *Do your PhD researchers give your company competitive advantages?*

A Absolutely. Our PhD researchers bring extensive and specialized knowledge that can help us navigate the significant challenges facing the construction industry. Their contribution is indispensable for our business development, especially given the tight, low-margin budgets we work with. I firmly believe that our capability is amplified due to the work contributed by our PhD researchers.

Q *How do they specifically help in developing your business?*

A They bring concrete insights that we can leverage in refining our branding and positioning. For instance, our researcher, Lin Kjerulf, works with proposals on how circular solutions can be implemented in construction projects. This knowledge becomes an asset in our offers and can be strategically employed in client discussions. I can inform a client that we are integrating one of our PhD researchers into a project right from the start – a value proposition that clients truly appreciate. This sets us apart in the industry.

Q *Only some of your PhD researchers are affiliated with CBEN. What advantages are there in being part of the network?*

A All our PhD researchers bring significant expertise. However, there are

benefits for those affiliated with the network. Being part of CBEN opens up opportunities for cross-dialogue, collaborative brainstorming, and access to connections with other researchers they might not have otherwise. Our PhD researchers, Lin and Andreas, found connecting with other researchers through the network more accessible, enriching their projects with an expanded academic network they could readily draw upon.

Q *Has EP become more circular due to the network?*

A Definitely. One example is the work of our PhD researcher, Andreas de Gier, which focuses on EU legislation and taxonomy. This allows us to craft compelling proposals with sustainability at their core. This initiates conversations that go beyond mere price considerations. For example, we can offer more informed advice to clients regarding sustainability in their procurement processes.

In the past, we tended to embark on each new project with a clean slate. Now, our PhD researchers play a crucial role in extracting sustainability best practices from previous projects and integrating them into new ones, thereby adopting a more circular approach.

Enemærke & Petersen has, for the last three years, been working with industrial PhDs Andreas de Gier and Lin Kjerulff as part of CBEN.

Andreas de Gier has dedicated his efforts to a project titled "From Policy to Practice: Towards a Circular Waste and Resource Management on Construction Sites". This collaborative initiative involves Enemærke & Petersen A/S, Aalborg University, and Chalmers University of Technology.

PhD Lin Kjerulff leads the project "Circular Tendering Strategies in Contractor Firms", which has been conducted with Enemærke & Petersen A/S, AAU Build, and Copenhagen Business School.

"Our PhD researchers bring extensive and specialized knowledge that can help us navigate the significant challenges facing the construction industry. Their contribution is indispensable for our business development, especially given the tight, low-margin budgets we work with. I firmly believe that our capability is amplified due to the work contributed by our PhD researchers"

Anders Strange Sørensen,
Sustainability Manager at Enemærke & Petersen

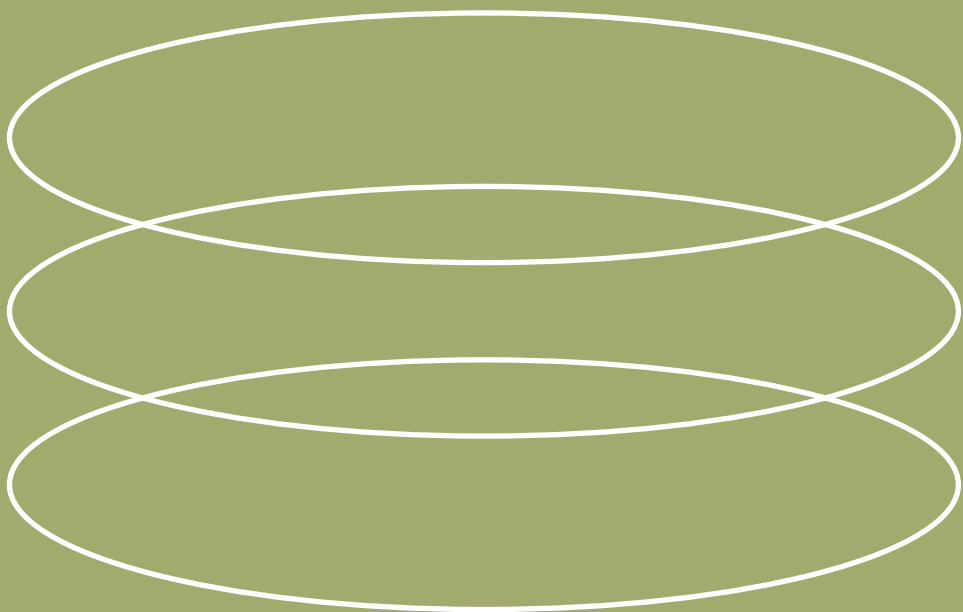

TRANSFORMATION
& STRATEGIC
RESEARCH

12345

Re-entanglement: What are the possible futures of our planet?

Introduction by
Christian Gaeth,
Bauhaus Earth

Throughout the past two centuries, progress in science and technology has predominantly been utilized for the short-term financial optimization of value chains, often without due consideration for long-term consequences. But the prosperity of a small portion of the world's population has been financed through the exploitation of nature and the sacrifice of ecosystems that have flourished since the last ice age. While air pollution, reckless waste disposal, and soil degradation have produced lethal living conditions for various species, including humans, the forecasted depletion of fossil fuel resources pushes humans towards increasingly brutal environmental interventions to dredge up the remaining reserves of oil, gas and rare earth elements. The consequences of our treatment of the earth have transcended mere predictions, manifesting in extreme weather, soil degradation, and species extinction. Geologists refer to this era as the Anthropocene, marking a turning point from the Holocene, where the ability of species to recover after major events has been lost –the initiation of a downward spiral.¹

The built environment stands as the primary contributor to carbon dioxide emissions and is a significant source of unrecyclable waste. After the production of building materials, maintenance of the built environment contributes 17% of global emissions². Consequently, the built environment accounts for 40% of worldwide carbon dioxide emissions and its footprint on the landscape a significant disruptor of the natural processes of carbon sequestration. Slowing down or halting climate change is unattainable without

re-evaluating the conception, construction and maintenance of architecture. Materials crafted from finite resources via energy-intensive processes warrant reconsideration of their viability in a world marked by a changing climate. Likewise, the technologies used to heat, cool, and power the built environment must be reassessed in order to preserve and adapt the structures that we have already built rather than demolishing them. With respect to the natural environment, the human species must be 're-entangled' into ecosystems and our footprint rescaled back to sustainable proportions.

Given the graveness of the situation, halt to the escalation of human impact is no longer sufficient to prevent a worsening of climatic conditions and irreversible changes to global systems. What is required is an approach that no longer views the planet as a collection of resources available for human enrichment, but instead seeks actively to restore and maintain natural systems. Rather than focusing on maintaining current conditions, the emphasis must shift towards regeneration and re-entanglement. This entails the adoption of an economic system that acknowledges and submits to environmental boundaries. The concept of regeneration embodies the idea of self-preservation, serving as a catalyst for an upward spiral that could, at least partially, reverse the damage inflicted by humans on the planet. If the fallacy of the past century is that there are universal solutions with global application, the pressing question emerges: What are the possible futures of our planet?

This question calls for strategic research as a foundation to make informed decisions about how to avert the impending crisis. Strategic research enables us to produce policies and approaches that holistically consider various potential impacts and externalities rather than focusing on single issues. A re-entanglement with earth systems requires the comprehensive anticipation of our actions' consequences and a shift to prioritizing long-term goals over short-term results in a location-specific theory of change. Considering the intricacies of possible future scenarios in globally interdependent systems is the daunting task of research and science that is becoming essential to re-imagine the futures of the planet.

REFERENCES:

⁽¹⁾ **Anna Tsing**, “**Feral biologies**“, Anthropological Visions of Sustainable Futures, London: University College London, (February 2015).

⁽²⁾ **Edgar G. Hertwich**, “Increased Carbon Footprint of Materials Production Driven by Rise in Investments“, Nature Geoscience 14, Nr. 3 (March 2021): 151-55.

Regenerating circularity

AUTHORS

Thomas Bo Jensen,
Head of Research ^{1,5}

Christian Geath,
Researcher ²

Jacob Blak,
Head of Resiliency ³

Heidi Sørensen Merrild
^{1,4,5}

ORGANIZATIONS

⁽¹⁾ Aarhus School of
Architecture

⁽²⁾ Bauhaus Earth

⁽³⁾ Cobe

⁽⁴⁾ Architect and
Industrial Researcher

⁽⁵⁾ Friis & Moltke A/S

The ideal of a Circular Built Environment blinds us. The notion of circularity anticipates a world in balance, a perfect orbit in which resources are endlessly reused and nature is therefore left untouched by human habitation. But nature itself is imbalanced and disordered. From the day life taught us to transform sunlight to chemical energy and started to create the atmosphere, the world has been out of balance. A constant battle between lifeforms has taken place ever since – a battle in which human beings, the most recently arrived guests on the planet, have accelerated the imbalances negatively, with invasive and devastating effects on the climate and biodiversity.

Geologist Minik Rosing's said, "the goal of harmony is hopeless" and so, rather than seeking balance, "our task is to find out how to fit into the system between all the other living organisms with the least number of subversive effects on our own basis of life. (...) If architects only become reactive to the problems, they solve nothing. The goal, in my opinion, must be to make a footprint that will remain, which is as beautiful and functional and wonderful as possible, so we don't have the heart to destroy it."

While maintaining the essence of material circularity, we need to broaden the concept to encompass a deeper understanding of situatedness and temporality, and a terrestrial sense and empathy as deep as our ancestors'. Even the smallest parts in a circular building process relate to something outside the circle. A more inclusive relational understanding of the building process is thus essential if Minik Rosing's vision is to become a reality. Furthermore, nature's tremendous regenerative capacity should become a focal point for all future architecture; for the love of the planet, for the love of beauty.

TERRESTRIAL CAPACITIES

The production of building materials alone is responsible for more than 23% of global CO₂ emissions. Current extraction and production of construction materials play a large role in contributing to a material accumulation that is in most cases not recyclable or reusable. At the same time, the conversion of forest areas into suburban settlements, industrial parks, agricultural land, and mining areas has significantly reduced the terrestrial capacity for carbon sequestration. The built environment is thus not only responsible for producing an excess of CO₂ emissions, but also for the fact that natural carbon storage processes have been devastated. We must therefore question how we source, modify, use, and dispose of the materials used in the built environments.

A critical examination of the individual components of architectural production is required. Avoidance and reuse are the most important factors here, and materials that are produced from finite resources must be denied their *raison d'être* in many areas of application. Built environments need to be designed with a focus on material origin and processing rather than on form and aesthetics, or a new aesthetics. Building upon the principle that no single answer can provide a universally and globally applicable solution, regionalization plays a significant role alongside ecologization.

In this context, it is imperative to consider the specificities of individual ecosystems. While acknowledging the interdependence of individual systems and phenomena, the task of saving a 'place' is more tangible and achievable than saving the entire planet. A land-oriented approach in architecture addresses the natural conditions of its location in both design and material selection.

It is essential to explore where natural boundaries emerge in terms of understanding the qualities and quantities of materials nature produces. These materials must be utilized in a manner that also addresses climatic conditions, emphasizing a low-energy maintenance of the architecture. The negotiation between natural supply and architectural requirements will result in a new material selection at the regional level that respects terrestrial capacity. Engaging with raw materials and their availability in a region allows for a critical examination of the division of tasks in architecture, including "ecological" architecture.



↑ Figure 1:

Soil analysis of samples
 from the Berlin-Brandenburg
 region. © Bauhaus Erde/
 Christian Gäth, Micha
 Kretschmann, 2023





Figure 2:

Pressed clay blocks.
© Bauhaus Erde, 2023

UNPACKING COMPLEXITIES

Circular economy is often referred to as a complete redefinition of current financial theory or even economic ideology. For companies competing in the construction industry, (and many other industries), and within the parameters of present paradigms, physical complexities, regulations, and legal standards, engaging with these new ideas can seem paralyzing. Going away from a linear logic towards a circular mindset in the building sector makes companies strive to map (and control) every link in the supply chain to ensure everyone is aligned to an overall shared purpose. Achieving this requires, an overwhelming amount of transparency and trust. This is a process few companies are prepared for or have the resources to even attempt. Not to mention, that a new set of contracts would need to be introduced to multiple industries and more paperwork is not necessarily the road we want to proceed down.

The question is, are there other ways to reduce the complexity for the individual while still contributing to a shared goal? Traditionally, we have trusted in regulation (rules) and certifications (motivation) to delineate the practice of responsible business within the construction industry, but these tools seem to be either too heavy or too imprecise to be workable.

Substantial investments need to be channelled into circularity to drive momentum and scale. For this to happen, efforts should be distributed so it is possible for even small actors to reform or refine one aspect of the supply line, while trusting that this work will be rewarded further down the chain – without the need for control or potential sanctions. A more self-sustaining system might enable this process, such as the approach of storing data in a blockchain used in fields including healthcare.

As a system for recording transactions on a peer-to-peer network, blockchains can underpin a cross-disciplinary approach. Blockchains are based on a decentralized and distributed architecture that provides multiple parties a secure and transparent record of transactions without the need for a central authority to verify authenticity. This technology shows promise as a way to allow the construction industry to help individual companies navigate the complexity of the



Figure 3:

The management of
the research team.
© Bauhaus Erde/
Christian Gäth, Micha
Kretschmann (2023)

industry while committing to a formalized and protected network of trust without the need for a centralized authority to regulate it. Potentially, instantiating every step in a supply cycle as a blockchain transaction could be a way to unpack the complexity of the circular transition in the construction industry.

MATERIAL CYCLES

The inherited frameworks, or current building practices, that modern architecture is built on separates environmental activity from cultural dynamics in a dualistic concept of describing ways of building. To counter this dualism, we need new relations between architecture and nature – a human and nonhuman coexistence. We need a clear link between terrestrial capacities and the built environment, as defined previously in this article. We need to consider the variability of regional resources by introducing consequential thinking into design.

A tendency exists to validate social, atmospheric, aesthetic, and architectural values only if they are measurable. This raises the question of whether the concept itself of planetary boundaries is only valid if we are able to measure them, or if we should also value what experience tells us to be true. We need to balance both relevant metrics and lived observations to form the basis of a consequential design thinking.

Can we by (re)generating and (re)connecting materials in cycles, instead of exploitation, create a new concept? – a concept, where design and building processes, based on transparency and trust, form multiple material cycles that either engenders a renewal of process or the (re)collection of (urban) materials; cycles where building materials travel through history in a continuous re-collection and re-connecting until the day they are broken down and can return to nature again.

Focus on the living – a paradigm shift?

AUTHORS

Mia Kruse Rasmussen ^{1,2,3}

Lotte Nystrup Lund ^{4,5}

ORGANIZATIONS

⁽¹⁾ AART Architects DK A/S

⁽²⁾ Aarhus University

⁽³⁾ Aalborg University

⁽⁴⁾ Udviklingssekskabet
By & Havn I/S

⁽⁵⁾ Royal Danish Academy

To content with the complex, uncontrollable, and ever-changing character of this world in which we all live, we need to rethink our approach to the built environment. The traditional circular perspective, which predominantly focuses on resources (materials and energy), requires a reorientation. Attention needs to shift from objects and materials to a wider focus on “the living”.

So, what does “focus on the living” mean, in the context of the built environment? At its core, this perspective urges us to recognize that a building is not an isolated entity, but is intricately connected to living organisms, including humans and the socio-ecological systems they are part of.

A building, and the infrastructure around it, is primarily made of natural resources extracted from living environments that serve as habitats for mammals, insects, birds, fungi and so on. While wood once lived as trees in forests, concrete consists of sand, stone, and water which once played an essential role in aquatic ecosystems. International research assesses that the built environment is responsible for 30% of current biodiversity loss on a global scale, when including the off-site impact of buildings extracting materials from living environments, and thereby radically changes landscapes and ecosystems.

When we focus on the living, we delve into these relational entanglements between living beings and built environments, and the ongoingness of architecture as it evolves alongside these flows of socio-ecological relations. This involves acknowledging what was there before we began constructing – species, habitats, ecosystems – and considering what comes after the building stands. We need to understand how life keeps going and grows in different

directions, as inhabitants engage in everyday socio-material practices in, through, and around the built environment; how these entanglements continuously shape environments and social life, and how we might work to give these entanglements direction.

So, how do we deal with the living in this perspective? One answer lies in embracing complexity and multiplicity and rejecting the quest for singular, definitive solutions. Instead of trying to predict the future through precise measures and fixed standards, we should prioritize 'resonance' and 'correspondence' as ways of moving forward; setting things in motion and letting them evolve as part of this interconnected web of socio-ecological relations. This approach requires us to adopt multiple and multispecies feedback loops. Our actions have consequences, rippling through ecosystems and societies in complex ways. This insight reveals the need for participatory processes in which we invite ongoing feedback from the living – be it humans, flora, fauna, or fungi – to continuously qualify relational entanglements and engage actively with our capacity to imagine possibilities for life to come; through ongoing collaborative processes of making and transformation, as part of the world's becoming, not separate from it.

One crucial realization is that current measures of success are often misleading. Numbers, such as those derived from standard certification tools, are not objective truths but products of human decision-making. They frequently fail to account for the cascading impacts that material extractions have on ecosystems and social life, and struggle to account for social values in meaningful ways. Instead of relying solely on numbers, we need to find ways of making these aspects count without reducing them to static entities with a limited set of attributes. We must embrace other narratives, stories highlighting the significance of living organisms and their role within socio-ecological systems, and find ways of navigating this complexity in practice by opening up the scope of what these conversations might entail and who is invited to participate.

Replacing a fixation on numbers and objects with a focus on relational performances and stories could help us better understand and work with the nuances and dilemmas of the built environment – how form is continuously gener-

ated within process, and how these flows or transformations extend far beyond building projects. This implies that everything we alter or potentially harm through building practices must be given the opportunity to come alive again. It means healing the wounds we create and fostering relationships between the built and the living.

In conclusion, we propose a reconfiguration of urban development to challenge current narrow perspectives and numerical obsessions. The ambition should not be to design perfect solutions, but rather to create spaces for dialogue that allow co-existence and continuous change by focusing on the living. We see this paradigm shift not as a luxury, but as a necessity for the survival of societies, cities, habitats, and the Earth. Urban developers, builders, architects, and other professional actors of the building industry must embrace this new perspective, weaving threads of socio-ecological well-being into the fabric of our building practices. In doing so, we might start moving towards the much-needed creation of truly resilient cities that thrive in harmony with the living world.

The sweet spot of knowledge in circular decision-making: Balancing deep knowledge and best practices in the age of data and real-world experiments

AUTHORS

Lene Damsbo Brix ¹

Karoline Fogh
Gustafsson ²

Thomas Fabian Delman ¹

ORGANIZATIONS

⁽¹⁾ Circue

⁽²⁾ Lendager Arkitekter ApS

The construction sector is at a crossroads. While it is a cornerstone of modern society, providing shelter, infrastructure, and economic growth, it is also a major resource consumer, responsible for a substantial share of global waste and CO₂e emissions. To address these environmental and social challenges, circular decision-making has gained traction within the construction value chain. Circular construction aims to reduce waste, extend the lifespan of buildings, and ensure a low environmental impact throughout the entire life cycle of a building.

As the industry collects more data and conducts real-world experiments, it is vital to find the right balance between deep knowledge and best practices, to not overburden development budgets or get caught in analysis paralysis. Deep knowledge involves a comprehensive understanding of materials and processes, and their environmental implications. Best practices, on the other hand, involve proven methods and strategies that have demonstrated success in enhancing sustainability and circularity.

DATA: THE FOUNDATION OF INFORMED DECISION-MAKING

In the digital age, data collection has become the backbone of informed decision-making in construction. Through data, we gain insights into material flows, energy consumption, waste generation, and environmental impact.

However, a challenge arises as the volume and complexity of data increase. It becomes crucial to filter, analyze, and interpret data effectively to inform decision-making and to develop clear narratives to assist decision-makers. Collecting and presenting data without a clear purpose can lead to information overload, causing decision-makers to lose sight of their goals and how to reach them.

REAL-WORLD EXPERIMENTS: A CRUCIAL LEARNING PHASE

Real-world experiments are essential for testing and validating circular construction practices, including implementation of innovative strategies, materials, and technologies in actual construction projects.

The challenge with real-world experiments lies in their potential to be resource-intensive and risky. To find the sweet spot between deep knowledge and best practices, it is crucial to strike a balance between experimentation and risk management.

BALANCING DEEP KNOWLEDGE AND BEST PRACTICES:

- **Comprehensive data analysis:**
To make informed decisions, construction professionals must conduct a thorough analysis of the data they collect. This analysis should focus on identifying key performance indicators (KPIs) that align with circularity and sustainability goals. Deep knowledge comes from understanding the environmental and economic implications of these KPIs.
- **Assisted decision-making:**
The owners of deep knowledge need to take respon-

sibility for guiding decision-makers in how to use the artifacts of data analysis. This can be done through scenario building, presenting the receiver with potential next steps and their consequences.

- **Pilot projects:**

To bridge the gap between deep knowledge and best practices, pilot projects play a significant role. These allow for controlled experimentation, enabling construction professionals to test new solutions in a real-world context. Learning from both successes and failures is critical to refining best practices.

- **Knowledge sharing:**

The construction industry is highly fragmented, with various stakeholders involved in a project. Sharing knowledge and best practices across the value chain is vital. Collaboration platforms and data-sharing protocols can facilitate this exchange, ensuring that deep knowledge is leveraged for collective benefit.

- **Risk mitigation:**

Real-world experiments inherently carry risks. To strike a balance, it is essential to implement risk mitigation strategies. This involves setting clear objectives, establishing benchmarks, and having contingency plans to manage unforeseen challenges. It is recommended to assess risk continuously throughout a project's phases to determine if the project should carry on with plan A, or move on to plan B, or plan C.

- **Continuous learning:**

The construction industry is dynamic, with new materials and technologies emerging regularly. To stay at the forefront of circular decision-making, professionals must commit to continuous learning and adaptation. Deep knowledge is an ongoing pursuit.

THE SWEET SPOT:

The "sweet spot" of decision-making within circular construction is where deep knowledge and best practices

converge to maximize sustainability, circularity, and economic viability. Achieving this balance requires a holistic approach that considers data, experimentation, and risk management.

In this sweet spot, construction professionals leverage their deep knowledge to make informed decisions based on data analysis. They draw from best practices, continually refined through real-world experiments, to implement sustainable strategies with an acceptable level of risk. Collaboration and knowledge-sharing across the industry can contribute to a collective effort to advance circular construction.

The construction industry's journey towards circular decision-making is a complex and multifaceted one. As the industry evolves, the sweet spot will shift and adapt to changing circumstances. Striking the right balance will not only promote sustainability and circularity, but also ensure the construction sector's continued relevance in a world that demands responsible resource management and environmental stewardship. The key is to find that delicate equilibrium that fosters a brighter, more sustainable future for construction and the planet.

Integrating biodiversity in urban development

PROJECT

Industrial PhD

AUTHOR

Lotte Nystrup Lund

ORGANIZATIONS

Udviklingselskabet
By & Havn I/S

Royal Danish Academy

Alongside rapid urbanization, escalating climate concern, and the emerging realization of the consequences of biodiversity loss, a new urban concept has arisen: The regenerative city, and with this; ambitions of integrating biodiversity in urban development. The ideology of the regenerative city exceeds classic ambitions of the circular ditto. While circular ideas often focus on reusing, recycling, and reducing resources, regenerative ideas seek to restore and regenerate what has previously been lost. For example, a regenerative city aims for integrating biodiversity and supporting the rehabilitation of ecosystems through native planting, wildlife habitats, ecological steppingstones, eco-education of citizens, and restoration programs connecting the urban with its hinterlands. A regenerative city strives to mimic ecosystem services and to develop multispecies environments focused on the needs of more-than-humans. The essence of the regenerative urban paradigm lies in transforming cities from mere (although more and more conscious) consumers of resources into active participants in restoring and enhancing the natural systems that support all life on earth. Thus, the concept of the regenerative city provides a beacon of hope, but the idea of a city integrating into a complex web of ecosystems challenges the urban actors of today, as neither biodiversity issues nor ecosystem thinking has traditionally been a focus in urban development.

The research offers a deep case study exploring today's practices targeted biodiversity in urban development and explore ideas of the regenerative city, navigating an intricate web of urban actors and their sometimes collaborative, sometimes conflicting endeavors. The study uncovers drivers, barriers, paradoxes, and diverse strategies related to

integrating biodiversity in the city.

The study captures the balancing act required to transition ideas of biodiversity from vision to reality, delving into complexities born of conflicting interests, financial constraints, diverse worldviews, and knowledge gaps obstructing the transformative journey towards a regenerative city benefitting citizens of today, tomorrow as well as the more-than-human. The findings emphasize the indispensable role of ongoing communication and collaboration among stakeholders to help surmount conflicts and hurdles and unfurls a tapestry of deeply embedded (power) dynamics shaping the urban landscape. It delves into varying ideas and practices of different urban actors – where grassroots movements voice their ideas of biodiversity alongside urban officials.

This case study underscores the imperative of holistic thinking, cocreation and cooperation, transcending silos to craft urban spaces that truly incorporate ecosystem thinking. The research is relevant for urban planners, researchers, policymakers, and citizens seeking insights into how to re-envision urban landscapes. The study can inspire the journey towards a regenerative future where the importance and characteristics of biodiversity are recognized and has become a driver for a radical transformation of the way we develop cities.

Reversible Tectonics

– a circular design concept in the built environment

PROJECT

Industrial PhD

AUTHOR

Heidi Sørensen Merrild

ORGANIZATIONS

Friis & Moltke A/S

Aarhus School of
Architecture

Boligforening
Ringgården

University of Southern
Denmark

Reversible Tectonics, also the title of my PhD project, is an examination of materials, design, and practice developed through the lenses of nature. This is done by overlapping theory and practice, in an aesthetic and creative design approach. The method used is called research through design (RtD), which is an exploration through making. A focus on 1:1 demonstrators inspired by and translating premodern reversible tectonics.

The new climate framework demands rethinking. We must recognize that past methods or concepts haven't brought the changes wished for, and we must therefore transform our current practice. We need an awareness not only of the climate crisis but also corresponding cultural, existential, and philosophical crises. The problem goes far beyond carbon emissions, and so the solutions must go deeper and be more far-reaching than a plan to reduce carbon emissions.

Recent years have brought a focus on scientific methods, measurements, and policymaking, which emphasizes carbon emission reduction. Traditional architectural practices lack openness between disciplines and overemphasize standardization while failing to consider the microscale in materials and the atmosphere and to understand the conditions necessary to maintain an ecosystem.

We often remain entrenched in technical solutions and overlook the need of the transformation of the built environment to encompass a closeness as well as a holistic worldview. This process demands moving beyond the

concept of 'nature' rooted in *Bifurcation*¹ and transforming habitation from a driver of climate and societal crises into a creative force enabling a systemic terrestrial regeneration².

As human beings, we depend on the terrestrial landscape and its materials, and we must accept a new mindset embracing life conditions, both human and non-human. This must be through a self-description, revealing the connection between the world we live in and the one we live from³.

As Bruno Latour writes "*...the Terrestrial is bound to the earth and to land but it is also a way of worlding, in that it aligns with no borders, transcends all identities.*"⁴

The word terrestrial relates to the land of the earth and its inhabitants. The term creates a worldview, reaching from the seed to the plant and its connections from the soil to the atmosphere; understanding the multiplicity and network of materials, and the temporalities from growing to decomposing. This worldview could be the new basis for harvesting and using materials by generating architectural processes supporting human and nonhuman habitation alike.

Materials have in their origin various cycles and temporalities which we must understand in order to respond in a reciprocal way when designing. We must carefully consider their placement and layering in buildings, allowing the materials to flow and become an intermission before being able to decompose back into new cycles within nature. In this way, we can understand architecture as a dense constellation of past, present, and future.

A change in our way of working with architecture is required. In our choice of material, we must understand its circulation in relation to the given time and space. Our choice and placement of materials must be coordinated with terrestrial capacities. A 'beautiful' architecture created through an overproduction and misutilization of resources is no longer an option. We must strive for architecture to create a positive impact in accordance with planetary boundaries.

My research suggests a new reversible design concept, where building principles are transparent and form parts of material cycles; cycles where building materials travel through history in a continuous re-collection and re-cycling, until one day they are broken down into nature again.

REFERENCES:

⁽¹⁾ Alfred Whitehead protests against Bifurcation, which is the idea that entity or form doesn't exist if it has an inability to be localized, and more specifically the modern scientific practice of isolating elements and calling it nature.

⁽²⁾ **DEBAISE, D. Nature as an event, the Lura of the Possible. Duke University Press. 2017, pp. 4-14.**

⁽³⁾ **LATOUR, B & Schultz N., Notat om den økologiske klasse. 2022, Hans Reitzels Forlag. 2022, pp. 84-85**

⁽⁴⁾ **LATOUR, B. Down to Earth. Politics in the new climate regime. Polity Press 2018, p.54**

City as Resource

– tools and strategies for expanded adaptive reuse of the existing building stock

PROJECT

Industrial PhD

AUTHOR

Simon Sjökvist

ORGANIZATIONS

Cobe

Royal Danish Academy

Aalborg University

ETH Zurich

Planning and construction, play critical roles in human activity's transgressions of the environmental 'boundaries' on planet earth, and the return to a so-called 'safe operating space' (Rockström et al., 2009) will require a radical transformation of the way we plan and construct our buildings and cities. One way of responding to these challenges is by using the resources in the already built environment more efficiently. The reserves amassed in our cities, in the form of buildings and infrastructure, form a great repository for future urban development. The potential and necessity of making better use of these vast resources is highlighted in several recent studies as well as in the latest IPCC report (ipcc, 2022).

Studies suggest that the most environmentally sustainable way of reusing the existing building stock is by extending built structures' life cycles through direct reuse (renovation, transformation, or adaptation, hereinafter reuse) (Eberhardt et al., 2019; Hebel, 2020). However, until now, both practices and research of reuse have mainly focused on cultural heritage and on single building projects. Moreover, although half of building materials are in infrastructure (Schiller et al., 2015), this area is largely overlooked.

Taking a broader view and using Copenhagen as a case study, this project addresses the potential for expanded reuse practices (to implement them more systematically, considering a larger urban scale, and taking account of infrastructure) through changed practices of demolition, reuse, and new construction, in urban development at city and

neighborhood levels.

Urban development through urban planning largely influences processes of demolition, reuse, and construction in cities. Most construction takes place in large Urban Development Areas (*UDAs*), (e.g., over 75% in Copenhagen) (City of Copenhagen, 2019), often as transformations of already built-up areas in which existing buildings are, to varying degrees, replaced by new ones. Although there is reason to believe that there is potential in expanding reuse practices in these areas, there is only a vague knowledge of this potential. How much of the building stock could be reused rather than demolished? What changes to current practices would such an expansion of reuse entail? And to what extent could adverse environmental impacts be reduced by doing so?

The project is carried out in four parts: (1) analysis of patterns of demolition, reuse and new build across buildings and infrastructure at city scale and in case-studies of *UDAs*, making use of statistical databases, GIS-mappings, drawings, and planning documents; (2) analysis of how urban planning processes and practices influence demolition, reuse, and new build in three *UDAs*, through analysis of policy documents, design proposals, and interviews with key professionals; (3) analysis of the environmental impact of various scenarios of demolition and reuse in one *UDA* using a method developed to estimate the life cycle aggregated carbon emissions related to types of buildings and infrastructure; (4) prototyping new urban development models through a method of research-based teaching together with students at the Urbanism and Societal Change programme at the Royal Danish Academy.

Based on the results of these investigations, the project examines the scope of the potential for expanded reuse in urban development, and what concrete measures would have to be taken for this potential to be materialized. It further discusses the need for alternative urban planning praxes and speculates on which directions such alternatives might be oriented in.

REFERENCES:

- City of Copenhagen. (2019).** Københavns Kommuneplan. <https://kp19.kk.dk/>
- Eberhardt, L. C. M., Birgisdottir, H., & Birkved, M. (2019).** Potential of Circular Economy in Sustainable Buildings. IOP Conference Series: Materials Science and Engineering, 471, 092051. <https://doi.org/10.1088/1757-899X/471/9/092051>
- Hebel, D. E. (2020).** 100% Ressource: Bauten als Rohstofflager. In Sorge um den Bestand, Zehn Strategien für die Architektur (Vol. 2020). Jovis.
- Ipcc. (2022).** Global Warming of 1.5°C: IPCC Special Report on impacts of global warming of 1.5°C above pre-industrial levels (1st ed.). Cambridge University Press. <https://doi.org/10.1017/9781009157940>
- Rockström, J., Steffen, W., Moone, K., Persson, Å., Chapin, F. S., Lambin, E. F., Lenton, T. M., Scheffer, M., Folke, C., Schellnhuber, H. J., Nykvist, B., de Wit, C. A., Hughes, T., van der Leeuw, S., Rodhe, H., Sörlin, S., Snyder, P. K., Costanza, R., Svedin, U., ... Foley, J. A. (2009).** A safe operating space for humanity. *Nature*, 461(7263), 472–475. <https://doi.org/10.1038/461472a>
- Schiller, G., Ortlepp, R., Krauß, M., Steger, S., Schütz, H., Fernández, J. A., Reichenbach, J., Wagner, J., & Baumann, J. (2015).** Kartierung des Anthropogenen Lagers in Deutschland zur Optimierung der Sekundärrohstoffwirtschaft. 315.

Social commissioning – a relational approach to social value creation in the built environment

PROJECT

Industrial PhD

AUTHOR

Mia Kruse Rasmussen

ORGANIZATIONS

AART Architects DK
A/S

Aarhus University

Aalborg University

Social commissioning is a process to support social value creation in the built environment by maintaining a focus on the relationship between buildings as *projects* and buildings as *lived spaces* throughout the building life cycle and creating spaces for dialogue and joint reflections along the way.

The social commissioning PhD project is rooted in a relational ontology that assumes the constitutive entanglement of the social and the material. Inspired by design anthropology, architectural anthropology, and posthuman practice theory, the project sets out from the idea of an entangled, moving world that is always in the making, and understands buildings as relational performances rather than static objects, as well as viewing design and use as parts of the same continuous process of emergence. Understanding the relationship between people and environments as dynamic and relational, the central question is not what buildings are (buildings-as-entities), but what they make possible (buildings-as-relational-performances). Through my research, I explore how these relational enactments of values play out; i.e. how value is co-created or co-performed between buildings and inhabitants, how we can understand these relationships, and how we might work to support them going forward.

Values are not static, but dynamic and entangled. They are tied to particular practices and thus mean different things to different people at different times depending on the configuration of these practices. Therefore, working with social value creation in the built environment needs to be about

the design of buildings *and* about collaboratively transforming or reconfiguring sociomaterial practices. Buildings do not create social values, and change cannot be designed *for* others, but needs to be enacted in practice. Value creation is dependent on people doing things differently, on our capacity to imagine possibilities for life to come, and on posing new questions instead of looking for simple answers.

The dual focus on qualifying design and supporting transformation is central in a social commissioning process. It is about setting things in motion and creating possibilities for change – in between the social and the material, between the building as *project* and as *lived space*. This work is inspired by a more circular or ecological approach to design, with a stronger emphasis on the processes of co-creation and what these processes make possible in relation to supporting collective change.

Social commissioning is about finding ways of making social aspects count without reducing them to static entities with a defined set of attributes, precise numbers, or absolute values. It is about navigating a relational approach in practice, with an explicit focus on futures and transformation, collaboratively working out ways of moving from relational understandings to relational design by way of engaged architectural anthropology. Giving these transformations direction and focusing on the *how* rather than the *what*, the ambition is not to design the perfect solution, but rather to create spaces for dialogue that set things in motion; a commencement or commissioning of “the social”, not a destination or a final end product.

Sustainable urban development in practice

PROJECT

Industrial PhD

AUTHOR

Gunhild Askehave
Rassov

ORGANIZATIONS

Freja Ejendomme A/S
Royal Danish Academy
Aalborg University

Everyone can agree that our cities should be ‘sustainable’, ‘green’, ‘inclusive’, and ‘circular’. But what do these words mean in practice? What happens when good intentions meet material, financial, and political reality? This thesis provides insight into how popular sustainability concepts are being integrated into practice. The monograph is based on an ethnographic study of the daily lives of architects, investors, and property owners in their work to create a local plan for ‘Copenhagen’s new green neighbourhood’, Jernbanebyen (The Railway District). The thesis offers insight into how practitioners navigate the many dilemmas and contradictions in their work on sustainability, which in practice turns out to be much more complex than what the original ideas suggest. What narratives of a sustainable future take center stage in an investment project like Jernbanebyen and what narratives are excluded? By focusing on sustainability in practice, the goal is to contribute to new knowledge about how sustainable visions and dreams for the future are translated and adapted to the material and financial context of current urban development.

→
When ideas about sustainability hit the material context of planning, dilemmas often arise. Image by the author.





Bridging the gap: Optimizing academia and industry cooperation

In a reflective interview, Thomas Bo Jensen, Head of Research at Aarhus School of Architecture, delves into why research can move mountains, and sheds light on the inherent advantages of outsiders' perspectives within the Circular Built Environment Network.

In pursuing a comprehensive commitment to the study of material cycles – from the initial extraction phase through processing, assembly, and concluding with the return to nature – Thomas Bo Jensen has supervised Industrial PhD Heidi Merrild within the Circular Built Environment Network. Merrild's research focuses on reversible architecture, aiming for groundbreaking solutions promoting more conscientious utilization of building materials.

We asked Thomas Bo Jensen to provide insights into the tangible impact of his involvement in the network, particularly in bridging the gap between theoretical research and practical applications within the construction industry.

Q *In what ways has participation in the Circular Built Environment Network been an asset to the project?*

A Myriad discussions in the network have inspired and enriched our exploration of reversible tectonics, introducing diverse perspectives, and uncovering new approaches. The network's abundance of inspiring and critical voices has unquestionably enhanced the project's quality and refined our work, while admittedly adding challenges and complexities.

Q *How do you see the network contributing to the evolution of sustainable architectural practices?*

A Having a PhD within the company means that we now have research validated by a third party, making it legitimate research that cannot be dismissed as manipulated marketing. Furthermore, we gain access to potent networks comprising highly skilled and talented individuals across sectors, which sharpens our focus on the research, knowledge, networking, and profiling that we aim to pursue in the future.

Q *What benefits do you see in cultivating collaborations across academia and industry for projects of this nature?*

A Cultivating collaborations between academia and industry is crucial for breaking down barriers and driving sustainable development across the building industry's value chain. While the benefit is significant, these partnerships have their complexities. Interdisciplinary cooperation only solves problems if the circle of stakeholders is wide enough. We must be more aware of the delicate interconnectedness of everything and our critical blind spots within the value chain of the building industry.

Q *Isn't that the essence of what the CBEN network aims to achieve – breaking down silos and exchanging knowledge to eliminate blind spots?*

A Yes, and that is indeed very valuable. One of the key learnings gained over the last three years is the need for an even more extensive network of stakeholders. For the industry to truly embrace the green transition, it is essential to have voices with an integrated understanding of resources, cycles, and the intricacies of ecosystems. We must establish partnerships with bio-scientists such as ecologists, geologists, biologists, and builders. Some may be more loosely associated with the network, serving as critical 'chains of knowledge.' Through such collaborations, we can avoid being confined to isolated circles and break free from counterproductive habits.

Q *How do you foresee the project contributing to the broader goals of transforming the building industry?*

A An accumulation of knowledge is like a seed – it can initiate a movement on a longer-term basis. I'm not entirely sure if one project alone can bring about an immediate impact. The effects may only become apparent a few years from now. Nevertheless, I firmly believe that research has the power to move mountains, but it takes time.

Q *Does this collaboration model hold potential for broader adoption in the research community?*

A While there is great potential, the timelines of the industry clash with the timeframe of PhD projects, which is limited to three years. Even so, our research experiences are enriched by engaging with a more complex reality characterized by rapid progress and instant change. Working with external partners breaks down the traditional research approach that tends to navigate in relatively closed circles. We need slow-paced basic research, which can lay the groundwork for significant changes over time, but we also need fast-paced applied research that can move and solve issues in the short term, which also forces us to keep up the pace.

Q *What advice would you give to other research institutions and advisers pursuing similar projects?*

A Seek out robust partnerships with those genuinely committed to making a meaningful impact, not just for themselves, but for the benefit of the climate, nature, people, and ecosystems. Look for partners who go beyond traditional industry perspectives, such as those who advocate for nature – geologists, ecologists, and biologists. Stakeholders with a bio-scientific approach can provide valuable insights into the entire value chain. In our eagerness to address issues, we mustn't repeat mistakes from the past by forgetting to adopt a holistic approach.

Professor and Head of Research at Aarhus School of Architecture, Thomas Bo Jensen is the adviser for industrial PhD Heidi Merrild who is working on the project "Sustainable Tectonic – Durability, Materials, and Building Culture in Reversible Architecture" as part of the Circular Built Environment Network. The project is being conducted in collaboration with Friis & Moltke A/S, Housing Association Ringgården, University of Southern Denmark, SDU Create, and Aarhus School of Architecture.

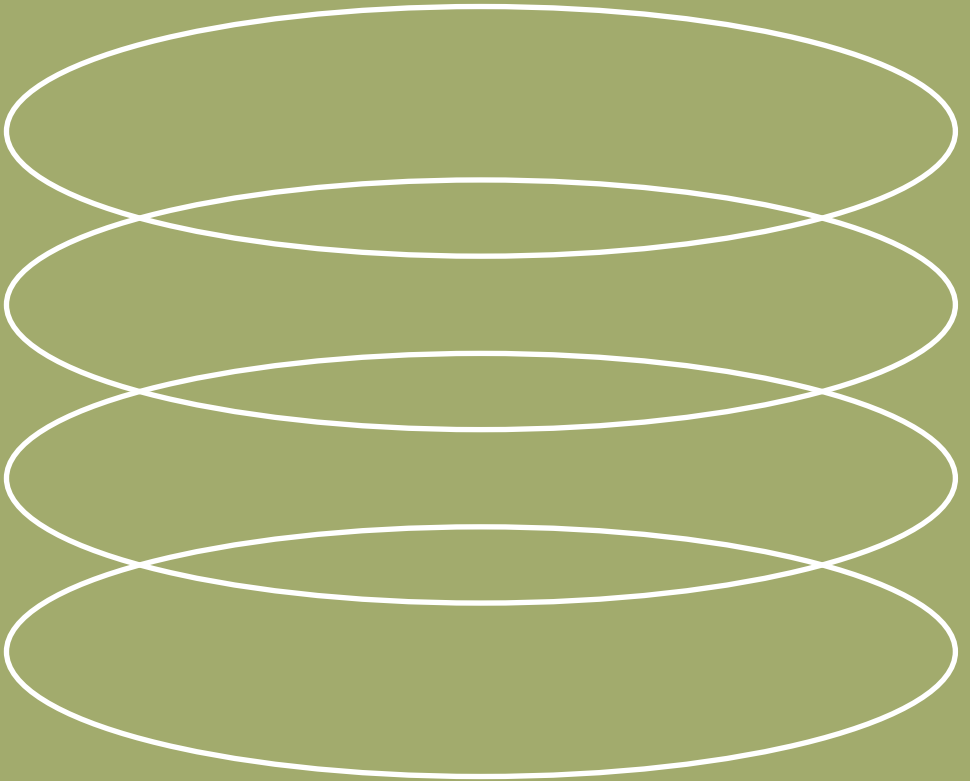

MATERIALS &
ENERGY

12345

CBEN Denmark

The fallacy of misplaced circularity

Text by
Kiel Moe

Circular building, in its most superficial and simple connotation of recurring buildings and building components, is a welcoming and necessary evolution of modern building culture. But the ease of discussing the concept often belies the non-simple reality of integrating recurrence into building culture. Specifically, no building process is linear and thus no building process can be bent neatly to form a circle. Perhaps counterintuitively, the very complexity of that nonlinearity is construction's greatest (latent) ecological asset.

Circular building helps train a generation of designers, engineers, and builders to unlearn a highly linear meta-diagram of modern metabolisms: extract → process → use → abuse → discard. One of the paradigmatic, and most problematic, concepts of modernity – waste – is only possible in the linear framing of this catastrophe. Circular building intends to make that line circular. But this narrow effort misses, or misplaces, important ecological and social opportunities. While some buildings or building components might cycle back directly into construction, such components should not be fetishized at the expense of the larger ecology of a building project. In other words, circular building leads us to relearn the immense role of feedback. If recent decades of putative “sustainable design” errantly obsessed over varied efficiencies in the (linear) material and energy flows of late modern building, then circular building is finally internalizing what sustainability externalized: the highly consequential role material, energy, and information feeding back into any ecological system. Modern systems were never ecological, nor could they be, due to their methodological disregard for the role of feedback.

Circular building, though, tends to limit its feedback purview to redirecting material flows back into building stock. While this may be one powerful paradigm for building in the decades ahead, it is not the only form of feedback to keep in mind. The broader construction ecology of any project is inherently larger, and more ecologically and socially complex, than that conception allows for. So, the full ecology must first be mapped, and its social and political relations grasped, before sound material, energetic, and informational designs for a building's inputs, throughputs, outputs, and feedbacks can be discerned.

Circular building would therefore benefit from adding the approaches of ecosystem science to its methods and design procedures. Tools from ecosystem science, such as Howard T. Odum's emergy method, offer the most complete guide on how to map material and energetic flows in a physical system. That map of physical flows and relations, in turn, becomes the basis of important forms of social and political analysis concerning unequal ecological and economic exchanges, environmental load displacements, and forms of underdevelopment, that accompany modern building projects. Despite its name, life cycle analysis does not offer this broader, necessary perspective, as it suffers from chronic system boundary definition problems. Only ecosystem science methods begin with the biogeophysical work of the planet, which is the basis of every building, its operation, and future uses. To methodologically disregard the biogeophysical work of the planet uncouples building from the life of the planet and is thus a grave error that perpetuates the problems of modern building practices.

The rich and vital complexity of construction ecology is not merely a way to more cogently describe the dynamics of building, but indeed it is one of our best models for how we might more generally think about the cycling of energy, matter, carbon, and water on this planet through architecture. To occlude this complexity and its lessons from architecture imperils the obligations and opportunities of building in this century. Circular building is swerving architects, engineers, and builders in the direction of less linear futures for building; however, it could extend its purview and adopt the full ecological horizon of the biogeophysical basis of building. Then, cycles, rather, circles, will become, at long last, the metier of

designers and builders and thus finally establish an ecological future for building.

REFERENCES:

I offered an interpretation of Odum's methods for architects in Kiel Moe, *Convergence: Architectural Agenda for Energy*. London: Routledge, 2013; and a primer: Ravi S. Srinivasan and Kiel Moe, *The Hierarchy of Energy in Architecture: Emergy Analysis*. London: Routledge, 2015.

Maximizing the reuse of wood in construction

AUTHORS

Olga Popovic Larsen ^{1,2}

Lisbeth M. Ottosen ²

Xan Browne ^{1,3}

ORGANIZATIONS

⁽¹⁾ Royal Danish Academy

⁽²⁾ Technical University of Denmark (DTU)

⁽³⁾ Lendager Arkitekter ApS

The climate emergency calls for urgent measures to minimize the harmful effects of the building sector. Where possible, reducing high-impact materials and building with wood and other bio-based materials help reduce harmful emissions and the use of mineral-based materials while increasing carbon sequestration. As a result, the interest in using bio-based materials, and especially wood, in construction has increased. Wood is a renewable material with high strength to weight ratio that has been utilized since ancient times, including in many global indigenous building cultures.

However, increasing the use of wood in construction is challenging because a dramatic rise in timber construction would lead to a global timber shortage. This calls for building better with timber and elevating reclaimed wood to use in construction wherever possible.

Over the last few years, the Royal Danish Academy has been experimenting with several projects that investigate the design potential for reclaimed wood, focusing specifically on loadbearing applications. *Nordic Waste Wood for Good* (Larsen O.P, Browne X., 2022) examined how different wood waste streams can be utilized for creating façade elements. Developed through a series of hands-on workshops in the Nordic countries, the project's main aim was to present the potential for the reuse of materials generally discarded as waste. Over 200 participants from Sweden, Finland, and Denmark showcased versatile designs and opportunities for further use of different wood waste streams.

The current collaborative efforts between DTU and the Royal Danish Academy focus on how to facilitate the structural use of reclaimed wood. Currently, due to premature demolition and the discarding of wood deemed unfit for

construction, there are large quantities of material coming from different timber waste streams that offer opportunities to utilize wood otherwise considered scrap. For example, in Europe, 16Mt of construction and demolition wood waste is produced annually (Vis M, et al. 2016).

Wood is an anisotropic material and building timber structures with reclaimed wood is a complex and challenging process. Using reclaimed wood requires determining its properties and ensuring structural safety. StructuralReuse researchers at DTU, as part of the Grand Solution project, investigated different non-destructive test (NDT) methods for the classification of structural wood for reuse. Preliminary results of the NDTs have shown that the variations in properties over the length of the timber can be captured by these tests, leading to a highly specified definition of strength classes. Since the lowest grade of timber determines its overall classification, segmenting the timber into smaller units based on the classification enables the use of every specimen at the highest level in structures such as gridshells.

Waste Wood Canopy (Browne X, Larsen O.P, Castriotto, C. 2021) was a full-scale demonstrator evaluating the viability of using discarded wood for loadbearing structures at an architectural scale. A full-scale prototype was developed and constructed from short elements utilizing Reciprocal Frame (RF) principles in a small timber gridshell structure. The short-offset RF timber members were joined using a timber clamp connection developed for the project that reduced the number of steel connections. The project also explored aspects of robustness through structural redundancy and optimization of structural behavior, buildability, and overall architecture.

A current PhD project investigates the potential use of reclaimed wood for construction, where the wood's defects provide design agency. The main research focus is on exploring new approaches to architecture that hold the capacity to offer undervalued timber a longer life. By building on wood's existing material culture, the project formalizes new concepts through the realization and evaluation of prototypes.

The effort included the development and construction of *Wood ReFramed*, a full-scale pavilion designed as a series of portal frames made up of trusses, which was constructed

for the UIA World Congress of Architects in 2023. The structural frames incorporated the same architectural language, yet integrated a variety of tones and geometries, with the pavilion frames' structural capacity demonstrated by a hanging amphitheatre.

Through a combination of *research by design* (qualitative) and positivistic (quantitative) methods, the study proposes new circular approaches for implementing waste wood in building design. (Browne X. , Larsen O.P., 2022)

Though challenging, through collaboration we can find ways to maximize the reuse of wood in construction. The innovation of using NDTs to classify the variability in timber properties across its length allows it to be segmented into smaller units based on their most favorable properties. The gridshell structure can then be designed and optimized to use the strongest pieces where needed. This approach enables us to fully realize the potential of the timber we have.

REFERENCES:

Vis M., U. Mantau, B. Allen (Eds.) (2016) Study on the optimised cascading use of wood. No 394/PP/ENT/RCH/14/7689. Final report. Brussels 2016. I

Larsen O.P., Browne X. (Eds) (2022) Nordic Waste Wood for Good, Royal Danish Academy: Architecture, Design, Conservation.

Larsen O.P, Browne, X. & Castriotto, C., (2021), Utilising waste wood through reciprocal frame systems, IASS annual Symposium and Spatial Structures Conference 2021: Inspiring the next generation.

Browne X, Larsen O.P (2022), Motivating the architectural application of waste wood, Architecture, Structures and Construction.

Supporting circular and sustainable decision-making in the construction sector through digital innovation

AUTHORS

Thomas Fabian Delman

Lene Damsbo Brix

Viktorija Klansø

Robert Haff-Jensen

ORGANIZATIONS

Circue

THE CHALLENGE

The construction sector is inherently resource-intensive, consuming large quantities of raw materials, energy, and water. It generates significant waste and has a substantial environmental impact, contributing to greenhouse gas emissions, air and water pollution, and habitat destruction. As global awareness of environmental issues and resource scarcity grows, it is imperative to adopt circular and sustainable practices within the construction sector.

Circular economy principles emphasize the reduction, reuse, recycling, and regeneration of materials and products. In the construction sector, this translates into minimizing waste, extending the lifespan of buildings and infrastructure, as well as integrating new practices such as design-for-disassembly and adaptability and circular materials innovation, e.g. biogenic materials.

THE TWIN TRANSITION OF THE CONSTRUCTION SECTOR

The construction sector is one of the least digitalised sectors and also highly fragmented, with almost 97% of all European construction companies employing fewer than 20 people. Also, the construction sector has relatively low profit margins and a very high risk aversion, which means that incentives to experiment and implement new, innovative practices are

extremely low.

In recent years, several Danish and European projects have addressed circularity in the construction sector from various perspectives, providing new knowledge, best practice cases, and a host of reports and publications on everything from design optimisation to materials tracking and predictive urban mining. The challenge is that in a fragmented and risk averse value chain, knowledge is not sufficiently disseminated and new practices are not effectively implemented.

To overcome these inherent barriers and challenges and support a twin transition towards more sustainable and circular practices we need to develop and utilise digital tools, providing low-cost, in-time, multi-criteria decision-support towards all actors in the value chain.

THE CIRCUE-PLATFORM

Since 2021 a group of professionals from various parts of the Danish construction industry have worked together to create an integrated, scalable and cost-effective circular value chain able to compete with the linear construction practice on market terms by solving the existing research and market challenges. The goal of the project is to launch a digital platform, which aims to become the circular construction sector's main collaboration hub. The Circue-platform offers several innovative tools such as:

- **Automated resource mapping:** Using open data combined with in-depth analysis of historical building typologies, the platform is able to provide automated resource mapping with a detailed analysis of embedded materials and embodied carbon, allowing for early-stage decision-support aimed at building owners' investment processes.
- **Digital building & material data bank:** Allowing building owners to store, enrich and exchange data related to materials, buildings and entire building portfolio with other stakeholders in the value chain, e.g. demolition companies, architects, engineers, facility management, contractors, marketplaces for secondary materials etc.

- Market exchange for secondary materials: Providing overview of and transparency for secondary materials embedded in existing buildings scheduled for demolition or already on existing marketplaces allowing for fast and efficient reuse of secondary materials in new construction.
- Integration with digital design tools: Seamless integration of secondary materials from the market exchange into design tools such as Revit, providing architects and engineers with the ability to design with secondary materials and receiving immediate feedback on their design choices related to circularity and sustainability frameworks.

The platform is centered around the notion of a seamless data-flow through the entire value chain based on standardised data formats (e.g. material passports), and supports decision-making for every actor in the chain by guiding them towards the next, most circular or sustainable decision based on a zone-of-proximal-development approach.

VALUE CHAIN COLLABORATION

The circular construction sector is an emerging market and while some sees it as a competitive space many others are looking at circular construction as a chance to enter into new partnerships, driven by the possibility of a necessary societal and environmental impact rather than personal or corporate financial gain. This also means that there is a general openness towards collaboration across traditional disciplinary boundaries, creating new, integrated design processes, circular business models, and public-private partnerships.

While many actors in the construction sector are still hesitant to adopt new practices, front-runners are beginning to push for a fast transition, realising that circular and sustainable decision-making is paramount for the construction sector to reduce its environmental footprint and resource consumption.

Digital solutions play a vital role in supporting this transition, enabling more informed and sustainable choic-

es throughout the construction process. While challenges exist, the long-term benefits, including cost savings and environmental benefits, make digital solutions a worthwhile investment in transforming the construction sector into a more sustainable and circular industry. Collaboration among stakeholders and ongoing education and training are essential to ensure the successful integration of digital solutions and to drive the construction sector towards a more sustainable future.

Towards a multi-scalar approach to circular economy

AUTHORS

Simon Sjökvist ^{1,2}

Olga Popovic Larsen ²

Xan Browne ^{2,3}

ORGANIZATIONS

⁽¹⁾ Cobe

⁽²⁾ Royal Danish Academy

⁽²⁾ Lendager Arkitekter ApS

To ensure a sustainable transition within planetary boundaries, a radical shift in how we plan and design our buildings and cities is necessary. Currently, there is a growing awareness of the environmental impacts associated with natural resources, building materials, and construction processes. These impacts include the substantial and increasing share of embodied energy in relation to a building's overall environmental footprint, the depletion of finite resources, and the generation of waste.

In response to these challenges, the adoption of circular economy principles appears to be inevitable. The traditional linear approach of take-make-use-dispose is no longer viable if we intend to stay within the absolute boundaries of our environment. Instead, we must replace it with principles focused on reducing, reusing, and recycling. Simultaneously, it is evident that a more qualified and nuanced discussion of circular economy principles is necessary, moving beyond simplistic notions that have sometimes shaped the discourse in the past, proving unrealistic in terms of large-scale implementation or with little actual impact in a broader sustainability transition.

If we are genuinely committed to implementing circular economy principles, we need to think across scales—materials, components, buildings, districts, and cities. Particularly, we must consider how the urban scale ties in with all the other scales. Such a multiscale approach will have implications on many levels – technical, quantifiable, and operational.

RECLAIMED WOOD AS EXAMPLE

Taking reclaimed wood as an example, we can explore how this multiscale approach unfolds and reveals potentials and barriers at different levels. Wood, considered the building material of the future, already holds several environmental advantages over current alternatives. While inherently renewable, *reclaimed wood* amplifies these benefits by reducing deforestation, lowering energy requirements for processing, and bypassing end-of-life stage emissions. The minimal negative environmental impacts associated with reclaimed wood create strong incentives for its increased use and adaptation.

At the *building scale*, reclaimed wood has advantages in durability and similar material properties to virgin wood. The assembly of wood allows straightforward disassembly, setting it apart from some other materials. However, challenges emerge in functionality, assembly, and construction, as reclaimed wood often comes in smaller pieces impractical for larger spans, necessitating novel and potentially costly assembly methods. Also, remains of contaminants as nails or metal plates, screws etc. can pose challenges for direct re-use. A further requirement is a having a comprehensive understanding about the wood properties of the reclaimed wood (strength, origin, state, etc.)

Zooming out to the urban scale, reclaimed wood presents environmental potentials by offsetting the demand for virgin wood, curbing deforestation, and preserving land use and biosphere integrity. Simultaneously, there are also barriers, particularly in the availability of reclaimed wood. Primarily sourced from demolition, a study in Denmark indicates that material from demolitions could, at best, cater to a fraction of the materials needed for new buildings, given the surplus in construction rates over demolition. Additionally, most demolished buildings from earlier decades contain minimal wood.

At the national scale, lack of supportive policies or regulations can impede widespread adoption of reclaimed wood. Infrastructure considerations for sourcing, processing, and distributing reclaimed wood materials are crucial.

NEW COLLABORATIONS ACROSS SCALES AND DISCIPLINES

While the discussion above does not offer a comprehensive review of all the complexities tied to reclaimed wood, it serves as an illustration of various aspects and considerations at different scales.

A comprehensive understanding of these elements, intrinsically interconnected within complex networks and systems, can hopefully contribute to a better and more nuanced understanding of the scope and potential of individual circular economy technologies and solutions in a wider sustainable transition of the construction industries.

This multiscale approach will also impact how we design our buildings and cities. The circular economy potential at the urban scale shapes the design and construction of individual buildings. Simultaneously, the technologies employed in individual buildings can reciprocally influence urban planning practices and even have implications for national legislation.

Given that these scales are generally overseen by different disciplines, such a multi-scalar approach will require more collaboration between various disciplines—e.g., architecture, construction, planning and engineering—across practice, policy and research. While challenging, integrating knowledge and expertise from these different areas is crucial if we are serious about implementing circular economy principles broadly. Such collaborations can also pave the way for new synergistic ways of working and partnerships. Additionally, these collaborations can open up new possibilities for interdisciplinary research.

Needless to say, this call for new collaborations across scales and disciplines extends beyond just reclaimed wood; it applies to all materials and construction practices.

Architecture and (waste) wood: Revaluing discarded timber for use in structural applications

PROJECT

Industrial PhD

AUTHOR

Xan Browne

ORGANIZATIONS

Lendager Arkitekter ApS

Royal Danish Academy

The climate crisis has propelled the building sector into evaluating its environmental impact and to question the destructive modes of material extraction that have accelerated over the last century. During this period of increased awareness, new theories have emerged that rethink how the material world can be organized to be less harmful, more effective, and even regenerative. With a focus on timber construction, this project situates architecture within the biomass cascading framework, investigating how buildings can extend the lifetime of wood.

The emphasis is on material lifetimes rather than product lifetimes, motivated by issues surrounding the ecological limit of forests and the potential benefits of long-term carbon storage. The research aims to develop design strategies for retaining timber in its solid form in load-bearing applications. Through more specific dialogue between material streams and timber structures, the strategies contribute outcomes that offer effective utilization of timber and new aesthetics that embody the past intersections of material and environment.

Waste wood's value is currently compromised by its material traits. 'Defects', such as nails, screws, and treatments, as well as short lengths, wane, cupping, and bowing, create practical challenges for current production processes, leading to significant material losses and the rejection of waste wood in recent research (Husgafvel et al., 2018; Risse



et al., 2019; Rose et al., 2018). Furthermore, the incineration of reclaimed wood remains a major contributor to the EU's energy balance, resulting in a material that's undervalued in one sector, but highly valued in another, further hindering the case for reclaimed timber.

In an effort to see 'defects' as enablers rather than inhibitors, design strategies must integrate the specificity of used materials within new components. The research evolves over a sequence of prototypes, each conceived and then evaluated from qualitative or quantitative perspectives. The prototypes maintain a common strategy for incorporating a broad variety of material properties and qualities within existing component typologies.

Beams, columns, and slabs are well established construction components across the globe. Working within these taxonomies enables new types of components to interface with existing building geometries, stakeholder relations, and design methodologies. Successful biomass cascading relies on more than material flow, and must examine the complex provenance that has formed post-consumer



Beam prototype developed during 'Making a Beam Social' - a workshop at Central Saint Martins

material. The traits that emerge from interactions between artifact and environment are core components during design development. A negotiation between these multiple agencies fosters a distributed authorship, challenging traditional notions of human-centric design.

During the project, the developed prototypes have evolved to express wood's ephemerality, poised between its distant origin and intended longevity. The sociological and technological contexts the prototypes are fabricated in are equally important, contributing to a methodology that carries through from a small beam to a pavilion project, the latter demonstrating that undervalued timber material is capable of meeting the functional demands of full-scale buildings.



'Wood ReFramed' pavilion demonstrating the load-bearing potential of reclaimed timber, exhibited during UIA2023



Circue

PROJECT

Grand Solution,
Circue

AUTHORS

Lene Damsbo Brix
Thomas Fabian Delman
Viktoria Klansø
Robert Haff Jensen

ORGANIZATIONS

Circue

In recent years, innovation in circular construction and small-scale experiments have provided us with a glimpse of a more sustainable future within the industry. Political agreements on new policies and guidelines for ecologically-sound construction reflect a recognition of the need for alternatives to current practices. However, it is still more efficient, cheaper, and faster to build using a traditional linear approach, which is a major systemic challenge for the circular transition. That's why we've launched the Circue project. We want to create an integrated, scalable, and cost-effective circular value chain able to compete with more exploitative practices on market terms by solving existing research and financial challenges.

Through the development of a digital platform, Circue seeks to become the circular construction sector's main collaboration hub, as well as knowledge and data repository for secondary building materials. The platform will provide the value chain with digital tools, including for estimation of materials and CO2 embedded in existing buildings, a building and materials bank, an exchange for circular materials, and circular decision support.

We work with data at the core, operationalizing circularity by supporting data flow and exchange across the value chain to increase transparency, reduce risk, and promote active collaboration among diverse stakeholders. We have built, and are continuously improving, a digital framework for the collection, organization, and enhancement of data on existing Danish buildings. Our current building stock model is based on open data and a bottom-up analysis of multi-story housing from 1850-2000. The model aims to provide decision support for professional building owners in order to promote preservation and reduce waste in the context of possible end-of-life scenarios that consider multiple parameters including environmental, resource, and market

value information. We are currently developing both a digital framework for a dynamic lifecycle assessment model and a dynamic digital passport for secondary building materials. We have also built prototypes for a resource-mapping application and a Revit plug-in for designing with secondary materials from our market exchange. We collaborate closely with value chain actors, public institutions, research projects, and organizations within the construction sector to inform our work and disseminate results.

The Circue Grand Solution Project is a joint effort across a consortium of knowledge, commercial, and market partners, including: Tredje Natur, Matter bybrix, J. Jensen A/S, HD Lab, twentyfifty futures, Circue, the Danish Technological Institute, Syddansk Universitet (the University of Southern Denmark), Roskilde Municipality, Middelfart Municipality, Danica Real Estate, and Lejerbo. The project is financed by Innovation Fund Denmark and Realdania.



PRESCREENING ONBOARDING



ENVIRONMENTAL + RESSOURCE MAPPING



QUALITY TEST OF MATERIALS



SELECTIVE DEMOLITION DISASSEMBLY



SORTING PREPARATION



TRANSPORTATION



CLEANING



PROCESSING STORAGE



MARKETPLACES



DESIGN + CONSTRUCTION DOCUMENTATION



TRANSPORTATION



CONSTRUCTION + INSTALLATION



OPERATION + MAINTENANCE

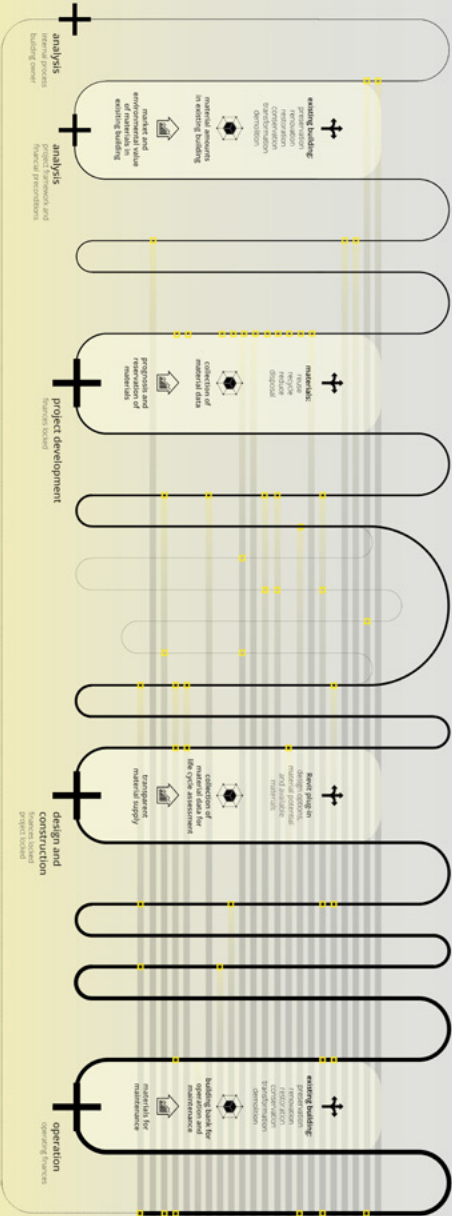

material and building bank



material exchange



decision support

circue

Enabling reuse of structural components through documentation of quality

PROJECT

Grand Solution,
Structural Reuse

AUTHORS

Lisbeth M. Ottosen ¹

Karoline Fogh
Gustafsson ²

ORGANIZATIONS

⁽¹⁾ Technical University
of Denmark (DTU)

⁽²⁾ Lendager Arkitekter
ApS

The reuse of building components, and especially the basic components of a building structure, (walls, beams, columns, etc.), is almost non-existent today, but needs to be scaled up to fully implement circular principles. In addition, the potential reuse of structural components represents a significant environmental benefit as the structural frame alone can account for up to 80% of the embodied carbon in a building¹. The lack of systems for standards, certification, and documentation is a barrier to the reuse of structural components and creates a significant burden in terms of paperwork and economic risk for owners who choose these components for a building.

The objective of the Structural Reuse project is to overcome this barrier by developing much-needed systems and methods to make the choice between second-life building components and new components equivalent. To fulfill the purpose, the project has four specific aims, to: (I) develop and standardize a requirements classification system for reuse of concrete, wood, and steel components; (II) develop and standardize non-destructive tests (NDT) for documentation of the technical quality of components; (III) provide know-how and data for inclusion of NDT methods in technical guidelines in the Joint Technical Property; and (IV) perform three full-scale tests as a baseline for developing a methodology to quantify the environmental impact from reuse options.

The existing requirements for materials and components have been mapped as part of systematizing how they

can be applied to reused components within acceptable risk thresholds². The requirements are grouped into legislative requirements at the product level, standard terms for processes, Joint Technical Property, and voluntary arrangements. In parallel, a classification framework has been developed for the reuse of structural elements based on pre-assessment (element history and in-situ condition), functional requirements and parameters, and a categorization based on structural, environmental, and dimensional parameters². A classification for concrete has already been developed³, while one for steel is ongoing at the CEN level. For timber, the work is underway and is combined with a parallel industrial PhD project on fire properties of reused timber⁴.

The use of NDT methods for evaluating other potential purposes within structural elements has been mapped both in the scientific literature and the methods used by practitioners with widely-available equipment (these mappings are currently pending publication). The first in-situ pilot-scale tests with ultrasound pulse velocity and Schmidt hammers on concrete columns have been performed. These tests, together with other ongoing and planned pilot-scale tests, will form the foundation for a detailed description of procedures for in-situ documentation and data treatment to determine actual concrete strength classes. These procedures will then be developed into guidelines and further analyzed in full-scale tests which will be performed before the project's conclusion.

CURRENT PROCESS

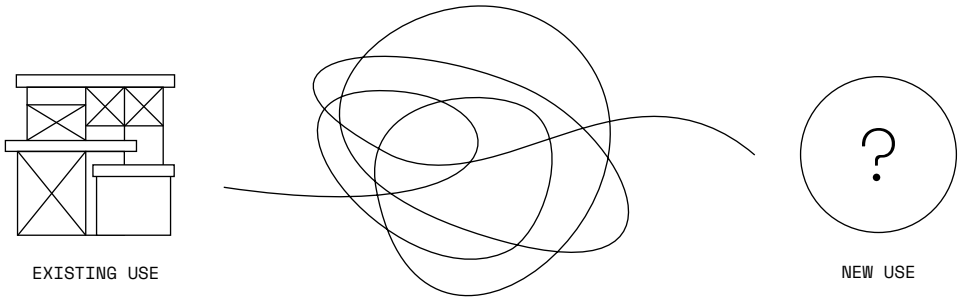

THE FUTURE PROCESS

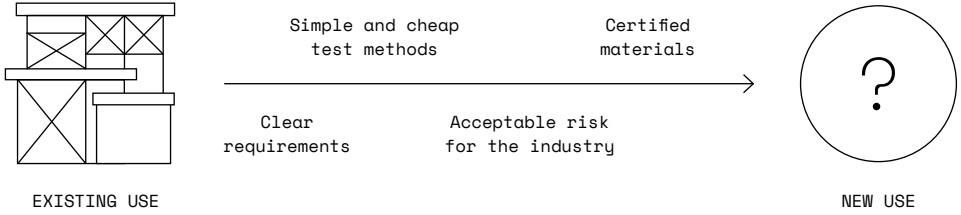

REFERENCES:

⁽¹⁾ **Seunghyun son** , kwangheon park, heni fitriani, and sunkuk kim, 20. January 2021
<https://www.Mdpi.Com/2071-1050/13/3/1060/htm>

⁽²⁾ **Structuralreuse midway conference publication (2023)** https://data.Dtu.Dk/articles/online_resource/structuralr

⁽³⁾ [Euse_midway_conference_publication/23043551](https://data.Dtu.Dk/articles/online_resource/structuralr)

⁽⁴⁾ **Fire performance assessment methodology** to ensure second life potential of reused load bearing timber elements – welcome to dtu research database

Extending the use of supplementary cementitious materials in concrete

PROJECT

Industrial PhD

AUTHOR

Maxime Ranger

ORGANIZATION

The Danish Road
Directorate

Technical University
of Denmark (DTU)

Concrete is the most used construction material in the world, and its production accounts for about 8% of human-generated CO₂ emissions. In conventional concrete, the binder is Portland cement, which has the largest CO₂ contribution of all constituents. To improve the properties of concrete and reduce its carbon footprint, Portland cement can be partially replaced by Supplementary Cementitious Materials (SCMs), such as coal fly ash, blast furnace slag, or silica fume. These traditional SCMs are industrial by-products and their use in concrete promotes circularity and reduces waste. However, due to the overall decarbonization of the industry, their availability is expected to decrease in the coming years. The concrete industry is therefore looking into alternative SCMs, which can ideally substitute even more Portland cement than traditional SCMs. In this respect, it is essential to evaluate the effect of SCMs on concrete durability, i.e. ensuring that concrete will remain in sufficiently good condition over the service life of a structure – typically 100–120 years for bridges.

This PhD project focused on the impact of SCMs on a particular durability damage mechanism called alkali-silica reaction. From an industry perspective, the project proposed a procedure to assess SCMs with respect to the alkali-silica reaction. In other words, which criteria should an SCM fulfil to ensure its safe use in concrete? To find out which criteria to evaluate and which level to set the project mainly relied on an experimental approach. Various laboratory tests were performed on eight reference SCMs, as shown in Figure 1, which aimed to provide a representative sample of sources.

Figure 1:

Supplementary Cementitious Materials (SCMs) powders selected for testing in this PhD project. The selection intended to represent a range of potential SCMs in terms of origin, chemical composition, and physical properties.



Coal fly ash
FA



Sewage sludge ash
SSA



Crushed brick
CB



Glass beads
GB



Biomass ashes
BA



Calcined clays
CC



Figure 2:

Concrete field exposure site at the Technical University of Denmark, initiated in 2017. 90 cubes are exposed and monitored to study the effects of concrete composition on the alkali-silica reaction. Small stainless-steel pins are placed at the surface of the cubes to measure their length change.



The experimental program included tests at different scales, from SCM powders to concrete. As for assessing durability issues, laboratory tests were conducted to accelerate chemical reactions so it was possible to evaluate the effect of SCMs within a reasonable time frame. A field exposure study was also initiated to determine the validity of the accelerated tests. This consisted of placing concrete cubes on an outdoor field exposure site (see Figure 2) and monitoring the state of the cubes over time, then comparing the results with those from the accelerated tests.

The project led to the development of a procedure to screen and qualify cementitious materials. Special attention was paid to selecting or designing tests that can be performed in most laboratories, so they can be used by most industry stakeholders. So far, the outcome of this procedure matches well with the behavior of the concrete cubes, but long-term data are needed to confirm the initial trends. The final deliverable of the project will be a suggestion for the national regulations for concrete, to update the requirements for approving SCMs with respect to alkali-silica reaction.



Circular wax 3D printing for sustainable formwork in construction

PROJECT

Industrial PhD

AUTHOR

Nicolas Ramirez Ortiz

ORGANIZATIONS

Odico A/S

University of Southern
Denmark (SDU)

In the face of mounting pressure and the need to adopt sustainable practices, the construction industry is at a crossroads. Traditional formwork manufacturing methods have long hindered the achievement of both economic viability and environmental sustainability. To address these challenges, our research introduces wax 3D printing as a transformative approach for formwork fabrication.

The study conducts a comprehensive analysis of wax formwork, positioning it as both a sustainable and circular material. By introducing a novel additive manufacturing technique, the research aims to expand the range of possibilities in formwork production, offering a low-cost and zero-waste alternative. Through the development and meticulous optimization of 3D printing process parameters, the study has successfully improved the mechanical properties, surface finish, and overall quality of the 3D-printed formwork prototypes. Additionally, a Life Cycle Assessment study of the wax-based 3D printing method is currently underway to further evaluate its circularity and environmental impact.

Comparative analysis between 3D-printed and traditionally cast and milled formwork specimens is underway. This evaluation focuses on key performance indicators such as mechanical strength, elasticity, and dimensional accuracy. Preliminary results underscore the viability of wax 3D printing, and even suggest its superiority in certain respects over conventional methods.

The aim is to contribute to the advancement of additive manufacturing techniques in the construction sector.



Figure 1, 2, 3:
The top figure showcases the surface of a 3D printed wax formwork prototype. The bottom left image displays a formwork mold designed for a column. The bottom right image features the cast column alongside the leftover wax that can be reused. These images collectively highlight the innovative aspects of wax 3D printing, including its advantages in material usage, waste reduction, and sustainability (Photo: Nicolas Ramirez Ortiz and Peter Balle).

↑ Figure 1

Figure 3 ↓



↑ Figure 2





Figure 4:

This figure presents before-and-after pictures of a test cylinder, measuring 160 mm in height with a wall thickness of 8 mm. This showcases the transformation in surface quality due to optimized 3D printing parameters. (Photo: Nicolas Ramirez Ortiz).

Wax offers practical benefits for architects, engineers, and construction professionals seeking circular materials for formwork solutions.

This new approach could change how we create formwork and shows how using new technologies like additive manufacturing can make construction more sustainable and efficient.

REFERENCES:

⁽³⁾ **8 Billion Trees. November, 2023.** "Carbon Footprint of Construction Materials." 8 Billion Trees. URL <https://8billiontrees.com/carbon-offsets-credits/carbon-footprint-of-building-materials/>

A modifiable and optimized structural system for circular use of buildings made of precast concrete

PROJECT

Industrial PhD

AUTHOR

Sara Sofie Vestergaard

ORGANIZATIONS

Rambøll Danmark A/S

Technical University
of Denmark (DTU)

Heidelberg Materials
Precast Denmark

Rambøll Foundation

Concrete is a widely used material in the building industry. In Denmark, precast concrete elements are commonly used for building structures. The tradition of precast concrete structures started in the 1950s, when industrialization and standardization of production methods were prominent. Since then, the production and construction of precast concrete structures for buildings has developed into an efficient industry with a skilled labor force and a wealth of accumulated knowledge. Furthermore, concrete has some beneficial material properties and performs well within technical requirements like durability, acoustic insulation, fire safety, and heat accumulation. For those reasons, concrete is often chosen as a material for structures in the tradition-driven construction industry.

However, concrete is also known as a material with high environmental impact, primarily due to the content of cement. With an urgent need to reduce greenhouse gas emissions, the building industry needs to rethink its construction methods to limit the use of concrete and implement a circular construction philosophy.

Precast concrete structures often consist of concrete walls, which serve multiple functions, from load-bearing, to room separations, sound isolation, and fire protection. Traditional concrete walls are often designed in a structurally inefficient manner, and they are not very flexible with respect to future building modifications.

In this project, we will delve into the limitations of a tradition-driven industry and rethink structural design to fit current well-known construction methods with the hope of developing a new and scalable approach that reduces material usage in the present and supports adaptable use of buildings in the future.

To this end, we have developed a new concept – precast modifiable concrete walls. The modifiable concrete walls are prepared for multiple future modification scenarios, such as merging adjacent apartments, transformation from housing to office space, or many other types of alterations or renovations which require new holes or door openings in existing concrete walls.

The modifiable concrete walls are designed with two zones: a stronger frame zone, and a flexible zone that can be removed in the future with no or little need to strengthen the structure. Furthermore, the structural design of the wall is optimized by use of computational methods to minimize the CO2 footprint.

Figure 1:

Illustration of the concept.

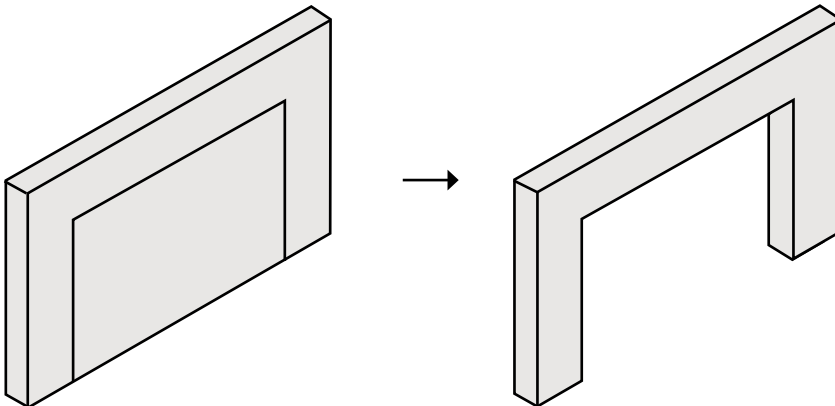

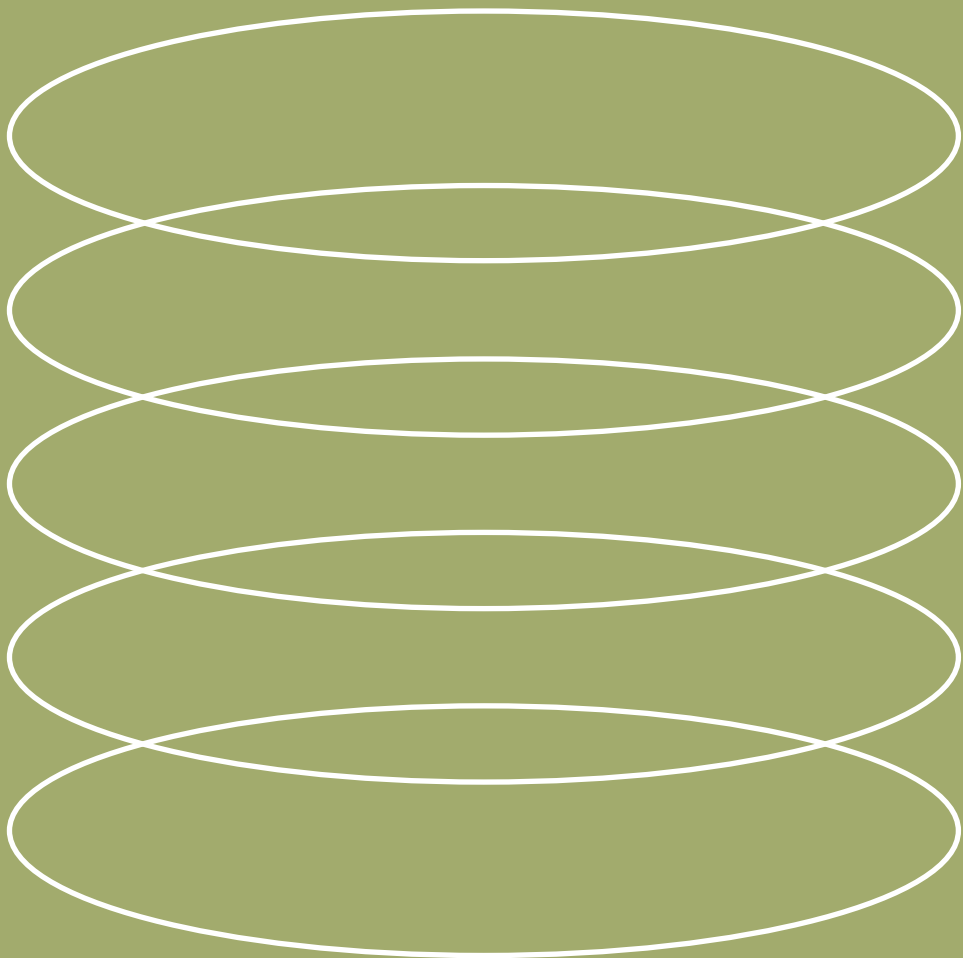

Figure 2:

A full scale modifiable wall element that is ready for testing.

Current analyses indicates, that there are potential CO₂ savings in the range of 25 - 50% compared to a standard concrete wall, depending on specific conditions. A large part of the savings comes from using a very low strength concrete in the flexible zone, which reduces the amount of cement in the concrete mixture. However, the designs need to undergo further analysis throughout the project before practical application.

To develop solutions that can be produced with the quality required for practical application and commercialization, the production is tested at a concrete element factory. Furthermore, experimental tests of the wall elements are conducted to verify the analytical results.



WHERE DO WE GO
FROM HERE?

12345



Transformative reflections: CBEN's journey in revolutionizing construction

In an exclusive interview, Realdania's project chief, Simon Kofod-Svendsen, and the Vice President of the Danish Innovation Fund, Ole Sinkjær, delve into the details of a three-year journey, illustrating how research plays a pivotal role in reshaping the construction landscape.

Amidst the pressing challenges of climate crises and resource constraints, Realdania and Innovation Fund Denmark forged a transformative alliance with a joint vision of transforming the construction landscape through the Circular Built Environment Network. As the three-year journey of the pioneering network reaches its zenith, we sat down with project chief Simon Kofoed-Svendsen and Vice President Ole Sinkjær to reveal the intricacies of a collaboration poised to be a catalyst for change transcending conventional construction industry boundaries.

Simon Kofoed-Svendsen,
Project Chief, Realdania

Q *What motivated Realdania to co-sponsor the Circular Built Environment Network?*

A Two reasons drove that decision: Firstly, and generally, Realdania aims to spark a fundamental transformation in the construction industry, urging companies to see research as a crucial ally in overcoming substantial challenges ahead. We simply need more applied research related to the construction industry. The sector is way behind many other sectors. With the Circular Built Environment Network, we were able to support a whole cohort of companies in using research as an innovation tool.

Secondly and more specifically, we saw a need to boost research about circular economy if this way of thinking is to fulfill its potential. The ambition was to create a network that goes beyond talk and can deliver commercially solid circular solutions. The Circular Built Environment Network became the concrete expression of this belief, actively turning vision into reality.

Q *What is unique about your approach?*

A Our strategy combines traditional industrial research with an additional networking layer. Each participating company funds one industrial researcher, but gains access to 14 others – a win-win for everybody. Industrial researchers benefit from collaborative knowledge exchange, avoiding a solitary journey. Universities also tap into to a diverse pool of researchers, sparking new ideas. We've gone one step further in this network by including two Grand Solutions projects, essentially networks themselves, that contribute to a melting pot of innovative professional discussions.

Q *How do you foresee the Circular Built Environment Network driving the shift from the conventional construction industry to a circular resource economy?*

A Transformations occur as individuals evolve. Over the past three years, approximately one hundred individuals have been part of the network, serving as catalysts for change. Engaging in conversations and sharing project experiences has contributed to an expanding pool of knowledge, thereby also changing the participants themselves. More than the directly-involved network members, the first to be inspired and changed are the various businesses and organizations within the network. Secondly, all interested companies and actors in the construction industry are invited to share in the many learnings and findings, to inspire and perhaps change them. Hopefully, the broader collaboration can support this challenging but necessary shift.

Q *Based on the results you have seen thus far, what aspects of the network and their results have impressed you the most?*

A I particularly remember how engaged the industrial researchers were when the network kicked off, even when the COVID-19 pandemic's challenges had them working remotely behind screens. They fully grasped the concept and embraced the network mindset immediately. That impressed me. In the fall of 2023, they impressed me again when we had a three-day network symposium on Bornholm with around 30 participants, including industrial researchers, Grand Solutions representatives, and university and corporate advisors. The energy, dedica-

tion, and conversations during that event left me with a sense that there are individuals who both can and want to make a difference.

Q *Does Realdania plan to sponsor another network in 2024, and if so, can you provide insights into whether this initiative will have a different focus?*

A Yes. In fact, at the end of 2023, The Innovation Fund Denmark and Realdania decided to follow up CBEN with a new network in 2024. The new network will accept applications through The Innovation Fund in April, with the expectation of kicking off by the end of 2024. Building upon CBEN, the new network will focus on 'the regenerative'. The theme revolves around advancing a regenerative built environment. The need is to construct in ways that restore ecosystems and positively contribute to climate and human well-being.

Ole Sinkjær,
Vice President, The Innovation Fund Denmark

Q *Why did the Innovation Fund support the construction industry via the Circular Built Environment Network?*

A In selecting the network as a platform for supporting the construction industry, we affirmed our commitment to propelling research and innovation into the forefront of the green transformation. The critical role of the entire construction sector, with its significant environmental impact, underscores Denmark's imperative to cultivate visionary talents capable of innovating new solutions. This emphasizes the pressing need to bridge the gap between academic insights and practical, real-world applications within companies. The combination of the Industrial Researcher program and the Circular Built Environment Network is a vital instrument for nurturing talent and bridging the realms of academia and business.

Q *What do you see as the most significant benefits to participants in the network?*

A Feedback from researchers in the network indicates that it provides valuable support professionally and socially. Professionally, they gain more from their research because it can constantly be placed in the context of others' research, which helps to increase the breadth and impact of individual projects. Socially, the network serves as a platform for discussions about the experiences and challenges inherent in such educational trajectories. Challenges others in the network face may mirror one's own, and collaborative solutions and suggestions for overcoming these challenges can be shared.

Q *What expectations do you have for the new network scheduled to start in 2024?*

A The preliminary evaluation of the program that was just completed has been positive, while generating constructive ideas for minor adjustments that could further enhance the overall yield. Additionally, we can continue collaborating with Realdania, thereby collectively supporting crucial efforts in the green transformation of the construction sector. With its collaborative ethos, the new network is envisioned as a catalyst for change, fostering innovation and contributing to ongoing sustainability initiatives in the construction industry.



Why Cobe has engaged an industrial PhD and why your company should follow suit

Exploring Cobe's innovative decision to bring on an industrial PhD, we dive into the motivations behind this move and its potential benefits.

Few architectural firms have left as profound a mark on the Danish architectural landscape as Cobe. Since its establishment in 2006, Cobe has emerged as a powerhouse of architectural innovation, renowned for the redevelopment of the entire new district of Nordhavn, along with the realization of iconic projects such as The Silo, Nørreport Station, Paper Island, Israel's Square, and Krøyer's Square.

In our exclusive interview with Jacob Blak, the Head of Resiliency at Cobe, we delve beyond the company's local and international success to unravel Cobe's latest strategic move – the recruitment of an industrial PhD. In this exchange, we explore the motivations and expected benefits involved in Cobe's decision to bring PhD fellow Simon Sjøkvist onboard.

Q *Why did Cobe choose to hire an industrial PhD?*

A The green transition has accelerated the need for new insights and the capability to analyze hyper-complex interdisciplinary dynamics. This goes far beyond what our company alone can invest in or recruit for. We greatly rely on networks within academia, especially within philanthropically-funded institutions, to tailor our consultancy based on evidence.

Q *What significant contributions does Simon's research bring to Cobe?*

A Having a PhD within the company means that we now have research validated by a third party, making it legitimate research that cannot be dismissed as manipulated marketing. Furthermore, we gain access to potent networks comprising highly skilled and talented individuals across sectors, which sharpens our focus on the research, knowledge, networking, and profiling that we aim to pursue in the future.

Q *How does the research project align with Cobe's green ambitions?*

A We share the IPCC's assessment that cities play a pivotal role in combating the climate crisis. Simon's understanding of sustainable urban transformation and the reduction of CO2 emissions by reusing the existing building stock more effectively and on a larger scale provides a valuable insight into how we can potentially build greener. It has helped us justify proposing more sustainable solutions for urban development projects.

Q *What practical applications will Simon's research have for you?*

A We gain a much more qualified understanding of the negative consequences that our previous (and current) planning paradigms can have on planetary boundaries, specifically the damaging effects of expanding cities into undeveloped land. This means that in the future, we will turn down certain undertakings.

Q *Will the project benefit the bottom line?*

A It's difficult to measure, because we don't know the negative consequences it would have on the bottom line if we didn't engage in it. We consider it more as a necessary professionalization of our company, enhancing our services, profile, and appeal to skilled employees. I have no doubt that these parameters will have a positive effect on Cobe's position in the market and perhaps on the bottom line in the long run.

Q *What has surprised you the most?*

A I would say it's the extent to which commercial developers respect and recognize validated research. We have experienced completely unsolicited approaches from developers who are curious about the direction of Simon's PhD research. They have provided some truly important insights for contextualizing the findings we have presented.

Q *Would you recommend that others hire an industrial PhD?*

A Absolutely, if the company can afford it. But my recommendation comes with a premise: that the company invests time in understanding and contextualizing the findings that the research provides and is prepared to let the results influence the company. That way, it can yield a lot in return.

Cobe's inaugural industrial PhD in sustainable architecture and urbanism is conducted by architect Simon Sjökvist and supervised by Cobe's founder, Dan Stubbergaard, managing director Mari Randsborg, and head of resilience Jacob Blak. The PhD investigates how to transform and reuse the existing building stock on a broader and larger urban scale than today. The collaboration involves the Royal Danish Academy – Architecture, Design, Conservation, Aalborg University, and ETH Zurich.

"The green transition has accelerated the need for new insights and the capability to analyze hyper-complex interdisciplinary dynamics. This goes far beyond what our company alone can invest in or recruit for. We greatly rely on networks within academia, especially within philanthropically-funded institutions, to tailor our consultancy based on evidence."

Jacob Blak,
the Head of Resiliency at Cobe



Call to action

We hope this publication has provided inspiration and valuable insights and encourage you to continue this journey by connecting with researchers and implementing their insights in the field. You may even choose to initiate your own applied science project, future-proofing your work through the cross-pollination of research and industry. Your active involvement is vital to shaping a resilient and innovative future for construction.

- ▼ To see more information about the projects and find contact information and more about the researchers please visit:



- ▼ At BLOXHUB we are always working to ensure research and innovation is disseminated and applied in industry via a number of activities such as workshops, roundtable and applied science network. For further information or to sign up for our Applied Science Forum visit bloxhub.org.





Notes

Notes

Notes
