



**AALBORG UNIVERSITY**  
DENMARK

**Aalborg Universitet**

## **The Vision-in-practice Project leadENG**

Geil, Olav; Poulsen, Mogens Rysholt; Møller Jeppesen, Mette; Christensen, Troels Frøkjær

*Published in:*  
Transforming Engineering Education

*Publication date:*  
2023

*Document Version*  
Publisher's PDF, also known as Version of record

[Link to publication from Aalborg University](#)

*Citation for published version (APA):*  
Geil, O., Poulsen, M. R., Møller Jeppesen, M., & Christensen, T. F. (2023). The Vision-in-practice Project leadENG. In *Transforming Engineering Education* (OA ed., pp. 49-54). Aalborg Universitetsforlag.

### **General rights**

Copyright and moral rights for the publications made accessible in the public portal are retained by the authors and/or other copyright owners and it is a condition of accessing publications that users recognise and abide by the legal requirements associated with these rights.

- Users may download and print one copy of any publication from the public portal for the purpose of private study or research.
- You may not further distribute the material or use it for any profit-making activity or commercial gain
- You may freely distribute the URL identifying the publication in the public portal -

### **Take down policy**

If you believe that this document breaches copyright please contact us at [vbn@aub.aau.dk](mailto:vbn@aub.aau.dk) providing details, and we will remove access to the work immediately and investigate your claim.



Aalborg Universitet

AALBORG UNIVERSITY  
DENMARK

## Transforming Engineering Education

Guerra, Aida; Chen, Juebei; Lavi, Rea; Bertel, Lykke Brogaard; Lindsay, Euan

*Creative Commons License*  
CC BY-NC-ND 4.0

*Publication date:*  
2023

*Document Version*  
Publisher's PDF, also known as Version of record

[Link to publication from Aalborg University](#)

*Citation for published version (APA):*  
Guerra, A., Chen, J., Lavi, R., Bertel, L. B., & Lindsay, E. (Eds.) (2023). *Transforming Engineering Education*. (OA ed.) Aalborg Universitetsforlag. International Research Symposium on PBL

### General rights

Copyright and moral rights for the publications made accessible in the public portal are retained by the authors and/or other copyright owners and it is a condition of accessing publications that users recognise and abide by the legal requirements associated with these rights.

- Users may download and print one copy of any publication from the public portal for the purpose of private study or research.
- You may not further distribute the material or use it for any profit-making activity or commercial gain
- You may freely distribute the URL identifying the publication in the public portal -

### Take down policy

If you believe that this document breaches copyright please contact us at [vbn@aub.aau.dk](mailto:vbn@aub.aau.dk) providing details, and we will remove access to the work immediately and investigate your claim.





9<sup>th</sup> International Research Symposium  
on Problem-based Learning (IRSPBL):

# TRANSFORMING ENGINEERING EDUCATION 2023

Edited by: Aida Guerra, Juebei Chen, Rea Lavi, Lykke Bertel, and Euan Lindsay



**Harvard John A. Paulson  
School of Engineering  
and Applied Sciences**



United Nations  
Educational, Scientific and  
Cultural Organization



AALBORG UNIVERSITY  
Aalborg Centre for Problem Based Learning  
in Engineering Science and Sustainability  
under the auspices of UNESCO



School of  
Engineering

**NEET  
New Engineering  
Education Transformation**

## *Transforming Engineering Education*

Edited by Aida Guerra, Juebei Chen, Rea Lavi, Lykke Bertel, and Euan Lindsay

Series: International Research Symposium on PBL

© The authors, 2023

Graphic design by Hjortlund Medier

ISBN: 978-87-7573-023-0

ISSN: 2446-3833

Published by Aalborg University Press | forlag.aau.dk

9th International Research Symposium on PBL, June 21-23, 2023

Transforming Engineering Education

Hosted by MIT School of Engineering, Harvard John A. Paulson School of Engineering and Applied Science, and co-organised with Aalborg PBL Centre for PBL in Engineering Science and Sustainability under the Auspices of UNESCO, Aalborg University.

All the IRSPBL proceedings are available at <https://aauforlag.dk/> and <https://www.ucpbl.net/global-network/research-symposia>



**Responsibility for the content published, including any opinions expressed therein, rests exclusively with the author(s) of such content.**

### **General Copyrights**

The authors and/or other copyright owners retain copyright and moral rights for the publications made accessible in the public portal and it is a condition of accessing publications that users recognise and abide by the legal requirements associated with these rights. Users may download and print one copy of any publication from the public portal for the purpose of private study or research. You may not further distribute the material or use it for any profit-making activity or commercial gain. You may freely distribute the URL identifying the publication in the public portal.

### **Take down policy**

If you believe that this document breaches copyright, please contact [aauf@forlag.aau.dk](mailto:aauf@forlag.aau.dk) providing details and we will remove access to the work immediately and investigate your claim.



**Harvard John A. Paulson  
School of Engineering  
and Applied Sciences**



# Foreword

What kind of future awaits our graduates? Megacities, disruptions caused by expansions in artificial intelligence and big data, climate crises and (more) global pandemics are a few examples of the grand challenges emerging in the literature in the past eight years. For instance, the National Academy of Engineering<sup>1</sup> outlines 14 grand challenges for engineering in the 21<sup>st</sup> century, the United Nations<sup>2</sup> frames 17 Sustainable Development Goals to achieve by 2030, and the European Commission<sup>3</sup> advocates for ambitious research and innovation agendas around missions to address global challenges like climate crises. Worldwide, the vision is shared: addressing global challenges like these and securing a fair, peaceful, sustainable, and prosperous future for all. Engineers are central to achieving this vision, whilst engineering education institutions are key actors ensuring the transformation of educational practices to equip the next generation of professionals with the right set of skills, such as complex problem-solving, systems thinking and interdisciplinary collaboration.

**Transforming engineering education** is the theme of the 9<sup>th</sup> International Research Symposium on Problem-Based Learning (IRSPBL 2023), convened by the MIT School of Engineering, Harvard's John A. Paulson School of Engineering and Applied Sciences, and the Aalborg Centre for Problem-Based Learning in Engineering Science and Sustainability under the auspices of UNESCO. How can engineering education be transformed so that students develop the required skills to perform in globalised contexts and address global challenges? What learning can be shared by higher-education institutions that have embarked on educational transformation processes? What do other stakeholders in higher education, industry and society have to say about these efforts? These are examples of questions that will be discussed during the conference, hosted by MIT and Harvard on 21–23 June 2023. The IRSPBL 2023 has collected **55 contributions from 16 different countries**, all of which will be presented during the conference and have been compiled in this book. The contributions cover multiple relevant topics related to conference themes, namely collaboration with industry, creativity and interdisciplinarity, development of professional competences, digitalisation and online learning, education for sustainability, educational innovation and curriculum design, faculty professional development, problem-based learning (PBL) design and implementation, and student learning. This book represents some of the newest results from research on PBL and best practices to inspire researchers and practitioners to transform their practice and their institutions.

We would like to acknowledge **Prof. Edward Crawley, Prof. Eric Mazur and Prof. Anette Kolmos**, honorary co-chairs of the organising committee, along with **Prof. Xiangyun Du, Dr Babi Mitra, Dr Rebecca Nesson and Dr. Anas Chalah**, for their expertise, insightful suggestions and support during the process leading to this book.

We hope that you will find the book useful and inspirational for your future work, and we look forward to meeting you at IRSPBL, this year and in the future.

*The editors,*

*Aida Guerra,  
Juebei Chen,  
Rea Lavi,  
Lykke Bertel,  
and Euan Lindsay*

---

<sup>1</sup> National Academy of Engineering (2023). 14 Grand Challenges for Engineering in the 21st Century. Available at: <http://www.engineeringchallenges.org/challenges.aspx>

<sup>2</sup> United Nations (2015). Transforming our world: the 2030 Agenda for Sustainable Development. Available at: <https://sdgs.un.org/goals>

<sup>3</sup> European Commission (2018). Directorate-General for Research and Innovation, Mazzucato, M., Mission-oriented research & innovation in the European Union – A problem-solving approach to fuel innovation-led growth, Publications Office. Available at: <https://data.europa.eu/doi/10.2777/360325>

# TRANSFORMING ENGINEERING EDUCATION

Edited by: Aida Guerra, Juebei Chen, Rea Lavi, Lykke Bertel, Euan Lindsay

## Contents

Foreword ..... iii

### Collaboration with Industry

*Edwin Koh, Lee Siang Tai and Ashraf Kassim*

A Design and Artificial Intelligence Undergraduate Curriculum Based on Project-based Learning ..... 2

*Bente Nørgaard, Ida Marie Lybecker Korning, Lilia Bárcena-Caballero and Patricia Caratozzolo*

Practices and Trends in Continuing Engineering Education at Scandinavian and Mexican Universities ..... 7

*Hyunmi Park, Hyejeong Lee and Jeonga Yang*

A Case of Special Interest Group on Industry Coupled Problem-Based Learning for Transforming Engineering Education ..... 12

*Leonidah Kerubo, Thomas Ochuku Mbuya, Erastus Abonyo and Marc Zolver*

Work-In-Progress: Reforming Engineering, Science and Technology Education in Kenya ..... 17

*Mattias Bingerud, Mikael Enelund, Kristina Henricson Briggs, Anna Karlsson-Bengtsson and Johanna Larsson*

Tracks: Impactful Reform for Flexible Adaptable Education ..... 23

### Creativity and Interdisciplinarity

*Fernando Rodriguez-Mesa*

Perception of Students in a Transdisciplinary Rural PBL Model ..... 29

*Michael O'Connell, Patric Wallin, Raffaella Negretti and Christian Stöhr*

Work-In-Progress: Tracking Social Regulation of Learning in Interdisciplinary Group Work ..... 34

*Euan Lindsay, Olav Geil and Mette Møller Jeppesen*

Microcredentials to Support PBL ..... 39

*Jianxi Luo*

Meta Disciplines: Systems, Design and Computing ..... 44

*Olav Geil, Mogens Rysholt Poulsen, Mette Møller Jeppesen and Troels Frøkjær Christensen*

The Vision-in-practice Project leadENG ..... 49

*Ronald Ulseth and Bart Johnson*

From Project-Based to Work-Based Learning: Learnings from an Educational Transformation Process ..... 55

*Ryan Lundell*

Work In Progress: Combining Project-Based Learning with Critical Pedagogy ..... 60

### Development of Professional Competences

*Afandi Ahmad, Shamsul Mohamad, Muhammad Muzakkir Mohd Nadzri, Ashlee Pearson, and Sally Male*

Work-In-Progress: Global Competency in Engineering Education - Are We Doing Well Enough? ..... 65

*Ignacio Laiton*

Work-In-Progress: Analysis of the Incidence of a Pedagogical Intervention Centered on PBL Methodology and the Teaching of Critical Thinking Skills, in the Solving of Mechanical Physics Problems, in Engineering Students . 70

<i>Jette Egelund Holgaard, Asbjørn Romme, Henrik Worm Routhé and Anette Kolmos</i> Facilitating PBL Meta-competences in Engineering Education . . . . .	75
<i>Jovana Jezdimirovic Ranito and Pascal Wilhelm</i> Work-In-Progress: Perceived Learning Gains of Students, Teachers and Domain Experts in Challenge-based Learning and Students' Critical Thinking Activity in Student - Domain-Expert Interactions. . . . .	81
<i>María Leon and Carola Hernandez</i> Work-in-progress: Diagnosis of Developing Teamwork Competences in Engineering Students in a PO-PBL Course . . . . .	86
<i>Richa Mishra</i> My Dinner Plate is Different from Your Dinner Plate: Teaching Empathy using PBL in Engineering classrooms: A Case Study from India . . . . .	91
<i>Yakhoub Ndiaye and Lucienne Blessing</i> Work-In-Progress: Teaching and Assessing Complex Engineering Design Skills from A Whole-Task Approach . . .	97

## Digitalization and Online Learning

<i>Adam Hendry, Daniel Bateman, and Joshua Bryers</i> Work-in-Progress: How are Constructivist Pedagogies Transforming Engineering-related Education in High school and Potentially Beyond? . . . . .	103
<i>Aderonke Sakpere, Wonderful Osalor, Divine Nwabuife, Fenton Hughes and Halleluyah Aworinde</i> A study on the use of Flipped Classroom in a Mentorship Programme for STEM Females . . . . .	108
<i>Pauli Lai</i> Work-in-Progress: Codatus – An Innovative Online Practical Platform for Transforming Coding Education . . . . .	113
<i>Sofie Otto and Lykke Brogaard Bertel</i> Engineering Students' Perceptions of Digital Competences in a PBL Environment . . . . .	118
<i>Olga Timcenko and Lui Albaek Thomsen</i> Work in progress: Real mathematics in Virtual worlds . . . . .	124
<i>Shubhakar Kalya, Chee Huei Lee, Tee Hui Teo, Jacob Chen, Melvin Lee Ming Jun, Jun Hua Ong, Kwan Chee Goh, Mohan Rajesh Elara, Wei Lek Kwan and Oka Kurniawan</i> Work-In-Progress: Immersive and Collaborative Environment for Remote Participants in Cyber-Physical mode using Telepresence Robot Enabled with 360° View Camera . . . . .	129

## Education for Sustainability

<i>Aida Guerra, Gesa Ruge and Jovana Jezdimirovic Ranito</i> Who am I and Why am I here? - Academic Staff Viewpoints on CBL and towards a Sustainability Mindset . . .	138
<i>Camilla Guldborg and Christian Skelmosé</i> Action competence in PBL: Revitalizing Educational Ideals to Foster Meaning and Engagement in Engineering Education for Sustainable Development . . . . .	143
<i>Giajenthiran Velmurugan, Sebastian Munk Andersen, Sanne Lisborg and Stine Ejsing-Duun</i> Work-in-Progress: How to Assess Collaboration in Problem- Based Learning to Promote Sustainability in Future Engineers. . . . .	148
<i>Katherine Ortegón, Natalia Rodríguez, Camila Pizano, Pilar Acosta and Andrés López</i> Reflections on Creating an Interdisciplinary Graduate Program of Sustainability in Colombia. . . . .	154

## Educational Innovation and Curriculum Design

<i>Imad Abou-Hayt and Bettina Dahl</i> Is the Drawing of Free Body Diagrams a Threshold Concept? . . . . .	160
---	-----



<i>Lelanie Smith, Jaco Fourie and Karin Wolff</i> Work-in-Progress: 'clear' - A value-based Approach towards Overcoming Resistance to Change and Adapting Student-centred Classroom Practices in Engineering Education . . . . .	167
<i>Louise Møller Haase, Jette Egelund Holgaard and Anette Kolmos</i> The Complexity of Engineering Education in a Mission Driven PBL University . . . . .	172
<i>Federico Toschi, Alessandro Gabbana, Jasmina Lazendic-Galloway, Anneke Boonacker-Dekker and Yvonne Vervuurt</i> Designing a Learning Dashboard to Facilitate Project Development and Teamwork in a CBL Physics Course . . .	178
<i>Gowtham N, Shobha Shankar, Savyasachi G.K, Rakshith P, Avinash R, Goutham B, and Mahipal Bukya</i> CDIO Based Curriculum Design Framework for Electrical and Electronics Engineering Program . . . . .	183
<i>Lama Hamadeh</i> Work in Progress: Integrating Python into Mechanical Engineering Undergraduate Curriculum. . . . .	190
<i>Liliana Fernández-Samacá, Sonia Esperanza Díaz Marquéz, Diana Carolina Latorre, María Cristina Corrales Mejía and Oscar Iván Higuera-Martinez</i> Promoting PBL initiatives in Engineering from an Institutional Strategy for Curricular Transformation. . . . .	198

## Faculty Professional Development

<i>Jorge A. Baier, Isabel Hilliger, Matías Piña, Ximena Hidalgo, Gabriel Astudillo and Loreto Valenzuela</i> Work-In-Progress: Caring for Student's Academic and Personal Challenges via the Wellbeing Teaching Assistant. . . . .	206
<i>Alessia Napoleone, Lykke Brogaard Bertel and Ann-Louise Andersen</i> Work-in-Progress: PBL Requirements and Challenges for Teachers in Industrial Engineering Education . . . . .	211
<i>Andrew Olewnik, Amanda Horn and Laine Schrewe</i> A Systematic Review of PBL Literature: in Search of Support for Engineering Situated Problem Design Guidelines. . . . .	219
<i>Sanne Lisborg, Søren Hansen, Lykke Brogaard Bertel, Mette Møller Jeppesen, Bettina Dahl, Sofie Otto, Camilla Guldborg, Lars Bo Henriksen and Jakob Farian Krarup</i> Work-in-Progress: STEMification - Towards a Framework for Supporting Teachers' Professional Development in PBL with a Focus on Engineering Education Transitions . . . . .	224

## PBL Design and Implementation

<i>Oscar Mariño, Lina Peña-Páez and Lyda Soto-Urrea</i> Teaching Differential Calculus in Engineering: An Experience from PBL . . . . .	231
<i>Dave Custer</i> An Odyssey of a Maker Seminar, Thoughts on Teaching Making for Project-enhanced Learning in First-year Physics. . . . .	237
<i>Eral Bele, Enrique Galindo-Nava, Zareena Gani, Liwei Guo and Martyna Michalska</i> Work In Progress: Design of a PBL-Centred Masters Programme in Nanoscale Manufacturing . . . . .	242
<i>Francesco Ciriello, Claire Lucas, Antonio Elia Forte and Wei Liu</i> Strategies for Embedding Simulation in Open-ended Engineering Design Education . . . . .	247
<i>Isabelle Lermigeaux-Sarrade and Ingrid Le Duc</i> Work in progress – Imagining / Designing Informal Learning Spaces for PBL. . . . .	254
<i>Renate G. Klaassen, Hans Hellendoorn, Linette Bossen, Birgit de Bruin</i> A Learning Ecosystems framework for Engineering Education . . . . .	260
<i>Tammar Shrot, Ayelet Raz, Ronit Shmallo, and Lior Aronstham</i> A Transformation in Teaching Software Engineering Novices Based on Their Errors when Learning Design Patterns . . . . .	266

## Student Learning

*Bonolo Mokoka, Lelanie Smith, Karin Wolff and Lykke Brogaard Bertel*

Work-in-Progress: Project-based Learning and Culturally-responsive Pedagogy: An Approach to Foster Self-efficacy and Inclusivity in Undergraduate Engineering Education ..... 272

*Faris Tarlochan, Wadha Labda, Khalid Naji and Xiangyun Du*

Work-In-Progress: Examining Engineering Students' Perception of Student Agency in Solving Complex Engineering Problem. .... 277

*Thitiwat Piyatamrong, Gouri Vinod, Yiwen Xu, Yifan Xie and Abel Nyamapfene*

Discussions on how Self-directed Learning is a by-product of Problem-based Learning through the Conception of "Divide and Conquer". .... 282

*Yan Zhao and Xiangyun Du*

Work-In-Progress: Using research-focused PBL to Support Computer Engineering Students' Learning Engagement in a Systemic PBL Environment. .... 287

*M. Ezhilarasi and S.G. Mohanraj*

Kumaraguru Project Based Learning (KPBL) Framework: The Futuristic Pedagogy for Gen Z Learners ..... 292

*Philippe Chang*

Considering PBL in Engineering Science from an Epistemological Perspective. .... 297

*René Bødker Christensen, Bettina Dahl, and Lisbeth Fajstrup*

Transforming First-Year Calculus Teaching for Engineering Students - Field Specific Examples, Problems, and Exams. .... 303

*Fiona Truscott, Emanuela Tilley, John Mitchell, Abel Nyamapfene*

Large-Scale Interdisciplinary Project-based Learning: Staff Experiences of Leading Multi-departmental Projects for Year 1 Engineering Students. .... 309

List of Authors ..... 314

List of Reviewers ..... 320



## Collaboration with Industry

# A design and artificial intelligence undergraduate curriculum based on project-based learning

Edwin C.Y. Koh

Singapore University of Technology and Design, Singapore, [edwin\\_koh@sutd.edu.sg](mailto:edwin_koh@sutd.edu.sg)

Lee Siang Tai

Singapore University of Technology and Design, Singapore, [leesiang\\_tai@sutd.edu.sg](mailto:leesiang_tai@sutd.edu.sg)

Ashraf A. Kassim

Singapore University of Technology and Design, Singapore, [ashraf@sutd.edu.sg](mailto:ashraf@sutd.edu.sg)

## Summary

This paper discusses the development of the Design and Artificial Intelligence (DAI) undergraduate degree programme at the Singapore University of Technology and Design (SUTD), which aims to nurture technically grounded innovators that can create better design with AI. The curation of both the Design and AI content within the DAI curriculum was not easy as the programme needs to deliver a strong foundation in both areas without requiring students to overload additional courses. To address this, the DAI programme uses project-based learning (PBL) in the curriculum through hands-on design studio courses where students work in teams on industry-sponsored projects to design solutions. In this paper, the DAI programme is evaluated from a student self-efficacy perspective to better understand whether the PBL approach embedded in the DAI programme suffices in increasing student confidence on designing solutions and working with industry. A series of end-of-term surveys were carried out in this work and the results show that the number of students with higher confidence level increases with each passing term over the duration of this study. The findings suggest that PBL can be used as an approach to broaden student learning in a packed curriculum while supporting the development of student confidence.

**Keywords:** curriculum design, project-based learning, industry ready, design competency, self-efficacy

**Type of contribution:** Research extended abstracts

## 1 Introduction

Artificial Intelligence (AI) is set to play an important role in the global economy (Rao & Verweij, 2017). While not everyone aspires to be an AI engineer, future jobs across industries will inevitably be influenced by AI (Bughin et al., 2018). Hence, there is a growing need to produce graduates who are savvy in AI. The Design and Artificial Intelligence (DAI) undergraduate programme at the Singapore University of Technology and Design (SUTD) seeks to address this need by nurturing students to become technically grounded innovators that can create better design with AI. A key principle in the development of the DAI curriculum is to ensure that students go through rigorous learning in design innovation and AI technology to gain mastery in both areas rather than a superficial sampling of the two. However, Design and AI are both huge topics that require substantial amount of time to cover the fundamentals. A mere stacking of traditional Design courses together with AI courses may lead to a curriculum that requires course overloading for each term. Hence, the DAI programme uses project-based learning (PBL) (Blumenfeld et al., 1991; Luxhøj & Hansen, 1996) in the

curriculum through hands-on design studio courses where students work in teams on industry-sponsored projects to design solutions. The key objective is to provide opportunities for self-regulated learning (Boekaerts, 1999) to broaden and strengthen student learning in both Design and AI topics. In doing so, the PBL inspired design studio courses also offer a platform to engage students in active learning (Prince, 2004), increase students’ motivation (Chandrasekaran et al., 2014), and enhance their epistemological development (Zhu et al., 2019).

In this work, the DAI programme is evaluated from a student self-efficacy perspective to examine whether the PBL approach embedded in the DAI curriculum increases student confidence on their beliefs that they can execute the courses of action required to complete a design project with an industry partner (see Bandura, 1977, on self-efficacy theory). The remainder of this paper is organised as follows: Section 2 presents the DAI curriculum in further detail. Section 3 outlines the methodological approach of this study. The results from the study and the implications of the findings are discussed in Section 4. Lastly, the contribution of this work is summarised in Section 5.

## 2 A design and artificial intelligence curriculum

The Design and Artificial Intelligence (DAI) programme at the Singapore University of Technology and Design (SUTD) is a four-year undergraduate degree programme with eight terms (see Figure 1). Term 1, 2 and 3 are referred to as the Freshmore terms where all SUTD students take on common core courses such as ‘Modelling and Analysis’ and ‘Design Thinking and Innovation’. Students who wish to pursue the DAI programme will take on DAI courses from Term 4 onwards. A unique feature of the DAI curriculum is the four design studio courses that take place from Term 4 to Term 7 of the programme. These studios allow students to undergo hands-on experiential learning on real-world issues through industry-sponsored projects. For instance, ‘Product Design Studio’ in Term 4 focuses on training students to design a physical product with an industry partner (e.g. medical dispensing machine). Similarly, ‘Service Design Studio’ in Term 5 focuses on the design of an online service application (e.g. online banking app), ‘Systems Design Studio’ in Term 6 focuses on the design of a material flow system (e.g. queueing system for a hospital), and ‘Spatial Design Studio’ in Term 7 focuses on the design of a physical space (e.g. interior of a museum lobby).

		<b>Term 1</b> Modelling and Analysis Physical World Computational Thinking for Design World Texts & Interpretations
<b>Term 2</b> Modelling Space & Systems Technological World Science for a Sustainable World Design Thinking & Innovation	Vacation/ Summer Programme	<b>Term 3</b> Modelling Uncertainty Theorising Society, Self & Culture Any two Term 3 electives*
<b>Term 4</b> Product Design Studio AI Applications in Design Algorithms HASS elective^	<b>Term 5</b> Service Design Studio Machine Learning HCI & AI HASS elective^	Vacation/ Internship/ Exchange
<b>Term 6</b> Systems Design Studio Applied Deep Learning DAI elective# HASS elective^	Vacation/ Internship/ Summer Programme	<b>Term 7</b> Spatial Design Studio Capstone DAI elective# HASS elective^
<b>Term 8</b> Capstone DAI elective# DAI elective# HASS elective^	*Science & Technology for Healthcare, Data Driven World, Designing Energy Systems, or Spatial Design World ^Humanities, Arts and Social Sciences (HASS) electives #Elective courses offered by or aligned to DAI	

Figure 1: Design and Artificial Intelligence (DAI) curriculum at SUTD

The DAI design studio courses form the core of the design-focused courses in the DAI curriculum. Students are exposed to design principles and methods and fundamental technical know-how in the early weeks of each design studio to create awareness and develop curiosity. For example, in the 'Product Design Studio', students will learn design fundamentals covering topics such as design thinking, value proposition design, product form design, and electronics prototyping, while working on an industry project. In the 'Service Design Studio', students will learn topics such as agile design process, Ruby on Rails framework, and web technologies for medium-scale cross-platform service, while working on another industry project. The inclusion of AI technology in the solutions developed is optional as each industry project is unique with its own requirements. Nevertheless, students are supported by AI-focused core courses in the curriculum in the form of 'Algorithms' in Term 4, 'Machine Learning' in Term 5, and 'Applied Deep Learning' in Term 6, which students can tap on and apply in the design studios. In addition, there are two DAI core courses on the interplay between Design and AI, focusing on the use of AI technology to support the design process. For instance, the 'AI Applications in Design' course in Term 4 covers topics such as the mining of design requirements from large volume online data, which students can apply in the design studios to reinforce their learning. The 'HCI and AI' course in Term 5 exposes students to the concept of human memory and attention and can be used in the design studios as well to support the design of user interfaces.

There are four elective slots in the DAI curriculum spread across Term 6, 7, and 8 where students have the flexibility to pursue more courses in Design and/or AI based on their interests. In Term 7 and 8, senior year students (4<sup>th</sup> year) from different degree programmes at SUTD, including DAI, come together to form teams and work on industry projects through the Capstone course. While the Capstone course offers yet another avenue for project-based learning, this paper limits the discussion to the core courses unique to the DAI programme. Further details on the Capstone course can be found in (Pey et al., 2020).

### 3 Method

This work seeks to evaluate the DAI programme from a student self-efficacy perspective and examines whether the PBL approach embedded in the curriculum to broaden student learning in a packed curriculum has an impact on the development of student confidence. A series of end-of-term anonymous surveys was carried out in this work for this purpose and this section describes the approach taken.

#### 3.1 Survey Sampling

Participants in this study are DAI students and the first batch enrolled at SUTD in September 2020. They started with Freshmore courses in Term 1, 2, and 3 before embarking on DAI courses from Term 4 onwards. At the time of writing this paper, the first batch completed Term 5 while the second batch completed the Freshmore terms. Hence, this study only focuses on the first batch of DAI students as the second batch has not experienced DAI core courses. Identical end-of-term surveys were carried out at three junctures – Survey 1 was carried out at end of Term 3 (i.e. start of DAI core courses), Survey 2 at end of Term 4, and Survey 3 at end of Term 5. All DAI students (N = 34) were invited to participate. Out of which, 17 students participated in Survey 1 (n1 = 17), 19 in Survey 2 (n2 = 19), and 23 in Survey 3 (n3 = 23). Participation in the study was voluntary. No course credits or monetary rewards were given.

#### 3.2 Survey Instrument

The end-of-term survey consists of 2 survey items as shown in Figure 2. The survey items were structured as questions with verbally labelled response options instead of statements with agree/disagree response options to avoid acquiescence bias (Sarlis et al., 2010). A 5-point response scale ranging from 'Extremely confident' to 'Not at all confident' was adapted from (Timur & Tasar, 2011) with all response options labelled as recommended in (Gehlbach & Artino, 2018).

Q1. How would you rate your current confidence level in working with industry partners?

Not at all confident	Slightly confident	Somewhat confident	Fairly confident	Extremely confident
----------------------	--------------------	--------------------	------------------	---------------------

Q2. How would you rate your current confidence level in designing a solution?

Not at all confident	Slightly confident	Somewhat confident	Fairly confident	Extremely confident
----------------------	--------------------	--------------------	------------------	---------------------

Figure 2: Survey items

## 4 Results

A summary of the responses for survey item 1 (i.e. Q1) is tabulated in Table 1. ‘Fairly confident’ was identified as the mode and median in Survey 1, 2, and 3. The percentage of respondents who selected higher confidence level increases over time, with 53% of respondents in Survey 1 selecting ‘Fairly confident’ or ‘Extremely confident’ (i.e.  $(8 + 1) / 17 = 53\%$ ), 58% in Survey 2, and 87% in Survey 3. While the distribution between Survey 1 and 2 (i.e. from start of DAI core courses to end of Term 4) and the distribution between Survey 2 and 3 (i.e. from end of Term 4 to end of Term 5) did not differ significantly, the distribution between Survey 1 and 3 was significantly different (Mann–Whitney  $U = 128.5$ ,  $n_1 = 17$ ,  $n_3 = 23$ ,  $P < 0.10$ , two-tailed).

Table 1: Survey responses for Question 1 – working with industry partners.

Survey ID for Q1	Confidence level				
	Not at all confident	Slightly confident	Somewhat confident	Fairly confident	Extremely confident
Survey 1	2	2	4	8	1
Survey 2	0	1	7	9	2
Survey 3	0	0	3	19	1

A similar trend can be seen in the responses for survey item 2 (i.e. Q2) shown in Table 2. ‘Fairly confident’ was also identified as the mode and median in Survey 1, 2, and 3. The percentage of respondents who selected higher confidence level increases over time as well, with 53% of respondents in Survey 1 selecting ‘Fairly confident’ or ‘Extremely confident’, 68% in Survey 2, and 78% in Survey 3. The distribution between Survey 1 and 2 and between Survey 2 and 3 did not differ significantly. However, the distribution between Survey 1 and 3 was significantly different (Mann–Whitney  $U = 130.5$ ,  $n_1 = 17$ ,  $n_3 = 23$ ,  $P < 0.10$ , two-tailed).

Table 2: Survey responses for Question 2 – designing a solution.

Survey ID for Q2	Confidence level				
	Not at all confident	Slightly confident	Somewhat confident	Fairly confident	Extremely confident
Survey 1	1	3	4	9	0
Survey 2	1	0	5	13	0
Survey 3	0	1	4	16	2

## 5 Closing remarks

The Design and Artificial Intelligence (DAI) degree programme at SUTD uses project-based learning to broaden student learning in a packed curriculum. This paper examines whether the PBL approach embedded has an impact on the development of student confidence in terms of designing solutions and working with industry through a series of student surveys. The results show that the number of students with higher confidence level increases with each passing term over the duration of this study, suggesting that PBL can be used as an approach to broaden student learning in a packed curriculum from a student self-efficacy perspective.

Acknowledgement: The authors would like to thank Zerline Tan for collating the survey data.

## 6 References

- Bandura, A. (1977). Self-efficacy: Toward a unifying theory of behavioral change. *Psychological Review*, 84(2), 191-215.
- Blumenfeld, P. C., Soloway, E., Marx, R. W., Krajcik, J. S., Guzdial, M., & Palincsar, A. (1991). Motivating project-based learning: Sustaining the doing, supporting the learning. *Educational Psychologist*, 26(3-4), 369-398.
- Boekaerts, M. (1999). Self-regulated learning: Where we are today. *International Journal of Educational Research*, 31(6), 445-457.
- Bughin, J., Seong, J., Manyika, J., Chui, M., & Joshi, R. (2018). *Notes from the AI frontier: Modeling the impact of AI on the world economy*. Report, McKinsey & Company.
- Chandrasekaran, S., Littlefair, G., Joordens, M., & Stojcevski, A. (2014). A comparative study of staff perspectives on design based learning in engineering education. *Journal of Modern Education Review*, 4 (3), 153-168.
- Gehlbach, H., & Artino, A. R. Jr. (2018). The survey checklist (Manifesto). *Academic Medicine*, 93(3), 360-366.
- Luxhøsj, J. T., & Hansen, P. H. K. (1996). Engineering curriculum reform at Aalborg University. *Journal of Engineering Education*, 85(3), 183-186.
- Pey, K. L., Blessing, L., & Tuncer, B. (2020). *A transformative engineering and architecture education*. In: 2020 IEEE Frontiers in Education Conference (FIE), 1-4.
- Prince, M. (2004). Does Active Learning Work? A Review of the Research. *J. Eng. Educ.*, 93 (3), 223-231.
- Rao, A. S., & Verweij, G. (2017). *Sizing the prize: What's the real value of AI for your business and how can you capitalise?* Report, PricewaterhouseCoopers.
- Saris, W., Revilla, M., Krosnick, J. A., & Shaeffer, E. M. (2010). Comparing questions with agree/disagree response options to questions with item-specific response options. *Survey Research Methods*, 4(1), 61-79.
- Timur, B., & Tasar, M. F. (2011). In-service science teachers' technological pedagogical content knowledge confidences and views about technology-rich environments. *Center for Educational Policy Studies Journal*, 1(4), 11-25.
- Zhu, J., Liu, R., Liu, Q., Zheng, T., & Zhang, Z. (2019). Engineering students' epistemological thinking in the context of project-based learning. *IEEE Transactions on Education*, 62(3), 188-198.



# Practices and Trends in Continuing Engineering Education at Scandinavian and Mexican Universities

Bente Nørgaard

Aalborg Centre for Problem Based Learning in Engineering Science and Sustainability, Aalborg University, Denmark,  
*bente@plan.aau.dk*

Ida Marie Lybecker Korning

Aalborg Centre for Problem Based Learning in Engineering Science and Sustainability, Aalborg University, Denmark,  
*imlk@plan.aau.dk*

Lilia Bárcena-Caballero

EGADE Business School, Tecnológico de Monterrey, Mexico, *lilia.barcena@tec.mx*

Patricia Caratozzolo

Institute for the Future of Education, Tecnológico de Monterrey, Mexico, *pcaratozzolo@tec.mx*

## Summary

This study aims to explain the activities of universities within Continuing Engineering Education (CEE) by conducting a mapping study based on data from different technical universities in the Scandinavian countries and Mexico. The main objective is to explain the patterns related to current CEE practices, the trends identified in cross-collaboration, and the new paradigm for the flow of knowledge between universities, companies, and professional workers.

**Keywords:** continuing engineering education, educational innovation, lifelong learning, industry 4.0, professional development.

**Type of contribution:** Research extended abstracts.

## 1 Introduction

Organisations such as the World Economic Forum (WEF) and the Organisation for Economic Cooperation and Development (OECD) have published international reports related to the future of work, the reskilling revolution, and the relationship between Employment, Skills, and Workforce Strategy for the Fourth Industrial Revolution (Hughson & Wood, 2020; Ratcheva et al., 2020). The conditions of rapid evolution in Industry 4.0 and its accelerated technological advances seem to require more research in CEE in the universities themselves so that graduates develop a lasting culture of lifelong learning (Zhang et al., 2020). The CEE should be considered a great ally to achieve not only the upskilling and reskilling update in the technical and technological competencies of Industry 4.0 but also for the formal and informal training in the skills and competencies that professionals require throughout their engineering careers. Additionally, there is still the unresolved problem of the impact of COVID-19. Post-COVID issues posed new challenges for education in general and severe problems for the CEE (for example, the accelerated implementation of digitised versions of some processes and the difficulty of virtually carrying out specific training) (Nayak et al., 2022). The interest in this work started during the 18th World Conference on Continuing Engineering Education in June 2022, where "A Panoramic View of the State of Continuing Engineering Education in Europe" was discussed and put into perspective, i.e., to Mexico. Thus, the main objective of this study is to describe the different cultures, processes, and CEE approaches, practices, and trends identified in cross-collaboration between universities, companies, and professional workers. The study considered different layers: macro factors (national and international) that refer to other countries and their contexts: labour market and education system; and *meso factors* (learning providers) that refer to the different providers and organisations, considering the management of the programs. The scope of this study does not allow any

analysis of the *micro factors* (individual) that refer to the individual level construct, such as psychological and socio-cultural, demographic, and economic factors. The study considers two Research Questions on the way to identify the patterns related to current CEE practices and trends:

*RQ1: What is the current panorama of CEE in countries of two geographically independent regions: Scandinavia (Denmark, Norway, Sweden, Iceland, and Finland) and Latin America (Mexico)?*

*RQ2: What trends and innovative practices related to CEE are ongoing in those regions?*

## 2 Methodology

The literature non-systematic literature review carried out in the present study is a review that seeks to identify linkages among Higher Education Institutions, industry, and society. The keywords for the search, derived from the RQs mentioned above, were "*continuing education*", "*continuous professional education*" and "*engineering*". However, the study limited the search to the Scopus database and the last ten years (2013-2022). As a result, we found only 46 document results using the search term "*continuing engineering education*" and 135 document results using the search terms "continuous professional development" AND "engineering" AND "*computer sciences*", with the following characteristics:

- Three publications with the European Commission as Funding Sponsor (2016, 2020, and 2021) exist.
- Regarding universities, the TOP 10 were: Oklahoma State University ( $n=9$ ); Aalborg University ( $n=9$ ); University of Johannesburg ( $n=8$ ); Koch Engineered Solutions Institute SM ( $n=7$ ); John Zink Institute ( $n=6$ ); University of South Carolina ( $n=6$ ); University of Limerick ( $n=6$ ); The Open University ( $n=6$ ); Trinity College Dublin ( $n=5$ ); University of Leicester ( $n=5$ ).
- Of the 28 articles published in 2022, 7 are chapters belonging to the book "*Continuing Engineering Education Handbook*" (<https://doi.org/10.52305/ZRNH8663>).

The data collection resulted from descriptive document analysis, e.g., global, national, and institutional reports and whitepapers. We analysed those documents to identify CEE activities and thus give voice and meaning to the data and further highlight trends and the future of CEE based on the CEE mapping.

## 3 Mapping of the Scandinavian countries CEE

### 3.1 Panorama of the CEE in Scandinavian countries

CEE activities across Scandinavian universities are diverse, as the Nordic STEM Report (2021) reflects. We interviewed CEE staff from nine Scandinavian universities in Denmark, Sweden, Iceland, Finland, and Norway, who describe the contemporary practice and imaginaries regarding the future of CE. The number of participants in postgraduate education in Scandinavia is limited. In 2021, 1220 individuals participated in continuing education (CE) in Denmark out of a population of around 5,8 million. Likewise, there has been a tendency to prioritize CE in the humanities and social sciences instead of engineering and natural science courses. When describing the Scandinavian CEE praxis, two organisational approaches emerge. The "open university" (OU) courses are managed centrally and constitute accredited and continuously scheduled classes. The accreditation of the OU corresponds to the European Qualifications Framework (EQF), equalling EQF levels 6 and 7, which is the BS.C and MS.C degree. OU covers MBAs, Diplomas, Open Seat-, Full Time on Part, Time courses, and Single Subjects, partly funded through government funding. This situation reduces the financial burden on the participants but heightens the formal obligations for CEE activities.

Additionally, the requirements depend on national legislation and constitute specifications for admission and conduction of CEE. An example of this is the admissions requirements for an MBA, which is a BSC and two years of work experience, or for the Empty Seat courses, where participants can take up an empty seat for cheap and participate in ordinary BS.C. and MS.C. courses and receive credits if they fulfill the requirements and exams. According to the Scandinavian universities, the problem with OU courses is the limited flexibility due to the formal regulations. Universities bypass these limitations through commercial courses (CC), which

are organised internally at the university or through university external holding companies. Commercial courses are often not accredited or state-funded, but participants or employers finance them. Commercialised CEE includes a range of products such as workshops, single courses, micro-credentials, or MOOCs spanning hours or days, to more extended programs such as commercial MBAs. Besides increased flexibility, universities emphasise the advantage of new revenue through CC. The synergy between BS.C. and MS.C. level and CEE courses is typical for the Scandinavian CEE. Specific for CEE is the use of Problem-Based learning, group work, and utilisation of teachers from industries to ensure that the CEE meets the professional needs of adult learners and companies.

### 3.2 CEE trends in Scandinavian countries

Looking into the future of CEE, Scandinavian universities believe that CEE will constitute an essential part of the university's activities and business. The fact influences the political discussions, e.g., Aalborg Universities (AAU) strategic agreement with the Danish government, where AAU pledged to provide new CE courses within the engineering field. Academic staff also consider CEE as having a vital role in the future "*[...] maybe in the future we have as many [...] ordinary students as we have continuous learning students*".

Scandinavian universities need better organisational structures, e.g., by creating holding companies, streamlining administrative systems, and implementing new incentive structures. The situation raises a conscious wish to move away from CEE based on the individual employees' passion and playing a minuscule role on an institutional level. Instead, having CEE constitutes a vital role in the university strategy. The interviewed universities agreed on the need for better cooperation between universities and the private and public sectors. The universities wish to utilise a dialogue-based approach to facilitate collaboration through market research, student networks, and courses aimed at adult learners with a non-formal educational background to ensure that CEE reflects professional needs. Finally, the universities underscored the need for flexible CEE activities, making CEE easily accessible for companies seeking a competence boost by implementing digitalization and micro-credentials. There exists an agreement that universities must utilise CEE to facilitate personal development and lifelong learning as in current society, individuals spend evermore years in the labour market "*[...] if we're going to work until we're 70, we have to have a system that can handle 45, 50-year-old engineers coming back and taking a one-year master's degree to reskill because what they studied 25 years ago isn't valid anymore*".

## 4 Mapping of the Mexican CEE

### 4.1 Panorama of the CEE in Mexico (Macro Level)

Data for the first quarter of 2022 from the National Occupation and Employment Survey (ENOE) shows that the number of employed professionals in the country is 10.5 million. Of the total population in Mexico, 237 thousand 617 students are currently studying a specialty, master's degree, or doctorate, according to data from the National Information System of Educational Statistics in Mexico of the federal Ministry of Public Education. According to the Organization for Economic Cooperation and Development (OECD), in Mexico, there are about 6.6 million people, representing 0.7 percent of the total population, who have a master's degree, and about 400,000 have a Ph.D. degree, representing 0.1 percent of the total population. Master's degrees in business or MBA are in great demand, so there are different rankings for this type of study. To be considered among the most prestigious and significant rankings worldwide, business institutions must have accreditation from the Association to Advance Collegiate Schools of Business (AACSB), the Association of MBAs (AMBA), or the European Quality Improvement System (EQUIS). The rankings evaluate the school based on its students' results at the end of their studies. It is possible to review the methodology of each ranking in detail on the official websites of said publications. Elements such as the requirements for the selection of students, and their average GMAT scores, salary increase, job growth and success, networking, and entrepreneurship index, perception compared to other business schools, consider the quality perceived by recruiters, and the return on investment against the cost of tuition, among others. Only two Mexican

Institutions belong to the QS Global MBA Rankings, Latin America 2022: EGADE Business School (with an overall score of 65.3) and IPADE Business School (with an overall score of 50.2).

#### 4.2 The case of Tecnológico de Monterrey and CEE trends in Mexico

EGADE (Graduate School of Business Administration) Business School is part of the 1% of business schools worldwide that have obtained triple International accreditation: it has been evaluated and endorsed by the three prominent accreditation organisations worldwide (AACSB, AMBA, and EQUIS). EGADE School currently has three internationally positioned programs in the main rankings: the *Full-Time MBA in Innovation & Entrepreneurship*, the *Master's in Finance*, and the *Master's in Business Management*, which was ranked #1 in Mexico and LATAM for the second consecutive year. Regarding the CEE options at Tecnológico de Monterrey, the program most required by engineers (minimum two years of professional experience) is *The Master's in Engineering (MCI)*, which seeks to face the current challenges of a global society: overpopulation, hyperconnectivity, and the irreversibility of climate change and loss of natural resources; and *The Master's in engineering management (MEM)* that is aimed at engineers employed in large multinational companies and seeks to develop communication, leadership, and project management. In the last admission of EGADE Business School students, the master's degrees in business had the following distribution of students: MBA, 39% of engineering students; MAF students, 33% of engineering students; MBD, 49% of engineering students. One of the trends integrated into the master's programs at Tecnológico de Monterrey is the incorporation of courses, micro-courses, and webinars by professors on engineering topics such as Logistics Trends and Supply Chains, as well as Machine Learning Models in risk management in the MBA and the MAF; and the issue of the Impact of Analytics on the Transformation of the Company, in the MBD. These topics are complemented by carrying out real projects with companies where students put into practice the knowledge taught in the classroom. It is interesting to highlight the inclusion of technologies for learning through educational innovation in various courses, alternative learning such as cybersecurity in business, virtual introduction to Virtual Reality in industry, and introduction of *blockchain for business* to reinforce knowledge and even obtain a certificate.

Additionally, a virtual campus in the metaverse opened last year. Considering the Meso level, some of the most innovative CE trends we can mention are related to the aspects of didactics and the modular structure of the programs. Two examples of the Tecnológico de Monterrey educational strategies are Massive Flexible Digital Masterclass Model (MFDM) and distance programs with LIVE interactions. MFDM follows a masterclass approach using challenge-based learning and flipped classrooms as pedagogic techniques to promote the development of competencies and skills. LIVE are online programs that combine two types of learning, synchronous and asynchronous.

### 5 Findings and Discussion/Conclusion

Though there has been public recognition of the need for lifelong learning in engineering education, CEE still needs scholarly attention. The purpose of this study was to deliver a mapping of contemporary practises and imaginaries regarding the future of CEE in Scandinavia and Mexico. Firstly, it is necessary to emphasise the different educational traditions on a macro level. In Scandinavia, CEE encompasses formal and informal postgraduate education, whereas CEE constitutes courses at MA/Ph.D. level in Mexico. This difference in conceptualization may reflect that getting a tertiary education is more widely spread in Scandinavia than in Mexico, creating a different understanding of CE (UNESCO Institute for Statistics, 2016). When researching CEE, it is necessary to keep this conceptual discrepancy in mind. Financing and administration of CEE is another point of difference at a macro level. CEE in Mexico is developed as a part of the university focal point and financed by the participants, and the welfare state partly subsidises the CEE in Scandinavia.

To attain greater flexibility, Scandinavian universities look to developing CEE, which places the financial burden on the learner but enables more flexible CEE initiatives. The administration and organisation of CEE still constitute a minor role compared to regular BS.C. and MS.C. courses in Scandinavia. However, the interviewed universities articulate desires towards better administrative and incentive structures, ensuring

that CE will make up a more significant role on an institutional level in the future. Although CEE refers to two different levels of education across Scandinavia and Mexico, the mapping reflects a common goal with the development of CE in engineering. Not only does CEE secure upskilling for the individual learner and companies, but the significant role of CE in humanities, social sciences, and business may point towards a need for non-traditional competencies, such as business and communication skills. Those options are ideal for individuals seeking professional development in engineering. This change in professional profile through CEE will be examined in future work by the authors of this paper. At a meso level, both Scandinavian- and Mexican technical universities implement problem- and challenge-based learning to ensure the professional relevance of the courses offered to the participants. Collaboration with corporations is put forward as the way to ensure the relevance of CE in the upskilling of engineers and create the possibility for corporations to utilise CEE to implement problem-solving- and collaboration skills as a part of a professional profile. The need for collaboration put forward new demand for flexible CEE courses, fitting the schedule of companies and working adult learners. Both Mexican and Scandinavian universities put forward the use of digital- and blended learning and short formal and in-formal courses, such as micro-credentials, workshops, and flexible masters, to meet the demands for flexibility. At the Micro level, we observe that the tradition of "social purpose," in which CEE is a lever for empowerment and emancipation, has passed to a "*learning to earn money*", in which CEE is a lever for economic growth and global competitiveness. Perhaps this is why one of the trends in continuing education for engineers is to seek to develop knowledge and skills in business issues to complement the technical knowledge learned at the university. In that way, workers can potentiate opportunities to occupy senior management positions in corporate or possibly detonate their enterprises to generate jobs.

### Acknowledgment

The authors would like to acknowledge the financial support of Writing Lab and the Challenge-Based Research Funding Program, Grant no. IJXT070-22EG51001, both of the Institute for the Future of Education, Tecnológico de Monterrey, Mexico, in the production of this work.

### References

- Hughson, T. A., & Wood, B. E. (2020). The OECD Learning Compass 2030 and the future of disciplinary learning: A Bernsteinian critique. *Journal of Education Policy*, 0(0), 1–21. <https://doi.org/10.1080/02680939.2020.1865573>
- Nayak, J., Mishra, M., Naik, B., Swapnarekha, H., Cengiz, K., & Shanmuganathan, V. (2022). An impact study of COVID-19 on six different industries: Automobiles, energy and power, agriculture, education, travel and tourism and consumer electronics. *Expert Systems*, 39(3), e12677. <https://doi.org/10.1111/exsy.12677>
- Postgraduate and Continuing Education Programs | Tecnológico de Monterrey. (2022). <https://maestriasydiplomados.tec.mx/>
- Ratcheva, V., Leopold, T. A., & Zahidi, S. (2020). Jobs of tomorrow: Mapping opportunity in the new economy. *World Economic Forum*, 1–29.
- Zhang, S., Zhao, Y., Wang, R., Tao, Y., & Zhang, Q. (2020). Application of continuing engineering education talent training model and mixed learning model based on the construction of "Intelligent Chinese Academy of sciences" in lifelong education. 1307–1318. Scopus.
- Danskstatistik. Voksenuddannelser. <https://www.dst.dk/da/Statistik/emner/uddannelse-og-forskning/voksen-og-efteruddannelse/voksenuddannelser>
- UNESCO Institute for Statistics. (2016). Higher Education. <https://uis.unesco.org/en/topic/higher-education>

# A Case of a Special Interest Group on Industry-Coupled Problem-Based Learning for Transforming Engineering Convergence Education

Hyunmi Park

Hanyang University ERICA, Republic of Korea, [phm2000@hanyang.ac.kr](mailto:phm2000@hanyang.ac.kr)

Hyejeong Lee

Hanyang University ERICA, Republic of Korea, [gogolhj@hanyang.ac.kr](mailto:gogolhj@hanyang.ac.kr)

Jeonga Yang

Hanyang University ERICA, Republic of Korea, [yangalv@hanyang.ac.kr](mailto:yangalv@hanyang.ac.kr)

## Summary

Hanyang University ERICA (Education-Research-Industry Cluster at Ansan, Korea) has employed the Industry-Coupled Problem-Based Learning (IC-PBL) model for all engineering majors since 2017. IC-PBL differs from general PBL in that industry problems are directly brought and presented to students, and industry experts provide mentoring, feedback, and evaluations of students' problem-solving process and results. To facilitate professors to develop IC-PBL multidisciplinary convergence courses, we have established special interest groups (SIGs). From 2017 to 2022, a total of 13 SIGs were organized as part of convergence education research. From these, "G-Capstone Design: Convergence Technology in the Non-face-to-face Era" was selected as the best SIG case in engineering education. This case is meaningful in that it is a convergence between five majors and utilizes an online-offline convergence education environment. Furthermore, it has excelled in that it has expanded and connected the case of development and operation of convergence subject to interdisciplinary convergence research projects of national research institutes and connected learners to careers through their participation as researchers. Through this case, we would like to share the innovation and development direction of engineering convergence education.

**Keywords:** engineering education, PBL (problem-based learning), IC-PBL (industry-coupled problem-based learning), SIG (special interest group), interdisciplinary convergence

**Type of contribution:** Best practice extended abstracts

## 1 Industry-Coupled Problem-Based Learning (IC-PBL)

Problem-based learning (PBL) is a student-centered teaching approach in which students learn by solving a real-world problem (Barrows, 1996). Specifically, students foster problem-solving and collaboration skills by working on an authentic problem in a group (Hmelo-Silver, 2004). According to social demands emphasizing problem-solving skills, PBL is being applied in various disciplines, including engineering, medicine, humanities, and design (Park et al., 2020).

Hanyang University ERICA (Education-Research-Industry Cluster at Ansan, Korea) introduced the IC-PBL model to all majors in 2017 with the educational goal of strengthening students' creative convergent problem-solving skills. IC-PBL stands for industry-coupled problem-based learning, which can be differentiated from general PBL in that industry problems are directly brought and presented to students,

and industry experts provide mentoring, feedback, and evaluations of their problem-solving process and results (Kim et al., 2022).

## 2 IC-PBL Special Interest Group (SIG)

The IC-PBL special interest group (SIG) is a research community of professors with a shared interest in developing multidisciplinary convergence IC-PBL courses. The research period of the SIG is six months. Professors regularly meet to determine the course's title, objectives, and scope and develop problem scenarios. In addition, comprehensive IC-PBL courses, such as learner team formation strategies, instructor team teaching strategies, and evaluation methods have been designed. At Hanyang University ERICA, a total of 13 IC-PBL SIGs were held from 2017 to 2022 with 37 professors participating. Six of the 13 SIGs were related to engineering.

Table 1: List of IC-PBL SIGs for developing interdisciplinary IC-PBL subjects

No.	Year	Departments	Research topics	Subjects
1	2018	Software, Engineering	Development of a fundraising robot to spread donation culture	Intelligent robot crash lab
2	2018	Software, Engineering	ROS: Education on using embedded the Linux-based robot software platform	Embedded operating system
3	2018	Business, Engineering	Industrial production process analysis and improvement plan	Smart factory simulation
4	2019	Engineering, Pharmacy, Software	Fostering ICT/AI convergence talents for innovation in the bio-medical industry	R&D industry in the era of the fourth industrial revolution
5	2020	Engineering, Business, Design, Software, Science	OPEN Education-Research Practice for Cultivating Convergence Talents	G-capstone design: convergence technology in the non-face-to-face era
6	2021	Software, Engineering	IC-PBL+ course development for artificial intelligence-based earthquake early detection method development	Artificial intelligence analysis for disaster response

## 3 A best case of IC-PBL SIG: G-Capstone Design

### 3.1 The course design

The IC-PBL SIG called G-Capstone Design aimed to design an innovative curriculum that combines software engineering technology for on-site service and business management for marketability. As shown in <Table 2>, five professors from different majors designed the graduate-level convergence curriculum for teams of graduate students from various majors to carry out industry problem-based projects for developing innovative problem-solving skills.

Table 2: Participants of SIG for G-Capstone Design

Professors	Affiliated majors	Lecture areas
1	Electronic engineering	Robot design
2	Ocean science	Acoustic signal processing
3	Software engineering	Software design
4	Business management	Management

5	Visual communication design	UI, UX
---	-----------------------------	--------

SIG research activities were conducted through nine research meetings for six months from September 2020 to February 2022. <Table 3> shows the contents of research activities and the progress of the course design.

Table 3: Research activities

Rounds	Major topics	Contents
1	P-school planning Kick-off meeting	Confirmation of application platform and operation method -A new platform with enhanced interaction -Graduate school first semester or 1-year course using the capstone design method
2-6	Major search for curriculum planning and detailed planning (internal university members)	Major seminar for course convergence - Topic lectures on major areas by 5 participating instructors - Seminars by inviting experts in related industries
7	P-school interim reporting session Opening of new courses	Interim report SIG research process, goals, progress sharing, and feedback Application to open the course in the first semester of 2021 Course name: G-Capstone Design (Fusion Technology in an Untact Society)
8-9	P-school interim reporting session Opening of the new course	Contents of the 6-week educational program made by each of the participating professors Confirmation of detailed contents Submission of a final educational program

### 3.2 The course implementation

For the G-Capstone Design course, Hanyang University Hospital was selected as the industry, and Professor Ji of the Department of Otorhinolaryngology participated as an industry expert. The course was operated for 2 hours of theory and 2 hours of practice in the spring semester of 2021, in which students developed medical robots through convergence technology in the non-face-to-face era. A total of 12 graduate students participated in the class (four design majors and eight science and engineering majors). Lectures were conducted by three professors participating in the SIG and an online-based team teaching format using ZOOM was employed. Additionally, practice, field visits, and project execution were conducted offline. The composition of the course operation according to the IC-PBL stage is shown in <Table 4>.

Table 4: Course implementation

IC-PBL steps	Week	Contents	Operation methods
Understanding the problem (lecture)	1–2	Orientation & identify a problem Assemble the project team & plan the project Lectures on creative thinking to derive ideas	Zoom online lecture
Theory (lecture)	3–6	Android-based web programming lecture Design thinking "Temi" robot features a lecture Do It Process lecture to establish a business model	Zoom online lecture
Solution Presentation	7–8	Presentation of five ideas per team Confirmation of final idea by revising and supplementing	Zoom online presentation Faculty evaluation



Practice	9–15	Acoustics theory and practice lecture Robotics basics and Arduino practice Carrying out the project	Practice in a designated classroom
Final evaluation and reflection	16	Final presentation	Zoom online Presentation Faculty evaluation

Until the eighth week, the students analyzed the presented problems, took online practice theory lectures, and prepared for the interim presentation. During this time, they visited university hospitals, mid-sized hospitals, and small private hospitals and explored the pain points of doctors and patients through user research. A survey of specialists was conducted to derive the components of the medical robot system in the non-face-to-face era, focusing on the functions that can be used by existing robots and those required for medical robots. The students presented the role of the robot and the design of the medical environment for using the robot from reservation to inquiry, medical treatment, and finally prescription. Professors provided feedback for realization through the midterm evaluation and suggest concrete solutions in the final evaluation and presentation

### 3.3 The course result

As a result of the G-Capstone Design course, students developed a remote-control robot service scenario that can be applied to a telemedicine environment. Professors and industry experts evaluated that while students developed service scenarios using the “Temi” robot well, it was desirable to implement only simpler and more useful robot functions. As for the students' main opinion on the course results, it was possible to improve the digital change of the medical market, and the on-site understanding and the role of the robots is also essential, but based on user research, they found that it was essential to reflect the difficulties of non-face-to-face situations between patients and medical staff.

The results of this course are meaningful in that they are valuable in to universities, students, and society. First, from the university perspective, this course contributed to fostering talents who can cultivate the convergence thinking required by the current society combining knowledge and ideas from the five departments. Second, from the students' perspective, a sense of learning achievement was encouraged by applying their proposed service robots as solutions to industry problems. In addition, as the results of education were extended to research fields, students had opportunities to participate in research and write papers. Third, from the social perspective, this course provided direct and immediate problem solutions to the industry by developing a remote-control service scenario for non-face-to-face treatment using robots.

## 4 Implications of G-Capstone Design for fostering convergence talents

### 4.1 Convergence between five majors

This SIG project took the development of convergence subjects to instruct advanced convergence talents aiming for future technologies that converge software, design, and management fields in the fields of science and technology. The majors of electronic engineering and marine engineering, which can actively utilize information and communications technology, were set as application areas. The majors of software engineering, design, and business administration are meaningful in convergence education in providing not only convergence knowledge and technology but also technology-based service, aesthetics, and marketability as educational content.

### 4.2 Convergence between the online and offline educational environment

The class consisted of theory and practice: theory was conveyed via online lectures, and the site visits and practice were designed by an offline team. It is excellent that the online/offline environment was converged

and operated according to the characteristics of the contents of the convergence class and the activities of the instructor and the learner.

### 4.3 Expansion into national research projects

By expanding the SIG Convergence Curriculum Development Research, this SIG was selected for the “Interdisciplinary Convergence Research” of the 2021 National Research Foundation of Korea's Balanced Academic Development Support Project. This is significant in that subject research has expanded to a national-level study that can propose a model for interdisciplinary subject convergence.

### 4.4 Career advancement for students

Through “Interdisciplinary Convergence Research,” the scope of research to the aspect of cultivating student careers was expanded. There were outcomes in which students who participated in the education went on to postdoctoral programs or were hired as researchers. It is meaningful that the outcomes of the class differ from other cases in that it is helpful for students’ careers and advancement.

## 5 Conclusion

Due to COVID-19, convergence of new technologies is needed. Because technology advances rapidly, it is impossible to keep up with social demands unless the paradigm of university education changes. To adequately prepare for the era of the 4th Industrial Revolution, it is essential to develop convergence subjects that aim for exchanges between various disciplines. Nevertheless, several barriers exist.

First, there are difficulties for professors to set the scope of team teaching for convergence subjects. For curriculum development and operation, it is necessary to secure joint research time for continuous discussion among participating professors.

Second, identifying the exact needs of the field to solve IC-PBL problems is very difficult for students. This issue could be solved to some extent by visiting the site. For industry-coupled PBL operation, it is necessary to provide sufficient opportunities for students to investigate and observe the field in-person.

Third, this case was limited to the conceptual design level because there was not enough time to run the hardware design course within one semester. It is necessary to improve the academic system so that long-term convergence projects at the university level can be carried out and classes with a high level of implementation can be operated.

## 6 References

- Barrows, H. S. (1996). Problem-based learning in medicine and beyond: A brief overview. *New Directions for Teaching and Learning*, 68, 3–12. <https://doi.org/10.1002/tl.37219966804>
- Hmelo-Silver, C. E. (2004). Problem-based learning: What and how do students learn? *Educational Psychology Review*, 16(3), 235–266. <https://doi.org/10.1023/B:EDPR.0000034022.16470.f3>
- Kim, Y., Kim, C. M., & Park, K. (2022). A study on IC-PBL (Industry-Coupled Problem-based Learning) and learning performance measurement in higher education institutions. *Korean Business Education Review*, 37(6), 101–131. <https://doi.org/10.23839/kabe.2022.37.6.101>
- Park, H., Lee, H. & Jang, J. (2020). Case study on design and implementation of job training program based on one-day, one-problem approach. *Korean Journal of Human Resources Development*, 23(2), 139–167. <https://doi.org/10.24991/KJHRD.2020.06.23.2.139>

# Work-In-Progress: Reforming Engineering, Science and Technology Education in Kenya

Leonidah Kerubo

Professor, Faculty of Science and Technology, University of Nairobi, Kenya, [lkerubo@uonbi.ac.ke](mailto:lkerubo@uonbi.ac.ke)

Thomas Ochuku Mbuya

Professor, Faculty of Engineering, University of Nairobi, Kenya, [tmbuya@uonbi.ac.ke](mailto:tmbuya@uonbi.ac.ke)

Erastus Abonyo

Architect, Faculty of Built Environment, University of Nairobi, Kenya, [e.o.abonyo@uonbi.ac.ke](mailto:e.o.abonyo@uonbi.ac.ke)

Marc Zolver

Foreign expert, Directorate of University Advancement and Institutional Development, University of Nairobi, Kenya  
ExpertiseFrance, AFD group, France, [marc.zolver@expertisefrance.fr](mailto:marc.zolver@expertisefrance.fr)

## Summary

Kenya is among the leading economies in East Africa but faces challenges, nationally, such as high demography, low access to Education, inadequacy between educational programs and the job market, and internationally, such as the climate change and its dramatic impacts. To tackle these multiscale challenges, Kenyan higher education institutions are committed to transforming their academic framework.

In particular, the University of Nairobi (UoN), top-first in Kenya, launched a strategic plan with a specific focus in Engineering, Science & Technology (ES&T). Its concretization is threefold: **enabling infrastructures** by constructing innovative buildings; **systemic transformation** by upgrading programs, embedding societal stakes, strengthening multi-disciplinarity, supporting innovative and entrepreneurial spirit; **enhanced companies' involvement** in governance and strategy, Education, Research and Innovation.

UoN will blend its experience and practices with the ones of its international partners, such as from France amongst others. It will define achievable objectives and indicators to monitor and assess this transformation. Aware of the **risks and challenges**, UoN expects to increase its impact on civil society to tackle the economic and environmental challenges and increase its graduates' employability and impacts at regional and international levels. The UoN initiative shall place the university at the forefront of ES&T Education developments in Africa.

**Keywords:** Enabling infrastructures, Curriculum transformation, Industry-Academia linkage, Innovation, Higher Education in Africa.

**Type of contribution:** Best practice extended abstracts

## 1 Introduction

In East Africa, Kenya is one of the most stable and rapidly growing economies, regularly achieving more than 5% growth per year in the last decade (World Bank, 2022). In addition, like many other countries, Kenya is aware of the future dramatic impacts of climate change. To sustain its growth and to prepare for future challenges, a national strategic plan (Kenya Vision 2030) has been developed and is being implemented with a series of reforms in the economy, society and public policy. Split into 4-year-long medium-term plans, all sectors are addressed with clear objectives and indicators in, for example, infrastructures, ICT, Education,

public services, and labour market. In the (Medium term plan 2018-2022, 2018), there is a specific focus in higher and technical Education with the development of key programs in Science, Technology, Engineering and Mathematics (STEM), the empowerment of the National Research Fund, The National Commission for Science, Technology and Innovation, and the Kenya National Innovation Agency. One of the major targets is to increase Research and Innovation engagement up to 2% of the GDP.

Nevertheless, Kenya faces many challenges in its journey to becoming a middle-income, resilient and green economy by 2030. With 50% of its population under 20 years old, the pressure on the educational system and the job market is tremendous. The access rate to Higher Education remains low (up to 15%), and is accompanied by a high dropout rate around 10% per year. In addition, it is well known that the impacts of climate change will be dramatic worldwide but worse in Africa. Although Kenya wishes to develop its resilience and its economic capacities through ES&T, it has been reported by (Mukhwana et al, 2016) that there is low attractiveness of this sector, especially with regard to the training programs and the poor employability of its graduates as reported by (Federation of Kenya Employers, 2018) and (SOFRECO, 2019).

In response to these gaps, the Kenyan Higher Education sector is engaged in strategic reforms whose overarching goal is to promote the ES&T sector through improved infrastructures and implementation of relevant curricula developed in consultation with industry and societal stakeholders. In particular, UoN launched master and strategic plans (University of Nairobi, 2015-2018) that include specific attention to ES&T as key drivers for development and resilience. The plans interconnect 3 parts:

- **The infrastructure** by constructing a new innovative Complex, totalizing more than 30,000sqm, called the "Engineering & Science Complex" (ESC), where spaces and their distribution will play an active role;
- **A systemic transformation** of Education, Research and Innovation;
- **Enhanced industry-academia linkages** within the activities of the Complex.

International cooperation will be active, blending local experience and practices from UoN with the ones of its international partners, especially from France, where industry-academia linkages are well developed and efficient, namely CentraleSupélec (CS) from Université Paris-Saclay (UPSaclay), and the ParisTech group (PT). In addition, CS and UPSaclay have very recent experience in building new campuses, which shall benefit the UoN ESC. The whole project is supported by a sovereign loan for the construction, topped up by a grant for cooperation, both from the French Agency for Development.

## 2 Enabling infrastructure

Most university campuses are historic (some multi-centenary) and embedded in a classical vertical vision of Education and Science. In that vision, Education is rather a top-down process, from professors to students, and Science is structured in independent domains. University campuses follow this vision with separated and mono-function spaces and buildings. Education is well separated from Research, academia from administration and services, professors from students, even researchers from each other. In such configurations, multi-disciplinarity, interconnectivity and serendipity - amongst other best practices - are not welcome and need specific efforts to be effective.

However, many universities have adopted a new vision of cross-enrichment between people, activities and domains. They have created new, open and multi-functional spaces where creativity and serendipity are enabled, and new pedagogies take place. Some universities, such as CS in France (Figure 1), have even had the chance to reimagine and build totally new infrastructures adapted to the new practices. Such existing benchmarks and UoN internal and external stakeholders' consultations, led to the main driving principles for the architectural programming of the ESC with a shared core centre for Education, Research and Innovation, multi-connected and full-fledged flexible - with modular classrooms and sizeable amphitheatres, adaptable and multi-functional spaces - embedded in a multi-users and open innovation ecosystem. It includes a creativity centre (makerspace/fablab), a team-project platform, and incubation

areas. It hosts trans-disciplinary centres of excellence in key research areas for sustainable development, all together interweaving student's life spaces, services and administration.



Figure 1: benchmarked multi-functional building (CS, France, 2017).

The construction shall remain locally inspired and adapted (culture and climate), with green and sustainable certification, including a smart building management and maintenance through Building Information Modelling. After the (feasibility study, 2020) and UoN preliminary architectural works, international calls for tender will be published in 2023. The result is expected to become a regional and international benchmark, inspiring future campus development in Africa.

### 3 Systemic transformation

In conjunction with the new ESC, UoN proposes a challenging plan to engage people, faculties and students in an academic reform in the ES&T area. It is well known in our community that, in the challenging context of sustainable development, but in a more volatile, uncertain, complex and ambiguous world (Kamp, 2016), ES&T education requires new pedagogies, new practices and more societal stakeholders' involvement. UoN wishes to address this reform in systemic and multiple concrete ways through its Directorate for Advancement, the Faculty of Science and Technology and the Faculty of Engineering, by developing:

**Problem and Goal-based learning (PGBL):** actual curricula in ES&T, especially in Kenya, often remain too theoretical and far from the corporate world. They have a limited practical component and competence development. They also fail to keep pace with the ultra-fast life-cycle of technologies and sometimes fail to deliberately address the UN global sustainable development goals (SDGs).

Inspired by international examples, such as in North America (MIT in USA with its NEET program, McGill in Canada with its international bachelor), Europe (CS & PT in France with their strong corporate linkages, Aalborg in Denmark with its PBL approach), the UoN reform proposes stronger and deeper student's exposure to real-life and complex problems, especially industry-based and goal-based projects. This new PGBL approach mixes STEM with Social & Human Sciences, multi-cultural individuals and teams, in an agile approach that focuses attention to problem solving, stakeholders' concerns and client relation, uncertainties management, planning and business canvas, entrepreneurship, challenges and impacts.

The PGBL activities will be organized from week-long activities (possibly twice a year) with focused workshops and challenges (complexity, creativity, teamwork, SDGs awareness) to semester or year-long competitive and integrative projects. It will involve the UoN academic teams, helped by internal and external stakeholders from the public and private world, working with teams of students.

**Immersion with companies/organizations:** Students are often disconnected from the professional world. Hence UoN will multiply real experiences in companies and organizations through visits, placements and internships of different durations and levels along its programs, and possibly develop apprenticeship. The latter may be challenging in the local context, as it is mainly dedicated to technicians. However, developing higher-level apprenticeships (such as in France) may benefit both students and companies.

In addition, job-oriented competencies will be addressed specifically with student professional preparation, thanks to transversal professional workshops and tracks during their studies (such as entrepreneurship, project management, applied research, production and supply chain), where specific inputs from companies are expected to better prepare them for the job market.

**Innovation and Entrepreneurship:** the ESC and its activities will allow students and faculties to train and experience the concepts and processes involved in Innovation and Entrepreneurship. The new curricula will embrace the basics of Innovation and Entrepreneurship to be learned by most students, to advanced tracks, following up and coaching for the more mature and innovative individuals and teams, allowing them to create businesses and jobs further. The environment, open to students and faculties, will include classical fab lab/maker space (inc. rapid prototyping facilities), incubators for start-ups and their scaling-up, a transfer office to accelerate research outputs to the market, and will generate regional and international competitions and investments (hackathons, pitches, investors/business angels' meetings...). Based on local and international human resources, especially in cooperation with the Kenyan National Innovation Agency, CS and PT, a team will be set to develop and scale up this new transversal environment.

#### 4 Enhanced Industry-Academia linkages

UoN, and more generally, higher education institutions in Kenya, strongly believe in the added value of bringing companies and professional organizations inside the university. It is not only a key for financing activities but also a key to training the students more adequately for their future careers and to engaging faculties in transferring research to the market. By inviting companies within the ESC, physically by opening its spaces and intellectually by letting them participate in Education, Research and Innovation, UoN wishes to open up its programs and to generate synergies between the professionals, the students and the faculties. The companies, then strongly connected to their future human resources and to high academic resources, will have more opportunities to be active in Education, giving practical lectures and study cases, offering projects and placements, developing mentoring and coaching, and organizing events and visits. Companies will also be closer to Research, the Centres of Excellence and be engaged in their activities. They will be in position to benefit, mobilize and support teams and PhD programs through chairs and scholarships, and they will be invited to sustain the value chain of innovation from labs to market. The students will in turn develop their competencies and employability and, together with faculty members, be more connected to innovation, the job market, the economic and societal challenges.

Professionals from the companies and stakeholders from civil society will be invited to the governance of the ESC, especially in its Management Board and its Advisory Committee. This involvement aims to impact on the strategic orientation of the ESC and its teams and give inputs from the external and challenging world to the content of studies, better balancing knowledge, competencies (hard and soft) and employability. Eventually, executive Education and Lifelong Learning will link professionals and academics. On the one hand, the ESC will develop a needs-oriented executive Education, for better professionals and, at the same time, leveraging resources. On the other hand, the ESC will propose Lifelong Learning to individuals to accelerate and multiply its impact on the Kenyan society, from the youngest to the eldest.

#### 5 Monitoring and assessment

UoN is initiating a long-term challenging and ambitious transformation in ES&T to enhance its capacities and its impacts on society. To follow it up correctly and timely, UoN is developing a quality assurance scheme where the activities are discussed, defined and controlled. The scheme involves a "project team" under the authority of the Vice-Chancellor, with leaders and experts with specific roles and duties, a project documentation with all the processes and their acknowledgement, the chronogram of the ESC and the accompanying reform, and the semester-based budget. The breakdown follows six dimensions with the design and construction of the ESC, its governance and business plan, the curricula development, the research activities, the industry-academia linkages and its internationalization. Objectives and Key parameters follow the breakdown and are yearly defined, controlled, and possibly corrected. Being a public entity, UoN is subject to controls and audits from the Kenyan National Treasury and the Ministry of Education, and AFD, as the main funder.

## 6 Risks and challenges

UoN strongly believes in the values of the reform for its own development and for the one of Kenya, but remains aware of the risks and challenges. A recent study (McGowan et al., 2022) identified key questions for the success of such reform as follows:

**What are the drivers of the initiative, and how is it accepted?** Academics, who may consider the approach as top-down, may develop some reluctance against the project. However, on the one hand, the facts about the national economic situation and its sustainability are convincing enough to believe in the necessity of reform. On the other hand, UoN is trying to identify and empower local "champions" within the faculties. These champions will be key to connecting the governance of the project to the actors.

**Does a shared vision exist amongst the stakeholders?** The importance of an existing shared vision is well known in Project Management. Since 2019, UoN has run meetings and participative workshops to build and share this vision, mostly with the internal stakeholders. A new phase started in 2022 to engage with external stakeholders, namely the corporate world, which will have a key active role.

**Are resources and incentives correctly anticipated?** A good part of the project falls under the French Agency for Development funds. The sovereign loan for the construction and the grant for cooperation with French institutions are the two main financial instruments. UoN will also develop its participation in international calls, such as the European programs. Partnerships and donations from organizations and the business community will also be crucial. In addition to funds, UoN will develop professional incentives for faculties and staff, such as teaching recognition, training programs and international mobility, accelerated career evolution...

**What will be the transformative learnings?** At the end of the day, in addition to enhancing student employability and impact, the project shall bring better and new know-how and competencies to the university's human resources. Lessons will be learned during the long-term transformative process and will be capitalized in order to make the whole university a "learning and entrepreneurial university".

The UoN project team does not underestimate these risks and challenges. This is why this work-in-progress paper is aiming at sharing the UoN experience, attracting interest and generating debate on this quasi-unique initiative of excellence in Africa. The ESC itself and the cross-enrichment between local practices and international ones are expected to be very productive and fruitful and hopefully efficient and impactful. Lessons learned and added values shall be many and worth to be studied and compared with other projects of this kind amongst our universities.

## 7 References

- Executive Committee. (2018). 2018-2022 Medium-term Plan Proposal. In *XXXVIII Regular Meeting of the Executive Committee*. Retrieved from <http://vision2030.go.ke/publication/third-medium-term-plan-2018-2022/>.
- Federation of Kenya Employers (2018). *Skills Mismatch Survey Report*. Retrieved from <https://fke-kenya.org/>.
- Kamp, A., (2016). *Engineering Education in A Rapidly Changing World*. Delft University of Technology Press.
- Kenya, Republic of (2008). *Kenya Vision 2030: First Medium Term Plan 2008-2012*. Nairobi: Ministry of Planning, National Development and Vision 2020, Nairobi.
- McCowan, T., Omingo, M., Schendel, R., Adu-Yeboah, C., & Tabulawa, R. (2022). Enablers of pedagogical change within universities: Evidence from Kenya, Ghana, and Botswana. *International Journal of Educational Development*, 90, 102558.
- Mukhwana, E., Oure, S., Kiptoo, S., Kande, A., Njue, R., Too, J., & Some, D. K. (2016). State of university education in Kenya. *Commission for University Education: Discussion Paper 04*. Nairobi, Kenya.

SOFRECO (2019). *Labour Market Study in Kenya*. SOFRECO. Retrieved from [https://www.sofreco.com/UK/formSelectReference.awp?P1=EN\\_D034\\_ZXXX\\_PXXXXX\\_BXXX\\_L001&P2=projects-sofreco-vocational-training](https://www.sofreco.com/UK/formSelectReference.awp?P1=EN_D034_ZXXX_PXXXXX_BXXX_L001&P2=projects-sofreco-vocational-training)

University of Nairobi (2015). *Master plan 2015-2035 & strategic plan 2018-2023*. Retrieved from <https://edufoundations.uonbi.ac.ke/sites/default/files/CEES-STRATEGIC-PLAN-2018-2023.pdf>.

World Bank (2022). *World Bank Kenya Overview*. Retrieved from <https://www.worldbank.org/en/country/kenya/overview>.



# Tracks: Impactful reform for flexible adaptable education

Mattias Bingerud

Chalmers University of Technology, Sweden, [mattias.bingerud@chalmers.se](mailto:mattias.bingerud@chalmers.se)

Mikael Enelund

Chalmers University of Technology, Sweden, [mikael.enelund@chalmers.se](mailto:mikael.enelund@chalmers.se)

Kristina Henricson Briggs

Chalmers University of Technology, Sweden, [kristina.henricson.briggs@chalmers.se](mailto:kristina.henricson.briggs@chalmers.se)

Anna Karlsson-Bengtsson

Chalmers University of Technology, Sweden, [anna.karlsson-bengtsson@chalmers.se](mailto:anna.karlsson-bengtsson@chalmers.se)

Johanna Larsson

Chalmers University of Technology, Sweden, [johanna.larsson@chalmers.se](mailto:johanna.larsson@chalmers.se)

## Summary

In this contribution we discuss the progress and achievements of the first three and half years of the Tracks initiative for reformed education at Chalmers University of Technology. In Tracks, the education is designed to give students opportunities to develop inter-disciplinary competencies and to follow individualized study tracks. The purpose of Tracks is also that Chalmers, in collaboration with strategic external partners, shorten the lead times for changing the education to embrace new technologies, emerging materials and concepts and to offer a meeting place for education, research, industry, and society. Three and a half years into the initiative, we conclude that the initial intentions have been achieved. In addition, the project brought unexpected positive effects in, e.g., terms of opportunities for newly recruited faculty and collaboration with sports associations and athletes.

**Keywords:** interdisciplinary education, educational development, agile development, industry involvement

**Type of contribution:** Best practice extended abstract

## 1 Introduction

Chalmers University of Technology (hereafter “Chalmers”) primarily offers program-based education in engineering, science, business, shipping, and architecture, from bachelor’s to master’s and doctoral level with about 11,000 full-time students. The program portfolio includes 3-year BSc in Engineering, and 5-year MSc in Engineering and MSc in Architecture, and 2-year international masters’ programs. In February 2019 Chalmers launched Tracks, a ten-year long initiative for reformed learning and learning environments. The basic idea of Tracks is to offer opportunities for students, faculty, and external stakeholders to meet, learn and co-create across disciplinary boundaries (cf. the New Engineering Education Transformation (NEET) at MIT (Crawley, Hosoi & Mitra, 2018)). An essential part of Tracks is project-centred learning supplemented with short on-line modules that provide teaching and training in professional skills, covering project management, working in interdisciplinary teams, critical thinking, innovation, ethics, and equality. Chalmers’ organization have identified three, inter-connected, trends that are likely to affect the university’s role in society:

- Complex societal challenges with greater demands on competence to work across disciplinary boundaries,
- Changed expectations of and on students, including lifelong learning, and
- Shorter lead times for (digital) technology development, and emerging new materials.

To respond to these trends, the aim of the first three-year phase of the Tracks project was:

- To create an offer of inter-disciplinary courses, open for all students at Chalmers. The courses should prepare students to contribute to the solution of today's and future complex societal challenges. 300 students should be enrolled in the courses per academic year.
- To develop all courses within Tracks in close cooperation with research, and industry and society.
- A process to swiftly change course content and learning outcomes.
- Support to faculty to teach in an interdisciplinary setting and in using physical and digital learning environments for active learning.
- To create learning environments for active collaborative teaching and learning.

Drawing on the experiences of the management group of the initiative, this paper will describe the progress and achievements of the first three and half years of the Tracks initiative. The impacts on students and faculty and how Tracks is used to collaborate with industry, society and academia will be exemplified and discussed.

## 2 Status of development and implementation

The education within Tracks is primarily delivered as elective courses which allow students to create their own study tracks based on their interest, complementing the rather strict program-based format outside Tracks. To avoid disciplinary barriers and to ensure that Tracks is open to all students and faculty regardless of organizational affiliation, Tracks courses do not belong to any specific programme, school, or department.

Tracks courses are proposed by faculty in an open application process. The courses must be linked to current research and/or societal challenges, be open to and attract students from several educational programs and disciplines, contain inter-disciplinary projects that require different competencies from the students, and have teaching teams with teachers with different backgrounds and competencies. Courses can also be added through requests and suggestions from industry, society, and academia.

A Tracks course needs to guide students through an entire development process, from needs and ideas to a model or prototype in an implementable condition that can be evaluated. Such models or prototypes may consist of a service, an algorithm, a product, or a concept that can be physical or digital. The courses are, thus, platforms for training development methodology, developing professional engineering skills as well as to deepen science, math, and technology knowledge. A major part of the learning in Tracks occurs through inter-disciplinary projects that require contribution from students with different competences, both self-directed during project work and as planned activities in which students teach peers on their subject area. Additionally, all courses have external stakeholders that the students need to interact with which contributes to develop their inter-disciplinary abilities.

A Tracks course is guaranteed to be delivered at three occasions, after that the future of the course is evaluated. The course could either be granted a new round within Tracks, be discontinued, or be transferred as whole or in part to the ordinary program-based course offer. Hence, Tracks is not only a state-of-the-art course palette but also a system for developing new program courses to develop the programs.

The initial strategy was to develop the Tracks concept and implement it into the education system simultaneously and focus on early incremental developments. To accomplish this, a flexible and agile management structure (Enelund & Henricson Briggs, 2020) was set-up and external stakeholders were involved in an advisory board to provide advice and input and to verify that development is continuously relevant to industry and society.

Tracks courses cover a wide range of subjects, from research-related courses such as *Building and programming a quantum computer* to society-oriented courses such as *Technology, politics & the society*. A particularly relevant set of courses is *Emerging energy technologies* comprising five courses. These are *Solar energy: From photons to future societal impact*, *Carbon capture, utilization and storage - A path towards negative emissions*, *Fuel cell systems*, *Structural battery composites: Realization and multifunctional performance*, *Rechargeable battery systems and Batteries: From materials to manufacturing*. The complete Tracks course catalogue can be found at ([Current courses within tracks](#)). Still after three and a half years, there is a steady influx of new course proposals.

Another part of the Tracks initiative is a learning environment for design, build and test, and experimental learning. This learning environment is called Chalmers Fuse (hereafter “Fuse”), a name that reflects the environment's cross-border activities where actors from different programmes, disciplines and sectors are integrated to learn, develop, research, test and innovate. Fuse is a 2000 square meters makerspace and innovation lab, and a meeting point for education, research, industry, and society. Fuse has workshops for metal, wood, surface treatment, electronics, textile and rapid prototyping, studios for film, sound and VR, computer lab and physiology lab as well as project and study spaces and a large event hall. Tracks courses are given the highest priority to use the learning environment, but it is also available to other courses and projects, subject to availability. Fuse was designed and set-up in collaboration with students and is maintained by staff together with the student association T-RAX. T-RAX has the responsibility for Fuse after school hours and during weekends. The board of T-RAX consists of seven students from different programs. They all have licences to operate the machinery and hold training courses for other students. Moreover, they assist start-up companies in making models and prototypes and help the staff in Fuse during periods of heavy workloads. Students in Tracks courses use Fuse extensively. In addition, there are weekly events with external visitors and collaborative projects, such as partnership events, Hackathons and challenges, workshops, school visits, as well as design, build and test events for start-ups.

### 3 Impact and responses

#### 3.1 Students

The first Tracks course was taught in April 2019 with 12 pioneering students. The number of courses has since increased to 29 and the number of students that have taken a Tracks course is about 850 in November 2022 out of which 345 in the final year of phase one. Overall, the courses have had students from all Chalmers master's programs and almost all undergraduate programs but also PhD students, alumni, and professionals.

Most students choose Tracks courses either as electives within their program or as extracurricular courses. Student feedback has so far been very encouraging and reaffirms the concept. Students appreciate to collaborate with other students, alumni and faculty from different disciplines and backgrounds that have similar research and societal interest. The courses get very high evaluation rates in course surveys, e.g., in the spring semester 2022 the mean value of overall impression was 4.6 out of 5. A free-text comment that illustrated this result was “I loved it! I learned so much from this and my thinking was always challenged in a good way. I have gotten a whole new way of thinking that I don't think I could have gotten without this kind of work.”

#### 3.2 Faculty

Tracks provides an education platform and resources that enables faculty to be very creative in developing interdisciplinary learning experiences. The open call process for faculty to suggest new courses offers possibilities to propose courses connected to teachers own research or their personal or societal interest as well as testing of pedagogical ideas. This has been an attractive opportunity especially for recently recruited faculty who might otherwise have had difficulties to get their own course in the rather immobile program-

based education system. For new faculty to get to know students and interest them for their research and ultimately recruit students for master's theses and doctoral studies is an appreciated possibility.

The teachers have come from all Chalmers departments, and during the academic year 2021/22 there were 40 external participants in the form of guest lecturers, supervisors and clients from academia, industry, and society. In Tracks, teacher teams consisting of faculty without prior relationships have evolved around the common interest in a certain theme or problem. Sometimes this has happened deliberately through matchmaking and sometimes the teams have formed spontaneously. This has led to (un)expected spin-off effects such as new research collaborations forming new research questions.

The Tracks leadership team together with a specialist in university teaching have structured evaluation meetings with all examiners in Tracks courses. In general, the teachers are very satisfied with the format but report difficulties with individual grading in team projects and supervision of teams with different backgrounds. Teams consisting of students with different academic levels has been a particular challenge. In order to support faculty to deliver courses in the Tracks format there are on-line modules on professional skills aimed at both faculty themselves and students. In addition, Tracks has individual coaching, support in writing papers for educational conferences, and thematic workshops on topics such as individual grading in student teams and constructive alignment.

### 3.3 Industry and society

Chalmers has intense collaboration with industry and has an always ongoing discussion with strategic industry partners on educational issues such as new important subjects and areas, lifelong learning and collaboration on BSc and MSc projects. With regards to Tracks, industry has expressed great satisfaction with, and see great benefit in, the outcome of Tracks, in particular that the students graduate well prepared for a career where interdisciplinary teams are the norm. They are also very satisfied that they have been welcomed to co-create and suggest new courses, and that their employees can take part as clients, teachers, and course participants. One example is the creation and teaching of courses within fuel cell and battery systems which went from idea phase to course start in three months. In these courses, professionals from Chalmers' partner companies participated together with, and on the same conditions as, ordinary students in mixed teams. This was very well received by both by professionals and students. There is also a strong collaboration between Tracks and Swedish sports associations such as the Swedish ski association, the Swedish athletics federation, and the Swedish swimming federation, with whom we can design student projects regarding physiology, equipment analysis and development, and who also have great interest in collaborating on research projects in which we share and analyse massive amount data, e.g., from the Fuse physiology lab where elite athletes can test their limits and evaluate their technique using high end technology. Moreover, Fuse is an asset for Chalmers in collaboration with elementary and high schools and has been used in events designed to increase the interest in STEM education.

## 4 Findings and discussion

Research on Tracks has indicated that the interdisciplinary study experience created within Tracks may be challenging to students that are not used to open problem- and solution spaces (O'Connell et al., 2022). Students, e.g., experienced difficulties and frustration when formulating a project idea. However, in many cases, these difficulties also inspired students to develop "effective collaborative coping strategies, leading to progress and learning." (p.10) This points towards the need to enable students to engage in real collaborative work and to find balance within Tracks to support students in learning new skills while also providing real "desirable challenges" (O'Connell et al., 2021). These considerations also open for thinking about the diversity in how students experience and are affected by the Tracks initiative, both in relation to their personal identities and to their educational background. The right balance of challenge and support is different for every student and thus needs to be considered in relation to the student body that is choosing Tracks. An analysis of the material used to recruit students found that the tracks student is "described as

simultaneously especially employable and especially committed, for example to solving real problems on the level of society and with an impact on the future" (Larsson and Johansson, 2022, p. 4). These ways of appealing to students may hold contradictions in relation to diversity since concepts such as excellence and brilliance may carry certain connotations. However, there is also great potential in that Tracks is offering students that are on non-traditional study paths alternatives to the streamlined program structure. Two ongoing research projects connected to Tracks are in the process of investigating these issues further.

In conclusion, three and a half years into the project, Tracks has delivered as planned. Using Tracks, Chalmers can offer interdisciplinary education linked to current research and societal challenges to students from different programs, disciplines, and backgrounds and with teacher teams consisting of faculty from different disciplines and with external stakeholders. The flexibility in the Tracks format has been exploited to swiftly start new courses with the aim to embrace the rapid technological development and the demands from industry regarding, e.g., electrification and digitalization. Tracks' learning environment Fuse has been established as a home for the Tracks courses and a meeting place for research, education, and external partners.

Unexpected positive outcomes include that newly recruited faculty has found Tracks as an arena to teach, develop and merit pedagogically as well as to recruit students. The sports associations and athletes have discovered Tracks and especially Fuse, which has resulted in new projects and collaborations as well as in publicity and marketing of Chalmers in new channels. The admission of professionals to Tracks courses and mixing them up with program students has become a successful part of the professional education at Chalmers. Finally, students testify that through Tracks they have had the opportunity to innovate, evaluate, test, and improve innovations. Many students have also obtained jobs at partner companies or have been recruited as thesis workers and doctoral students.

## 5 References

Crawley, E. F., Hosoi, A., & Mitra, A. (2018). Redesigning Undergraduate Engineering Education at MIT – the New Engineering Education Transformation (NEET) initiative. *ASEE National Conference & Exposition. Salt Lake City, UT, USA.*

Current courses within Tracks | Chalmers website. Retrieved February 21, 2023, from <https://www.chalmers.se/en/education/your-studies/select-courses/choose-a-tracks-course/#overview-all-courses>

Enelund, M., & Henricson Briggs, K., (2020). Tracks for Change, Flexibility, Interdisciplinarity and Creativity in Engineering Education. *Proceedings of the 16th International CDIO Conference, On-line.*

Larsson, J., & Andersson, J. (2022). Seeking the simultaneously socially committed, successful, and employable engineering student. *2022 IEEE Frontiers in Education Conference (FIE). Uppsala, Sweden.*

O'Connell, M. O., Adawi, T., Trefna, H. D., Ström, A., & Stöhr, C. (2021). Challenge Episodes and Coping Strategies in Undergraduate Engineering Research. *SEFI 49th Annual Conference: Blended Learning in Engineering Education: Challenging, Enlightening – and Lasting?. On-line.*

O'Connell, M., Stöhr, C., & Wallin, P. (2022). Using Challenge Episodes to Identify Social Regulation in Collaborative Groupwork. *18th International CDIO Conference Reykjavik, Iceland.*



## Creativity and Interdisciplinarity

# Perception of students in a transdisciplinary rural PBL model

Fernando José Rodríguez-Mesa

Universidad Nacional de Colombia, Colombia, [fjrodriguez@unal.edu.co](mailto:fjrodriguez@unal.edu.co)

## Summary

Rural education requires the use of learning models that facilitate the integration of its population into education. Torca's model of the PEAMA Sumapaz program at the Universidad Nacional de Colombia uses a transdisciplinary project-based learning (PBL) model to assist in undergraduate preparation during the first semesters in various academic programs. Students admitted to various academic programs makeup groups of 6 or more students. They carry out their learning in their subjects during the first four semesters and carry out a social project located with the intervention of the community of these areas. Project work faces challenges since each group member comes from different subjects and programs. This work presents the results of the project work during 2022, applying a 108 statements questionnaire to 34/47 students from the second semester. The PCA analysis reduces to 53 perception variables and eight components. The model shows that students learn from developing performance and commitment.

**Keywords:** Project-based learning, Humanitarian, Principal component analysis, culture, transdisciplinary

**Type of contribution:** Research extended abstract.

## 1 Introduction

The Universidad Nacional de Colombia designed the Special Program for Admission and Academic Mobility, PEAMA, in 2007 to support access to education in the Colombian border areas in Arauca, Leticia, San Andrés Islands and San Andrés de Tumaco. With this program, the University actively facilitates that inhabitants in those regions get professionals, developing the region of influence of these venues. Subsequently, in 2016 the University extended the program to the rural areas of its four main Andean campuses, Bogotá, Medellín, Manizales and Palmira. In Bogotá, the District Education Secretariat provides resources for this program.

The PEAMA Sumapaz program offers access to rural education in Bogotá to mitigate the rural and school difficulties of young people who pass secondary education. This program began in the populated centre of Nazareth in the Sumapaz paramo, located more than 85 km from Bogotá, about 3 hours away by conventional vehicle. It started with a project-based learning model explained in detail by Ordoñez et.al. (2017; 2020), and applied until 2021 inclusive. With this model, there are about 123 students, 39 still in the Peama while 84 have moved to Bogotá Campus (Peama Sumapaz, 2022).

In 2021 during the COVID-19 Pandemic, the program was extended to other rural areas of the district territory, first in Ciudad Bolívar and then starting in 2022 in the town of Torca north of Bogotá. This territorial expansion increased the academic offer from 10 programs to 14. Consequently, the PBL model changed from one that blends courses and projects to another with courses within the project. The Torca model uses situated transdisciplinary PBL, with the traditional principles of PBL models such as Aalborg's (De Graaff & Kolmos, 2003; Kolmos & De Graaff, 2015).. It includes the participation of students from various academic programs, professors of various specialties, and community actors. Therefore, it integrates various disciplines of basic sciences and engineering, social and agricultural sciences (Rodríguez-Mesa, 2022). The academic model has a project work with students from various programs, two facilitators and teachers. Its debut takes place beginning in 2022.

## 2 The Torca Model

In the Torca model, students carry out a project-work oriented by a set of problems of situated social origin. Students compose groups of 8 to 10 members. These members belong to different academic programs and therefore are studying different subjects. Each of them must achieve the Learning Outcomes of their subjects involved in the project. That constitutes the multidisciplinary feature of the project.

The problem is the starting point of knowledge, and it is real. Students must analyse a set of local problems whose solution process leads to propositional knowledge of the subjects. As each subject addresses different topics, during the problem analysis, students must include several relevant aspects, originating sub-problems connected in some way to each other. Students first address this aspect of problem formulation during the first five weeks of the 16-week term.

Three actors are involved in this process: the student, the teacher, and the local community. The students are the ones who carry out the analysis. The teacher's guide students about the problem from the point of the problem requirement for getting ILOS in their subjects. At the same time, the community is like an owner and potential user of the product outcome. The latter can be a person, group of people, local group, or association.

The students must interact with these two actors to formulate the problem and reach a process for the solution. As it is a formulation of problems, they must set limited objectives in time and the respective work methodology for the project. Then make the work report in the scientific format.

To facilitate relations with the community and teachers, the Torca model introduced two types of facilitators. The first is a facilitator to support transversal skills. The other is a chancellor, a facilitator to help formulate the problem regarding the community's needs, the student's abilities, and the problem's analysis.

The chancellor is a professional who can find social problems in the community, build relationships with members, and help in the relationship between the project group and the community. In addition, he should help students reflect on the problem and encourage any conversation with the actors involved while realising the solution to the problems formulated in the project.

The other facilitator is also a professional in charge of promoting the project's work and helping during the project's progress. In addition, this facilitator is also responsible for knowing the progress status of the project and keeping the teachers informed of the relevant aspects of the project during its completion.

## 3 Methodology

The Revealed Cultural Factors Questionnaire, QFR, collected students' perceptions about their project work. Data helps to find the predominant behaviour in the project work by Component Analysis, PCA. It has 108 cultural variables on a 5-point Likert (Rodriguez-Mesa, 2021).

The QFR was sent to 47 participating students from 14 second-semester programs to determine the predominant factors in the group, divided into eight project groups. In addition, the questionnaire was distributed online with the Google Forms tool, reaching 34/47 responses, with a Cronbach's alpha reliability of 0.97. These students are in economics, zootechnics, linguistics, philology, social work, anthropology, geology, agronomic, agricultural, civil, mechanical, electrical, electronic, and mechatronic engineering.

The data was processed using PCA, leaving 53 variables grouped into eight components. The results of the perception of the students' work are in Table 1. The columns show eight orientations that characterized the project work.



Table 1. Students' perception about their orientation of the project work of the Peama Sumapaz program according to the results of the PCA.

	Perfor.	Cohesion	Learn.	Commit.	Interdep	Teacher	Motiva.	Leader
Believes in be productive	0,98							
Trusted in the performance of the project	0,9							
Knew the objective goals of the project	0,86							
High performance	0,84							
Works with standards	0,84							
There was commitment	0,81							
The group is high-performing	0,81							
Were united	0,79							
Commitment	0,7							
Effectivity	0,7							
Roles	0,63							
Respect differences and contributions	0,63							
Try high quality	0,62							
Self-confidence	0,57							
Mutual Influence	0,54							
Very productive	0,52							
Understanding explanations		0,89						
Mutual support knowledge		0,85						
Received motivation		0,8						
Received explanations		0,74						
Reflected on ideas		0,71						
Communicate with social networks		0,69						
Work as a team with IT		0,68						
Support each other emotionally		0,61						
Learned from the course			0,89					
Define a real-life problem			0,86					
Help understand the solution			0,69					
Learned to work in groups			0,67					
had a function			0,57					
Personal interactions			0,55					
Strong commitment				0,83				
The project encourages course activities				0,71				
The report evidence and limits contribution				0,62				
Use knowledge from other courses				0,62				
Meet individual commitments				0,59				
The product reflects contributions made in class				0,59				
Non-focused on learning from partners				0,54				
Dependence from others					0,8			
Dependence to others					0,74			
Work as a team in all activities					0,7			
Not aware of the tasks					-0,68			
Commitments according to knowledge and abilities					0,61			
Focused on teaching others					0,53			
Grade scale Oriented						0,94		
Pass Oriented						0,9		
Working with teacher's pressure						0,81		
Work under pressure from others						0,59		
Work for non-academic reasons							0,79	
Work to maintain the reputation							0,78	
Working on a project is better than taking classes							0,54	
Having a leader								0,77
Work independently on the report and join themes								-0,66
Individual work helped partners								0,52

N=34/47, p=.73,  $\alpha$ =.91

## 4 Discussion

Rodriguez (2021) found, in 2017, using this same procedure, that the students of Peama 2017 in the previous PLB model had six orientations of group work: Collaboration, cohesion, teacher's orientation, dialogue and roles. It showed that cohesion was positively associated with collaboration, dialogue, and role but negatively with passing orientation. In Torca's Model, collaboration is the performance factor. It is positively associated with cohesion efficiency, interdependencies, and commitment but negatively with teacher orientation. The

first ones are coherent with group work, but the incidence of teachers is affecting the work. In Torca's model, teacher intervention affects the quality and collaboration of project work (Table 2).

Table 2. Correlation between group work orientation in Torca Model.

	Perform	Cohesion	Learning	Commitment	interdependence	Teacher	Motivacion	Leader
Performance	1	0,5	0,28	0,09	0,06	-0,26	-0,02	0,11
Cohesion	0,5	1	0,28	0,15	0,24	-0,28	0,05	0,14
Learning	0,28	0,28	1	0,13	0,18	-0,09	-0,08	0,13
Commitment	0,09	0,15	0,13	1	0,23	0,06	-0,16	0,06
interdependence	0,06	0,24	0,18	0,23	1	0,06	-0,03	-0,06
Teacher	-0,26	-0,28	-0,09	0,06	0,06	1	0,09	0,03
Motivation	-0,02	0,05	-0,08	-0,16	-0,03	0,09	1	0,01
Leader	0,11	0,14	0,13	0,06	-0,06	0,03	0,01	1

The group's performance exceeds the constructs of Katzenbach et al. (2001). In addition, students perceive that the product was produced productively, with commitment and distribution of roles.

Cohesion is a perception of carrying out group activities and achieving group objectives (see Carless & de Paola, 2000).

Learning in groups was characterized by the positive effect that the group had and the definition of the objectives of the problem, meeting with the model's goals.

The commitment component refers to a relationship between the project and the course. That is due to the students must include the class topics. According to the students, their product has shreds of evidence. That is coherent with mutual dependencies between the task during the problem analysis, which expends six weeks of work from different subjects. As this indicates, the students knew what each one had to do. Therefore, interdependence and commitment are mutually associated.

The orientation to the teacher indicates that the students worked under pressure and wanted to get a grade and pass the subject. Since the community intervenes in the model, there is additional pressure from the environment, that is, from the rural community.

Motivation is extrinsic, as indicated by the three factors. Reputation and non-academic appear as essential elements, perhaps because the students worked with rural actors involved in the project, which could be diverting attention towards the project tasks, as could be indicated by the negative association with commitment. However, this aspect needs further investigation.

Group work is leader-oriented. Relevant variables are the perception of leadership, task dependency, and that individual work helped with project work. Here it is not known if that leader was a member of the group or perhaps the chancellor or facilitator. The latter since the association of leadership with the other variables is low.

In Torca's model, teacher intervention seems to be affecting the performance and cohesion of project work. During project work, several teachers of different subjects make reflections with some group members, causing the project performance to decline, moving students thinking to other perspectives to the problem solution or process. While the students meet, they make process decisions. However, students with a traditional behaviorism background tend to change their minds since they feel pressure due to grades or passing subjects, as indicated by load values in the Table 1.

Finally, although the students worked on a project and found the solution, the PCA and the students' perception do not guarantee that they achieve ILOs for several subjects. Although this paper does not show students' grades, the teachers' reports evidence the acquisition of learning by subject.

## 5 Conclusion

The Torca model works for the project according to students' perceptions, meaning learning acquisition and problem-solving skills. In addition, the model integrates members from several disciplines.

Group members have performance, commitment, cohesion, task interdependence, and the desire to work for the community. At the same time, the presence of teachers in project work negatively affects project work.

These indicators require the completion of a confirmatory study and specific evaluation on the effects of the teachers and facilitators.

## 6 References

- Carless, S. A., & de Paola, C. (2000). The measurement of cohesion in work teams. *Small Group Research*, 31(1), 71–88. <https://doi.org/10.1177/104649640003100104>
- De Graaff, E., & Kolmos, A. (2003). Characteristics of Problem-Based Learning. *International Journal of Engineering Education*, 19(5), 657–662. <https://doi.org/0949-149X/91>
- Katzenbach, J. R., & Douglas. (2001). *The discipline of teams*. John Wiley & Sons Inc.
- Kolmos, A., & De Graaff, E. (2015). Problem-based and project-based learning in engineering education: Merging models. In D. Johri & B. M. Olds (Eds.), *Cambridge Handbook of Engineering Education Research* (pp. 141–160). Cambridge University Press. <https://doi.org/10.1017/CBO9781139013451.012>
- Ordóñez, C. L., Cortés, H. G., Sánchez, C. M., & Peña-Reyes, J. I. (2017). Práctica del Aprendizaje Basado en Proyectos de la Universidad Nacional de Colombia en la localidad de SUMAPAZ de la ciudad de Bogotá D.C, Colombia. In A. Guerra, F. J. Rodríguez, A. Kolmos, & I. P. Reyes (Eds.), *6th International Research Symposium (IRSPBL' 2017)* (pp. 53–64).
- Ordóñez-Ordóñez, C. L., Cita Triana, N. C., & Sierra López, L. P. (2020). PEAMA Sumapaz: cuatro semestres de aprendizaje basado en proyectos, ABP. *Boletín Pedagógico*, 1(1).
- Peama Sumapaz. (2022). *Archivo Administrativo Peama*. Universidad Nacional de Colombia.
- Rodríguez-Mesa, F. J. (2021). *Estudio de la creatividad en diseño en ingeniería en Aprendizaje Basado en Proyectos*. Universidad Nacional de Colombia.
- Rodríguez-Mesa, F. J. (2022). The Torca Experiment: A model of transdisciplinary project work. *International Symposium on Project Approaches in Engineering Education*, 12.

# Work-In-Progress: Tracking social regulation of learning in interdisciplinary group work

Michael O'Connell

Chalmers UoT, Sweden, [connell@chalmers.se](mailto:connell@chalmers.se)

Patric Wallin

Norwegian University of Science and Technology, Norway, [patric.wallin@ntnu.no](mailto:patric.wallin@ntnu.no)

Raffaella Negretti

Chalmers UoT, Sweden, [negretti@chalmers.se](mailto:negretti@chalmers.se)

Christian Stöhr

Chalmers UoT, Sweden, [christian.stohr@chalmers.se](mailto:christian.stohr@chalmers.se)

## Summary

Recent years have seen a growing interest in how student groups regulate their learning when taking part in collaborative and interdisciplinary project-courses that are increasingly becoming popular in Engineering Education programs. While there is a rich research landscape on self-regulated learning, more empirical studies are needed on social regulation of peer-learning in collaborative group work. This study addresses this gap by conducting a narrative comparative case study to document shared regulation in three student groups from three project-based courses. Qualitative data was collected through interviews with members from those interdisciplinary groups working on real world challenges. The interviews were analysed for regulation episodes and synthesised into narratives representing key aspects of the groups regulative behaviours. The results are expected to highlight numerous instances of social regulation of learning within the various groups' at different stages of the project. Preliminary results presented here demonstrate challenges faced by a group when attempting to socially regulate their learning, underlining the importance of scaffolding for collaborative learning. Findings from the full study will highlight the important role that social regulation processes play in group learning and add to the current understanding of the interplay between different modes of social regulation in groups.

**Keywords:** Social Regulation of Learning, Collaborative Learning, Interdisciplinary Groups, Socially Shared Regulation, Co-Regulation

**Type of contribution:** Research extended abstracts

## 1 Introduction

Current Higher Education (HE) initiatives increasingly emphasize the need to develop students' teamwork skills through interdisciplinary and intercultural group work. Collaborative learning activities in education can help to create learning experiences that are distinct from learning experiences in one-to-many lecture-based activities. Research has reported positive effects of collaborative learning (e.g., Johnson & Johnson, 2009), however it is important to consider the general structure within collaborative learning activities. In engineering education, larger, semester based, collaborative learning activities are increasingly designed as project work where students work in groups on specific, oftentimes, authentic problems over several weeks (Gavin, 2011). This approach emphasises peer-learning, in active and self-regulated forms (Gavin 2011). Peer-learning encompasses a wide variety of educational strategies and activities, focusing on learning through active help and support among learners with equal status (Griffiths et al., 1995). In this way, peer-learning moves the focus from independent learning towards interdependent learning, where students develop skills

to plan, organise, work, and evaluate their learning together (Boud, 2001). However, for effective collaborative learning to take place, groups must engage in both the co-construction of knowledge and social regulation of learning (Summers & Volet, 2010).

Regulation of learning refers to activities such as planning, goal setting, evaluation, and self-instruction and requires learners to view their learning as dynamic, a process that they can take control of, as opposed to learning being something that happens to them as a result of teaching practices or their environment (Zimmerman, 2015). In terms of collaborative learning, there is a common misconception that simply taking part in group work will lead to collaborative learning (Summers & Volet, 2010) and until recently both teaching practice and research have ignored the regulatory dimension of learning: how does effective social regulation in group work foster collaborative learning, and which factors influence it? This question is particularly pertinent for interdisciplinary project work, which is being increasingly implemented in Engineering Education curricula (Hadgraft & Kolmos, 2020). In this paper, we address this gap, by comparing the regulation of learning in three interdisciplinary group projects. Our research question is:

How do student groups taking part in interdisciplinary group projects regulate their learning?

Theoretically, we build upon the emerging literature on social regulation of learning (SoRL), which extends the rich tradition of theoretical and empirical work on self-regulated learning (SRL) (Hadwin et al., 2017). While SRL provides a lens onto how an *individual* regulates and processes their own learning (e.g. Zimmerman, 2015), it is increasingly recognized that SRL is not able to address questions about the social dimension of learning. Thus, in recent years, an increasing number of studies have examined SoRL. Studies on socially shared regulation of learning (SSRL) and/or co-regulation of learning (CoRL) have identified various regulatory areas, categories, coding schemes and frameworks (e.g., Miller & Hadwin, 2015) conceptualizing SoRL. Many focus on metacognition, but some include the regulation of motivation, behaviour, or emotion (e.g., Rogat & Linnenbrink-Garcia, 2011). For this paper, we will consider two modes of social regulation: CoRL, and SSRL. CoRL is the regulation of one person by another agent (Hadwin et al., 2017). For CoRL to be successful, group members need to be aware of each other's skills, knowledge and personal goals and provide support and guidance when needed (Miller & Hadwin, 2015). CoRL as a process can be initiated by one or more individuals by requesting regulation, prompting others to regulate, or technology prompting regulation (Hadwin et al., 2017). It should be noted that CoRL can help or hinder SRL and SSRL (Hadwin et al., 2017). SSRL is the joint regulation of a group's learning; it requires negotiation for consensus within a group about task goals, plans, and ongoing strategic adjustments (Hadwin et al., 2017). For SSRL to be successful the group needs to be metacognitively aware of its joint goals and how to work together towards achieving said goals (Miller & Hadwin, 2015). However, previous research has predominantly sought to identify regulated learning in mono-disciplinary groups and not interdisciplinary ones, as in this ongoing study. Similarly, previous research predominantly discussed instances of regulation in isolation and not as a series of developments within a project.

Empirically, we examine social regulation in three group projects, part of interdisciplinary courses within *Tracks*, a major educational initiative by Chalmers University of Technology in Gothenburg, Sweden. *Tracks* courses are open to all students across the university, are project-based and intended to be multi- or interdisciplinary in nature (Enelund & Briggs, 2020). Thus, students meet and learn collaboratively across programme boundaries and take on relevant challenges with a basis in real-world problems together. The courses in this study are all one semester in duration and at master's degree level. All three courses started with a more theoretical lecture part after which students were placed in groups of 2-4 for the project work.

## 2 Methodology

As the field of SoRL is still quite new, researchers are experimenting with different ways to observe and record instances of social regulation, often employing a variety of qualitative methods to ensure richness of data (Hadwin et al., 2017). To examine our research question, we conducted a comparative narrative case study of SoRL in three interdisciplinary group projects. Narrative case studies are qualitative case studies in which the researcher collects data (in this case interviews) from one or several individuals about a specific event or events (the interdisciplinary group project) in order to retell and analyse the story (Baron & McNeal, 2019).

We collected data through five qualitative, semi-structured student interviews (Cohen et al., 2011) at the end of courses that ran in the same semester. The interviewees were selected through convenience sampling and came from a variety of engineering disciplines and national backgrounds, informed consent was gathered. During the interview, participants described different phases of the project and how the group approached different forms of regulative activities such as planning, monitoring and evaluation, including motivational and socio-emotional aspects. The interviews were held over Zoom, recorded, and transcribed for analysis.

Initially, the first author analysed the interviews using Miller & Hadwin (2015)'s definitions for SRL, CoRL, and SSRL as an analytical framework, to identify and code regulation episodes. Then co-authors compared the identified episodes with the original interview data to ensure reliability. Next, these episodes were formed into clusters related to similar events across groups (e.g. planning the project). These were then summarized into narratives that describe how groups regulated learning throughout the semester (names are fictive). Narratives allow for data to be presented in a readable format highlighting aspects relevant to the research question (Cohen et al., 2011). Finally, the narratives were jointly interpreted to highlight the different forms of social regulation across the groups, including specific episodes worth highlighting. In this work-in-progress paper, we present as illustration two narrative episodes from a group of three students conducting an interdisciplinary project in a course on battery development for transport.

## 3 Preliminary results

### *Episode 1 – Hans, Saoirse and John plan the project*

Hans, Saoirse and John began their project with a group meeting after approximately six weeks of lessons on the topic. Their discussion aimed at setting a possible goal and a plan for the project, but they faced some disagreements: Hans' ideas were felt as too ambitious by Saoirse and John, both in terms of the level of knowledge and skill in the group and in terms of time. Additionally, because neither had specific expertise on the topic, all three felt insecure about which potential challenges they could encounter in the project, meaning that they struggled in making an accurate and realistic plan. Eventually, after negotiations, they came to an agreement on a number of goals, one of which was related to a measurement strategy. However, when they presented their idea to their supervisor, it transpired that their plan was unnecessary, since a measurement tool had already been designed and only needed more work. The supervisor suggested that they use this existing design to create and test battery samples. This change in the group's goal led to further disagreements as they now had adjust their plan, including for instance what types of tests they should conduct on the batteries.

*“it was also clear that we didn't quite sort of understand each other I think in terms of like a, one person thinks it's, this [plan] is going to be taking way too much time already. The other person thinks it's like, this [plan] doesn't answer at all the question that we were supposed to answer and so on.” – Hans*

Despite extensive discussions among them, the group couldn't come to an agreement and so individuals turned to the supervisor:

*“at that point we were really pulling different directions and it sort of felt like everybody was just trying to get the support of the supervisor on like their idea.” – Hans*

The group eventually came to an agreement, but the disagreements had a negative effect on Hans who experienced a drop in motivation when his suggestions on goals were rejected by Saoirse and John.

### *Interpretation*

The episode illustrates how the group used SSRL to formulate goals and a plan to achieve them and despite conflicting views/opinions they eventually reached an agreement. CoRL from the supervisor saw the goal and plan rejected and replaced by a new goal. The group attempted to use SSRL and CoRL via discussions within the group and with the teacher to formulate a plan to achieve the new goal but were unable to reach consensus. Group members then tried to implement aggressive CoRL as they attempted to push their plan on the group by convincing the supervisor to support their plan. The achievement of a consensus on the plan and goals through discussion hints towards successful SSRL, though a negative effect on motivation was noted.

### *Episode 2 – Knowledge acquisition*

The course topic was outside the three students' disciplinary background, so they found it challenging to plan their work on the project. In addition to the compulsory lectures, their supervisor gave them scientific papers on the topic to help them in the initial phases of the project. The group members read these papers individually, using their own reading strategies:

*“We got like a set of five or six papers from our supervisor, that she asked us to read and I think most of us did, I'm not really sure everyone in our group read the papers”-Hans*

Devising a plan and relevant strategies improved as the project progressed and the group learned more about the topic, and on final reflection they felt the initial uncertainty was ultimately not a problem. In addition to the lectures and the reading, the supervisors were available to provide immediate help if needed, which helped lessen the impact of any knowledge gaps.

### *Interpretation*

This episode reveals how the group failed to engage in social regulation after the supervisor used CoRL to try and help the group overcome knowledge gaps. Instead, the group members used individual SRL rather than a form of social regulation. The quote demonstrates how little shared monitoring of the group's learning was applied at this early stage of the project, when the group had little knowledge of each other and the topic. The supervisors continued to co-regulate the group during the project when requested.

## 4 Concluding discussion

We aimed to examine how student groups regulate their learning in interdisciplinary group projects, using narrative case studies of empirical basis. Given the ongoing nature of the research the results and their implications are limited but nevertheless illustrate the potential social regulation as a framework to interpret learning dimensions of effective project work. For example, their ability to successfully socially regulate the planning stage of the project was limited by their joint lack of experience in the subject area, including different views on the task and its required effort, and the lack of initial support from the supervisor in terms setting up strategies for collaboration. As evidenced by work on “desirable difficulties” or “desirable challenges” (O'Connell et al., 2021), this is not necessarily a barrier to learning as such, but it increases the risk of students employing strategies that limit or even counteract the expected benefits of collaborative learning. In the presented case, this was indicated on several occasions, e.g. attempts of aggressive co-regulation when goal needed to be readjusted, and individual learning (reading) rather than group learning, impacting the students' ability for further regulation (Rogat & Linnenbrink-Garcia, 2011). Interestingly, while other studies have reported similar episodes of aggressive co-regulation (e.g. Rogat & Linnenbrink-Garcia, 2011), our case is unique in that individuals tried to use the supervisor as external figure of authority to push for their ideas about goals and strategies. Further, we observed a lack of shared monitoring in the knowledge acquisition process during the initial stages of the project, with little effort invested to ensure that all members understand the topic: another indication of poor social regulation (Rogat & Linnenbrink-Garcia, 2011). Finally, it is also relevant to observe how the supervisor's attempt to support the group by replacing the group's

hard-won goal agreement caused regulation challenges in the group. Altogether, similarly to the studies on self-regulation (e.g. Cervin-Ellqvist et al., 2020), these findings underline the importance of scaffolding both the process of knowledge construction and of collaborative learning regulation, to enable student groups to apply effectively engage in interdisciplinary projects entailing problem-based learning. Eventually this group managed to overcome their initial struggles as they became more familiar with each other and the project, though this is not the case for all groups investigated in this project. As our research is progressing, we will present and further discuss episodes of regulation and their implications for research and practice.

## 5 References

- Baron, A., & McNeal, K. (Eds.). (2019). *Case study methodology in higher education*. IGI Global.
- Boud, D. (2001). Using journal writing to enhance reflective practice. *New Directions for Adult and Continuing Education*, 2001(90), 9.
- Cervin-Ellqvist, M., Larsson, D., Adawi, T., Stöhr, C., & Negretti, R. (2021). Metacognitive illusion or self-regulated learning? Assessing engineering students' learning strategies against the backdrop of recent advances in cognitive science. *Higher Education*, 82(3), 477–498.
- Cohen, L., Manion, L., & Morrison, K. (2011). *Research methods in education*. (Depending on RTAC solution; 7. ed.). Routledge; Chalmers Library Print Collection.
- Enelund, M., & Briggs, K. H. (2020). Tracks for change, flexibility, interdisciplinarity and creativity in engineering education. 1, 37.
- Gavin, K. (2011). Case study of a project-based learning course in civil engineering design. *European Journal of Engineering Education*, 36(6), 547–558.
- Griffiths, S., K. Houston, and A. Lazenbatt. (1995). *Enhancing Student Learning Through Peer Tutoring in Higher Education*. University of Ulster.
- Hadgraft, R. G., & Kolmos, A. (2020). Emerging learning environments in engineering education. *Australasian Journal of Engineering Education*, 25(1), 3–16.
- Hadwin, A. F., Järvelä, S., & Miller, M. (2017). Self-Regulation, Co-Regulation, and Shared Regulation in Collaborative Learning Environments. In *Handbook of Self-Regulation of Learning and Performance* (pp. 83–106). Routledge.
- Johnson, D. W., & Johnson, R. T. (2009). An educational psychology success story: Social interdependence theory and cooperative learning. *Educational researcher*, 38(5), 365–379.
- Miller, M., & Hadwin, A. (2015). Scripting and awareness tools for regulating collaborative learning: Changing the landscape of support in CSCL. *Computers in Human Behavior*, 52, 573–588.
- O'Connell, M., Adawi, T., Trefna, H. D., Ström, A., & Stöhr, C. (2021). Challenge Episodes and Coping Strategies in Undergraduate Engineering Research. *Proceedings of the SEFI 49th Annual Conference*, 1071–1079.
- Rogat, T. K., & Linnenbrink-Garcia, L. (2011). Socially Shared Regulation in Collaborative Groups: An Analysis of the Interplay Between Quality of Social Regulation and Group Processes. *Cognition and Instruction*, 29(4), 375–415.
- Summers, M., & Volet, S. (2010). Group work does not necessarily equal collaborative learning: Evidence from observations and self-reports. *European Journal of Psychology of Education*, 25(4), 473–492.
- Zimmerman, B. J. (2015). Self-Regulated Learning: Theories, Measures, and Outcomes. *International Encyclopedia of the Social & Behavioral Sciences*, 541–546.



# Microcredentials to support PBL

Euan Lindsay

Aalborg University, Denmark, [edl@plan.aau.dk](mailto:edl@plan.aau.dk)

Olav Geil

Aalborg University, Denmark, [prodekan-eng-udd@aau.dk](mailto:prodekan-eng-udd@aau.dk)

Mette Møller Jeppesen

Aalborg University, Denmark, [mmje@adm.aau.dk](mailto:mmje@adm.aau.dk)

## Summary

Digitalisation is transforming the way engineering is both taught and practiced. Professional engineers need to learn how to work in a primarily digital work, and pedagogies such as PBL are increasingly popular due to their ability to provide authentic learning experiences for student engineers. These trends place increasing pressure on how universities support students in learning the underpinning technical content that is critical to an engineering degree. At Aalborg University, we are exploring the flexibility offered by microcredentials as a way of supporting our students in their project-based learning, providing pathways to recognise the independent and co-curricular study that is so critical to both PBL and their future professional practice. We also see significant potential for a more fine-grained curriculum to promote multidisciplinary learning between humanities and the STEM fields to align with AAU's mission driven research agenda.

**Keywords:** PBL, Microcredentials, Multidisciplinarity

**Type of contribution:** Best practice extended abstracts

## 1 PBL is increasingly prevalent

As we move into the 21<sup>st</sup> century, engineering degrees are increasingly moving their focus to the 21<sup>st</sup> century skills that graduates will need to succeed in practice. There are many reports that investigate these skills and make recommendations on how those skills should be achieved (eg. Graham 2018, ACED 2021). A common theme that emerges from these reports is a need for the curriculum to move from a traditional lecture driven model towards a more problem-based curriculum. Problem based learning is not new in engineering, however it does appear to be the newly dominant paradigm when newly established engineering programs are concerned, with a number of innovative new programs adopting PBL as their core philosophy (eg. Lindsay & Morgan 2021, Ulseth et al 2021).

PBL comes in many flavours (Chen et al 2021) with implementations that range from inclusion of projects into traditional courses, stand-alone PBL courses within degrees, or entire curricula focussed around a spine of PBL experiences. Regardless of the type of PBL implementation, students still need to develop competency in the underpinning technical fundamentals. In course level programs this competency is the core driver of the majority of the curriculum. At institutions with program level PBL, this competency is delivered in the support of the PBL, but it is often still delivered in the style of traditional programs.

It is the latter model that is used at Aalborg University (AAU), with all semesters built around the same structure (Figure 1). They are driven by a large PBL project, which is worth 15 ECTS, or half the load. These projects are typically conducted in groups of 4-7 students and run the whole duration of the semester.

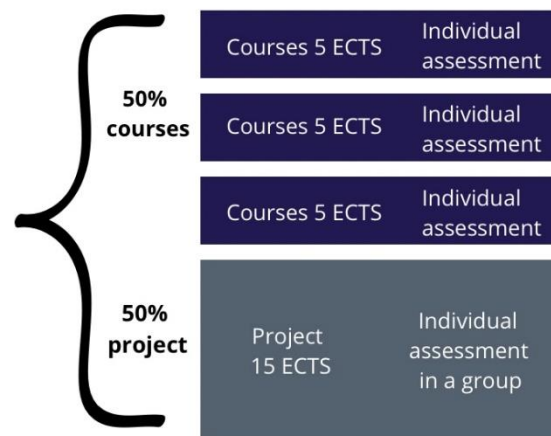

Figure 1: The Aalborg Semester Model

These projects are supported by more traditional courses, each of which is worth 5 ECTS. The role of these traditional courses is to provide the key knowledge that all students in that discipline should require at that stage of their professional development, however it is impossible for these courses to provide all of the necessary underpinning technical content. It is essential that students go beyond their classwork to seek specific knowledge relevant to the specific project they have defined.

This search for knowledge is inspired by the Danish concept of *udsyn* – the philosophy of looking beyond one’s own environment and discipline. Students are expected to seek knowledge because it is required, but also because they are inspired; there is not an expectation that the technical courses will (or should) be sufficient for them to complete their projects.

At AAU, independent study can often be as much as a third of the overall volume of learning in a PBL project – a volume equal to one of the traditional courses. However, this independent study is not structured like these courses. It does not have the explicit guidance as to what resources to explore, nor the quality assurance that the information they are seeking can be trusted. It does not require them to contextualise their project by seeking knowledge outside the purely STEM domain. It does not even have to take place in an academic context – students can and do draw upon co-curricular learnings such as internship experiences. Further, students do not receive any explicit recognition for the learning that they do in the course of their independent study.

The nature of PBL is that it requires students to be flexible and adaptable in the way that they seek the necessary knowledge to apply in their projects. Increased flexibility of learning for all teaching models is an emerging consequence of the COVID-19 pandemic. Universities are increasingly looking for ways to support and recognise alternative ways of learning by their students, leading to a disruption of traditional patterns of learning.

## 2 Delivery of technical fundamentals is being disrupted

Over the last decade, higher education institutions throughout the world have undergone a continuous digital transformation that is obvious and necessary (Sjöberg and Lilja, 2019). The digital transformation has accelerated even further during the COVID-19 pandemic. During the pandemic it has become clear that there is a need for new approaches to teaching where digital technologies are integrated, if we are to keep up with the times and not conveniently fall back on the more traditional teaching approaches within higher

education. The universities are therefore under pressure in terms of what they must be able to do and how they do that. This pressure will no doubt affect how we in higher education connect with employers, partners and students to successfully form the digital transformation.

If we want to move forward in the digital transformation the maturation of the universities is important, and it is vital that we aid the way we perceive and think about ourselves as organisations. In Kræmmergaard (2019) it is described how the crucial part of the digital transformation is not the technologies themselves; the crucial thing is “the value we can create for our customers...” - in the case of HE, our students. Technology should instead be considered as way in which we can bring even more value to our students.

If moving the digital transformation forward is also something to which the university should contribute, we have to be familiar with the way in which the technologies affect the world within the organisation and make sure to use the technologies in innovative ways: "(...) In the digitally mature company or organization, the technologies are an integral part of mission, vision, etc. (...)" (Kræmmergaard 2019, pp. 22). However, few organisations are at that maturity level. To aid this process, Kræmmergaard (2019) developed a model for conceptualising digital maturity levels, identifying five different generations of maturity (Table 1). Organizations in different generations use and perceive digitalization differently, ranging from using it as a means for supporting existing practice through to using it as a way of driving new organizational models of operation.

Table 1: Five generations of IT and digital maturity (Inspired by Kræmmergaard 2019)

	<b>Gen. 1</b>	<b>Gen. 2</b>	<b>Gen. 3</b>	<b>Gen. 4</b>	<b>Gen. 5</b>
<b>Digitization is about</b>	<i>Self-service and automation</i>	<i>Process improvement and integration of front and backend systems</i>	<i>Services in new ways and co-creation</i>	<i>New integrated and coherent services</i>	<i>Proactive personalised services</i>
<b>Preoccupied by</b>	<i>How do we support our practice with IT?</i>	<i>How do we implement new systems?</i>	<i>How do we develop new (digital) services that are similar?</i>	<i>How can we use our own and other systems, data and services to create coherent services?</i>	<i>How can we apply technology and data to personalised hyper-relevant, occasional proactive, services?</i>
<b>Culture and mindset</b>	<i>Maintaining existing practices</i>	<i>To do what we already do better - low risk and "known projects"</i>	<i>Doing the right thing – bold and experimental</i>	<i>Seek new collaborations and ecosystem mind set</i>	<i>Seek new contexts and patterns and insights</i>
<b>Changes</b>	<i>Use IT Instead of manual handling</i>	<i>New work processes and new IT systems</i>	<i>Change culture, new competencies and collaborative relationships</i>	<i>New ways to create value, and new forms of organization with many partners</i>	<i>New ways to interact with technology, work, learn, think and make decisions and choices</i>

Table 1 illustrates that many universities were in generation one before the pandemic. It was often used to support face to face activities, but was seldom the driver of the activities themselves. The pandemic was a decisive reason why many higher education institutions were forced to invest more in the digital

transformation whereby the emergency remote instruction helped to move the organizations to generation two in the model. Post COVID, we now find ourselves in a situation where we, as universities, must decide whether we must stagnate in relation to the development and perhaps fall back to the level before COVID-19, or we must follow the digital transformation and lift the organizations to a whole new level. Moving forward towards the next generations, initially generation three is largely about the organizations starting to experiment and collaborate with each other but also with our students. Around the world there are several examples of digital approaches within higher education, delivering engineering degrees and there are even examples of programs taking the digital native approaches to the next level (Morgan et al, 2021).

Increasing levels of digitalisation of the curriculum will require changes to the traditional model of higher education. In traditional institutions, where lectures are the primary method of delivery, this change will necessarily be disruptive as digital delivery displaces traditional face-to-face contact. In PBL-driven institutions, however, the transition has the potential to be transformative in a positive way. The PBL learning environment is uniquely suited to exploit the opportunities offered by the higher levels of the Kræmmergaard framework; the asynchronous, on-demand nature of a fine-grained digital microcredentials is ideal for supporting learning in PBL environments.

### 3 Digital Microcredentials can support PBL

The push towards increased flexibility in delivery is persisting beyond the impact of the COVID-19 pandemic. Many institutions within higher education are starting to work more structured with the digitization of teaching material and have introduced microcredentials in different areas – in relation to curriculum and other (Selvaratnam & Sankey, 2019). Universal standards for microcredentials are just emerging (Council of the European Union, 2022), with institutions exploring this space on their own initiative. Aalborg University is one of these places.

Through our PBL digital program (and other initiatives) we have been developing online resources and microcredentials to better support student learning. We have built micros in areas such as energy use in building, laboratory safety orientations and cryptography. These have been initially developed to support learning within their respective courses and draw upon a range of assessment approaches varying from self-assessment to project exams. The next stage is for them to be deployed in direct support of PBL projects. This will give us materials that we can share around the university, and to the outside world. Students will know that these resources are quality assured and they will get recognition when they complete these materials as part of their independent study.

AAU is particularly keen to promote stronger integration between the STEM and the humanities and social sciences disciplines. The challenges facing the world as identified through the UN SDGs all have technical solutions at their heart; but they are also problems where the technology will not be enough. Embedded microcredentials provide an opportunity to share knowledge across the STEM / social sciences / humanities borders, but in fine-grained enough quanta for that knowledge to be applicable to the projects involved. It is hoped that this knowledge exchange will help bring faculty together across disciplinary boundaries as well.

This approach does not need to be limited to microcredentials that are developed at AAU. Students already search broadly for the knowledge to support their projects; where this knowledge already exists in microcredentials these can be imported into our curriculum. This approach also allows for collaboration with industry partners in the development of curriculum that can support the learning of our students as well as the professional development of their employees.

### 4 Conclusion

The COVID-19 pandemic has highlighted the need for universities to move away from traditional models of instruction that rely upon synchronous in-person classes. This has accelerated the trend of adopting

alternative pedagogies such as PBL that are better able to provide students with the authentic learning experiences that they need to be prepared for practicing in an increasingly digital future.

The move towards newer curriculum models raises questions about how students should engage with the technical fundamentals of their disciplines; and the future requirements of this engagement increasingly look like the past and present of microcredentials. On-demand asynchronous fine-grained technical content aligns better with the needs of a PBL curriculum and is more authentic to the learning habits and lifestyles of contemporary student engineers.

Embracing the affordances of microcredentials offers significant opportunities for future curriculum development beyond just the flexibility of delivery for students. Microcredentials also offer the opportunity to support greater multidisciplinary collaboration and exposure to different ways of learning. Digital microcredentials can also serve as the building blocks on which the higher-level capacities of learning analytics and personalised instruction can be built.

Not everything within an engineering curriculum can be digitalised; but for the parts that can and should, the pathway forward aligns with contemporary work in microcredentials, and there are significant opportunities to learn from the experience of microcredentials as we move forwards to more digital native engineering curricula.

## 5 References

ACED (2021). Engineering Change: The future of engineering education in Australia. Australian Council of Engineering Deans (<https://www.aced.edu.au/index.php/examples>)

Chen, J., Kolmos, A., & Du, X. (2021). Forms of implementation and challenges of PBL in engineering education: A review of literature. *European Journal of Engineering Education*, 46(1), 90-115. <https://doi.org/10.1080/03043797.2020.1718615>

Council of the European Union (2022) A European approach to microcredentials. <https://education.ec.europa.eu/education-levels/higher-education/micro-credentials>

Graham, R. (2018). The global state of the art in engineering education. MIT. [neet.mit.edu](http://neet.mit.edu)

Kræmmergaard, P. (2019) Digital Transformation - 10 skills your organization must master and three that you need [Digital Transformation – 10 Evner din organisation skal mestre og 3 som du har brug for] 2 edition, Djøf Forlag: Denmark.

Lindsay, E., & Morgan, J. (2021). The CSU engineering model: educating student engineers through PBL, WPL and an online, on demand curriculum. *European Journal of Engineering Education*, 46(5), 637-661. <https://doi.org/10.1080/03043797.2021.1922360>

Morgan, J., Lindsay, E., Howlin, C., & Bogaard, M. E. D. V. D. (2021). The CSU Engineering Topic Tree: The First Four Years. *Advances in Engineering Education*, 9(3).

Selvaratnam and Sankey (2019), "Micro-credentialing as a sustainable way forward for universities in Australia: Perceptions of the landscape", White Paper for the Australasian Council on Open, Distance and eLearning.

Ulseth, R., Johnson, B., & Kennedy, C. (2021). Iron Range Engineering. *Advances in Engineering Education*, 9(3).

# Meta Disciplines: Systems, Design, and Computing

Jianxi Luo

Singapore University of Technology and Design, Singapore, [luo@sutd.edu.sg](mailto:luo@sutd.edu.sg)

## Summary

This paper defines and discusses the meta disciplines and their institutional implementations at a university. The meta disciplines refer to such fields of study as systems, design, and computing, which focus on meta theories and methodologies that may empower research and education across many if not all traditional disciplines such as engineering, architecture, medicine, business, and government. I consider three experiments at MIT to build intra-organizational units of meta disciplines, including the Engineering Systems Division, Schwarzman College of Computing, and Morningside Academy for Design. Their organizational design increases the dimensionality of knowledge to be learnt and created throughout MIT. The development and use of meta theories and methodologies may empower learning and exploitation in traditional disciplines while also fostering their interactions for emergence and innovation. Universities may explore new meta disciplines and novel implementation models to address the needs of future education and research.

**Keywords:** Meta disciplines, Systems, Design, Computing, MIT

**Type of contribution:** Best practice extended abstracts

## 1 Introduction

Our world is faced with many growingly complex and uncertain “wicked problems” (Rittel and Webber, 1973) such as COVID and climate change. As we enter the fourth industrial revolution, the fusion of the cyber, physical, and biological worlds induces new societal challenges to ethics, equity, and human values in the prevalence of ubiquitous computing and artificial intelligence (Schwab, 2017). Such wicked and new challenges involve intertwined technological, social, economic, and political factors that co-evolve and stakeholders with heterogeneous views and dynamic interactions.

Such emergent challenges would require continual design and experimentation of novel solutions, which are social-technical, systematic, and evolvable (de Weck et al, 2012). The complexity and uncertainty we face may have reached the level that human intelligence alone would be unable to effectively understand the intricate problems and come up with systematic solutions. Meanwhile, artificial intelligence (AI) beyond singularity (Kurzweil, 2005) may offer new capabilities to augment design creativity and AI-driven innovation to address those complex challenges (Luo, 2023).

These suggest the necessity and importance of design, systems and computing in engineering education, research, and innovation. Engineers of the future, regardless of disciplines, may benefit from mastering design, systems, and computational thinking and applying them to problem solving and innovation in their fields of practice. We anticipate engineers who are leaders to design and experiment with the aid of artificial intelligence for human-centred social-technical system-based solutions to complex challenges and for innovations that drive civilization toward a sustainable future.

Design, systems, and computing themselves appear to be specific fields to study, while they are also ubiquitous in and essential for many if not all fields of study. Herein, we call them meta disciplines. Many

academic societies and journals have been dedicated to developing these meta disciplines. The development of theories and methodologies in the meta fields require drawing upon, synthesize, and unify the observations, understandings, and methodologies in different traditional fields. In turn, the theories and methods developed in meta fields, such as design thinking and design science (Dym et al., 2005; Papalambros, 2015), system dynamics (Sterman, 2001) and network science (Newman, Barabási, & Watts, 2006), and deep learning (LeCun, Bengio, & Hinton, 2015) and large language models (Wei et al., 2023), can empower education, research, and practice across many if not all traditional disciplines such as engineering, architecture, medicine, business, and government. The relations and interactions of meta and traditional disciplines are depicted in Figure 1.

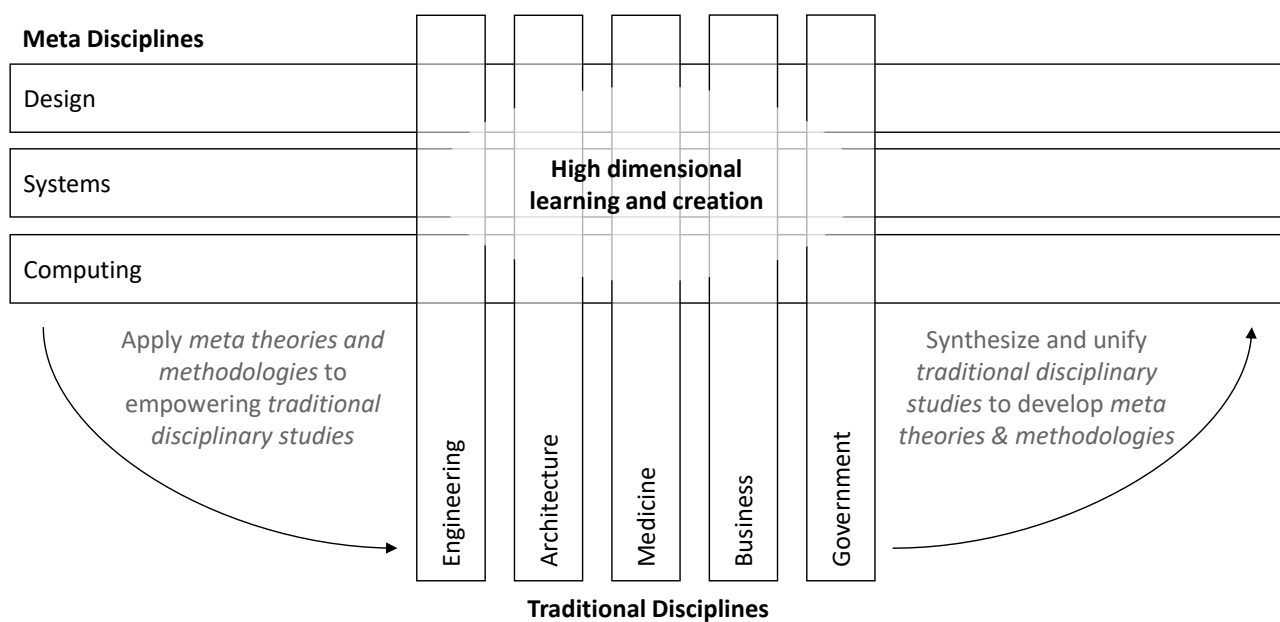

Figure 1: Relations and interactions between meta and traditional disciplines

Despite the high-order values of the meta disciplines for traditional disciplines, it remains ambiguous how to embed meta disciplines in the organizational structure of a university for them to empower traditional disciplines while advancing themselves at the same time. In this paper, we analyse three experiments at MIT to build intra-organizational units (see below) on meta disciplines, including

- 1) Engineering Systems Division (ESD)
- 2) Schwarzman College of Computing (SCC)
- 3) Morningside Academy for Design (MAD)

We briefly review the missions and operational models of the three organizational units, analyse their commonalities and differences, and assess their challenges and prospects. It is important to note that, we do not consider them as golden standards but experiments of a university for organizational learning, transformation, and evolution.

## 2 Meta Disciplines at MIT

### 2.1 Engineering Systems Division (ESD)

ESD was founded in 1998 to focus on the engineering of complex systems and broaden engineering education (Roos, 1999). ESD addresses the societal and industrial needs for new theories underlying many socio-technical systems, such as global manufacturing, multi-modal transportation and sustainable energy, and

unified methodologies for designing and managing them against growing complexity, emergence, and uncertainty. ESD hosted a PhD program in Engineering Systems and several master programs, e.g., System Design and Management, Technology and Policy Program. About 50 faculty members were associated with ESD through dual or joint appointments with traditional departments or schools. In 2011, ESD was the third largest graduate program in the School of Engineering and gained the right to hire ESD-only faculty. In 2015, MIT launched the Institute for Data, Systems and Society (IDSS) to integrate ESD and the Laboratory for Information and Decision Systems (LIDS) and focus more on data science for social-technical systems analytics, design, and management (de Weck, 2016).

## 2.2 Stephen A. Schwarzman College of Computing (SCC)

SCC was founded in 2018 with a mission to not only strengthen computer science, AI and computing-related fields but also discover the power and develop the applications of computing in every field of study, while also ensuring the future of computing is shaped by insights from other disciplines. The college is named after The Blackstone Group chairman Stephen A. Schwarzman, who donated \$350 million of the college's \$1.1 billion funding commitment. The college is an institute-wide academic unit that works alongside MIT's five Schools, with a focused home for computer science and AI education and research. It plans to host 50 new faculty positions, including 25 in computer science, AI and decision making located within the college as core faculty and 25 shared with other departments. It aims to educate students in every discipline to be "bilingual," and able to responsibly use and develop computing technologies to help design and make a better world.

## 2.3 Morningside Academy for Design (MAD)

MAD was founded in 2022 as a hub to transform learning, research, innovation, and entrepreneurship by integrating design methodologies into MIT courses and curricula (Ochsendorf and Yang, 2022). It is started with a \$100 million gift from the Morningside Foundation. MIT considers design a disciplined practice to augment creativity in and across different disciplines and to take "creative, humanistic thinking to society's biggest challenges." It is recently kicked off with launching the program of Design Fellows, who work with faculty and researchers to interweave design with different fields to create solutions to societal challenges. Moving forward, MAD aims to bring together a diverse community of researchers and designers from all five schools at MIT, via design projects, in-residence and public programming. MAD was built upon the successes and lessons learnt from the operations of SUTD-MIT International Design Centre (2010-2020) and many existing "design plus programs" at MIT, e.g., design + engineering, design + management, design + health (Ochsendorf & Yang et al., 2021).

## 3 Analysis and Synthesis of MIT's Experiments on Meta Disciplines

ESD, SCC and MAD share several characteristics in common. First, each of them is built around a respective meta discipline with unified theories and methodologies that can be used in diverse disciplines or fields. They differ from interdisciplinary centers such as Future Energy Center or Media Lab at MIT which bring together knowledge and methodologies from different disciplines for innovation but do not focus on and foster a meta discipline. Second, they cut across all five schools at MIT (Figure 2) by engaging faculty, researchers and students from different departments and traditional disciplines through dual or joint appointments and integrated multidisciplinary projects or programs. They all offer education and research programs.



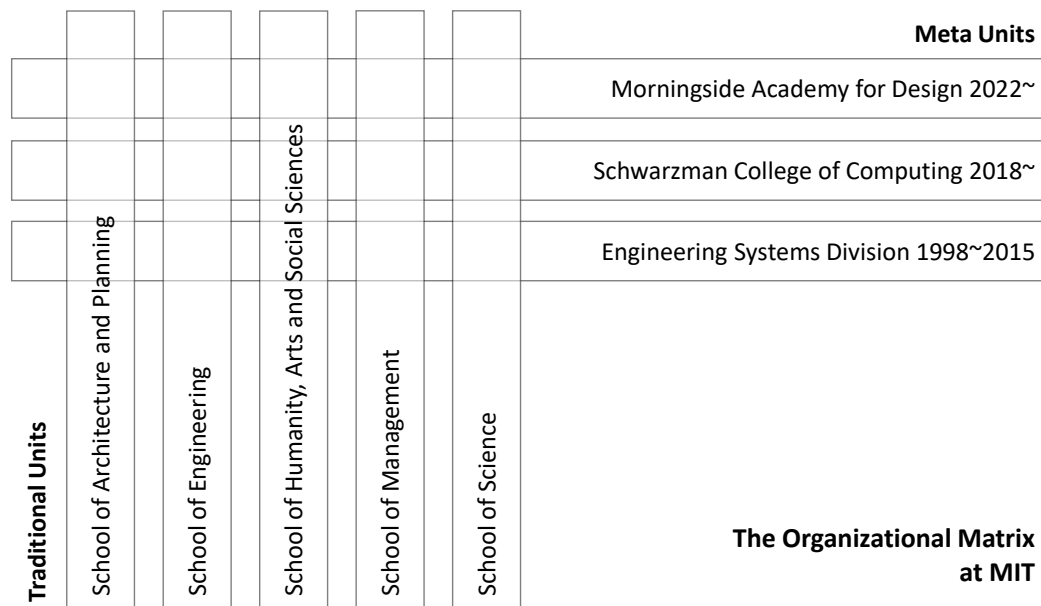

Figure 2: Meta disciplines at MIT

These three meta units at MIT differ in several ways. First, their naming differs as a division, college, and academy. SCC and ESD can hire tenure-track faculty while MAD at this point cannot. Second, ESD, SCC and MAD are driven by different faculties at the founding stage, e.g., Civil and Environmental Engineering for ESD, Electrical Engineering and Computer Science for SCC, Architecture and Planning for MAD, respectively. Third, their initial funding conditions differ. ESD pooled resources from existent initiatives and programs, whereas SCC and MAD were started with generous endorsement funds from external donors to build new programs.

MIT's intra-organizational design to embed systems, computing and design in the university structure appears to have increased the dimensionality of knowledge to be learnt, created, and shared throughout MIT and beyond. As depicted in Figure 2, they transform MIT into a matrix structure. The knowledge and methodologies from each meta discipline may empower learning, exploitation and innovation in individual traditional disciplines while fostering the interactions and integration of different disciplines for emergent learning and convergent innovation. Meanwhile, meta knowledge and methodologies can be developed and advanced by synthesizing or unifying observations, practices, and knowledge from various traditional disciplines.

Despite these aimed benefits, it can be difficult to develop and sustain organizational units of meta disciplines in established universities. By nature, such meta units are most likely operationalized via hybrid education and research programs. Traditional faculty who was trained and have succeeded in silos may not be able to perceive the values of high-dimensional learning and may not have the interest nor capacity to manage or get involved in hybrid organizational structures with increased dimensionality and sophistication. It is suggested the development and success of meta units would require strong support from the top leadership of the university, as well as abundant resources.

#### 4 Broader and future perspectives

To this point, we have only briefly discussed three meta disciplines and three meta organizational units at a single university. There are surely other meta disciplines and additional models of embedding and developing them at a university. Universities with different cultures, legacies and governance mechanisms may design and experiment different models for developing different meta disciplines and units for increasing dimensionality of learning and creation of knowledge and technologies that can address future needs.

The growing “wicked problems” and emergent challenges of the future (e.g., AI risks to humanity, infectious diseases, sustainability) can be utilized as drivers or shapers of future education and research that co-develops meta and traditional disciplines in a fused manner. The process of seeking solutions to such wicked problems would naturally require continual design and experimentation of systems-based solutions integrating multidisciplinary knowledge with the aids or uses of computing and AI, and thus provides a great context for education and research.

Problem-based learning courses or programs aiming to address such pressing or emergent challenges of a complex nature may motivate students’ active learning of knowledge from all relevant fields and experiential learning of design processes, methods, and tools, the complexity of design problems and solutions, and applications of computing and AI in the design processes and/or design solutions to the complex problems.

Design or research projects aiming to solve such complex real-world “wicked problems” may serve as test beds of new theories and methods from research in the meta and traditional disciplines, bring together researchers and students from meta and traditional fields, and attract industry and government stakeholders to participate and contribute. Therefore, problem-driven learning, research and design may foster the development of meta disciplines together with traditional fields simultaneously.

## References

- Dym, C.L., Agogino, A.M., Eris, O., Frey, D.D., Leifer, L.J. (2005) Engineering design thinking, teaching, and learning. *Journal of Engineering Education*, 94 (1), 103-120.
- de Weck, O.L., Magee, C.L., & Roos, D. (2012). *Engineering Systems: Meeting Human Needs in a Complex Technological World*. MIT Press.
- de Weck, O.L. (2016). MIT Engineering Systems Division R. I. P. Eulogy for a successful experiment 1998-2015. *MIT Faculty Newsletter*, Vol. XII No. 1.
- Kurzweil, R (2005). *The Singularity Is Near: When Humans Transcend Biology*. Viking.
- LeCun, Y., Bengio, Y., Hinton, G. (2015). Deep Learning. *Nature*, 521(7553): 436–444.
- Luo, J., (2023). Data-Driven Innovation: What is it. *IEEE Transactions on Engineering Management*, 70(2), 784-790, 2023.
- Ochsendorf, J., & Yang, M. etc. (2021). *Envision the Future of Design at MIT*.
- Ochsendorf, J., & Yang, M (2022). Elevating Design at MIT Through the Morningside Academy. *MIT Faculty Newsletter*, Vol. XVIII No. 4.
- Papalambros, P. (2015). Design Science: Why, What and How. *Design Science*, 1, e1.
- Newman, M., Barabási, A-L, & Watts, D.J. (2006) *The Structure and Dynamics of Networks*. The Princeton Press.
- Rittel, H.W.J., & Webber, M.M. (1973). Dilemmas in a general theory of planning. *Policy Science*, 4(2), 155–169.
- Roos, D. (1999). ESD Created to Broaden Engineering Education. *MIT Faculty Newsletter*, Vol. XVIII No. 4.
- Schwab, K. (2017). *The Fourth Industrial Revolution*. Penguin UK.
- Sterman, J.D. (2001). System Dynamics Modeling: Tools for Learning in a Complex World. *California Management Review*, 43(4): 8-25.
- Wei, J., Tay, Y., Bommasani, R., et al. (2023) Emergent Abilities of Large Language Models. *Transactions on Machine Learning Research*.

# The vision-in-practice project leadENG

Olav Geil

Aalborg University, Denmark, [prodekan-eng-udd@aaau.dk](mailto:prodekan-eng-udd@aaau.dk)

Mogens Rysholt Poulsen

Aalborg University, Denmark, [dekan-engineering@adm.aau.dk](mailto:dekan-engineering@adm.aau.dk)

Mette Møller Jeppesen

Aalborg University, Denmark, [mmje@adm.aau.dk](mailto:mmje@adm.aau.dk)

Troels Frøkjær Christensen

Aalborg University, Denmark, [tfc@adm.aau.dk](mailto:tfc@adm.aau.dk)

## Summary

In the publications Goldberg & Somerville (2014) and Graham (2018) the authors set the scene for a “coming revolution in engineering education”. Even though the Aalborg model for PBL which we practice at Aalborg University, is indeed a modern, vibrant and efficient method, in the aftermath of the above-mentioned publications, we always question our practice and continuously try to become a better version of ourselves. With the aim of delivering on the many inspiring visions articulated in Goldberg & Somerville (2014) and Graham (2018) we at the Faculty of Engineering and Science initiated the overall development project leadENG which since 2019 constitutes the framework for our continuous work. The Big-Beacon-Manifesto (Big Beacon, 2014) which relates to the first mentioned reference in particular is used as inspiration.

**Keywords:** Big-Beacon-Manifesto, Engineering education, Interdisciplinarity, Problem Based Learning, The Whole New Engineer

**Type of contribution:** Best practice extended abstract

## 1 Some important and inspiring trends in engineering education

Massachusetts Institute of Technology launched, in June 2016, the New Engineering Education Transformation (NEET) program and commissioned Ruth Graham to conduct the study *The global state of the art in engineering education* (Graham, 2018). The outcome of the report is a list of current thought leaders within engineering education as well as a list of emerging thought leaders. More importantly, the typical characteristics of these thought leaders are described. In the report the following description of distinctive pedagogical features of “current leaders” in engineering education is formulated:

- *pathways and linkages for students to engage with the university’s research activities, often building upon rigorous, applied teaching in the engineering fundamentals;*
- *a wide range of technology-based extra-curricular activities and experiences available to students, many of which are student-led;*
- *multiple opportunities for hands-on, experiential learning throughout the curriculum, often focusing on “problem identification as well as problem solution,” and typically supported by state-of-the-art maker spaces and team working areas;*

- *the application of user-centered design throughout the curriculum, often linked to the development of students' entrepreneurial capabilities and/or engaged with the social responsibility agenda;*
- *emerging capabilities in online learning and blended learning;*
- *longstanding partnerships with industry that inform the engineering curriculum as well as the engineering research agenda.*

(Graham, 2018:37).

In the light of the fact that Aalborg University holds a position as number four on the list of current thought leaders, it should obviously be expected that our PBL-practice involves all the above features. And indeed, this is the case. But having the features coined so explicitly is a well-come tool we can use actively in our present and future work. The report further describes, among other things, five curricular themes that seem likely to be more central in the future:

*(...)(1) student choice and flexibility, (2) multidisciplinary learning, (3) the role, responsibility, and ethics of engineers in society, (4) global outlook and experiences, (5) breadth of student experience*  
(Graham, 2018:43).

Such themes are common features of many of the institutions on the list of emerging thought leaders, among which more than a few are relatively small, and she concludes that the next challenge will be for larger institutions to implement similar methods. As all five themes fit well with the value base of Aalborg University, we will be among the larger institutions taking up the challenge to the extent that we are not already practicing it.

Olin College has a truly pioneering approach to engineering education, which has resulted in a position as world leading institution on the list of current thought leaders and a position as second among the emerging thought leaders. To describe their thinking, we now recall the Big Beacon Manifesto which has its origin in the engineering education transformation at Olin College, Illinois Foundry for Innovation in Engineering Education, and the Olin-Illinois Partnership. Besides being a platform for collaboration, the revolutionary, yet obviously meaningful, ideas are being concretely expressed in the book Goldberg, D. E. & Somerville, M. (2014). Rather than describing only the features of their practices, the manifesto formulates a clear vision for what should be *The Whole New Engineer*. Reading from page 14 and onwards we have:

*The whole new engineer: (1) Finds joy in engineering and in life (2) is open trusted, and trusting, (3) is authentically connected with others, (4) is powerfully present to possibilities in the moment, (5) is mindful, observant, and an effective listener, (6) has the courage to initiate, fail, and initiate again, (7) is technical competent and agile, (8) is broadly educated and curious, (9) is a team player, a collaborator, and a community builder, (10) is a designer, a creator, and a sustainer, (11) is emotionally and socially aware and competent, (12) is a reflective thinker and a self-directed and persistent learner* (Big Beacon, 2014:14-25).

These twelve characteristics are then followed by a description of what engineering education is not and what it should be:

*Engineering education is not a mind-numbing math-science death march that casts aside thousands of capable young people who might otherwise have made effective engineers. It is a joyful trusting process that delights in serving student aspirations, learning, and growth, unleashing the potential of each individual* (Big Beacon, 2014:26).

Building on the characteristics of The Whole New Engineer the manifesto then continues with the following twelve goals for the future of engineering education:

*A whole new engineering education: (13) is a joyful and challenging experience, (14) trusts students, believing they are resourceful, creative, and whole, (15) connects with students by fostering a sense of community, (16) encourages diverse student aspirations and increases student autonomy and choice, (17) accommodates diverse learning styles, (18) fosters agile technical competence in a changing world, (19) fosters concern for human values and ethics, (20) encourages pervasive collaboration and teamwork, (21) celebrates action in the world and values failure that results in learning, (22) values educators who are servant teachers, (23) listens to and collaborates with all stakeholders, (24) walks the talk of the whole new engineer (Big Beacon, 2014:26-38).*

At The Faculty of Engineering and Science (ENGINEERING), Aalborg University we agree with the vision for The Whole New Engineer and the description of what engineering education is not, and what it should be, as well as confess to the twelve goals for the future engineering education. Our vision-in-practice project leadENG (see Section 3 below) is based on the above strong messages from Graham (2018), Goldberg & Somerville (2014) as well as The Big Beacon Manifesto (Big Beacon, 2014). Here, we challenge our current practice and the conditions under which we operate.

## 2 The institutional context of leadENG: PBL at Aalborg University

Aalborg University was founded as a Problem Based Learning (PBL) institution in 1974. PBL at AAU is constantly developing, but the method, in whichever form it appears, always possesses the same fundamental and important characteristics which are (1) a problem is used as point of departure, (2) the project work is organized in groups, (3) the project is supported by courses, (4) collaboration plays a fundamental role and involves the group(s), supervisor(s), and possibly external partners, (5) Exemplarity. The project work typically takes up half the students studying time and the students own the project implying a high level of autonomy within given frames (Askehave et al., 2015). The efficiency of the method is well-documented Chen et al. (2021), Kolmos et al. (2021), Boelt et al. (2022).

It is a shared mission for the entire university and our partners to adapt PBL to the everchanging society and to prepare it for the future. The development is driven by stakeholders at all levels of the organization, i.e., students, supervisors (teachers), PBL researchers and management as well as our many external collaborators in the industry and other public and private organizations. See Bertel et al. (2021). The current common framework for the development comprises at least three directions which of course have some overlap, namely “Progressive PBL competencies throughout the study”, “PBL in the digital world” and “Integration of SSH competences in STEM-educations and vice versa” (SSH stands for social science and humanities whereas STEM is the commonly used abbreviation for science, technology, engineering, and mathematics). The latter mentioned topic includes recent experiments on what is known as Megaprojects which are very broad collaborative projects involving students from at least three out of the four faculties at AAU and addressing a problem posed by an external organization. For more information on Megaprojects, see <https://www.megaprojects.aau.dk/>.

Aalborg University is a comprehensive university consisting of the following four faculties: The Faculty of Social Sciences and Humanities, The Faculty of Medicine, The Technical Faculty for IT and Design (abbreviated TECH), and finally The Faculty for Engineering and Science (abbreviated ENGINEERING). At ENGINEERING we decided three years ago to embark on the journey which we call leadENG. Being smitten by the revolutionary ideas described in the previous section we decided to question potentially every aspect of our practice and to start a continued process where we always keep in mind that we do not need to stick to our old practice, but always should aim to become a more meaningful version of ourselves for the benefit of our students, our teachers, and the surrounding society. This is in the true spirit of PBL the most important characteristics of which is openness, ownership and meaningfulness. The project leadENG lives in synergy with the above-mentioned overall initiatives at the university level - sometimes addressing aspects from there and sometimes adding different perspectives.

### 3 The project leadENG

Combining our own experience and thoughts with the content of the first section of the present abstract we at ENGINEERING formulated a vision for leadENG building on 24 characteristics. It should be noted that the Danish university system is strongly regulated by the government and as at the same time AAU is a relatively large institution, seeking new solutions may require quite some ingenuity. The vision are as follows:

For the studies we aim for: (a) engaged students, (b) agile learning, (c) a clear connection between the different elements of the study, (d) a connection to the students' life in general, (e) vibrant PBL, (f) students' ability to pursue special interests and encouraging cultivation of personal skills, (g) freedom of choice.

For the professionalism we aim for: (h) a clear professional profile, (i) entrepreneurship, (j) applicable and applied science, (k) a clear link between research and education, (l) SSH competencies, (m) interdisciplinarity, (n) visibility beyond own profession, (o) collaboration with industry and other external organizations.

For the structure we aim for: (p) wide entrances to allow for students changing topic within the first year, (q) stable portfolio of studies, (r) rational and operational practice, (s) possibility for agile development, (t) not too small number of students on each study to prevent drop-out.

For the relevance we aim for: (u) profiles relevant for the society, (v) balance between the students' specialist and generalist competencies, (w) employable candidates, (x) students prepared for continuing learning

By purpose we have not formulated an overall strategy for our efforts to achieve the above goals. Rather we prefer to constantly keep an eye on the vision while defining and working strategically in subprojects. This makes leadENG operational and meaningful to engage in for the involved stakeholders at all levels of the organization. In regard to active and finalized subprojects in leadENG please see the list below.

#### *Progressive learning goals*

Together with TECH we have designed a course and a pool of workshops that the studies can choose from to support the fulfilment of the newly introduced progressive learning goals throughout the study plans. This is concluded with an individual PBL portfolio that the students produce during one of the last semesters.

#### *first.math 2.0*

In collaboration with TECH, we completely remodeled the set-up for our first-year math-courses in linear algebra, calculus, and discrete mathematics. Rather than preparing for a written exam, the students now conduct mini projects related to their individual study and present it at an oral exam where not only the math teacher participate, but also a teacher from the given study. This has clearly increased motivation as well as transfer of knowledge.

#### *Specializations*

Danish universities are strongly regulated by the Ministry of Education and Research. However, we have been able to push the limits for the use of specializations thereby enabling more flexibility and freedom of choice for the students. This new practice has already impacted our programs significantly.

#### *leadENG student projects*

Kolmos et al. (2020) introduces a matrix for different types of student projects according to their level of interdisciplinarity and the type of collaboration between groups. The megaprojects are the most complicated with respect to both dimensions and AAUs experiments in this direction <https://www.megaprojects.aau.dk/> are therefore in the midst of further development. At ENGINEERING we have introduced the much more manageable concept of leadENG student projects where groups from different studies within engineering and science collaborate on designing a physical solution to a given problem related to the faculty's strategy

for interdisciplinary research on sustainability. The concept has been a huge success at all semesters of our studies and may serve as a steppingstone for future versions of megaprojects. Recently it received a gold medal as the best concept in Europe in connection with the Wharton-QS Reimagine Education Regional Awards 2022, <https://www.reimagine-education.com/#>

### *ENG after Hours*

A series of combined social and professional activities where the students can interact outside office hours and across studies, and where they get the chance to meet alumni. We have two types of events: broad thematical events (e.g. the outer space) and “rotational” events where one study is hosting visits from studies around ENGINEERING. In collaboration with the students, we arrange 6-8 of such activities every year, the largest involving around 170 participants.

### *Microcredentials*

A brand-new concept where small pieces of learning material are digitalized and are offered to the students across studies to support their project work in an on-demand way or could be taken as an extra-curricular activity. In addition, thematical courses could be offered based on students’ choice of microcredentials within a given area. Each microcredential is concluded with a multiple-choice test and a certificate is issued. The concept relates to the topic tree described in Morgan & Lindsay, (2015), but also differs in many ways. The main idea is that students can follow personal interests both within their own discipline, but also within completely different areas such as topics from SSH. This project is truly ambitious, and the development will take several years before we have a final model.

The list of subprojects is of course not exhaustive and new subprojects and opportunities will continue to appear.

## 4 Concluding remarks

In the spirit of PBL the leadENG project is developed in an ongoing process involving the many different stakeholders being students, supervisors, teachers, industry partners, management and not the least researchers in engineering education. The project is the sum of the contribution of all participants, and the transfer of inspiration, knowledge, and insight among them is key for the project to evolve successfully. Recent research conducted in connection with leadENG includes Christensen et al. (2023), Lindsay et al. (2023), Winther et al. (2022). We stress that even though leadENG started out as a vision-in-practice project it is important to note that one cannot revolutionize engineering education without generating solid empirical knowledge on the impact on students learning and contributions to the engineering profession in general. Therefore, research will play an important part in the future development of leadENG.

## References

Askehave, I., Prehn, H. L., Pedersen, J., & Pedersen, M. T. (2015). Problem-Based Learning (PBL). Aalborg University. 28 pp. Available from [https://prod-audxp-cms-001-app.azurewebsites.net/media/mmmjbtthi/pbl-aalborg-model\\_uk.pdf](https://prod-audxp-cms-001-app.azurewebsites.net/media/mmmjbtthi/pbl-aalborg-model_uk.pdf)

Bertel, L. B., Askehave, I., Brohus, H., Geil, O., Kolmos, A., Ovesen, N. & Stoustrup, J. (2021). Digital Transformation at Aalborg University: Interdisciplinary Problem- and Project-Based Learning in a Post-Digital Age. *Advances in Engineering Education*. 13 pp.

Big Beacon Manifesto (2014, accessed 2022). Available from <http://bigbeacon.org/big-beacon-manifesto.pdf>

Boelt, A. M. & Kolmos, A. & Holgaard, J. E. (2022) Literature review of students' perception of generic competence development in problem-based learning in engineering education. *European Journal of Engineering Education*, 47(1), 2022, pp. 1–22.

Chen, J. & Kolmos, A. & Du, X. (2021). Forms of implementation and challenges of PBL in engineering education: a review of literature. *European Journal of Engineering Education*, 46(1), 2021, pp. 90–115.

Christensen, R. B. & Dahl, B. & Fajstrup, L. (2023). Transforming First-Year Calculus Teaching for Engineering Students – Blocks with Field Specific Examples, Problems, and Exams. ArXiv:2302.05904, 2023, 5 pp.

Goldberg, D. E. & Somerville, M. (with Whitney C.) (2014). *A Whole New Engineer – The Coming Revolution in Engineering Education*. ThreeJoy Associates, Inc., Douglas Michigan. ISBN 978-0-9860800-4-3. 264 pp.

Graham, R. (2018). *The global state of the art in engineering education*. Massachusetts Institute of Technology, Boston, USA. ISBN 13: 9780692089200. 163 pp.

Kolmos, A., Bertel, L. B., Holgaard, J. E., & Routhe, H. W. (2020). Project Types and Complex Problem-Solving Competencies: Towards a Conceptual Framework. In Proc. of 8<sup>th</sup> International Research Symposium on PBL, pp. 56–65.

Kolmos, A. & Holgaard, J. H. & Clausen, N. R. (2021). Progression of student self-assessed learning outcomes in systemic PBL. *European Journal of Engineering Education*, 46(1), 2021, pp. 67–89.

Lindsay E. & Geil O. & Jeppesen, M. M. (2023). Microcredentials to support PBL. To appear in Proc. of IRSPBL 2023 TEE2023, 5 pp.

Morgan J. & Lindsay E. (2015). The CSU Engineering Model. In Proc. of 26<sup>th</sup> Australian Association of Environmental Education Conference, 8 pp.

Winther, M. & Routhe, H. W. & Holgaard, J. E. & Kolmos, A. (2022). Interdisciplinary Problem-Based Projects for First-Year Engineering Students. In Proc. of ASEE 2022 Annual Conference: Excellence through Diversity, p. 37017.



# From Project-Based to Work-Based Learning: Learnings from an Educational Transformation Process

Ron Ulseth

Iron Range Engineering, USA, [ron.ulseth@ire.minnstate.edu](mailto:ron.ulseth@ire.minnstate.edu)

Bart Johnson

Minnesota North College, USA, [bart.johnson@minnesotanoth.edu](mailto:bart.johnson@minnesotanoth.edu)

## Summary

In 2009, the Iron Range Engineering (IRE) program began delivering a PBL curriculum utilizing authentic problems from industry. The curriculum, based on the Aalborg University model, sought to create learning experiences that developed the complex problem solving, systems thinking, and interdisciplinary collaboration abilities students needed as practicing engineers. With the industry project at the center of the curriculum, the technical content learning took place in one-credit courses along with professional development of communication, teaming, and other leadership skills. Soon, requests started for the opportunity to perform paid co-op work at the industry partner in lieu of an on-campus industry project. An alternate curricular structure was implemented allowing students to complete the requirements for educational advancement while working full-time in industry. Quickly, it became apparent that the quality of the engineering learning experience was higher than it was for the students working for industry on campus. Inspired by the Charles Sturt Engineering program, a pilot model was developed for delivering the entire program as a co-op work-based learning model. By 2019, the IRE BELL work-based learning model was in full operation with students and industry locations from across the country. This extended abstract will share learnings from this educational transformation process.

**Keywords:** work-based learning, co-op, project-based learning, interdisciplinary, complex problem solving

**Type of contribution:** Best practice extended abstracts

## 1 Introduction and Background

Throughout the past quarter of a century, conferences have focused on; both national and international reports have called for; and research continually points towards the need for engineering education to evolve for engineers to meet the rapidly changing needs of society. Over this same time period, the way engineers interface with knowledge shifted from an engineer mindset of expertise through acquisition of knowledge to one of expertise of how knowledge is accessed and incorporated into engineering solutions. Combined with a need to increase the overall number of engineering graduates and for the demographics of engineers to match those of society's, significant pressure exists on engineering educators to explore and innovate with models and pedagogical approaches that systematically move engineering education into a position to meet these rapidly changing societal needs.

One model recognized (Graham, 2018) for its exploration and innovation is the Iron Range Engineering (IRE) program. In 2009, IRE began delivering a PBL curriculum (Ulseth, 2016 and Johnson, 2016) adapted from the Aalborg University PBL model (Kolmos, et al, 2007). In this model, authentic, ill-structured, and complex problems were sought directly from industry (Ulseth 2016). Students, working in teams, would spend one semester using an engineering design process to create solutions for their clients. The project was at the center of the curriculum and was supported by the learning of technical content delivered in one-credit

courses along with professional development of communication, teaming, and other leadership skills. The technical content and professionalism strategies were brought to the project where the learning of each was enhanced through experiential applications. This model was delivered as the last two years of the engineering bachelors (upper division). Entering students completed their lower-division requirements (calculus, physics, chemistry, and foundational engineering skills) at a community college in the United States. At the time of startup, PBL was not common in the United States and was met with pessimism by higher education peers and some in industry. However, over the next decade, PBL became much more accepted and desired. IRE gained national [ABET] and then international recognition (Graham, 2018) as an innovative model and engineering education leader. The value of the IRE model of engineering education experience came not just from the real, complex, industry-driven design projects, but also from the unique curricular components that help students frame and conceptualize their own learning as they prepare to move from learning in a formal academic space to a lifetime of learning as engineering leaders. The following unique elements, all of which are required in the student experience, are adaptable and transferable in most engineering programs.

Not very far into the model's delivery, some students requested the opportunity for paid co-op work instead of the on-campus industry project. An alternate support structure and curricular elements were developed and put in place so educational components could be completed while working full-time in industry. Quickly, it became clear that the engineering learning experience was of higher quality for students working in industry than for those working for industry on campus. This led to further exploration and curricular innovation and thus innovation with innovation. The innovation was not only based on a further desire to develop work-based competences during the education, but it was also based on (Johnson, et al., 2018): 1) empowering students to use employment to help fund their education while gaining recognizable experience, 2) to take advantage of the variety of emerging technologies for on-line learning, and 3) to increase access to the engineering profession by designing it specifically for community college students which bring a wider demographic diversity than the university counterparts.

In August 2019, the first 20 students from community colleges across the nation started the pilot program that would have the entirety of the upper-division program delivered as a co-op based educational experience. Modeled this time after the Charles Sturt Engineering program, the IRE Bell model began in 2019 and operated in parallel with the original IRE model.

## 2 Development Process for the IRE BELL Model

As the curricular development for this second iteration of the PBL program began in 2016, an appropriate design and research methodology was needed to guide the development work. Design-based research (DBR) was adopted as the development methodology (Ulseth and Johnson, 2018) to 1) address learning theories, 2) study learning in context, 3) develop measures of learning, and 4) contribute to new designs and learning theories. For this purpose, Andriessen's (2007) dual purpose of DBR model was combined and adapted to incorporate the four phases of DBR identified by Kolmos (2015) (Design, Implementation, Data Collection and Analysis, and Findings and Conclusions) to create an Adapted DBR Process Cycle (Figure 1).

The focus of the adapted DBR Process cycle is *program design* through *progressive refinement* of 1) the problem statement; 2) defining the design and learning objectives; 3) planning (project management) of the curricular design; 4) development of the curricular ideation and selection of a design for initial implementation; and 5) ultimately a continuously reformed model with a curricular model improvement process. The *research design* focuses on 1) establishment of the research questions; 2) identification of the learning theories applicable to the research work; 3) design of the research work that influences the curricular implementation and improvement; and 4) ultimately disseminating what is learned and adding to the body of knowledge on engineering education.

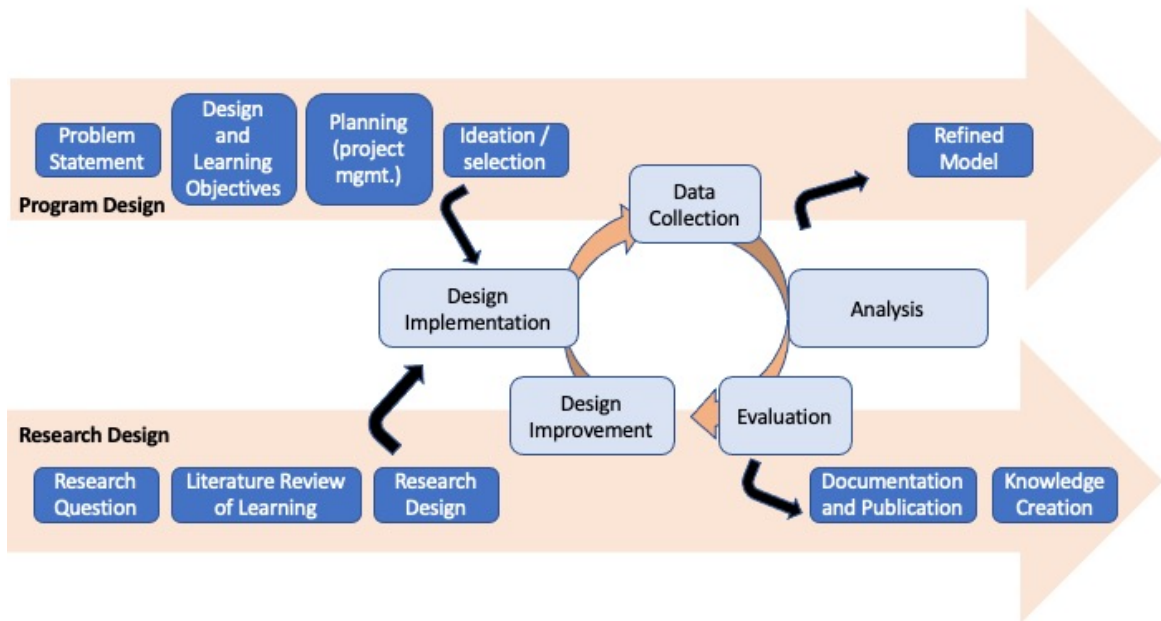

Figure 1. Adapted DBR Process Cycle

The cycle was specifically used to develop:

- curricular elements (Johnson *et al.*, 2018),
- understanding of how students and faculty members view new curriculum (Ulseth & Johnson, 2018),
- how students attained their first co-op placement (Rogalsky *et al.*, 2022), and
- how students developed their necessary workplace skills (Ulseth & Johnson, 2020 IRSPBL)

### 3 The Current IRE BELL Model

In September 2022, the two Iron Range Engineering models (four-semester on-campus and five-semester co-op based) merged. The result is termed Iron Range Engineering delivering the Bell model. Now, all students go through the intensive training semester followed by 24 months of co-op placements in industry.

The outcomes of the intensive semester, called the “Bell Academy” (Ulseth, Johnson, & Kennedy, 2021), are:

1. Provides the knowledge and skills necessary to find, interview for, and acquire co-op positions.
2. Student engineers learn and implement an engineering design process while completing a design project for an industry client.
3. Prepares them professionally to thrive as contributors on engineering teams while on co-op placement. Areas of learning include: leadership, self-awareness, professional actions, ethics, public speaking, technical writing, teamwork, and conflict management among others.
4. Develops self-directed learning capabilities as technical learners as they advance their acquisition of core technical knowledge and prepare to undertake advanced, student-led technical coursework.

These four themes of design, professionalism, technical, and career acquisition then flow into the rest of the curriculum in the remaining 24 months in the program while students continuously use their engineering experiences in industry to build and expand their knowledge.

#### 3.1 Technical learning

IRE students earn a bachelor's degree in engineering – BSE. Their official major is *integrated engineering*. It reflects a wide range of electrical and mechanical engineering principles which serve as the basis for deeper

learning in a focus area in any field of engineering. Student engineers are given the latitude to do their advanced learning across a broad range of areas of study or to dive deeply into one area. All technical learning is done in 1 credit (1 Carnegie unit) modules. 16 are core and 16 advanced to make up 32 technical credits in the upper-division (last 2 years of bachelors) experience. All technical learning has a strong self-directed component and is empowered through facilitation by professors. Each credit includes a deep learning activity where students apply their knowledge through experimentation, modelling, or design. (Ulseth, 2016)

### 3.2 Design learning

After the Bell Academy, student engineers continue to acquire design skills and project management by working on a wide range of project teams in their industry setting (Johnson & Ulseth, 2017). In this way they are learning design by doing design side-by-side with engineering professionals. They document this learning through extensive writing assignments during each of the four semesters, culminating in a substantial chapter in a senior thesis during their last semester. Special emphasis is put on the iterative nature of design and the value of encountering failure as part of the process. There is a strong system engineering aspect to the student engineer's design experience. They first acquire the knowledge and language of systems thinking and then apply it in an open-ended, final exam each semester.

### 3.3 Professional learning

While being a technically sound engineer with substantial design capability and experience are expectations of engineering graduates, what tends to set IRE graduates apart from their peers in industry is their professional acumen (Johnson, 2016). As part of their orientation, before the program's first day, students begin developing respect for being professionally responsible and embrace professional responsibility as the need to be responsive, communicate well across written and oral domains, perform as a valued member of a team, be ethical, be inclusive, and have the courage to act. These skills and attributes are developed through becoming self-aware of how they and others perceive their actions. Each semester student engineers complete ~50 one-page written reflections in their "learning journal" prompting them to think critically about how their actions and the actions of those around them impact work culture and team relationships. As in technical and design learning, students develop chapters in their senior thesis on both professionalism as defined by the literature and their professional self as identified through their engineering experiences.

### 3.4 Career acquisition

An outcome of the program is a well-honed skill in the ability to seek opportunities, market oneself, and acquire offers for employment. Entering student engineers face individual challenges that they need to overcome as part of this process. Some lack the self-motivation to put in the appropriate time and energy to create adequate opportunities, others lack the ability to represent their skills and experiences in writing or on technology-based platforms such as LinkedIn, while others lack the confidence or interpersonal skills to express their abilities in interview settings. Through a series of workshops and practice scenarios during the Bell Academy, students begin to build their confidence and acquire some of these skills. Their biggest growth comes through mentoring from their personal learning coach, an engineer on the staff who meets with the student weekly to provide guidance and encouragement as the student navigates the career search process seeking their first co-op to begin upon the conclusion of the academy (Rogalsky *et al.*, 2020, 2021, and 2022).

## 4 Lessons Learned for Education Transformation

Through the development and implementation of the original model in 2009 and the pilot Bell model in 2019, themes of necessity emerged for transformation of engineering education (Johnson *et al.*, 2022).

- Authenticity in the learning experiences is a necessary component. Student motivation peaks when they feel they are doing authentic work that has value and impact. This was achieved through industry projects and in the Bell model by working directly in industry with practicing engineers.
- The curriculum must reflect the desired outcomes. Important aspects for the model must be purposefully built into the curriculum. In this model, the development of professionalism is highly valued. Thus, professionalism courses make up 25% of the student experience every semester. In other words, important change cannot be accomplished through small or extra-curricular activities.
- Strong social connections are necessary. Relationships need to be cultivated between faculty/students and student/student. Physical spaces and a culture of trust, joy, collaboration, openness, and courage empower relationship building and the development of a common set of professional goals. These are necessary components as we seek to develop educational experiences that build engineers who will meet the needs of society, now and into the future.
- Transformative models are built through scaffolding of an entrepreneurial mindset. Structures such as the design-based research model implemented as part of the Bell pilot provide the purposeful approach to continuous improvement necessary to keep innovation alive.

## 5 References

- Andriessen, D. (2007). *Combining design-based research and action research to test management solutions*, 7th World Congress Action Learning, Action Research and Process Management, Groningen, 22-24 August, 2007.
- Graham, R. (2018). *The global state of the art in engineering education*. Massachusetts Institute of Technology, Boston, Massachusetts.
- Johnson, B. (2016). *Study of Professional Competency Development in a Project-Based Learning (PBL) Curriculum*. PhD dissertation. Aalborg University Press, DOI: 10.5278/vbn.phd.engsci.00092
- Johnson, B. & Ulseth, R. (2017). Student experience for the development of professional competencies in a project-based learning curriculum. *The International Journal of Engineering Education* 33, no. 3 (2017): 1031-1047.
- Johnson, B., Ulseth, R., & Wang, Y. (2018). *Applying Design Based Research to New Work-Integrated PBL Model (The Iron Range Engineering Bell Program)*. Proceedings of International Research Symposium on PBL. Tsinghua University, China.
- Johnson, B., Ulseth, R., & Rogalsky, D. (2022). *Design-Based Research: Multiple cohorts of students seeking co-ops in a co-op-centric educational model*. In *2022 ASEE Annual Conference & Exposition*.
- Kolmos, A., Krogh, L., & Fink, F. (2007). *The Aalborg PBL model*. Aalborg University Press.
- Kolmos, A. (2015). *Design-Based Research: A Strategy for Change in Engineering Education*, In: Christensen S., Didier C., Jamison A., Meganck M., Mitcham C., Newberry B. (eds) *International Perspectives on Engineering Education. Philosophy of Engineering and Technology*, vol 20. Springer, Cham.
- Ulseth, R. (2016). *Self-directed learning in PBL*. PhD dissertation. Aalborg University Press, DK.
- Ulseth, R., Johnson, B., & Kennedy, C. (2021). *Iron Range Engineering. Advances in Engineering Education*.
- Ulseth, R., & Johnson, B. (2015). *Iron Range Engineering PBL Experience*. Proceedings of Seventh International Symposium on Project Approaches in Engineering Education. San Sebastian, Spain.
- Ulseth, R. & Johnson, B. 2018. "Developing the Next Generation of Co-operative Engineering Education", *Project Approaches in Engineering Education (PAEE) 2018*, Brasilia, Brazil. March 2018.
- Lindsay, E. and J. Morgan, "The CSU engineering model: educating student engineers through PBL, WPL and an online, on demand curriculum", *European Journal of Engineering Education*, vol. 46, no. 5, pp. 637-661, 2021.

# Work-In-Progress: Integrating Critical Pedagogy with Project-Based Learning

Ryan Lundell

Santa Clara University, School of Education, United States, [rlundell@scu.edu](mailto:rlundell@scu.edu)

Jonathan Montoya

University of California, Irvine, School of Education, United States, [ilmonto1@uci.edu](mailto:ilmonto1@uci.edu)

Pedro Nava

Santa Clara University, School of Education, United States, [pnav@scu.edu](mailto:pnav@scu.edu)

## Summary

The separation of disciplines in secondary education is an inherent obstacle to project-based learning (PBL): educators go years without meaningful collaboration, critical feedback, or self-reflection (Jacobs, 2010). As a result, many inhabit an isolated bubble where no space is given to interdisciplinary collaboration; this isolation limits the authenticity of the projects students can produce. Compounding the dilemma is neoliberal logic, which disseminates the model of the market to all domains and activities (Brown, 2017). The curriculum is depoliticized; students are motivated to excel academically so they can compete in the market rather than work towards more societal equity. Additionally, marginalized groups are tracked into vocational pathways that focus only on basic skills training and give no space to critical thinking, which hurts the worker's ability to confront and transform inequitable neoliberal policies (Darder, 2017). While PBL in STEM and vocational pathways have positive impacts on teaching and learning outcomes, implemented without a critical pedagogy framework, PBL has not been shown to increase critical consciousness (Montoya et al., 2018). This research aims to discover how PBL and an interdisciplinary curriculum (Montoya et al., 2020) implemented through a framework of critical pedagogy can impact the critical consciousness of students and teachers.

**Keywords:** Neoliberalism, Neoliberal Logic, Interdisciplinary Curriculum, Critical Pedagogy, Critical Consciousness

**Type of contribution:** Research extended abstract

## 1 Obstacles to Project-Based Learning

In 1892, the National Education Association Committee of Ten, a group of educators asked to make recommendations for the future of schools, decided the most effective way to teach secondary students was to separate each discipline (Jacobs, 2010). Well over 100 years later and this structure of separation still goes unquestioned by teachers and administrators. Secondary schools still hold the same schedules, grouping patterns and spaces from the 1930s (Jacobs, 2010); however, century-old structures can't prepare students for the interconnectedness and innovation of today's science and engineering (Wang, et al., 2018). We don't just need reforms; we literally need *new forms* (Jacobs, 2010).

In 2018, to counter the silo structure of public education, I formed a cohort of teachers from different disciplines to create a building and construction curriculum that utilized interdisciplinary collaboration and project-based learning; I co-authored a paper about the results (Montoya et al., 2018). In this project, a team

of students analyzed sidewalks surrounding high schools in affluent and disadvantaged communities. They discovered that disadvantaged communities had unsafe conditions, so they organized a community clean-up and created a virtual design, Gantt chart, and budget to fix the sidewalks. Throughout the process, students received feedback from industry mentors and made a final presentation at Stanford University. Ultimately, the research revealed a positive impact on students' social mobility perceptions, but no impact on their social justice awareness (Montoya et al., 2018).

While the project provided interdisciplinary collaboration, project-based learning, and helped students get certifications to make them more competitive in the economy, we did not use a critical pedagogy framework to help students develop a critical consciousness. The driving force behind our curriculum was to engage students (Perry, 2022) and to make them employable; however, this approach only mirrors the absence of critical questioning that has historically existed in vocational education (Darder, 2017). This lack of critical thinking and an overemphasis on standardized testing perpetuates a false binary between “brain-work” and “hand-work” (Rose, 2014), so marginalized students get tracked into vocational programs that rarely give space for critical analyses of societal injustice, which only serves to frustrate the workers' ability to confront and transform inequitable economic and environmental policies (Darder, 2017). For instance, in Silicon Valley, building and construction pathways have become a road-to-nowhere and rarely lead to higher education or high-wage careers (Lundell et al., 2022). Ultimately, our own construction pathway utilized the concept of social justice as a symbolic gesture; we became what La Paperson calls the “second university:” hegemonic radicals who assume talking about freedom will result in freedom (2017). Like many second universities, we checked the box of project-based learning and social justice but never did the work and dialogue with students or the community to create space for critical consciousness, self-exploration, and transformation.

## 2 Neoliberal Logic and Education

Neoliberal economic policies compound the problem of secondary education's silo structure. For the last 40 years, neoliberalism has dominated the globe; this economic system celebrates free markets, deregulates industries, cuts social spending, privatizes public goods (such as education, prisons, and militaries), increases finance capital over productive capital, and converts every human need or desire into a profitable enterprise (Brown, 2017). Under neoliberalism, the United States ranks worst among industrialized nations in social mobility and other health and social metrics such as life expectancy, obesity, imprisonment, and mental illness (Wilkinson & Pickett, 2014). This economic system not only creates a society of the have and have-nots but also disseminates the model of the market to all domains and activities, and configures human beings exhaustively as market actors (Brown, 2017). Under neoliberalism, citizens are depoliticized, and a market logic becomes the foundation of all decisions and interactions. Saving the environment is good, if it serves the market; social justice is good, if it increases profits. Getting an education has value not because of personal growth and community contribution but rather because it increases our human capital in a competitive economic system that thrives off inequality. No longer is there a separation of political and economic life; neoliberalism formulates social justice, government investment, and environmental protection as fuel for economic growth (Brown, 2017). Under such a pervasive market ideology, equity and justice are reduced to the symbolic, and people of color face a “new racism” founded in myths of meritocracy and color blindness (Prashad, 2005). If neoliberalism causes such high levels of inequality, how does our education system, directly and indirectly, support and promote this ideology?

Public discourse on education tends to focus on the failures of schools, teachers, students, and curriculum, but rarely do we question how our economic system interacts with the structures and systems of public education; however, we can no longer talk about failing schools unless we are willing to discuss failing economic policies; the two have become so intertwined that it is difficult to tell where one ends and the other begins (Rose, 2014). Neoliberalism is an economic system where profit outweighs equality; similarly,

public education defines success by the scores of standardized tests that center on white settler-colonial epistemologies (La Paperson, 2017). As a result, students from underrepresented groups who do not fit or follow white settler-colonial norms are labeled “underachieving,” which puts them at risk of entering the school-to-prison pipeline (Nocella et al., 2018). In essence, neoliberalism and our failing schools feed into one another and not only strengthen and perpetuate societal inequities, but also, and perhaps most dangerously, “de-democratize” our citizenry by placing market logic at the center of the human psyche (Brown, 2017). Ultimately, if our curriculum is depoliticized and supplanted with market logic, how can we find solutions to the systemic inequities that impact our society? Without dialogue, solidarity, and critical consciousness, democracy doesn’t work for those who need it most.

### 3 The Opportunities of Critical Pedagogy

Project-based learning alone does not provide students with the space to contemplate and confront societal/environmental injustice. Critical pedagogy allows educators and students to believe that “history is a time filled with possibility...that the future is problematic [but] not already decided fatalistically” (Freire et al., 2020, p. 21). To dismantle the market logic of education, we must not only practice problem-based learning and interdisciplinary collaboration, but implement it through a lens of critical pedagogy, which gives us the tools to understand that “mass hunger and unemployment, side by side with opulence, are not the result of destiny” and “nothing can justify the degradation of human beings” (Freire, 1996; Reyes & Morrell, 2008, p. 54).

In critical pedagogy, the teacher moves to the role of facilitator and uses the dialogical method to engage in the act of creation and re-creation in which the students begin to develop a critical consciousness that allows them to confront and dismantle the source of their oppression (Freire et al., 2020). Freire argues that “dialogues cannot exist in the absence of a profound love for the world and for people...love is at the same time the foundation of dialogue and dialogue itself” (Freire et al., 2020, p.151). Within this pedagogy, the fundamental flaw of neoliberalism in schools is confronted: instead of learning to earn, students learn for freedom (Reyes & Morrell, 2008). Learning for freedom demands that one embrace praxis (reflection and action) (Freire et al., 2020). Educators and students must enter a partnership in which they become agents of social change determined to develop the capacity to reflect on and confront oppression in their lives and communities (Freire et al., 2020). Critical pedagogy not only gives teachers and students the tools to examine neoliberal systems and institutions with a critical lens, but also dismantles pervasive myths of meritocracy and color blindness. In the end, only a critical pedagogy founded in love can begin to dismantle a system where profit and growth outweigh justice and sustainability.

### 4 Integrating Critical Pedagogy with Project-Based Learning

As it presently stands, there is a radical separation between courses that exist for vocational training and courses that exist for critical thinking, and this drastically impacts the ability of the working class to change an inequitable neoliberal system (Darder, 2017). When vocational pathways utilize project-based learning through a lens of critical pedagogy, they teach employable skills while also creating space for critical thinking and community action.

Using my initial research as a point of departure (Montoya et al., 2018), I hope to discover the following through ethnographic data: how can an interdisciplinary curriculum implement using principles of PBL and critical pedagogy impact the critical consciousness of students and educators? Ultimately, vocational education must move beyond “reform reforms” and discover “revolutionary reforms” (Meiners, 2011); “reform reforms” come along every year and only support the present neoliberal logic: test-taking strategies, growth mindset seminars, and social-emotional learning techniques. However, these strategies never question how racism, discrimination, and poverty can truly be eradicated from our communities (Love, 2019). Ultimately, all these reforms add to doing yoga in a burning building.



Ethnographic data will be gathered at three different construction pathways in the East Side Union High School District (ESUHSD). In one of the three construction pathways, I will work with industry and university partners to implement an interdisciplinary curriculum utilizing principles of PBL and critical pedagogy. Similar to the demographics of San José, the students in these construction pathways come from diverse cultural and socioeconomic backgrounds. Many of these students have been tracked into our vocational pathway due to being labeled as behavior problems or academically deficient; in reality, these are the students who bear some of the heaviest impacts from four decades of neoliberal educational policies. In the dead-end maze of Silicon Valley construction pathways, critical pedagogy can operate as a compass that creates a way out. In the end, this research could influence other vocational pathways to move beyond simply educating for money and towards educating for freedom by not only merging project-based learning with an interdisciplinary curriculum, but also implementing this curriculum through a framework of critical pedagogy.

## 5 References

- Brown, W. (2017). *Undoing the demos: Neoliberalism's stealth revolution*. Zone Books.
- Darder, A. (2017). *Reinventing Paulo Freire a pedagogy of Love*. Taylor and Francis.
- Freire, P., Ramos, M. B., Macedo, D. P., & Shor, I. (2020). *Pedagogy of the oppressed*. Bloomsbury Academic.
- Jacobs, H. H. (2010). *Curriculum 21: Essential Education for a changing world*. ASCD.
- Love, B. L. (2019). *We want to do more than survive: Abolitionist teaching and the pursuit of educational freedom*. Beacon Press.
- Lundell, R., Montoya, J., Peterson, F., Kinslow II, A., Fruchter, R., Fischer, M., Bustamante, A., Nava, P. (2022). Looking Beyond Fiddlers Green College: Social Justice In Workforce Engineering Education Pathways. International Association for Continuing Engineering Education (IACEE) 2022, Buffalo, NY.
- Meiners, E. R. (2011). Ending the school-to-prison pipeline/building abolition futures. *The Urban Review*, 43(4), 547– 565. <https://doi.org/10.1007/s11256-011-0187-9>
- Montoya, J., Lundell, R., Peterson, F., Tarantino, S., Ramsey, M., Katz, G., Fruchter, R., Fischer, M., & Baldini, R. (2018). Building sustainable communities: A project-based learning approach to modify student perceptions of the building industry. ACEEE Summer Study on Energy Efficiency in Buildings, Asilomar conference center, Pacific Grove, CA. <https://doi.org/10.25740/tr806nn5051>
- Montoya, J., Peterson, F., & Bonilla, S. (2020). *Opportunity Gap and Women in the Energy Infrastructure Workforce*. In *8th International Research Symposium on PBL (IRSPBL)*, Aalborg, Denmark. <https://doi.org/10.25740/pm007md6862>
- Nocella, A. J., Parmar, P., & Stovall, D. (2018). From education to incarceration dismantling the school-to-prison pipeline. Peter Lang.
- Peperson, La. (2017). *A third university is possible*. University of Minnesota Press.
- Perry, A. (2022) Student Engagement, No Learning without It. *Creative Education*, 13, 1312-1326. <https://doi.org/10.4236/ce.2022.134079>.
- Prashad, V. (2005). Second-hand dreams. *Social Analysis*, 49(2). <https://doi.org/10.3167/015597705780886194>
- Reyes, D.-A. J. M., & Morrell, E. (2008). The art of critical pedagogy: Possibilities for moving from theory to practice in urban schools. Peter Lang.
- Rose, M. (2014). *Why school?: Reclaiming education for all of Us*. The New Press.
- Wang, H., Charoenmuang, M., Knobloch, N. A., & Tormoehlen, R. L. (2020). Defining interdisciplinary collaboration based on high school teachers' beliefs and practices of stem integration using a complex designed system. *International Journal of STEM Education*, 7(1). <https://doi.org/10.1186/s40594-019-0201-4>
- Wilkinson, R. G., & Pickett, K. (2014). *The spirit level: Why equality is better for everyone*. Bloomsbury Publ.



## Development of Professional Competences

# Work-In-Progress: Global Competency in Engineering Education - Are We Doing Well Enough?

Afandi Ahmad

Faculty of Electrical & Electronic Engineering, Universiti Tun Hussein Onn Malaysia, Malaysia, [afandia@uthm.edu.my](mailto:afandia@uthm.edu.my)

Shamsul Mohamad

Faculty of Electrical & Electronic Engineering, Universiti Tun Hussein Onn Malaysia, Malaysia, [shamsulm@uthm.edu.my](mailto:shamsulm@uthm.edu.my)

Muhammad Muzakir Mohd Nadzri

Faculty of Electrical & Electronic Engineering, Universiti Tun Hussein Onn Malaysia, Malaysia, [muzakirnadzri@gmail.com](mailto:muzakirnadzri@gmail.com)

Ashlee Pearson

Teaching & Learning Laboratory, Faculty of Engineering & IT, The University of Melbourne, Australia,  
[ashlee.pearson@unimelb.edu.au](mailto:ashlee.pearson@unimelb.edu.au)

Sally Male

Teaching & Learning Laboratory, Faculty of Engineering & IT, The University of Melbourne, Australia, [sally.male@unimelb.edu.au](mailto:sally.male@unimelb.edu.au)

## Summary

Global competence represents one's ability to work effectively across cultures. It is a crucial employability skill for graduate mobility in the international engineering market and working in a diverse workforce. This study investigated the presence of global competence in an electronic engineering program's curriculum at Universiti Tun Hussein Onn Malaysia (UTHM). Curriculum mapping was undertaken on the publicly accessible program handbooks and courses syllabus using a developed phrase bank of keywords indicative of global competence. Each course was then classified by the about matching to the keywords (strong, moderate, weak, no). A visual heat map was produced from the results to visually demonstrate the inclusion of global competence in courses. The findings demonstrated that 36% of the total courses in the electronic engineering program had strong or moderate evidence of global competency. This heatmap snapshot is a valuable reference for policymakers and curriculum developers to enable continual curriculum development works.

**Keywords:** Global competency, Engineering Education Curriculum

**Type of contribution:** Research extended abstracts

## 1 Introduction

Broadly, global competence is the ability to work effectively across cultures. It encompasses the ability to communicate across and appreciates other cultures, proficiency in working in or directing a team of ethnic and cultural diversity, and effectively dealing with ethical issues arising from cultural or national differences (Klein-Gardner & Walker, 2011).

In an engineering context, a globally competent engineer also applies these concepts to how engineering tasks might be approached and the engineering work itself, such as in product design and manufacture. Global competence is a vital employability skill for engineers due to the increase in mobility across geographical boundaries. As an example, Australia's engineering workforce draws migrant engineers from a multitude of countries (Kaspura, 2019).

This mobility is commonly recognised as necessary within engineering, for example, through international accords standardising engineering education between countries (International Engineering Alliance, 2021). It is, therefore, important for educators to consider how global competence is integrated across the curriculum for engineering programs. In this line of thinking, this paper proposes the overarching question – *to what extent is global competence integrated across a sample engineering program’s curriculum?*

This paper works to identify the current extent of global competence integrated into the Bachelor of Electronic Engineering (Honours) program at the Universiti Tun Hussein Onn Malaysia (UTHM)’s Faculty of Electrical and Electronics Engineering (FKEE). It aims to suggest improvements to strengthen global competence and form a reference for policymakers and curriculum developers to enable continual improvements.

## 2 Literature Review

Global competence is commonly discussed in engineering education, including through the lens of industry perceptions of value (Rawboon et al., 2021), in search of a definition (Majewska, 2022), assessment instruments (Mazzurco et al., 2020) as well as teaching interventions including certifications (Kjellgren & Keller, 2019) and new courses (Mekala et al., 2020).

To the extent of the author’s knowledge, no works currently investigate how global competence is implicitly embedded and developed across an engineering degree program. However, similar works have been undertaken in the context of other concepts, including sustainable development (Bury et al., 2022) and transversal skills (Kovacs et al., 2020).

This study contributes a method for understanding the extent of global competency development embedded in engineering curricula and identifying gaps in curricula holistically. It does this by studying the electronic engineering program at a particular university as a case study. It addresses an overarching question of *to what extent global competence is integrated across a sample engineering program’s curriculum?* by answering two sub-questions:

1. How is global competence embedded in the curriculum of the courses making up the sample program, and
2. Where are the gaps in global competence development in the program curricula?

## 3 Research Method

Previous studies have used curriculum heat-mapping techniques to study sustainable development (Bury et al., 2022) and studying transversal skills in academic curricula (Kovacs et al., 2020). In both cases, keywords indicative of the central concept were utilised to analyse the courses comprising a sample degree program or programs. In the case of Bury et al. (2022), this was done through manual analysis of course outlines and course handbook entries for a single degree (chemical engineering).

By comparison, Kovacs *et al.* (2020) used computational methods to analyse the frequency of specific transversal skills selected as part of standard course handbook information. In this application, the method utilised by Bury et al. (2022) is more appropriate as the course handbooks in question do not currently make space for the selection of graduate competencies developed within a course. This method was subsequently employed in this work.

A phrase bank of keywords, Figure 1, was initially developed by the paper’s first three authors (from UTHM). This was done by consulting literature and consolidating key themes drawing on the author’s knowledge and expertise. This phrase bank was further revised by the last author, who has expertise in graduate

competencies and employability skills. This phrase bank was further refined during pilot analysis to ensure specific phrasing being used was captured.

The publicly available academic handbooks and syllabus for all 58 courses in the Bachelor of Electronic Engineering (Honours) program at the Universiti Tun Hussein Onn Malaysia (UTHM)'s Faculty of Electrical and Electronics Engineering (FKEE) were downloaded and assessed from PROFORMA FKEE (FKEE UTHM, 2022) during September - November 2022 by the authors from UTHM. These were then analysed by the authors from UTHM using their experience and expertise to determine if and how the content of the handbook and syllabus matches the keywords in the phrase bank. The number of topics matching the phrase bank were documented manually. Using the number of topics matching the phrase bank, a heat map can be produced. The categorisations used in this paper, Figure 2, represent four levels of evidence: strong, moderate, weak and no evidence. The number of topics necessary to be reflective of each level were selected as an indicator to distinguish available evidence of global competence between strong, moderate, weak and no. From here, a visualisation of the heatmap can be produced.

Keywords	Global	<ul style="list-style-type: none"> <li>• Development</li> <li>• Globalisation</li> <li>• History</li> <li>• International</li> <li>• Sustainability</li> </ul>
	Competency	<ul style="list-style-type: none"> <li>• Health</li> <li>• Regulations</li> <li>• Safety</li> <li>• Technology</li> <li>• World</li> </ul>

Figure 1: Final phrase bank of keywords used to analyse handbook and syllabus entries

Heat & Description			Rubrics & Score	
Strong	Clear evidence	with the concept of global competency in multiple sections and related phrases that can be expanded	> 7 topics	5
Moderate	Moderate evidence		4 – 6 topics	3
Weak	Weak evidence		1 – 3 topics	1
No	The course entry has no evidence of global competency		0 topics	0

Figure 2: Legend and description of categories for courses in the heat map

## 4 Results & Discussions

A heat map was generated visually displaying the courses that related to each heat category, Figure 3. Of the 58 courses, the largest proportion (55%) had *no evidence* of the keywords used to indicate global competence. *Moderate evidence* of the keywords was the next most frequent result (26%), followed by both *strong* (10%) and *weak* (9%) categorisations.

Year 1 of the degree program has the highest number of courses with *strong evidence* of global competence, with three courses being categorised at this level. This includes three non-technical courses Islamic Studies (UQU10102), Nationhood and Current Development of Malaysia (UQU10103), Appreciation, Ethics and Civilisation (UQU10702) and Foreign Language (UHB1xx02). There are an additional two courses, including one technical engineering course, that were categorised with *moderate evidence* of global competence - Occupational Safety and Health (BEE12202) and Philosophy and Current Issues (UQI11202). In years 2 and 3 of the degree, there is a single course in each year level with *strong evidence* of the global competence

keywords. In year 3, this course is Engineers and Society (BEE32302), a technical engineering course, while in year two, it was a non-technical course. There were additionally three and four courses with *moderate evidence* of the global competence keywords in years 2 and 3, respectively. In year 4, there were no courses with *strong evidence* of global competence keywords. However, there are numerous seven courses with *moderate evidence*.

There is a pattern evident of an increasing number of courses with *moderate evidence* and decreasing number of courses with *strong evidence* between year levels. This increase in *moderate evidence* is typically in technical engineering courses, while those with *strong evidence* of global competence keywords are typically in non-technical engineering courses. This suggests that students develop global competence skills in non-technical engineering courses and later apply them in an engineering context. These later-year engineering courses are primarily using pedagogical strategies, including problem-based learning (PBL), case studies, or simulations with real problems based on a global context. Specialisation, elective, and final semester laboratory courses use a direct approach by listing special topics that require research and discussion on the latest global technological developments in their syllabus.

Course	Year 1 Sem 1	Year 1 Sem 2	Year 2 Sem 1	Year 2 Sem 2	Year 3 Sem 1	Year 3 Sem 2	Year 3 Sem 3	Year 4 Sem 1	Year 4 Sem 1
Generic -1	UQI10102	UQI11202	UQ*1xxx1	UQ*1xxx1					
Generic -2	UQU10103	UQU10702							
Core Engineering -1	BEE12202		BEE22402	BEE22503	BEE32302				
Core Engineering -1					BEE30103				
Mathematics	BEE10103	BEE11203	BEE20303	BEE32402	BEE32502				
Languages		UHB10102	UHB1xx02	UHB 20102		UHB 30102			UHB 40102
Electronic -1	BEJ10102	BEJ10201	BEJ20503	BEJ20303	BEJ30701	BEJ30303	BEE32205	BEE40602	BEE40704
Electronic -2	BEJ10303	BEJ10403	BEJ20102	BEJ20603	BEJ30503	BEJ30203		BEE40803	
Electronic -3	BEJ10702	BEJ10503	BEJ20203	BEJ20403	BEJ30403	BEJ30603			
Electronic -4		BEJ10603			BEJ30103				
Specialisation -1						BEJ32202		BEJ42303	BEJ42203
Specialisation -2						BEJ32103		BEJ42103	
Elective								BEJ42803	EEF40103
Laboratory	BEJ10801		BEJ20701	BEJ20801		BEJ30801		BEJ40401	BEJ42001

Legend    Strong    Moderate    Weak    No

Figure 3: Heat map of the global competency integration level in the Bachelor of Electronic Engineering with Honours

The overall global competency heat map has highlighted gaps in the curriculum. This is because primarily those with *strong evidence* are non-technical engineering courses. Similarly, where technical engineering courses have higher than *weak evidence* of the keywords, they are in the later years of the degree program. The findings of this study are just the beginning of assessing the presence of global competency in this curriculum and are intended to be used in subsequent curriculum redesign efforts.

A significant limitation of this method of curriculum mapping is that it relies on direct alignment between the reported syllabi and handbook entry and the delivered curriculum. Similarly, the outcomes of the curriculum mapping are only as good as the keywords that have been selected and the ability of the researcher to identify them from within the syllabi and handbook. However, for the purpose of capturing a snapshot of the curriculum and starting a conversation about holistic curriculum design, the method has produced sound results. The outcomes of this study can be used by policymakers directing the engineering curriculum at UTHM to add value to the university's current internationalisation ecosystem. Understanding where the degree program currently sits allows for more nuanced discussions and allocations of resources to further the development of students' global competency.

## 5 Conclusions & Future Works

The global competency “heat” mapping of this study quickly and visually provides an overview of the status quo and gap, which is helpful for policymakers and curriculum developers. This mapping is also essential benchmark data that can inform further action. The presented study is a work-in-progress that is now being enriched with more in-depth analysis, including evaluating other reference documents such as test questions, assignments, projects, field studies, and exams to add value to the existing mapping. Other methods, such as interviews and questionnaires among stakeholders such as students, lecturers, and alumni, can also strengthen the research findings. With more accurate mapping, better policies and action plans can be prepared to support a future-proof engineering education curriculum to produce engineers who act as game changers for global prosperity.

## 6 References

- Bury, N., Honig, C., Male, S., & Shallcross, D. (2022). Mapping Sustainable Development in Engineering Curricula. *Proceedings of AAEE 2022 Western Sydney University, Sydney, Australia*, 1–10.
- FKEE UTHM. (2022). *Academic Proforma 2022/2023 Bachelor of Electronic Engineering with Honours*. <https://cad.uthm.edu.my/muat-turun/proforma-v3/2-uncategorised/168-academic-proforma-2022-2023.html>
- International Engineering Alliance. (2021). *Graduate Attributes & Professional Competencies* (Issue June). <http://www.ieagrements.org>
- Kaspura, A. (2019). The Engineering Profession: A Statistical Overview. In *Institution of Engineers Australia* (Issue June). [https://doi.org/10.1142/9781786342294\\_0011](https://doi.org/10.1142/9781786342294_0011)
- Kjellgren, B., & Keller, E. (2019). Introducing Global Competence in Swedish Engineering Education. *Proceedings - Frontiers in Education Conference, FIE*, 1–5. <https://doi.org/10.1109/FIE.2018.8659122>
- Klein-Gardner, S. S., & Walker, A. (2011). Defining global competence for engineering students. *ASEE Annual Conference and Exposition, Conference Proceedings*. <https://doi.org/10.18260/1-2--17701>
- Kovacs, H., Delisle, J., Mekhaie, M., Zufferey, J. D., Tormey, R., & Vuilliomenet, P. (2020). Teaching transversal skills in the engineering curriculum: The need to raise the temperature. *SEFI 48th Annual Conference Engaging Engineering Education, Proceedings*, 906–917.
- Majewska, I. A. (2022). Teaching Global Competence: Challenges and Opportunities. *College Teaching*, 1–13. <https://doi.org/10.1080/87567555.2022.2027858>
- Mazzurco, A., Jesiek, B. K., & Godwin, A. (2020). Development of Global Engineering Competency Scale: Exploratory and Confirmatory Factor Analysis. *Journal of Civil Engineering Education*, 146(2). [https://doi.org/10.1061/\(asce\)ei.2643-9115.0000006](https://doi.org/10.1061/(asce)ei.2643-9115.0000006)
- Mekala, S., Harishree, C., & Geetha, R. (2020). Fostering 21st century skills of the students of engineering and technology. *Journal of Engineering Education Transformations*, 34(2), 75–88. <https://doi.org/10.16920/jeet/2020/v34i2/150740>
- Rawboon, K., Yamazaki, A. K., Wongsatanawarid, A., & Oda, S. (2021). Global Competencies for Engineering Program Graduates from an Industry Perspective. *International Journal of Learning and Teaching*, 7(1), 7–14. <https://doi.org/10.18178/ijlt.7.1.7-14>

# Work-In-Progress: Analysis of the Incidence of a Pedagogical Intervention Centered on PBL Methodology and the Teaching of Critical Thinking Skills, in the Solving of Mechanical Physics Problems, in Engineering Students.

Ignacio Laiton P.

Escuela Tecnológica Instituto Técnico Central, Bogotá, Colombia, [ilaiton@itc.edu.co](mailto:ilaiton@itc.edu.co)

## Summary

Developing problem-solving skills, as well as critical thinking skills in students of any educational level, is considered both a considerable shortcoming in education, and one of the key objectives of education, in addition to being considered within the skills necessary for education in the twenty-first century, as can be evidenced in OECD documents, UNESCO, among others. The objective of the research presented in the current work is to identify the incidence of the application of a pedagogical intervention, based on the PBL (Problem Based Learning) methodology, also supported by active methodologies such as flipped classroom, thinking routines, ICT among others, in the ability to develop critical thinking skills, reflected in the willingness to solve problems of mechanical physics in engineering. A pedagogical intervention applied during several semesters in the classrooms of a higher education institution in Bogotá, Colombia, is planned in detail. A modified set of problem situations is designed, as a data collection instrument, a coding system is also built with the aim of translating the data and performing the respective quantitative analysis. It is intended to make the comparison between an intervened group and a control group, identifying the expected incidence.

**Keywords:** Critical Thinking, Problem Based Learning, Solving Problems, Active Learning.

**Type of contribution:** Research extended abstracts.

## 1 Introduction

The starting point remains, even in the advanced 22 years of our twenty-first century, to find students in Colombian universities who, when faced with a problem situation, intend to arrive, in an extremely mechanical way, to an immediate solution, without even considering the development of a work plan, a logical process, a process to reach the solution, A solution with meaning, which in 100% of cases in engineering, represents a solution to a real problem. Problems that, in the case of science, usually entail a very high degree of complexity and conceptual understanding (Glaxton, 2018). The above situation leads to the little appropriation of knowledge by the individual, leading him to a simple repetition of data or purely rote procedures in the development of an academic test. It is proposed in this work, that the current active methodologies that are generated from different working groups in the world provide ideas for the education of the XXI century, which are just beginning to be put into practice at the global level and that it is urgent to put them into practice, particularly in countries such as Colombia, where the social gap, Economic and educational is magnified with each event or international contingency. Methodologies such as "Problem Based Learning" (PBL), Flipped Classroom, Making Learning Visible (MLV), Making Thinking Visible (MTV), among others, are elements that, at least in Colombia, are only being applied in an educational elite of some



secondary education institutions, with sufficient resources and intentions to pretend to offer a quality education to their students, but that, in no way does it involve the full number of students from the different social levels of education in Colombia.

Returning to the issue of the contributions of active methodologies to current education, several works expose the benefits of the use of active methodologies in the teaching of physics in higher education (Sujarittham, 2016; Rehmat & Hartley, 2020), describing how such methodologies have grown in terms of their use dramatically in recent years, particularly in countries such as the United States. It is assumed that this type of methodologies is those where the student has a permanent participation, much greater than in traditional instructional education, both in the work within the classroom, and in the independent work that the student must develop. From which emerges a wide range of strategies, from pre-designed worksheets to the use of thinking routines, or gamification method.

For the particular case of the use of teaching critical thinking skills in higher education, some works such as those of Leonard, Gerace and Dufresne (2002) show the results of a methodology they call "Problem solving based on analysis", where the results obtained by students demonstrate that they can improve their performance in solving problems, solving a typical classroom physics problem does not necessarily involve understanding the concepts involved. His analysis highlights an important aspect from the point of view of this project since it relates the use of thinking skills as an element to reach such understanding. Similarly, works such as those of Fabby and Koenig (2015) highlight the relationship between scientific reasoning and problem solving in physics, highlighting that complex problems require a high level of reasoning, which has not been developed as expected in novice engineering students.

Guirado, Mazzitelli and Maturano (2013), focus on the strategies used by students, Guisasola, Ceberio and Zubimendi (2011), observe how students solve problems from guided research, Truyol, Sanjosé and Gangoso (2014) focus on well-defined and poorly defined statements and their impact on student performance, It is observed then that there are several works related to problem solving, which consider great contributions to the integral formation of the individual. Finally, Franco, Almeida and Saíz (2014), Beltrán and Torres (2009), among others, insist on the importance of involving, together with the contents of the different subjects, the teaching of critical thinking in current education.

In the case of teaching skills in solving problems in physics, which constitutes one of the most important processes on which engineering education is based, (Marulis and Nelson, 2020) as a complex process, which requires elements of self-regulation, planning, execution, monitoring and evaluation of the process, as well as the ability to adapt their behaviors to different types of academic tasks, in addition to the orderly and structured knowledge of a specific domain. Precisely, also in the field of sciences, (Zohar & Barzilai, 2013) and in particular physics (Haeruddin & Supahar, 2020) there are also works where the ways in which critical thinking skills, coordinated with metacognitive ones, allow coordinating, monitoring and evaluating the use of cognitive skills in problem solving are studied, these investigations agree that students who demonstrate a high variety of critical thinking skills perform better in solving problems, reflect on their process, learn from their mistakes, and make appropriate decisions in order to solve the problem at hand.

Finally, in relation to the PBL methodology, according to the different consultations, it appears with its first applications in the medical school of the University of Case Western Reserve in the United States, around the 60s, as well as in the McMaster University in Canada in the 70s. It is identified as a methodology that appropriates the student of his own training process, must involve real-life problems in his themes, and is expected to have an interdisciplinary approach. Sipes (2017) indicates that the PBL methodology has been applied in a multiplicity of research, which, although most of them do not show empirical results, entail the usefulness and effectiveness of its use in the private teaching of engineering sciences. Rehmat and Hartley (2020), as well as other studies (La Force, Noble & Blackwell, 2017), investigated the positive impact PBL demonstrated in teaching STEM-focused critical thinking skills. In relation to the current project, none of the

research previously stated and consulted refers to the use of specific pedagogical interventions, nor to the use of active methodologies.

## 2 Methodology

For the study, 84 students belonging to the Mechatronics career, second semester of a higher education institution in the city of Bogotá, Colombia, enrolled in the subject of Mechanical Physics during the two semesters of the year 2021, were included in the first part of the project. They were invited to participate in the first part of this study of pre-experimental type, focused on the identification of the use of cognitive skills of students in the case of solving problems in mechanical physics, and its incidence in the adequate solution of the process. A package of ten problems generated by the researcher's working group was designed on the topics of the corresponding subject: kinematics, dynamics and work and energy. An instrument was also generated for the quantification of the variable "use and incidence of critical thinking skills in problem solving", as well as an adequate way to operationalize the variable in question. The set of selected problems was applied in a session at the end of the school semester, during which the teacher applied a classic master methodology.

The definition of problem is assumed here as that new situation (for an individual), for which the student does not have enough information to be able to solve said situation, which invites him to develop a plan, collect information and find tools that guide him in the process. Also understanding that a situation can be a problem for one individual, but not for another. It is also assumed that there are complex situations that even involve interdisciplinary knowledge, as well as other more specific ones located in the particular domain of physics, such as the behaviour of an object when it is thrown into the air, but that together with all the accumulated knowledge during an academic semester, and semester after semester, they build solid foundations for later constructions as a professional.

It is intended that, in the second part of the project, a pedagogical intervention is carried out with an approximate group of 40 students, while maintaining a control group of 35 students from a higher education institution in Bogotá, Colombia. For the second semester of 2022 and first of 2023, the second part of the project will be developed, in which students are asked to address a problem of everyday life, to which the knowledge learned in the mechanical physics course must be applied. The objective is to address the contents of the subject in an integrated way through the choice of a real-life problem (throwing a ball, taking off from an airplane, etc.). In this case it is about applying the concepts of kinematics, dynamics and work and energy in the chosen problem. The content is approached from active methodologies, such as flipped classroom, Making Learning Visible (MLV), metacognition skills, among others. At the end of the corresponding semester, the set of problems designed as a data collection instrument will be applied, to identify, through quantitative analysis, if there are significant differences in the performance of students during the problem-solving process.

## 3 Partial and Expected Results

It should be noted here that there are hardly any preliminary results of the first part of the Project, where we tried to identify the existence and use of critical thinking skills that students use during the process of solving problems in physics. Based on the classic approaches of problem-solving experts, the process is divided into categories; Scenario, Phenomenon, Relationships between variables and Mathematical modeling. (These categories are clearly defined in the project, built in the work team, but they exceed the limits of this summary.) The necessary skills for each category are also related, such as planning, describing, perceiving, identifying, generating processes, deepening, specifying, making decisions, among others.

The quantification of the results is done according to five stages. Stage one is assigned the highest level of adherence to the problem-solving process, as it relates to critical thinking skills in problem solving.

Consequently, this level is in turn assigned the highest score (4), and from there the other scores are assigned until reaching zero in the case where the student does not have any clarity about the objective of the category, does not use in any degree the necessary skills. The statistical descriptive analysis of the data for each step of the process of solving the problem situations in each of the stages is shown in Table 1.

Table 1 – Descriptive Statistics by Categories.

	<i>Scenario</i>	<i>Phenomenon</i>	<i>Relations</i>	<i>Mathematical</i>
Media	1,86309524	1,76785714	1,43452381	1,2202381
Media in percentage	46,58	44,2	35,86	30,5
Typical error	0,11908237	0,11007593	0,1070111	0,10989847
Median	2	2	1	1
Fashion	0	0	0	0
Standard Deviation	1,54348387	1,42674712	1,38702232	1,42444693
Sample Variance	2,38234246	2,03560736	1,92383091	2,02904904
Kurtosis	-1,5000660	-1,3375296	-1,0066118	-0,7347072
Asymmetry Coefficient	0,06400198	0,17913673	0,54598298	0,81211496
Rank	4	4	4	4

Since the highest score for each category was 4, it is observed in Table 1, as a minimum score zero, mode zero, clearly identifying the shortcomings evidenced in the process. In addition, it is found that the averages of the four categories reach only 46.58% of the maximum score in the "scenario" category, adding the identification of a clear downward trend. It should be noted here, since it is not intended to break down the entire process followed, that the four categories are intended to be sequential process, so that the scenario category is the first, where the physical and geometric characteristics of the phenomenon are identified, starting point to identify phenomena, relationships and finally reach the mathematical results. It is evident that the lack of an adequate perception of the situation, an adequate description, identification of general aspects of the problem, but more importantly, the lack of planning and generation of strategies leads to a wrong process, which ends in a poor and inaccurate result.

Regarding the expected results in the second part of the project, it should be said that when designing a pedagogical intervention with detailed planning for each of the sessions of the intervened group, including activities, sources of information making use of ICTs, as well as a permanent formative evaluation, based on making the thought visible, and based in general on the approaches of the methodologies indicated above, They should lead to better student performance in solving problems.

## 4 References

- Beltrán, Juliana. y Torres, Nydia. (2009) Caracterización de habilidades de pensamiento crítico en estudiantes de educación media a través del test HCTAES. Zona Próxima, Vol. 11, 66-85.
- Claxton, G. (2018). *The Learning Power Approach: Teaching Learners to Teach Themselves*. Corwin, London.
- Fabby, C. & Koenig, K. (2015). *Examining the Relationship of Scientific Reasoning with Physics Problem Solving*. Journal of STEM Education. Vol 16, n° 4, 20-26

- Franco, A. Almeida, L. & Saiz, C. (2014). *Pensamiento crítico: reflexión sobre su lugar en la Enseñanza Superior*. *Educatio Siglo XXI*, Vol. 32, n° 2, 81-96.
- Guirado, A. Mazzitelli, C. & Maturano, C. (2013). *La Resolución de Problemas en la Formación del Profesorado de Ciencias: Análisis de las Opiniones y Estrategias de los Estudiantes*. *Revista Eureka Sobre Enseñanza y Divulgación de las Ciencias*. Vol. 10, número extraordinario, 821- 835.
- Guisasola, J. Ceberio M. Almudí J. y Zubimendi J. (2011) *La resolución de problemas basada en el desarrollo de investigaciones guiadas en cursos introductorios de Física*. *Enseñanza de las Ciencias*. Vol. 29, n°3, 439-452.
- Haeruddin, Prasetyo, Z. & Supahar. (2020). The Development of a Metacognition Instrument for College Students to Solve Physics Problems. *International Journal of Instruction*. 13(1), 767-782. <https://doi.org/10.29333/iji.2020.13149a>.
- LaForce, M., Noble, E., & Blackwell, C. (2017). Problem-Based Learning (PBL) and Student Interest in STEM Careers: The Roles of Motivation and Ability Beliefs. *Education Sciences*, 7(4), 92. MDPI AG. Retrieved from <http://dx.doi.org/10.3390/educsci7040092>.
- Leonard, W. Gerace W. & Dufresne R. (2002). Resolución de problemas basada en el análisis : hacer del análisis y del razonamiento el foco de la enseñanza de la física. *Enseñanza de la Ciencias*. 20(3). 387 – 400. DOI: [10.5565/rev/ensciencias.3955](https://doi.org/10.5565/rev/ensciencias.3955)
- Marulis, L. & Nelson, L. (2020). Metacognitive processes and association to executive function and motivation during a problem-solving task in 3-5 years old. *Metacognition and learning*. <https://doi.org/10.1007/s11409-020-09244-6>
- Meltzer, D. & Ronald, K. (2012). Resource Letter ALIP–1: Active-Learning Instruction in Physics. *American Journal of Physics*. 80, 465-478 doi: 10.1119/1.3678299.
- Rehmat, A. Hartley, K. (2020). Building Engineering Awareness: Problem Based Learning Approach for STEM Integration. 14(1), DOI: <https://doi.org/10.14434/ijpbl.v14i1.28636>.
- Sipes, S. M. (2017). Development of a Problem-Based Learning Matrix for Data Collection. *Interdisciplinary Journal of Problem-Based Learning*, 11(1). Available at: <https://doi.org/10.7771/1541-5015.1615>
- Sujarittham, T. Emarat, N. Arayathanikul, K. Sharma, M. D. Johnston, I. & Tanamatayarat, J. (2016). Developing specialized guided worksheets for active learning in physics lectures. *European Journal of Physics*, 37(2). DOI 10.1088/0143-0807/37/2/025701
- Truyol, María. Sanjosé, Vicente. y Gangoso, Zulma (2014) *Obstacles modeling reality: Two Exploratory Studies on Physics Defined and Undefined Problems*. *Journal of Baltic Science Education*, Vol.13, n°6, 883-895.
- Zohar, A. & Barzilai, S. (2013). A review of research on metacognition in science education: Current and future directions. *Studies in Science Education*, 49(2), 121-169. DOI: 10.1080/03057267.2013.847261

## Facilitating PBL Meta-competences in Engineering Education

Jette Egelund Holgaard

Aalborg Center for PBL in Engineering Science and Sustainability under the auspices of UNESCO, Aalborg University, Denmark,  
[jeh@plan.aau.dk](mailto:jeh@plan.aau.dk)

Asbjørn Romme

Aalborg Center for PBL in Engineering Science and Sustainability under the auspices of UNESCO, Aalborg University, Denmark,  
[romme@plan.aau.dk](mailto:romme@plan.aau.dk)

Henrik Worm Routhe

Aalborg Center for PBL in Engineering Science and Sustainability under the auspices of UNESCO, Aalborg University, Denmark,  
[routhe@plan.aau.dk](mailto:routhe@plan.aau.dk)

Anette Kolmos

Aalborg Center for PBL in Engineering Science and Sustainability under the auspices of UNESCO, Aalborg University, Denmark,  
[ak@plan.aau.dk](mailto:ak@plan.aau.dk)

### Summary:

In this extended abstract, an initial conceptualisation of meta-competences is presented. A case-example from Aalborg University is outlined as one way to enhance meta-competence. In the case-example, students are facilitated to prepare PBL competence profiles. Preliminary findings reading through more than 150 competence profiles show that students hardly touch upon how they adapt and adjust their problem-based learning (PBL) competences to new problems. We end the paper by corroborating the importance of meta-competences, but at the same time we point to the necessity of re-thinking educational practice.

**Keywords:** Generic competences, Transformation, Meta-competence, Competence profiling

**Type contribution:** Extended research abstracts

In alignment with the European Qualification Framework, competence refers to responsibility and autonomy and specifies the ability to apply knowledge and skills in a work situation or a study-related context (Ministry of Higher Education and Science, 2020). This encompasses the notion that knowledge and skills are established to address unpredictable and changeable contexts. This also includes taking responsibility for one's work and one's learning, as well as that of others. The core of this understanding relates to the transfer of knowledge and skills and their application in new situations.

This application discourse has, however, been criticised for being too simplistic. Although they recognise the role of learning outcomes as a trajectory for learning, Havnes & Prøitz (2016) argue that the political system's aerial perspective has led to a situation in which a behaviouristic approach to learning objectives and a focus on 'to do' achievements has gained ground. Consequently, more cognitive and sociocultural participatory perspectives have been neglected, together with aspects of self-formation (Havnes and Prøitz, 2016, p. 208):

*“When striving to achieve a clearly stated LO, students may learn about themselves as learners, potentially forming an identity and developing ideas about the learning context. All of these are LOs that are neither stated nor regarded as guiding the learning process. Of course, if they are stated, they form a basis for potentially new subjects of meta-level learning.”*

This paper works from the assumption that such meta-level learning can provide meta competences which move beyond the level of competence and the focus on knowledge transfer to knowledge transformation. The question we address is:

How can meta-competences be conceptualised in a PBL perspective and how can such conceptualisations of meta-competence inform engineering education practices?

We do not intend to argue for a specific understanding of meta-competence or “best-practices” to reinforce meta-competences. Instead, we address this question by exemplifying how an understanding of meta-competences can inform an educational design in a PBL setting.

### **Conceptualisation of Meta-competence**

It is important to note that meta-competences are first and foremost about competences, not meta-reflection, not meta-cognition and not self-regulation. Such issues may be relevant and play a part in meta-competences, but they are inherently secondary. Consequently, it is impossible to have a fully elaborate idea of meta-competences without an elaborated idea of competences.

In this context we rely on the definition from Vitello et al. (2014:4) stating that *“Competence is the ability to integrate and apply contextually-appropriate knowledge, skills and psychosocial factors (e.g., beliefs, attitudes, values and motivations) to consistently perform successfully within a specified domain”*. We however redraw from considering what would take to “consistently perform successfully”, as we delimit ourselves from the normative assessment of success.

There are at least two literal meanings stemming from the ‘meta’ suffix. Bridges (1993) pointed out a distinction between the process of applying something learned in one context to another, and a person’s ability to select, adapt, adjust and apply one’s other competences. Whereas the first can be related to transfer of knowledge, the other can be related to a kind of ‘competence reshaping’. This understanding indicates that meta-competence involves a transformation process – transfer of knowledge and skills is not enough, as the basic purpose changes from the right use of knowledge and skills to the right approach to competence management and development. Carlile (2002, p. 453) emphasised that transformation is a process that recognises that “knowledge is localized, embedded, and invested in practice”. In a PBL the transformation process is targeted a real-life problem.

Following the definition of competence (Vitello et al., 2014:4) and the use of ‘meta’ as related to transformation, we suggest the following understanding of meta-competence in a PBL perspective: Meta-competence is the ability to select, adapt, adjust and apply competences to address a real-life problem, whereas competence is the ability to integrate and apply contextually-appropriate knowledge, skills and psychosocial factors within a specific domain.

Besides combining the beforementioned theoretical framework, we underline the move from the domain specific to the problem specific, which might include very different domains. Thereby meta-competence is seen as a domain transcending concept.

The move from transfer to transformation furthermore complicates the learning process. Mezirow (2012) referred to transformation as a movement through time to reformulate and manifest structures of meaning by reconstructing dominant narratives. He argued that in alignment with transformative theory, it is crucial for the learner to become critically aware of one's own tacit assumptions and expectations, as well as those of others, and to assess their relevance in the making of an interpretation. Although the curriculum is comprehensive in its approach to fostering the development of students knowing, acting and being, each student will evidently have their own narrative of their personal and individual competence development (Barnett, 2010, 2011).

Thus, we must also move our attention to the personal experiences and perceptions of competence. In terms of the previous discussion, this includes the way students formulate and reformulate their self-perceived competences and even more importantly the narratives behind them. Such an awareness provides an opportunity to reveal patterns in the way one reshapes and develops competences and through reflexivity this might open new pathways of competence development.

### **PBL competence profiles - a potential steppingstone towards meta-competence**

In the PBL environment at Aalborg University (AAU), generic competences are classified under the heading of PBL competences to underline that the focus is on the competences to identify, analyse and solve a given problem. During a restructuring of all curricula at AAU, the intention has been to integrate a higher and more progressive degree of intended learning outcomes for PBL. A PBL competence profile was introduced as a way for students to reflect on and articulate competences gained from studying in the PBL environment.

Most of the Danish engineering and science students follow a three-year bachelor's programme and thereafter continue onto a two-year master's programme. The competence profiles introduced at AAU are requested of students in the latter part of the fourth year of engineering and science studies. Before students reach the level of articulating their PBL competences, considerable efforts have been made to support students in developing such competences. During the first semester of all engineering and science programmes, a 5 ECTS (European Credit Transfer System = approx. 150 hours of study) PBL course is designed to prepare students for studying in a PBL environment. PBL workshops arranged by PBL research staff are integrated in all bachelor's curricula to support the ongoing maintenance and development of PBL competences. Finally, students spend 50% of their time in project teams, where in a student-directed format they address real-life problems within curricular framings. This provides students with a living lab in which to develop their PBL competences by relating PBL theory to practice.

Supporting students in developing their PBL competence profile is arranged using a combination of workshops, self-study activities and feedback, and aims to enable students to do the following:

1. Explain the purpose, content and prospects of a PBL competence profile.

2. Evaluate PBL competence descriptions based on predefined criteria, whereas the most fundamental criterion is that a competence profile should include personal experiences and prospects.
3. Prepare a PBL competence profile based on their own experiences of working within a PBL environment.
4. Reflect on the potential to develop the PBL competence based on facilitator feedback.

The workshops rely on the active participation of students in a flipped format, and thereby it is expected that students have read a guide beforehand on how to prepare a PBL competence profile (for more information, see Holgaard & Kolmos, 2021). After the workshop, students should be able to finalise a first draft of their competence profile as a self-study activity (approx. 3 hours), and they submit this competence profile to complete the course activity. However, each student receives qualitative feedback on their profile to guide them in using this first iteration as a baseline for further development.

What Mezirow (2012) would term different frames of references are used to invite students to reformulate, question and attach meaning to in relation to their own PBL competences, e.g., competence frameworks such as 21<sup>st</sup> century skills. By elaborating on their own experiences and interpretations of PBL competences together with peers, the intention is to make students critically aware of their own tacit assumptions and expectations and to potentially be able to develop and even articulate meta-competences. For example, what might seem like purely structural competences when using a specific agile project management system might, upon reflection and peer-learning, contribute to different strategies for project planning depending on the problem (meta-competence). This is not to be confused with the ability to apply a given project management framework such as SCRUM in different contexts (competence).

To facilitate a development approach, we intentionally asked for students to clarify their competences:

- *Experience*, to ensure that the competence is based on personal experiences.
- *Variation*, as this increases the span of competences developed.
- *Personal contribution*, to distinguish the responsibility of one's own learning from that of others.
- *Potential*, to emphasise the actively oriented aim of the profile; competences have to be brought into use to make a difference.

After this clarification, students started profiling their competences by narrowing them down to those they wanted to emphasise. We suggest that students in this process use at least the following views:

- *Practice view*: Where do I have the most experience?
- *Conceptual view*: Which competences are highly grounded in theory and methods?
- *Performance view*: What do I do best?
- *Preference view*: What do I like the most?
- *Development view*: How does my list of competences match with who I want to be, professionally speaking?



In guiding and supporting students' preparation of their competence profiles, questions were made to facilitate students' reflection of strategies and patterns in their competence development. An example of one guiding question related to meta-competences is: How have you worked to develop your PBL competences through your studies (e.g., personal learning goals, strategies, use of theories and methods, experiments, evaluations and new goals), and what competences has this given you to facilitate your own and others' competence development?

## Preliminary findings

As part of the educational activities the authors read through and commented on more than 150 profiles from engineering students. Preliminary to a more systematic analysis, the read through of the many profiles provided a first impression of students' performances in terms of competence profiling.

The overall impression was that students were divided into two types. One type seemed to attach themselves to one of the competence frameworks presented and exemplified a few competences, whereas others used personal qualities and experiences to outline a more personalised competence profile.

Almost all students exemplified their competences in a project context, and by reading the examples most students showed abilities to align the use of competence and the problem addressed. Overall, students show their ability to select and apply competences to address a real-life problem, but they hardly touched upon how they could adapt and adjust their competences to other types of problems and other domains.

Finally, interaction with students in the workshop setting revealed that the competence profiling was considered to be difficult. It is not at all easy to clarify and articulate one's own competences, select those competences found to be the most important to profile oneself on, reflect on the experiences and the personal qualities underlying these competences and, finally, reach the meta-level necessary to express the personal strategies to select, adapt, adjust and apply competences to a given situation and a given problem. As conceptual frameworks in which to develop and articulate meta-competences are rather limited, no frame of reference was given in this regard. As a result, due to the complexity of meta-competences, facilitating questions might not be enough.

## Conclusion

In this extended abstract, we have argued that the outcome-based approach to competence and its focus on knowledge transfer is insufficient to address the level and pace of change in today's society. In other words, we have to move beyond competences. To do so, we have argued for meta-competence as a conceptual lens to inform future educational designs. We have exemplified this by relating one understanding of meta-competence with one educational PBL practice concerning students' PBL competence profiling. Especially the distinction between selecting, adapting, adjusting, and applying competences pointed our attention to the risk of overlooking adaptation and adjustment processes in the management and development of competences. By this example we have shown how the concept of meta-competence can inform educational designs, and we have stressed the need to develop new types of scaffolding to facilitate such higher order competences.

## References

- Barnett, R. (2010). *Being a university*. Routledge.
- Barnett, R. (2011). The coming of the ecological university. *Oxford Review of Education*, 37(4), 439–455.
- Bridges, D. (1993). Transferable skills: A philosophical perspective. *Studies in Higher Education*, 18(1), 43-51.
- Carlile, P. R. (2002). A pragmatic view of knowledge and boundaries: Boundary objects in new product development. *Organization Science*, 13(4), 442–455.
- Havnes, A., Prøitz, T. S. (2016). Why use learning outcomes in higher education? Exploring the grounds for academic resistance and reclaiming the value of unexpected learning. *Education Assessment Evaluation and Accountability*, 28(3), 205–223.
- Holgaard, J. E., & Kolmos, A. (2021). *Competence Profiles for Problem Based Learning (PBL): Guide for Students for Preparing a PBL Competence Profile*. Aalborg Universitetsforlag.  
[https://vbn.aau.dk/ws/files/449673133/Kompetenceprofilguide\\_UK.pdf](https://vbn.aau.dk/ws/files/449673133/Kompetenceprofilguide_UK.pdf)
- Mezirow, J. (2012). Learning to think like an Adult: Core Concepts of Transformative Theory. In Taylor, E. W., Cranton, A., and Associates (Eds.), *The Handbook of Transformative Learning – Theory, Research, and Practice* (pp. 73–97). John Wiley & Sons, Inc.
- Ministry of Higher Education and Science. (2020). *Concepts – Read here about what is understood by the key concepts in the Qualification Framework for Lifelong Learning*.  
<https://ufm.dk/en/education/recognition-and-transparency/transparency-tools/qualifications-frameworks/concepts>
- Vitello, S., Grotorex, J., & Shaw, S. (2021). What Is Competence? A Shared Interpretation of Competence to Support Teaching, Learning and Assessment. Research Report. *Cambridge University Press & Assessment*.

# Work-In-Progress: Perceived learning gains of students, teachers and domain experts in Challenge-based learning and students' critical thinking activity in student - domain-expert interactions

Dr. Jovana Jezdimirovic Ranito

University College Twente, Netherlands, [j.jezdimirovicranito@utwente.nl](mailto:j.jezdimirovicranito@utwente.nl)

&

Dr. Pascal Wilhelm

University College Twente, Netherlands, [p.wilhelm@utwente.nl](mailto:p.wilhelm@utwente.nl)

## Summary

What do students, teachers and domain experts learn from engaging in a Challenge-based learning (CBL) project? And to what extent do domain experts foster critical thinking in students? These questions were addressed in a research study that took place in the context of the 2021-2022 semester 2 project of the ATLAS program of the University College Twente, part of the technical University of Twente in the Netherlands. The project theme was "Sustainable Oceans" and the assignment for the students was to write a short-term and long-term sociotechnical scenario for an emerging technology related to the theme. In this project, 28 first-year students, 5 ATLAS tutors, and 6 domain experts from industry, research, and society participated. The main research questions were: what do all stakeholders in this CBL project perceive as their main learning gains from participating in this project? And to what extent were the domain expert able to foster critical thinking activity in students? Data was collected using surveys, interviews, audio recordings of student-expert meetings and student focus groups. Preliminary results show clear learning gains for all stakeholders, even though challenging issues in the collaboration process were identified.

Key words: CBL, interdisciplinary project, domain experts, critical thinking Type

of contribution: Research extended abstracts

## Introduction

The University College Twente, part of the technical University of Twente in the Netherlands, hosts a unique Bachelor program, ATLAS (Technology, Liberal Arts and Sciences). This three-year bachelor program focuses on educating New Engineers who can approach complex issues from different disciplinary angles (mathematics, natural sciences and social sciences) in a multi-stakeholder collaborative context. ATLAS is a breeding ground for innovative teaching approaches. The program adopted the concept of self-directed learning, meaning that students set their own learning goals and self-evaluate their academic performance to build their unique profile as a New Engineer. ATLAS provides for a foundation in mathematics, natural science and social sciences, and CBL semester projects in which the students work together on mitigating complex societal issues. The extensive elective space accommodates the build-up of a unique profile as a New Engineer.

The 2021-2022 semester 2 project revolved around the theme “Sustainable oceans.” The challenge was to choose a technology related to Biotechnology, Energy or Transportation and develop a long - and short-term sociotechnical scenario that would show how the technology could become mainstream. Teams of 5 – 6 students were assigned two domain experts, and two tutors with expertise in social and natural science. Tutors are teachers who are associated to ATLAS, and their background is in natural, social sciences or mathematics. In the 2020-2021 run of the project, students would meet regularly with their tutors for feedback on project deliverables and to discuss important steps in the project. The domain experts’ role was to open the door to real-life contexts and provide information on state-of-the art technology development. However, it appeared that the domain experts did much more than that. With financial support from the University, it was decided to explore learnings gains of all stakeholders involved in the current set-up, with a special focus on critical thinking in students.

Challenge-based learning as an educational approach is becoming increasingly popular in higher education institutes, especially in engineering education (Gallagher & Savage, 2020). In the Netherlands, most of the technical universities have currently adopted the approach. Despite its popularity, there is still a need for research on student voices, praxis, and evidence on learning with respect to CBL (Leijon, 2021). This study responds to this call. Although there is evidence that knowledge gains of students in CBL are substantial (Caratozzolo & Membrillo-Hernandez, 2021), this study also explored teachers’ and domain experts’ learning gains. In addition, the study focused on the extent to which domain experts played a role in fostering critical thinking activity in student. There is evidence that suggests that CBL can foster critical thinking (Nawawi, 2017) and that involving industrial partners in the learning process has an added benefit for student learning by increasing complexity and uncertainty levels (Membrillo-Hernandez et al., 2019). This suggests that interactions with domain experts can foster critical thinking activity in students.

Our main research question was: what do all stakeholders in this CBL project perceive as their main learning gains from participating in this project? And to what extent are domain expert able to foster critical thinking activity in students?

## Methods

The project team received a grant from the University of Twente to conduct the study. The Ethical Committee approved of the plan. To study perceived learning gains of teachers and domain experts, semi-structured interviews were conducted. For the learning gains of the students, short surveys and focus groups were used. To study the assumed effect of domain expert interaction on students' critical thinking ability, verbal protocols of expert meetings were analyzed. Based on work by Facione (1990) it was assumed that the following critical thinking activities would be fostered by the domain experts: Assumption recognition, Argumentation, Evaluation and Decision making. In addition, focus groups were used to further explore this assumption.

## Results

Currently, data analysis is being completed, so only preliminary data will be described here. We will first address students' perceived learning gains, followed by tutor and expert's learning gains. Finally, we will address critical thinking.

Regarding the student perceived learning gains, the data indicated that the main benefit of having experts available was in bringing together real-life knowledge and insights from the experts, and the academic perspectives of the students on the project topic at hand. This closes a gap that is usually present between academic and real-life settings. The experts supported students in broadening the scope of the technology they researched and widened their perspectives on the broader context in which the technology would function. This resulted in a deeper understanding and awareness of the complexity of the technology and related stakeholder dynamics in society.

Students also pointed out that they learned from the different perspectives of the experts and the tutors, through discussing their different standpoints and perspectives. This fostered their decision-making skills, as they needed to evaluate information and decide what is relevant and what not for their projects. They also practiced critical evaluation of information and critical thinking skills by being questioned about the assumptions they made, and they felt the experts supported them in developing confidence and better organization of thought. Experts helped them develop their research (where to find credible information, how to assess it) and communication skills and students also experienced the challenge of understanding the different vocabularies used by experts from different disciplines around one topic. Finally, students pointed out that they improved their note taking skills (being able to write quickly, listen while typing, think, and participate in conversation).

Tutors highly appreciated the participation of experts in the project. They expressed having learnt a great deal about the project topics. However, they found students required additional guidance in relation to working with experts. For example, how they should evaluate what the experts bring to the table. They also noticed students are insecure (what path to take and how to move forward), and sometimes confused about the role and position of the experts (i.e. how much of experts' input they need to include, and to what extent experts were aware of students' general progress in the semester project). In general, tutors expressed they were positively surprised that first-years students are capable to deal with very complex issues and the multiple opinions of real-life stakeholders.

Tutors expressed that they became more open to the inclusion of experts in their own projects and classes. They also mentioned that, in such a case, they would try to define the experts' role more precisely. They also became more confident to trust the capacity of students to judge input they receive, but they would also encourage students to speak up more and be more confident in their interactions with domain experts. Finally, the inclusion of specific learning activities for the development of collaborative skills and team bonding which was part of the project, was a takeaway for the tutors.

The project experience was generally positive for all experts involved. They considered their main gain was learning about the technologies or the geographical areas chosen for the scenarios. On occasion, they expressed that the reference list of project reports was of use to them. Some of them expressed having gained a better understanding of the breadth of the topic, learning about it from the perspective of another discipline. Finally, some of them did not work with students previously, and gained insights in what this entails. The main challenge they identified were the students' teamwork abilities, since students struggled to manage motivation and organisation within their teams.

When asked about what they took from the project for their own practices, they mentioned two aspects. Firstly, like all other stakeholders, the benefit of becoming aware of the complexity of certain problems and issues. Second, the benefit of incorporating multiple perspectives (from various disciplines and points of view) in dealing with challenges to create a holistic perspective on a given problem.

Finally, students expressed that the experts helped them develop their critical thinking skills, by asking them questions, bouncing off ideas and consistently asking them to look at their assumptions. From the audio recordings of the expert meetings there were few signs in this direction, but based on self-report measures and focus groups, it was evident that the experts helped the students develop their critical thinking skills. Based on the feedback students received from tutors and experts, they often revised their assumptions. On presenting their ideas to the experts, they experienced their argumentation and organization of thoughts improved. The expert meetings enabled them to engage in discussions with the experts about the topic and to carefully evaluate arguments to build their scenarios. Although not fully intentional, the experts helped the students sharpen their critical thinking throughout these activities, leading to what the students referred to as "accelerating the development of critical thinking skills." The students also mentioned that having two different experts helped fostering their critical thinking, especially regarding evaluating their assumptions.

## Discussion and Conclusions

To complement the picture presented, the study has some clear limitations. All identified gains are, as stated consistently, perceived gains by students, teachers and experts. It is fair to say that some challenges were identified as well. It became clear that involvement of various stakeholders (tutors and experts) calls for clear roles and task expectations. At times, experts expressed to be overburdened, and at times tutors and students found involvement of experts challenging as experts did not fully understand the learning objectives of the project. Students also sometimes asked contributions from the experts which were not agreed upon with project management beforehand, adding to the workload of some of the experts. So, clear role and task expectations seem important.

Another important factor seems to be the quality of the relationship between students and experts, this affects the effectiveness of their collaboration. In addition, the extent to which experts see students as active players in CBL dynamics instead of passive learners seems important in this respect.

For students, the degree to which they made use of the experts differed. There were groups who had over fourteen meetings with their experts, whilst some only had four or five. As it could not be controlled how many meetings the groups would have with their experts, therefore it is recommended for future research that the number of expert meetings is standardized.

Regarding the tutors, student perceived tutoring as very useful but experienced challenges in dealing with different tutoring styles (each group had at least two tutors). Even though there was a tutor learning community set up to share information and solve problems, not all teachers attended regularly. It is advised to encourage this to align tutor practices more.

In all, this challenge-based learning project was experienced as positive and enriching for all stakeholders involved. What we learned is that it is important to define clear roles and tasks for all stakeholders involved and to communicate them well. Furthermore, good project coordination is of seminal importance to temporally align all different learning activities and to distribute workload evenly.

## References

- Caratozzolo, P., Membrillo-Hernández, J. (2021). Evaluation of Challenge Based Learning Experiences in Engineering Programs: The Case of the Tecnológico de Monterrey, Mexico. In: Auer, M.E., Centea, D. (eds) Visions and Concepts for Education 4.0. ICBL 2020. *Advances in Intelligent Systems and Computing*, vol 1314. Springer, Cham. [https://doi.org/10.1007/978-3-030-67209-6\\_45](https://doi.org/10.1007/978-3-030-67209-6_45)
- Facione, P. A. (1990). *Critical Thinking: A Statement of Expert Consensus for Purposes of Educational Assessment and Instruction. Research Findings and Recommendations*. <https://eric.ed.gov/?id=ED315423>
- Gallagher, S. E., & Savage, T. (2020). Challenge-based learning in higher education: An exploratory literature review. *Teaching in Higher Education*, 0(0), 1–23. <https://doi.org/10.1080/13562517.2020.1863354>
- Membrillo-Hernández, J., J. Ramírez-Cadena, M., Martínez-Acosta, M., Cruz-Gómez, E., Muñoz-Díaz, E., & Elizalde, H. (2019). Challenge based learning: The importance of world-leading companies as training partners. *International Journal on Interactive Design and Manufacturing (IJIDeM)*, 13(3), 1103–1113. <https://doi.org/10.1007/s12008-019-00569-4>
- Nawawi, S. (2017). Developing of module challenge based learning in environmental material to empower the critical thinking ability. *Jurnal Inovasi Pendidikan IPA*, 3(2), Article 2. <https://doi.org/10.21831/jipi.v3i2.15988>
- Leijon, M., Gudmundsson, P., Staaf, P. & Christersson, C. (2022) Challenge based learning in higher education– A systematic literature review. *Innovations in Education and Teaching International*, 59 (5), 609-618, DOI: [10.1080/14703297.2021.1892503](https://doi.org/10.1080/14703297.2021.1892503)

# Work-in-progress: Diagnosis of developing teamwork competences in engineering students in a PO-PBL course

**María Leon**

Universidad de Los Andes, Colombia, [ma-leon@uniandes.edu.co](mailto:ma-leon@uniandes.edu.co)  
Pontificia Universidad Javeriana, Colombia, [mpleon@javeriana.edu.co](mailto:mpleon@javeriana.edu.co)

**Carola Hernandez**

Universidad de Los Andes, Colombia, [c-hernan@uniandes.edu.com](mailto:c-hernan@uniandes.edu.com)

## Summary

Project-based learning is based on collaborative work, one of the competencies required by industry today in engineering graduates. This pedagogical model promotes the development of teamwork competencies. However, due to the recent implementation of this model in our context, it is essential to define strategies that allow structuring the development of teamwork competencies through the programs. Knowing the conceptions of teamwork with which students start engineering programs allows for identifying practices that may favor the development of this competency. Preliminary results of the concept of teamwork by engineering students of the Pontificia Universidad Javeriana show that in addition to the commitment to the work performed, trusting relationships promote the generation of more efficient teams. Likewise, shared communication and coordination behaviors are also frequently referenced by students; however, few references are made to conflict resolution behaviors. These identified elements account for the interactions of work groups in our context and will allow us to establish strategies with elements that consider our specific conditions.

**Keywords:** Engineering education, PO-PBL, Competencies, Teamwork, Team dynamics

**Type of contribution:** Research extended abstracts.

## 1 Introduction

Organizations worldwide have had to face more complex, global, rapidly evolving, and unexpectedly changing environments. In response to these environments, organizations have restructured work around collaborative, team-based work systems to enhance problem-solving, innovation, and adaptability (Kolowsky et Chow, 2018).

To address the challenges demanded by industry, the project-organized, problem-based, organized learning (PO-PBL) methodology has been used in engineering curricula in universities worldwide (Guerra, 2017). This methodology combines problem orientation, where problems appropriate to the program serve as the basis for the learning process, with project organization, where the project is both a means through which the student addresses the problem and the immediate learning context for students (Kjær-Rasmussen, & Jensen, 2013). The type of interactions involved in the project implies the need to foster and develop teamwork competence in this pedagogical framework.



Team dynamics must be characterized to understand how to develop teamwork competencies. Salas *et al.* (2008) proposed the ABC framework of teamwork, whose usefulness lies in capturing elements that constitute the team dynamics and thus helps to understand it. Dynamics are embedded in team performance and are composed of the interrelationship of attitudes, shared behaviors, and cognitions; therefore are indicative of team performance.

These behaviors, attitudes, and cognitions are, in part, what makes teamwork an adaptive, dynamic, and episodic process that is instrumental in achieving a common goal. Figure 1 shows the elements; raised in the framework that is part of the attitudes, shared behaviors, and cognitions (Delice *et al.*, 2018).

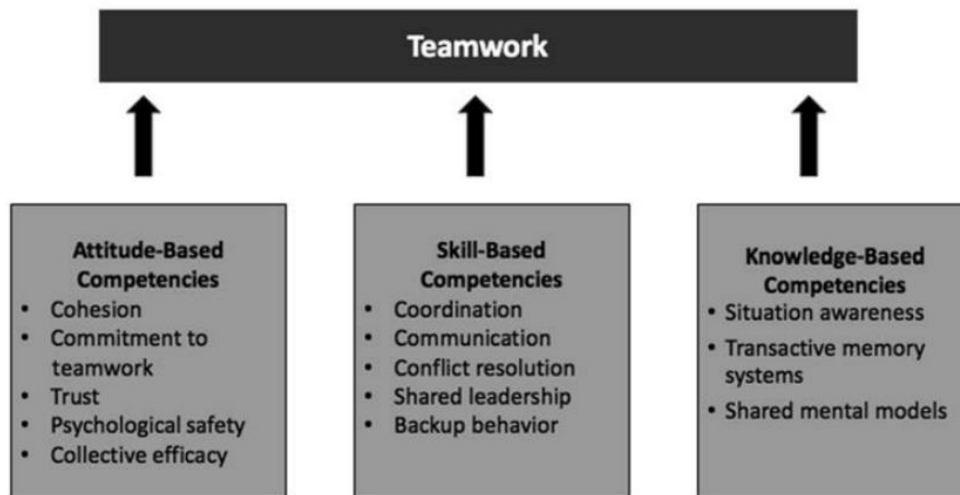

Figure 1. A-B-C Teamwork Competency Framework (Delce *et al.*, 2018)

## 2 Engineering Project Year 1 PO-PBL

In the Engineering programs at Pontificia Universidad Javeriana, students have PO-PBL experiences throughout the curriculum, where the approach is based on real context problems. In particular, the Engineering Project Year 1 course brings together the second-semester students of the Engineering Faculty who participate in this PO-PBL course.

The course approaches engineering design from a perspective of knowing the environment, *problematizing*, and ideating; based on Design Thinking tools and then proposes the development of a prototype using Lean Start Up methodologies.

The course problem is related to the Sustainable Development Goals (SDGs) to enable students to identify local and national challenges associated with our contexts. One of the learning outcomes that the student is expected to develop is the skills to promote a collaborative environment within the work team, for which the course has integrated tools for team formation, the assignment of roles, planning and monitoring, team evaluation, and team reflection on their performance. The use of these tools is structured based on the agile SCRUM methodology and must be applied in the different deliverables of the course.

## 3 Methodology

This study is part of doctoral research whose objective is to design a pedagogical strategy for developing teamwork competencies in engineering students in Pontificia Universidad Javeriana using the critical research methodology proposed by Skovsmose and Borba (2004). This methodology helps to investigate the process of change in educational practice through three analytical situations that are approached from qualitative methods. The starting point is the need to identify possibilities for transformation, starting from

an initial, concrete situation. The systematic analysis of the characteristics of the initial situation gives rise to the approach of an imagined situation, which represents the vision of the possibilities and alternatives for change to address the initial situation. However, when implementing the proposals for change, the imagined situation and what is possible to achieve is only partially aligned; there must always be conditions restricting the possibilities of achieving everything we imagine. From this disparity arises the fixed situation as a realistic vision of the imagined situation.

The approach to the initial situation is based on understanding the conceptions of teamwork for the actors of the teaching-learning context (teachers and students) in the first year. In this document, we focus on the perspectives of teamwork in engineering students who are taking the Year 1 Project course. In the second week of classes, we conducted a survey answered by 190 of the 450 students who are part of the different sessions of the Year 1 Project course. The questions addressed by the survey were associated with inquiring about the frequency with which students were in courses involving teamwork, the conception of teamwork indicating attitudes, behaviors, and cognitions, and the best and worst teamwork experiences. Finally, the survey inquired about the student's self-perception of their performance in the development of teamwork competencies associated with the practice of actions oriented to planning, generating a good working environment, facilitating the contributions of others, managing conflicts, and contributing to the project.

The analysis of the information was carried out through the triangulation of the information collected, using the categories of the definition of teamwork, including attitudes, behavior, and knowledge proposed by Salas (2008). The elements emerging from the categories were taken into account for their analysis.

#### 4 Presentation of results and discussion: Concept of teamwork competence in first-year engineering students.

The development of teamwork is a common practice in the first year of engineering, as expressed by students in the survey, where 94% reported that a medium to high percentage had involved teamwork. In engineering programs, it is common to find experiences perceived by students as teamwork experiences. Only sometimes, what is reported by students in the survey corresponds to teamwork since some experiences are associated with group work.

Figure 2 and Figure 3 present condensed results obtained from the qualitative analysis of the information. An information triangulation is made based on the three questions asked: (a) definition of what it means to work in a team, (b) what has been your best teamwork experience, (c) what was the worst teamwork experience, and (d) what was the worst teamwork experience? The results presented in Figure 2 show the students' perceptions related to attitudes, and those presented in Figure 3 show the results related to skills. Students highlight most frequently, in the conceptualization of teamwork competence, attitudes about shared behaviors and cognitions about teamwork.



Figure 2 Attitudes reported in the surveys (Source: Own elaboration)

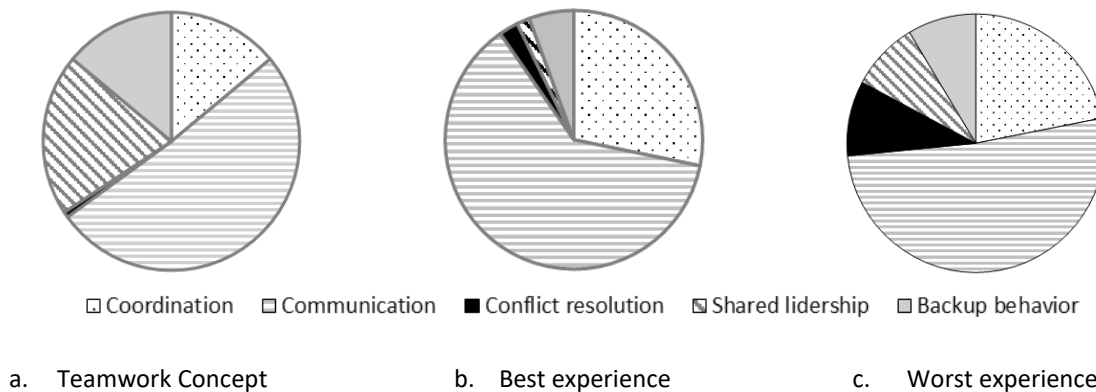

Figure 3 Shared behaviors reported from the survey (Source: Own elaboration)

Analyzing the attitudes reported in the survey, the students indicate the central attitude, the commitment to the work performed, which includes attitudes of responsibility, effort, discipline, and hard work, among others. The information provided by the students describing the worst teamwork experience, consequently, describes the lack of responsibility with the development of the task as the main complaint of the students. In the answers collected in the survey, this attitude is usually associated with poor motivation for work and the lack of communication mechanisms and face-to-face interaction. An example of the comments made by students in this aspect is: "It was very complicated to get together, especially because most of them were not very interested in the activity; they simply divided the tasks and then got together, so it usually resulted in a somewhat incoherent task".

Recurrently, this attitude of individual responsibility for the work is observed in the conceptualization of teamwork and in the narration of the best and worst experiences, disassociated with collective effectiveness or cohesion. However, it must be concluded that collective efficacy is a consciously exercised attitude for the development of teamwork by students or that the type of tasks to which students are being exposed requires it. The testimony of better experiences expressed below is an example of the division that takes place in the tasks performed in the group without highlighting the processes of collective construction: "We all did the part that corresponded to us, according to the skills of each one".

Performing the analysis of the shared behaviors reported in the survey, we can observe that communication is reinforced as a required practice to work as a team, an element frequently highlighted in the best and worst experiences. Additionally, in the best experiences, communication is associated with trusting attitudes. The following is an example of what is expressed by students in this aspect: "...we all worked together, we took breaks and at the time of the presentation, beyond looking like a distributed work, it looked like a conversation between friends explaining a topic: communication and trust". Among the references to shared behaviors, there are very few mentions of conflict resolution. It is consistent with expressing a higher number of conflicts in the worst experiences. However, information needs to be collected on the skills that students have incorporated for conflict management, as seen in the following excerpts of experiences regarding teamwork. The students expressed these: "There was no one in charge of mediation" and "...the lack of communication, which generated conflicts that damaged the work".

Finally, in the survey, the elements that account for the cognition required to work in a team are scarcely mentioned. An example of a student's testimony is: "...among the members we did not have the same objectives, we were not synchronized in giving the same effort for each of the works".

The information collected in the survey regarding these conceptions was subsequently cross-checked against the self-perception of the degree of development of teamwork competence. In this regard, students have a self-perception of having developed sufficiently the behaviors associated with an organization, communication, support, and conflict resolution, among others. In most aspects associated with each of these skills, around 50% of the students stated that they did not require significant improvements.

The information gathered shows that in the ABC framework of teamwork, there are elements in the team dynamics that are not taken into account by first-year students to generate dynamics aimed at team effectiveness. The pedagogical strategies to be developed should consider elements usually associated with student teamwork, such as coordination and communication, and others that do not appear so strongly associated with students, such as conflict resolution, shared leadership, and the generation of trust in work teams.

## 5 References

- Kozlowski, S. W., & Chao, G. T. (2018). Unpacking team process dynamics and emergent phenomena: Challenges, conceptual advances, and innovative methods. *American Psychologist*, 73(4), 576.
- Guerra, A. (2017). *PBL in Engineering Education: International Perspectives on Curriculum Change*. Brill.
- Salas, E., Cooke, N. J., and Rosen, M. A. (2008). On teams, teamwork, and team performance: discoveries and developments. *Hum. Factors* 50, 540-547. doi: 10.1518/001872008x288457.
- Delice F, Rousseau M and Feitosa J (2019). Advancing Teams Research: What, When, and How to Measure Team Dynamics Over Time. *Front. Psychol.* 10:1324. doi: 10.3389/fpsyg.2019.01324.
- Edström, K. & Kolmos, A. (2014). PBL and CDIO: complementary models for engineering education development, *European Journal of Engineering Education*, DOI: 10.1080/03043797.2014.895703.
- Skovsmose, O., & Borba, M. (2004). Research methodology and critical mathematics education. In P. Valero & R. Zevenbergen (Eds.), *Researching the socio-political dimensions of mathematics education: Issues of power in theory and methodology* (pp. 207-226). Boston, United States: Kluwer Academic Publishers.

# “My Dinner Plate is Different from Your Dinner Plate” Teaching Empathy using PBL in Engineering classrooms: Case Study from India

Richa Mishra, PhD

Institute of Technology, Nirma University, India, richa.mishra@nirmauni.ac.in

## Summary

This research work in progress intends to study the development of empathetic abilities in engineering students using a project-based learning approach during the Design Thinking classroom and to observe their progression. The study participants were first-year students in the four-year engineering program. This is a two hours per week value added course which is mandatory for everyone. In this course, students were taught methodical problem-solving and given tool-kits and scenarios where they worked in pairs/teams. The dinner plate activity is one of the PBL activities given to students in a team. The students follow Design thinking principles which are identifying the problem with the existing solution, ideation, identification of user and stakeholders, designing the solution, interviewing and validating the solution from the stakeholders and then telling the story. This is iterative and aims to fulfil the stakeholder's needs and requirements by using empathy. The author of this study has measured empathy using a very popular device, the Interpersonal Reactivity Index inventory. It was used as a diagnostic tool and was administered before and after the course. The students were also asked about their experiences which were qualitatively analysed to understand the lessons they have learned. A total of 30 participants were part of this study. The author wanted to do the study for 3 years to see whether empathy taught in the classrooms diminishes over time, but due to COVID-19 and switching to online classes, the old study was shelved. This is still ongoing work, and more insights will be added by next year. The work shows that the overall empathy score was constant, but students became more empathetic after the PBL activity. The real-world problems open them to another perspective.

**Keywords:** Problem-based learning, Empathy, Design Thinking, Engineering classrooms

**Type of contribution:** Research extended abstracts

## 1. Motivation for the work, with reference to relevant literature

Empathy is the new sixth sense (Pink, 2015) which is needed to make sense of the VUCA world and to solve complex problems (Goulet, 2022). Various research studies have shown that apart from technical skills, engineers also need communication and empathy skills (McGinley & Dong, 2011; Goulet, 2022).

Empathy in students is one of the required 21st-century skills. Researchers and educators are trying different approaches to inculcate and study this phenomenon. There are studies (Hutchison, M, 2016) where empathy was described as increasing comfort and skill with interdisciplinary thinking and collaborative learning while improving the core college skills of written and oral communication, ethical and quantitative reasoning, and critical thinking. Project-based learning approach was also used to increase medical student empathy (Hashim, Aris, & Chan, 2019) but very few in engineering classrooms. The same study has proposed empathy as a vital skill to be adopted in the classroom, but the work has not employed any diagnostic tool to see the change in empathy level, similarly (Busu, 2020) has interviews and peer rating feedback to assess empathy levels. In another study, a comparison of empathy levels was made among engineering, psychology, and social work students on the fantasy and perspective-taking subscales (Rasaol, 2012). Engineers are increasingly being asked to empathetically engage with a broad range of stakeholders

(Walther & Miller, 2017) they face problems while managing group tasks and leading the group as these tasks require empathy and social skills (Chato et al., 2012). Empathy has been identified as an important attribute of effective leadership in workplaces (Herbek & Yammario, 1990). Practising engineers are hired, rewarded and promoted for their ability to solve problems hence it becomes imperative to teach engineers problem-solving (Jonassen, Strobel, & Lee, 2006). Problem-solving is the central activity of the engineering profession (McNeill et al., 2016). The engineering education forums and consortiums now increasingly recognize the role of empathy while solving problems in 21st-century workplaces (Brewer et al., 2020; Wilson & Mukhopadhyaya, 2022). To address all these concerns, a premier engineering institute in the western region of India has designed a course on Design Thinking. This course has more problem-solving angles than the design element. It aims to teach students tools of problem-solving (Six thinking hats, fishbone diagram, concept mapping, etc). This course is for first-year engineering students of all branches, such as computer science engineering, mechanical engineering, civil engineering, etc. discipline. Around 1100 students take this course every year for a semester. The course uses a Problem-based learning approach and is administered in batches of 30 students by faculty members who are trained in PBL and empathy.

Problem-based learning (PBL) was the preferred method to teach problem-solving skills since it “triggers” students from a real-life scenario and facilitates self-discovery and learning before adding the acquired knowledge with their team members and augmenting the general learning (Wood, 2003). PBL also facilitates skills like Teamwork, Chairing a group, Listening, Cooperation, Assertive listening, Use of resources, and Presentation skills (Wood, 2003). These skills are congruous with the skills required by bodies like ABET (Radcliffe, 2005).

## 2. Research questions

This study examines three research questions and intended outcomes:

1. With a focus on human-centric problem-solving and designing solutions, can students be made more empathetic?
2. Can Problem-Based learning activity raises the empathy level and connects the students to the real world more easily than conceptual problems?
3. What can engineering educators learn from design thinking classes that can be replicated in core engineering classrooms?

## 3. Relevant theoretical and empirical frameworks that underpin the study

Hmelo-Silver (2004) has mentioned goals of problem-based learning that include the development of flexible knowledge; Effective problem-solving skills; Self-directed learning skills; effective collaboration skills, and intrinsic motivation. An imperative component of problem-based learning (PBL) is effective problem-solving. Engineering students are supposed to solve the wicked problems of the world. The wicked problems are social system problems, they are usually ill-formulated, with insufficient and ambiguous information, and decision-making is multiple having conflicting ideas and values (Webber & Rittel, 1973). Thus, engineering classrooms should mimic wicked problems instead of tame problems.

The effectiveness of these activities comes when the solution is human-centric. Thus, an in-depth understanding of the theoretical underpinnings of how to enhance problem-solving skills and effective collaboration that can bridge theory and practice more effectively, which in turn provides ideas and tools to enhance PBL practices and research is attempted in this work. Design Thinking is emerging as a very effective tool to teach problem-solving with empathy. It has crossed the walls of designing schools and is now used in engineering domains (Dym et al., 2013; Lammi & Becker, 2013; Mishra & Kartikeya, 2020). In this research, work author has taken the IDEO framework of Design Thinking. The school’s model of design thinking has five iterative steps: Define the problem (after interviewing the users/stakeholders), Ideate (using critical and creative thinking), Prototype and Test (validated by users and stakeholders) and tell the

story. Empathy is at the centre of the process and is used in every step (Plattner et al., 2012). This framework overlaps Barrows & Myers (1993) framework of the problem-based learning model (Yueh et al., 2005).

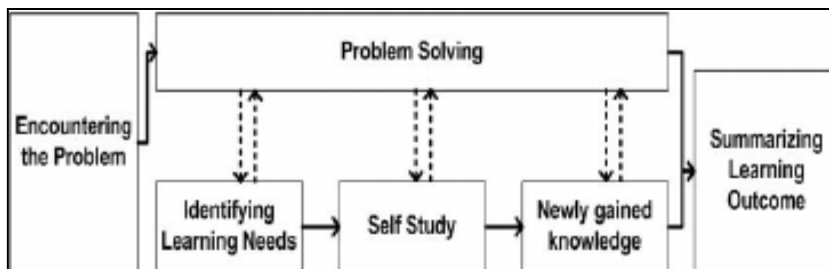

Figure 1: Barrows & Myers PBL Model (Yueh, Hsiu-Ping, & Lin, Weijane, 2005)

The IDEO framework stresses reiteration and empathy as the centre of every step during the problem-solving steps. This means going back again and again to users and stakeholders and asking about their views, perspectives, needs, constraints etc.

In this work, students in 1st year were divided into a class of 30 students. They were further divided into a team of ten students. Students were given the task to design a Dinner Plate (Plate for the main meal) The plates in India are usually this shape ( Fig 2/3). The food is not served in courses but all at once. It usually is served hot and is watery.



Figure 2-3: Types of Thalīs (Dinner Plates) in India

Source: Image from the Internet

Students were given the Case of a Design Dinner Plate for specific users (for example Playgroup kid / Blind person / Parkinson's disease patient / Space traveller / hiker, etc). The case also contains details, additional constraints, and guidelines. They are required to design open-ended questionnaires, research facts, and figures, and use empathy maps while drawing solutions for their users. Students need to interview, ask questions and understand their routine, living conditions, workplaces, the food they eat, etc during problem-solving activities

It was noted that during and after the activity using Design thinking principles, students could understand and incorporate the requirements of the dinner plates for specific users. Since these are first-year students, the goal is not to teach engineering solutions but empathy, presentation skills, communication, teamwork, etc.

#### 4. An appropriate research methodology, namely methods, and tools for data collection and analysis

The methods and tools employed were to see the attainment of research goals. Though the conceptual validity of empathy measurement and training is very problematic (Lam, Kolomitro, & Alamparambil, 2011).

Various tests are present to measure empathy. In this work, the author has used one of the most popular psychometric tools, namely the Interpersonal Reactivity Index (IRI) (Davis, 1980). This instrument measures a multidimensional scale and has sub-scales. They all measure different attributes of empathy: Perspective Taking, (the cognition to identify another's affective position), Empathic Concern (compassion for others), Fantasy (to imagine the scenario/ various situations), and Personal Distress (feeling fear or anxiety in response to seeing others in distress). Various studies have validated IRI as valid and reliable (Davis, 1980; Pulos et al., 2004].

Students were assessed during their first week of the course (it is a 4-months course with 4 PBL activities stretching over 2 months) and during their last week. This work display and mentions one activity in detail. The diagnostic tests displayed a shift in the empathy scale.

Referential statistics were also used on the data collected from the questionnaires. T-tests were performed to measure empathy. Students were also asked to write a self-reflection learning log which was analysed qualitatively.

## 5. Results in a clear manner and how they answer the research question(s)

It was observed during the reading of the weekly learning log that the empathy shift happened very slowly and very gradually. The pre and post-test display the changes. The IRI tests do display improvement in the low empathy group after the PBL activity. The entire class of 30 students took the questionnaires (a 100% rate). It was observed that students with low empathy levels during the pre-test of IRI gained awareness and empathy after doing PBL activities. The IRI has four subscales of seven items, each with scores ranging from 0 to 28. Every individual question has scored from 0-4, and few questions have reverse scoring. Two subscales that measure cognitive empathy are IRI- PR and IRI-FS, and two subscales measure affective empathy (IRI-EC and IRI-PD).

Table 1: Mean and Standard Deviation of The Four IRI subscales

Subscales	Pre-PBL, N=30		Post-PBL , N=30	
	Mean	SD	Mean	SD
Empathetic Concerns (EC)	14	(0.75)	22	(0.34)
Perspective Taking (PT)	13	(0.34)	25	(1.04)
Fantasy (FS)	13	(0.34)	20	(0.63)
Personal Distress (PD)	14	(0.53)	18	(0.72)

Students after participating in the PBL-based activity showed better empathy level  $t(30) = 5.096$ ,  $p = 0.0022$ . Students reported in their logs that empathy maps made them acutely aware of another perspective. Logs indicate amazement and concern for the users like

*“ How blind people serve food without seeing in such dinner plates, is concerning to me. He can get scalded by a hot item”.*

This pushes them more to feel/think and do for people who are unlike them and have problems to solve. The researcher would like to extend the study and see the long-term effect of PBL in teaching learning and the presence of empathy when these students are in their final year of the four-year degree program. The results answer the first two research questions. The third expected outcome, of taking PBL to core



engineering classrooms for empathetic engineering graduates is an ongoing process. The effort to make PBL mainstream in India will be helpful. More research work and visibility of research work are also needed.

## 6. Critical reflections regarding the results, discussion and conclusions, and their implications for the development of PBL theory and practice

Teaching a very intangible quality like empathy is very difficult. Teaching empathy as a theory is not easy. Rigorous and evolved training is required (Lam et al., 2011). This work highlights the effectiveness of PBL in teaching empathy in engineering classrooms. It proposes a PBL framework to teach empathy in engineering as a teachable and learnable skill.

## 7. References

- Busu, T. N. Z. T. M., Mohd-Yusof, K., & Rahman, N. F. A. (2020). Empathy enhancement among engineering students through cooperative problem-based learning, *IEEE International Conference on Teaching, Assessment, and Learning for Engineering (TALE)*, Takamatsu, Japan, 2020 (pp. 889–894). <https://doi.org/10.1109/TALE48869.2020.9368443>
- Davis, M. H. (1983). Measuring individual differences in empathy: Evidence for a multidimensional approach. *Journal of Personality and Social Psychology*, 44(1), 113–126. <https://doi.org/10.1037/0022-3514.44.1.113>
- Dym, C. L., Agogino, A. M., Eris, O., Frey, D. D., & Leifer, L. J. (2005). Engineering design thinking, teaching, and learning. *Journal of Engineering Education*, 94(1), 103–120. <https://doi.org/10.1002/j.2168-9830.2005.tb00832.x>
- Empathy-driven development: *How Engineers Can Tap into This Critical Skill*. <https://review.firstround.com/empathy-driven-development-how-engineers-can-tap-into-this-critical-skill>
- Goulet, M.-H., Larue, C., & Alderson, M. (2016). Reflective practice: A comparative dimensional analysis of the concept in nursing and education studies. *Nursing Forum*, 51(2), 139–150. <https://doi.org/10.1111/nuf.12129>
- Herbek, T. A., & Yammarino, F. J. (1990). Empathy training for hospital staff nurses. *Group and Organization Studies*, 15(3), 279–295. <https://doi.org/10.1177/105960119001500304>
- Hmelo-Silver, C. E. (2004). Problem-based learning: What and how do students learn?. *Educational Psychology Review*, 16(3), 235–266. <https://doi.org/10.1023/B:EDPR.0000034022.16470.f3>
- Hutchison, M. (2011). The empathy project: Using a project-based learning assignment to increase first-year college students' comfort with Interdisciplinarity. *Interdisciplinary Journal of Problem-Based Learning*, 10(1). <https://doi.org/10.7771/1541-5015.1580>
- Jonassen, D., Strobel, J., & Lee, C. B. (2006). Everyday problem-solving in engineering: Lessons for engineering educators. *Journal of Engineering Education*, 95(2), 139–151. <https://doi.org/10.1002/j.2168-9830.2006.tb00885.x>
- Lam, T. C. M., Kolomitro, K., & Alamparambil, F. C. (2011). Empathy training: Methods, evaluation practices, and validity. *Journal of Multidisciplinary Evaluation*, 7(16), 162–200.
- Lammi, M., & Becker, K. (2013). Engineering design thinking. *Journal of Technology Education*, 24(2), 55–77.
- McGinley, C., & Dong, H. (2011). Designing with information and empathy: Delivering human information to designers. *Design Journal*, 14(2), 187–206. <https://doi.org/10.2752/175630611X12984592780005>
- McNeill, N. J., Douglas, E. P., Koro-Ljungberg, M., Therriault, D. J., & Krause, I. (2016). Undergraduate students' beliefs about engineering problem-solving. *Journal of Engineering Education*, 105(4), 560–584. <https://doi.org/10.1002/jee.20150>

- Md Hashim, A., Syed Aris, S. R., & Chan, Y. F. (2019). Promoting empathy using design thinking in project-based learning and as a classroom culture. *Asian Journal of University Education*, 15(3), 14–23. <https://doi.org/10.24191/ajue.v15i3.7817>
- Mishra, R., & Kartikeya, M. (2019). Accelerating innovation and problem-solving in engineering by design thinking. *International Journal of Advanced Science and Technology*, 28(18), 691–698.
- Pink Daniel, A. (2005). *Whole New Mind: Why Right-Brainers Will Rule the Future*. <https://review.firstround.com/empathy-driven-development-how-engineers-can-tap-into-this-critical-skill>, Retrieved Dec 2022. Riverhead Books.
- Plattner, H., Meinel, C., & Leifer, L. (Eds.). (2012). Springer. *Design Thinking Research*.
- Pulos, S., Elison, J., & Lennon, R. (2004). The hierarchical structure of the interpersonal reactivity index. *Social Behavior and Personality*, 32(4), 355–359. <https://doi.org/10.2224/sbp.2004.32.4.355>
- Radcliffe, D. F. (2005). Innovation as a meta-attribute for graduate engineers. *International Journal of Engineering Education*, 21(2), 194–199.
- Rasoal, C., Danielsson, H., & Jungert, T. (2012). Empathy among students in engineering programmes. *European Journal of Engineering Education*, 37(5), 427–435. <https://doi.org/10.1080/03043797.2012.708720>
- Rittel, H. W. J., & Webber, M. M. (1973). Dilemmas in a general theory of planning. *Policy Sciences*, 4(2), 155–169. <https://doi.org/10.1007/BF01405730>
- Walther, J., Brewer, M. A., Sochacka, N. W., & Miller, S. E. (2020). Empathy and engineering formation. *Journal of Engineering Education*, 109(1), 11–33. <https://doi.org/10.1002/jee.20301>
- Walther, J., Miller, S. E., & Sochacka, N. W. (2017). A model of empathy in engineering as a core skill, practice orientation, and professional way of being. *Journal of Engineering Education*, 106(1), 123–148. <https://doi.org/10.1002/jee.20159>
- Wilson, E., & Mukhopadhyaya, P. (2022). Role of empathy in engineering education and practice in North America. *Education Sciences*, 12(6), 420. <https://doi.org/10.3390/educsci12060420>
- Wood, D. F. (2003). Problem-based learning. *BMJ*, 326(7384), 328–330. <https://doi.org/10.1136/bmj.326.7384.328>
- Yueh, Hsiu-Ping & Lin, Weijane. (2005). Design of the information sharing mechanism in supporting students' collaborative learning in PBL environment. 305- 307. 10.1109/ICALT.2005.104.

# Work-In-Progress: Teaching and Assessing Complex Engineering Design Skills from a Whole-Task Approach

Yakhoub Ndiaye

Singapore University of Technology and Design, Singapore, [yakhoub.ndiaye@sutd.edu.sg](mailto:yakhoub.ndiaye@sutd.edu.sg)

Lucienne Blessing

Singapore University of Technology and Design, Singapore, [lucienne.blessing@sutd.edu.sg](mailto:lucienne.blessing@sutd.edu.sg)

## Summary

Engineering design (ED) is often viewed, even accepted as a subjective, problem-oriented, open-ended and ill-structured field, and involves the mastery of complex skills. As such, many instructors recognise these aspects as typical of 'design', therefore neglecting to establish a holistic and well-defined instructional approach that addresses this complexity. This idea is reflected in the design literature with many design methods, theories, and models supporting the design processes and methodologies on how they can be conducted. However, little is known about how these models can be expanded to a fully coherent and explicit educational method for teaching and assessment. Therefore, it is particularly challenging for nonexpert and less experienced instructors to develop pertinent instructions for their students, through which the engineering expertise can be appropriately acquired. To address these issues, we propose using integrated task-centred instructional design approach to complex learning. This approach aims to integrate the process of defining teaching, teaching and assessment as a complex system that should be addressed holistically through a whole-task approach. To analyse the effectiveness of our approach, we follow a design-based research consisting of an intermediate RCT with two instructor groups to develop and compare the effectiveness of current teaching with the experimental intervention based on the suggested approach.

**Keywords:** instruction, skill assessment, whole-task, engineering design, instructional design.

**Type of contribution:** Extended Research Abstracts

## 1 Background

This research addresses the issues of teaching and assessing complex engineering design (ED) skills in higher education. ED is seen as a complex creative field aiming to solve complex real-life problems. As engineering tasks become increasingly complex in contemporary society, teaching, learning, and assessing in such a complex field are extremely challenging for both instructors and students. It is also noticed that several ED theories and processes have been proposed, all highlighting the ED ways of thinking, ideating, making, and approaching technical problems. However, ED education suffers from an integrative theory of instruction for complex learning. In fact, little is known about how these theories and processes of ED can be expanded to fully coherent instructional guidance for teaching and assessing ED. As a matter of fact, ED instructions are still using learning objective-based approaches to develop learners' skills, however, it is not yet clear how integrated goals can be implemented and assessed. Because ED education emphasises complex skill acquisition that differs depending on task complexity, a holistic approach to learning task is therefore needed to develop such complex skills and contribute to transforming ED education. However, several instructional design (ID) models have been proposed in ID research for decades.

## 1.1 Key skills in ED: Related works

With the current societal and technological challenges that our world is facing, the identification and development of student skills and competencies are attracting considerable interest. Recent work has been focussing on mapping ED knowledge, skills, and attitudes that students must develop (e.g. Sudhindra & Blessing, 2021). For instance, Caeiro-Rodríguez, et al. (2021) discussed the importance of soft skills across five EU countries. Quelhas et al. (2019) reviewed the literature and highlighted eight key competencies required by the engineering professional, related to sustainability. They conducted an empirical study that revealed that certain skills were predominant among others for respondents.

On the basis of a recent review (not presented here), we examined the literature over the past decade. In complement to student technical and problem-solving skills, we discussed three core interrelated skill domains that deserve to be included in contemporary curricula. Those domains could be categorised as follows: holistic thinking (design thinking, critical thinking, reasoning, metacognition, etc.), sustainability (social, responsibility, value, empathy, etc.), and management (creativity, organisation, planning, interpersonal, etc.). Sustainability, the guiding approach, is a complex system and requires students to understand how to approach complexity in sustainable ways (of thinking, acting, managing). However, the integration of sustainability into engineering curricula remains challenging (Tomas et al., 2020). Students need to engage appropriately in problem solving through holistic thinking. Regarding the last skill domain, students are also expected to become active learners, entrepreneurial, managerial, and able to address challenges collaboratively.

Despite the importance, it is argued that identifying student skills is only one step in transforming ED. It is important to know how to teach those skills, to readapt instructional practice but also curriculum and organisations. All should be constructively aligned.

## 1.2 ID Models for complex learning

There are several prescriptive instructional design (ID) models to design instructions in the ID history. It is important to understand the origin, purpose, how and why a model fits an instruction. ID models work when they are contextualised. Given the complexity of the ED context, it is difficult to know which model fits best to instructions, especially if they can take different formats. Warren et al. (2014) analysed four ages of ID (age of ID, message design, simulation, and learning environment) and how they gave birth to a new age of conceptual learning. Therefore, ID research and ED face similar challenges in the variety of models they used. We aim not to review all models, however, two ID models relevant to this research are the four-component instructional design (4C/ID) model (van Merriënboer, 1997) which is a more extensive version of the 'Pebble-in-the-pond' of Merrill (2002); and the 'Three-act theory' (3AT) (Musial & Tricot, 2020). We briefly discuss both.

### A four-component instructional design model

The 4C/ID model (van Merriënboer, 1997) is a holistic, research-based, task-centred approach to complex learning consistent with competency-based education. It is a design model used in complex professional fields to build instructions and curriculum that are coherent with human cognitive architecture. This model deals with three basic educational issues namely (van Merriënboer & Kirschner, 2018a): compartmentalisation (separating a whole component into distinct parts), fragmentation (breaking down a component into isolated parts which cannot be easily connected) and the transfer issue (defining specific learning objectives (LOs) to teach isolated components, instead of integrated LOs more effective for the transfer of learning). The instruction that is designed based on this model introduces four interrelating blueprint components (Ibid.):

1. learning tasks (the backbone of the model): complex ED tasks should be authentic, and variable to ease the acquisition of knowledge, skills, and attitudes simultaneously, as well as to ease transfer. The task complexity is introduced earlier but presented in a simple-to-complex sequencing that

avoids the three above-mentioned issues. Consequently, instructor support and guidance are consistent but gradually decrease (scaffolding process).

2. supportive information (the 'theory'): relevant and sufficient information is provided to students to support the development of their mental models and cognitive strategies.
3. procedural information (the 'how to'): perform the task; provide step-by-step instructions.
4. part-task practice: support the development of routine skills so that they can be performed automatically.

To implement this model into a design process, the authors (van Merriënboer & Kirschner, 2018b) have developed a 'Ten Steps' procedure.

### A three-act theory model

While the 4C/ID and the 'Ten steps' are particularly relevant for planning and organising complex contents and their task, Tricot and Musial (2020) have proposed a complementary approach called 'three-act theory' (3AT) that helps model teaching and learning trajectories. The 3AT describes the act of designing instructions itself in a very visual, holistic way, based on three components: two descriptive theories (knowledge theory and instructional strategy theory) and a prescriptive theory that links knowledge and strategies. The authors claim a learning-driven ID based on permeability between the roles of the instructional designer (specialist in instruction), the content expert (specialist in domain knowledge, the designer) and the psycho-ergonomist (specialist in learning and what makes it happen); closer to Lee Shulman's PCK.

An important assumption of the 3AT also supported by the 4C/ID is the articulation of the task and associated knowledge to perform the task, which according to Tricot and Sweller (2014) characterises learning better. Therefore, the authors suggest a pragmatic articulation of the task to be performed by students and the underlying declarative and procedural knowledge necessary to carry out the task (Task; Kd, Kp). For instance when applied to instructions, a teaching task ( $T_{Teaching}$ ) would require the knowledge for teaching ( $K_{For-teaching}$ ) and the knowledge to be taught ( $K_{To-be-taught}$ ).

A common concern shared by these task-centred models is that traditional engineering teaching often defines many fragmented LOs where instructions are then developed for each of those LOs. Researchers such as van Merriënboer & Kirschner (2018a; 2018b) argued that such atomistic approaches might be relevant if there are few connections between the separated LOs. However, these approaches have shown some limitations when it comes to teaching integrative goals. This especially applies to ED education which involves complex and higher-order skill acquisition. In fact, such instructions are cognitively demanding, as they often leave the learning to students who are supposed to construct, on their own, complex relations between LOs. Student learning issues are compounded, especially when instructors advocating this approach provide less support and minimal guidance to students, claiming that they should explore and learn by themselves, thus losing sight of the interconnections between the contents to be acquired (Kirschner et al., 2006). In contrast to this, holistic design approaches that focus on the integration and performance coordination of task-specific constituent skills have been developed to address these issues. From the perspective of ED education, 4C/ID and 3AT are complementary examples of ID models capable of supporting the instructional complexity and acquisition of higher-order skills.

### 1.3 Assessing ED skills

Assessing is part of teaching. Consequently, assessing the expertise of learners requires a systemic approach to competency and competency assessment. We view competency as the ability to integrate and coordinate simultaneously and relevantly a learner's knowledge, skills, and attitudes and their underlying components (affective, cognitive, motivational, etc.). In ED, students are generally assessed through project-based learning and on their physical and learning outcomes. The instructor assessment then relies on various types of student productions, which depending on the subject domain (architecture, product, systems design, capstone, etc.) are carried out on different types of productions (i.e., design brief, journal, poster, report,

presentation, portfolio, review, prototype, etc). As in other fields, two types of evaluation in ED can be: formative (for/as learning) and summative (of learning). Moreover, as a professional job, ED is also certifying in its assessment because students need to demonstrate their skills. Research suggests integrating the student into the assessment process (e.g., self-and/or peer, ipsative assessment, etc). The type of assessment can then vary depending on the instructions. Relying on research, best practice and standards (e.g., CDIO), this research will explore effective ways of assessing ED from a whole-task-centred approach. For instance, learning tasks in the 4C/ID, are organised into constituent skills to specify performance standards (i.e., criterion and norm-based assessment). This helps to identify performance assessments as described in the ‘Ten steps’ procedure. Learning tasks are defined in a way that allows skill development over time and involves many low-stakes formative assessments. However, the effects of whole-task approaches on other evaluation types are not well understood.

## 2 Research questions

Our overall research question is as follows: How can a holistic, whole-task ID approach support ED instructions? The following specific research questions are suggested;

- R1. How can we define and teach whole-task-based integrated LOs to develop key student skills?
- R2. How can learning be effectively assessed to measure student expertise?
- R3. What are the contributions and limitations of this approach for contemporary ED education?

## 3 Method

The experimental design referred to as design-based research (DBR) is used (e.g., DBR Collective, 2003). The purpose of DBR is to develop, implement, and evaluate instructions in an iterative fashion. The research seeks to analyse the effects of using integrated LOs through whole-task practice and its assessment. Therefore, an intermediate randomised control trial is adopted that will help to compare the classic instructions and those developed with the suggested ID models. In order to identify differences in teaching effectiveness, instructors will be observed first in their process of developing, implementing, and evaluating the current instructions. Following this, the new approach will be suggested to the same instructors or those with similar background and experience to minimise biases and other factors. Prior to the implementation of this research, we will submit an IRB application to seek approval on the various aspects of conducting this research and to comply with policies.

To respond to the research questions, we plan to conduct two studies (see Table 1). The first study aims to compare the effects of current instructions and assessment with an alternative approach based on the theoretical elements described above; the second study will focus on gaining insight from instructors and students into the contributions and limitations of the suggested approach in their practice and student learning through interviews. We are particularly interested in students’ collaborative learning which is a challenging skill (during co-design for instance) in project-based instructions.

Table 1. Studies

Studies	Method
S1. Teaching design	DBR based on an intermediate RCT method with 2 groups
S2. Instructor interviews	Semi-directed interviews

This research discusses ED instructions and assessment of student learning. It may have relevant contributions for engineering education. It will help improve our understanding of how ED teaching can be approached through whole-task practice. The described ID models, e.g. the 4C/ID, have been used in many domains, applications such as teaching complex problem-solving, training skills and used for teacher

professional development and blended learning for general practice (e.g., Frerejean et al., 2019). We will discuss the contributions and limitations of applying this research approach in the context of ED in higher education.

## 4 References

- Caeiro-Rodríguez, M., Manso-Vázquez, M., Mikic-Fonte, F. A., Llamas-Nistal, M., Fernández-Iglesias, M. J., Tsalapatas, H., ... & Sørensen, L. T. (2021). Teaching soft skills in engineering education: A European perspective. *IEEE Access*, 9, 29222-29242, 2021, doi: 10.1109/ACCESS.2021.3059516.
- DBR Collective. (2003). Design-based research: an emerging paradigm for educational inquiry. *Educational Researcher*, 32(1), 5-8.
- Frerejean, J., van Merriënboer, J. J. G., Kirschner, P. A., Roex, A., Aertgeerts, B., & Marcellis, M. (2019). Designing instruction for complex learning: 4C/ID in higher education. *European Journal of Education*, 54(4), 513-524. <https://doi.org/https://doi.org/10.1111/ejed.12363>
- Kirschner, P. A., Sweller, J., & Clark, R. E. (2006). Why minimal guidance during instruction does not work: an analysis of the failure of constructivist, discovery, problem-based, experiential, and inquiry-based teaching. *Educational Psychologist*, 41(2), 75-86. [https://doi.org/10.1207/s15326985ep4102\\_1](https://doi.org/10.1207/s15326985ep4102_1)
- Merrill, M. D. (2002). A pebble-in-the-pond model for instructional design. *Performance Improvement*, 41(7), 41-46. <https://doi.org/10.1002/pfi.4140410709>
- Musial, M., & Tricot, A. (2020). *Précis d'ingénierie pédagogique*. De Boeck.
- Quelhas, O.L.G., Lima, G.B.A., Ludolf, N.V.-E., Meiriño, M.J., Abreu, C., Anholon, R., Vieira Neto, J. and Rodrigues, L.S.G. (2019). Engineering education and the development of competencies for sustainability. *International Journal of Sustainability in Higher Education*, 20(4), 614-629. <https://doi.org/10.1108/IJSHE-07-2018-0125>
- Tomas, L., Mills, R., Rigano, D., & Sandhu, M. (2020). Education for sustainable development in the senior Earth and Environmental Science syllabus in Queensland, Australia. *Australian Journal of Environmental Education*, 36(1), 44–62. <https://doi.org/10.1017/ae.2020.7>
- Tricot, A., & Sweller, J. (2014). Domain-specific knowledge and why teaching generic skills does not work. *Educational Psychology Review*, 26(2), 265-283. <https://doi.org/10.1007/s10648-013-9243-1>
- Sudhindra, S. T., & Blessing, L. T. (2021). A framework for design competency assessment. *Proceedings of the Design Society*, 1, 91-100.
- van Merriënboer, J. J. G. (1997). *Training complex cognitive skills: a four-component instructional design model for technical training*. Educational Technology Publications.
- van Merriënboer, J. J. G., & Kirschner, P. A. (2018a). 4C/ID in the context of instructional design and the learning sciences. In F. Fisher, C. E. Hmelo-Silver, S. R. Goldman, & P. Reimann (Eds.), *International handbook of the learning sciences* (pp. 169-179). Routledge.
- van Merriënboer, J. J. G., & Kirschner, P. A. (2018b). *Ten steps to complex learning: a systematic approach to four-component instructional design* (3rd ed.). Routledge.
- Warren, S. J., Lee, J., & Najmi, A. (2014). The impact of technology and theory on instructional design since 2000. In J.M. Spector et al. (eds.), *Handbook of Research on Educational Communications and Technology*, Springer, 89-99, doi: 10.1007/978-1-4614-3185-5\_8



## Digitalization and Online Learning



# How are Constructivist Pedagogies transforming STEM and Engineering-related Education in High School and potentially beyond?

Dr Adam Hendry

Parramatta Marist High School, Australia, [ahendry@parra.catholic.edu.au](mailto:ahendry@parra.catholic.edu.au)

Dr Daniel Bateman

Parramatta Marist High School, Australia, [dbateman@parra.catholic.edu.au](mailto:dbateman@parra.catholic.edu.au)

Joshua Bryers

Parramatta Marist High School, Australia, [jbryers1@parra.catholic.edu.au](mailto:jbryers1@parra.catholic.edu.au)

## Summary

In 2008, Parramatta Marist, a comprehensive all boys' secondary school in Sydney, Australia, introduced project-based learning and then other constructivist pedagogies to increase student engagement and soft-skill development. Since 2008, the school's performance in standardised state-wide exit exams, the Higher School Certificate (HSC), has increased considerably despite the academic profile and socio-economic status remaining relatively unchanged. Given the school's context and graduate pathways, discussion has focused on how these pedagogies have transformed STEM/Engineering education within and beyond the school. In this study, we used a mixed-method approach to analyse the impact of the pedagogical models on student performance in disciplines critical to engineering and we explored the perceptions of STEM/Engineering alumni. To assess the impact of pedagogy on student performance in the HSC, data were collected from 2001-2021 and four different groups of pedagogical combinations were compared. Results in all Mathematics and Science courses examined from the three constructivist groups showed significant growth with the evolution of pedagogical models when compared with the (earliest) *traditional* group. Additionally, a cross-sectional study of the post-school experiences of 11 graduating cohorts (2011-2021) indicate that 'STEM' alumni valued constructivist approaches to learning as these approaches align with their training and professional practice.

**Keywords:** Project-based learning; Flipped Classroom; Flipped Problem-Based Learning; STEM; Secondary school.

**Type of contribution:** Research extended abstracts

## 1 Introduction

In Australia, entry into engineering fields in higher education was traditionally determined by strong performance in standardised school exit examinations that relied heavily on content knowledge and mathematical abilities. This paradigm fostered the use of traditional or 'teacher-centred' pedagogies in which students were viewed as passive receptors of learning. However, in recent times, the most commonly-cited non-technical competencies required by engineers include problem solving, critical thinking, communication, self-regulation and collaboration (Male et.al., 2011). The acquisition of these so-called "soft" skills are difficult to achieve through the use of traditional pedagogies yet these skills are required for accreditation as a professional engineer by the industry's peak professional body, Engineers Australia. One proffered solution to acquisition of these skills are constructivist approaches like project-based learning, problem-based

learning (PrBL and PBL respectively) and the flipped classroom which are student-centered and contextualise educational information and promote solution development by the learner as the primary method of demonstrating their understanding (Kolmos 1996; Mills & Treagust, 2003; Sousa & Costa, 2022). These pedagogical styles can increase retention of content knowledge (Remhat & Hartley 2020), improve learner problem-solving skills (Duke et al., 2016; Ferreira & Trudel, 2012; Beyram & Deveci, 2022) enhance critical thinking skills (Remhat & Hartley 2020; Lapuz & Fulgencio 2020), self efficacy (Egenrieder, 2010), engagement in STEM based subjects (Hendry et al., 2016; Nurtanto et al., 2019) and increased interest in commencing careers in STEM related fields (Egenrieder, 2010; Nariman, 2021).

## 2 Constructivist pedagogies used within the school

Prior to 2008, Parramatta Marist used traditional pedagogies as the primary method of content delivery. Since then, various constructivist pedagogies have been introduced, the sequence of which can be seen below (Table 1). For a more detailed discussion of the school's pedagogical models and development, please see Hendry et al. (2017).

Table 1: Four different combinations of pedagogies utilised at Parramatta Marist High School from 2001-2021, n = number of engineering-related courses sampled over the 20-year period.

Pedagogical Combination	Years 7 & 8	Years 9 & 10	Year 11	Year 12	Time period & sample size
1	Project-based learning	Project-based learning	Flipped problem-based learning	Flipped	HSC Classes 2017-2019 (n=35)
2	Traditional	Project-based learning	1-5-1 problem-based learning	Flipped	HSC Classes 2013-2016 (n=28)
3	Traditional instruction	Project-based learning	1-5-1 problem-based learning	Traditional instruction	HSC Classes 2011-2012 (n=14)
4	Traditional instruction	Traditional instruction	Traditional instruction	Traditional instruction	HSC Classes 2001-2010 (n=70)

## 3 Methodology

To determine the impact of constructivist pedagogies on engineering-related fields in both secondary and post-school settings a mixed methods approach involving both quantitative and qualitative analyses was employed.

### 3.1 Testing of school results

To examine the impact of pedagogies at the secondary school level, HSC results from Engineering-related courses including Biology, Chemistry, Physics, Mathematics Advanced, General/Standard, Extension I and II were obtained from the New South Wales Education Standards Authority (NESA). This data included z-scores which quantify the performance of the school compared to the state by measuring the number of standard deviations between school and state means for each subject - the higher the z-score the higher the school performance relative to state performance. Z-scores were collected from the above courses across a 20-year

period that spanned the various pedagogical combinations employed at Parramatta Marist over time (Table 1). Various comparisons were made including:

- 1) Changes in z-scores across all Engineering-related courses over time
- 2) Changes in z-scores across each separate Engineering-related course over time

Separate one-way permutational ANOVAs (PERMANOVAs) were used to determine whether school z-scores varied relative to pedagogical combination, with pairwise comparisons between pedagogies used to determine where differences between pedagogies lay ( $\alpha < 0.05$ ). PERMANOVA is a highly robust test and its permutational nature negates the need to use corrections for error when conducting multiple tests.

### 3.2 Alumni survey of 'PBL/Constructivist' educated graduates 2011-2020

In 2021, 311 out of 1478 graduates in the period of 2011 to 2020 were surveyed. All these students had been educated under constructivist models of learning within the school. A self-rating questionnaire (based on Schmidt, Vermeulen & van der Molen, 2006) enabled participants to compare their interpersonal skills, as well as their cognitive, academic and task-supporting competencies with their colleagues, if they were in the workplace, or with their classmates, if they were still studying.

## 4 Results

### 4.1 School results

School performance in all engineering-based courses combined varied significantly in relation to the pedagogical combination employed across all comparisons (Pedagogy 1 > 2 = 3, 2 > 4, 3 = 4; Figure 1).

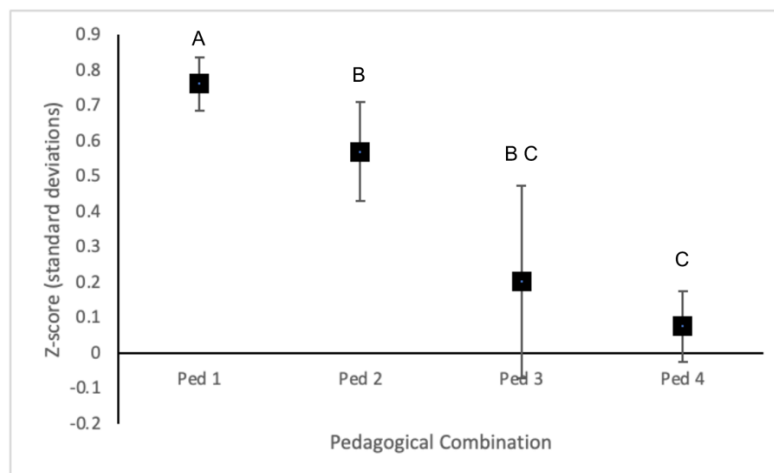

Figure 1: The mean  $\pm$  95%CI z-scores in all Engineering-related subjects combined (Chemistry, Physics, Engineering Studies, Mathematics Advanced, Extension 1, Extension 2 and Mathematics Standard) across 4 pedagogical combinations employed at Parramatta Marist High from 2001-2021. Letters indicate significant differences between treatments.

Although specific course results varied depending on the course examined, pedagogy 1, that included both flipped learning in year 12 and flipped problem-based learning in year 11, consistently exhibited a significantly greater academic performance than other combinations that included traditional pedagogies (Table 2).

### 4.2 Survey of PBL educated graduates 2011-2021

Of the 311 alumni surveyed, 164 studied in engineering-related fields at a tertiary level and 104 entered careers in these fields. STEM tertiary students and those working in STEM fields overwhelmingly attributed

the development of skills such as Critical Thinking ( $4.2/5 \pm 0.9$  [mean  $\pm$  SD], students;  $3.9/5 \pm 1$  workers), Problem Solving ( $4.2/5 \pm 0.9$ , students;  $4/5 \pm 1$ , workers), Collaboration ( $4.6/5 \pm 0.8$ , students;  $4.4/5 \pm 1$ , workers) and Communication ( $4.4/5 \pm 0.9$ , students;  $4.2/5 \pm 1$ , workers) to their high school education.

Table 2: Pairwise comparisons of pedagogical combinations assessing how school performance in separate engineering-related courses varied compared to the state in relation to pedagogical combination. In all columns, the first pedagogical combination (left) is measured against the second pedagogical combination (right). All differences indicated (\*) are significant at  $\alpha < 0.05$ .

Course	1 & 2	1 & 3	1 & 4	2 & 3	2 & 4	3 & 4
Biology	=	=	> *	=	> *	=
Chemistry	=	> *	> *	=	> *	=
Physics	=	=	> *	=	> *	=
Mathematics Standard	=	=	> *	=	> *	=
Mathematics Advanced	=	=	> *	=	> *	=
Mathematics Extension 1	=	=	> *	=	> *	=
Mathematics Extension 2	> *	=	=	> *	=	=

## 5 Discussion

Whilst not the primary motivation behind the introduction of constructivist pedagogies, the results of our study indicate that their introduction and evolution have resulted in significant improvements in student performance in state-mandated examinations in engineering-related fields. In contrast to traditional approaches, these pedagogies have clear perceived benefits to 'PBL-educated' alumni relative to their colleagues. These alumni attribute an increased ability to collaborate, communicate and problem solve at tertiary level and in the workplace, to the constructivist pedagogies they experienced during their high school years. In retrospect, this combination of deeper disciplinary knowledge and soft skill acquisition was considered most important to those alumni in engineering-related fields given the accreditation process for Engineers Australia places them on an equal footing within their 'competency standards'.

The authors believe that this transformative educative process has significant implications for engineering within and beyond school by producing graduates ideally suited to the profession. Furthermore, the authors posit that the mechanisms that drive this process are the constructivist pedagogies themselves. Project- and problem-based learning differ from other pedagogies as they are student-centred and have, as their prime motivation within the learning process, an open-ended, ill-defined and authentic 'problem'. More specifically, the metacognitive strategies (like the 'Know and Need to Know' lists) embedded within the pedagogies help learners to develop routines, organise their thoughts and scaffold problem solving processes under the guidance of a trained facilitator. Additionally, these approaches afford students the opportunity to collaborate with peers, develop interpersonal, communication, reporting and presentation skills as well as their critical thinking skills – the very same skills demanded by industry and peak professional bodies like Engineers Australia. Lastly and most tellingly, when the skills developed within these modes of learning are integrated with the flipped classroom approach, a significant improvement in academic achievement in standardised state-wide exit exams has been evidenced by this school.

## 6 References

- Duke, N. K., Halvorsen, A.-L., & Strachan, S. L. (2016). Project-based learning not just for STEM anymore. *The Phi Delta Kappan*, 98(1), 14–19. <http://www.jstor.org/stable/24893301>
- Egenrieder, J. A. (2010). Facilitating Student Autonomy in Project-Based Learning to Foster Interest and Resilience in STEM Education and STEM Careers. *Journal of the Washington Academy of Sciences*, 96(4), 35–45. <http://www.jstor.org/stable/24536352>
- Ferreira, M. M., & Trudel, A. R. (2012). The Impact of Problem-Based Learning (PBL) on Student Attitudes Toward Science, Problem-Solving Skills, and Sense of Community in the Classroom. *The Journal of Classroom Interaction*, 47(1), 23–30. <http://www.jstor.org/stable/43858871>
- Hendry, A., Hays, G., Lynch, D., & Challinor, K. (2016). Enhancing student learning through Project Based Learning (PBL) in a secondary school integrative STEM course. Southern Cross University (AAEE 2016 Conference).
- Hendry, A., Hays, G., Challinor, K., & Lynch, D. (2017). Undertaking Educational Research Following the Introduction, Implementation, Evolution, and Hybridization of Constructivist Instructional Models in an Australian PBL High School. *Interdisciplinary Journal of Problem-Based Learning*, 11(2). Available at: <https://doi.org/10.7771/1541-5015.1688>
- Kolmos, A. (1996). Reflections on Project Work and Problem-based Learning, *European Journal of Engineering Education*, 21(2), 141 – 148.
- Lapuz, A.M.E., & Fulgencio, M.N. (2020). Improving the Critical Thinking Skills of Secondary School Students using Problem-Based Learning. *International Journal of Academic Multidisciplinary Research*, 4(1), 1-7. Available at SSRN: <https://ssrn.com/abstract=3543211>
- Male, S.A., Bush, M. B., & Chapman, E. S. (2011). An Australian study of generic competencies required by engineers, *European Journal of Engineering Education*, 36(2), 151-163. DOI: 10.1080/03043797.2011.569703
- Mills, J.E., & Treagust, D.F. (2003). Engineering Education – Is Problem-Based or Project-Based Learning the answer? *Australasian Journal of Engineering Education*, Available at: [http://www.aaee.com.au/journal/2003/mills\\_treagust03.pdf](http://www.aaee.com.au/journal/2003/mills_treagust03.pdf)
- Nariman, N. (2021). How Does an Industry-Aligned Technology-Rich Problem-Based Learning (PBL) Model Influence Low-Income and Native Hawaiian Student's STEM Career Interest? *Journal of Problem Based Learning in Higher Education*, 9(1), 150-178. <https://doi.org/10.5278/ojs.jpblhe.v9i1.6367>
- Nurtanto, M., Sofyan, H., Fawaid, M., & Rabiman, R. (2019). Problem-based learning (PBL) in industry 4.0: Improving learning quality through character-based literacy learning and life career skill (LL-LCS). *Universal Journal of Educational Research*, 7(11), 2487–2494. <https://doi.org/10.13189/ujer.2019.071128>
- Schmidt H. G., Vermeulen L., & van der Molen H. T. (2006). Long term effects of problem-based learning: a comparison of competencies acquired by graduates of a problem-based and a conventional medical school. *Med Educ*. 40(6), 562-7. doi: 10.1111/j.1365-2929.2006.02483.x. PMID: 16700772.
- Sousa, M. J., & Costa, J. M. (2022). Discovering entrepreneurship competencies through problem-based learning in higher education students. *Education Sciences*, 12(3), 185. <https://doi.org/10.3390/educsci12030185>

# A study on the use of Flipped Classroom in a Mentorship Programme for STEM Females

Aderonke Sakpere<sup>1</sup>, Wonder Osalor<sup>1</sup>, Divine Nwdibuife<sup>1</sup>, Fenton Hughes<sup>2</sup> & Halleluyah Aworinde<sup>3</sup>

<sup>1</sup>Tech Girls Club – University of Ibadan, Nigeria, [techgirlsclub1@gmail.com](mailto:techgirlsclub1@gmail.com)

<sup>2</sup>Uncity Company, USA

<sup>3</sup>Directorate of Digital Services, Bowen University, Nigeria

## Abstract

Science, Technology, Engineering and Mathematics (STEM) disciplines have recorded a low number of female enrolments in various higher institutions. Furthermore, study has shown that the little number of females who enroll in STEM also struggle with drop-out. In this study, we attempt to bridge the gender gap in STEM through a mentorship programme to help females in developing soft skills through a design thinking course which adopted the flipped classroom model in the delivery of knowledge. Design thinking is an innovation methodology that solves problems in an iterative manner as opposed to the traditional method of solving problems in a linear manner. The mentorship programme lasted for four weeks. With respect to the flipped classroom model used for engaging the participants, 72.7% of the respondents agreed that flipped classroom model helped them to better understand design thinking concepts and prepare them for making contributions during in-class discussion. A future recommendation would be that the next mentorship programme should adopt a blended learning methodology, that is, the use of traditional teaching and flipped classroom model.

**Keywords:** Flipped Classroom, Design Thinking, Pedagogy, Gender Gap, Mentorship

**Type of contribution:** Research Extended Abstract

## 1 Introduction

According to a UNESCO report, only 35% of science, technology, engineering, and mathematics (STEM) students in higher education globally are women (UNESCO, 2021). However, in some specific disciplines such as Information and Communication Technologies (ICT), the percentage could be as low as 3% (UNESCO, 2021). Furthermore, study has shown that the little number of females who enroll in STEM also struggle with drop-out (Isphording & Qendrai, 2019). Mentorship has been identified as a means by which this wide gap can be bridged and drop-out rate reduced (Isphording & Qendrai, 2019). To improve the impact of mentorship programmes, Mbogho (Mbogo, 2019) has suggested the adoption of critical thinking skills (Mbogo, 2019). Critical thinking includes the component skills of analyzing arguments, making inferences using inductive or deductive reasoning, judging, or evaluating, and making decisions or solving problems (Lai, 2011).

From research, many institutions in Nigeria and other developing countries employ traditional teaching approaches, which encourage cramming and often engage students at the lower level of the bloom taxonomy (Huitt, 2011). As a result, students are often unable to come up with innovative solutions and graduates often do not meet the demands of today's job market for problem-solving and critical thinking skills (Osoba et al., 2021). In a traditional instructor-centered classroom, the teacher delivers lectures during class time and gives students homework to be done after class. In a flipped, or inverted, classroom, things are done the other way round: the teacher “delivers” lectures before class in the form of pre-recorded videos and spends class time engaging students in learning activities that involve collaboration and interaction. (Mok, 2014). From research, flipped classroom model has been used in various school settings for courses such as social sciences

(Roheling et. al., 2017), STEM (Fung, 2020), Arts (Ansori & Nafi, 2018). However, there is still a gap on how flipped classroom model has been adopted in a semi-formal setting such as a mentorship programme which does not necessarily accrue toward school credit. As a result, this research attempts to study how flipped classroom model can be adopted in a mentorship programme.

### **1.1 Research Objective and Research Question**

The objective of this study is to evaluate how female students in STEM perceived the use of flipped classroom pedagogical approaches to foster critical thinking skills, improve engagement and impact of mentorship programmes. This study intends to address the question: Is Flipped Classroom model effective for a mentorship programme targeted at STEM females?

## **2 Methodology**

The mentorship programme was organized by Tech Girls Club, a non-governmental organization in the University of Ibadan, Nigeria. The teaching and interaction between the facilitator and the participants took place virtually. The Web-based videoconferencing software application Zoom was used for the real-time interaction with the facilitator while Google Classroom was used as the Learning Management System (LMS) and asynchronous interaction. The flipped classroom model was the adopted pedagogy. According to Razzouk & Shute (2012), design thinking has been identified to help develop critical thinking skills. As a result, the mentorship programme focused on the principles of design thinking.

### **2.1 Participants**

The mentorship programme was opened to people of all backgrounds especially girls in STEM. Prior to the commencement of the mentorship programme, application advert was made on various social media platforms. The first class had over 30 people in attendance. Participation dropped afterwards with about 20 people in the second class. Then in the third class, about 15 people attended and, in the 4th, class, which is the final one, about 15 people also attended. To understand the reason for dropping out, some of those who dropped out were contacted. The reasons given for dropping out included the following: clash with other activities, family demands, work demands, time-constraint. Many of those who dropped out were women who are either married or working. It was therefore difficult for them to combine family/work demands with the mentorship programme.

### **2.2 Procedure**

The mentorship programme spanned four weeks. The first week was basically an introduction to design thinking, the LMS (Google Classroom) used, overview of the themes and course expectations. In week 2 of the mentorship programme, the participants started a project of their choice that centers around a roadmap for a career choice. The mid-course survey/evaluation was administered after week 2 lecture. During the in-class discussion of week 3, participants were grouped and asked to discuss the lesson learnt in the process of their ideation and prototype. In week 4, participants were asked to ideate and prototype an alternate odyssey plan. In addition, they were asked to further think on the prototype of their first/main Odyssey plan for risks that could frustrate it and how to mitigate such. The final evaluation was designed to understand the holistic perception of the participants about the class and whether they would recommend the course/programme.

### **2.3 Data Collection and Analysis**

Two evaluations were carried out. One at the middle of the course and the other at the end of the course. Google Forms were designed and used for data collection to understand the perception of the participants about the teaching style (flipped classroom model) adopted. The data collected can be grouped as open-ended and close-ended. In total (that is for the 2 surveys), there were 6 close-ended questions and 5 open-ended questions. The open-ended gives the participants liberty to express their thoughts without constraining them to a set of options. The close-ended constrains the participants to choose from a set of options. 5 Likert-scale was employed for the close-ended. Participation in both the mid-evaluation and final evaluation was voluntary and anonymous. A total of 11 participants responded to the mid-evaluation survey while a total of five participants responded to the final evaluation survey.

### 3 Findings on the Suitability of Flipped Classroom Model

For the mid-evaluation, a key objective was to understand participants perception of the flipped classroom model. To measure that, the following prompts were coined: (i) The concept of the flipped classroom learning model adopted in this class (i.e., the release of short videos before class and pre-class activity) helps me better understand and contribute to in-class discussion (ii) The concept of the flipped classroom learning model adopted in this class (i.e., the release of short videos before class and pre-class activity) is new to me and I am really struggling to understand the course and catch up. A total of 11 learners participated in the mid-evaluation. From our finding, as represented in Figure 1, 72.7% of the respondents agreed that the concept of flipped classroom model helps them better understand and contribute to in-class discussion while 27.3% disagreed.

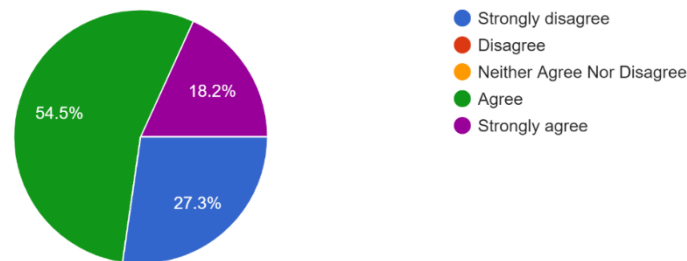

Figure 1: Distribution of response based on Perception of Flipped Classroom (Mid-Evaluation)

Furthermore, as illustrated in figure 2, 18.2% say the Flipped Classroom Model is new to them and are struggling with understanding the course/catch up with class while 45.5% are neutral and the rest 36.4% disagree that they are struggling as a result of the use of the flipped classroom model.

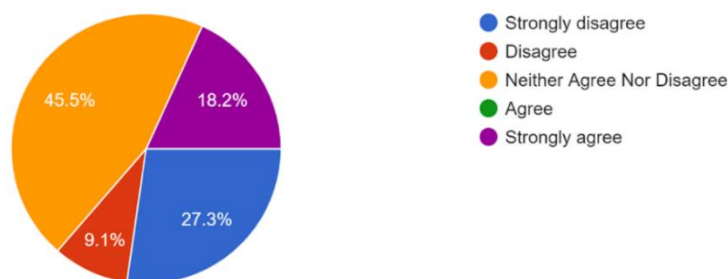

Figure 2: Distribution of response based on Adaptation to flipped Classroom (Mid-Evaluation)

From the open-ended question on what participants like most about the class/flipped classroom model, responses that emerged include the following: (i) The flipped classroom model encourages class contribution



and active learning, (ii) It provides platform for practice during in-class sessions and (iii) Provides platform to learn from others.

For the final evaluation, we had 5 participants. A major interest was likelihood of the participants introducing or recommending the class. 80% of the respondents noted that they would give a 100% recommendation and 20% of the respondents noted they would give a 90% recommendation. None of the respondents wouldn't recommend it or give less than a 90% degree of recommendation. A major reason a couple of the respondents gave for the high level of recommendation is due to the insightful and educative nature of the course.

#### 4 Discussion

We compare our result with that of Mbogho (2019) which also focused on mentorship programme targeted at improving critical thinking and soft skills amongst Africans. Results obtained are similar in recommendation rate but widely different in retention rate. The retention rate of our mentorship programme is estimated at 42.9% while that of Mbogho is on average 82.67%. A major reason for this low retention rate in our case is because it's solely targeted at females, many of whom are married with family or working and found it difficult coping or combining the mentorship programme with their family or job demands after week 2. On the other hand, that of Mbogho isn't gender-specific and solely targeted at students in higher institution who perceived the mentorship programme as having immediate benefit to their studies. An implication of this, is that there is still a need for further research on how to increase retention rate of married or working-class females in a mentorship programme.

Our mentorship programme and that of Mbogho (2019) share similar rating in terms of how likely participants will recommend the programme. Mbogho (2019) result shows that 100% of the students indicated that they would recommend a friend to apply to the mentorship program. In our case, 80% of the respondents indicated they would give 10/10 (on a scale of 10) recommendation and 20% recommended 9/10 recommendation rate. Though, it's unclear the scaling rate used in Mbogho (2019), the 9/10 rating of the 20% in our case is as good as 10/10 rating and as a result we can conclude that the 100% of the respondents of the final evaluation survey of our mentorship programme would recommend the programme.

On further one-on-one interaction with participants of our mentorship programme about adoption of the flipped classroom model in comparison to traditional model of teaching, a response is "The flipped classroom was good yes but it's too soon to say which I prefer. But I think a fusion of traditional and flipped classroom will do better in our society." This kind of mixed preference is also recorded in the research of Roehling et. al. (2017) since the experimented course is more theoretical. Though in our case it's a STEM based programme which is hands-on, the reason for the mixed preference is because the participants are new to flipped classroom model and need time to adjust to it.

Finally, from our research, the use of flipped classroom model for design thinking promoted in-class contribution which according to Carino et. al (2018) is helpful to promote creativity and intelligence which are 2 key components needed to foster design thinking and critical thinking. In this case, learning is bi-directional rather than uni directional.

#### 5. Conclusion

Past and recent research on the impact of the flipped classroom on students in various settings has shown promising and positive outcomes. From the evaluation of the four-week mentorship programme on Design

Thinking which adopted the Flipped Classroom Model as the teaching methodology, it is shown that STEM female learners showed positive attitudes towards flipped classroom model on their learning and in-session practice. However, to further validate the facts drawn from the evaluation, more research would be carried out, using the flipped classroom model for mentorship, with a wider range of participants and focusing on using local contents as opposed to examples from Western World.

## Acknowledgement

Thanks to Dr. Rea Lavi of the School of Engineering at Massachusetts Institute of Technology (MIT) for his advice and support with this manuscript. Also, sincere appreciation to the MIT-Empowering The Teachers programme (ETT) for exposing the main author to cutting-edge pedagogy that can drive revolution and produce graduates with 21<sup>st</sup> century skills in Africa. Finally, thanks to TotalEnergies for sponsoring the ETT programme.

## References

- Ansori, M., & Nafi, N. N. (2018). English teachers' perceived benefits and challenges of flipped classroom implementation. *JEELS (Journal of English Education and Linguistics Studies)*, 5(2), 211-227.
- Canina, M., Bruno, C., & Piselli, A. (2018). Design thinking via flipped classroom. In *DS 93: Proceedings of the 20th International Conference on Engineering and Product Design Education (E&PDE 2018)*, Dyson School of Engineering, Imperial College, London. 6th-7th September 2018 (pp. 468-475).
- Fung, C. H. (2020). How does flipping classroom foster the STEM education: A case study of the FPD model. *Technology, Knowledge and Learning*, 25(3), 479-507.
- Huitt, W. (2011). Bloom et al.'s taxonomy of the cognitive domain. *Educational psychology interactive*, 22.
- Isphording, I.E. and Qendrai, P., 2019. Gender Differences in Student Dropout in STEM. *Institute for the Study of Labor (IZA) Research Reports*, 87.
- Lai, E.R., 2011. Critical thinking: A literature review. *Pearson's Research Reports*, 6(1), pp.40-41.
- Mok, H.N., 2014. Teaching tip: The flipped classroom. *Journal of information systems education*, 25(1), p.7.
- Mbogo, C. (2019). A Structured Mentorship Model for Computer Science University Students in Kenya. In *Proceedings of the 50th ACM Technical Symposium on Computer Science Education* (pp. 1109-1115).
- Mok, H.N., 2014. Teaching tip: The flipped classroom. *Journal of information systems education*, 25(1), p.7.
- Osoba, Moyosoore, Shamsudeen Usman, Oluwafemi Oyadiran, Joseph Odeyemi, Michelle Abode, Olamide Usman, Olufemi Olulaja, Olusina Ajidahun, and Don Eliseo Lucero-Prisno III (2021). "Undergraduate medical education in Nigeria: current standard and the need for advancement." *The Pan African Medical Journal* 40.
- Razzouk, R., & Shute, V. (2012). What is design thinking and why is it important? *Review of educational research*, 82(3), 330-348.
- Roehling, P. V., Root Luna, L. M., Richie, F. J., & Shaughnessy, J. J. (2017). The benefits, drawbacks, and challenges of using the flipped classroom in an introduction to psychology course. *Teaching of Psychology*, 44(3), 183-192. UNESCO. Girls' and women's education in science, technology, engineering and mathematics (STEM). <https://en.unesco.org/stemed>, retrieved 24<sup>th</sup> April, 2021.

# Work-in-Progress: Codatus – An Innovative Online Practical Platform for Transforming Coding Education

Pauli Lai

The Hong Kong Polytechnic University, Hong Kong, [pauli.lai@polyu.edu.hk](mailto:pauli.lai@polyu.edu.hk)

## Summary

The pandemic has disrupted the learning mode worldwide, and teachers have to figure out new ways to motivate programming students to learn. The computer labs were not accessible during the pandemic. Unlike conventional coding courses, which require computer labs with pre-established platforms for students to practise coding, students had to set up a specific computer environment for code writing on their own while online. The setup process is time-consuming.

Besides, submitting programming assignments was cumbersome. Students had to screencap the answers to the assignments and put them into a word file for teachers' manual marking. It took time for teachers to return these assignments for students' review and further study.

To address these issues, we developed a brand-new online platform—Codatus. Codatus features the online execution of codes, submission and auto-grading of coding assignments to provide a consistent environment for students to practice coding with just a web browser. Codatus also provides a unique "Issue Ticket" feature for public and private enquiries.

This platform has facilitated students' learning with more interactions, motivated students and expedited their learning of code writing. Students find it effective in helping them learn the subject during the pandemic.

**Keywords:** auto-grading, coding platform, programming, SQL, virtual lab

**Type of contribution:** Research extended abstracts

## 1 Background

Conventional coding courses require computer labs with pre-established platforms for students to practise coding. Before the pandemic, face-to-face teaching allowed teachers to come to the aid of students whenever students encountered problems with the coding platforms. However, students had no access to the computer labs during the pandemic when social distancing was in place.

With the migration of learning to the online mode during the pandemic, students had to set up a specific computer environment for code writing on their computers. The setup process is time-consuming, and each computer environment may have discrepancies, which spell trouble for teachers' investigation in online classes. According to our survey, most students face difficulties installing and configuring SQL servers, confusion over how different software operates and getting support from teachers in an online environment. It calls for a need to have an online platform that provides a consistent environment for code execution so that students can focus more on learning code writing with minimal effort in setting up the environment at home.

Furthermore, for assignment submission, previously, students had to submit screen captures for manual grading by teachers. It was tiresome for students to run the code on their computers, copy the screen

captures of their coding statements and output results to a report for submission. Also, it took considerable time for teachers to grade and return the results for students to review the correctness and feedback of their answers. Given the time taken to grade assignments, manual marking of coding assignments is not ideal nowadays for evaluating students' capabilities in coding (Bhanuse et al., 2022). While some online coding platforms are available, they are neither designed for learning SQL specifically nor do they feature online submission of coding assignments with auto-grading. Meanwhile, chatbots like ChatGPT may simply replace humans to do the coding work without guiding students to write codes.

Hence, we developed a brand-new online platform—Codatus, to provide a consistent environment for students to practice coding with just a web browser. Codatus features the online execution of codes so that students can focus on coding and spend less time setting up environments. Codatus supports different languages, including SQL, Java, C++, and Swift. Also, Codatus provides auto-grading of coding assignments so that teachers save time in grading and students can view their scores instantly without waiting for the return of their manually graded assignments.

In addition, Codatus provides a unique "Issue Ticket" feature, with which students can discuss coding problems publicly with peers or raise questions privately with teachers. This platform has facilitated students' learning with more interactions, motivated students and expedited their learning of code writing. Students find it effective in helping them learn the subject during the pandemic.

Having developed Codatus as an online coding platform, our research question is to study whether Codatus could facilitate students to learn coding online during the pandemic. We find that Codatus has facilitated students to learn coding online during the pandemic and enhanced their academic performance.

## 2 Literature Review

Covid-19 imposed constraints on interactions between programming students, and such conditions called for the need to develop a platform for online learning of programming with the aid of technology (Novaliendry et al., 2021). For learning SQL online, many issues are associated with installing and configuring the MySQL Query Browser, etc. (Cigas & Kushan, 2010). Meanwhile, teaching programming requires tremendous effort as teachers have to persistently keep track of students' learning activities with substantial feedback (Cardoso et al., 2021). Besides, manual grading of SQL assignments is time-consuming, while feedback to students may be delayed (Sadiq et al., 2004). One study suggests using online platforms to aid students in studying programming (Zinovieva et al., 2021). There are many free coding platforms for students to learn coding (Siegle, 2017). However, lacking appropriate feedback mechanisms may cause novice programmers to experience frustration and disengage from the learning experience. Hence, a feedback mechanism should be available on these platforms. (Drosos et al., 2017). With online teaching, the essence is to deliver programming labs online "without significant methodological changes, which might imply modifications of the learning outcomes" (Garcia et al., 2021, p. 162). A coding platform should incorporate direct feedback to students to motivate them to learn (Combéfis & CLÉMENT de SAINT-MARCQ, 2012).

## 3 Research Method

### 3.1 Development of Codatus

In view of the inaccessibility to the physical labs and lack of interactions and discussions during the pandemic, we developed an online coding platform, Codatus, that allows students to use a browser to work on the coding exercises. Codatus allows teachers to customize the question sets and answers for auto-grading. The platform also features an issue-tracking function to let students tie their enquiries to the relevant questions and previous attempt records. It will also provide a collaborative code-writing feature to pair up students for collaborative editing. Our project is innovative in reinventing the process of practical coding classes supported by Codatus's unique features.

### 3.2 Trialing of Codatus

We have trialed Codatus for practising SQL in the subject of Database System. There were 153 students in this class. We briefed all students about this study, and they gave their consent to participate in this study. All participations were voluntary. They used Codatus to practice SQL and submit lab works for Lab 1 and Lab 2.

### 3.3 Mixed research approach

Our research question is to study whether Codatus could facilitate students to learn coding online during the pandemic. We adopted a mixed methods approach. Mixed methods research is usually a combination of qualitative and quantitative research approaches (Johnson et al., 2007).

In the quantitative phase, we keep an eye on numerical data such as the number of students who attempted to use Codatus, the number of their attempts, and their academic results to determine any correlation between them. We also arranged pre-survey and post-survey to identify the students' problems learning SQL online. We also studied whether our intervention with the provision of Codatus has helped the students learn SQL.

In the qualitative phase, we arranged online interviews with students and teachers to obtain detailed information about the students' preferences and to explore students' beliefs or perceptions towards Codatus.

Combining the strength of mixed research methods can give us deeper insights and reach broader conclusions (Johnson et al., 2007).

## 4 Results and Analysis

### 4.1 A need for Codatus

In our pre-survey with the students, about 57% of the students have issues with the installation and configuration of SQL servers, confusion over how different software operates and getting support from teachers in an online environment. Meanwhile, about 40% of the students spent more than 30 minutes setting up the environment on their computers to learn programming each time, which occupied 1/6 of the lab time. More than 80% of the students agree that online SQL statement execution without setting up an environment could reduce preparation time, allowing more time for practising SQL exercises. The above information justifies the need for a coding platform with the feature of submission and grading of coding assignments.

### 4.2 High Participation Rates

Codatus, as an online coding platform, had high participation rates. Students kept practising code writing and had multiple attempts for each question during the lab sessions.

We had two lab sessions related to SQL on this subject. Out of the 153 students, 151 students, i.e., 98.69% of the students, participated in the Lab 1 session by attempting questions with Codatus. Meanwhile, 139 students (90.85%) completed all 19 questions. Each participant has an average of 126.22 attempts. Each student, on average, attempted each question about 6.64 times.

In Lab 2 (Part 1-3), the same number of students (151) attempted questions with the same participation rate of 98.69%. 139 students (90.85%) completed all 14 questions, while each participant had an average of 83.95 attempts. On average, each student tried each question about 6 times.

In Lab 2 (Part 4), 145 students attempted questions with a participation rate of 94.77%. 125 students (81.7%) completed all 9 questions. The average number of attempts for each student is 41.7, while each student attempted each question about 4.6 times on average.

For the "Issue Ticket" feature, there are altogether 150 issues with 523 messages on our Codatus platform. An issue refers to the enquiry on one topic, while a message refers to the conversation within each issue. 26 students (17%) raised issues with the "Issue Ticket" features.

### 4.3 Students in favour of Codatus

Students are in favour of Codatus. According to the post-survey of Codatus, more than 80% of the respondents agree that Codatus is effective in helping them learn the subject during the pandemic, as shown in Fig. 1. Its auto-grading feature shortens the time to receive the grade and teacher feedback. Students could also put more time into learning and practising SQL without setting up the environment. When students know their grades earlier, they can learn from their mistakes.

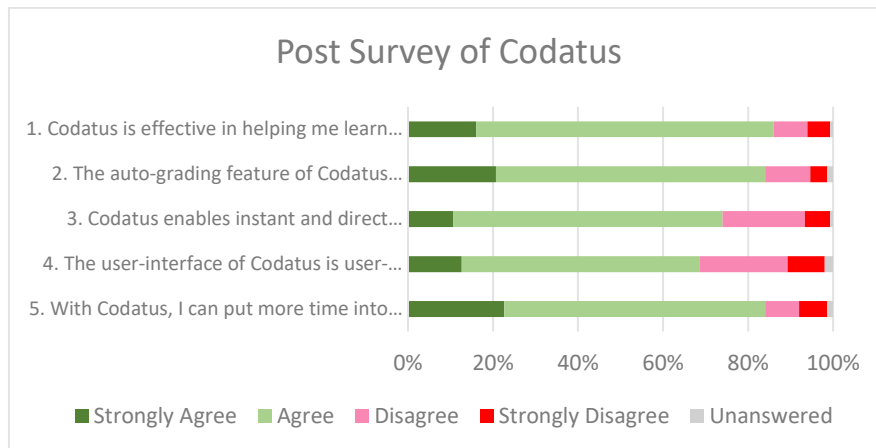

Fig. 1 Post-Survey of Codatus indicates that the majority of students favour it

### 4.4 Improvement in academic performance

With the introduction of Codatus in the database subject, the students' test results regarding SQL (Test 1) have improved by 8.99% compared to last year's test on SQL. The improvement in academic performance related to SQL indicates that Codatus has helped students perform better regarding SQL. The improvement of the average Test 1 Score is shown in Table 1.

Table 1 Average Test 1 Score improved with the Codatus coding platform

	2020/21	2021/22	Changes
Average Test 1 Score	73.38793	79.98904	8.99%

### 4.5 Interview with students

In an interview, a student pointed out that Codatus is an excellent platform for students to check whether their codes (SQL statements) conform to the standard(s). Though many online compilers are in the market, Codatus is more intelligent since other compilers just run the codes while Codatus offers auto-grading for checking the correctness of the results. This student told us that initially, he did not know that this platform of Codatus was developed by his teacher(s). He thought it was just a platform that any school in the market may use. He then realized that Codatus was uniquely developed by the teachers. He even told his friends in other schools that he has this unique coding platform (Codatus) for learning SQL.

### 4.6 Interview with teachers

According to a teacher, Codatus is a platform to let students learn codes. When asked if ChatGPT can serve the same purpose, that teacher told us that ChatGPT and Codatus are entirely different. ChatGPT is a chatbot with lots of knowledge. Of course, one can ask ChatGPT to teach students programming. However, ChatGPT

does not aim to let students complete a customized assignment given by a teacher. Besides, it does not provide a collaborative environment for students to write codes with others. The teacher intends to build platforms to enhance human ability, not to build something to replace humans.

## 5 Conclusion

Overall, Codatus lets students learn code writing virtually with just a web browser. It has facilitated the learning process of code writing amid the pandemic when face-to-face learning is unavailable. Students find that this subject is the most tailored-made for online or virtual learning among the subjects they have studied. Still, the user interface of Codatus needs time to be more adaptable to user needs. According to the students, there is room for further streamlining of Codatus, such as allowing pictures input in the "Issue Ticket" mechanism. To enhance student interaction, we will add a collaborative editing feature to enable students to co-edit their codes in real-time so that they can collaborate and learn from each other.

All in all, Codatus has transformed coding education in the way that students can execute codes online, submit coding assignments with auto-grading, discuss coding problems with peers and teachers, and work collaboratively on an all-in-one platform. With the return of face-to-face teaching, Codatus, as an online coding platform, still provides students with the flexibility of learning to program ubiquitously.

## 6 References

- Bhanuse, R., Bawankar, U., Sharma, D. M., Patle, M., Narsapurkar, V., & Sawate, S. (2022). A coding platform: For all programming labs and practical examination. *AIP Conference Proceedings*, 2424(1), 060001. <https://doi.org/10.1063/5.0076793>
- Cardoso, M., Marques, R., Castro, A. V., & Rocha, Á. (2021). Using Virtual Programming Lab to improve learning programming: The case of Algorithms and Programming. *Expert systems*, 38(4), n/a. <https://doi.org/10.1111/exsy.12531>
- Cigas, J., & Kushan, B. (2010). Experiences with online SQL environments. *Journal of Computing Sciences in Colleges*, 25(5), 251-257.
- Combéfis, S., & CLÉMENT de SAINT-MARCO, V. I. (2012). Teaching Programming and Algorithm Design with Pythia, a Web-Based Learning Platform. *Olympiads in Informatics*, 6.
- Drosos, I., Guo, P. J., & Parnin, C. (2017, 11-14 Oct. 2017). HappyFace: Identifying and predicting frustrating obstacles for learning programming at scale. 2017 IEEE Symposium on Visual Languages and Human-Centric Computing (VL/HCC),
- Garcia, M., Quiroga, J., & Ortin, F. (2021). An Infrastructure to Deliver Synchronous Remote Programming Labs. *IEEE transactions on learning technologies*, 14(2), 161-172. <https://doi.org/10.1109/TLT.2021.3063298>
- Johnson, R. B., Onwuegbuzie, A. J., & Turner, L. A. (2007). Toward a definition of mixed methods research. *Journal of mixed methods research*, 1(2), 112-133.
- Novaliendry, D., Huda, A., Cuhanazriansyah, M. R., Sani, H. K., Hendra, H., & Karnando, J. (2021). E-Learning Based Web Programming Course in the COVID 19 Pandemic Time. *International journal of interactive mobile technologies*, 15(20), 117-130. <https://doi.org/10.3991/ijim.v15i20.23749>
- Sadiq, S., Orłowska, M., Sadiq, W., & Lin, J. (2004). *SQLator: an online SQL learning workbench* Proceedings of the 9th annual SIGCSE conference on Innovation and technology in computer science education, Leeds, United Kingdom. <https://doi.org/10.1145/1007996.1008055>
- Siegle, D. (2017). Technology: Encouraging Creativity and Problem Solving Through Coding. *Gifted child today magazine*, 40(2), 117-123. <https://doi.org/10.1177/1076217517690861>
- Zinovieva, I. S., Artemchuk, V. O., Iatsyshyn, A. V., Popov, O. O., Kovach, V. O., Iatsyshyn, A. V., Romanenko, Y. O., & Radchenko, O. V. (2021). The use of online coding platforms as additional distance tools in programming education. *Journal of Physics: Conference Series*, 1840(1), 12029. <https://doi.org/10.1088/1742-6596/1840/1/012029>

# Engineering Students' Perceptions of Digital Competences in a PBL Environment

Sofie Otto

Aalborg University, Denmark, [sio@plan.aau.dk](mailto:sio@plan.aau.dk)

Lykke Brogaard Bertel

Aalborg University, Denmark, [lykke@plan.aau.dk](mailto:lykke@plan.aau.dk)

## Summary

With the rapid digital transformation in industry and society, further accelerated by emerging technologies, digital literacy as a set of digital competences is quickly becoming essential for the 21st century engineer and engineering student alike. Thus, different strategies are currently being applied in curriculum development and teaching practices to integrate digital competency in formal engineering education curricula. However, few studies take point of departure in students' perceptions of digital competences, its relation to their learning experiences and environment as well as their future perspectives and expectations towards what digital competences are required within their profession. This extended abstract presents an approach to understand, verbalize, and categorize digital competence within a systemic PBL environment and explores engineering student current perceptions of the digital competences they believe they develop within this learning environment. Based on empirical data collected through a series of workshops centered around digital practices supporting PBL project work, we synthesize and analyze general trends, potentials and challenges based on students written accounts of their digital user, creator, and reflective competences in relation to their general academic, PBL and discipline-specific practices. Findings show an overall predominance of accounts that relate to skills rather than competences as well as a general absence of contextualization across competence types, indicating that it may be difficult for students to articulate and reflect upon their digital competences in general. Finally, students do not substantially relate their digital creator competences to aspects outside of their respective disciplines. We conclude that formal learning outcomes related to digital competences are indeed needed, but that these should be supported by systematic reflective practices that support engineering students in developing and externalizing both transversal and discipline-specific digital competences.

**Keywords:** Digital competences, Problem-Based Learning, Engineering education

**Type of contribution:** Research extended abstract

## 1 Introduction

In recent years, the importance of digital competences has been at the forefront of educational transformation, further accelerated by the experiences with emergency remote teaching (ERT) inflicted by the Covid-19 pandemic (Frolova et al., 2020; Hodges et al., 2020). In these increasingly emergent change pathways, higher education institutions are revisiting educational policy and curricula with a focus on embedding digital competences as learning objectives in the formal curriculum (Sánchez-Caballé et al., 2021; Lyngdorf et al., 2022). At Aalborg University (AAU), this process has been undertaken at all faculties and study boards in 2021 with different levels of stakeholder involvement (e.g. industry and society partners) and subsequent revision of curricula to include digital competences across all disciplines and semesters. However, due to the plentitude of existing frameworks for digital competences and digital literacy, it may be challenging and time consuming to understand and distinguish between concepts and taxonomical relations when revising formal curricula. In higher education research, digital competency is commonly defined by



reference to policy documents (Zhao et al., 2021), such as the DigComp 2.2 framework presented by the European Union. In this framework, digital competence involves key components related to the areas of information and data literacy, communication and collaboration, digital content creation, safety, and problem-solving (Vuorikari et al., 2022). Other frameworks, such as the Danish IT framework for digital literacy (2021), focuses more on taxonomies of digital competence, highlighting three key taxonomical levels of digital competence that citizens should possess in order to be informed and empowered in a digital society, i.e.: *user*, *creator*, and *reflective* digital competences. For the purpose of this study, these two frameworks form the basis of a matrix for making sense of digital competences particularly within formal engineering education curricular as presented by Lyngdorf et al. (2022), which is further coupled with and contextualized in the categories of general academic competences, discipline specific competences, and PBL-specific competences to highlight digital competences particularly relevant to a PBL learning environment. The result is a matrix of nine distinct types of digital competences in engineering education (table 1), which can make the different domains of digital competences accessible for non-experts in digitalization and create a shared language for internal and external stakeholders in curriculum design and development.

Table 1: The digital competence matrix (Lyngdorf et al., 2022)

	General academic	PBL-specific	Discipline/domain specific
User	<i>e.g. literature searches and use of academic databases</i>	<i>e.g. using digital tools to improve the team's time/resource management</i>	<i>e.g. use tools to solve discipline-specific problem</i>
Creator	<i>e.g. writing reports and making presentations</i>	<i>e.g. creating a collaborative hybrid working environment</i>	<i>e.g. designing new digital solutions to discipline-specific problem</i>
Reflective	<i>e.g. reflecting on how to maintain motivation in online/hybrid teaching</i>	<i>e.g. reflecting on how online communication affects group dynamics and conflict management</i>	<i>e.g. reflecting on how digital solutions might bring new, unintended problems</i>

This matrix was applied in the initial process of integrating digital competence in formal curricula across all educations at AAU conducted mainly by study boards and is intended to support the study boards' ongoing and iterative revision of study regulations every five years. While student representatives within these boards took part in this revision, the integration of digital competences in its first iteration was somewhat of a 'top-down' process emphasizing industry and institutional perspectives on engineering digital competences needed for the future. However, in a student-centered learning environment where engineering students spend half their time each semester doing project work, it is reasonable to assume that a substantial part of the development of digital competences happens outside formally organized teaching settings through the students' own creation of and reflection on digital practices in project work and in their future profession. Thus, this extended abstract aims to emphasize student perspectives on digital competences to further inform this ongoing revision of learning outcomes and to bridge the gap between digital literacy as articulated in formal curriculum and engineering students' own experiences of digital practice and competence development, particularly within a systemic PBL environment, through the following research question:

*What are the current engineering student perceptions of digital competence in a systemic PBL environment and how can we support students in understanding, verbalizing, and categorizing digital competence both in relation to their general academic practice, their PBL-specific digital practice, and their future profession?*

## 2 Methodology

The paper reports on data collected from a series of nine three-hour online workshops carried out with first- and second-year engineering students from eight different engineering domains during the spring and fall semesters of 2022. The workshops as a whole were centered around digital practices supporting PBL project work with a segment focusing on digital competences and offered on a volunteer basis mid-semester. During the workshops, we deliberately chose to not present the students with the full matrix presented in table 1 in this initial phase of the study, to avoid the risk of students seeing this as a ‘form’ to fill out and to give space for the students’ own immediate responses, perspectives, and priorities of digital competences. Thus, they were only presented with the Danish IT (2021) framework’s distinction between user, creator and reflective digital competences and subsequently asked to write down their individual reflections anonymously on an online bulletin board (offered through Padlet), which were structured in accordance with this distinction. The first twenty minutes were allocated for this reflective exercise in each workshop, and as the students often attended the workshop in their project group, some chose to align their perspectives in collective ‘group’ responses while others responded individually. The exercise was followed by a plenary discussion, in which the students were given the opportunity to vocally elaborate upon the cards and ask questions. These written and vocal inputs were collected and compose the empirical basis of this extended abstract. All responses were collected anonymously, and the students were informed about the research purpose prior to the activity.

## 3 Results and discussion

A total quantity of 121 responses were registered on the bulletin boards dispersed across the three categories of user, creator, and reflective digital competences. Following from the data collection, the authors deductively clustered the inputs of each category into key aspects according to general academic, PBL, and discipline/domain specific competences according to the columns in the matrix of digital competences in engineering education (Lyngdorf et al., 2022). The following sections will present the results of this process structured in accordance with the user, creator, and reflective digital competences.

### 3.1 Digital user competences

The students entered 51 inputs into the field of digital user competences, out of which 26 relates to general academic, 17 to PBL-specific, and 8 to discipline/domain specific competences. When it comes to general academic competences, the majority of the responses are related to structures for digital information gathering when finding and accessing information, navigating databases and search engines, as well as critically evaluating which “sites and search options can be trusted”. A broad range of different platforms and online tools were mentioned, e.g., Google Scholar, YouTube, etc. without further contextualization or critical reflection on these tools’ role in the development of those digital competences or the competences needed to utilize these tools most effectively. Similarly, within digital competences that relate to the students’ PBL practice, the students entered multiple different online platforms used in their PBL practices, particularly institutionally supported platforms (such as Moodle and the project library, i.e. a database of past student projects which students can access to seek information specifically within an AAU PBL context). Furthermore, several inputs mention the use of tools supporting project management, e.g., Trello or Excel, to “create a common overview of the project”, as well as tools supporting synchronous and asynchronous communication during remote collaboration, e.g., Discord or Microsoft Teams, to “meet and access shared material online”.

In terms of discipline/domain specific competences, several inputs relate to software development, e.g., programming collaboratively with GitHub, programming in Python, and troubleshooting, thus the use of digital tools to design for and solve discipline-specific problems. Other input relates to the use of digital tools to collect empirical data to inform the identification and analysis of discipline-specific problems. The majority of inputs in discipline/domain specific competences are thus connected to problem-oriented aspects related

to the respective disciplines, however, mostly mentioned without further contextualization aside from the digital tools and practices.

### 3.2 Digital creator competences

In the field of digital creator competences, the students entered 38 inputs, out of which 8 relates to general academic, 13 to PBL-specific, and 17 to discipline/domain specific competences. The substance of the inputs related to general academic and PBL-specific competences are not considerably distinguishable from the inputs entered in digital user competences, which could indicate that students tie creator competences to their profession (e.g. as a software developer) rather than the creation of (new) digital practices, e.g. in project work and collaboration. The quantity of input is also notably smaller as well compared to digital user competences, further demonstrating this pattern of students perceiving these competences in relation to the *use* of technology rather than *create* using the technology. Likewise, the majority of inputs related to PBL-specific competences follow the same tendencies as in digital user competences by mainly relating to information seeking structures and project management, particularly in relation to their project work. Although a few notable inputs mention specific tools for communication and resource sharing, the students did not mention any practices related to interpersonal competences, e.g., creating a collaborative hybrid working environment or a team culture. This implies that they do not considerably relate the collaborative practices of project work to something they *create* in the digital space. Thus, the predominant focus on structural aspects in comparison with interpersonal practices suggests a perception of collaboration as something that happens separately from the development of digital creator competences. The majority of inputs registered in digital creator competences relates to discipline/domain specific skills and competences, again with a predominance of input naming specific tools and systems, e.g., image processing or simulation programs. This indicates that the students to a greater extent perceive their digital creator competences as tied to their respective disciplines, rather than their PBL and academic practices.

### 3.3 Reflective digital competences

The students entered 32 inputs into the field of reflective digital competences, out of which 20 relates to general academic, 12 to PBL, and 0 to discipline/domain specific competences. The vast majority of inputs entered into the field of reflective digital competences relates to the students' general academic competences, out of which several specifically mention the European General Data Protection Regulation (GDPR) in the context of handling and protecting other people's data as well as practices for obtaining consent when sharing data with other parties, as stated by one student "Having a basic understanding of how to use other people's data and how to use it ethically correctly". Another student addressed the implications for their practice when writing reports containing confidential information, which should be stored on offline platforms, rather than online non-GDPR compliant platforms. This indicates a general awareness of ethical and legal matters in relation to their academic practices and an ability to act accordingly. Several inputs relate broadly to what could be considered PBL-specific competences, e.g., the creation of a professional group identity when communicating with the university or industry partners, as highlighted by one student. Other inputs similarly address the collaboration with external stakeholders, which has provided "insight into how a product affects the company" as well as experience with developing solutions that meet the needs of the company. This shows that the students to some degree perceive their reflective digital competences in relation to problem-orientation and the PBL-approach. Some inputs also concern interpersonal aspects related to the students' PBL-practices, e.g., the use of virtual logbooks as a point of departure for future discussions and evaluations of the project, as well as the analysis and reflection upon the collaborative process. This competence area was notably absent in the students' accounts of digital user and creator competences, which might indicate that students associate the optimization of digital practices in group work and collaboration as mainly a meta-cognitive process rather than one of action and active creation.

Interestingly, in spite of several references to discipline-specific tools and systems in digital user and creator competences, no inputs were registered in reflective digital competences related to discipline-specific practices. This shows that engineering students might primarily relate their discipline-specific digital competences to the usage and creation of and with technologies and digital tools, and the absence of inputs in discipline-specific reflective digital competences suggests a lack of awareness of possibilities, risks, ethical issues and societal implications of the use and creation of discipline-specific technologies.

#### 4 Conclusions and future work

In this extended abstract we introduced an approach to understand, verbalize, and categorize digital competence within a systemic PBL environment and analyzed engineering students' current perceptions of the digital competences they believe they develop within this learning environment based on data from nine student workshops centered around digital practices supporting PBL project work. The results show an overall predominance of skills, e.g., the mastery of specific tools, rather than competences, indicating that it may be difficult for students to articulate and reflect upon their digital competences in general. The absence of reflection and contextualization of the respective competences is similarly a common tendency across disciplines with no significant difference identified between disciplines. Furthermore, the students did not substantially relate their digital creator competences to aspects outside of their respective disciplines, indicating that engineering students might consider digital collaborative practices in project work as something that 'just happens' rather than something they have an active role in creating. Finally, the analysis indicates a need for highlighted digital reflective competences in relation to specific disciplines and domains, to ensure that engineering students are equipped with the necessary competences to critically reflect on the possibilities, risks, ethical issues, and societal implications of emerging technology they might take part in developing in their future profession.

Future work includes tracking the role of new formal digital learning outcomes in shaping teaching practices and activities as well as exploring way for further integrating both student, stakeholder and future perspectives in curriculum development focusing on transversal and discipline-specific digital competences that go beyond the five-year lifespan of a study regulation through participatory and anticipatory methods.

#### 5 References

Dansk IT (2021). Dansk IT's anbefalinger til styrkelse af danskernes digitale kompetencer. Retrieved from: <https://dit.dk/Nyheder/~media/3CDE0CB99C61401DB77A1516A79E11BB.ashx>

Frolova, E.V., Rogach, O.V., Ryabova, T.M. (2020). Digitalization of education in modern scientific discourse: new trends and risks analysis. *European Journal of Contemporary Education*. 9(2). 313-336. <https://doi.org/10.13187/ejced.2020.2.313>

Hodges, C., Moore, S., Lockee, B., Trust, T., & Bond, A. (2020). The difference between emergency remote teaching and online learning. *Educause review*, 27, 1-12.

Lyngdorf, N. E. R., Bertel, L. B., & Lindsay, E. (2022). A matrix for making sense of digital competences in formal engineering education curricula. In *Towards a new future in engineering education, new scenarios that European alliances of tech universities open up: Proceedings of SEFI 2022: 50th Annual Conference of The European Society for Engineering Education (2041-2046)*.

Sánchez-Caballé, A., Gisbert-Cervera, M., & Esteve-Món, F. (2021). Integrating Digital Competence in Higher Education Curricula: An Institutional Analysis. *Educar*, 57(1), 241–258.

<https://doi.org/10.5565/rev/educar.1174>

Vuorikari, R., Kluzer, s., & Punie, Y. (2022). *DigComp 2.2: The Digital Competence Framework for Citizens—With new examples of knowledge, skills and attitudes*. Publications Office of the European Union, Luxembourg. <https://doi.org/10.2760/115376>

Zhao, Y., Pinto Llorente, A. M., & Sánchez Gómez, M. C. (2021). Digital competence in higher education research: A systematic literature review. *Computers & Education*, 168, 104212.

<https://doi.org/10.1016/j.compedu.2021.104212>

# Work-in-Progress: Real Mathematics in Virtual Worlds

Olga Timcenko

Aalborg University, Denmark, [ot@create.aau.dk](mailto:ot@create.aau.dk)

Lui Albaek Thomsen

Aalborg University, Denmark, [lat@create.aau.dk](mailto:lat@create.aau.dk)

## Summary

Following issues with learning mathematics and, especially, transferring mathematical knowledge to problem-based projects for soft-engineering students, this paper suggests to challenge the students who use technological tools without enough mathematical knowledge, by explicitly exposing mathematical objects in virtual reality. Only a pilot-study is done for now and more work is needed to optimize this approach for classroom or project-room use, but the first indications are that by using students' fascination with contemporary technology and showing that behind favourite game engine that gives life to virtual environments and characters, there is a solid mathematical background, motivation to learn mathematics and implement that knowledge could be improved.

**Keywords:** PBL in courses, mathematics for non-math majors, real-life examples, virtual reality

**Type of contribution:** Best practice extended abstract, work in progress

## 1 Introduction: Issues that motivated this project

Project oriented problem-based learning is educational paradigm at Aalborg University since it was founded in 1974. Group based project work, supervised by teachers typically takes half of all learning activities, 15ECTS each semester, while other half is dedicated to the courses that, in the ideal circumstances, should support the project work. However, over the years it was noted that at certain educations course grades on projects are significantly higher than on individual courses. Semester evaluations, provided by the students after the end of each semester, indicate that the students often fail to see the connection between courses and project work, thus implementing very little and shallow knowledge from the courses into their projects. This was surprizing and warning factum, and among the reasons that Aalborg University initiated a project "PBL Future" back in 2017 (Aalborg University, 2017). That project, among many other research activities and goals, included a pilot-project on integrating all 3 courses of one particular semester (4<sup>th</sup> semester of Media Technology studies at Copenhagen campus) with the semester project. PBL researchers were following semester's teacher's team, attended certain classes, and made several interviews both with semester teachers and the students (Bruun-Pedersen, 2020). Media Technology studies are placed on the Technical Faculty of Informational Technology and Design; thus, they are considered to be technical studies, but with a strong inclination to design, usability and users, making them a kind of "soft engineering studies". "Soft-engineering" students are defined to be those whose main interest is a human use of technology and effects that different technologies can have on people in general, or some specific groups in particular, rather than optimal, correct technological development.

The first author of this paper was among the observed teachers and found discussions with the colleagues who were teaching two other courses extremely beneficial. During the meetings about course experiences on the semester that is quite technical (courses cover sound design, sensors, and statistics), it became apparent that the students in general lack mathematical competences needed for the semester, although they have been thought those topics at high school and at the mathematics course at the first university year. This is, in fact, in alignment with many reports from all over the world, and is also in line with our previously published work (Triantafulyoy & Timcenko, 2014; Triantafyllou et al., 2015)

The first author of this paper also had several disappointing experiences while supervising the semester projects, when students opted to solve significantly simpler problems than originally planned, because of lack of mathematical knowledge. Even worse, they have been explicitly taught the needed knowledge on the course dedicated to Mathematics for Computer Graphics, but the transfer of knowledge did not happen – which is also the problem well documented in the literature.

As there is huge body of research that points to conclusion that non-mathematics major students are significantly more motivated to learn mathematics when they are exposed to real-life problems from their future profession, the authors of this paper posed a question: “What are real-life mathematical problems for Media Technology students?” That is, in fact, a part of the bigger question: Which mathematics Media Technology students need, in order to be successful in their profession?

The fact is that to prototype certain media artefacts, being that a computer game, an educational applet or a film effect, professionals use very elaborate software tools, like game engines (Unity, Unreal...), or 3D modelling software (Maya, Blender...). In all those tools the best effort is made to hide all mathematics, so that users can produce the artefact he wants even without understanding all complex mathematics behind. But another fact is that the deeper understanding of the tool allows for faster work of a higher quality – so some mathematical knowledge helps a lot.

Thus, the authors have decided to explicitly expose the basic mathematical concepts behind a game engine to the students. The idea is to use these visualizations as helping teaching material during the mathematics course.

In the following sections we will present theoretical background, the research question, the material we have developed until now, and plan for the evaluation.

## 2 Theoretical framework and research question

The Aalborg model of project-oriented problem-based learning is a form of active learning, and we are also considering our intervention as an active learning activity. Thus, we have opted to evaluate our intervention from pragmatist perspective, established for more than hundred years ago by John Dewey (Dewey, 2010).

The pragmatist approach considers the practical actions in the world and applies research into social practice, including teaching. Pragmatic models of inquiry-based learning and reflection have been adapted by various followers for different fields, due to the pragmatic view of learning as a lifelong process that includes school, art, literature, mass media, work life, and citizenship (Frølund, 2009). Reviews of Dewey’s framework of the reflective process have been simplified into three phases, that often appear roughly as follows:

1. Defining a problematic situation that has practical dimensions.
2. Isolating a particular problem and ways to address the problem as an inquiry.
3. Reflecting on how the problem was addressed and pursuing the problem in the abstract.

The second model of reflection, by American educator Donald Schön, is based on how architects and other arts professionals go through process of reflection in action and on action (Schön, 1987). In action refers to the understanding that occurs while in the concrete process (such an experience of hands-on design), and

on-action refers to idea of reflection as looking back on an experience. We find this model particularly well-suited for Media Technology students, as they typically construct virtual artefact in the similar manners as artists and architects, and often neglect on-experience reflection.

The research question, that we plan to investigate in the cited framework, is:

How can exposing students to tangible representations of abstract mathematical concepts support students' motivation in gaining and retaining knowledge?

### 3 Learning material in Virtual Reality

Real-life examples are great tool in making mathematics relevant. However, what is "real life" is different for different categories of students. For lots of nowadays young people, Media Technology students included, computer games are everyday experience, and virtual environments are something that gains their attention, so showing mathematics behind those environments, while in the environment, might boost students' interest and enhance understanding of mathematical concepts. Visualization of mathematical objects and formulas in Virtual Reality is not a novel idea; one excellent implementation is presented in (Hsu, 2020), that illustrates solving systems of linear equations, but the difference of our approach is that we incorporate those objects into a familiar Virtual Reality environment, highlighting their roles in constructing and modifying such an environment.

The idea is to start with the basic concepts from Linear Algebra – unit vectors, dot product and cross product, and explicitly visualize them in a Virtual Reality game-like environment. The goal is to explicitly illustrate the concepts students have difficulties to understand when presented just by definitions: that the dot product is crucially connected with angular distance between vectors and can determine directions and visibility, and that the cross product is not commutative operation, determining how certain parts of objects will appear to the observer. On the Figure 1, Figure 2 and Figure 3. Some characteristic screenshots of our application are presented. 2D screenshots do not do a justice to the virtual 3D environment, but they give a rough idea of our intention. The student should find herself in an environment similar to those from games – there is a landscape, a balloon that floats only if control vectors are normalized, a sculpture where some facets look wrong, because surface normal are inverted, and a field of solar panels, that should follow the motion of the Sun, in order to maximize the quantity of electricity produced. The difference of an ordinary environment is that the relevant vectors also are the part of the environment, and that the student could gram them, using game controller, as any other object in the environment, and manipulate their positions and magnitudes. In order to work with formulas while in the virtual environment, we have developed a formula-editor, also visible on the Figures 2 and 3.



Figure 1. Demonstrating effect of unit and non-unit vectors



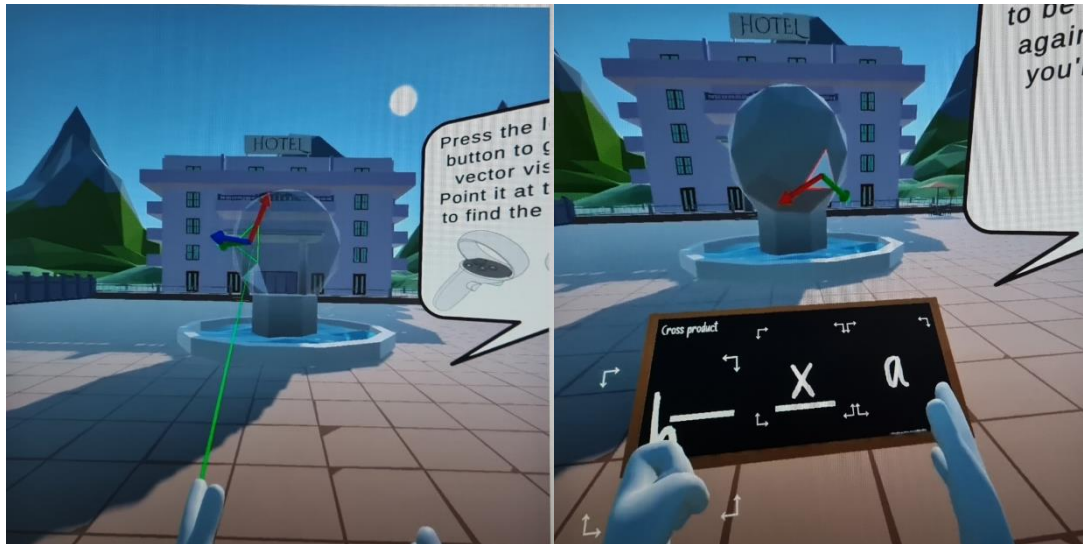

Figure 2. Demonstrating effect of cross-product of vectors (left), and a tool to fix the formulas (right)

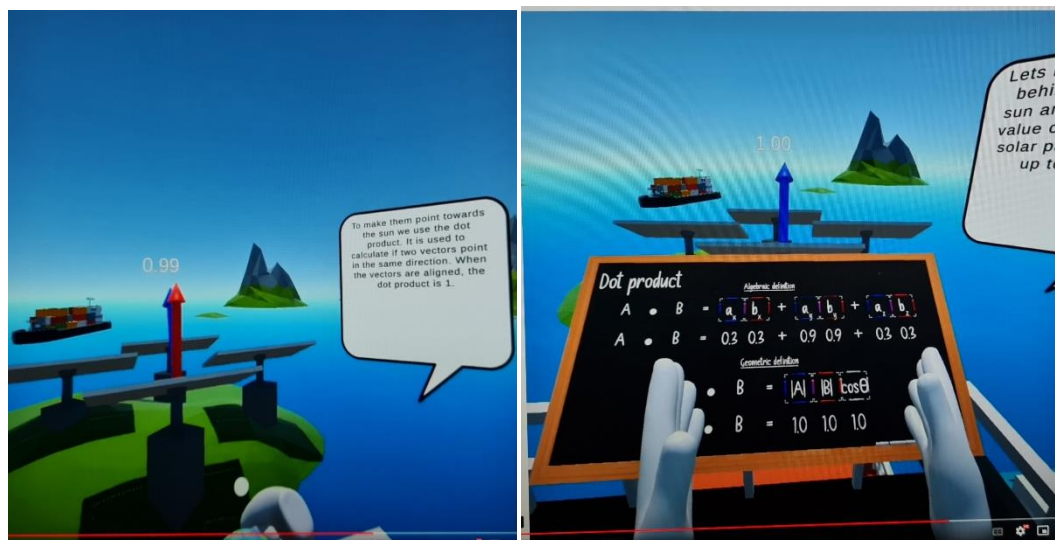

Figure 3. Effect of dot product and a tool to adjust the formula

We have performed usability-testing of the developed material on several students and faculty members during Erasmus+ Item project meeting (Hellenic Mediterranean University, 2022), and got confirmation that interest in technology could keep students interest in learning mathematical part. However, significantly more carefully planned tests are needed before we could conclude whether this approach produces wanted results, or keeps students attention only as long as interest for VR technology exists.

## 4 Future testing plan

As mentioned in Section 2, we are using pragmatist framework with reflection, and we would like to check whether the students retain knowledge and can use it creatively in future projects.

Thus, the testing plan we envision consists of several steps over time:

1. Observations how the developed material is used by mathematics teacher during the 3<sup>rd</sup> semester mathematics course.
2. Questionnaires distributed among the students exposed to the intervention (20-30 students)
3. Group interviews of the same students when they reach 5<sup>th</sup> semester and would need to use some mathematics in their semester project.

We need this two-step testing approach, with a minimum one year of elapsed time, as we would like to see if there is any persisting effect on motivation and knowledge.

## 5 Conclusion

In this paper we have presented a VR environment we have developed in order to make mathematics visible and tangible for the students. The work is still in the preliminary phase, as we have included only the most basic vector operations. However, with the toolbox developed, not much work is required to add more content, like minimal distances, object intersections or projections. That is the easier part of future development. What is much more challenging is to develop protocols for proper usage of those VR environments in math courses, and to test their immediate and prolonged effect on students' motivation, knowledge retention and reflection skills. Thus we hope to get interest of more researchers and to formulate a larger project around this idea.

## 6 References

- Aalborg University. (2017). *PBL Future*. Retrieved from <https://www.pblfuture.aau.dk/>
- Bruun-Pedersen, J. R. (2020). Flipping All Courses on a Semester: Students' Reactions and Recommendations. *SEFI Annual Conference Engaging Engineering Education* (pp. 124-131). online: European Association for Engineering Education.
- Dewey, J. (2010). *How we Think*. Dewey Press.
- Frølund, L. (2009). *Animated Symbols, Ph.D thesis*. Aarhus: Danish School of Education, Aarhus University.
- Hellenic Mediteranian University. (2022). *Innovative Teaching Education in Mathematics*. Retrieved from <https://item.hmu.gr>
- Hsu, Y. C. (2020). Exploring the learning motivation and effectiveness of applying virtual reality to high school mathematics. *Universal Journal of Educational Research*, 8(2), 438-444.
- Schön, D. A. (1987). *Educating the Refleksive Practitioner: Toward a new design for the teaching and learning in the professions*. Josey-Bass.
- Triantafulyo, E., & Timcenko, O. (2014). Introducing a flipped classroom for the statistics course: A case study. *EAEIE* (pp. 5-8). European Association for Electric Engineer Education.
- Triantafyllou, E., Timcenko, O., & Kofoed, L. B. (2015). Student behaviour and perceptions in a flipped classroom: A case in undergraduate mathematics. *SEFI*. European association for Engineering Education.

# Title of the Extended Abstract Immersive and Collaborative Environment for Remote Participants in Cyber-Physical mode using Telepresence Robot Enabled with 360° View Camera

Shubhakar Kalya, Chee H. Lee, Teo T. Hui, Jacob S. Chen, Lee M.J. Melvin, Ong J. Hua, Goh K. Chee, Mohan R. Elara, Kwan W. Lek, Oka Kurniawan

Singapore University of Technology and design (SUTD)  
8 Somapah Road, Singapore-487372

Corresponding author: [shubhakar@sutd.edu.sg](mailto:shubhakar@sutd.edu.sg)

## Summary

Cyber-physical mode of teaching combines face-to-face physical class and remote students attending the same class virtually through online platform in a cohesive learning environment. 360° view camera and Telepresence robot are the most widely explored tools for immersive and collaborative cyber-physical classes/sessions involving online teaching and learning, and group activity. In this work, we report a study and findings of conducting different hybrid class sessions involving regular physical class and remote students attending the same class virtually through online platform such as Zoom connected with 360° view camera for teaching, group discussion/brainstorming and project demonstration. Similarly, teaching, group discussion/brainstorming and hands-on activity was conducted in a cyber-physical mode through a telepresence robot. Some of the key issues/concerns faced during these sessions are addressed by using customized telepresence robot enabled with 360° view camera system. These different sessions focused on studying the impact of involvement of 360° view camera, telepresence robot and customized telepresence robot enabled with 360° View camera system on online teaching and learning, group activity and hands-on activities. By using the survey data, we studied how technology can be used for enhanced teaching and learning in a cyber-physical mode and areas for further improvement to create an immersive and collaborative teaching and learning environment

**Keywords:** Online learning, Cyber-physical, Remote learning, 360° view camera, Telepresence robot

**Type of contribution:** Research extended abstracts;

## 1 Introduction

Online learning is a fast-growing component in the field of education and plays a major role in the advancement of changing teaching and learning system [1-3]. In addition, COVID-19 pandemic has speeded up the use of technology tools for effective online teaching and learning [4,5]. Recently, cyber-physical teaching and learning has attracted a lot of attention and create an effective environment for inclusive and collaborative learning [5-7]. The cyber-physical mode of teaching using 360° view camera and Telepresence robot offers more advantages over conventional online courses by providing better intimacy for the remote students with physical class and better engagement in learning activities [8,9]. Participating in the physical class through the telepresence robot offers unique sense of presence and immersion for the remote students by making them feel like as if the user sitting inside the physical class. Advanced 360° view camera

telepresence robot aims at improving the wide field of view with better and effective navigation, and supports virtual reality (VR) interface enabling participation in an immersive virtual environment [10,11]. Adaptation of cyber-physical learning environment will re-shape the education system.

## 2 Plan and execution of different hybrid class sessions

A lot of planning is required to ensure that the different cyber-physical sessions work well and for the success of proposed methodology. These sessions involved 15-20 student participants. Fig. 1(a) illustrates the overall cyber-physical class environment highlighting online tools enabled physical class and remote students accessing the physical class activities through online platform. Different sessions and its analysis with overall study framework is shown in Fig. 1(b). A survey involving student participants was conducted on teaching and learning experience after completing the different sessions. This survey focused on mainly on students' experience on teaching and learning with class intimacy and engagement level in different cyber-physical sessions using (i) Zoom connected with 360° view camera and (ii) telepresence robot. Identities of the participants of this work is not shown to due to the privacy and confidentiality agreement. Initial study on telepresence robot embedded with 360° view camera based cyber-physical classes was conducted and the key findings are reported here

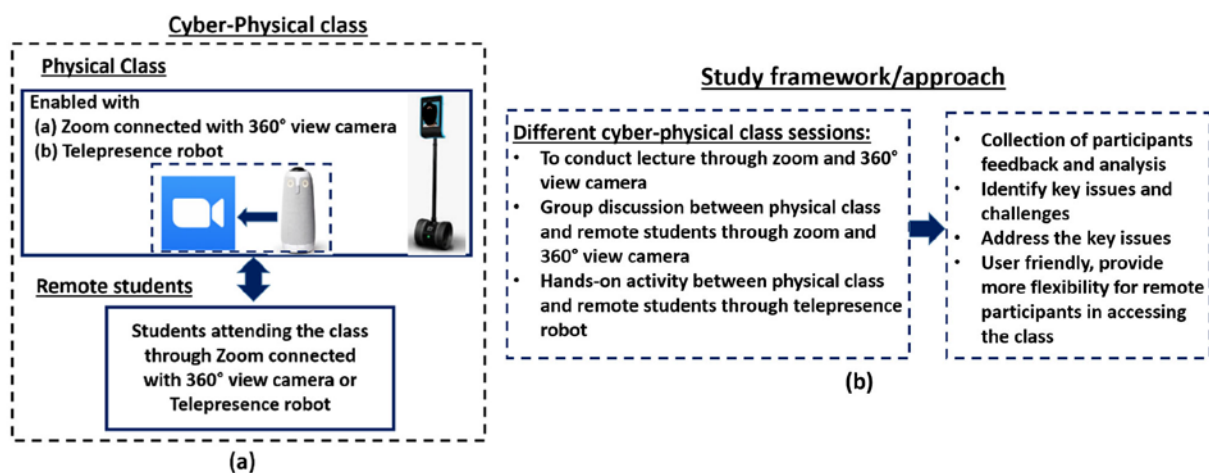

Fig. 1. (a) Cyber-physical class environment showing physical class enabled with online supporting tools and its access to remote students and (b) overall study framework/approach.

## 3 Demonstration details and discussion

Case study (I): In this cyber-physical class session, an Owl 360° view camera placed in the physical class room is connected to the Zoom online class platform. Remote students access the physical class through Zoom and get the view of the class from 360° view camera. Fig. 2 (a) shows the physical class room set-up with Zoom connected with 360° view camera. Fig. 2 (b) shows a remote student's view of the physical class and teaching content.

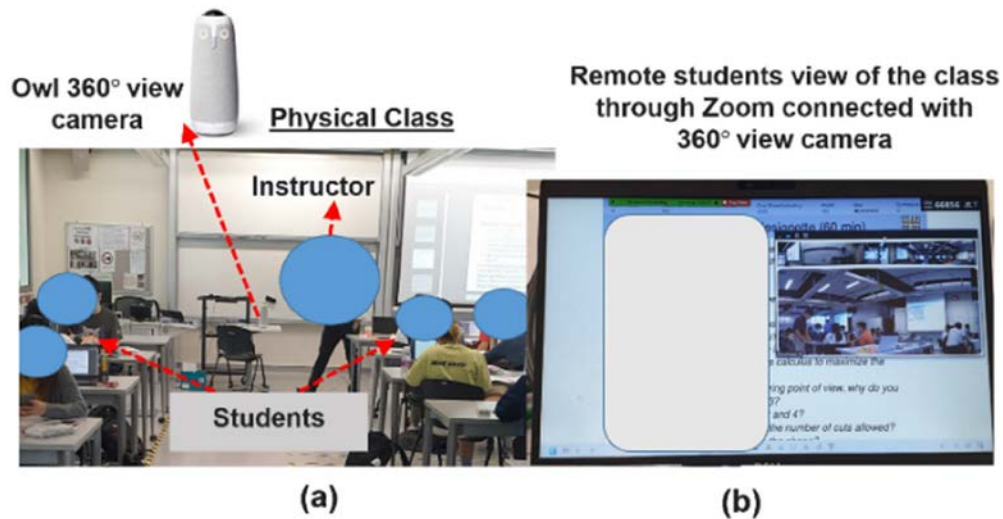

Fig. 2. (a) Physical class room view in cyber-physical class environment with Zoom connected with 360° view camera. (b) Remote student's view of the class.

Remote students screen contains different panels showing class view, teaching slide panel and instructor's area. Students can get the overall view of the physical class from 360° view camera.

In second session, a group activity involving discussion/brainstorming was conducted between students present in the class and remote students using Zoom connected with 360° view camera. Fig. 3 shows group activity (discussion/brainstorming) between physical class students and remote groupmates through Zoom connected with 360° view camera. Fig. 3. (a) shows A team from the physical class was involved in a group activity with remote students through Zoom connected with 360° view camera as highlighted in Fig. 3(a). Fig. 3(b) shows remote student's view of the physical class and their interaction with groupmates present in the physical class.

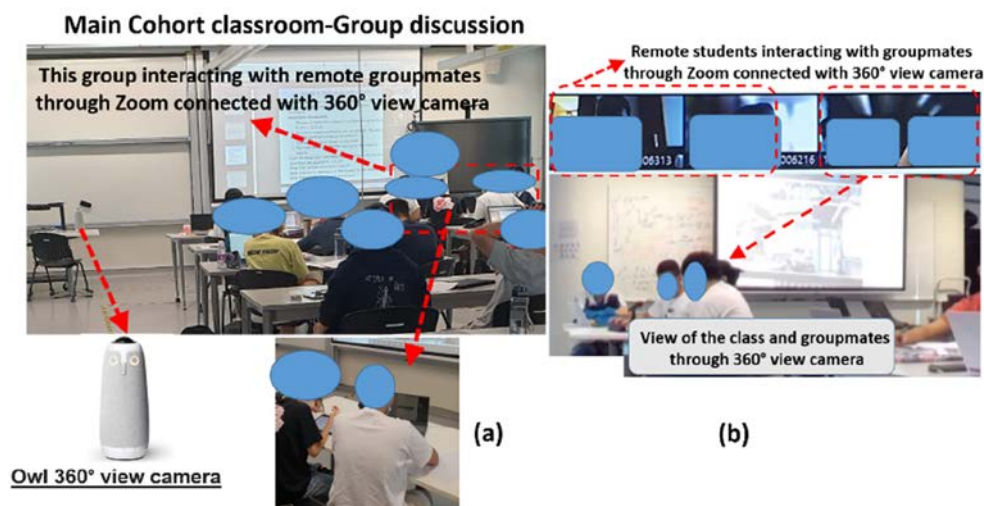

Fig. 3. (a) A group of students involved in group discussion in the physical class room and interacting with remote groupmates through Zoom connected with 360° view camera. (b) Remote student's screen showing the physical class providing the view of groupmates in class [12].

In another session, the experimental work related to course project was demonstrated and remote students viewed the live demonstration in cyber-physical class mode using Zoom connected with 360° view camera. Fig. 4 shows the screenshots of the live demonstration video captured by the remote students. Figs. 4(a)-(c) show the screenshots at different time ( $t_1$ ,  $t_2$ ,  $t_3$ ) of the group activity. Attending these sessions remotely provided better view of the live demonstration for remote students and these students felt better engaged in the group activity. This session also helped to enhance group intimacy and information on classmates' behaviour during the activity.

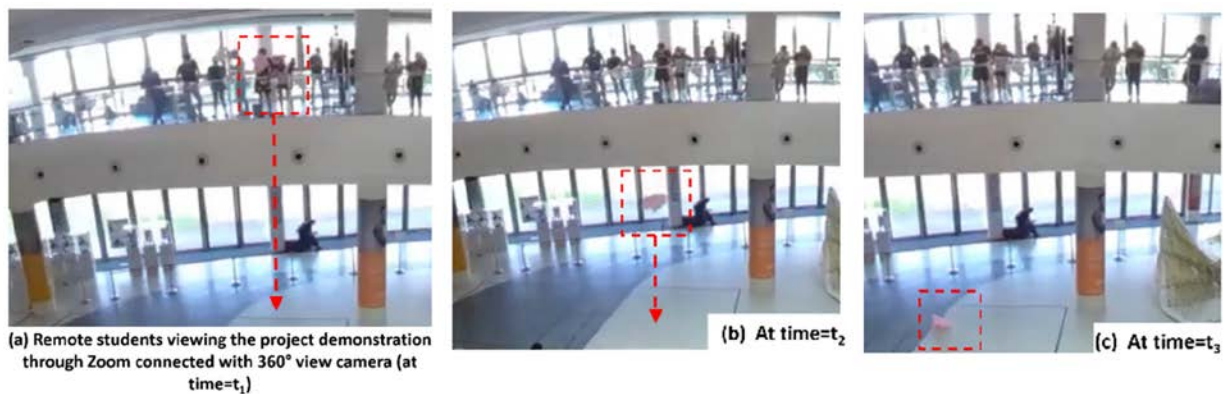

Fig. 4. Screenshots of the video captured by the remote participant at different times; (a) at time  $t_1$ , (b) at time  $t_2$ , and (c) at time  $t_3$ , during the live demonstration of the project to the remote groupmates.

The main advantages of this type of cyber-physical class sessions are;

- Remote students can experience a unique sense of presence and immersion by getting the view of the teacher and students in the physical classroom.
- Teaching and learning session is inclusive and better engaged.

However, the key challenges associated with this hybrid class session are;

- Audio signal needs to be improved.
- More flexibility required for the remote students to navigate and control the different panels on the screen.
- Remote students require better channel for interacting with teacher/teaching assistants.

Fig. 5(a) shows the group project conducted during summer with partner university and this session was conducted physically at the partner university. Another group of students were involved in summer project with partner university students in a cyber-physical mode (using 360° view camera) as shown in Fig. 5(b). Fig. 6 shows the students' survey results on different parameters associated with learning and collaboration under physical and cyber-physical (virtual) mode. Results clearly highlight that 360° view camera is not suited for hands-on activity sessions.

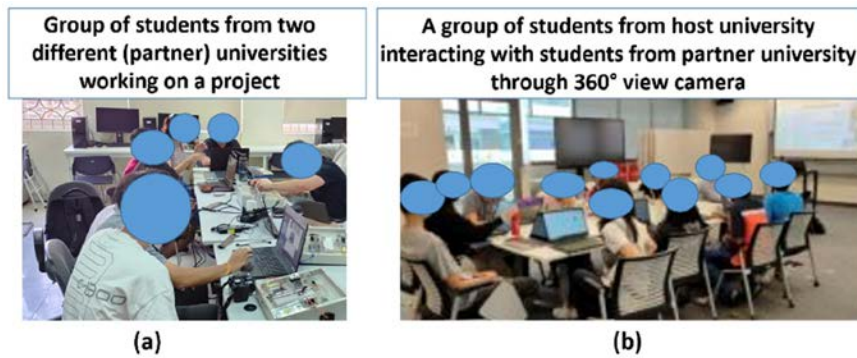

Fig. 5. (a) Physical summer collaborative project work at the partner university. (b) Cyber-physical project session using Zoom connected with 360° view camera with partner university students.

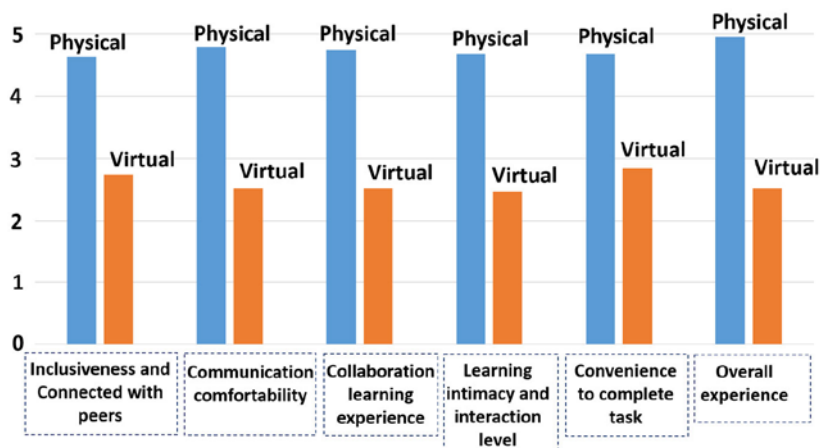

Fig. 6. students' survey results on different parameters associated with learning and collaboration under physical and cyber-physical (virtual) mode.

Case Study (II)- Telepresence robot based cyber-physical sessions

In the first session under this case study, the remote students attended the lecture through telepresence robot. Fig. 7(a) shows the physical class in the cyber-physical class environment involving students, teacher and telepresence robot which is used for the participation of remote students. The remote student's view of the physical class through telepresence robot is shown in Fig. 7(b). Figs. 7(c) and (d) shows the group discussion activity in cyber-physical mode

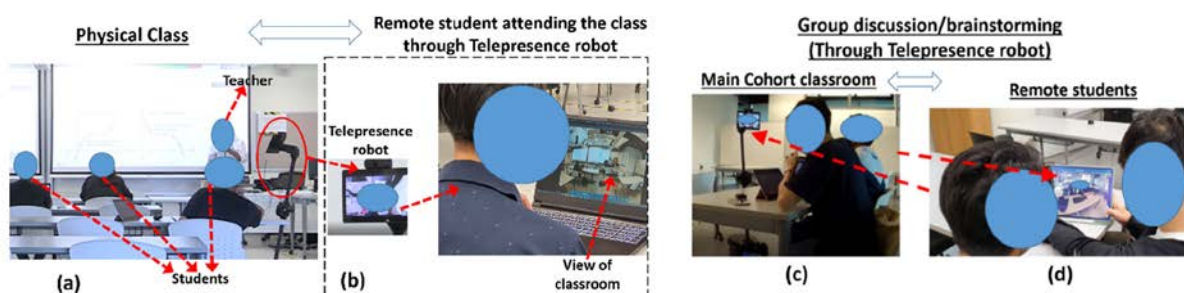

Fig. 7. Cyber-Physical mode (a) physical class with Telepresence robot for the participation of the remote student. (b) Remote student accessing the class using Telepresence robot. (c) and (d) Group discussion in cyber-physical mode [12].

The hands-on activity was performed in another session and conducted in the class/lab by a group (2-3) of students and the remote students joined this group through the telepresence robot as shown in Fig. 8(a). The role of the remote student is to observe the hands-on activity performed in the physical class/lab closely and interact with group members. The remote participants can also take the role of a lead/guide to perform the hands-on task by providing relevant guidance or instructions. Fig. 8(b) shows students' survey results on different parameters associated with learning and collaboration under cyber-physical mode using the telepresence robot.

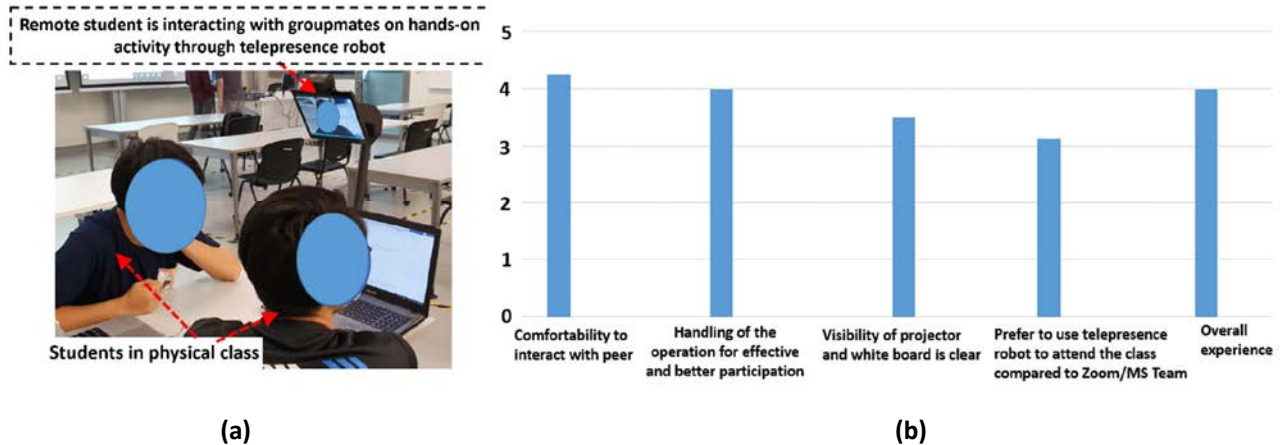

Fig. 8. (a) Hands-on activity between physical class students and remote groupmates through telepresence robot. (b) Students' survey results on different parameters associated with learning and collaboration under cyber-physical mode using telepresence robot.

The key findings of the telepresence robot based cyber-physical classes are highlighted below;

- Gets the feeling of being physically present in the class and able to see the teacher and students present in the physical class.
- Remote student can control and navigate the view left, right, up and down to get the unrestricted view of the class.
- Provides the view of the projector and whiteboard in the class.

However, there are some important issues/challenges associated with telepresence robot as highlighted below;

- Audio quality and signal lag need to be improved.
- Telepresence robot users require adequate training for its operation. Needs more flexibility in the navigation.
- Movement of telepresence robot could distract the students and teacher in the physical class.
- Interaction comfortability with teachers and peers need to be improved.

#### Case study (III)- Telepresence robot enabled with 360° view camera (In progress)

Some of the key concerns and issues encountered in case I and case II are addressed by adopting cyber-physical class environment using telepresence robot embedded with 360° view camera combined with online supporting tools and its access to remote students in web view or VR access as highlighted in Fig. 9. This telepresence robot enabled with 360° view camera is suitable for both attending class sessions, group activities in an immersive and collaborative manner. Additional features such as laser pointer, reaction indicator and dedicated audio system are assembled in this system. In addition, this type of cyber-physical



sessions can further be extended to short courses, seminars, conferences for external participants who are not able to attend these events physically.

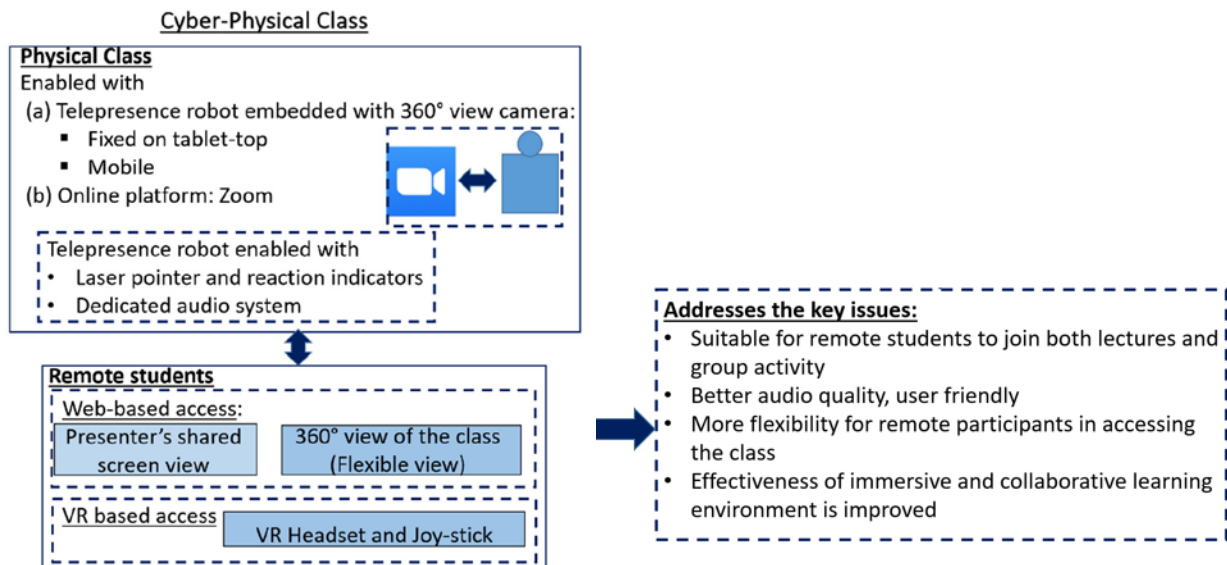

Fig. 9. Cyber-physical class environment showing physical class enabled with 360° view camera embedded telepresence robot with online supporting tools and its access to remote students in web view or VR access.

The remote users require adequate training on the operation of telepresence robot and go through well-developed safety plan to avoid unexpected situations and incidents. Virtual reality with the support of enabling technologies will become a part of learning system in the field of engineering and science. Virtual reality also plays an important role in the remote learning environment in cyber-physical classes [13]. In pilot study, the users experienced more immersive and interactive learning experience in the cyber-physical class using telepresence robot embedded with 360° view camera along with online supporting tools and its access to remote students in web view or VR access. Next generation networking capabilities (5G and beyond) can support the key requirements such as low latency and high bandwidth to achieve high performance from telepresence robots. Setting up of a high quality cyber-physical class also depends on the technology that is in place. So, high resolution camera is required to stream good quality video from physical classroom and high quality microphone/speaker to experience good quality audio signal.

## Acknowledgment

This work is supported by Immersive and Integrative Cyber-Physical Learning Environment project SUTD-campusX programme. Authors would also like to thank Prof. Pey Kin Leong (Associate Provost, Digital Learning, SUTD) for the overall guidance and Dr. Nachamma S, SUTD for the technical discussion.

## 4 References

- [1] E. C. Boling, E. Holan, B. Horbatt, M. Hough, J. Jean-Louis, C. Khurana, and C. Spiezio, "Using online tools for communication and collaboration: Understanding educators' experiences in an online course", *The Internet and Higher Education*, 23, pp. 48–55, 2014.

- [2] M. Akcaoglu, and E. Lee, "Increasing social presence in online learning through small group discussions", *International Review of Research in Open and Distance Learning*, 17(3), 2016.
- [3] F. Martin, T. Sun, C. D. Westine, "A systematic review of research on online teaching and learning from 2009 to 2018", *Computers & Education*, 159 (2020) 104009.
- [4] L. Mishraa, T. Gupta, A. Shree, "Online teaching-learning in higher education during lockdown period of COVID-19 pandemic", *International Journal of Educational Research Open* 1 (2020) 100012.
- [5] R. Gopal, V. Singh, A. Aggarwal, "Impact of online classes on the satisfaction and performance of students during the pandemic period of COVID 19", *Education and Information Technologies*, 26, pp. 6923–6947, 2021.
- [6] A. Meydanlioglu, F. Arikan, "Effect of Hybrid Learning in Higher Education", *World Academy of Science, Engineering and Technology International Journal of Information and Communication Engineering* Vol.8, (5) 2014.
- [7] J. H. Westover and J. P. Westover, "Teaching Hybrid Courses across Disciplines: Effectively Combining Traditional Learning and e-Learning Pedagogies", *Int. Journal of Information and Education Technology*, Vol. 4, No. 1, 2014.
- [8] J. Reyna, "The Potential of 360-Degree Videos For Teaching, Learning and Research", In *Proceedings of 12<sup>th</sup> International Technology, Education and Development Conference*, pp. 1448-1454, (2018).
- [9] G. Lampropoulos, V. Barkoukis, K. Burden and T. Anastasiadis, "360-degree video in education: An overview and a comparative social media data analysis of the last decade", *Smart Learning Environments*, Vol. 8, 20 (2021).
- [10] V. K. L. Ha, R. Chai and H. T. Nguyen, "A Telepresence Wheelchair with 360-Degree Vision Using WebRTC", *Applied Sciences* **2020**, 10, 369.
- [11] K Chandan, X Zhang, J Albertson, X Zhang, Y Liu and S Zhang, "Guided 360-Degree Visual Perception for Mobile Telepresence Robots", *The RSS-2020 Workshop on Closing the Academia to Real-World Gap in Service* (2020).
- [12] K. Shubhakar, C.H. Lee, and T.T. Hui, "Enhanced Learning Experience for Remote Students in Hybrid Class Model using 360° View Camera and Telepresence Robot", *IEEE-International Conference on Teaching, Assessment, and Learning for Engineering (TALE) 2022* (In press).
- [13] D. Mourtzis, E. Vlachou, G. Dimitrakopoulos and V. Zogopoulos, "Cyber-Physical Systems and Education 4.0-The Teaching Factory 4.0 Concept", *8<sup>th</sup> Conference on Learning Factories 2018*, *Procedia Manufacturing*, 23 (2018) 129-134.



# Education for Sustainability

# Who am I and why am I here? - Academic staff viewpoints on CBL and towards a sustainability mindset

Aida Guerra

Aalborg University, Denmark, [aq@plan.aau.dk](mailto:aq@plan.aau.dk)

Gesa Ruge

Central Queensland University, Australia, [g.ruge@cqu.edu.au](mailto:g.ruge@cqu.edu.au)

Jovana Jezdimirovic Ranito

University of Twente, Netherlands, [j.jezdimirovicranito@utwente.nl](mailto:j.jezdimirovicranito@utwente.nl)

## Summary

The integration of CBL in engineering education is gaining popularity and it has been claimed as one of the most suitable strategies for 21<sup>st</sup> century skills development and sustainability mindset. The literature indicates potentials of CBL for a quality of education centred in ecological paradigm and development of a sustainability mindset. Nevertheless, empirical studies exploring CBL potential for sustainability mindset involving academic staff are scarce, if not inexistent. This extended abstract explores academic staff beliefs and viewpoints on their role as a teacher in a CBL environment and in which ways they can be related with a sustainability mindset.

**Keywords:** Challenge-based learning, sustainability mindset, transformative learning, academic staff, engineering education.

**Type of contribution:** Research extended abstract

## 1 Introduction

Problem-oriented, student-centred, and collaborative learning pedagogies, such as Challenge-Based Learning (CBL), are gaining popularity in engineering higher education. The integration and curriculum change for CBL is argued in twofold: first, it develops the competences and skills for the 21<sup>st</sup> century and for employability; second, it enables the education for sustainable development by having challenges as point of departure for learning (Sukackè et al., 2022; van den Beemt et al., 2022). Said that, CBL comprises characteristics that distinguish it from other problem-oriented, student-centred, and collaborative learning pedagogies. For example, the point of departure for learning is a social relevant challenge and not a problem, which is addressed in collaboration with stakeholders and partners from outside academia, leading to solutions with social and environmental positive impacts (Sukackè et al., 2022). Students and teachers assume new roles and are referred broadly as (co)learners. Teachers are facilitators for learning of interdisciplinary teams of students, who work transdisciplinary (Gulikers & Oonk, 2019; Sukackè et al., 2022; van den Beemt et al., 2022). CBL provides the opportunity for students and teachers to become aware of developing an outlook and capacity to create new knowledge and pathways towards more sustainable long-term outcomes, leading to a reconsideration roles and responsibilities of higher education learning and teaching. Therefore, CBL enables to re-conceptualise and construct a new quality of education, rooted in social-environmental quality, replacing the current educational models that continues contributing to the unsustainable planetary depletion (Galotti, 2008). In sum, CBL provides the opportunities for a 'revolution' of higher education for

sustainability, with a holistic and transformative learning approach and development of sustainability mindset. The concept of a sustainable mindset is based on values, knowledge, and attributes and is linked to the UN movement to support the UN SDGs and sustainable development outcomes (Hermes & Rimanoczy, 2018; Kassel et al., 2016). A sustainable mindset involves deep learning and intensive change. Rimanoczy convened the UN-backed Principles of Responsible Management Education (PRME) working group on the sustainability mindset (PRME, 2022). The PMRE framework has been adopted across various disciplines and educational practices (Avelar et al., 2021; Ruge, 2020). A sustainability mindset is a philosophy and way of being (i.e., behaving or acting) that results from a broad understanding of the ecosystem and introspection of the impacts. This mindset is a lens for analyzing and interpreting information for decision-making. Development of sustainability mindset calls for a transformative learning process, involving one mind (*know-what*), hands (*know-how*), heart and spirit (*know-why and know-how to be*) (Kassel et al., 2016). Additionally, sustainability mindset as a way of thinking and being takes a system thinking perspective, with individual in connection with systems he/ she is part of and act upon. Inspired by the promise of CBL for sustainable education and development of sustainability mindset through transformative learning, this paper explores academic staff viewpoints on their professional roles in a CBL environment in which ways they relate with a sustainability mindset.

## 2 Methodology

The study takes a qualitative approach, it is part of two workshops for staff professional development and it is conducted at the University of Twente (Netherlands).

### 2.1 Context of study

University of Twente is a technological University, located in the Enschede, Netherlands. Beside belonging to a small group of Technical Universities (4TU) in Netherlands, it has been elected by Keuzegids Universiteiten as the best of them. University of Twente has a history of innovative teaching approaches and has institutionally embraced Challenge Based Learning (CBL) from 2020. In 2013, University College Twente was established as a hub for innovative teaching within University of Twente. The same year started a unique Honours Bachelor programme in science joining Technology, Liberal Arts and Sciences, named ATLAS. The aim of the program is to educate a new type of engineer, able to consider and find responsible and creative solutions for the complex globalized problems our societies face. The program uses interdisciplinary approach both through domain courses (Natural Sciences, Mathematics and Social Sciences) aligned with semester projects, to teach students to consider multiple perspectives and work with other fields. Within the College, the program was envisioned as a playground to formulate and test new teaching techniques. This unique teaching style heavily relies on the ability of students to self-evaluate their learning progress and set their own learning goals. This exposes the students to different ways of teaching besides the more traditional teaching methods. Being embedded in a small-scale residential college, the program works as a tight knit community of learners, where both staff and students are learning together. More information about the ATLAS programme is available at: <https://www.utwente.nl/en/education/bachelor/programmes/university-college-twente/>.

In the ATLAS programme students are learning through a semester project how to work on sustainable and responsible solutions for complex real-life problems. The projects are supported by domain courses, which feed into the topic of the project and semester. For instance, during semester 2 (first year) students are focusing on sustainable systems: project focuses on making scenarios and plans for embedding innovative transportation technologies (i.e., hyperloop and electric autonomous pods) into mainstream transportation system in period of 30 years. Other domain courses extend knowledge in social science, natural science and mathematics which also apply sustainable system or transition and provide background theories to support the ATLAS project learning process. Students are also provided with opportunity to collaborate in

transdisciplinary environment to test the sustainable options they are developing not only in various academic disciplines but also with outside stakeholders from industry, government, and society.

## 2.2 Data collection and analysis

The study uses two main methods for data collection (narrative inquiry and observations) and has been conducted across two concurrent workshops as part of the staff development of the ATLAS programme. The workshops address different topics: workshop 1 focus is on problem-oriented, collaborative, and participant-directed learning environments, where PBL and CBL are used as examples. Workshop 2 focus is on role of the teacher and facilitation skills. The workshops are organised in small-lectures, group work and discussions with aim for participants to not only develop knowledge and skills but also to reflect, for example, on their conceptualisation of CBL, their teaching practice, and role.

The narrative inquiry instrument is based on Savin-Baden & van Niekerk (2007) and Du et al. (2020), and comprise the following parts: i) “tell us” about yourself (demographic information), ii) “tell us” about your feelings and experiences as teacher, iii) “tell us” about your students, and iv) “tell us” about your career development and prospects. Each part includes prompting questions to support participants in their reflections. An observation schedule was constructed, where three researcher assistants took notes during participant group work and discussions. The observational notes focus mainly on which ways participants express their viewpoints regarding the different topics addressed in the workshop and guided by questions.

In terms of participants, the study targeted 8 to 10 academic staff, with different disciplinary backgrounds, who teach in the ATLAS programme. However, the data was collected from three participants, where two are male aged above 50, and a female 41 years old. Both male participants have a background in mathematics and developmental and educational psychology. The female participant has a background in international relations. All three participants are teachers and supervisors in the ATLAS programme. Ethical approval was obtained before data collection took place, and all the data collected was with the consent of the participants. The data is anonymised and analysed through content analysis.

## 3 Results

The results are clustered around three thematic viewpoints, which are: 1) personal viewpoints, exemplified by perspectives and beliefs in relation to their role as teacher; 2) relational viewpoints, exemplified with their perspectives and views about relations established with peers, students, and stakeholders; 3) institution educational viewpoints, exemplified by their perspectives and views on institution and educational CBL model.

### 3.1 Personal viewpoints

Impactful, meaningful, and interactional are main motivational factors and characteristics of good teaching and learning. The three participants perceived their role as a teacher as something that should contribute positively to students’ development, learning and growth, while also envisioning the broader societal impact. For example, P1 refers to teaching as a “calling, not just a job”, where she/ he “enjoyed stimulating people to learn new things and supporting them in learning process”. P2 points out that “spent most of my working life in industry” [...] before joining academia and belief has “something to share with young people”. P3 mention that it is through teaching that she/ he contributes to the society in general, and she/ he enjoys “creating positive learning experiences”. Furthermore, the observations notes show the participants agreement on what characterises a teacher in a CBL environment, which someone that informs about learning outcomes, communicates, and facilitates learning by questioning rather than provide answers; is a good observer and does not take over the learning process; fosters reflection and self-directed learning through (self)evaluation. P1 recognises that when she/ he started teaching her/his views of teacher was of “someone who transmitted content”; however, with time her/ his view change towards a more collaborative

process and co-construction of knowledge. P3 perceives her/ his “support as basically giving reassurance and stimulating empowerment”.

### 3.2 Relational viewpoints

All participants agree that interaction and connection with students is one of the most enjoyable things of being a university teacher. CBL is the environment that promotes such close interaction and connection, with positive and meaningful impacts on student learning but also teacher sense of accomplishment. This is also very aligned with participants personal viewpoints and their role as educators in a CBL environment. P1 refers to “sharing learning process”, where teacher also learns and the ability to collaborate, co-learn and co-create with students is as much as important as the content taught. However, the process is not absent of challenges, namely on keep “meaningful discussions in large groups of students” (P1), being aware that “you cannot force the development process of others, and that my contribution is limited” (P2), or “personal struggle in balancing work and leisure time/ extracurricular activity and coping with personal and academic setbacks” (P3). Additionally, given the nature of the ATLAS, teacher-student interaction and collaboration comes in different ‘forms and sizes’, i.e., different type of activities (class and project) and group sizes (large and small groups). Besides students, participants also interact and manage external partners and stakeholders.

### 3.3 Institution educational viewpoints

Participants viewpoints unfold in two levels: 1) the CBL model in general; and 2) the institutional frameworks they work with. The observational notes allow to infer participants viewpoints on the CBL. For example, what is? How is it practice? There is a consensus that CBL is problem oriented, where students work with real and authentic problems. CBL is also collaborative, and it goes beyond student-student and team-facilitator relation. There is constant and continuous collaboration with external stakeholders, where everyone learns. Participants also conceptualise and demark CBL from Problem-Based Learning (PBL). For example, the framework of CBL is ‘fuzzier’ and with more uncertainty and complexity. CBL is also transdisciplinary since stakeholders’ involvement and integration of non-academic knowledge is part of practice and student learning. CBL also goes beyond academic development, there is also personal development namely students’ high engagement, attitudes, and self-confidence. Even though participants recognise and reflect on CBL potential for skill development, they also face institutional challenges. In their narratives, participants refer to assessment as a challenge, which they would like to change because they consider it is not adequate for what they have learned and developed. For example, P1 refers to “students have different strengths and weaknesses, and I am always feeling kind of guilty when I see that the grades do not reflect their true knowledge”. Even though there no suggestions are provided, it is visible that there is some sort of frustration and disappointment that assessment does not reflect the impact of CBL on students learning and their achievements. Additionally, participants 1 and 2 would like to engage in more scholarly approaches to teaching and learning and develop their teaching and educational research skills, however the institutional support is not systemic and organised to support such type of development. However, such scholarly activities are essential for educational reflective practice, making decisions based on empirical evidence, and moving towards a research-based education as well.

## 4 Conclusion

The results presented here are preliminary and based on three detailed academic staff viewpoints, who are already highly motivated and engaged towards an innovative and sustainable education through CBL. It does not allow to make more general inferences about their different viewpoints and to which extent they point towards a sustainability mindset. This poses the major limitation of the study; however, we consider this study a ‘seed’ for future work and with potential for further conceptualisation of CBL and sustainability mindset as strategies to create and deliver a quality of education for sustainability. Whilst we took the point of departure in exploring the academic staff beliefs, values, and viewpoints on different aspects of their

professional identity and practice, the results indicated intertwined and interconnected viewpoints that can be related with personal viewpoints, relational viewpoints, and institution educational viewpoints, hinting towards not only complexity but also a systemic perspective. Sustainability mindset is undoubtedly complex and, probably comprises other aspects that were not uncover and explored in this study, which provides room for future studies. The results show that values and beliefs around teaching are student-centred, altruistic and, to some extent personal. This study also provides the initial ideas for a model inspired by a nesting system, with point of departure of the self and expanding to relational and institutional aspects, i.e., spaces where academic staff can engage and interact, and might influence their personal and professional development. Additionally, ATLAS programme is launching the senior teaching accreditation programme within University of Twente, where the programme will allow enthusiastic teachers from across university to involve in 3-year fellowship at ATLAS. During their stay, they get involved in learning innovative solutions on how to include sustainability into their teaching and propose their own educational approaches. This will enrich debate within the ATLAS community on how to be more inclusive and sustainable in their teaching practices. Furthermore, the sustainable mindset approach engages learners and educators in questioning, clarifying ways of being and acting with a broadened understanding which underpins the ATLAS program. Future studies can take this initial conceptual model as point of departure and investigate in more depth which ways CBL and academic staff sustainability mindset impacts students learning for sustainability.

## 5 References

- Avelar, A. B. A., da Silva-Oliveira, K. D., Farina, M. C., & da Silva Pereira, R. (2021). Contribution of PRME in education, research, and outreach in Brazilian higher education institutions. *International Journal of Sustainability in Higher Education*. <https://doi.org/10.1108/IJSHE-09-2020-0350>
- Du, X., Spliid, C. M., Kolmos, A., Lyngdorf, N. E. R., & Ruan, Y. (2020). Development of critical reflection for transformative learning of engineering educators in a PBL-based professional learning program. *International Journal of Engineering Education*, 36(4), 1356–1371.
- Gadotti, M. (2008). What we need to learn to save the planet. *Journal of education for Sustainable Development*, 2(1), 21-30. <https://doi.org/10.1177/09734082080020010>
- Gulikers, J., & Oonk, C. (2019). Towards a Rubric for Stimulating and Evaluating Sustainable Learning. *Sustainability* 2019, Vol. 11, Page 969, 11(4), 969. <https://doi.org/10.3390/SU11040969>
- Hermes, J., & Rimanoczy, I. (2018). Deep learning for a sustainability mindset. *The International Journal of Management Education*, 16(3), 460-467. <https://doi.org/10.1016/j.ijme.2018.08.001>
- Kassel, K., Rimanoczy, I., & Mitchell, S. F. (2016). The sustainable mindset: Connecting being, thinking, and doing in management education. In *Academy of management proceedings* (Vol. 2016, No. 1, p. 16659). Briarcliff Manor, NY 10510: Academy of Management. [doi.org/10.5465/ambpp.2016.16659abstract](https://doi.org/10.5465/ambpp.2016.16659abstract)
- Ruge, G. (2020). Sustainability mindset framework for educational developers supporting future-ready curricula and student learning. *ETH Learning and Teaching Journal*, 2(2), 432-436. <https://doi.org/10.82425/lt-eth.v2i2.179>
- Savin-Baden, M. & van Niekerk L. (2007) Narrative Inquiry: Theory and Practice, *Journal of Geography in Higher Education*, Vol. 31(3), 459-472, DOI: 10.1080/03098260601071324
- Sukacké, V., Guerra, A., Ellinger, D., Carlos, V., Petroniené, S., Gaižiūnienė, L., Blanch, S., Marbà-Tallada, A., & Brose, A. (2022). Towards Active Evidence-Based Learning in Engineering Education: A Systematic Literature Review of PBL, PjBL, and CBL. *Sustainability* 2022, Vol. 14 (21) <https://doi.org/10.3390/SU142113955>
- van den Beemt, A., van de Watering, G & Bots, M. (2022) Conceptualising variety in challenge-based learning in higher education: the CBL-compass, *European Journal of Engineering Education*, DOI: 10.1080/03043797.2022.2078181



# Action competence in PBL: Revitalizing educational ideals to foster meaning and engagement in engineering education for sustainable development

Camilla Guldborg

AAU; KU, Denmark, [cgni@plan.aau.dk](mailto:cgni@plan.aau.dk); [pbt716@alumni.ku.dk](mailto:pbt716@alumni.ku.dk)

Christian Skelmosé

KU, Denmark, [lrj507@alumni.ku.dk](mailto:lrj507@alumni.ku.dk)

## Summary

This abstract looks at the concept of Action Competence and its potential contribution to engineering education for sustainable development. The abstract outlines an often-highlighted issue of the missing ‘meaningfulness’ in engineering education and suggests action competence as an educational approach that can help bridge the gap between ‘meaning’ and intended learning outcomes in formal curricula. Action competence as a theoretical concept is rooted in the central European “Bildung” tradition and Danish critical pedagogy. In this abstract we take a deeper look at its origin and how it can be combined with problem-based learning (PBL) in engineering education to create a more meaningful and engaging curriculum to support a much needed transformation of the understanding of the role of engineering itself in society as well as a shift towards student-centered learning in engineering education by providing students the ability and the belief that they can be a part of solving current and future global sustainability challenges.

**Keywords:** Action competence, sustainable development, problem-based learning, engineering education, Bildung

**Type of contribution:** Research extended abstract.

## 1 Introduction

According to UNESCO (2021) “Engineering plays a vital role in addressing basic human needs by improving our quality of life and creating opportunities for sustainable growth on a local, national, regional and global level.” (p. 4). Furthermore UNESCO (2021) underlines the need for transformations of engineering itself, to be more innovative, inclusive, cooperative, and responsible, if the United Nations Sustainable Development Goals (SDGs) is to be reached. According to UNESCO (2021) a shift is needed from an academic technical knowledge-focused path to a much broader interdisciplinary approach to learning, and from a teacher-centric focus to one that is more student-centered and problem-based. Though the shift is already happening according to Hadgraft & Kolmos (2020) over the last 30 years there has been seen new student-centred learning methods, such as design-based learning, inquiry-based learning, problem- and project-based learning etc. Hadgraft & Kolmos states that “Problem- and project-based learning (PBL) are commonly proposed solutions in engineering education as a response to a requirement for more complex (and complicated) learning.” (p. 10). Despite this shift Hadgraft & Kolmos (2020) still request engineering education with more focus on social responsibility and sustainable development.

In this abstract, we argue for Action Competence as an educational approach to transform problem-based learning (PBL) engineering education. To broaden the perspective and potential in PBL engineering education, to include more action-oriented curriculum. Action Competence naturally relates to concepts

such as agency, empowerment, literacy and self-efficacy, however for the purpose of this paper we focus primarily on the Danish understanding of action competence as introduced by Schnack (1993) and its potential contribution to problem-based learning in engineering education for sustainable development.

We suggest action competence as a practical educational approach between scientific and technological knowledge and a radical version of the notion of “Bildung” in action competence, to create more engaging and meaningful engineering education. When we use the word “meaning” we do not only see it in terms of creating student engagement. What we see as meaningful is having students experience self-confidence in their knowledge and skills. An interplay where the students can use their knowledge of scientific content and engineering competencies to impact the greater context of society in practical and action-oriented ways.

To further elaborate on the contribution of a focus on action competence in engineering education, we will look at the two-part dimension of action competence, the pedagogical concept and competence. We will first explore the concept of action competence from a general perspective and why it is relevant to creating functional members of society. We will elaborate on action competence as a pedagogical concept, in order to outline the pedagogy behind action competence. Afterwards, we will look at the potential of action competence in its interplay with engineering education from a theoretical perspective. We will look at what it can provide engineering students, and how it has potential to broaden the perspective on engineering education. Although outlining a comprehensive guide for implementing action competence in engineering education is considered out of scope for this paper, we will conclude with a few concepts that we believe could aid in the building of engineering action competence.

## 2 Action competence as a pedagogical concept

Action competence is a predominantly Danish concept that originated as a reaction to teaching characterized by behavior-regulating approaches and which was especially used within environmental pedagogy/environmental education and health-promoting education. The concept arose in the late 1970s in a research environment at the, then Danish teacher training college, with roots in critical pedagogy, and only became internationally used somewhat later (Mogensen & Schnack 2010; Lund, 2020). Later, in the 1980s and 1990s it became a key concept in research and curriculum development in relation to environmental- and health education, in Denmark (Mogensen & Schnack, 2010). In our research we have noted that action competence seems to have been given new life, with an increase in published articles since 2010, which could correlate with a renewed focus on sustainable education (Chen & Liu, 2020).

Historically, Schnack (1993) is generally credited the original definition of action competence (Sass, 2020; Chen & Liu, 2020). Schnack (1993) introduced the concept in the field of political education and defined action competence in terms of the ability and willingness to be a competent participant and describes how “Education for democracy is thus education for qualification for the role as a participant. It is in this light that the concept of competence to act must be seen” (translated from Schnack, 1993 p. 7). Thus, action competence is closely linked to democratic and political personal transformation in the role as an active participant in the democratic society and to a radical version of the notion of “Bildung” (Mogensen & Schnack, 2010). In this context, “Bildung” should be viewed as more than formation of the personality through education. In the utopian dimension of critical theory, “Bildung” aims for the fulfilment of humanity: “full development of the capacities and powers of each human individual to question preconceived opinions, prejudices, and 'given facts', and intended participation in the shaping of one's own and joint living conditions.” (Mogensen & Schnack, 2010, p. 61). In this sense, “action competence” should be viewed as an educational ideal.

The concept of action as a pedagogical concept, however, traces back to Dewey (1997), who according to Lund (2020) with his pragmatic concept of experience, connect action closely with intentionality and understanding of a situation, in which understanding, and creation of meaning are both a driving force and

motivation for action (Lund, 2020). Dewey links this to problem identification, analysis, and action together with educational thinking, which emphasizes promoting action on an informed and informed foundation (Lund, 2020). Furthermore, the roots of action competence in critical pedagogy have roots in Klafki's (2007) educational ideal, i.e., in the form of "co-determination", which implies being able to take responsibility and empowered to assess and make informed decisions. Klafki (2007) places particular emphasis on "self-determination", "co-determination" and "solidarity" as rooted concepts in connection with "Bildung". According to Klafki (2007), this concept of education is characterized by the ability to act based on working through epoch-making key problems, by asserting one's opinion and arguing for one's own, justified beliefs. In other words, students must be able to deal with global and current societal challenges and problems, with an emphasis on developing empowerment. As an extension, this paper takes inspiration from Biesta's (2015) understanding of education, which emphasizes inviting students to co-develop their world. Thus, the internal formation takes place in the relationship between society and the students' individual formation processes as a person, which in turn contributes to the development of society (Biesta, 2015). We therefore see that action competence as an educational approach can function as a direct invitation for students to influence, co-develop and transform their world, rather than merely adapting to the existing society.

We see the revitalization of the action competence concept in the modern education system, and in engineering education, as having roots in critical pedagogy similar to the skepticism that arose in the 1970s (Schnack, 1993) towards the view of the educational task as a matter of behavior modification, not too different from current 'leaky pipeline' discourse and instrumentalization of particularly STEM education. Rather, we see action competence as an educational approach bound in the pedagogy concept, to foster empowerment in the future of education for social responsibility and sustainable development. For students to experience a connection and relevance between the activities and their future careers and personal goals, as well as an opportunity to participate as active democratic citizens in the development of a sustainable society, it is essential that engineering education move beyond a mere focus on employability and a strong disciplinary curriculum (Mulder, 2017). Mulder (2017) argues for the need of rethinking engineering education to include, developing strategic and analytic capabilities to contribute to sustainable development and to support engineering students' public engagement during their studies (Mulder, 2017). He suggests this should have a leading role in the engineering curriculum design, including systems analysis, technology history and future studies as a foundation for developing what he refers to as techno-strategic competences, elaborating that the "(...)issue is not replacing science, modelling- and design courses; it is enabling students to connect science, modelling- and design work to the main challenges of society" (Mulder 2017, p. 1110).

## 2.1 Action competence as an engineering sub-competence

In the 1990s the industry voiced a concern regarding a larger focus on engineering science compared to engineering practice in engineering higher education (Edström & Kolmos, 2014). This led to an attempt at MIT with the introduction of CDIO (Conceive-Design-Implement-operate), to reform engineering education with an increased focus on what technical and scientific knowledge, skills and competencies were needed in the engineering industry.

However, the shift in focus on learning outcomes defined by the needs of the industry has not necessarily led to the desired outcome, as research shows how students still do not possess the needed competencies for real-world work situations (Walther & Radcliffe, 2007; Chen, Kolmos & Du, 2021; Hadgraft & Kolmos, 2020). Furthermore, they experience a dichotomy between their idea of the society-changing capability of engineering and the functional attribute focused engineering education (Walther & Radcliffe, 2007). This dichotomy could be perceived as a failure of engineering education to create meaning for the individual students.

Problem-based learning (PBL) has been argued to support students to take ownership of the learning process by having the students working with open ended, ill-structured and real-life problems through self-directed

learning (Edström & Kolmos, 2014). The PBL approach has a wide variation of implementations within engineering, with problems and projects varying in length and complexity, projects and cases can be picked to elicit specific learning outcomes or real-world cases that mirror the complexities and open-endedness of actual engineering tasks (Chen et al., 2021; Kolmos et al., 2020). In this way, PBL in engineering education has the potential to let students lead, driven by an inner motivation and a desire to act. However, with such a wide variation in implementations, shared strategies and common approaches are needed to ensure and encourage this motivation and ownership, particularly for new engineering students new to PBL, who might experience problems with identifying problems and effective solutions (Chen et al., 2021).

We propose that this issue could be alleviated by developing students' action competence and by having students engage with problems in society that can be solved with engineered artefacts. A review of empirical studies on action competences by Chen & Liu (2020), show how “action-oriented and transformative pedagogy cultivate students to be active participants, empower their capability of deliberating the causes and effects, and construct their visions for finding strategies toward the problems” (Chen & Liu, 2020 p. 1). This review (Chen & Liu, 2020), although not focused on engineering students specifically, highlights the potential for increasing engineering students' interest, motivation, and their perception of ‘meaningfulness’ in learning activities, by including action competence as an educational approach. We view this Active participation in society as a possible path to creating more socially responsible students/engineers as requested by Hadgraft & Kolmos (2020). Another request from Hadgraft & Kolmos (2020) is to increase integration of social contexts, here we also see the potential of action competence, as it could lead students to not only work with social contexts because it is required, but because they have a drive to help alleviate societal problems. Further we consider it important to scaffold an educational environment that allows the students to act based on their ideas and take action in the local community. Where the students can develop the self-confidence to believe in their own abilities to be able to develop new ideas and solutions to society's major problems.

In terms of implementing engineering education with a larger focus on action competence we have yet to conduct a comprehensive literature review. But we have noted the ENACT model, that uses the concept of SSI's (Socio Scientific Issues) to identify problems and through that lens has a focus on ethics, society and sustainability (Hwang et al., 2023). Although Hwang et al. (2023) does not mention action competence, it shares many perspectives with our belief of a potential direction for future engineering education.

### 3 Concluding remarks and future work

In this paper, we argue that the revitalization of Schnack's (1993) definition on action competence as an educational approach, has the possibility of transforming engineering education in both pre-college engineering and in higher education. A focus on action competence enforces a shift from an academic technical and knowledge-focused path to a much broader interdisciplinary approach to learning, and from a teacher-centric focus to one that is more student-centered and problem-based. We therefore see that action competence as an educational approach can function as a direct invitation for students to take action and influence, co-develop and transform their world, rather than just adapt to the existing world. In future studies, we will explore strategies for implementing action competence in practice in both K12, pre-college and engineering higher education transitions and its ability to provide the opportunity for students to experience meaning and a connection and relevance between intended learning outcomes and activities and their future careers and goals as well as opportunities to participate as active democratic citizens in the development of a sustainable society.

### 4 References

Biesta, G. (2015). What is Education For? On Good Education, Teacher Judgement, and Educational Professionalism. *European Journal of Education*, 50(1), 75–87. <https://doi.org/10.1111/ejed.12109>

- Chen, J., Kolmos, A., & Du, X. (2021). Forms of implementation and challenges of PBL in engineering education: a review of literature. *European Journal of Engineering Education*, 46(1), 90–115. <https://doi.org/10.1080/03043797.2020.1718615>
- Chen, S. Y., & Liu, S. Y. (2020). Developing Students' Action Competence for a Sustainable Future: A Review of Educational Research. *Sustainability*, 12(4), 1374. <https://doi.org/10.3390/su12041374>
- Dewey, J. (1997). *Experience And Education* (Reprint). Amsterdam University Press.
- Edström, K., & Kolmos, A. (2014). PBL and CDIO: complementary models for engineering education development. *European Journal of Engineering Education*, 39(5), 539–555. <https://doi.org/10.1080/03043797.2014.895703>
- Hadgraft, R. G., & Kolmos, A. (2020). Emerging learning environments in engineering education. *Australasian Journal of Engineering Education*, 25(1), 3–16. <https://doi.org/10.1080/22054952.2020.1713522>
- Hwang, Y., Ko, Y., Shim, S.S., Ok, S., Lee, H. (2023), Promoting engineering students' social responsibility and willingness to act on socioscientific issues. *IJ STEM Ed* 10, 11 (2023). <https://doi.org/10.1186/s40594-023-00402-1>
- Klafki, W. (2007). *Neue Studien zur Bildungstheorie und Didaktik: zeitgemäße Allgemeinbildung und kritisch-konstruktive Didaktik* (6th ed.) [New studies on educational theory and didactics: contemporary general education and critical-constructive didactics]. Beltz Verlag.
- Kolmos, A., Bertel, L. B., Holgaard, J. E., & Routhe, H. W. (2020). Project Types and Complex Problem-Solving Competencies: Towards a Conceptual Framework. I A. Guerra, A. Kolmos, M. Winther, & J. Chen (red.), *Educate for the future: PBL, Sustainability and Digitalisation 2020* (1 udg., s. 56-65). Aalborg Universitetsforlag. International Research Symposium on PBL
- Lund, B. (2020). *Bæredygtighedspædagogik og handlekompetence – et velkommen tilbage til 70'erne? Forskning Og Forandring [Sustainability Pedagogy and Action Competence – a Welcome Back to the 70s? Research and Change]*, 3(2), 47–68. <https://doi.org/10.23865/fof.v3.2433>
- Mogensen, F., & Schnack, K. (2010). The action competence approach and the 'new' discourses of education for sustainable development, competence and quality criteria. *Environmental Education Research*, 16(1), 59–74. <https://doi.org/10.1080/13504620903504032>
- Mulder, K. F. (2017). Strategic competences for concrete action towards sustainability: An oxymoron? Engineering education for a sustainable future. *Renewable and Sustainable Energy Reviews*, 68, 1106–1111. <https://doi.org/10.1016/j.rser.2016.03.038>
- Sass, W., Boeve-de Pauw, J., Olsson, D., Gericke, N., De Maeyer, S., & Van Petegem, P. (2020). Redefining action competence: The case of sustainable development. *The Journal of Environmental Education*, 51(4), 292–305. <https://doi.org/10.1080/00958964.2020.1765132>
- Schnack, K. (1993). Handlekompetence og politisk dannelse: Nogle baggrunde og indledende betragtninger. [Some background and preliminary considerations. In Action competence as a didactic concept]. In *Handlekompetence som didaktisk begreb* (2nd ed., pp. 5–15). Danmarks Lærerhøjskole.
- UNESCO. (2021). *Engineering for Sustainable Development: delivering on the Sustainable Development Goals*. United Nations Education, Scientific & Cultural Organization.
- Walther, J., & Radcliffe, D. F. (2007). The competence dilemma in engineering education: Moving beyond simple graduate attribute mapping. *Australasian Journal of Engineering Education*, 13(1), 41–51. <https://doi.org/10.1080/22054952.2007.11464000>

# Work-in-Progress: How to Assess Collaboration in Problem-Based Learning to Promote Sustainability in Future Engineers

Giajenthiran Velmurugan

Aalborg University, Denmark, [vel@plan.aau.dk](mailto:vel@plan.aau.dk)

Sebastian Munk Andersen

Aalborg University, Denmark, [sema@plan.aau.dk](mailto:sema@plan.aau.dk)

Sanne Lisborg

Aalborg University, Denmark, [sali@plan.aau.dk](mailto:sali@plan.aau.dk)

Stine Ejsing-Duun

Aalborg University, Denmark, [sed@plan.aau.dk](mailto:sed@plan.aau.dk)

## Abstract

Researchers and political decision-makers agree that collaboration is a key competence of future engineers as a prerequisite for tackling the world's complex problems and thus contributing to meeting the UN's sustainable development goals. However, as we show in the paper, collaboration is often not assessed in engineering education. In this extended abstract, we frame the problem of assessing collaboration skills among engineering students. In the paper, we first introduce the problem, then we present the field through a state-of-art in relation to assessment and then present our methodological design for our upcoming study of collaborative assessment in engineering education. This extended abstract is a work-in-progress.

**Keywords:** PBL, collaboration, assessment, sustainability, engineers

**Type of contribution:** Research extended abstract

## 1 Introduction

In the last twenty years different scholars have addressed how the labor market that awaits the engineering graduates is defined by complex problems due to increased globalization and rapid changes in technological developments (Rompelman, 2000; Lucena, 2006; Bass et al., 2015; Ellis et al. 2019; UNESCO, 2021). This has prompted the modern employer of not only engineering graduates, but STEM graduates in general, to demand workers with stronger transversal skillset that enables them to be exemplary in complex problem solving and collaboration with other professionals (Prinsley & Baranyani, 2013; Hart Research Associates, 2015, 2018; McGunagle & Zizka, 2018; Ellis et al., 2019). The demand for engineering graduates with exemplary problem solving and interdisciplinary collaboration skills does not solely originate from the labor market. The United Nations Sustainable Development Goals (SDGs) require skilled engineers who can deliver the needs and demands of the 21<sup>st</sup> century (UNESCO, 2021). The Director-General of UNESCO, and the chairman of the Chinese Academy of Engineering have stressed the crucial role of an innovative and sustainable STEM curricula, that responds to the shortage of modern engineers for implementing each of the 17 sustainable development goals (SDGs) (UNESCO, 2021). They both state that the problems that awaits the newly graduated engineers have become more complex, and require multi-disciplinary, cross-country, and inter-cultural solutions, which in turn require the universities to educate engineers that can create innovative

and sustainable solutions in collaboration with interdisciplinary teams at both the local, national, regional, and global level (UNESCO, 2021). The acknowledgment of collaboration as an important skill for engineering graduates has in the past decade been a focus for organizations responsible for international education standards, such as OECD and ABET. They state that the international standard for collaboration skills for engineering graduates includes demonstrating an ability to function effectively as an individual in teams to accomplish a common goal (OECD, 2011; ABET, 2016). The call for change in the required competencies of engineering graduates is not new but was pointed out by Bucciarelli (1996) and Petty (1999) in the 90s (see figure 1).

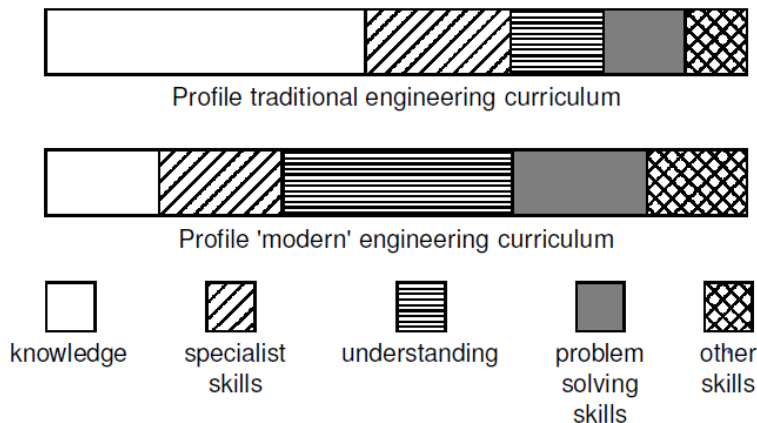

Figure 1: The change of emphasis in the contents of engineering curricula (Petty, 1999)

The engineers of the 50s were educated to do their jobs as specialists' employee within a large, well organized, hierarchical, and authoritarian organization defined by its technical focus and expertise, while the engineers of the 90s was educated to be less of a specialist, but trained to cope with problem solving, uncertainty and teamwork, able to articulate, communicate and defend different proposals and solutions (Bucciarelli, 1996). What defines today's engineers, are a requirement to work in a multidisciplinary team, on interdisciplinary solutions for divergent users, which requires collaboration with different sciences, professions, and nationalities (Ellis et al., 2019; Hart Research Associates, 2015, 2018; UNESCO, 2021). The universities need to prepare engineering students for a lifelong career in their respective fields and ensure that they acquire the skills needed for providing sustainable engineering solutions to the problems of the 21<sup>st</sup> century (Rompelman, 2000). This requires that universities focus more intensively on transversal skills such as interdisciplinary collaboration. A key element in promoting collaboration skills in engineering education is developing suitable assessment frameworks that correspond with the needed competencies (Rompelman, 2000; Jackel et al. 2017; Evans, 2016; Tremblay et al., 2012; Bloxham & Boyd, 2007; Bigs & Tang, 2011). Traditionally, engineering students have been tested on their knowledge, skills, and understanding, and even though a lot has changed in the 21<sup>st</sup> century, these three themes are still at the gist of what is assessed today (Halls, et al., 2022).

The aim of this publication is to explore how to develop suitable frameworks for assessing collaboration in engineering education. This is needed as the assessor often does not get an authentic view of how the collaboration among students unfolds (Velmurugan, 2022). First, we present what the literature suggests as best practice within assessment in higher education. These insights help setting the scene and identify potentials and pitfalls as suggested in the research literature. Further, the state-of-art informs a Future Workshop (FW) with practitioners which aims to answer our research question:

How are collaboration processes in engineering education made explicit for students, supervisors and assessors so that it is conducive to learning?

## 2 State-of-Art

The literature on assessment and its associated topics are complex (Halls et al., 2022), and although the literature on assessment in general is comprehensive, the literature about assessment of collaboration is lacking (Jackel et al., 2017). Literature reviews establish that best practice consists of systematic considerations of practice on a range of elements (Halls et al., 2022), and as such, the literature divides to focus on different frameworks of assessment that each deal with their own element of assessment; design, feedback, or practice. The literature on the design element of assessment tends to overlap in their presentation of general assessment literature, to then diverge and focus on different individual elements of the design, such as: the developing of general assessment design in higher education (Bloxham & Boyd, 2007), credit weightings and workloads (Galvin et al., 2012), constructive alignment (Biggs & Tang, 2011), design of multiple-choice questions (Brame, 2013), design of marking rubrics (Brookhart, 2018; Suskie, 2018), program level assessment design strategies (Jessop & Tomás, 2017; Hartley & Whitfield, 2012) and program level reviews (TESTA, 2019; Tomás & Jessop, 2018). Other literature focuses more specifically on the feedback element of assessment, such as: developing evaluative judgment (Tai et al., 2018; Boud et al., 2018), feedback, enhanced feedback, and student engagement (Evans, 2016; Nicol, 2010; Cockett & Jackson, 2018; Winstone et al., 2017), formative vs. summative assessment (Lau, 2015), self-, peer- and co- assessment (Dochy et al., 1999), and developing students' self-efficacy (Panadero & Romero, 2014). While the abovementioned literature focuses on different elements of assessment, other literature tries to combine them and make comprehensive guidelines for assessment practice in general. In *Assessment and feedback in higher education* (Jackel et al., 2017), the authors identify the principles and processes that are fundamental to assessments of not only high quality, but also improves student learning. These principles and processes detail a framework for assessment design that not only assesses the students, but also reviews the institutions and programs that form the assessments of the students. Similarly, the Evans Assessment Toolkit (EAT), made by Evans (2016), not only assesses what the student has acquired, but identifies assessment priorities in both the individual, the discipline, the faculty, and the university. As such, EAT comes with detailed guidelines for assessment performance for both students, educators, and program directors to follow. While the literature surrounding assessment shows a clear focus on specific assessment elements such as design, practice, and feedback, it also reveals the absence of comprehensive guidelines for the assessment of collaboration. As described earlier, engineers need skills that enable them to successfully engage in multi-disciplinary, cross-country, and inter-cultural collaborations. However, literature on how to assess these skills is lacking. We wish to fill this gap by exploring how we as educators can better assess these collaboration skills by conducting a future workshop with expert practitioners in the field.

## 3 Research Design

The Future Workshop is a method that brings practitioners together to criticize a practice and then imagine a more desirable future (Vidal, 2005). Originally, FW was introduced as a method that engaged participants in critique, learning, teamwork, democracy, and empowerment in relation to a problem that they wanted to address. Thus, FW builds on the agency and expertise of practitioners.



We are inviting teachers within Engineering Education to participate in a FW to develop assessment frameworks that honor and illuminate collaboration processes and skills. Engineering teachers and researchers are experts in more than one way: a) they themselves conduct teaching and assess students; b) they might participate in developing assessment forms; c) as researchers they look at the topic from the outside and reflect on it.

FW consists of five overall phases: Prior to the workshop the (1) preparation phase is initiated. The preparation covers planning the FW. Here, themes are determined and formulated, participants are invited and informed about the purpose of the FW and the practical matters are clarified. The second phase is the (2) critique phase, here the problem of assessing collaboration in engineering education is discussed and examined critically and thoroughly by the participants through a brainstorm about the problems they have experienced and observed. This is followed by a structuring and grouping of issues into some main themes. In the (3) fantasy phase, the participants try to develop their social imagination by creating a utopia and thus drawing a caricatured picture of the future that might mitigate the experienced and described problems. In the (4) implementation phase, the ideas found are assessed in relation to their feasibility. In the (5) follow-up phase, an action plan is normally drawn up; finally, changes are made if the FW is conducted within an organization and, if necessary, new FWs are planned (Vidal, 2005).

Knowledge, produced through the FW and subsequent development and testing of ideas will be shared through two papers: The first paper, presents the central issues with the current practice as experienced by the participants, how these are narrated and prioritized in the FW. The second paper presents and evaluates the ideas for new designs for assessment of collaboration in engineering education.

## 4 References

- ABET. (2016). 2017-2018 Criteria for Accrediting Computer Programs. Baltimore, MD: ABET
- Bass, J. M., McDermott, R., & Lalchandani J. T. (2015, July). *Virtual teams and employability in global software engineering education*. IEEE 10th International Conference on Global Software Engineering 2015, 115–124.
- Biggs, J., & Tang, C. (2011). *Teaching for Quality Learning at University* (4th ed.). New York, NY: McGraw-Hill International.
- Bloxham, S., & Boyd, P. (2007). *Developing Effective Assessment in Higher Education: A Practical Guide*. New York, NY: McGraw-Hill International.
- Boud, D., Ajjawi, R., Dawson, P., & Tai, J. (2018). *Developing Evaluative Judgment in Higher Education*. Routledge.
- Brame, C. (2013). *Writing Good Multiple Choice Test Questions*. Retrieved [11/11-2022] from <https://cft.vanderbilt.edu/guides-sub-pages/writing-good-multiple-choice-test-questions/>.
- Brookhart, S. M. (2018). Appropriate Criteria: Key to Effective Rubrics. *Frontiers in Education: Assessment, Testing and Applied Measurement* 3(22), 1–12.
- Bucciarelli, L. (1996). *Educating the learning practitioner*. In F. Maffioli, M. Horvath and F. Reichl (eds), *Educating the Engineer for Lifelong Learning*. Proceedings of the SEFI Annual Conference, Vienna, 13–22.
- Cockett, A., & Jackson, C. (2018). The use of Assessment Rubrics to Enhance Feedback in Higher Education: An Integrative Literature Review. *Nurse Education Today* 69, 8–13.
- Dochy, F., Segers, M., & Sluijsmans, D. (1999). The Use of Self-, Peer- and Co-assessment in Higher Education: A Review. *Studies in Higher Education* 24(3), 331–350.

- Dolmans, D. H. (2019). How theory and design-based research can mature PBL practice and research. *Advances in health sciences education* 24(5), 879-891.
- Ellis, R. A., Han, F., & Pardo, A. (2019). When Does Collaboration Lead to Deeper Learning? Renewed Definitions of Collaboration for Engineering Students. *IEEE Transactions on Learning Technologies* 12(1), 123-132
- Evans, C. (2016). *Enhancing Assessment Feedback Practice in Higher Education: The EAT Framework*. Southampton, England: University of Southampton.
- Galvin, A., Noonan, E., & O'Neill, G. (2012). *Assessment Workload and Equivalences*. Dublin, England: University College of Dublin.
- Halls, J. G., Tomás, C., Owen, J. S., & Hawwash, K. (2022). Mapping out the landscape of literature on assessment in engineering education. *European Journal of Engineering Education* 47(3), 373–393.
- Hart Research Associates. (2015). *Falling short? College learning and career success*. Washington, DC: Hart Research Associates
- Hart Research Associates. (2018). *Fulfilling the American dream: liberal education and the future of work*. Washington, DC: Hart Research Associates
- Hartley, P., & Whitfield, R. (2012). *Programme Assessment Strategies (PASS)*. York, England: The Higher Education Academy.
- Jackel, B., Pearce, J., Radloff, A., & Edwards, D. (2017). *Assessment and Feedback in Higher Education: A review of literature for the Higher Education Academy*. York, United Kingdom: The Higher Education Academy.
- Jessop, T., & Tomás, C. (2017). The Implications of Programme Assessment Patterns for Student Learning. *Assessment and Evaluation in Higher Education* 42(6), 990–999.
- Lau, A. M. S. (2015). Formative Good, Summative bad? – a Review of the Dichotomy in Assessment Literature. *Journal of Further and Higher Education* 40(4), 509–525.
- Lucena, J. C. (2006). Globalization and organizational change: Engineers' experiences and their implications for engineering education. *European Journal of Engineering Education* 31(3), 321–338.
- McGunagle, D., & Zizka, L. (2018). Meeting real world demands of the global economy: an employer's perspective. *Journal of Aviation/Aerospace Education & Research* 27(2), 59–76.
- Nicol, D. (2010). From Monologue to Dialogue: Improving Written Feedback Processes in Mass Higher Education. *Assessment and Evaluation in Higher Education* 35(5), 501–517.
- OECD. (2011). *A Tuning-AHELO Conceptual Framework of Expected Desired/Learning Outcomes in Engineering*. *OECD Education Working Papers 60*. Paris, France: OECD Publishing
- Panadero, E., & Romero, M. (2014). To Rubric or not to Rubric? The Effects of Self-Assessment on Self-Regulation, Performance and Self-Efficacy. *Assessment in Education: Principles, Policy and Practice* 21(2), 133–148.
- Petty, I. (1999). Vision 2020—education in the next millennium. In A. Hagström, (ed.), *Engineering Education: Rediscovering the Centre*. Proceedings of the SEFI Annual Conference, Winterthur and Zürich, 27–35.
- Prinsley, R. T., & Baranyai, K. (2013). *STEM skills in the workforce: what do employers want?*. Brisbane: Office of the Chief Scientist.
- Suskie, L. (2018). *Assessing Student Learning: A Common Sense Guide* (3rd ed.). San Francisco, CA: Jossey-Bass.
- Tai, J., Ajjawi, R., Boud, D., Dawson, P., & Panadero, E. (2018). Developing Evaluative Judgement: Enabling Students to Make Decisions About the Quality of Work. *Higher Education* 76, 467–497

- TESTA. (2019). *Transforming the Experience of Students through Assessment*. UCL Arena Centre for Research-Based Education
- Tomás, C., & Jessop, T. (2018). Struggling and Juggling: a Comparative Study of Student Assessment Loads Across Institution Types. *Assessment and Evaluation in Higher Education* 44(1), 1-10.
- Tremblay, K., Lalancette, D., & Roseveare, D. (2012). Assessment of Higher Education Learning Outcomes – AHELO: Feasibility Study Report. Paris, France: OECD
- UNESCO. (2021). *Engineering for Sustainable Development*. Paris, France: the United Nations Educational, Scientific and Cultural Organization
- Velmurugan, G. (2020). Problem Construction in Problem-Based Learning: How Students Deal with Disagreements in Decision-Making. Aalborg, Denmark: Aalborg Universitetsforlag
- Vidal, R.V. (2005). *The Future Workshop: Democratic problem solving*. Lyngby, Denmark: Technical University of Denmark
- Winstone, N. E., Nash, R. A., Parker, M., & Rowntree, J. (2017). Supporting Learners' Agentic Engagement with Feedback: a Systematic Review of the Literature and a Taxonomy of Recipience Processes. *Educational Psychologist* 51(1), 17–37.

# Reflections on creating an interdisciplinary graduate program of Sustainability in Colombia

Katherine, Ortegón

Director Master in Sustainability, School of Engineering, Universidad Icesi, Colombia, [kortegon@icesi.edu.co](mailto:kortegon@icesi.edu.co)

Natalia, Rodríguez

Director Master in Law - Research, School of Law and Social Sciences, Universidad Icesi, Colombia, [nrodriguez1@icesi.edu.co](mailto:nrodriguez1@icesi.edu.co)

Camila, Pizano

Assistant Professor, School of Natural Sciences, Universidad Icesi, Colombia, [cpizano@icesi.edu.co](mailto:cpizano@icesi.edu.co)

Pilar, Acosta

Adjunct Professor, School of Business and Economics, Universidad Icesi, Colombia, [mdacosta@icesi.edu.co](mailto:mdacosta@icesi.edu.co)

Lopez, Andres

Associate professor, School of Engineering, Universidad Icesi, Colombia, [alopez@icesi.edu.co](mailto:alopez@icesi.edu.co)

## Summary

Creating an interdisciplinary graduate program on sustainability in the Colombian context represents a challenge. This paper is intended to inspire other universities that have similar endeavours while raising awareness about the challenges and difficulties they might encounter, and the benefits it brings. This article presents the reflections from the founders and the managing director of a Master in Sustainability (MS) program, that was created and is managed between four schools: Engineering, Law and Social Sciences, Natural Sciences, and Business and Economics. The reflection includes three aspects that are paramount to design interdisciplinary programs that require cooperation among different schools. First, usually each school works independently and has isolated programs that commit strongly to its own discipline, whereas an interdisciplinary project profits from the expertise of professionals in several fields and has the support of different schools. Second, to be successful, an interdisciplinary program must be committed to project and problem-based learning as a learning strategy to solve sustainability problems. Finally, this kind of programs seek to have a real impact on different sectors of society; for this, it is paramount to have private and public organizations engaged as allies.

**Keywords:** Sustainability, Interdisciplinarity, Higher Education, Colombia

**Type of contribution:** Best practice extended abstracts

## 1 Introduction

To transform education through innovative learning, teaching, and experiential methodologies that truly have an impact on students and society is nowadays a necessity. Moreover, educating for sustainability requires higher education institutions (HEIs) to engage and be willing to break invisible walls that have been shaped by disciplinary solutions to problems that are, by nature, interdisciplinary. Today, sustainable global challenges such as climate change, energy transition, waste recovery, biodiversity conservation, and poverty and inequality demand an interdisciplinary approach for finding solutions that are inclusive, integrate technology, and respect natural ecosystems (Horn et al., 2022). However, interdisciplinarity faces multiple challenges related to the epistemological traditions of each discipline, and the structural organization of universities (Kaplan et al., 2017; Thrin et al., 2021). Although the advantages and the importance of an

interdisciplinary approach to differentiate and create value in different manners and environments have been studied (Kaplan, 2022; The National Academies Press, 2020), information on learned lessons from institutions that have already implemented these programs, is limited. This article presents the reflections from a group of professors and researchers that worked as an interdisciplinary team to conceive, design, and launch the first interdisciplinary graduate program in sustainability at Universidad Icesi, a private university in Colombia, South America.

## 2 Bringing schools together to create an interdisciplinary graduate program on sustainability

The Master in Sustainability (MS) was created in 2019, and it is the first interdisciplinary and multi-school program at Universidad Icesi of this kind. |It was approved by the Colombian Ministry for Education in 2020, and started operation in the fall of 2021. Five professors working in sustainability from different fields and affiliated to four different schools came together to create a program that, from its conception, had interdisciplinarity as the main pillar. They worked as representatives from the schools of Engineering, Law and Social Sciences, Natural Sciences, and Business and Economics. There were three main reasons for creating an interdisciplinary program: First, they identified a lack of articulation between schools that resulted in initiatives, research, and solutions with low visibility. Second, sustainability should be understood as an intersectional endeavour where educational institutions recognize the strengths and weaknesses of each school and discipline. Lastly, local, national and international environmental challenges require robust and inclusive solutions with the potential to positively impact society. With these three main elements in mind, the Masters in Sustainability graduate program focusses on the central competency of “*forming professionals capable of designing and leading solutions to the most pressing sustainability challenges* “. This objective is complemented by soft skills in critical and system thinking, meaningful communication, responsible leadership, and ethics. The MS program lasts 1.5 years (3 semesters) and welcomes students from all disciplines. The MS program offers a unique training curriculum to professionals whom strength their skills in four areas of knowledge: *Sustainable technologies*, supported by the School of Engineering; *Conservation biology* supported by the School of Natural Sciences; *Legislation and public policy* supported by the Law and Social Sciences School, and *Business sustainability* supported by the School of Business and Economics. In addition, three aspects foster the interdisciplinarity of MS: professionals from across diverse disciplines learning from each other, capstone projects related to real-world problems that require an interdisciplinary approach, and courses taught by at least two professors from different schools (Figure 1).

There were several challenges during the creation stage. These started with the institutional framework of Universidad Icesi and the Colombian Ministry of Education, that do not encourage the inclusion of the word “interdisciplinary” on a master degree. This also means that programs should “belong” to only one school. To overcome this challenge, the team of professors had to justify the importance of having all schools equally represented and registered within the program. University governance had to be contested with the proposal of a new structure that would allow for the participation of all four schools in the decision-making process. This new structure includes an Executive committee formed by each school’s deans , an Academic committee with the professors who created the program, a Curriculum committee which includes alumni and current students, and an Advisory board composed by external experts in each field. The program also has a managing director, whom rotates every two years between the four participating schools. In addition, Universidad Icesi created a new unit in the information system called “interdisciplinary programs” that deals with the academic, administrative, and accounting issues related to initiatives like this at the university. It should be noted that this information system was originally designed to support individual programs associated to specific schools. Joining four schools has created a common point of discussion that raises awareness around sustainability and how each school can contribute to it.

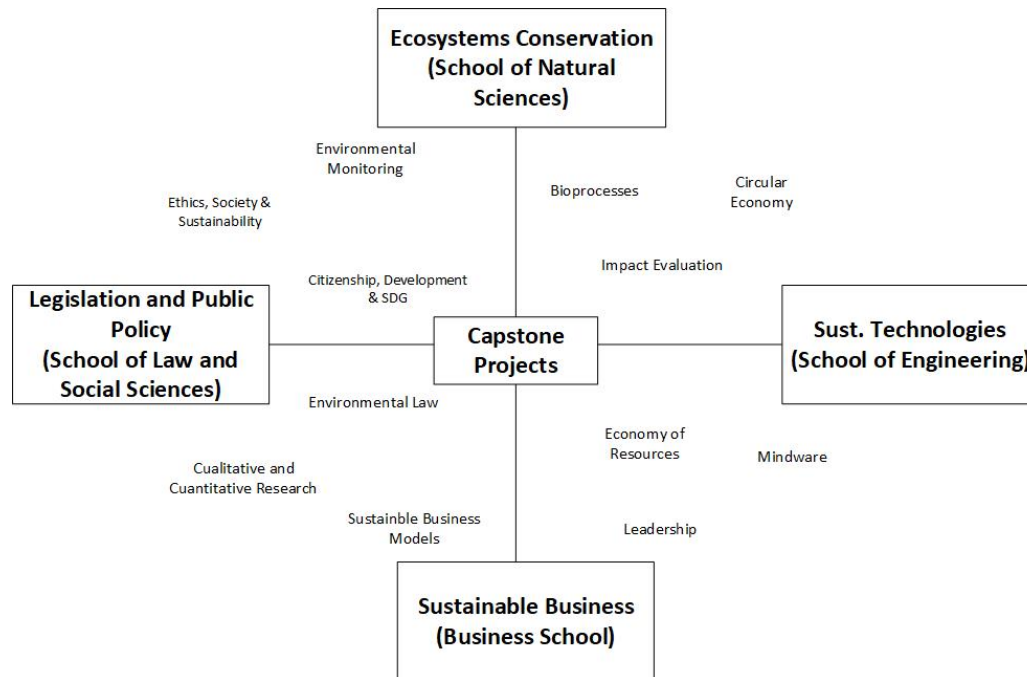

Figure 1: Shared courses between different schools. The majority of courses are interdisciplinary in terms of students, professors and projects

### 3 Curriculum design: PBL and POL for solving sustainability problems

The path towards interdisciplinarity requires a paradigm shift in relation to the interpretation of the development of sustainability in organizations. This was traditionally considered a responsibility of a specific area in charge of the company's environmental management, configuring a thought in silo. This area is also accountable for environmental legal compliance, as well as voluntary business management systems. Sustainability now requires network thinking developed through the construction of transversal systems, where the person in charge leads the development of the transformation in the organization. In tune with the 2030 Sustainable Development Goals agenda, and a long-term 2050 horizon, private and public institutions should now strive to comply with the global agreements that aim for the decarbonization of the economy. These transversal systems include developing environmental policies, business sustainability strategies and projects that integrate functional areas and business units. Thus, if universities wish to form well-rounded students that can rise to these challenges, they must educate them to develop skills related to systemic thinking, critical thinking and the management of collaboration and complementarity through natural and business ecosystems, as well as complex systems (Bursztym & Drummont, 2014).

It is impossible to face current and future sustainability challenges with old and outdated learning methodologies. Thus, the commitment to new learning strategies is critical. For this reason, the MS program is based on problem-based learning (PBL) throughout all the courses of the curriculum, and project-organized learning (POL) throughout the capstone and thesis. In addition, classes are designed on active learning with an interdisciplinary approach. At least two professors from diverse backgrounds collaborate in designing, teaching, and assessing each class. For example, the Sustainable business models' class is taught by professor A from the Business School who emphasizes an environmental perspective and professor B from the Law and Social Sciences School, who emphasizes a social perspective in business models. This interdisciplinary approach enriches the discussions, debates, and participation during the class.

Capstone projects are designed with three main goals. First, to expose students to real-world sustainability challenges while collaborating with partners from diverse organizations (e.g., NGOs, private and public

companies). Second, to develop in students the ability to work effectively in interdisciplinary teams, given their different professions and backgrounds and third, each semester's courses are integrated, allowing them not only to embed class' concepts in the projects, but also to make more robust solutions as they address these real-world sustainability issues. Table 2 presents examples of the capstone projects developed to date and a brief explanation of their impacts under the triple bottom line approach.

Table 2: Sustainable capstone projects developed during 2021 and 2022 and associated impacts under the triple bottom line approach

Capstone Project	Partner	Environmental impact	Social Impact	Economic Impact
Sustainable Tourism	Eco-tourism entrepreneurs	Improvement of circular economy practices	Development of shared economy	New business model
Ecosystem of Recovered Plastics	Packaging Company	Reduction of plastic footprint	Improvement of recyclers conditions	Increase of recycling rates
Sustainable Agriculture	Fruits Company	Improvement of ecological practices	Local job opportunities	Diversification of products
Water Information Systems	Rivers and Lakes Foundation	Water conservation through information	Community and society engagement	Platform with available information
Sustainable Cosmetics	Cosmetics Company	Reduction of cosmetics footprint	Engagement of vulnerable population	New business opportunities

#### 4 Engaging organizations in creating value through capstone projects of high impact

The Academic committee has identified three main benefits of interdisciplinary programs. First, organizations engaged in capstone projects create value beyond the business boundaries while connecting their suppliers, distributors, and/or costumers in sustainable practices (Miemczyk et al., 2022). Second, capstone projects can also generate value to the community when relevant stakeholders become active participants in the solutions along with the students, overcoming set mindsets together. Third, the ecosystem benefits as well because the environmental aspects are always considered. For instance, the project related to the design of an "Ecosystem for recovered plastics" allowed the partner company to expand its vision across other supply chain actors, connecting other companies in charge of collecting and classifying waste as well as companies in charge of reprocessing the recovered materials for a second life. The value to the community was oriented to the job conditions and engagement of recyclers. Typically, recyclers are a vulnerable population that lack acknowledgement for their labour. Entire families earn their daily livelihood from this activity, and the project exposed these conditions and proposed alternatives considering not only the role of women as pillars of the family, but also the policies that collection and classification stations must have in reference to keeping children involved, drug sales and consumption. Lastly, the ecosystem value was achieved in two manners: through the increase of recycling rates of plastics, and the subsequent socialization of this initiative to governmental instances in charge of fostering circularity of materials in the city of Cali.

#### 5 Lessons and takeaways

Creating the culture of cooperation and interdisciplinary work is a continuous process that requires patience, common goals, and a shared vision. Educational institutions need to work seriously on changing the traditional view of schools being separate and isolated entities in academic and research activities. Instead,

HEIs should adopt for a view that integrates schools and academics from various backgrounds as part of the same ecosystem if they really want to provide high quality education that impact society. It is important to highlight that disciplinary terms create a language barrier; this calls for the identification of common vocabularies that can make the different disciplines accessible to every student. Indeed, our current training in silos leads to different visions of the world, variety in the definition of research and its outputs. In other words, discipline-focused academic education can sometimes difficult communication and the creation of interdisciplinary knowledge. Similarly, measuring the impacts derived from interdisciplinarity is a complex task since defining impacts on itself might be different as the vision of the world changes across disciplines. Students' assessment also represents difficulties, especially to avoid emphasizing one discipline, something usually done when teaching.

Regarding structural problems of universities and business schools, we identified balancing targets of different schools or units within a university might be complex (e.g., priority given to research or teaching). In this line, satisfying accreditation bodies and tenure-track systems (Thrin et al., 2021), remain discipline-based creating challenges for interdisciplinarity. To solve the current and future sustainability challenges, is paramount to strength the relationship between universities and industry willing to learn together, to open to each other and to risk together in research and projects of diverse nature to achieve more robust, less impacting, and more inclusive solutions. This alliance between academy and organizations has allowed for cross-fertilization, which has enriched the master's program, in addition to materializing ideas and solutions for improving organizations' performance in sustainability. To this end, finding partners from across disciplines and varied social, economic, and environmental focuses is crucial, and may need a more regional or national view of academic programs. At the same time, interdisciplinary programs should attract students from across disciplines with varied social, economic, and educational backgrounds that will more likely come from different regions or even countries. Thus, interdisciplinary programs on sustainability should not only provide on-line program options, but also design meaningful learning experiences to successfully engage partners and students from all across.

## References

- Horn, A., Urias, E., & Zweekhorst, M. B. M. (2022). Epistemic stability and epistemic adaptability: interdisciplinary knowledge integration competencies for complex sustainability issues. *Sustainability Science*. <https://doi.org/10.1007/s11625-022-01113-2>
- Kaplan, S. N. (2022). The Importance of Interdisciplinarity to Differentiate. *Gifted Child Today*, 45(2), 69–71. <https://doi.org/10.1177/10762175211070713>
- Kaplan, S., Milde, J., & Cowan, R. S. (2017). Symbiont practices in boundary spanning: Bridging the cognitive and political divides in interdisciplinary research. *Academy of Management Journal*, 60(4), 1387–1414. <https://doi.org/10.5465/amj.2015.0809>
- Miemczyk, J., Carbone, V., & Howard, M. (2022). Learning to Implement the Circular Economy in the Agri-food Sector: A Multilevel Perspective. In L. Bals, W. L. Tate, & L. M. Ellram (Eds.), *Circular Economy Supply Chains: From Chains to Systems* (pp. 283–301). Emerald Publishing Limited. <https://doi.org/10.1108/978-1-83982-544-620221014>
- The National Academies Press. (2020). *Strengthening Sustainability Programs and Curricula at the Undergraduate and Graduate Levels*. National Academies Press. <https://doi.org/10.17226/25821>
- Marcel Bursztyn & José Drummond (2014) Sustainability science and the university: pitfalls and bridges to interdisciplinarity, *Environmental Education Research*, 20:3, 313-332, DOI: 10.1080/13504622.2013.780587
- Trinh, M., Kirsch, R., Castillo, EA, Bates, D., (2021). Forging paths to interdisciplinary research for early career academics. *Academy of Management Learning*, <https://doi.org/10.5465/amle.2019.0386>





# Educational Innovation and Curriculum Design

# Is the Drawing of Free Body Diagrams a Threshold Concept?

Imad Abou-Hayt

Aalborg University, Denmark, [imad@plan.aau.dk](mailto:imad@plan.aau.dk)

Bettina Dahl

Aalborg University, Denmark, [bdahls@plan.aau.dk](mailto:bdahls@plan.aau.dk)

## Summary

This extended abstract is the starting point of ongoing empirical research, which aims at challenging the claim that the concept of a Free Body Diagram (FBD) in engineering mechanics is a threshold one. In the abstract, we first discuss the notion of threshold concepts, including making references to literature claiming that FBD is a threshold concept. We critically discuss this literature. As a first step in discussing if FBD is indeed a threshold concept, we perform a test to students after following a course teaching the students FBD, among other things. We did not yet succeed in verifying that drawing FBDs is a threshold concept.

**Keywords:** threshold concepts, problem-based learning, free body diagrams, engineering mechanics

**Type of contribution:** Research extended abstracts

## 1 Introduction

Many authors claim to have identified so-called threshold concepts in various fields, including engineering mechanics. This extended abstract is the starting point of an ongoing empirical research, which aims at challenging the claim that the concept of a Free Body Diagram (FBD) in engineering mechanics is a threshold one. Threshold concepts were introduced by Meyer and Land in their foundational paper (Meyer & Land, 2003). They defined the notion of threshold concepts to describing and analyzing specific aspects of university student learning: “A threshold concept can be considered as akin to a portal, opening up a new and previously inaccessible way of thinking about something. It represents a transformed way of understanding, or interpreting, or viewing something without which the learner cannot progress” (p. 1). According to Meyer and Land, threshold concepts must have five characteristics. These are:

- **Transformative:** A significant change occurs from understanding the threshold concept. It can change how learners think about the discipline, about themselves, or about the world.
- **Irreversible:** Once a threshold concept is understood, it is not likely that it will be unlearned or forgotten.
- **Integrative:** The students suddenly see how details make sense and fit into a large picture. This is also described by Zepke (2013) as: “Once understood, it enables students to knit dissimilar elements of a subject together” (p. 100).
- **Bounded:** In the sense that “any conceptual space will have terminal frontiers, bordering with thresholds into new conceptual areas” (Meyer & Land, 2005, p. 8).
- **Troublesome:** Threshold concepts are troublesome in the sense that they are difficult for students to understand, as they appear counter-intuitive and not easily understood when first encountered.

There are many concepts in engineering that students must understand and some of these concepts can be regarded as building blocks which should be mastered if the students are to succeed in their studies. An

example of such concepts is the ability of students to idealize a mechanical system and draw its free body diagram (FBD) to determine the forces acting on it. A free body diagram is a representation of the external forces and moments acting on a physical object. The effects of all external connections and supports are replaced by the forces and moments that those connections and supports can impart (Rosengrant et al., 2009). Thus, “A thorough understanding of how to draw a free-body diagram is of primary importance for solving problems in both statics and strength of materials” (Hibbeler, 2019, p. 177). Therefore, we decided to focus on FBDs in this paper. The participants of our investigation are 1<sup>st</sup> year students, enrolled in the study program “Sustainable Design” at Aalborg University, Denmark. The main research question of our full paper is: Assuming that FBDs is a threshold concept, how well do the students perform on a longer term on a test checking their understanding of FBDs?

## 2 The concept of ‘threshold concepts’

According to Shryock and Haglund (2017), engineering faculty members who teach introductory engineering mechanics courses find that the ability of students to idealize a mechanical system and draw its FBD is a threshold concept that, once mastered, can transform the student’s understanding. They developed an instrument for FBDs containing both free response and multiple-choice questions. Shryock and Haglund have identified strengths and weaknesses of their students related to FBDs. Using this information, faculty members can better modify instruction in the classroom related to FBDs. McCarthy and Goldfinch (2012) developed an online FBD quiz that detects students who understand this concept and those who have difficulties with it. They found that the FBD quiz is a good predictor of future performance in subsequent engineering mechanics courses. Prusty and Russell (2011) report that adaptive tutorials, which provide interactive learning tools for students, help them practice applying concepts and skills in engineering mechanics, where they get immediate feedback on how well they understand and apply basic concepts. Moreover, the adaptive tutorials enable teachers to track where students are having difficulties with basic concepts in the course. Based on this, we can conclude that a vast amount of literature claims that FBDs is indeed a threshold concept. However, we wish to argue that we do not find the conclusions of these studies convincing. For instance, Shryock and Haglund merely asked faculty members, not students about this, and there was no testing of students or monitoring of their learning process. We find that in order to determine if a concept is indeed a threshold concept, deeper studies are needed.

In terms of ways to teach students threshold concepts, a study by Doody (2009) explored the idea of a threshold concept in computer science. He examined the effect of using PBL on teaching an introductory software development course. His findings indicate that PBL was effective in helping the students master threshold concepts in computing and that the use of PBL to teach novice learners may also help to improve the students’ ability of retention. Furthermore, regarding the relation of threshold concepts to PBL, the book *Threshold Concepts in Problem-based Learning* (Savin-Baden & Tombs, 2018) claims to address a gap in research and the authors maintain that PBL and threshold concepts are natural partners and argue that teaching threshold concepts enhances the students’ understanding and practice of PBL. For the purpose of this research, we regard PBL as an educational framework that also aligns well with the concept of *lived knowledge* from Variation Theory (Kullberg et al., 2017). The lived knowledge refers to what the students actually learn as a result of a learning situation – in this case a PBL learning situation. In this study, we do not intend to *test* to what extent PBL *caused* a certain learning outcome in the students. Rather, we study the students’ lived knowledge of FBDs after the end of a course to help us answer to what extent it is reasonable to assume that a FBD is a threshold concept.

## 3 Methodology

The preliminary investigation was conducted in January 2022 in the form of a written test, right before the students began their 2<sup>nd</sup> semester on 1 February (Spring 2022). The students were given a closed book, closed notes test in drawing FBDs of various objects. Drawing FBDs is a topic the students met in the beginning of

Fall 2021 in an introductory course in engineering mechanics, that includes statics and strength of materials. At the test, the students were physically present, sitting by themselves without the opportunity to receive help from each other or the lecturer. The same test will be repeated in January 2023 for the new students enrolled in the same study program. Moreover, interviews with the new students will be conducted in Fall 2022, right after they are introduced to FBDs. The subject of the interviews is to explore the students' experiences and obstacles in learning the concept of FBD. In the years 2018-2021, the first author used Problem-Based Learning (PBL) as a method to teach the basic concepts of the course. The PBL implementation in the course is fully described in Abou-Hayt et al. (2020). The textbook by Hibbeler (2019) is used throughout the course, in addition to notes and slides, which are made accessible on Aalborg University's learning management system, *Moodle*. The course problems were deliberately chosen in such a way that, on the one hand, they were *related* to the students' first semester project, where they should design (or redesign) equipment for a playground for children, and on the other hand, all the central topics of statics and strength of materials were represented in the questions asked in the formulation of the problems (Abou-Hayt et al., 2020).

The participants of the test are 23 out of 33 1<sup>st</sup> year students, enrolled in the "Sustainable Design" engineering bachelor study program at Aalborg University. The students have already followed a PBL-implemented course in statics and strength of materials in Fall 2021, and were chosen for convenience, since the first author is also their instructor in the course. Not all students in the class were present for the test, as participation in courses is not mandatory. The test was part of an exam brush up session, and it can therefore be assumed that students who felt in need of a brush up would attend. The test given was anonymous; it consisted of six figures of various objects and the students should draw the FBD of each, by hand. The duration of the test was 15 minutes. The first author told the students that the aim of the test was to investigate how well they still *remember*, *understand*, and *apply* (Anderson & Krathwohl, 2001) the principles and methods of drawing FBDs as well as to *improve* the future teaching of the course. In view of this, the first author has got permission from the students to use the tests for research. A correct FBD for each object is worth one point, giving a total of **6** points for the whole test. Each object has two constraints. If the forces or moments are drawn correctly on only one constraint, the student will get a half point. If a support requires two forces and the student draws only one, no credit will be given. The responses of the students were collected and graded, and the students' scores were analyzed using descriptive statistics. The results of the tests would also function as feedback for the instructor on how to improve the teaching and learning of FBDs in the next offering of the course. The objects of the test are shown in Figure 1.

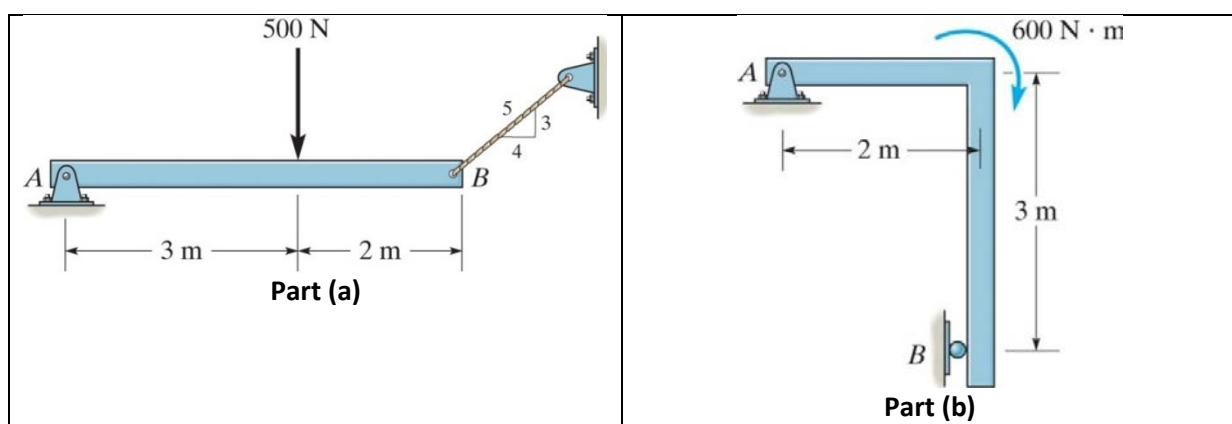

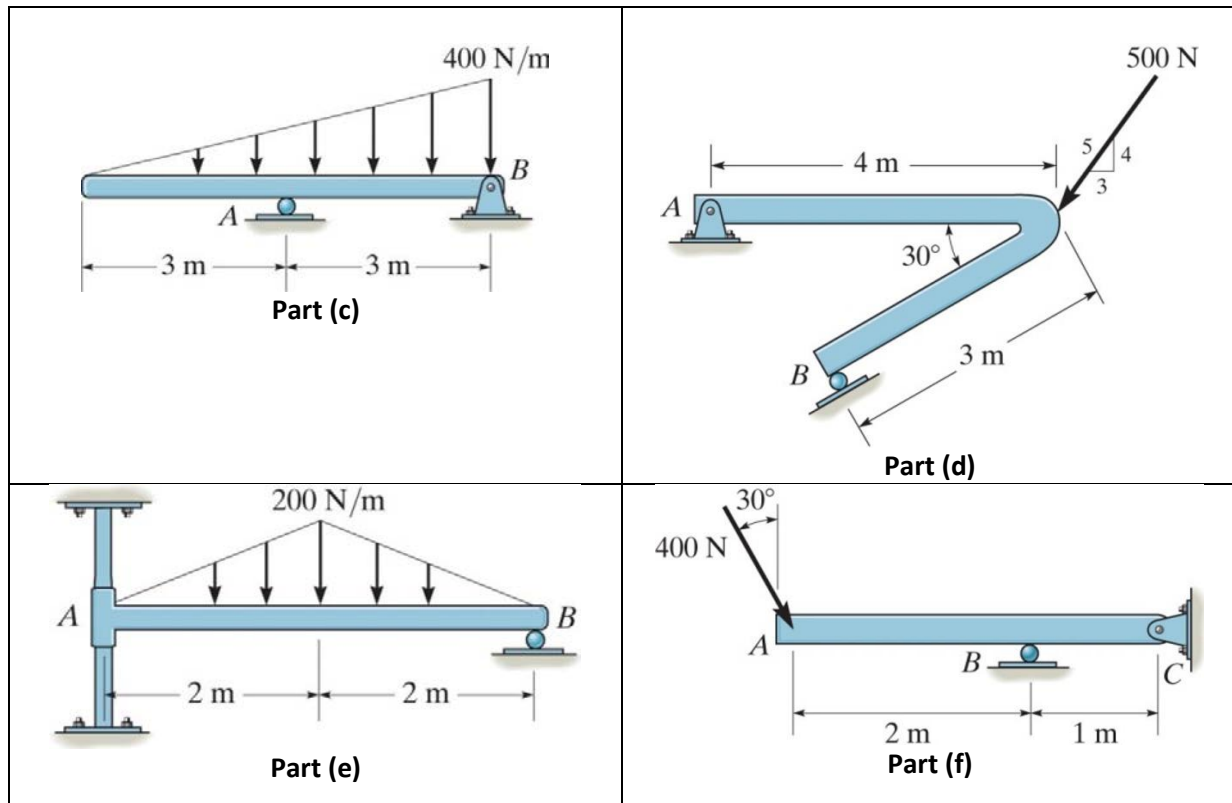

Figure 1: The six parts of the test given to the students.

In addition, the test will also be used to analyze the students' lived knowledge of FBDs as well as to enable us to see if the students had any a long-term retention of the knowledge of FBDs, since a test given directly after the lesson is not an indicator of long-term change in the students' experience. The objects of the test were deliberately chosen so that they involve the most used types of supports and connections encountered in engineering practice. Moreover, drawing the FBDs of these supports and constraints is a prerequisite for a successful application of the equations of equilibrium in engineering mechanics.

## 4 Results

The test is graded according to the scheme mentioned above. The performance of the students is shown in Table 1 and Table 2. The results show that many students still can remember drawing FBDs and most of them are able to differentiate between the different kinds of constraints and supports given.

Table 1: Students' performance on the individual parts of the test.

Part	Number of students who score 1	Number of students who score 0.5	Number of students who score 0	Average
(a)	10	11	2	67%
(b)	16	5	2	80%
(c)	16	6	1	83%
(d)	16	5	2	80%
(e)	2	19	2	50%
(f)	15	7	1	80%

In Table 1, we notice that only very few students scored 0 points at any parts of the test and that the average score is quite high, apart from part (e).

Table 2: Students' performance on the whole test.

Number of students	Average student score per part	Average student grade of the test	Standard deviation of the average grade
23	73%	4.4	0.1163

Table 2 showed the overall student performance on the test, which with 73% and an average grade of the test as 4.4 (scale 1-6), would on average have given the students a high mark, had this been a regular exam. Only two students managed to answer part (e) correctly. They are also the same students who got full score on the whole test. As seen from Table 1, most students failed to realize that the collar in part (e) exerts a couple moment on the rod  $AB$ , in addition to a reaction force. In addition, many of them thought that the rod on which the collar slides is part of the object in interest and have drawn a FBD for the whole system. It may be the case that those students have misunderstood our question: "Draw the free-body diagram of each object". They may have thought that we meant the whole figure.

Meyer and Land make the strong claim that threshold concepts are troublesome to learn, *absolutely*. However, our initial results could not verify that the difficulties the students may have in drawing FBD, are due to the *concept* of FBD. Nor could we find that FBDs are *intrinsically* difficult to learn and *inherently* troublesome for *all* students. In fact, the students taking this test got a quite good result, also considering that these students might be the ones who felt the need to attend this exam brush up session. Rather, our study shows that the difficulties that some students encounter in drawing FBDs are normal didactical challenges of teaching *core concepts* as well as about the abilities of individual students to grasp these concepts. The results also show that troublesomeness in FBDs is a student-relative attribute and that students in a PBL-setting seem to have been able to reduce it. If troublesomeness can be gradually reduced by improved teaching methods, or by being taught in another type of educational setting, can it still be a major, defining characteristic of a threshold concept?

## 5 Discussion and conclusion

Meyer and Land (2003) mention a series of examples of threshold concepts. They claim that the concept of *limit* in mathematics is a threshold concept (p. 3). They report that mathematicians themselves were aware of the issues that surround the concept of limit, referring to them as *epistemological obstacles*. These obstacles are related to the historical development and formalization of the concept of limit. It may be in place to mention that we dealt with this same concept of limit in Abou-Hayt et al. (2019). We have used both PBL and another well-established educational theory, namely the Theory of Didactical Situations (TDS) Brousseau (2006) to tackle the epistemological obstacles of the concept of limit. This is another example of the success of PBL in taming the so-called threshold concepts. In TDS, the instructor *engages* the students by *designing* didactical situations that enable the students to overcome the epistemological obstacles (Artigue et al., 2014). If a threshold concept is identical with an epistemological obstacle, what then is the difference between a threshold concept and a core concept? Isn't the "discovery" that the limit of a function is a threshold concept just old wine in new bottles?

Our study showed that on almost all items, the students scored very high on the test taken some time after the students had followed a PBL-based course teaching them about FBDs. Is this then evidence that PBL was the primary reason of their successful learning? Without an actual randomized experiment with control group, one cannot conclude this with any certainty, however we wish to argue that our study is existence-evidence of undergraduate students successfully learning the presumable threshold concept FBD in engineering mechanics through a PBL-based course. Furthermore, given that the test was given to the students a long time after the teaching is over, this suggests that the PBL-driven instruction in FBDs had a positive long-term effect on the students' knowledge. The difficulty that some students have with conceptual material is familiar to all teaching practitioners and it is of course important that educators know those concepts that cause student difficulty in understanding them. The question is on what grounds we think that

student difficulty is something about the concepts rather than something about the individual student ability. For, we cannot directly observe whether a student has grasped the content of a concept, since our mental life is hidden from the public. Rather, we can only infer that the student has done so.

The limitations of our study are that our sample of students are relatively small and furthermore, future interviews with students might reveal more of their learning process and understanding of, or lack of, FBDs. Also, as stated above, a randomized experiment comparing students being taught using PBL-methods with students being taught applying other teaching methods, might yield to which extent PBL is the best/better method. However, the purpose of our research is not to find out, which is the best method of teaching FBDs, but to find out if students relatively long time after a PBL-inspired course, should a level of understanding of drawing FBDs that makes it reasonable to assume that the drawing of FBDs is not a threshold concept; at least to the extent that it warrants further study.

In conclusion, we could not verify that drawing FBDs is a threshold concept. And as Salwén (2019) rightly points out, “proponents of threshold concepts have neither provided a clear definition of ‘threshold concept’, nor presented any clear idea of what explanatory role threshold concepts are supposed to play” (p. 47). Therefore, our study also points to the need for further clarification of the concept of threshold concepts. Moreover, the study also suggests that PBL is appropriate to help the students in learning threshold/core concepts such as FBDs in engineering mechanics. We believe that the success of PBL is not unique to drawing FBDs but can be generalized to the whole course, as shown in Abou-Hayt et al. (2020). Finally, the test revealed that the students’ *lived knowledge* of FBDs is still consistent with what the first author initially intended the students to learn.

## 6 References

- Abou-Hayt, I., Dahl, B., & Rump, C. Ø. (2019). Teaching the limits of functions using The Theory of Didactical Situations and Problem-Based Learning. In *SEFI Annual Conference: Complexity is the new Normality* (pp. 58-69). SEFI: European Association for Engineering Education.
- Abou-Hayt, I., Dahl, B., & Rump, C. Ø. (2020). A Problem-Based Approach to Teaching a Course in Engineering Mechanics. (A. Guerra, J. Chen, M. Winther, & A. Kolmos, Eds.) *Educate for the future: PBL, Sustainability and Digitalisation 2020*, pp. 499-509.
- Anderson, L. W., & Krathwohl, D. R. (2001). *A taxonomy for learning, teaching, and assessing: A revision of Bloom's taxonomy of educational objectives*. Longman.
- Artigue, M., Haspekian, M., & Corblin-Lenfant, A. (2014). Introduction to the theory of didactical situations (TDS). In *Networking of theories as a research practice in mathematics education* (pp. 47-65). Springer, Cham.
- Askehave, I., Prehn, H. L., Pedersen, J., & Pedersen, M. T. (2015). PBL: Problem-based learning. *Aalborg University*.
- Barrows, H. S., & Tamblyn, R. M. (1980). *Problem-based learning: An approach to medical education* (Vol. 1). Springer.
- Brousseau, G. (2006). *Theory of didactical situations in mathematics: Didactique des mathématiques, 1970–1990* (Vol. 19). Springer Science & Business Media.
- Doody, J. (2009). *A longitudinal evaluation of the impact of a problem-based learning approach to the teaching of software development in higher education*. (Doctoral dissertation, Durham University).
- Hibbeler, R. C. (2019). *Statics and Mechanics of Materials* (Fifth ed.). Pearson.
- Kullberg, A., Kempe, U. R., & Marton, F. (2017). What is made possible to learn when using the variation theory of learning in teaching mathematics? *ZDM*, 49(4), 559-569.

- McCarthy, T. J., & Goldfinch, T. (2012). Assessing students understanding of the concept of free body diagrams using online tests. *Edulearn 4th International Conference on Education and New Learning Technologies*, (pp. 1-10).
- Meyer, J., & Land, R. (2003). Threshold concepts and troublesome knowledge: Linkages to ways of thinking and practising within the disciplines. In C. Rust (Ed.), *Improving student learning theory and* (pp. 412-424). Oxford: OCSLD.
- Meyer, J., & Land, R. (2005). *Overcoming barriers to student understanding*. Taylor & Francis Limited.
- Prusty, B. G., & Russell, C. (2011, August). Engaging students in learning threshold concepts in engineering mechanics: adaptive eLearning tutorials. In *17th International Conference on Engineering Education (ICEE)* (pp. 21-26).
- Rosengrant, D., Van Heuvelen, A., & Etkina, E. (2009). Do students use and understand free-body diagrams? *Physical Review Special Topics-Physics Education Research*, 5(1), 010108.
- Salwén, H. (2019). Threshold concepts, obstacles or scientific dead ends? *Teaching in Higher Education*.
- Savin-Baden, M., & Tombs, G. (2018). *Threshold Concepts in Problem-based Learning*. Brill Sense.
- Shryock, K. J., & Haglund, J. (2017). Instrument for assessing skills related to free body diagrams in a sophomore engineering mechanics course. In *2017 ASEE Annual Conference & Exposition*.
- Zepke, N. (2013). Threshold concepts and student engagement: Revisiting pedagogical content knowledge. *Active Learning in Higher Education*, 14(2), 97-107.



# Work-in-Progress: ‘clear’ - A value-based approach towards overcoming resistance to change and adapting student-centred classroom practices in engineering education

Lelanie Smith

University of Pretoria, South Africa, [lelanie.smith@up.ac.za](mailto:lelanie.smith@up.ac.za)

Jaco Fourie

Curiosity Campus, South Africa

Karin Wolff

University of Stellenbosch, South Africa, [wolffk@sun.ac.za](mailto:wolffk@sun.ac.za)

## Summary

Change management in any environment is difficult. There are always pioneers and early adopters, but the process of creating critical mass towards positive change is often slow or does not happen. Higher Education Institutions are not different, and changes that have been required (shift to student-centred teaching) before the pandemic have now been accelerated. Institutional leaders are often quick off the mark to change the mandate of what they want to see, but the change is not integrated or connected to the staff members in the classroom which can lead to frustrated, disconnected and overwhelmed staff. The increasing demand on academics to develop critical competencies demanded by current and future societies and their responsibility to become change agents in the classroom (facilitators of learning) is often met with resistance. In this work we share the first phase of a change management framework called ‘clear’ towards igniting the need for change and in so doing opening up the conversation around a holistic, individual, sustainable process of comfort with change and a willingness and curiosity towards the change. The framework draws from a wide variety of disciplinary fields including philosophy, neuro-semantic, and design and systems thinking. We share the first phase and the translation to a workshop to start the conversation in an Engineering Department or School.

**Keywords:** student-centred learning, change management, facilitator, systems thinking, neuro-semantic

**Type of contribution:** Research extended abstracts

## 1 Introduction

The challenges around rapid technological development, complex changes in society and the workplace has led to a sense of urgency in Higher Education (HE) towards transformation (Graham, 2018;2022; Supendi & Nurjanah, 2020). Student success rates and academic staff’s ability to maintain a balanced workload in South African HE under these demands has been exacerbated by the impact of the pandemic. In Engineering the focus is on authentically developing the prescribed graduate attributes put forth by the Engineering Council of South Africa, which translates to “systems-, critical and anticipatory thinking, integrated problem-solving and collaboration, all of which contribute to a life-long learning perspective” (Klotz, et al., 2014; Oberrauch et al., 2021; Du et al., 2022). If university educators are to become developers of young engineering professionals that are ready for the challenges of the 21st century, they need to adopt new pedagogical approaches and models, such as social and active learning (Rieckmann et al., 2017; Oberrauch et al., 2021; Chen et al., 2021; Stenalt & Lassesen, 2022).

Academic staff in research-intensive SA institutions are primarily considered to be knowledge creators (Badat, 2010). This identity and priority are reinforced by the institutional focus on publications over

education. Although education is advocated to be equally important in some cases, this is not necessarily reflected in how staff are evaluated or valued/rewarded (Olsson & Roxå, 2013). The split in identity between knowledge creators and developers of young professionals is not always part of a discussion or integrated into institutional culture. The one identity requires the individual to be an expert and authority in their technical field, the other requires them to be a facilitator with a range of refined socio-cultural development skills to guide a student towards becoming an engineer. These two identities are often further conflicted by context and agendas of specific institutions and departments. The unconscious bias towards the academic's research mandate may lead to inefficient and uninformed (even though well intentioned) classroom practices which may be exacerbated by poor student engagement and feedback. The psychological burden of such engagement, high workloads and insufficient support can cause academics to become overwhelmed and despondent (Czerniewicz et al., 2020).

The current generation is predicted to require far more support towards developing maturity levels due to the strong reliance and dependence on technology (Twenge, 2017). Twenge (2017) writes that there is an inability to understand or interpret expectations, identify and respond to nuanced interpersonal behaviour and discernment of inherent value. Although this is not the case for all students, the reality is that the modern world with its strong technological dependence requires a stronger affective intervention towards supporting the student's role towards becoming a professional. The academic guide is required, as a consequence, to become a facilitator - rather than a direct instructor - of socio-cultural learning processes which enable the holistic development of graduates with the requisite knowledge, skills and attributes for legitimate socio-technical participation (DHET, 2013).

There are many well-established pedagogical approaches to move towards a different classroom practice. In this paper, we argue that despite the well-intended mechanistic policy measures designed to encourage academics to balance their different roles, it is through organic - ground-up - strategies (Durkheim, 2010) that academics can be supported in becoming effective facilitators of holistic student development. We believe the staff member has to want to make the shift for it to be integrated and sustained. In an academic landscape where staff are not only strongly attached to a professional engineering identity but also that of an independent academic, the complex contexts may offer little opportunity for reflection on how to navigate these identities. The focus of this work is to develop and test a framework that draws from coaching tools towards "waking up" participants to the reality of their experience in order to be able to open up and to start to let go of what no longer works in their current state.

Participants in a Higher Education ecosystem may have the intention or desire to make a positive impact, but often with very limited clarity on how to do so or why the effort towards doing so is not successful. In order to facilitate transformation in the broader socio-cultural and socio-technical environments, we need to first become inspired and guided to facilitate such a transformation as individuals. This work is guided by the question:

*How can we inspire/motivate an awareness and urgency for change in identity from knowledge creator – educator – facilitator?*

## 2 Progress on development of a framework

Although the larger framework that will lead to catalyst for the sustainable systemic change will draw from a series of techniques found in awareness practices (journaling, reflecting, meditation, walking in nature etc), gestalt therapy, neuro linguistic programming (NLP), theory-U, systems team coaching, design and systems thinking and brand communication, the first phase is developed with the focus on design and systems thinking and neuro-semantics.

## 2.1 Philosophy

The process of moving from confusion, frustration, resistance towards clarity requires facilitation. The 'clear' process is a confluence of frameworks and principles within a range of different methodologies and fields. In philosophy (Stumpf, 1979) questions around definition, identity, purpose, responsibility is used across psychology, coaching, consulting, and many more in the attempt to facilitate clarity. These are some of the fundamental questions which are used in the 'clear' process. It is the starting point of the process, and the challenge lies in that we are not able to answer these questions immediately or with clarity, which can lead to being stuck, frustrated or confused. Therefore, the facilitation of this process requires a state shift to hold the mindset of curiosity leading us to open up towards the change that wants/needs to happen in us individually as well as collectively.

## 3.2 Neuro-Linguistic-Programming and Neuro-Semantics

Neuro-Semantics allows us to articulate and work with the higher levels of meaning for detailed human processing and experience (Hall, 1996). It gives us a way of thinking about our experience and to work with our nervous system (neurology) and mind (linguistics) to create meaning, evaluate events and experiences and assign significance (semantics). The mind can reflect on itself and then reflects on that first reflection, and then reflects on the second - and it can continue to do this without ever reaching an end to the process, this is called human consciousness reflexivity (Hall et al., 2001). This process is what enables us to 'step back' from ourselves to witness our own experiences and respond as we choose to. It gives us the power to rise above our circumstances, challenges and ultimately live from our highest level of intention and responsibility within alignment of who we are (Linder-Pelz & Hall, 2008). It is a combination of these principles and strategies that we draw on in this study to facilitate change in our engineering academic communities.

## 3 Context of Study

The Engineering Council of South Africa (ECSA) is the local accreditation body that aligns its processes to the International Engineering Alliance (IEA). The transition in accreditation away from knowledge-based outcomes to graduate attribute outcomes has not systematically been integrated into SA University practices and as a consequence, the demands on individual lecturers who are responsible for developing complex competencies have escalated. Specifically, the attributes relating to independent learning, teamwork, professionalism, social responsibility and communication have become challenging for an academic with a PhD in Engineering Science to facilitate and ensure the development of these aspects in the student. There are some that continue to develop or connect to engineering education research to change their approach in the classroom, but the large majority find themselves overwhelmed and unsupported. It is against this background that an internationally collaborative project was established to enable engineering academics in South Africa to actively participate in innovating their curriculum and pedagogic practices ([www.iecurriculum.co.za](http://www.iecurriculum.co.za)) through becoming more proficient in the broader professional competencies required of both themselves and their future engineering graduates. A fundamental component often overlooked in curriculum development is the development and preparation of the academic staff members that will be responsible for the teaching.

## 4 Application of method: A pilot study

The focus of this paper is the first step in the larger 'clear' process referred to as 'waking up'. In order for the individual to start the reflection, the context of the environment where they are stuck/struggling is framed. In the South African Engineering Academic context, we start with what is expected of us from the accreditation body (ECSA) to develop our students. We explore the ecosystem of our higher education through talking about our programmes, the demands on academics and the conflicting roles and responsibilities they have and who our students are. It is critical that in framing the context, it is linking the states of 'stuckness' and the overwhelming reality of the expectations in the environment. Often hearing this

will lead participants to become overwhelmed as they notice this for the first time or it could lead them to become calm, understanding they are not alone.

It is important for the facilitators here to move the potential resistance or awareness of being overwhelmed with a tool that can enable becoming more open and curious about their 'stuck' state. A coaching tool match/mismatch is used to open the space for open reflection from participants. This phase requires contextually relevant questions drawn from Stumpf (1979) to guide the individual to: What is it? (Definition); Who am I? (Identity); Why am I here? (Purpose); How do I respond? (Responsibility). In the case of the engineering academic identity, the question is asked: "What is the ideal classroom experience?" and the request to participants is to describe the visual, auditory and kinesthetic components. The first 90 min session is closed through reflecting on what the individual can do immediately and what steps can lead them closer to where they would want to end.

## 5 Status and Future Work

Currently phase 1 has successfully been piloted at one local conference, two institutions and one international conference. Generally, the feedback has been that staff and student expectations of the classroom engagement are very misaligned. Staff typically want students to be curious, engaged and bursting with anticipation to learn about the specific knowledge area the staff member has to offer. Students mainly asked for a stronger contextualisation of knowledge areas to what they will do as engineers as well as more work integrated practices to understand what their professional identity is and how the classroom engagement is playing a part in forming that. The first step already provides participants with a sense of belonging through the collective challenges we face and also with some small steps towards resolving the challenges. The subsequent phases are already developed and are currently being contextualised for Engineering Educators. The following phases will be completed early in 2023.

## 6 References

- Badat, S. (2010). The challenges of transformation in higher education and training institutions in South Africa. *Development Bank of Southern Africa*, 8(1), 1-37.
- Chen, J., Kolmos, A., Guerra, A., & Zhou, C. (2021). Academic Staff's Motivation, Outcomes and Challenges in a Pedagogical Training Programme of PBL. *International Journal of Engineering Education*, 37, 900–914.
- Czerniewicz, L., Agherdien, N., Badenhorst, J., Belluigi, D., Chambers, T., Chili, M., de Villiers, M., Felix, A., Gachago, D., Gokhale, C., Ivala, E., Kramm, N., Madiba, M., Mistri, G., Mgqwashu, E., Pallitt, N., Prinsloo, P., Solomon, K., Strydom, S., Swanepoel, M., Waghid, F. & Wissing, G. (2020). A wake-up call: Equity, inequality and Covid-19 emergency remote teaching and learning. *Post digital Science and Education*, 2(3), 946-967.
- DHET (2013). White Paper for Post-School Education and Training: Building an expanded, effective and integrated education and Training system. Pretoria: Department of Higher Education and Training.
- Du, X., Guerra, A., Nørgaard, B., Chaaban, Y., Lundberg, A., & Lyngdorf, N.E.R. (2022). University Teachers' Change Readiness to Implement Education for Sustainable Development through Participation in a PBL-Based PD Program. *Sustainability*, 14(19).
- Durkheim, E. (2010). From mechanical to organic solidarity. *Sociology: Introductory Readings*, 2(1).
- Graham, R. (2018). The global state of the art in engineering education. Massachusetts Institute of Technology (MIT) Report, Massachusetts, USA.
- Graham, R. (2022). Crisis and catalyst: The impact of COVID-19 on global practice in engineering education.
- Hall, L.M. (1996). *Languaging: The linguistics of psychotherapy. How language works psycho-therapeutically: an exploration into the art and science of" therapeutic languaging" in four psychotherapies (neuro-linguistic programming, reality therapy, rational-emotive behavior therapy, logotherapy). Using general-semantic formulations.* The Union Institute ProQuest Dissertations Publishing.

- Hall, L.M., Bodenhamer, B.G., Bolstad, R., & Hamblett, M. (2001). *Structure of Personality*. Crown house publishing.
- Klotz, L., Potvin, G., Godwin, A., Cribbs, J., Hazari, Z., & Barclay, N. (2014). Sustainability as a Route to Broadening Participation in Engineering. *Journal of Engineering Education*, 103, 137–153.
- Linder-Pelz, S., & Hall, M. (2008). Meta-coaching: a methodology grounded in psychological theory. *International Journal of Evidence Based Coaching & Mentoring*, 6(1).
- Oberrauch, A., Mayr, H., Nikitin, I., Bögler, T., Kosler, T., & Vollmer, C. (2021). “I Wanted a Profession That Makes a Difference”—An Online Survey of First-Year Students’ Study Choice Motives and Sustainability-Related Attributes. *Sustainability*, 13(15), 8273.
- Olsson, T., & Roxå, T. (2013). Assessing and rewarding excellent academic teachers for the benefit of an organization. *European Journal of Higher Education*, 3(1), 40-61.
- Rieckmann, M., Mindt, L., & Gardiner, S. (2017). *Education for Sustainable Development Goals. Learning Objectives*; United Nations Educational, Scientific and Cultural Organization: Paris, France.
- Stenalt, M.H, & Lassesen, B. (2022). Does student agency benefit student learning? A systematic review of higher education research. *Assessment & Evaluation in Higher Education*, 47(5), 653–669.
- Stumpf, S.E. (1979). *Elements of Philosophy: An Introduction*. McGraw-Hill College.
- Supendi, A. & Nurjanah, N. (2020). Society 5.0: Is it high-order thinking? *In International Conference on Elementary Education*, 2(1), 1054-1059.
- Twenge, J.M. (2017). *iGen: Why today's super-connected kids are growing up less rebellious, more tolerant, less happy and completely unprepared for adulthood and what that means for the rest of us*. New York, NY: Atria.

# The Complexity of Engineering Education in a Mission Driven PBL University

Louise Møller Haase

The technical faculty of IT and Design, Aalborg University Denmark,  
[prodekan-tech-udd@aau.dk](mailto:prodekan-tech-udd@aau.dk)

Jette Egelund Holgaard

Aalborg Center for PBL in Engineering Science and Sustainability under the auspices of UNESCO, Aalborg University, Denmark,  
[jeh@plan.aau.dk](mailto:jeh@plan.aau.dk)

Anette Kolmos

Aalborg Center for PBL in Engineering Science and Sustainability under the auspices of UNESCO, Aalborg University, Denmark,  
[ak@plan.aau.dk](mailto:ak@plan.aau.dk)

## Summary:

In this extended abstract, we will argue that education in a mission driven university holds particularities that call for the transformation of not only the research base of education but also the way in which education is conceptualised and practiced. Following a PBL approach, we put the students in the centre of educational activity and propose a conceptual framework for engineering education in a mission driven PBL university.

**Keywords:** Mission driven, student roles, management of change

**Type contribution:** Research extended abstracts, conceptual paper

*“To find a way to bring together the triple objectives of smart innovation-led growth, inclusion and sustainability, we must first answer the critical question of how to direct innovation to solve the pressing global challenges of our time” (Mazzucato, 2018b, p. 2).*

Mazzucato (2018b) presented a mission-oriented approach to research and innovation as a response to the aforementioned question. The overarching research question for this extended abstract is: What does education in a mission driven university imply?

## 1. The mission driven organisation – the mission driven university

The tendency for organisations to have a declared mission as an overall trajectory for how they will achieve their visions is not a new one, especially for larger companies. However, due to increasingly urgent global and grand societal challenges, the mission driven approach has gained more attention. Cipriani et al. (2020) defines mission driven organisations as organisations that manage to generate financial returns alongside social and/or environmental returns. Example of environmental and social impacts are those that foster a sustainable development, as highlighted by the sustainable development goals agreed upon at the United Nations General Assembly in 2015, to be achieved in 2030.

Mazzucato (2018a) argues that mission driven organisations have much to learn from mission-oriented programmes for innovation policy. Mission driven programs are turning ‘wicked’ societal problems into concrete problems that drive innovation across multiple actors and sectors, enabling bottom up experimentation and learning, and encouraging the diffusion of results (Mazzucato, 2018a). However, like the problem, the problem-solving approach is also ‘wicked’. Mission driven organisations operate on potentially paradoxical strategies that pursue both social and economic objectives (Cipriani et al., 2020).

The social focus emphasises social innovation business models with key characteristics such as conflicting goals, multiple value propositions, context dependency and a call for de-facto hybrid organisations (Cipriani et al., 2020).

The mission-driven approach is about developing clear-targeted missions based on grand challenges, and a portfolio of projects and bottom-up experimentations can be developed for each mission; relevant cross-disciplinary, cross-sectoral, and cross-actor innovations can also be established (Mazzucato, 2018a, 2018b). Consequently, the mission driven organisation acknowledges that grand challenges cannot be resolved by one sector, one organisation or one discipline, and thus more formal partnerships are encouraged to manage the complexity of dependencies across institutional and national borders.

Challenges, be they environmental, democratic, economic or social, have entered innovation policy agendas as key justifications for actions and strategies for funding policies and innovation efforts (Mazzucato, 2018a, p. 804). Universities have adopted the mission-oriented approach to research and innovation, and some universities have taken a more systemic approach and highlighted the mission driven approach as a strategic core for the whole university. This is the case for Aalborg University, Denmark, where the problem and project based (PBL) approach (Kolmos & Graaff, 2014) resonates with the focus on wicked problems in the mission driven approach.

In this conceptual extended abstract, we will argue that education in a mission driven university holds particularities that call for a specific strategic concern. We will use different lenses on students to outline potential alignments and educational pitfalls when transforming to a mission driven university; see Figure 1.

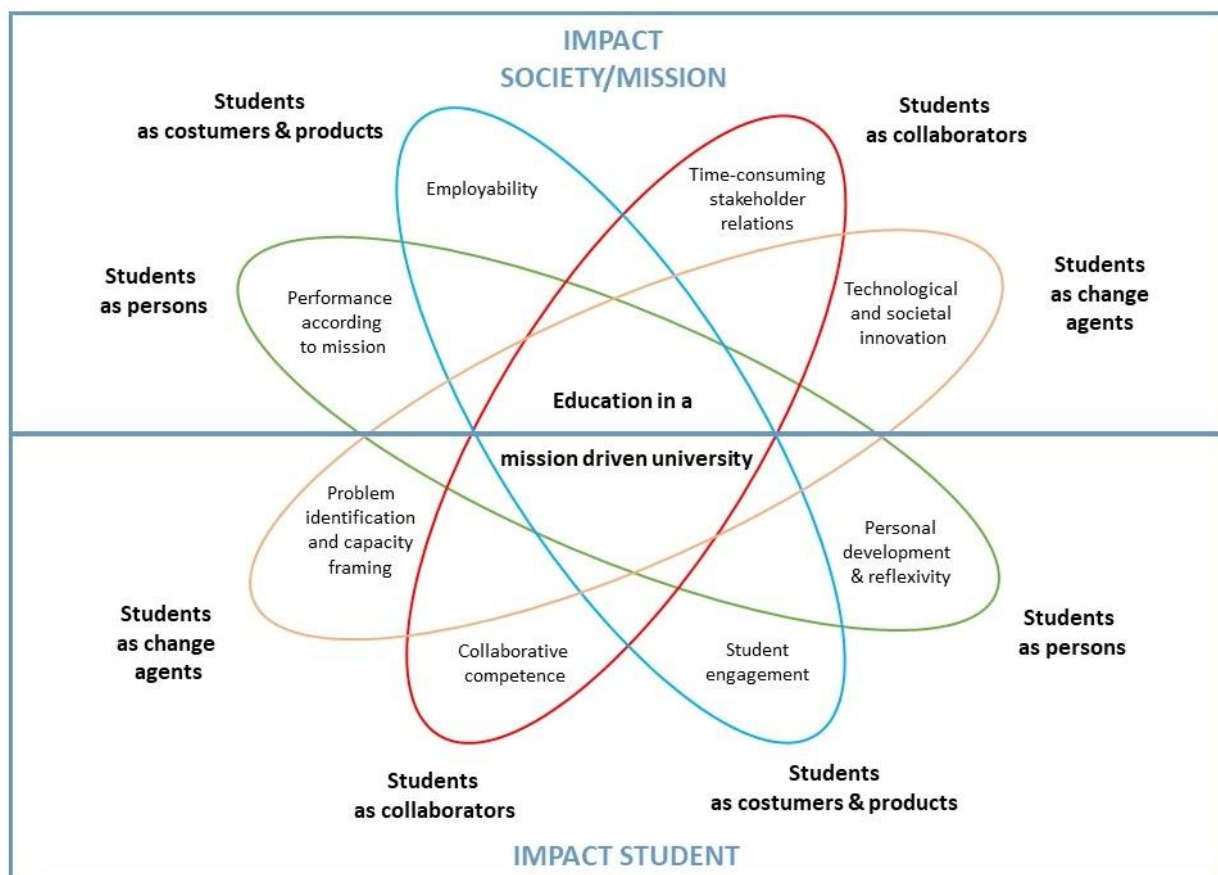

Figure 1: Student roles and the key aspects of education in a mission driven university

As illustrated in Figure 1, students are characterised as change agents (transformation discourse), collaborators (social interaction discourse), costumers & products (market discourse), and persons (individual discourse) with reference to both their impact on society/mission and themselves. These lenses point to core aspects of education in a mission driven PBL university. In Sections 2 to 5, we will elaborate on these aspects in relation to the different student roles.

## 2. Students as change agents

In a mission driven approach to education, students should be enabled to serve as change agents, influencing innovation-decisions aligned with the intended mission. A change agent is an individual who influences clients' innovation-decisions in a direction deemed desirable by a change agency (Rogers, 1995, p. 27). Other definitions of agency underline the influence of the socio-cultural framing of agency, which resonates with the mission driven incentives to reinforce societal change. From this perspective, agency can be defined as the sociocultural mediated capacity to act (Ahearn, 2001, p. 112).

There are many definitions related to the concept of change agency, but crosscutting aspects are the ability to act and impact. As noted by Barnett, public policy has constructed students as an active being more than a cognitive being, and from that emerges 'the performative student' (Barnett, 2009, p. 430):

*"This student is replete with 'transferable skills', contemplates with the equanimity the prospect of multiple careers in the lifespan, is entrepreneurial and has an eye to the main chance, and possesses a breezy self-confidence in facing the unpredictability that characterizes contemporary life."*

Adding change agency to the performative student means that the ability to demonstrate impact becomes a (perhaps tacit) part of the curriculum. According to Negt (1968), learning should exemplify relevant societal, material and social constructs and, with reference to Mills (1959), he stressed the importance of sociological imagination – to think of society in new ways. This principle of exemplarity shows that the active being, as a student or a citizen, is fundamentally reliant on cognitive abilities to decide what is relevant and imagining what could be. In a PBL environment that emphasises exemplary learning, abilities to analyse the problem from different angles and in different contexts are needed to make informed decisions towards a mission. A pitfall of the urgency of change would be to move directly to act and impact, whilst neglecting the cognitive dimensions to make sense of complex sociocultural systems. Another pitfall emerges if the mission is not firmly related to technological innovation as the core of engineering.

## 3. Students as collaborators

As previously mentioned, missions derived from grand challenges cannot be solved by one sector, one organisation or one discipline, and so partnerships are encouraged to manage the complexity of dependencies across institutional and national borders. In a PBL environment, it is thereby not enough to prepare students to collaborate and co-create in disciplinary teams to develop what Katzenbach and Smith (1993) call real or even high performing teams. Students should also be enabled to work across disciplines and collaborate across boundaries through a variety of stakeholder interactions. They should be able to work in interdisciplinary teams and in networks of teams, and they should also be able to initiate and maintain cross-institutional collaborations and partnerships. Wenger (1998) presented a social learning theory to establish such relations in the interaction between different Communities of Practice (CoP).

Borrowing the notion of boundary objects from Star (1989), Wenger (1998) draws attention to the objects that serve to coordinate the perspectives of various CoPs. Boundary objects being artifacts, documents,



terms, concepts or other forms of reification can organise interconnections (Wenger, 1998). In a mission driven approach, a policy paper, a mission statement or a combustion plant are examples of boundary objects that will initiate, maintain and structure active participation. When missions have led to projects, a stated problem, a Gantt chart or a business model, among others, can act as boundary objects. In a problem and project-based environment, the stated problem and project plans become overall boundary objects. Project structures can be conceptualised in different project types with different levels of interdisciplinary connections and network relations (Kolmos et al., 2020).

Wenger (1998), however, stressed that multi-memberships of different CoPs would provide the opportunity to introduce and transfer elements from one practice into another through brokering. The brokering process is complex and involves processes of translating, coordinating and aligning perspectives, and brokers have to avoid being rejected in other CoPs as intruders, or being pulled in as a full member (Wenger, 1998). It takes significant energy to be a broker, and it might be easier to adopt some reifications from other CoPs and 'get the most out of it'. Therefore, there has to be a reason to invest and there should be a clear sense of the expected outcome. The mission-driven approach to education might provide such reasons, and a proactive PBL institution might provide the conditions for working across teams and across disciplines. A potential pitfall is, however, if students are not formally credited in proportion to the energy they have put into their boundary work.

#### **4. Students as costumers and products**

As noted by Anctil (2008), the challenge of the mission driven university is to position the university as a social institution with missions dedicated to the public good, while at the same time remaining competitive. Furthermore, universities have to manage the fact that students are both consumers and products all together (Anctil, 2008). On the one hand, universities have to brand themselves in order to recruit and retain students, and outcomes are measured by the number of students, dropout rates and level of satisfaction with faculty support. On the other hand, students are themselves products, labelled by their diploma and evaluated by their employability.

Whereas students can be considered as costumers and products, they are not to the same extent under management control compared to employees in an organisation. The formal power is restricted to curriculum structures, which is, at least in a European context, designed to outline intended learning outcomes in terms of knowledge, skills and competences (Commision, 2008). Perceived as products, students can be seen as containers of learning outcomes designed to react to a certain societal need or potential. In a PBL environment, the question is, however, what kind of need or potential the students will use to exemplify how their knowledge, skills and competences are put into play.

A given mission driven approach might be welcomed by some students and challenged by others; indeed, it might seem to motivate some disciplines and encounter resistance in others. When a mission is acknowledged, the mission has to be matched with the learning outcomes in the curricula. In engineering education, students might narrow down the mission to a certain technological response, and it can be an internal negotiation to settle the blend of attention between technology and mission. The student as a costumer might resign from the push to follow a specific mission, and there needs to be a balance to satisfy diverse needs and positions.

## 5. Students as persons

Teaching students what they need to know and what they should do to master a discipline is one thing, telling them what to think is another, especially in a PBL environment that values self-directed learning and an open curriculum. The diploma and arguments from future employers might motivate some learners to act according to the university-defined missions, but to reinforce more deep learning it is questionable whether personal qualities such as interest and curiosity can be left out of the equation. Students are human beings with dreams, passions and experiences, all of which are put into play in a university context, shaping their being and becoming a student or professional. In other words, students are far more than containers of knowledge, skills and competences.

Barnett (2009) stressed differences between knowing, becoming and being. He suggests that dispositions form a more fundamental human being and includes dispositions like the will to learn and to engage, preparedness to listen and to explore and, finally, a determination to keep moving forward (Barnett, 2009). He also combines dispositions with qualities, which are manifestations of dispositions like resilience, self-discipline, openness and respect for others (Barnett, 2009). Such dispositions and qualities cannot be taught, but they can be facilitated and developed by self-formation (*Bildung*).

Klafki (1999) highlighted the dialectics between individuality and communality in *Bildung*, which align with the mission-driven approach (Klafki, 1999, p. 95):

*“I think that the general or universal in Bildung, a universal that today can or must be defined as binding, will have to focus on problems that are the central concern of us all as well as for generations to come, that is, the key problems of our social and individual existence – at least as far as these problems can be foreseen.”*

Based on Klafki, among others, Sjöström and Eilks (2020, p. 56) define *Bildung* as autonomous self-formation as well as reflective and responsible action in, and in one’s interaction with, society. Such understandings add reflexivity to the understanding of *Bildung*. A potential pitfall is, however, to think that mission driven strategies for research and innovation are sufficient to cover the aspects of personal development and reflexivity. Education also has to be understood as a way to support students in developing *Bildung* on their own (Sjöström & Eilks, 2020).

## 6. Conclusion

In this extended abstract, we have argued that educational aspects add considerable complexity to the understanding of a mission driven university. We have suggested a conceptual framework for understanding education in a mission-driven university, including:

- Students as *change agents* to underline that the mission-driven engineering institutions have to enable students to analyse the ‘wicked’ problems related to a given mission and act accordingly to make sustainable *technological innovations* and *societal change*.
- Students as *collaborators* to stress the need for mission-driven universities to enable students’ ability to interact in *teamwork* and *stakeholder relations* and establish partnerships to address the increasing complexity and dependency in technological innovation processes.
- Students as combined *customers and products* to recognise the basic need for the mission-driven university to secure recruitment, *student engagement* and *employability* to adjust educations to societal needs and maintain the financial capacity to ensure quality education.

- Students as *persons* to stress that the mission driven university should still support students' self-formation (*Bildung*) in terms of their *personal development* as academics, professionals and life-long learners and *reflexivity* relating one's actions to subsequent societal impacts.

There might be other lenses and aspects of education in a mission driven university, and as such the purpose with this paper has not been to present a complete list of aspects to consider. Our point is to argue that education adds to the complexity of the strategic concerns that constitute a mission driven university.

## 7. References

- Ahearn, L. M. (2001). *Language and Agency*, 30, 109-137.
- Anctil, E. J. (2008). *Market driven versus mission driven* (ASHE Education Report, Issue. W. InterScience).
- Barnett, R. (2009). Knowing and becoming in the higher education curriculum. *Studies in Higher Education*, 34(4), 429-440.
- Cipriani, T. K., Deserti, A., Kleverbeck, M., Rizzo, F., & Terstriep, J. (2020). Business models & social innovation: mission-driven versus profit-driven organisations. *International Review of Applied Economics*, 34(5), 541-566.
- Commission, E. (2008). *Explaining the European Qualifications Framework for Lifelong Learning*.
- Katzenbach, J. R., & Smith, D. K. (1993). *The Wisdom of Teams - Creating the High-performance organization*. Harvard Business Review Press.
- Klafki, W. (1999). The Significance of Classical Theories of Bildung for a Contemporary Concept of Allgemeinbildung. In I. Westbury, S. Hopmann, & K. Riquarts (Eds.), *Teaching as a Reflective Practice* (1st Edition ed.). Routledge.
- Kolmos, A., Bertel, L. B., Holgaard, J. E., & Routhe, H. W. (2020). Project types and complex problem-solving competencies: Towards a conceptual framework. International Research Symposium on PBL.
- Kolmos, A., & Graaff, E. D. (2014). Problem-Based and Project-Based Learning in Engineering Education: Merging Models. In A. Johri & B. M. Olds (Eds.), *Cambridge Handbook of Engineering Education Research* (pp. 141-161). Cambridge University Press.
- Mazzucato, M. (2018a). Mission-oriented innovation policies: challenges and opportunities. *Industrial and Corporate Change*, 27(5), 803-815.
- Mazzucato, M. (2018b). *MISSIONS, Mission-oriented Research & Innovation in the European Union, A problem-solving approach to fuel innovation-led growth*. E. Commission.
- Mills, C. W. (1959). *The sociological imagination*. Oxford University Press.
- Negt, O. (1968). *Soziologische Phantasie und exemplarisches Lernen*.
- Rogers, E. M. (1995). *Diffusions of Innovations* (4th edition ed.). Free Press.
- Sjöström, J., & Eilks, I. (2020). The Bildung Theory - From von Humboldt to Klafki and Beyond. In B. Akpan & T. Kennedy (Eds.), *Science Education in Theory and Practice*. Springer Texts in Education.
- Star, S. L. (1989). The Structure of Ill-Structured Solutions: Boundary Objects and Heterogeneous Distributed Problem Solving. *Distributed Artificial Intelligence*, 37-54.
- Wenger, E. (1998). *Communities of Practice - Learning. Meaning, and Identity*. Cambridge University Press.

# Designing a learning dashboard to facilitate project development and teamwork in a CBL physics course

Federico Toschi, Alessandro Gabbana

Department of Applied Physics and Science Education, Eindhoven University of Technology, The Netherlands,  
[f.toschi@tue.nl](mailto:f.toschi@tue.nl), [a.gabbana@tue.nl](mailto:a.gabbana@tue.nl)

Jasmina Lazendic-Galloway

TU/e innovation Space, Eindhoven University of Technology, The Netherlands, [j.lazendic.galloway@tue.nl](mailto:j.lazendic.galloway@tue.nl)

Anneke Boonacker-Dekker, Yvonne Vervuurt

Department of Applied Physics and Science Education, Eindhoven University of Technology, The Netherlands  
[a.a.boonacker.dekker@tue.nl](mailto:a.a.boonacker.dekker@tue.nl), [y.m.j.vervuurt@tue.nl](mailto:y.m.j.vervuurt@tue.nl)

## Summary

There have been, and still are, considerable efforts to stimulate interdisciplinary research to tackle interesting research questions and address some of the complex societal challenges we are facing in the 21<sup>st</sup> century. Therefore, the current STEM education needs to provide opportunities for students to develop an interdisciplinary mindset and to actively engage them in solving societal issues early on during their degree. With these goals in mind, we designed a set of three interdisciplinary courses focused on the physics of social systems, or Sociophysics, using Challenge-Based Learning (CBL) as an instructional approach. Our aim was to offer students the freedom to define their projects while supporting them with a robust framework capable of helping them rapidly define their challenge (via CBL) and efficiently work on it (via Scrum). Since CBL is a new educational framework for most students and it relies on the students-driven initiative, we designed a learning dashboard specifically aimed at providing efficient feedback and supporting the development of students' research and teamwork skills. We found our dashboard to be highly effective in providing both qualitative and quantitative support for students' progress in their self-defined projects, allowing scaling-up of CBL-based educational settings.

**Keywords:** learning dashboard, (peer) feedback, physics education, interdisciplinary education, challenge-based learning;

**Type of contribution:** Best practice extended abstracts

## 1 Designing a CBL course in Sociophysics

To make students aware of the complex interplay between scientific and technological innovation with societal and ethical aspects the USE (User, Society and Enterprise) learning line trajectories were introduced at the Eindhoven University of Technology (TU/e), typically consisting of three subsequent courses across three quartiles (3 x 8 weeks). A good example is the unprecedented availability of data in modern society, which has led to a vast number of applications of physics (e.g., Schweitzer 2018) that require collaboration with other disciplines to produce valid solutions. Therefore, we (led by the first author) designed an elective USE learning line on the physics of social systems, where students are taught how to bring mathematical, physics-based (model-driven), and machine learning (data-driven) modeling approaches together with ethics

and psychology and apply them, for example, to modeling of crowd movement around busy spots in cities (e.g., Pouw 2020). While quantitative approaches inspired by fluid mechanics or statistical physics can be used to model crowd movement, understanding human perception, experience, motivation, and decision-making, as provided by psychological theory and methodology, is needed to improve interpretation and speed up modeling efforts. At the same time, one needs to be knowledgeable of the ethical and legal restrictions when establishing and processing large datasets, especially now that these increasingly tend to cross the threshold of personal privacy.

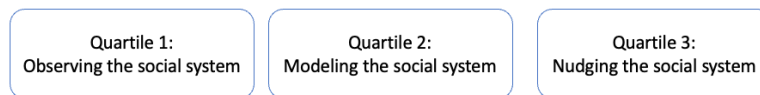

Figure 1: The three Sociophysics courses make up a full learning line focused on solving challenges around safe and efficient crowd control on busy train platforms.

## 1.1 Challenge-Based Learning

The students taking the learning line come from diverse backgrounds, mainly in their second year of study with majors in physics, mathematics, electrical engineering, and computer science. The structure of the three courses is rather similar and students work through each course (over a quartile period) on slightly different aspects of the same project, to be completed at the end of the third course of the learning line (see Fig. 1). For our learning line, it was important to involve a societal stakeholder (in this case, a railway company) that could provide a real-life case presenting an open-ended challenge (“The Big idea”) for students to solve. To help students define their research question (rather than being given one), we have set up a pedagogical framework that ended up aligning closely with CBL (see Fig. 2), a relatively new teaching approach defined by Apple Inc. (Nichols & Cator 2008), which has since been applied to higher education as well (Gallagher & Savage 2020).

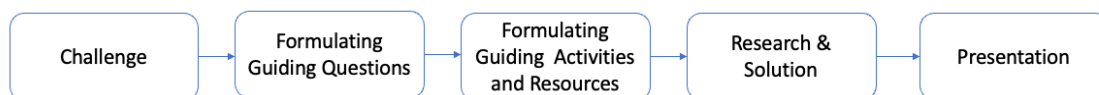

Figure 2: For each of the 3 courses students go through the same challenge-based learning set-up (sketched above).

By working on a challenge *defined by the students themselves*, students acquire and apply the relevant technical skills from physics and psychology to model social systems (e.g., human crowds) by re-formulating the stakeholder’s problem into research (guiding) questions that also incorporates considerations from ethics and psychology. This creates engaging learning environments in which students are active participants rather than passive “absorbers” of knowledge. Furthermore, by defining their own research questions, the students take ownership of their learning, which is shown to be beneficial for success and retention of STEM students (Rodenbusch et al. 2016). The students’ teams work on their challenges supported by academics from each of the disciplines (physics, ethics and psychology). Day-to-day team support is given by teaching assistants (TAs) who act as CBL coaches and help facilitate teamwork (as “Scrum masters”). The project results are delivered as a report and presented to the stakeholders at the end of each quartile period.

## 2 Designing a custom-made learning dashboard to support learning

After the initial delivery of the courses (Sep 2020 – Apr 2021) we experienced difficulties in monitoring the effective way of working of the student teams. It is essential to provide feedback to the students efficiently, especially during the first few weeks of the course when they need to define, through iterations, their guiding questions. If their guiding questions are too broad, too vague, or too specific (e.g., they assume already part of the solution), it is then difficult or even impossible to translate them into concrete (guiding) activities for students to work on. And if this is not addressed early enough, it causes cascading problems as the student

teams progress through the learning line. For that reason, we developed, a fully in-house, custom-made learning dashboard to enable: 1) a faster turnaround of student-to-teacher-to-student feedback, 2) real-time monitoring of student teams' performance, and 3) provide a transparent teamwork framework that enables peer feedback.

## 2.1 The key features of the learning dashboard

**Faster turnaround of feedback:** As mentioned before, one of the main characteristics of the CBL approach to learning is that students are not given a pre-defined question but must think of "guiding" questions to solve themselves, based on the challenge they chose. Since the quartiles are only eight weeks long, guiding questions need to be finalized within about two weeks, to leave enough time for getting through the rest of the CBL process (Fig. 2). The dashboard is, therefore, used to enable students to upload questions and seek faster feedback at any point, rather than wait for scheduled class time (4-hour blocks twice a week).

The lecturers can then check the dashboard on a regular basis and provide frequent succinct feedback. The guiding questions are given zero to five stars rating based on the considerations such as: is this question relevant to the challenge or specific enough, are there enough questions asked to provide a solution to the challenge, etc. The students can then review the feedback quickly and submit updated questions (see Fig. 3, left). The average of the ratings should be increasing over the weeks based also on the qualitative feedback that students receive as well. This way the lecturers can address a lot of students' questions in a short period of time and the students can get feedback faster, enabling them to fine-tune their guiding questions in a short period of time (Fig. 3, bottom right).

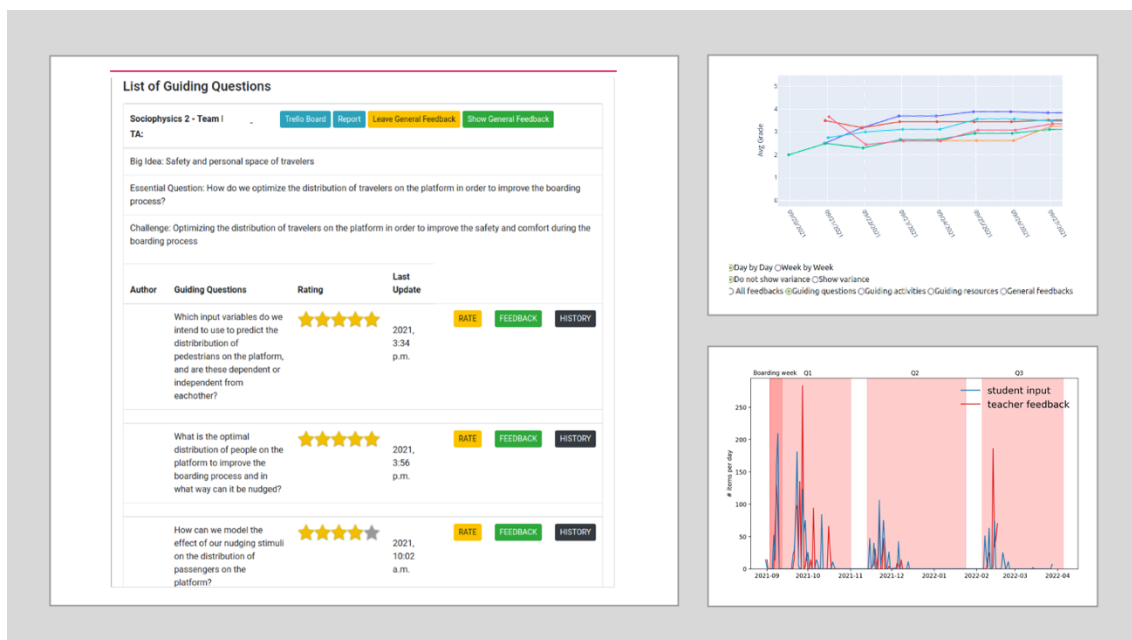

Figure 3: (left) Instructor's view of the learning dashboard for each team – the guiding questions are rated quickly from zero to five stars, and by clicking on the "feedback" button in the tab, the lecturer can leave written feedback as well. (top right) The lecturers and TAs can also monitor the weekly average rating of the team to identify as soon as possible groups requiring additional support. (bottom right) The number of questions (blue) and answers (red) per day over a period of three quartiles during the 2021-2022 academic year with 5 student teams (28 students). The most intense question-feedback period is at the start of each quartile, especially quartile 1 (Q1) when defining the guiding questions is conducted for the first time.

**Real-time monitoring:** The second key function of the dashboard is that the responsible lecturer can monitor in real-time how student teams are progressing throughout the course by viewing the average rating score (Fig. 3, top right). This helps identify early possible signs that the team is experiencing difficulties or

underperforming consistently so that the lecturer can engage more with those students and provide additional specific support.

**Visual representation of student teamwork:** The third key function of the dashboard is to provide a transparent framework and visualization for students' teamwork. Students are usually not enthusiastic about teamwork and instructors often do not formalize this aspect of learning (e.g., Dunne & Rawlins 2000). Students need to be aware of team processes and be accountable for their contribution to their team and their project (Tarricone & Luca 2002). Therefore, we introduced Trello boards and Scrum-like project management to formalize the project process, and we introduced the peer-review feature in the dashboard to help students be accountable to their teammates. Every week, the students rate each other and themselves (from zero to five stars) on six aspects: participation, leadership, listening, feedback, cooperation, and time management (this year we also added "quality of the work"). The students can also provide written comments that only the instructors can view (Fig. 4). This way the TA can become aware of any possible issues, which can then be discussed privately or with a whole team in weekly meetings. The responsible lecturer can again monitor in real-time how individual students are progressing and offer additional support to both the students and the less-experienced TA if needed.

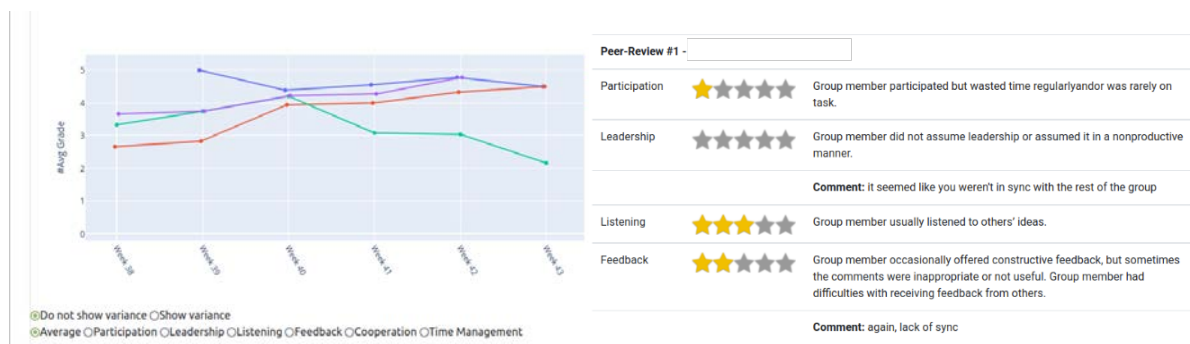

Figure 4: Instructor's view of the peer- and self-review feature of the dashboard. The quick overview of the weekly average rating (left panel) can help spot any issues within the team, and students' written comments can help the TA to facilitate more informed and efficient team meetings.

### 3 Results and summary

We wanted to investigate student perception of our courses, and thus with the 2021-2022 cohort (28 students), we collected quantitative data via an anonymous survey, of which 11 students (40%) responded:

- 80% of the respondents agreed that exploring how physics can be applied to societal problems was very important for them and that working with external partners was motivating for their learning;
- 70% of the respondents agreed that the possibility and freedom to shape their own project was motivating for them, helped them improve their interpersonal and team-working skills, and increased their ability to think about topics in an interdisciplinary way; and
- 90% of the respondents agreed that working on their projects in this course helped them gain useful skills for their future studies and career.

Rather than using commercially available platforms, we designed our learning dashboard in-house to be able to introduce new functionalities and quickly adapt the dashboard to our needs. The development of the dashboard has been conducted as the 2021-2022 courses were taking place, refined by the constant feedback provided by the instructors and the students. Therefore, from the 2022-2023 cohort with 80 students enrolled, we collected qualitative data via an anonymous survey containing two open-ended questions on students' perception of the dashboard functionalities, to which 43 students (54% of the cohort) responded. From the responses to the first question "Which aspect(s) of the learning dashboard do you find most useful?", we find that:

- 58% of the respondents listed the (rapid) feedback feature,
- 19% of the respondents listed the peer feedback feature,
- 17% of the respondents listed visual representation of the “CBL overview”, which refers to the graphical representation of the link between the guiding questions, guiding actions and guiding resources, or in the words of one of the students “It helps you to think about what you want to investigate in more detail”.

From the responses to the second question “Which aspect(s) of the learning dashboard do you think could be improved?”, we find that: most suggestions were related to the way editing of the questions could be improved and streamlined, a couple of respondents suggested that peer feedback every week could be reduced to once every fortnight, and a couple of respondents suggested that there could be an email alert to the instructors after the students update their entries for even faster feedback response, as well as an email reminder for the students to complete their peer review.

Therefore, the advantages perceived by the students align well with the intended purpose of the dashboard and we see that there is an interest in the implementation of additional automation and scheduling functionalities.

In summary, our students have demonstrated a willingness to learn physics in a new way and build broader knowledge and skills than in a more traditional physics course. Our experience shows that a carefully designed learning tool has enabled scaling up a CBL course initially designed with a cap of 20-30 students to be scaled up to larger class sizes (around 100) while maintaining the quality of engagement between the lecturers and the students. We believe that this framework, instead of simply teaching physics to students, support them in learning how to become physicists and how to integrate quantitative approaches with ethics and psychology to tackle complex multidisciplinary societal challenges.

Acknowledgments: This work was partially supported by the NRO grant 405.20865.714 and the TU/e educational innovation projects “New Challenge Based learning line: Physics of Social Systems” and “Scaling up Challenge Based Learning (CBL) at TU/e”. Ethics approval was obtained for use of data reported here (ERB2021ESOE17).

## 4 References

- Dunne, E., & Rawlins, M.C. (2000). Bridging the Gap Between Industry and Higher Education: Training Academics to Promote Student Teamwork. *Innovations in Education and Training International*, 37, 361 - 371. <https://doi.org/10.1080/135580000750052973>
- Gallagher, S., & Savage, T. (2020). Challenge-based learning in higher education: an exploratory literature review. *Teaching in Higher Education*, 1-23. <https://doi.org/10.1080/13562517.2020.1863354>
- Nichols, M., & Cator, K. (2008). Challenge based learning white paper. Apple, Inc.
- Pouw CAS, Toschi F, van Schadewijk F, Corbetta A. (2020). Monitoring physical distancing for crowd management: Real-time trajectory and group analysis. *PLOS ONE* 15(10): e0240963. <https://doi.org/10.1371/journal.pone.0240963>
- Rodenbusch, S. E., Hernandez, P. R., Simmons, S. L., & Dolan, E. L. (2016). Early Engagement in Course-Based Research Increases Graduation Rates and Completion of Science, Engineering, and Mathematics Degrees. *CBE life sciences education*, 15(2), ar20. <https://doi.org/10.1187/cbe.16-03-0117>
- Schweitzer, F. Sociophysics, (2018). *Physics Today* 71, 2, 40. <https://doi.org/10.1063/PT.3.3845>
- Tarricone, P., & Luca, J. (2002). Successful teamwork: A case study. Proceedings of the 25th HERDSA Conference, Perth, Western Australia



# CDIO Based Curriculum Design framework for Electrical and Electronics Engineering Program

Gowtham N

Manipal Institute of Technology Bengaluru, Manipal Academy of Higher Education, India, [gowtham.n@manipal.edu](mailto:gowtham.n@manipal.edu)

Shobha Shankar

Vidyavardhaka College of Engineering, India, [shobha.shankar@vvce.ac.in](mailto:shobha.shankar@vvce.ac.in)

Savyasachi G K

Vidyavardhaka College of Engineering, India, [savyasachi@vvce.ac.in](mailto:savyasachi@vvce.ac.in)

Rakshith P

Vidyavardhaka College of Engineering, India, [rakshith.p@vvce.ac.in](mailto:rakshith.p@vvce.ac.in)

Avinash R

Vidyavardhaka College of Engineering, India, [avinashr@vvce.ac.in](mailto:avinashr@vvce.ac.in)

Goutham B

Vidyavardhaka College of Engineering, India, [goutham.b@vvce.ac.in](mailto:goutham.b@vvce.ac.in)

Mahipal Bukya

Manipal Institute of Technology Bengaluru, Manipal Academy of Higher Education, India, [mahipal.bukya@manipal.edu](mailto:mahipal.bukya@manipal.edu)

## Summary

The paper explains the process of curriculum design for E and EE engineering program with CDIO approach. The process employed in restructuring of curriculum considering policies framed by regulatory bodies like All India Council of Technical Education (AICTE), India, National Board of Accreditation (NBA), India etc. is also highlighted. The paper also explains the incorporation of CDIO courses in the curriculum to enhance knowledge, skill, and learning domains as per CDIO syllabus 3.0. As an example, one of the CDIO course 'Innovation by design thinking' was considered as a case and was implemented. It can be observed that in the innovation by design thinking course, all the Course Outcomes (COs) are able to contribute on a higher scale to the program outcomes and almost all the program outcomes were addressed. The students' feedback about the course was found encouraging. The students were able to exhibit their innovation and design thinking capabilities and have presented the outcomes of the activities in various conferences, project competitions and the comments obtained from the peers was overwhelming. Based on the feedback and the efficacy of the method used, other CDIO courses were also implemented in full scale across all the semesters and programs.

**Keywords:** Curriculum Design, CDIO, Learning outcomes, Framework

## 1 Curriculum Design Process

CDIO (Conceive, design, Implement, Operate) is a novel approach which includes a framework of OBE (outcome Based Education) and was initiated for engineering education. But in recent times, the CDIO approach is used for other programs like engineering, economy, and management in various universities across the globe (G. A. C. Florez and M. J. C. Huérfano, 2019). The CDIO framework gives a basic idea and provides a structure to design the syllabus (L. Anderson and D. Krathwohl, 2000). It is also vital to consider other factors like NBA accreditation, department internal quality assurance model, national and international education policies, institute documents and research articles which highlight the different perspectives and benchmarks of notable universities worldwide to design the curriculum. In this process of curriculum design,

a committee was formed consisting of professors from different departments. Professors were selected according to their proficiency in curriculum design. Number of enrichment programs were organized to highlight the core components of CDIO syllabus. Series of meetings were held to discuss and finalize the design including the components of CDIO syllabus. The objective was to incorporate CDIO curricular components which include personal and professional skills, interpersonal skills, knowledge, and reasoning in the curriculum (L. Anderson and D. Krathwohl, 2000).

A competency scale was formulated as shown in the Table 1. The members of the syllabus framing committee conducted various sensitization programs on CDIO syllabus version 3.0, standards, learning domains and on the competency scales (CS) (Thiruvengadam S.J, 2020).

Table 1: Competency Scale

Competency Scale	Competencies	Cognitive	Affective	Psychomotor
CS1	To have an exposure	Remember	Receive	Perception set
CS2	Ability to imitate and interpret	Understand	Respond	Guided response
CS3	Skilled in implementation and practice	Apply	Value	Mechanism
CS4	Ability to involve and contribute	Analyze	Organize	Complex/responses
CS5	Ability to adapt and be judgmental	Evaluate	Organize	Adaptation
CS6	Ability to exhibit leadership and innovation	Create	Characterize	Origination

Table 2: CDIO Courses

Semester	Course	Type of course	Credits	CDIO
I	Exploration lab	Practical dominated theory	2	C (D)
II	Lateral thinking	Practical dominated theory	1	C
III	Innovation by design thinking	Practical dominated theory	2	CD (I)
IV	Project management	Practical dominated theory	3	C(D)(I)
V	System thinking	Practical dominated theory	2	CD(I)
VI	Engineering design project	Project	3	CDI(O)
VII	Capstone design project	Project	3	CDIO
VIII	Major project	Project	8	CDIO
			24	

A set of new courses were finalized for inclusion without deviating the requirements of AICTE Model curriculum. Around 15 percent of the total credits is allocated to CDIO courses as listed in Table 1. The syllabus for the CDIO courses was prepared by syllabus framing committee and suggestions on the same was taken from the internal stake holders.

## 2 CDIO based Curriculum structure in E&EE program

The curriculum was designed considering the CDIO curricular components. These components were addressed by incorporating new courses and restructuring the old courses. A structured framework was used to frame the syllabus to make it more comprehensive and novel than the old syllabus with a more emphasis for the students to select their major areas of specialization.

To accomplish the task of curriculum design, a group is formed. The department head to look after the procedure along with a team with a lead comprising of professor, associate professors, and assistant professors. Inputs from CDIO Syllabus 3.0, policies, and guidelines of AICTE, NBA, professional societies, and

the feedback report on the current curriculum by the internal and external stake holders was taken into consideration in designing the curriculum (CDIO v3, 2022). In E and EE program, domain referents like IEEE Power and Energy Society, Institution of Engineering and Technology (IET), Council on Large Electric Systems (CIGRE), ministry of education, and National Education Policy (NEP) 2020 (B. S. Sonde, 2011; M. Zhang, X. Shen and D. Wang, 2021) were considered. The findings from the agencies will include minimum credits to be fetched, credit division, evaluation methods, internship policies, outreach, and the courses that are industry supported. The credit distribution for different courses is as per the Table 3.

Table 3. Distribution of credits

S. No	Courses	Credits by AICTE	EEE credits
1	Management, Humanities and Social Sciences	12	10
2	Basic Sciences	25	20
3	Engineering Sciences	24	24
4	Professional Core	48	52
5	Professional Electives	18	16-26
6	Open Electives	18	10-16
7	Seminar, Internship and Project Work	15	18
8	Compulsory Courses [Environmental Studies, Indian Constitution]	-	-
		160	160

Specialized Domains (SDs) were created in the teaching learning process to balance research and academic activities. A theme was formulated in each department considering the faculty specialization and facilities. SDs comprising of faculty members have been designated the task of designing the courses and to stimulate industry connect according to the theme and domains of the department. This method has structured the process of curriculum design and has considered the program outcomes, feedback from internal and external stake holders in the design.

The course outcomes and program level outcomes were identified for each SDs. Apparently, subjects for each curricular component was identified in each SDs (Su Qiaoping, 2019; Thiruvengadam S.J, 2020). Considering this and the institutional policies, courses were categorized as professional and core elective courses. There are four types of courses in EEE-CDIO curriculum. There are theory, practical, and integrated courses like dominated theory and practical, dominated practical with theory and projects. The program level designated faculty member designs a course map for the program in consultation with the coordinators of SDs and schedules the courses in correlation with the CDIO syllabus 3.0 and the academic regulations of the institute/EEE-CDIO. Later credits are assigned to each course. This scheduling of courses was kept open for discussion in the CDIO core committee to give feedback and suggestions on the same. The schedule of course for the undergraduate E and EE program is presented in Table 4.

Concept mapping is used to design the syllabus under Specialized Domains (SDs). Faculty members at the program level will draft the syllabus. Specialized domains (SDs) of the department include,

1. Analog and digital electronics
2. Power Electronics
3. Power systems
4. Electrical Machines

The initial step in course design under SDs is to select a course designer for each SDs. The course designers are expected to define or redefine the COs according to bloom's level. Then the COs must be mapped with Program Outcomes (POs). Later, the course designer prepares an assessment plan which includes content, concept map, lesson plan and assessment questions. This syllabus is later discussed in the core committee

meeting and suggestions will be considered for improvement. This procedure is followed for all the courses and the final syllabus is drafted in the same manner (Thiruvengadam S.J, 2020). The courses formulated by each SDs for EEE program is presented in the Table 5. Later the members of the Board of Studies (BoS) will finalize the syllabus. Board consists of academicians, industry professionals, department faculty members, alumni and university nominee and few students. This draft is later approved by academic council.

Table 4: Course scheduling for EEE program

Semester	Theory and Practical Courses						Practical		CDIO Courses	Credits
I	Engineering Mathematics -1	Engineering Physics	Chemistry	Communication	Engineering Drawing	Workshop Practice	Chemistry/Physics Lab	Language Lab	Engineering Exploration	22
II	Engineering Mathematics -2	Electric Circuit Analysis	Analog Electronic Circuits	Digital Electronics	Electrical and Electronic Measurements	-	Analog Electronics Lab	Digital Electronics Lab	Innovation and Design Thinking	18
III	Engineering Mathematics - 3	Electromagnetic Waves	Transformers and Generators	Signals and Systems	Microcontrollers	Data Structures and Programming	Microcontroller Lab	Transformers and Generators Lab	Lateral Thinking	22
IV	Engineering Mathematics -4	Power Electronics	Generation, Transmission and Distribution	DC Machines and Synchronous Machines	CMOS VLSI	Core Elective	Power Electronics Lab	DC Machines and Synchronous Machines Lab	Project Management	22
V	Embedded Systems	Control Systems	Digital Signal Processing	Power Systems Analysis 1	Core Elective	Open Elective	Digital Signal Processing Lab	Controls Lab	Capstone Project	22
VI	Engineering Economics	Power Systems Analysis 2	High Voltage Engineering	Sensors And Instrumentation	Core Elective	Open Elective	Power Systems Lab	High Voltage Lab	Engineering Design Project	24
VII	Core Elective	Core Elective	Core Elective	Open Elective	-	-	-	Core Elective Lab	System Thinking	15
VIII	Core Elective	Core Elective	-	-	-	-	-	-	Project	15

Table 5: Core courses formulated by each SDs for EEE program

Analog and Digital electronics	Power Electronics
<ul style="list-style-type: none"> <li>• Analog electronic circuits</li> <li>• Digital electronic circuits</li> <li>• Microcontrollers</li> <li>• Signals and Systems</li> <li>• Digital Signal Processing</li> <li>• Embedded Systems</li> <li>• CMOS VLSI</li> </ul>	<ul style="list-style-type: none"> <li>• Power Electronics</li> <li>• Sensors and Instrumentation</li> <li>• Control Systems</li> </ul>
Power systems engineering	Electrical Machines
<ul style="list-style-type: none"> <li>• Power System Analysis 1</li> <li>• Power System Analysis 2</li> <li>• Generation, Transmission and Distribution</li> <li>• Electrical and Electronics Measurements</li> </ul>	<ul style="list-style-type: none"> <li>• Electromagnetic Waves</li> <li>• AC Machines</li> <li>• DC Machines</li> </ul>

As an example, one of the CDIO course Innovation by design thinking was considered as a case study and was implemented, the COs of the course is illustrated in Table 6. It can be observed that in the innovation by design thinking course, all the COs are able to contribute on a higher scale to the program outcomes and almost all the program outcomes were addressed. Similar kind of mapping was observed in the other CDIO courses. The students' feedback about the course was found encouraging. The students were able to exhibit their innovation and design thinking capabilities in their chosen fields of interest. They have presented the outcomes of the activities in various conferences, project competitions and the comments obtained from the peers was overwhelming. The course end survey is presented in Figure 1.

Table 6: Course outcomes of Innovation by design thinking course

S. No	Course Outcomes	Weightage
1	Identify a broad group of stakeholders needs from a human-centred perspective.	10
2	Able to define and re-define innovation challenges necessary to accomplish a societal project.	15
3	Develop many creative ideas through structured brainstorming sessions.	20
4	Develop proof of concept to bring their ideas into reality and obtain feedback.	30
5	Select the best portfolio available amongst the peers for validation of design solutions.	25

Table 7. Mapping of course outcomes with CDIO syllabus components and competency scale

Course Outcomes		CO1	CO2	CO3	CO4	CO5
Competency Scale		CS3	CS3	CS3	CS3	CS5
LEARNING LEVELS	Cognitive	Apply	Apply	Apply	Apply	Evaluate
	Affective	Value	Value	Value	Value	Organize
	Psychomotor	Mechanism	Mechanism	Mechanism	Mechanism	Adaptation
CDIO curricular components as per CDIO Syllabus 3.0	1.1 Knowledge of underlying Mathematics and Sciences	✓	✓	✓	✓	✓
	1.2 Core engineering fundamental knowledge	✓	✓	✓	✓	✓
	2.1.1 Problem identification and Formulation	✓				
	2.1.3 Estimation and Qualitative Analysis			✓		
	2.1.4 Analysis with Uncertainty				✓	
	2.1.5 Solution and Recommendation					✓
	2.5.1 Ethics, Integrity, and Social Responsibility		✓			
	2.5.2 Professional Behaviour		✓			
	3. Interpersonal communications	✓	✓	✓	✓	✓
	3.1 Teamwork and Collaboration	✓	✓	✓	✓	✓
	3.2.3 Written Communication	✓		✓	✓	✓
	3.2.6 Oral Presentation	✓	✓	✓	✓	✓
	4.1.2 The Impact of Engineering on Society and the Environment	✓	✓	✓	✓	✓
	4.3.2 Understanding Needs and Setting Goals			✓		
	4.4.1 The Design Process				✓	✓

### 3 Conclusions

CDIO curricular framework is employed for E and EE program as a case study in alignment with NBA, AICTE and institutional policies. The new modification in the curriculum has more options to the students to select the subjects based on the areas of interest. The syllabus is designed based on the Competency Scale and CDIO syllabus 3.0. The course learning outcomes is also mapped with CDIO components. The competency scale is framed considering necessary knowledge, skills, and learning domain. New CDIO courses is introduced in the proposed curriculum framework to enhance the major attributes of CDIO which include knowledge and reasoning, personal, interpersonal and system building skills of the students. The CDIO courses have also addressed learning domains and the program outcomes of NBA. As a case study innovation by design thinking course was implemented and the course significantly improved several domains of learning and the students' feedback was encouraging.

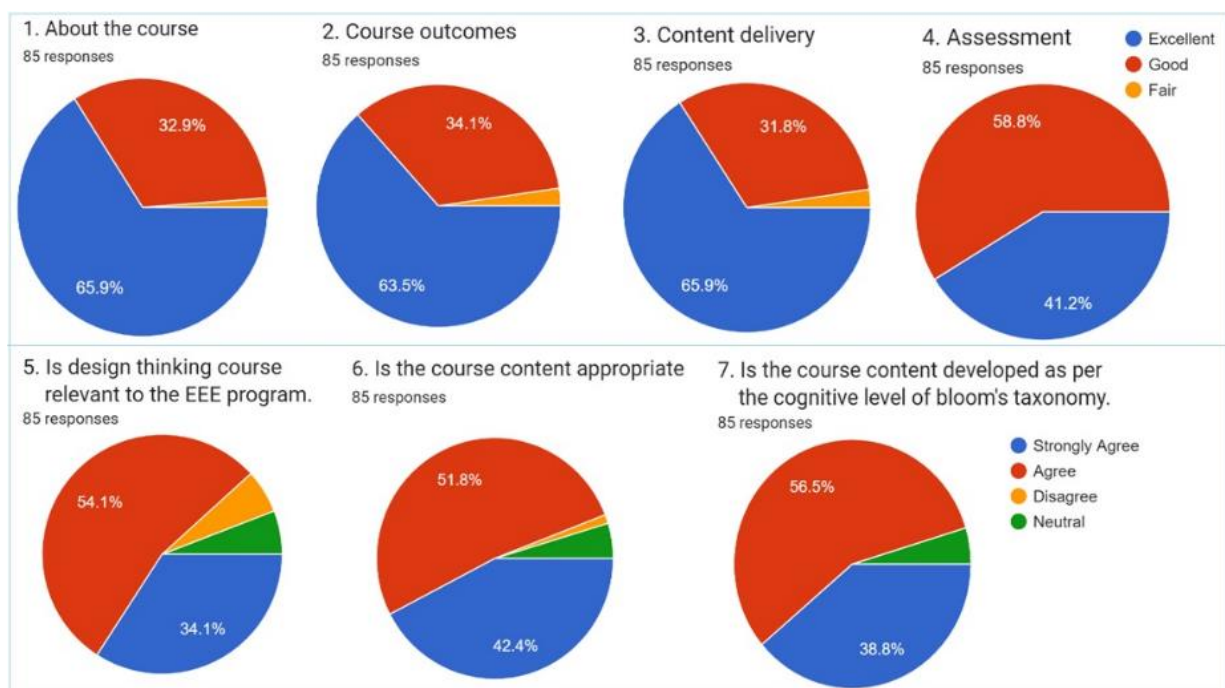

Figure 1: Course end survey

### 4 References

1. Florez, G. A. C., & Huérfano, M. J. C. (2019). Curriculum Design Process for a Systems Engineering Program. In 2019 International Symposium on Engineering Accreditation and Education (ICACIT) (pp. 1-6). IEEE.
2. L. Anderson and D. Krathwohl. (2000). A Taxonomy for Learning Teaching and Assessing: A Revision of Bloom's Taxonomy of Educational Objectives, New York, NY:Longman.
3. The CDIO Syllabus v3.0, [online] Available: [http://www.cdio.org/files/project/file/cdio\\_syllabus\\_v2.pdf](http://www.cdio.org/files/project/file/cdio_syllabus_v2.pdf).
4. B. S. Sonde. (2011). Evolving Accreditation Criteria for Engineering Programs: Indian experience, In 2011 International Workshop on Institutional and Program Accreditation: Connections and Opportunities, 2011, (pp. 1-8), doi: 10.1109/IWIPA.2011.6221140.
5. M. Zhang, X. Shen & D. Wang (2021). Research on the Reform of "Electrical Engineering and Electronics, Based on the CDIO Education Mode1. In 2021 IEEE Conference on Telecommunications, Optics and Computer Science (TOCS) (pp. 179-182). doi: 10.1109/TOCS53301.2021.9688903.

6. Su Qiaoping (2019). Reform and exploration of basic electrical experiments under the concept of CDIO. *Journal of Shangrao Normal University*. 39.
7. Thiruvengadam, S. J., Subramanian, B., Venkatasubramani, V. R., & Abhaikumar, V. (2020). Design of CDIO Curriculum for Undergraduate Engineering Programme: Indian Context. In *The 16th International CDIO Conference* (Vol. 2, p. 65).

# Work in Progress: Integrating Python into Mechanical Engineering undergraduate curriculum

Lama Hamadeh

University College London, United Kingdom, [l.hamadeh@ucl.ac.uk](mailto:l.hamadeh@ucl.ac.uk)

## Summary

Integrating the fundamentals of computer science and programming skills into the undergraduate engineering curriculum has been a primary focus for many educational institutions around the world. Learning the basics of programming from the beginning of undergraduate engineering education allows students to incorporate such skills into their work in the future with ease. The department of mechanical engineering at University College London has acknowledged this value and decided to implement a programming element into the first-year mechanical engineering curriculum to teach the basics of Python language and assess it using a real-life engineering problem. Python is general-purpose, concise, easy-to-read and -learn programming language that has become one of the most popular and in-demand languages in the world. Python has a vast ecosystem of tools, packages, and libraries that address a wide-ranging number of programming scenarios and provide mechanical engineers with a large array of general-purpose functionality. The addition of this element to the first-year curriculum during the last academic year 2021-2022 has shown a high assessment passing rate and notable student engagement. In this extended abstract, an overview of planning, implementing and the results obtained from this process will be illustrated, and future work plans will be outlined.

**Keywords:** Python, mechanical engineering, computer science, undergraduate curriculum, programming skills.

**Type of contribution:** Best practice extended abstracts

## 1 Introduction: Python for Mechanical Engineers.

Programming skills provide engineers with an opportunity to integrate innovative technologies into their everyday work and make it more efficient. Even the knowledge of one programming language or understanding of how to work with data gives engineers a substantial advantage in their work. For the aim of giving rise to highly equipped engineering graduates, teaching these skills needs to be considered and implemented from the very beginning of their undergraduate university journey. Learning how to code allows students to start thinking like a programmer and improve their problem-solving abilities (Oliphant, 2007). After all, both engineering and programming include multiple tries and attempts to develop high-quality results, so with experience, they will start finding solutions for these problems much easier.

Choosing the right introductory programming language to teach undergraduate mechanical engineering students should be based on several factors, e.g., its simple syntax that makes it easy to learn for all beginners, its adaptability to analyze and explain most of the mechanical engineering problems, and its popularity within the computational communities, industry, and academia, which greatly helps with students' employability. For example, MATLAB is a widely taught software in most undergraduate STEM



subjects that are used to write code for solving assignments, plotting graphs, and data analysis (Liu, 2020; Mueller, 2003). In addition, C language is especially useful for mechanical engineers because it is the language of choice for hardware interfaces, and is commonly used for microcontroller data acquisition and real-time robotic control (Furman et al, 2010; Salzman et al, 2013; Rehberger et al, 2013). Python is another high-level language and at first sight very similar to MATLAB: it is interpreted, has an interactive prompt, allows dynamics typing, and provides automatic memory management (Raymond, 2008; Nanz & Furia, 2015; Fangohr, 2004; Manish, 2021; Kumar et al, 2020). A comparison between these three programming languages in the context of teaching in engineering has been studied in (Fangohr, 2004). It has been found that Python is selected to be the best choice in terms of clarity and functionality of a programming language that provides engineering students with clear, unambiguous, and intuitive syntax that allows them to express their algorithms quickly. Python has a small core of commands, which provides nearly all the functionality beginners will require. Additionally, its vast ecosystem of tools, packages, and libraries addresses many programming scenarios and provides engineers with a large array of general- and special-purpose functionality. Most interestingly, Python has seen rapid growth as an introductory language in computer science courses and is becoming one of the most popular programming languages in industry and academia (Wende et al, 2020; Davim et al, 2019). When Python was released in 1991, the premier languages at the time were FORTRAN, COBOL, C, and C++. Since the mid-90s, it has steadily been increasing in popularity and overtaking its old competitors as its programs tend to be much shorter than equivalent programs in other languages. Learners' rates have also skyrocketed due to the fact that Python is an open-source language, meaning that anyone can contribute to the code. This surely makes Python stands out from all the other introductory programming languages. Fig 1 shows the percentage of questions received by Stack Overflow, a public question-answer platform for developers, from Python users over roughly 10 years. It can be clearly seen how the interest in Python has noticeably increased compared to other programming languages (Stack Overflow, 2023).

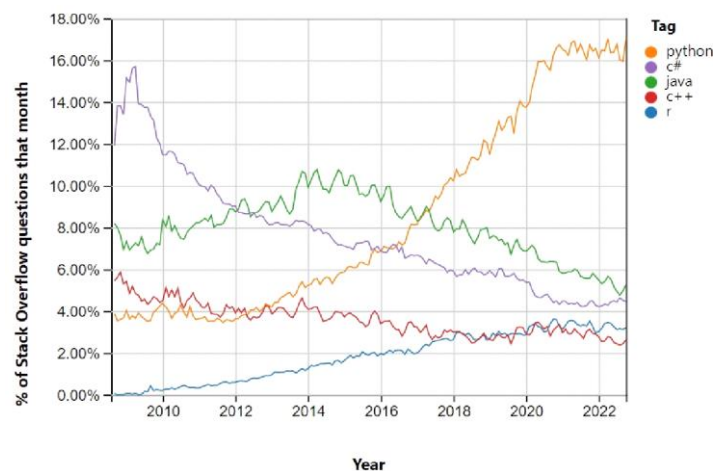

Figure 1: A snapshot of how programming languages have trended over time based on their tags on [Stack Overflow](#) since 2008 (Stack Overflow, 2023).

This has given motivation to some academics to transition to Python in their mechanical engineering teaching courses (Furman et al, 2020). As a result, a decision has been consensually made to implement Python in this element since it encapsulates largely all the pre-mentioned factors an introductory programming language must meet for teaching first-year mechanical engineering undergraduates.

## 2 Framework for a Best Practice

The aim of introductory courses in the first year of mechanical engineering is to provide students with the engineering fundamentals and show how they are applied to basic real-life problems. When it comes to designing an introductory programming element and integrating it into the first-year curriculum, it must go

in line with this aim (Sheth et al, 2016). The content, objectives, and the way everything is learned, taught, and assessed need a lot of thought to be successful (Sobral, 2021). For this introductory programming element, and since no prior programming experience is required, the content and its associated activities should be progressive, i.e., starting from the most fundamental with simpler questions and advancing gradually toward more complex concepts (Gomes & Mendes, 2009). This hierarchical structure means that in order for the students to be able to explain and analyze a given engineering problem using Python, they must attain prerequisite **knowledge** (understanding the principles of algorithmic thinking and the language syntax), and **skills** (implementing Python commands *correctly* while making use of its available libraries), in the course of a certain teaching and learning approach. Furthermore, it is easier to achieve goals when they are well-defined. The clear and structured definition of instructional objectives, considering the acquisition of knowledge and skills, will direct the teaching process towards the appropriate choice of strategies, methods, delimitation of specific content, and assessment instruments, and, consequently, effective and lasting learning (Sobral, 2021). For the aim of designing an introductory programming element and creating clear learning objectives, the levels of the revised Bloom's taxonomy (Krathwohl, 2002) are chosen to be the drive for creating a holistic teaching and learning plan. This taxonomy has been proven to be effective in formulating undergraduate introductory programming content (Sobral, 2021; Gomes & Mendes, 2009; Britto & Usman, 2015) and assessments (Chatzopoulou & Economides, 2010). The revised Bloom's taxonomy is a hierarchical two-dimensional framework: Knowledge and Cognitive Processes with six levels: remember, understand, apply, analyze, evaluate, and create, as shown in Fig 2. In this element, and as shown in Fig 2, a mapping to each level of the revised Bloom's taxonomy has been drawn to its design and its underlying objectives. The first four levels correspond to the teaching and learning classes that deliver the main programming materials and ultimately build foundational knowledge and skills. A blend of both the fourth and fifth levels is directed toward assessing students' comprehension of the programming material. The final level, i.e., creating, is targeted at higher undergraduate years where students can implement and advance their Python knowledge onto new engineering projects.

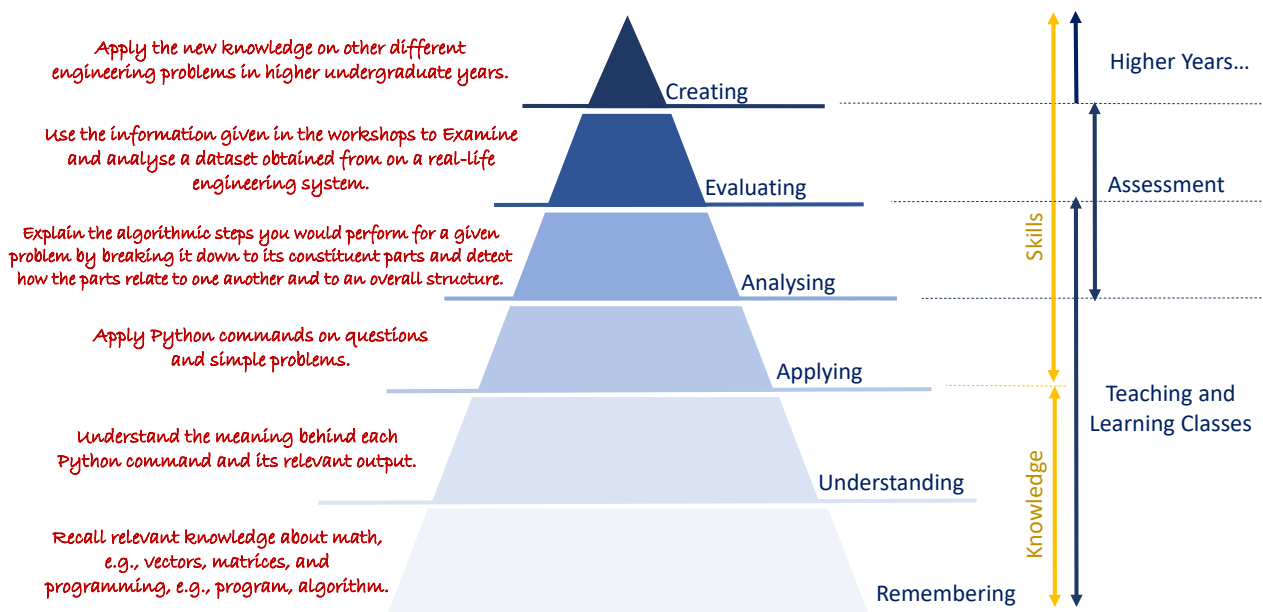

Figure 2: Revised Bloom's Taxonomy projected onto the programming element introduced for the first-year mechanical engineering undergraduate course.

To systemize the best practice, the plan, as shown in Fig 3, starts with four teaching and learning classes where all the material is delivered in live-coding sessions depicting the first four levels of the taxonomy, followed by an assessment that tests students' apprehension and their ability to analyze and evaluate a given mechanical engineering system.

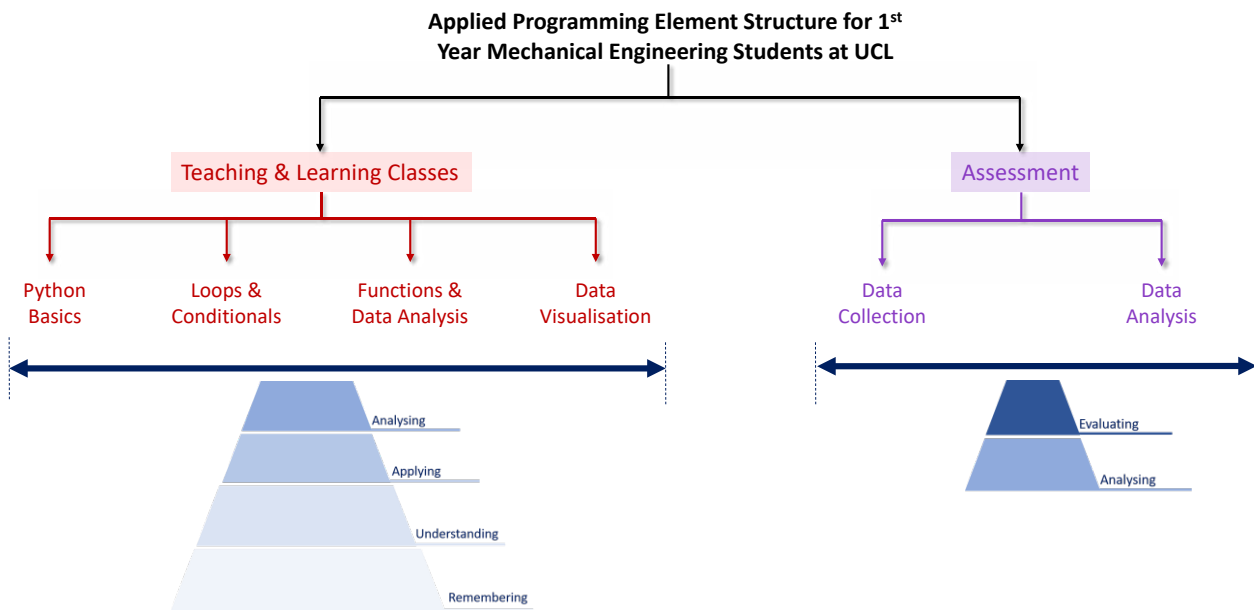

Figure 3: Teaching and Learning plan for the Introductory Python Programming Element.

## 2.1 Teaching and Learning Classes

In order to incorporate the first four levels of the pyramid into the students' programming learning journey, i.e., remembering, understanding, applying, and analyzing, it is essential to structure the programming classes so that they enhance students' engagement with the material, enable students to receive instant feedback and stimulate peer-to-peer discussion. Another aspect that must be considered is that a variation in programming abilities and skills between students should be expected. Some students will enter with a certain programming background, whilst the majority are novices in this field (Cawthorne, 2021). Assuming that all students have no prior programming experience, and for the aim of creating inclusive and active coding classes, four, 2-hours, in-person, live coding workshops were scheduled for the entire cohort that has roughly 200 students to be delivered throughout four weeks, i.e., one workshop per week. During these workshops, students are strongly advised to attend with their laptops so they can practice and develop their coding-writing skills and master the syntax of the language. Moreover, to provide programming material that is suitable for all students, the fundamentals of Python were chosen to be delivered; Python basics, iterative loops, conditionals, functions, working with data, and visualization. After explaining each topic and its required syntax, several problems are followed so students can solve using the correct concept. This is essential as it builds the required skillset that allows students to break down a larger task into smaller blocks that can be performed by code (Cawthorne, 2021). To manage the large number of students and to make certain that all of them receive the necessary feedback while they solve and code the questions, four postgraduate teaching assistants and I are constantly roaming around the lecture theatre to make sure students' questions are answered and their learning journey is on track.

## 2.2 Assessment

A typical introductory programming course will assess students by having them complete coursework so students are assessed on their ability to apply programming to solve problems (Cawthorne, 2021). For this element's assessment, and since it is directed toward first-year mechanical engineering students, it is designed so that it examines and measures the students' practical and programming skill sets. In this assessment, *Students are required to collect a dataset from a 3D-printed Stirling Engine and use it to answer coursework questions that analyze its physics, dynamics, and kinematics in a single Jupyter Notebook using*

*Python language and submit it into the online associated submission portal. Stirling Engine is a mechanical engineering system that uses cyclic compression and expansion of a gas at different temperatures to convert heat energy into mechanical work at a certain frequency. The collected dataset, which has the format of a .csv file, includes parameters such as the engine's running time, the upper and lower temperatures, the number of revolutions, etc. Students are required to use this dataset to answer questions presented to them as coursework with the aim of evaluating and quantifying the physics, dynamics, kinematics, and efficiency of the engine. Their coursework answers must be written and submitted as a single Jupyter Notebook file. This would surely allow evaluating objectively students' technical skills and scientific knowledge.*

### 2.3 Next Steps.

The top of the revised Bloom's pyramid is reserved for "creating". For this element, the content of Python programming provided in Year 1 is linked to skills in data analysis and the visual presentation of graphics. This builds the foundational knowledge and essential skills that are helpful in subsequent years when higher-level programming is necessary.

- In Year 2, the students primarily use data analysis and visual presentation skills in laboratories, such as Aerofoil testing (in Intermediate Fluid Mechanics), beam buckling (Solid Mechanics), and strain gauge measurements (Instrumentation).
- In Year 2, the above skills are used in laboratories related to Advanced Dynamics and Control. Importantly, the students undertake a significant year-long individual research project, where they apply advanced data analysis. Several projects require advanced programming skills, e.g. in machine learning (ML), parametric model setup, and artificial intelligence. The success of these projects was limited in the past because the students lacked knowledge of basic programming, and this was fed back to the curriculum development team on multiple occasions.
- In Year 4, the students undertake a year-long group design project that is worth 50% of the year's credits. There is always a requirement for advanced data analysis in these projects. The students also undertake complex projects that involve building and testing ML platforms, creating advanced codes for image recognition, etc., where advanced knowledge of programming languages is required. These students are much better equipped now that the fundamentals of Python are acquired in Year 1.

## 3 Outcomes, Conclusion, and Future Plans

Introducing the Python programming element to the first-year students of a cohort of roughly 200 students last academic year, 2021-2022, has shown significant success. This can be evaluated based on two factors:

- **Coursework results.** As mentioned in 2.2, students had to submit a single Jupyter Notebook file that contains the answers to coursework questions that analyze the dynamics of a Stirling Engine. The marking criteria have been set out in a way that they depend on three main aspects: quality of code, the use of markdown cells, and the accuracy of scientific content. Grades are split into four bands: A (excellent), B (well executed), C (competent), D (marginally accepted), and F (fail). Fig 4 shows the coursework grades distribution where it can be seen that 94% of students passed the coursework with the 44% majority falling into the B (well executed) grade. It is worth noting here that the dominant cause behind the 6% fail rate was mostly technical as most of these students were unable to save their Jupyter Notebooks properly (they used the "save as" option from the browser rather than Jupyter software), and as a result, markers were unable to open and see their submitted files. This issue has been stressed on it this year to prevent it from re-occurring.

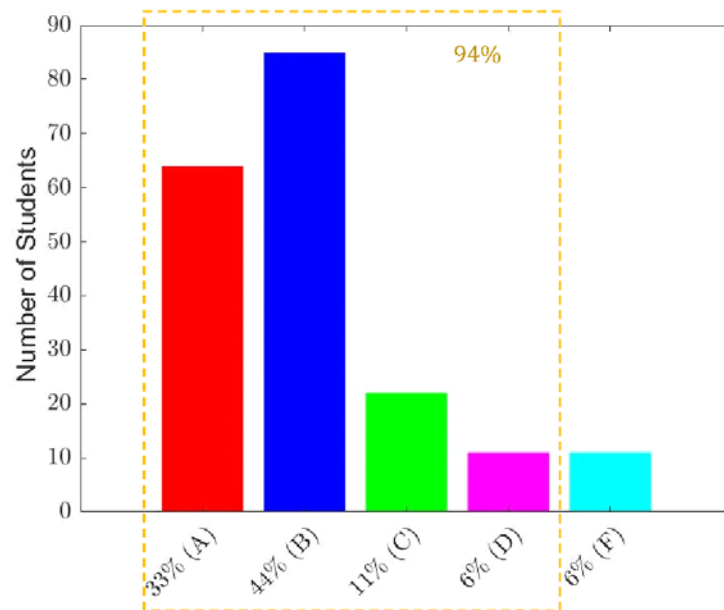

Figure 4: Grades percentages distribution of the programming assessment.

- Students' motivation.** Throughout the entire teaching and learning journey of this element, students showed several behavioral signs that proved their motivation and interest in learning Python. The average workshop attendance was roughly 70%. This created vibrant and interactive learning classes where students tended to sit in groups that positively enhanced their collaborative discussion. Moreover, many students did not apply the material blindly during workshops; they engaged with the thought process and often proposed alternative algorithmic ways to solve questions. These are certainly good indications that students had an enjoyable introductory programming experience. Worth mentioning that for the existing later-year students who have not had the basic Python experience and showed interest in this introductory course as many emails were received asking for more details, all the material was shared with them so they can go through the content at their own pace.

In conclusion, integrating an introductory Python programming element into the first-year mechanical engineering curriculum has shown to be a necessary course of action. Putting together an effective instructional design for this element would certainly lay out the required foundational programming knowledge and skills that our students need for their academic progression in higher years and their future careers. Surely, and since this element is new and still in progress, several future ideas are needed to be thoughtfully considered so this learning activity is taught as smoothly and holistically as possible for the next years. For instance, the problems introduced during the active learning workshops that students use to solve computationally must be related to other modules taught in the course, e.g., thermodynamics, elasticity, solid body kinematics, fluid dynamics, etc. This will build a holistic element that not only equips students with the necessary programming skills but also allow them to project these skills on the topics taught in their courses. Furthermore, and as mentioned before, since higher-year students deal with engineering projects that require advanced programming and data analysis knowledge and skills, new elements that focus on algorithms and methodologies that address key tasks in data-driven engineering can be introduced and integrated suitably into relevant modules. This would provide students with additional expertise to not only analyze their projects effectively and extract useful insights from them but also add an auxiliary hard employability skill into their academic package.

## 4 References

- Britto, R. & Usman, M., (2015). Bloom's taxonomy in software engineering education: A systematic mapping study. *IEEE Frontiers in Education Conference (FIE)*, El Paso, TX, USA, pp. 1-8.
- Cawthorne, L. (2021). Invited Viewpoint: Teaching Programming to Students in Physical Sciences and Engineering. *Journal of Materials Science*, vol. 56, pp. 16183-16194.
- Chatzopoulou D. I., & Economides A. A. (2010). Adaptive Assessment of Student's Knowledge in Programming Courses, *Journal of Computer Assisted Learning*, 26(4), pp 258-269.
- Davim, J. P., Díaz Vicente García, & Solanki, V. K. (2019). Handbook of IoT and Big Data. *CRC Press*.
- Fangohr, H. (2004). A comparison of C, MATLAB, and python as teaching languages in engineering. *Computational Science - ICCS 2004*, 1210–1217. [https://doi.org/10.1007/978-3-540-25944-2\\_157](https://doi.org/10.1007/978-3-540-25944-2_157)
- Furman, B. J., Ahsan, S., & Wertz, E. (2020). Making the move from C to Python with mechanical engineering students. *Paper presented at 2020 ASEE Annual Conference & Exposition Virtual Conference*.
- Furman, B., & Wertz, E. (2010). A first course in computer programming for mechanical engineers. *In Proceedings of 2010 IEEE/ASME International Conference on Mechatronic and Embedded Systems and Applications* (pp. 70–75).
- Gomes, A. & Mendes, A. (2009). Bloom's taxonomy based approach to learn basic programming. In G. Siemens & C. Fulford (Eds.), *Proceedings of ED-MEDIA 2009--World Conference on Educational Multimedia, Hypermedia & Telecommunications* (pp. 2547-2554).
- Krathwohl, D. R. (2002). A Revision of Bloom's Taxonomy: An Overview. *Theory Into Practice*, vol. 41, no. 4, pp. 212-218.
- Kumar, G., Singh, V., & Thombre, M. (2020). Importance of Learning Python Programming in the Field of Mechanical Engineering. *United International Journal for Research & Technology*, 1(12), 16-18.
- Liu, Y. C. (2020). Implementation of MATLAB/Simulink into a vibration and control course for mechanical engineering students. In *Proceedings of the ASEE SE Section Annual Conference* (pp. 8-10).
- Manish, P. (2021). Exploring Integration of Python Libraries in Computation Intensive Mechanical Engineering Courses, *International Journal of Engineering Research & Technology (IJERT) ICDML – 2020* (Volume 09 – Issue 02).
- Mueller, D. (2003). Introducing the finite element method to mechanical engineering students using MATLAB. In *2003 Annual Conference* (pp. 8-781).
- Nanz, S., & Furia, C. A. (2015). A comparative study of programming languages in Rosetta Code. 2015 *IEEE/ACM 37th IEEE International Conference on Software Engineering*. <https://doi.org/10.1109/icse.2015.90>

Oliphant, T. E. (2007). Python for Scientific Computing. *Computing in Science & Engineering*, vol. 9, no. 3, pp. 10-20.

Raymond, E. S. (2008). The art of Unix programming: With contributions from thirteen Unix pioneers, including its inventor, *Ken Thompson*. Addison-Wesley.

Rehberger, S., Frank, T. & Vogel-Heuser, B. (2013). Benefit of e-learning teaching C-programming and software engineering in a very large mechanical engineering beginners class. *IEEE Global Engineering Education Conference (EDUCON)*, Berlin, Germany, pp. 1055-1061.

Salzman, N., & Meckl, P. H. (2013). Microcontrollers for Mechanical Engineers: From Assembly Language to Controller Implementation. *Paper presented at 2013 ASEE Annual Conference & Exposition*, Atlanta, Georgia. 10.18260/1-2—22290

Sheth, S., Murphy, C., Ross, K. A., & Shasha, D. (2016). A course on programming and problem solving. *Proceedings of the 47th ACM Technical Symposium on Computing Science Education - SIGCSE '16*. <https://doi.org/10.1145/2839509.2844594>

Sobral, S. R. (2021). Bloom's Taxonomy to Improve Teaching-Learning in Introduction to Programming. *International Journal of Information and Education Technology*, 11(3), 148-153. DOI: 10.18178/ijiet.2021.11.3.1504. ISSN: 2010-3689. Disponível no Repositório UPT, <http://hdl.handle.net/11328/3368>

Stack Overflow is a question and answer website for professional and enthusiast programmers. Stack Overflow Trends show how technologies have trended over time based on use of their tags since 2008, when Stack Overflow was founded. <https://insights.stackoverflow.com/trends>

Wende, M., Giese, T., Bulut, S., & Anderl, R. (2020). Framework of an active learning python curriculum for First Year mechanical engineering students. *2020 IEEE Global Engineering Education Conference (EDUCON)*. <https://doi.org/10.1109/educon45650.2020.9125259>

# Promoting PBL initiatives in Engineering from an Institutional strategy for curricular transformation

Liliana Fernández-Samacá

Universidad Pedagógica y Tecnológica de Colombia, Colombia, [liliana.fernandez@uptc.edu.co](mailto:liliana.fernandez@uptc.edu.co)

Sonia Esperanza Díaz Márquez

Universidad Pedagógica y Tecnológica de Colombia, Colombia, [sonia.diaz@uptc.edu.co](mailto:sonia.diaz@uptc.edu.co)

Diana Carolina Latorre

Universidad Pedagógica y Tecnológica de Colombia, Colombia, [diana.latorre@uptc.edu.co](mailto:diana.latorre@uptc.edu.co)

María Cristina Corrales Mejía

Universidad Pedagógica y Tecnológica de Colombia, Colombia, [maria.corrales01@uptc.edu.co](mailto:maria.corrales01@uptc.edu.co)

Oscar Iván Higuera-Martínez

Universidad Pedagógica y Tecnológica de Colombia, Colombia, [oscar.higuera@uptc.edu.co](mailto:oscar.higuera@uptc.edu.co)

## Summary

This paper presents a transformation route as an institutional strategy for promoting curriculum change. This route, also called the Four Step Methodology (4S-M), considers the analysis of i) institutional policies; ii) surrounding context, including the professional demands in a global world; iii) aspects related to institutional academic management and iv) curricular design characteristics that favor the professional education. This route allows faculty staff to propose alternatives for renovating engineering curricula, including Project-Based Learning scenarios that use contextual issues to trigger the learning process and whose goals involve improving collaboration and autonomy, and developing professional and transversal skills. The paper also shows a possible configuration of an IT engineering program based on two kinds of PBL scenarios sketched using the results of applying the proposed methodology. These scenarios pursue PLB initiatives in which several courses support the development of a project (Project Scenario PS that stresses on professional skills) or research projects become a learning environment (Transversal Projects TP that focus on inter and transdisciplinary knowledge), where teachers and students, working in teams, perform different roles.

**Keywords:** Curricular transformation, Project-based learning, Engineering education, Management of change

**Type of contribution:** Best practice extended abstracts

## 1 Introduction

Curriculum transformation in engineering has been an important research topic for academic engineering communities worldwide. How to conceive new curricula that face the growing challenges that our life brings? It has become an open question that academics and stakeholders need to answer in less and less time. The climate crisis, an economy based on a global market, and the emerging problems due to the use and demand of new technologies and energy sources make us reflect on how to train new engineers and how current study plans respond to the professional challenges imposed on them in an accelerated way. This transformation must go beyond the adoption of a model; it requires the discussion and participation of the different actors and social sectors, facing the very meaning of education and the review of existing knowledge, as well as the production of new knowledge sensitive to the context needs, especially for topics socially relevant is mentioned in (Graham, 2018). Therefore, it is necessary to promote an exercise of analysis and questioning of what the curriculum represents for the institutions, for the training programs, and in



general for the academic community and the impact that this generates in the development of the students' potentialities, through a study plans and practices and pedagogical strategies designed for this purpose.

Currently, one of the most discussed and widely adopted educational approaches in engineering education is Problem and Project Based Learning. Thanks to its notable advantages (Kolmos et al., 2009), PBL has become an approach for transforming engineering education curricula, especially by simulating professional issues in educational environments. Thus, PBL has been adopted to help students build a broad and flexible knowledge base, develop effective problem-solving skills, cultivate self-direction and lifelong learning skills and become effective collaborators by the demands of the context.

Likewise, the PBL is a versatile option for change at different organizational levels: 1) individual level, as a complement/strategy for a single course where a project focuses on a single course; 2) system/group level, as an integration strategy where a project is dedicated to combining knowledge from different courses; and 3) philosophy/institution level, rebuilding strategy where all courses support project work, and projects can be interdisciplinary and transdisciplinary (Kolmos et al., 2016; Korkmaz & Kalayci, 2019; Moesby, 2004).

In engineering education, the curricular design must consider both the curricular and organizational transformation of the institutions; some examples of these transformations are presented in (de Graaff & Kolmos, 2007; Du et al., 2009). In (Chen et al., 2021), the authors review the literature on the ways of implementation and the challenges of PBL in engineering education, which shows the implementation of PBL from different aspects. This study examined 108 articles on the implementation of PBL from 2000 to 2019 at the course, cross-curricular, curricular, and project levels, discussing challenges, which are classified into three levels: individual, institutional, and cultural. All these PBL initiatives have a common characteristic: the management of the teaching and learning process implies an essential reflection on the learning activities, which can be applied in different ways and levels, the different levels of teaching and learning, and the organization.

According to Chen et al. (2021), the institutional level demands more dedication and effort, usually due to a lack of support from departments and institutions, challenges to effective PBL design, and constraints from external conditions. Very few institutions have a problem-based learning (PBL) curriculum at the institutional level or as a cultural vision of the organization. In short, the experience with changing systemic models of PBL at the institutional or organizational level is still limited. Some successful cases are, for example, the Republic of Singapore Polytechnic University, which has leveraged problem-based learning (PBL) as a deliberate instructional approach for all diploma programs since its inception in 2002, or Aalborg University, conceived as a PBL university.

This article presents a transformation route, also called the Four Step Methodology (4S-M), which considers four steps for carrying out the analysis of the background, requirements, challenges, and trends of an education context when a faculty staff wants to transform or design a new program. The steps are labeled like: (1) institutionally, (2) context, (3) management, and (4) action, see (<https://sites.google.com/uptc.edu.co/reformaacademica/inicio>). This route serves as a strategy to promote curricular change toward student-centered approaches, including PBL. Therefore, resulting curricula can be adjusted according to engineering education interests or the organizational levels of the change. Then, for the PBL instance, diverse scenarios can emerge in step 'action' as an alternative for project-based learning, taking as a basis the discussion that 4M-S involves in its three first steps.

The rest of the document is organized as follows: Section 2 describes the methodology 4M-S, Section 3 presents an example of a PBL program for IT engineering, and finally, Section 4 concludes the document.

## 2 Curricular Transformation Route or 4-Steps Methodology (4S-M)

This section describes a curricular design process based on the proposed route for curricular transformation, see Figure 1. Each route step aims at different aspects of the curricular design, the three first steps provide

information for carrying out a deep analysis of the carrier in the institutional and contextual framework, and the last step focuses on concretizing a curriculum. It is worth clarifying that this proposed route was not designed exclusively for engineering; therefore, it can be adjusted or adapted for any program or knowledge field, where autonomy, the interaction between fields of knowledge, and collaborative construction from differences are priorities in curricular design. The route steps correspond to:

Step 1 of the curricular design, called 'Institutionality,' is oriented to knowing and understanding all the academic policies that, through regulations, theoretical constructions, or experiences, guide the educational processes that support the curricular design at the Macro-curricular level. This is understanding the institutional intentions (big goals for changing) manifested through the values of the mission, institutional principles described in a pedagogical or formative model, academic policies, along with institutional curricular structure –organization of contents at the institutional level– among other aspects, for facilitating the incorporation of the identity elements of the University in the curricula. The factors related to Step 1 are in yellow; see Figure 1.

Step 2 of the curricular design, called 'Context,' focuses on identifying the needs of the context, opportunities in the professional field, ways as other related programs develop their educational process, application areas of the profession, challenges for new professionals, values, skills, abilities, attitudes, and sensitivities that students must develop and cultivate, and of course, the trends in education in the knowledge field. Likewise, in this step, the faculty staff recognizes how other fields deal with or study a phenomenon and how its program is interesting for other areas, which is helpful to facilitate future articulation among programs. Thus, the analysis of the context allows the faculty staff and stakeholders to understand the necessary elements to build a relevant program and to recognize, in turn, its limitations and potentialities. Aspects related to Step 2 are in green; see Figure 1.

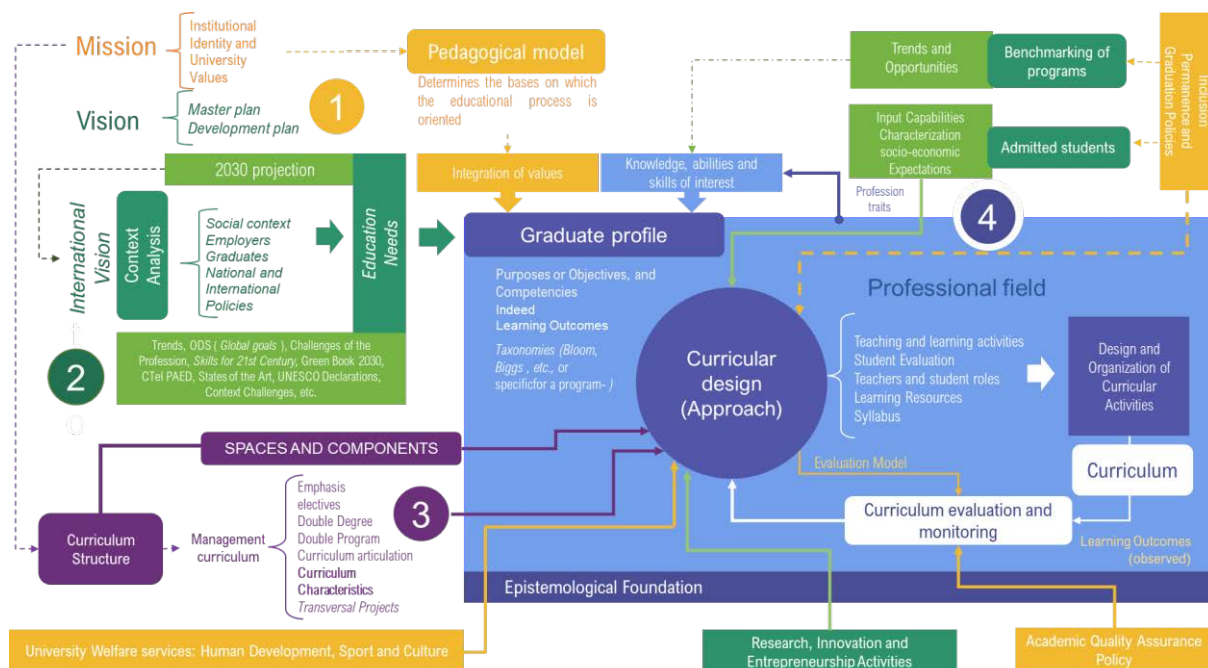

Figure 1: Proposed Curricular transformation Route or 4-Steps methodology: (1) Institutional (Yellow), (2) Context (Green), (3) Management (Dark Purple), and (4) Action (Blue).

Step 3 of the curricular design, called 'Management,' is oriented to identifying the openings that the institutional curricular structure offers for building or strengthening a program. This means knowing the curricular expressions (e.g., how mobility and flexibility are possible) and understanding topics such as the relationship between a curricular activity and a subject, as well as the implications of the i) freedom for taking courses by choice within and outside the program; ii) strategies for articulation between undergraduate and

postgraduate; iii) double program and the double degree; iv) degree work options; and v) the possibility of convert research environments into academic environments, among other factors. This will allow faculty staff to propose alternatives for the program and facilitate the update of the curriculum, exchange between programs, and take advantage of other fields' experience for integral formation. Thus, from autonomy, the programs can conceive curricular projects for responding to the students' expectations and context needs. The aspects related to Step 3 are in dark purple; see Figure 1.

Step 4 for curricular transformation is called 'Action.' This step concretizes all reflections developed in the previous steps of the curricular design to build actions that facilitate: i) the creation of new programs, ii) the adjustment or updating of the existing ones, iii) the curricular articulation of academic programs, or iv) the transformation desired with a new educational project. In Step 4, the faculty staff will be able to define the professional profile based on the information collected in previous steps, along with the curricular approach or alignment and evaluation models. According to the defined approach and intended profile, the faculty staff will determine the kind of curricular activities (teaching and learning practices) and student assessment. Likewise, they will discuss aspects like competencies, learning outcomes, taxonomies, knowledge areas facilities and learning spaces, modalities of degree work, strategies for curricular management, research, internationalization, and innovation, among others. In short, all aspects dealt with herein take the purposes and agreements identified or defined in the previous steps as a basis. The factors related to Step 4 are in blue; see Figure 1.

### 3 Description of the proposed program by using 4S-M

This section describes an example of a PBL curriculum for IT engineering programs designed by applying the proposed transformation route. The main program goal aims to develop abilities for offering solutions based on technology to engineering problems taking the surrounding context as a learning environment. Thus, students can develop professional competencies in conditions very similar to actual performance.

#### 3.1 Institutionalality

The designed program centers on the curricular structure of Universidad Pedagógica y Tecnológica de Colombia, UPTC. This structure comprises two learning spaces, namely (1) social and humanistic and (2) disciplinary, each one with two educational components. On the one hand, the components of the disciplinary space are a) fundamentals and b) disciplinary knowledge. On the other hand, the social and human space has five outcomes related to promoting the development of competencies in all UPTC students to address i) ethical, ii) communication, iii) scientific and technological thinking and innovation, iv) education and citizenship issues, and v) current global problems, promoting the critical thinking. The curricular structure also considers two additional components to level entry competencies and improve foreign language skills.

**Curricular design remark 1:** To suggest the location of social-human courses along the curriculum, considering the curricular transversality and integrality, educational trajectories, and learning outcomes.

#### 3.2 Context

The UPTC is a public university located in the eastern center of the country (over the intersection of the Andean mountains and Eastern plains). This region has different industries and economic sectors, mainly steel and cement industries, agricultural companies, and goods and services firms. The UPTC has more than 30.000 students in 72 undergraduate programs of different modalities. The UPTC has more than 40 master's and 11 Ph.D. and a high-quality accreditation by the National Accreditation council. Although this region has a low index in innovation and poor infrastructure for the market, its people and our University are highly committed to social and economic development. For the reasons discussed previously, the proposed engineering program aims to take advantage of the surrounding context for developing competencies in students, so they can offer new solutions and benefit the region through technology development or application.

**Curricular design remark 2:** To include PBL learning activities and environments that take advantage of the surrounding issues, especially those related to social and industrial contexts.

### 3.3 Management

The proposed engineering program stresses on the freedom to take courses by choice within and outside the program. For this reason, it promotes the students' autonomy through elective classes, degree work options, project scenarios (PS), and transversal projects (TP) and minors, promoting collaboration, interdisciplinarity, and transdisciplinary. The PS involve several courses that serve as inputs to execute a project; and TP are projects that emerge from research scenarios, which involve different educational levels (e.g., from undergraduate to Ph.D.) and knowledge fields. These PBL scenarios are good alternatives to promote mainly creativity from open or ill-defined problems (looseness Space) and long time for project execution (looseness time), as is proposed in (Higuera-Martinez et al., 2022). Moreover, TP and PS usually involve several teacher roles, including expert, tutor, designer, lecturer, facilitator, and mentor (the last one happens mainly when an expert teacher works with an apprentice teacher), and imply a particular PBL design according to their intended learning outcomes and available educational support resources.

**Curricular design remark 3:** To promote student autonomy and self-confidence through PBL scenarios that involve problems and projects, which promote collaboration among carriers and research work.

Leveling	1	2	3	4	5	6	7	8	9	10
Fundamentals of Physics (3 credits) 4h	Physics I (3 credits), 4h	Physics II (3 credits), 4h	Physics III (3 credits), 4h	Physics IV (4 credits), 5h						
Basic mathematics (3 credits) 4h	Differential Calculus (4 credits), 6h	Integral Calculus (3 credits), 4h	Multivariable Calculus (3 credits), 4h	Diferencial Equations (3 credits), 4h	Project 1 (10), 12 credits	Project 2 (10), 12 credits	Project 3 (10), 12 credits	Project 4 (10), 12 credits	Transversal projects Elective (6)	Final work (9), Graduate courses Academic Stay or Internship
Programming Fundamentals (3 credits) 4h	Programming I (3 credits), 4h	Programming II (3 credits), 4h	Programming III (3 credits), 4h	Programming IV (3 credits), 4h						
	Introduction to Engineering (3 credits), 4h	Disciplinary course NP (3 credits), 4h	Disciplinary course NP (3 credits), 4h	Disciplinary course NP (3 credits), 4h	Disciplinary course NP (3 credits), 4h	Disciplinary course NP (3 credits), 4h	Elective (3 credits), 4h	Elective (3 credits), 4h		
					P5 : Research Seminar (3 credits), 4h	Agile Management (3 credits), 4h		Machine Learning (3 credits), 4h	Data analytics (3 credits), 4h	
Communication abilities (3 credits) 4h	P3 : Elective (3), 4h	P4 : Elective (3), 4h	P5 : Elective (3), 4h	P1 : Elective (3), 4h			P3 : Sustainable Projects (3), 4h		P5 : Public and social Innovation (3), 4h	P2 : Elective (3), 4h
	16	15	15	16	16	16	16	16	12	12
										150 credits
Foreign Language	English level I (3 credits) 4h	English level II (3 credits) 4h	English level III (3 credits) 4h	English level IV (3 credits) 4h	English level V (3 credits) 4h	English level VI (3 credits) 4h	English level VII (3 credits) 4h	English level VIII (3 credits) 4h	English level IX (3 credits) 4h	

Figure 2: Proposed program for IT engineering programs by using 4S-M.

### 3.4 Action

Based on the previous analysis, the faculty staff proposes a curriculum (see Figure 2) that includes three transversal trajectories: i) IT learning, which comprises courses or activities related to improving computational thinking, programming skills, and decision-making by using data (in magenta); ii) social-human courses that match with the institutional intentions of the curricular structure of UPTC (in yellow) and intended social-human outcomes of the program, which focus on sustainability, and public and social innovation (in green); iii) learning by projects in junior and senior years (dark blue), which devote to disciplinary knowledge and professional and transversal skills. Likewise, the program seeks to strengthen student autonomy through program electives (dark blue) and electives, by choice, of other programs, which also foster inter and transdisciplinarity, in turn. It is worth clarifying that, in Colombia, the undergraduate

programs take 4 and 5 years and about 160 academic credits (one academic credit corresponds to 48 working hours). These credits are distributed in semesters typically of 16 weeks. The leveling and foreign language components are not included in the 150 academic credits because these courses are only for students who need to strengthen their entry competencies or foreign language. These curricular activities are not mandatory for all program students; nevertheless, program staff can coordinate these in line with the intended outcomes.

## 4 Concluding remarks

The 4S-M route is a methodological tool that facilitates the process of analysis, reflection, and deliberation of academic programs to analyze their relevance and design curricula that are transformed and dynamized from the growing challenges of society, contributing to the generation of changes in the cultural practices of the curricula. Moreover, the 4S-M route promotes collaboration among institutional and program actors by establishing educational goals and designing strategies that encourage changes from traditional learning to student-centered ones, in which different curricular elements are aligned (e.g., learning outcomes and competencies with learning and assessment activities). All this aims to foster student autonomy, decision-making, appropriation of disciplinary knowledge, and the development of professional and transversal competencies.

The proposed transformation route facilitates incorporating the PBL approaches or initiatives at different levels, especially those oriented to renew the academic spaces towards more disruptive learning scenarios. For example, at level 1, when change is encouraged individually in a course, as a strategy to respond to a particular challenge (usually disciplinary knowledge or skills), or a project that integrates a set of courses to respond to employability challenges, or when the curriculum takes advantage of the context to propose a large project and courses support its execution, at seeking a suitable solution that promotes a social change. All these ways are possible with 4S-M.

## 5 References

- Chen, J., Kolmos, A., & Du, X. (2021). Forms of implementation and challenges of PBL in engineering education: a review of the literature. *European Journal of Engineering Education*, 46(1), 90–115. <https://doi.org/10.1080/03043797.2020.1718615>
- de Graaff, E., & Kolmos, A. (2007). History of problem-based and project-based learning. In E. de Graaff & A. Kolmos (Eds.), *Management of change* (pp. 1–8). Brill | Sense. [https://doi.org/10.1163/9789087900922\\_002](https://doi.org/10.1163/9789087900922_002)
- Du, X.-Y., de Graaff, E., & Kolmos, A. (2009). Research on PBL Practice in Engineering Education. In *Rotterdam/Boston/ Taipei: Sense Publishers*.
- Higuera-Martinez, O. I., Corazza, G. E., & Fernandez-Samaca, L. (2022). PBL in the Space-Time Continuum for Engineering Education. *European Journal of Engineering Education*. <https://doi.org/10.1080/03043797.2022.2149388>
- Kolmos, A., de Graaff, E., & Du, X.-Y. (2009). Diversity of PBL-PBL learning principles and models. *Research on PBL Practice in Engineering Education*, 9–21.
- Kolmos, A., Hadgraft, R. G., & Holgaard, J. E. (2016). Response strategies for curriculum change in engineering. *International Journal of Technology and Design Education*, 26(3), 391–411. <https://doi.org/10.1007/s10798-015-9319-y>
- Korkmaz, G., & Kalayci, N. (2019). *Transformation of PBL through the change in Higher Education in the 21st Century: A model for an Institution-Level PBL Design*.
- Graham R. (2018). *The global state of the art in engineering education*. Massachusetts Institute of Technology (MIT) Report, Massachusetts, USA.

Moesby, E. (2004). Reflections on making a change toward POPBL. *World Transactions on Engineering and Technology Education*, 3(2), 269–278.



## Faculty Professional Development

# Work-In-Progress: Caring for Student's Academic and Personal Challenges via The Wellbeing Teaching Assistant

Jorge Baier, Isabel Hilliger, Matías Piña, Ximena Hidalgo, Gabriel Astudillo, Loreto Valenzuela  
School of Engineering, Pontificia Universidad Católica de Chile, Chile, {jabaier,ihillige,xhidalgo,gastudillo,lvalenzr}@ing.puc.cl

## Summary

Since the covid pandemic, some higher education institutions have promoted a flexible evaluation approach for students who face a variety of problems. Instructors willing to implement such flexibilizations face an important challenge: making themselves aware of students going through hard times. This extended abstract gives a high-level overview and a preliminary evaluation of the well-being teaching assistant (WTA), an approach to facilitating communication, suggesting and documenting flexibilizations, and providing support for students going through difficult times in high-enrolment courses. WTAs are regular members of the teaching assistant staff, but they use learning analytics to identify potential students in need, initiate communication using supportive language, and take action by suggesting flexibilization or providing academic support for students facing challenges. WTAs have been incorporated into 27 courses at the School of Engineering of the Pontificia Universidad Católica de Chile in 2022, and have been positively evaluated by students. One of the main current challenges of the approach is scalability.

**Keywords:** Students Wellbeing

**Type of contribution:** Best practice extended abstracts

## 1 Motivation

Students regularly deal with the effects of health and emotional situations faced by themselves or by family members. Aware of those difficulties, and with the additional challenge imposed by the pandemic, some institutions promoted a flexible approach, suggesting teachers to increase communication with their students and make modifications to course evaluations and deadlines if needed (Marinoni et al. 2020, Joaquin et al. 2020; Khraishi, T., 2021). Caring about the wellbeing of students is important for a number of reasons, including the fact that it may affect engagement (Chadha et al., 2021).

In massive engineering courses, instructors willing to implement such flexibilizations face an important challenge: making themselves aware of difficult situations that students may be going through. Unfortunately, students facing mental health issues or other personal problems may not initiate communication, or may initiate it once it is very hard to recover.

This extended abstract describes the well-being teaching assistant (WTA), a teaching assistant whose main task is to actively initiate communication with students at risk of failing the course, suggesting and documenting flexibilizations, and providing support for students going through difficult times in high-enrolment courses. To discover students at risk of failing the course, the WTA uses a machine-learning predictive model (PM) which aims at predicting the final grade of a student given partial grading. The WTA uses a Protocol of Action and Communication (PAC) with students, whose first step involves sending an



email written in a supportive language to establish the causes of the low academic performance. Once the WTA identifies issues with the students, an action is taken according to a set of possible actions defined in the PAC. Every student selected to be a WTA must complete a 4-session training program, which was designed in order to provide WTAs with knowledge of mental health first aid, and to make them aware of the University's health services and procedures for students with serious health issues. Throughout the semester, WTAs receive support from a psychologist with the Engineering Education Unit.

The WTA was first implemented in the fall of 2020 in the School of Engineering of the Pontificia Universidad Católica de Chile. Up to the current second term of 2022, it has been extended to 27 high-enrolment courses. In a previous work-in-progress paper (Piña et al., 2021) we described the PAC and an evaluation of the WTA carried out for a single course. In this paper, we give an overview of the TW, the PAC, and the PM. In addition, we present data about the interactions between WTAs and students, including their motivation and actions taken. We identify three advantages of this approach. First, the proactiveness of the WTAs is very appreciated by students even in cases where no actions are triggered as a result of communication. Second, WTAs document cases, which helps professors of the same course to make consistent flexibilizations through time. Third, since WTAs are coordinated at a school level, lessons learned in specific courses are shared and may be transferred to other courses.

## 2 Selecting and Training WTAs

An important aspect of WTAs is that we require them to be fully qualified as a teaching assistant for the course. The reason for this is that we want WTAs to be fully aware of the academic challenges of the course and therefore able to combine academic and personal support.

WTAs however need additional competencies since they engage in communication that potentially needs to address personal issues of various kinds and complexity. To provide the WTAs with additional competencies, we designed a training program which was taught by a psychologist working with the Engineering Education Unit (EEU) of the School of Engineering. To provide WTAs with notions of mental health, the EEU hired an external psychologist who filmed video capsules that were shown and discussed during training.

In the second semester of 2022, the training program had 4 modules. The objectives of the WTA training are as follows.

- Know the role and duties of the WTA
- Know about the support networks available at the University. Specifically, about the procedures for referrals to the School of Engineering
- Identify support/orientation actions for students who have difficulties of academic or other nature.
- Share experiences with other AB regarding their work and challenges of this role.
- Share perceptions regarding possible areas of improvement for future versions of the AB Program.

WTA do not work alone, and cannot make decisions all by themselves. Indeed, in many cases flexibilizations (more details in Section 3) have to be discussed by the WTA and the instructor. For this reason, the instructors in charge of the courses participating in the WTA program receive information about the main guidelines and suggestions regarding actions to be carried out at each stage of the semester. The information's objective is to clarify what are the WTA's duties, what are the instructor's duties, and what are the joint duties to be considered by both the WTA and the instructor. In the future we will also develop training meetings for teachers as well.

While training is carried out at the beginning of the semester, throughout the semester the WTA can obtain support from the EEU's psychologist. Specifically, WTAs should contact the EEU in case they face situations that appear to be particularly more challenging because of their perceived complexity.

At the end of the semester, the EEU requests from each WTA a record of all the cases received, detailing the reason for the request and actions taken. This information allows us to have a perspective on the type of most recurring cases and their complexity, allowing decisions to be made for the continuous improvement of the WTA program.

```
Hi <STUDENT NAME>,
How are you doing? I hope you are doing well!
I am <TA NAME>, the well-being TA of <COURSE NAME>. I am writing to ask how you are
feeling about the course. Have you been able to comfortably work on the class
activities and homework assignments? Is there anything you are having trouble with?
Remember you can count on me if you need support. I will be happy to help you!
All the best,
```

Figure 1: Causes of low academic performance and actions taken by the TA

Table 1: Causes of low academic performance and actions taken by the TA

Cause	Possible Actions
Isolated/non-recurring situation	No further actions are taken
High time demand at the moment due to non-academic compulsory activities (i.e., extra-curricular activities, care taking of a child)	Offer personalized academic help and/or flexibility (i.e., modify deadlines).
Personal issues (i.e., health issues with the students of family members) or anxiety associated with the course (e.g., because the student failed this course in the past)	Inform/connect the student with University Health services and/or academic advisors, if needed. Offer personalized academic help and/or flexibility (i.e., modify deadlines).
Difficulty understanding the material of the course	Offer personalized academic help
Connectivity issues / low-quality study environment	Flexibility (i.e., modify deadlines).

### 3 A Protocol for Taking Action

The WTA follows a protocol of action that we describe in this section. At the beginning of the course, we obtain consent from the students, informing them that their academic performance will be monitored during the term as part of the wellbeing program of the course. After the first course evaluations, the students' grades are fed into a pre-trained support vector machine (SVM) which is trained to predict the final grade based on the grade of preliminary evaluations, using data from previous semesters. We use SVMs since they seem to generalize better on our data.

Every student that is labeled as being at risk of failing the course is sent an email similar to the one shown in Figure 1. After receiving a response from the student, communication is continued using the most appropriate means (e.g., email, video call, text messaging). Based on this exchange, the TA classifies the

causes of the low academic performance and offers help. The categories and actions taken are shown in Table 1. An emphasis is placed on flexibility and offering personalized academic help. Flexibility refers to offering personalized deadlines depending on the severity of the situations the student is facing. Personalized academic help refers to determining which contents of the course need to be reinforced and suggesting appropriate actions, which range from reviewing written material to one or more tutorial interviews. In case the WTA becomes aware of the existence of mental health issues, the student is immediately put in contact with the school's academic advisors who are psychologists that provide academic counseling. Academic advisors may forward the student to the University's health services and contact the instructors to help them tailor the course to the needs of the student, if appropriate. Students that directly address the wellbeing TA or that fail to submit an assessment at any moment of the semester are also sent emails in the style of the email of Figure 1 and go through the same protocol.

#### 4 Preliminary Evaluation

During the final weeks of class, we applied an online survey in three out of the 27 courses. A convenience sample of 202 students voluntarily answered this survey. Most students learned about the WTA being present in the course via their teaching team (see Figure 2), while 8% had not heard of the program before answering the survey.

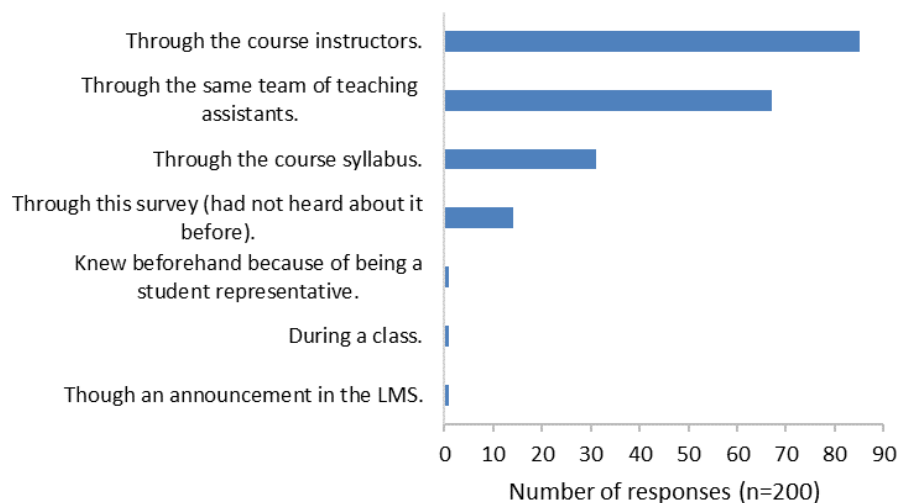

Figure 2: Number of responses regarding they way students got to know about the WTA

Out of the 202 students, 66 had been in touch with the WTA during the semester, and more than 80% of them agreed or strongly agreed with considering a WTA in other engineering courses (55 out of 66). The reasons for contacting the WTA ranged from difficulties with course workload to personal matters. In an open-ended question, students commented on the perceived benefits of WTAs:

*'This semester I had a WTA (...) and just knowing that he exists and feeling that he is there just in case, relieves me. I had to contact him a couple of times. He couldn't do much about my situation, but he did everything possible to help me and I felt heard and understood which helped me a lot.'*

*'Sometimes it is difficult to take the initiative to ask for help, so it helped that he sent me an email that at least seemed personalized, to break the ice.'*

Furthermore, 78% of students who were contacted by a WTA suggested implementing this role in first year courses (52 out of 66) , followed by basic sciences courses and large-enrolment courses. However, they anticipated challenges regarding its scalability:

*'It happens to me that as, in almost all the classes, there are 100 people more or less, the relationship with the teacher is often somewhat distant; in the sense that it is not so much an interaction but rather listening. That's where a WTA could come in as key in making the classroom feel more like a course. Perhaps my idea is not very applicable in the university because there are a lot of people, but it would be good to try to make the courses of the university feel more close.'*

*'It is a very good initiative to have someone specialized within the course and coordinated with the teacher and teaching assistants. Due to the salary issue, it must be difficult to implement in all courses.'*

## 5 Summary and Challenges

This work presents the WTA program, a practice to provide engineering students with timely support in large-enrolment courses. An important feature of the WTA program is that it is a proactive practice, supported by a predictive model, which, as suggested by our results, provides true care for students. As a result, students feel heard, and through the support provided many persist, cope with their difficulties, and eventually approve their course. From our evaluation we infer that WTAs may be addressing the loss of connection and closeness between the instructor and their students, typical of large-enrolment courses. While an important focus of the WTA is to provide care for students, the objective of flexibilizations is not to relax learning objectives. Being a program centralized at a school level, we have been gathering experiences and thus allowing spontaneous good practices to be documented and potentially incorporated into the program. The documentation carried out by WTAs as part of their regular duty also allows courses to define standards for flexibilization and fairness between cases of similar nature across different terms.

Our early results show that scaling this initiative to more large-enrolment courses may be challenging. These challenges are associated with a high workload of the WTA. Increasing the ratio of WTAs to the number of students has associated costs. Thus, we are currently studying ways to automate some of the tasks of the WTA, without sacrificing the human connection that is so key to the practice. As a next step, we plan to extend the practice to cover first-year courses like Calculus, Linear Algebra, and Physics. Another key challenge is the engagement of teaching staff; as mentioned above WTAs and instructors need to collaborate. The quality of such collaboration depends strongly on the engagement of teaching staff.

## References

- Marinoni, G., Van't Land, H., & Jensen, T. (2020). The impact of Covid-19 on higher education around the world. *IAU global survey report*, 23.
- Joaquin, J. J. B., Biana, H. T., & Dacela, M. A. (2020). The Philippine higher education sector in the time of COVID-19. In *Frontiers in Education* (p. 208). Frontiers.
- Khraishi, T. (2021). Teaching in the COVID-19 Era: Personal Reflections, Student Surveys and Pre-COVID Comparative Data. *Open Journal of Social Sciences*, 9(2), 39-53.
- Chadha, D., Kogelbauer, A., Campbell, J., Hellgardt, K., Maraj, M., Shah, U., ... & Hale, C. (2021). Are the kids alright? Exploring students' experiences of support mechanisms to enhance wellbeing on an engineering programme in the UK. *European Journal of Engineering Education*, 46(5), 662-677.
- Piña, M. A., Hilliger, I., Baier, J. A., Melian, C., Ruz, C., & González, T. A. (2021, July). A Protocol to Follow-up with Students in Large-enrollment Courses. In *2021 ASEE Virtual Annual Conference Content Access*.

# Work-in-Progress: PBL Requirements and Challenges for Teachers in Industrial Engineering Education

Alessia Napoleone

Department of Materials and Production, Aalborg University, Denmark, [alna@mp.aau.dk](mailto:alna@mp.aau.dk)

Lykke Brogaard Bertel

Department of Planning, Aalborg University, Denmark, [lykke@plan.aau.dk](mailto:lykke@plan.aau.dk)

Ann-Louise Andersen

Department of Materials and Production, Aalborg University, Denmark, [ala@mp.aau.dk](mailto:ala@mp.aau.dk)

## Summary

Problem-based learning (PBL) is relevant to industrial engineering education due to the interdisciplinarity of this field and the necessity for students and professionals to address complex cause-effect relations. The features of this field introduce requirements and specific challenges for teachers, who consequently need to embrace suitable PBL solutions. In order to understand the requirements and challenges related to teaching in this particular field, a systematic literature review was conducted, and the challenges were outlined and framed in a teacher agency model. While this paper presents the preliminary results of the study, the authors aim to extend the study and identify an integrated solution for effective PBL in this field.

**Keywords:** problem-based learning, teacher agency, industrial engineering education, transition to active learning, literature review

**Type of contribution:** Research extended abstracts

## 1 Introduction

Problem-based learning (PBL) is a “learner-centred approach that empowers learners to conduct research, integrate theory and practice, and apply knowledge and skills to develop a viable solution to a defined problem” (Savery, 2006). It has been used successfully for over 40 years, especially in medicine and engineering disciplines (Andersen et al., 2019; Bae et al., 2021; Jaeger et al., 2013; Louw & Deacon, 2020; Servant-Miklos, 2020; Suliman, 2004).

Industrial engineering is concerned with the design, implementation, planning, and continuous improvement of complex socio-technical systems - meaning systems integrating people, materials, information, equipment and energy - using knowledge in the mathematical, physical and social sciences, and using methods and tools of engineering (Jaeger et al., 2013). In other words, industrial engineering is a highly interdisciplinary field, where professionals need to deal with complex cause-effect relations (Colombo & Golzio, 2016; Jin, 2015; Ramos & Espinosa, 2003). Therefore, PBL is particularly relevant for education in industrial engineering. Encouraging students to address real, complex and ill-structured problems, supports them in creating the mental bridges across disciplines and using the right knowledge and tools to do their future job.

The features of this field introduce specific challenges for teachers. Moreover, highly specialized or discipline-centred teachers are also challenged with PBL, as they additionally need to shift their focus on the students' learning and arrange their teaching activities accordingly (Gosavi & Fraser, 2013; Shi & Zhang, 2013).

The power of teachers to act and influence their teaching, determining their educational innovation is often referred to as professional agency (Du et al., 2021). It includes four iterative stages (Bae et al., 2021; Bandura, 1989; Du et al., 2021), as shown in Figure 1 and detailed below.

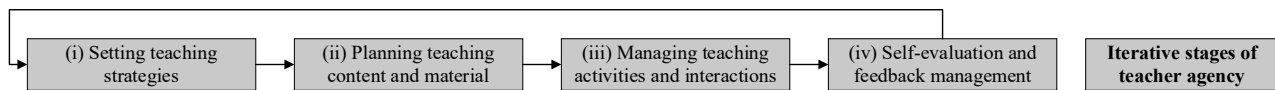

Figure 1 Four iterative stages of teacher agency (based on literature)

Stage (i) - *Setting teaching strategies* refers to the teacher's personal motivation for change, affected by social or external aspects as well as personal aspects (Bandura, 1989; Du et al., 2021). Stage (ii) - *Planning teaching content and material* refers to teachers' preparation and design of content and material. Stage (iii) - *Managing teaching activities and interactions* refers to the real-time handling of students' learning (Bae et al., 2021). Stage (iv) - *Self-evaluation and feedback management* refers to the ex-post reflection about the teaching performance, as well as dialogue with colleagues and students, that are consequently used to adapt teaching strategies over time (iterations in Figure 1). With reference to the four stages of teacher agency, this paper aims to address the following research question:

*"How can PBL Teacher Agency be used to understand the specific challenges in Industrial Engineering Education?"*

While the authors aim to extend this study to identify an integrated solution for effective PBL in the field of industrial engineering, the focus of this paper is to use the teacher agency model to outline and frame the challenges for teachers in this specific field.

## 2 Methodology

A systematic literature review (Denyer & Tranfield, 2009) was conducted to frame existing knowledge about PBL requirements and challenges for teachers in industrial engineering education. To reach academically relevant works, Scopus was used as search database. In alignment with the aim of the study, the following search string was used:

*("manufacturing system" OR "supply chain" OR "factory" OR "plant" OR "industrial engineering") AND "problem based learning"*

The search in Scopus was restricted to articles titles, abstracts, and keywords. This allowed to reach a total of 212 research products. A preliminary screening led to the exclusion of 19 of documents for being: (i) out of scope, (ii) trade journal articles, (iii) not written in English, or (iv) entire proceedings wrongly categorised by the search database as individual research products.

The full texts of the remaining 193 articles were carefully analysed. 65 articles falling into the scope of industrial engineering as per the definition provided in section 1 were individuated and selected. For these, an Excel database was created, reporting the specific area within industrial engineering and the aim of the paper. The addressed theme was also reported, distinguishing between: curriculum design, course design, lecture arrangement and students' skills development. In these themes, the referred stages of teacher agency and identified challenges were also reported.

## 3 Findings

The following Table 1 summarises the findings of this study in terms of PBL requirements and challenges for teachers in this field, framed according to themes and stages of teacher agency.

Table 1 PBL requirements and challenges for teachers in Industrial Engineering Education

	(i) Setting teaching strategies	(ii) Planning teaching content and material	(iii) Managing teaching activities and interactions	(iv) Self-evaluation and feedback management
Course design	<ul style="list-style-type: none"> <li>Develop teaching methods for experiential learning (e.g. using simulated or physical learning factories) to supplement the lack of experience of students and deepen students' ability to solve strategical and tactical problems in the real world (Masse et al., 2019; May, 2022)</li> <li>Adopt sandwich model to foster the required combination of technical and social skills (Makio et al., 2017)</li> <li>Form partnership with companies (Martínez León, 2019; Ruiz-Cantisani et al., 2022)</li> </ul>	<ul style="list-style-type: none"> <li>Start with learning objectives (Steffen et al., 2012)</li> <li>Start with practical skills needed (Sutopo &amp; Aqidawati, 2019)</li> <li>Embed integrative and interdisciplinary experiences into courses (Roethlein et al., 2021)</li> <li>Think creatively to update teaching content (Antkowiak et al., 2017)</li> <li>Consider the practical aspects of some subjects, such as lean management, and align teaching methods using e.g. real examples (Tortorella &amp; Cauchick-Miguel, 2017)</li> <li>Plan to expose students to wide sets of subjects and aspects, to make them able to act as the interface between specialists and users of final systems (Lau &amp; Mak, 2005)</li> </ul>	<ul style="list-style-type: none"> <li>Insert students in the context of lean manufacturing strategies through manufacturing facility tours and simulation type exercises in lab (McLeod &amp; Savoy, 2009)</li> </ul>	<ul style="list-style-type: none"> <li>Survey students and lecturers to find relevant and up-to-date substantiated information to improve PBL (Janno &amp; Körbe Kaare, 2022)</li> <li>Update courses based on managerial needs and complexity in innovative companies, also in relation to the sustainability challenge (Dombrowski et al., 2016; Grigoreva &amp; Sorensen, 2020; Jaeger et al., 2013)</li> <li>Update courses based on the impacts of the digital transformation on management and decision making (Antkowiak et al., 2017; Oberc et al., 2019)</li> <li>Have constant dialogue with industrials to improve teaching material and form (Andersen &amp; Rösio, 2021)</li> </ul>
Skills development	<ul style="list-style-type: none"> <li>Use learning factories to develop students abilities to deal with complex situations (Maganha et al., 2022)</li> <li>Use learning factories to intensify students' technical, soft and social competences (Jaeger et al., 2012; Louw &amp; Deacon, 2020)</li> <li>Build ontological support to match business processes, IT and competences of professionals (Ortega-González et al., 2009)</li> </ul>	<ul style="list-style-type: none"> <li>Plan support students improving visualizing the logic of presentation of results (Filho &amp; Calado, 2013)</li> <li>In project work, ensure that design, creativity, innovation, communication and presentation skills are assessed (as they are needed in industry) (Mohd Salleh &amp; Yusof, 2017)</li> </ul>	<ul style="list-style-type: none"> <li>Use case studies to make groups of students use practical skills, such as general problem solving and project management; as well as social skills to build integrated solutions (Martinez Leon &amp; Crimi, 2019; Miller et al., 2016; Sutopo &amp; Aqidawati, 2019)</li> <li>Use role-playing games to make students understand the complexity around communication and collaboration (e.g. in supply chains) (Jin, 2015; Katzlinger, 2008; Tuulos et al., 2017)</li> <li>Make the students use IT decision support systems since companies often rely on these systems (Grasas &amp; Ramalhinho, 2016)</li> </ul>	

Teaching arrangement	<ul style="list-style-type: none"> <li>• Plan both interactions and independent study sessions (Hisjam, 2019)</li> <li>• Plan teaching by examples, for example exposing a problem and then dig into theory (Lagrasta et al., 2021; Zhong &amp; Huang, 2014)</li> </ul>	<ul style="list-style-type: none"> <li>• Expose and make students solve real-life problems so that they can accumulate experience to produce workable solutions minimize the mismatch between what is taught in classes and what are the real industry needs (Lau et al., 2006; Zhong &amp; Huang, 2014)</li> <li>• Challenge students without providing relevant information to make them experience the problem of lacking information to solve problems (Snider et al., 2019)</li> <li>• Rather than beginning with a single question that is multilayered and complex, use a sequence of questions to build knowledge (Muttamara et al., 2020)</li> </ul>	
----------------------	---	---	--

Outside the teacher agency domain, thus requiring a joint effort at curriculum or university level, the following relevant aspects were also reported:

- Learning factories for different teaching purposes should be developed (Andersen et al., 2019; Jaeger et al., 2012, 2013; Simons et al., 2017; Veza et al., 2015; Zhong & Huang, 2014).
- Interdisciplinary development teams should evaluate the scope and sequence of existing courses and identify potential PBL modules to fit both the educational requirements of courses and workplace activities. These teams should include technical experts and teachers familiar with interdisciplinary and problem-based instruction (Wood, 2002). Interdisciplinary teams might also be needed to develop factory simulation environments for students (Bumblauskas & Vyas, 2021; Rodríguez et al., 2016).
- Methods to evaluate the capability to produce employable industrial engineers that suit perfectly to each industry's needs are needed (Mohd Salleh & Yusof, 2017).
- Development of elective courses for exceptional students should be considered to provide industry with the right competences to face nowadays challenges (Jackson & Wiles, 2013).

## 4 Conclusion

This work-in-progress study aimed to understand the specific requirements and challenges in Industrial Engineering Education. This was obtained using PBL Teacher Agency to identify and classify requirements and challenges, based on a systematic literature review. This paper contributes to the extant body of knowledge by providing an overview of PBL requirements and challenges for teachers in Industrial Engineering Education framed according to themes and stages of teacher agency. Themes are curriculum design, course design, lecture arrangement and students' skills development. Referring to themes supports distinguishing between challenges for teachers as individuals, and challenges requiring a joint effort at university or curriculum level. Referring to stages of teacher agency shows the temporal sequence of requirements and challenges, thus outlining temporal relations between these.



In future research, the authors aim to address these challenges and provide an integrated teacher agency solution in this field. This solution is expected to be particularly helpful for teachers transitioning from discipline-centred teaching to PBL and active learning in general.

Considering the four stages of teacher agency in an integrated way, the solution would enable teachers to align their roles of educators with the role of researchers.

## 5 References

- Andersen, A.-L., Brunoe, T. D., & Nielsen, K. (2019). Engineering Education in Changeable and Reconfigurable Manufacturing: Using Problem-Based Learning in a Learning Factory Environment. *Procedia CIRP*, *81*, 7–12. <https://doi.org/10.1016/j.procir.2019.03.002>
- Andersen, A.-L., & Rösiö, C. (2021). Continuing Engineering Education (CEE) in Changeable and Reconfigurable Manufacturing using Problem-Based Learning (PBL). *Procedia CIRP*, *104*, 1035–1040. <https://doi.org/10.1016/j.procir.2021.11.174>
- Antkowiak, D., Luetticke, D., Langer, T., Thiele, T., Meisen, T., & Jeschke, S. (2017). Cyber-Physical Production Systems: A Teaching Concept in Engineering Education. *2017 6th IIAI International Congress on Advanced Applied Informatics (IIAI-AAI)*, 681–686. <https://doi.org/10.1109/IIAI-AAI.2017.35>
- Bae, H., Glazewski, K., Brush, T., & Kwon, K. (2021). Fostering transfer of responsibility in the middle school PBL classroom: An investigation of soft scaffolding. *Instructional Science*, *49*(3), 337–363. <https://doi.org/10.1007/s11251-021-09539-4>
- Bandura, A. (1989). Human Agency in Social Cognitive Theory. *American Psychologist*, *10*.
- Bumblauskas, D., & Vyas, N. (2021). *The Convergence of Online Teaching and Problem Based Learning Modules amid the COVID-19 Pandemic*. *19*(3), 12.
- Colombo, S., & Golzio, L. (2016). The Plant Simulator as viable means to prevent and manage risk through competencies management: Experiment results. *Safety Science*, *84*, 46–56. <https://doi.org/10.1016/j.ssci.2015.11.021>
- Denyer, D., & Tranfield, D. (2009). Producing a Systematic Review. In *The Sage Handbook of Organizational Research Methods* (pp. 671–689). Sage Publications Ltd.
- Dombrowski, U., Ernst, S., & Reimer, A. (2016). A New Training for Factory Planning Engineers to Create Awareness of Climate Change. *48*, 443–448. Scopus. <https://doi.org/10.1016/j.procir.2016.04.083>
- Du, X., Naji, K. K., Ebead, U., & Ma, J. (2021). Engineering instructors' professional agency development and identity renegotiation through engaging in pedagogical change towards PBL. *European Journal of Engineering Education*, *46*(1), 116–138. <https://doi.org/10.1080/03043797.2020.1832444>
- Filho, O. S. S., & Calado, R. (2013). Learning Supply Chain Management by PBL with A3 Report Support. *IFAC Proceedings Volumes*, *46*(24), 471–477. <https://doi.org/10.3182/20130911-3-BR-3021.00115>
- Gosavi, A., & Fraser, J. (2013). Problem-Based Learning and Industrial Engineering. *2013 ASEE Annual Conference & Exposition Proceedings*, 23.985.1-23.985.10. <https://doi.org/10.18260/1-2--22370>
- Grasas, A., & Ramalhinho, H. (2016). Teaching distribution planning: A problem-based learning approach. *The International Journal of Logistics Management*, *27*(2), 377–394. <https://doi.org/10.1108/IJLM-05-2014-0075>
- Grigoreva, A., & Sorensen, L. T. (2020). Developing Enterprise Architecture Skills in HEI's: A Russian survey. *Proceedings of the International Scientific Conference - Digital Transformation on Manufacturing, Infrastructure and Service*, 1–6. <https://doi.org/10.1145/3446434.3446530>
- Hisjam, M. (2019). *Problem Based Learning for Techno-economic Analysis for Logistics System Course: Cases in State-owned Warehouse*. 7.
- Jackson, K., & Wiles, G. (2013). Using Nonlinear Programming to Optimize the Fiber Packing Density of Optical Fiber Cables- A Short Problem-Based Learning Course. *2013 ASEE Annual Conference & Exposition Proceedings*, 23.1331.1-23.1331.10. <https://doi.org/10.18260/1-2--22716>

- Jaeger, A., Mayrhofer, W., Kuhlmann, P., Matyas, K., & Sihn, W. (2012). *The "Learning Factory": An immersive learning environment for comprehensive and lasting education in industrial engineering*. 6.
- Jaeger, A., Mayrhofer, W., Kuhlmann, P., Matyas, K., & Sihn, W. (2013). Total immersion—Hands and heads-on training in a learning factory for comprehensive industrial engineering education.pdf. *The International Journal of Engineering Education*, 29(1), 23–32.
- Janno, J., & Körbe Kaare, K. (2022). Problem-Based Learning Contribution to Master's Studies in Logistics and Supply Chain Management. In M. E. Auer, H. Hortsch, O. Michler, & T. Köhler (Eds.), *Mobility for Smart Cities and Regional Development—Challenges for Higher Education* (Vol. 389, pp. 492–503). Springer International Publishing. [https://doi.org/10.1007/978-3-030-93904-5\\_49](https://doi.org/10.1007/978-3-030-93904-5_49)
- Jin, H. W. (2015). Analysis of student behavior in the beer game. *International Journal on Information*, 1–9.
- Katzlinger, E. (2008). *Exploratory learning through role playing simulation games in e-business education: Experiences with the beer game in the university education*. 2008-January, 219–226. Scopus. <https://www.scopus.com/inward/record.uri?eid=2-s2.0-84938589488&partnerID=40&md5=b98025f57405ff1ef7c26c0634e4a6f6>
- Lagраста, F. P., Pontrandolfo, P., & Scozzi, B. (2021). *Circular Economy Business Models for the Tanzanian Coffee Sector: A Teaching Case Study*. 28.
- Lau, H. Y. K., & Mak, K. L. (2005). A configurable e-learning system for industrial engineering. *International Journal of Engineering Education*, 21(2 PART 1), 262–276. Scopus.
- Lau, H. Y. K., Mak, K. L., & Ma, H. (2006). IMELS: An e-learning platform for industrial engineering. *Computer Applications in Engineering Education*, 14(1), 53–63. Scopus. <https://doi.org/10.1002/cae.20067>
- Louw, L., & Deacon, Q. (2020). Teaching Industrie 4.0 technologies in a learning factory through problem-based learning: Case study of a semi-automated robotic cell design. *Procedia Manufacturing*, 45, 265–270. <https://doi.org/10.1016/j.promfg.2020.04.105>
- Maganha, I., Pereira, T. F., Pugliese, L. F., Santos, A. C. O., & Andersen, A.-L. (2022). A Learning Factory for Teaching the Transition from Conventional to Industry 4.0 Based Systems. In A.-L. Andersen, R. Andersen, T. D. Brunoe, M. S. S. Larsen, K. Nielsen, A. Napoleone, & S. Kjeldgaard (Eds.), *Towards Sustainable Customization: Bridging Smart Products and Manufacturing Systems* (pp. 903–910). Springer International Publishing. [https://doi.org/10.1007/978-3-030-90700-6\\_103](https://doi.org/10.1007/978-3-030-90700-6_103)
- Makio, J., Makio-Marusik, E., Yablochnikov, E., Arckhipov, V., & Kipriianov, K. (2017). Teaching cyber physical systems engineering. *IECON 2017 - 43rd Annual Conference of the IEEE Industrial Electronics Society*, 3530–3535. <https://doi.org/10.1109/IECON.2017.8216597>
- Martínez León, H. C. (2019). Bridging theory and practice with Lean Six Sigma capstone design projects. *Quality Assurance in Education*, 27(1), 41–55. <https://doi.org/10.1108/QAE-07-2018-0079>
- Martinez Leon, H., & Crimi, M. (2019). Assessing the Impact of University-Industry collaborative Lean Six Sigma Capstone Projects on Engineering Management Students. *2019 ASEE Annual Conference & Exposition Proceedings*, 32122. <https://doi.org/10.18260/1-2--32122>
- Masse, C., Martinez, P., Mertiny, P., & Ahmad, R. (2019). A Hybrid Method Based on Systems Approach to Enhance Experiential Learning in Mechatronic Education. *2019 7th International Conference on Control, Mechatronics and Automation (ICCMA)*, 403–407. <https://doi.org/10.1109/ICCMA46720.2019.8988746>
- May, M.-D. (2022). Physical and Virtual Game Based Experiential Learning for Supply Chain and Operations Management Teaching Practice and Effectiveness. *2022 IEEE Global Engineering Education Conference (EDUCON)*, 1113–1120. <https://doi.org/10.1109/EDUCON52537.2022.9766394>
- McLeod, A., & Savoy, A. (2009). Problem Based Teaching And Learning In An Introductory Level Lean Manufacturing Systems Course. *2009 Annual Conference & Exposition Proceedings*, 14.981.1-14.981.14. <https://doi.org/10.18260/1-2--5210>
- Miller, K. E., Hill, C., & Miller, A. R. (2016). Bringing Lean Six Sigma to the Supply Chain Classroom: A Problem-Based Learning Case: Lean Six Sigma to the Supply Chain. *Decision Sciences Journal of Innovative Education*, 14(4), 382–411. <https://doi.org/10.1111/dsji.12107>

- Mohd Salleh, N. A., & Yusof, K. M. (2017). Industrial Based Final Year Engineering Projects: Problem Based Learning (PBL). *2017 7th World Engineering Education Forum (WEEF)*, 782–786. <https://doi.org/10.1109/WEEF.2017.8467149>
- Muttamara, A., Nakwong, P., & Pararach, S. (2020). *Problem-based learning (PBL) implemented in manufacturing processes*. *10*, 174–178. Scopus. <https://www.scopus.com/inward/record.uri?eid=2-s2.0-85090824803&partnerID=40&md5=8e2660c48797e74f48279f72b937fb85>
- Oberc, H., Prinz, C., Glogowski, P., Lemmerz, K., & Kuhlenkötter, B. (2019). Human Robot Interaction – learning how to integrate collaborative robots into manual assembly lines. *Procedia Manufacturing*, *31*, 26–31. <https://doi.org/10.1016/j.promfg.2019.03.005>
- Ortega-González, Y., Carli, G., Grandi, A., & Delgado-Fernández, M. (2009). *The specification of competency questions: An ontological support to match business processes, IT and competences of professionals*. 531–539. Scopus. <https://www.scopus.com/inward/record.uri?eid=2-s2.0-84893149036&partnerID=40&md5=e8e48d811380897c521089d522570612>
- Ramos, F., & Espinosa, E. (2003). A Self-Learning Environment based on the PBL Approach: An Application to the Learning Process in the Field of Robotics and Manufacturing Systems. *International Journal of Engineering Education*, *19*(5), 754–758.
- Rodríguez, F., Guzmán, J. L., Castilla, M., Sánchez-Molina, J. A., & Berenguel, M. (2016). A proposal for teaching SCADA systems using Virtual Industrial Plants in Engineering Education. *IFAC-PapersOnLine*, *49*(6), 138–143. Scopus. <https://doi.org/10.1016/j.ifacol.2016.07.167>
- Roethlein, C. J., McCarthy Byrne, T. M., Visich, J. K., Li, S., & Gravier, M. J. (2021). Developing a distinctive consulting capstone course in a supply chain curriculum. *Decision Sciences Journal of Innovative Education*, *19*(2), 117–128. <https://doi.org/10.1111/dsji.12235>
- Ruiz-Cantisani, M. I., Martinez-Medina, G., & Ramirez-Robles, L. A. (2022). Stakeholders' perspective using challenge-based learning and industry partnerships to develop competencies: Case study in industrial engineering. *Proceedings of the 20th LACCEI International Multi-Conference for Engineering, Education and Technology: "Education, Research and Leadership in Post-Pandemic Engineering: Resilient, Inclusive and Sustainable Actions."* 20th LACCEI International Multi-Conference for Engineering, Education and Technology: "Education, Research and Leadership in Post-pandemic Engineering: Resilient, Inclusive and Sustainable Actions." <https://doi.org/10.18687/LACCEI2022.1.1.731>
- Savery, J. R. (2006). Overview of Problem-based Learning: Definitions and Distinctions. *Interdisciplinary Journal of Problem-Based Learning*, *1*(1). <https://doi.org/10.7771/1541-5015.1002>
- Servant-Miklos, V. (2020). Problem-oriented Project Work and Problem-based Learning: "Mind the Gap!" *Interdisciplinary Journal of Problem-Based Learning*, *14*(1). <https://doi.org/10.14434/ijpbl.v14i1.28596>
- Shi, J., & Zhang, L. (2013). *An analysis of the development of student entrepreneurship abilities based on PBL mode of instruction*. *2*, 392–396. Scopus. <https://doi.org/10.1109/ICIII.2013.6703168>
- Simons, S., Abé, P., & Naser, S. (2017). Learning in the AutFab – The Fully Automated Industrie 4.0 Learning Factory of the University of Applied Sciences Darmstadt. *Procedia Manufacturing*, *9*, 81–88. <https://doi.org/10.1016/j.promfg.2017.04.023>
- Snider, B., Southin, N., & Cole, R. (2019). Patio Swings Intermodal Shipping Competition: An Inquiry-Based Partial Information Exercise. *Decision Sciences Journal of Innovative Education*, *17*(2), 146–162. <https://doi.org/10.1111/dsji.12174>
- Steffen, M., May, D., & Deuse, J. (2012). The Industrial Engineering Laboratory. *Proceedings of the 2012 IEEE Global Engineering Education Conference (EDUCON)*, 1–10. <https://doi.org/10.1109/EDUCON.2012.6201098>
- Suliman, S. M. A. (2004). Towards problem-based engineering education. *International Journal of Continuing Engineering Education and Lifelong Learning*, *14*(1/2), 167. <https://doi.org/10.1504/IJCELL.2004.004582>

- Sutopo, W., & Aqidawati, E. F. (2019). *Learning a Supply Chain Management Course by Problem Based Learning: Case Studies in the Newspaper Industry*. 12.
- Tortorella, G., & Cauchick-Miguel, P. A. (2017). An initiative for integrating problem-based learning into a lean manufacturing course of an industrial engineering graduate program. *Production*, 27(spe). <https://doi.org/10.1590/0103-6513.224716>
- Tuulos, T., Kauppinen, T., Peñafort, L. R. I., & Ospina, D. I. R. (2017). Around the world in 36 hours— Understanding the dynamics of the global product design relay marathon. *Proceedings of the 45th SEFI Annual Conference 2017 - Education Excellence for Sustainability, SEFI 2017*, 177–185.
- Veza, I., Gjeldum, N., & Mladineo, M. (2015). Lean Learning Factory at FESB – University of Split. *Procedia CIRP*, 32, 132–137. <https://doi.org/10.1016/j.procir.2015.02.223>
- Wood, J. C. (2002). Using problem-based learning to modify curriculum to meet industry needs. *ASEE Annu. Conf. Proc.*, 5633–5639. Scopus. <https://www.scopus.com/inward/record.uri?eid=2-s2.0-8744295930&partnerID=40&md5=e261ad70616877930dee2456c5d9c2e2>
- Zhong, R. Y., & Huang, G. Q. (2014). RFID-enabled Learning Supply Chain: A Smart Pedagogical Environment for TELD. *International Journal of Engineering Education*, 30(2), 471–482.

# A Systematic Review of PBL Literature: In Search of Support for Engineering Situated Problem Design Guidelines

Andrew Olewnik

University at Buffalo, United States, [olewnik@buffalo.edu](mailto:olewnik@buffalo.edu)

Amanda Horn

University at Buffalo, United States, [ahorn@buffalo.edu](mailto:ahorn@buffalo.edu)

Laine Schrewe

University at Buffalo, United States, [lainesch@buffalo.edu](mailto:lainesch@buffalo.edu)

**Keywords:** problem design, engineering, literature review

**Type of contribution:** Research extended abstract

## 1 Introduction

Problem-based learning (PBL) encompasses teaching methodologies that rely on learning experiences that are based on real-world problems and engaged by small student groups that are supported by instructor facilitation (Felder et al., 2011; Graaf & Kolmos, 2003; Servant-Miklos et al., 2019). PBL allows engineering students to actively engage with the materials to build necessary skills as future engineers. In comparison to traditional teacher-centered teaching methods, instructors utilizing PBL instead act as a guide for students to gather pertinent information and solve problems.

While this unique teaching and learning environment is beneficial to students, it also presents challenges to both instructors and students. Our research group approached this literature review as a team working to transition an introductory aerospace engineering course from traditional instruction to PBL. This frame of references brings our focus to PBL research at a course level (Chen et al., 2021). During our initial search for literature, we approached it with three questions: 1) how do you design a problem for PBL? 2) how do you facilitate PBL? and 3) how do you assess PBL? In this extended abstract, we focus on the first research question. Overall, this work is motivated to understand how prior work within engineering education spaces might inform other faculty who seek to adopt PBL.

## 2 Reference Frame

We imagine the PBL environment as enabling interactions between instructor and students around more open and ill-defined problems. In such a student-centered environment these interactions would be expected to follow less predictable paths than those found in the more traditional, instructor-centered environments. In traditional environments, knowledge transfer is typically lecture based and application of knowledge is exercised in closed-ended story problems (Jonassen, 2014). Our conceptual model of the interactions that we envision in the PBL setting is shown in Figure 1. The pathways are labeled and defined as follows. Path (1) flows from faculty to problem and focuses on challenges related to problem design. It is critical that instructors design realistic problems, but these problems will inherently be more ill-defined and open to interpretation. Path (2) focuses on the relationship between students and the problem. Both paths (1) and (2) represent the relationship between the students and faculty as it connects with the problem. To better understand this relationship, we approached

the literature with three questions in mind: **Q1: How should faculty design problems that build upon students' varied prior knowledge? Q2: What format and type and level of information should be provided in the problem statement? Q3: How much should students be involved in framing and scoping of the problem?**

Path (3) represents the direct relationship between faculty and students without the problem. The lack of structure PBL can be a shock for both faculty and students (Chen et al., 2021) that can lead to familiar practices such as lecture; can undermine learning (Hmelo-Silver et al., 2019). Finding a comfortable balance between facilitator and teacher can be challenging. We wondered: Q4: How do structure and scaffold the learning to balance the dual facilitator/teacher role?

Paths (4) and (5) represent the faculty and student relationship as it relates to identifying and producing knowledge. In a PBL environment, rather than faculty transferring knowledge, students also have the responsibility to discover and produce knowledge related to problem solving. This shift in the balance of knowledge acquisition led to a fifth question. Q5: How much knowledge should students be expected to produce/acquire as they go?

Path (6) considers the artifacts produced that will demonstrate student growth as they work toward a solution. Path (7) represents the assessment and faculty feedback related to that progress. Paths (6) and (7) are focused on the overall relationship between faculty and students as it relates to the solution artifacts. This led to two questions. Q6: How and when should students be assessed? Q7: What kind of evidence or artifacts should students be creating to support that assessment?

We describe the questions to provide the broader context of this research. In this work we focus on the paths related to problem design as reflected in questions Q1-Q3.

### 3 Methodology

We conducted a systematic review of the literature following the PRISMA model (PRISMA, 2023). Our focus was on PBL within engineering in higher education. We identified potential journals as well as papers from annual conferences. This included but was not limited to the European Journal of Engineering Education, Journal of Problem Based Learning in Higher Education, Interdisciplinary Journal of Problem Based Learning as well as the American Society of Engineering Education conference. EBSCO Host was utilized to search for relevant articles related to PBL published within the respective journals. Considering papers from the past 25 years, this initial identification process yielded 195 papers. Additional filtering occurred over three phases. In the first phase, we reviewed the abstracts and searched for terms including engineering, higher education, and PBL to ensure that our base criteria were met. These terms allowed us to remove manuscripts that did not align with the engineering domain or appeared to report a reflection on a PBL experience rather than describe a research study. This reduced the number of papers to 88. In the second phase, we skimmed each paper to determine if it may provide insights on our seven research questions. This reduced the number of papers to 51. In the final filtering phase, we reviewed each paper more deeply, explicitly looking to understand specific claims as it relates to any of the questions and the evidence to support those claims. This reduced the number of papers to 36.

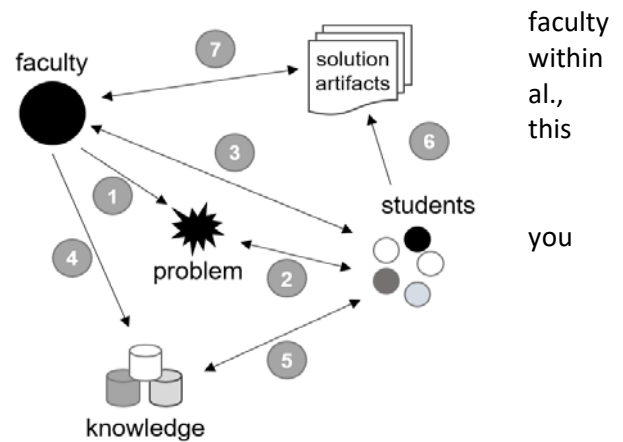

Figure 1. Conceptual model of PBL interaction

faculty  
within  
al.,  
this  
  
you

## 4 Findings

Each of the 36 papers included in this work provided some level of insight on at least one of the questions described in the Reference Frame section. The focus of this extended abstract is on the problem design aspect of PBL; thus, we only include findings related to that aspect (Q1-Q3). A total of eight papers were applicable: five for Q1, three for Q2, and one for Q3. We discuss questions individually here and synthesize findings as part of the Discussion.

### 4.1 Q1: How should faculty design problems that build upon students' varied prior knowledge?

Five papers were found that related to Q1. Most papers in this category highlighted the value of designing problems such that the topics explored are familiar to students. The rationale for this logic is that when students are more comfortable with the topics covered, they will be more likely to engage in the problem. For example, Riis et al. (2017) claim that idea generation and "intuitive evaluation" of proposed solutions is improved ("more fruitful") when concepts that are readily comprehensible and easily understood by the students are used. However, it is unclear what is meant by "intuitive" and how prior knowledge that fits that definition is explicitly accommodated in problem design. Similarly, McLoone et al. (2016) describe learning modules with content related to a PBL course being taught in the prior semester as important to student success. However, there is no specific guidance on how prior knowledge is integrated within problems designed for the PBL experience.

Garcia-Barriocanal et al. (2011) describe an approach rooted in novice/expert comparison to systematically find gaps in prior knowledge to support the development of additional related (sub-) problems that can be used to build student knowledge. The intent is to scaffold learning to build up students' ability to handle increasingly ill-structured problems. The method sounds promising but there were no specific examples demonstrating how existing problems were evolved or how new problems were created based on the approach.

### 4.2 Q2: What format and type and level of information should be provided in the problem statement?

Three papers addressed this question to some level, though not at the granularity that might be necessary to support PBL adoption by faculty. Khalaf et al. (2013) summarize efforts to create three different problems "from an iterative process of prototyping, running, analyzing and redesigning" to create problem "cores" that can be covered with different "skins." The core of each problem is aligned with specific skills or competencies deemed important to a biomedical engineering setting - probability/statistics in health screening and decision making, experimental design, and mathematical modeling/computer simulation - and serve to introduce students to that world. While the paper informs some thinking about the philosophy behind a problem (or set of problems) at the center of a PBL environment and provides an example problem statement it does not provide guidelines on how to develop additional problems. It also does not provide specific information on how iteration and analysis supported problem evolution.

Similarly, Mitchell et al. (2010) describe the philosophy and shift to a PBL curriculum. There is a brief discussion about how problems (called "trigger material") were formulated through a top-down structure that starts with selecting appropriate topics and skills. Consideration of specific technical knowledge (content knowledge) and engineering specific skills (transferable skills) are described. There is no evidence regarding the effectiveness of the approach to designing problems. There is an example problem statement ("trigger material") provided as representative of the underlying philosophy but nothing is explicitly mapped in terms of knowledge and skills to aspects of the problem statement.

Diaz et al (2013) describe a systematic analysis that considers 40 factors to find and formulate the nine biggest challenges in problem- and project-based learning. The approach is based on a survey of eight faculty as representative of the 40 faculty in the program. Through cause-effect analysis they map factors to areas of methodology, resources, teachers, and students. Thus, the evidence is conceptual and derived from their experience as a group with PBL. As it relates to developing problems at an appropriate level of detail, they propose the use of limited topics, curating references (e.g., classic books) related to the topic, use of patent databases, and visit and support seminars. However, there are no specific examples of problem statements that result from these guidelines.

### 4.3 Q3: How much should students be involved in framing and scoping of the problem?

One paper was related to supporting students as part of problem framing and scoping activities. Holgaard et al. (2017) present a 5-step model to support students in defining the problem: 1) relating to a theme, 2) mapping the problem field, 3) narrowing down the problems, 4) problem analysis and contextualization, problem formulation. This is a conceptual model inspired by findings from interviews with PBL staff and students from two programs at Aalborg university. However, there is no evidence as it relates to the effectiveness of this approach to involve students in framing and scoping of problems. Additionally, the approach may be more appropriate in project-based learning environments, where engagement with a problem occurs over a longer period.

## 5 Discussion and Conclusion

Designing problems for PBL can be time consuming and requires skills to develop problems that are appropriate and a positive learning experience for students. Problems should reflect real-world problems that students may experience in their future professional lives. Generally, problem design is recognized as a challenge that deters faculty from engaging PBL. In this (ongoing) literature review, we considered prior work specifically situated in engineering education to understand how that work might be operationalized by faculty in PBL problem design.

Prior work suggests that students' prior knowledge is a critical consideration that should inform problem design. However, there was no specific evidence included in the papers to support this claim, and it seems to be based more on instructor perceptions than evidence derived from research. This idea is logical in that educational experiences often leverage building on prior knowledge. However, a valued principle of PBL is that it makes students responsible for knowledge acquisition as part of their problem engagement. We found no discussion in the literature about the level of prior knowledge students should have.

In addition, none of the papers specify how to integrate prior knowledge into the problem statement. We note a lack of explicit mapping between pedagogical philosophy that drives problem design and the problem representation. Generally, reviewed papers described guiding principles and/or specific knowledge constructs or learning outcomes that problems should engender. However, how that specifically informs the design of the problem is vague. Of note is that in the papers reviewed related to problem design there are limited examples or specific evidence of well-designed problems that might be considered exemplars that include supporting ideology explaining why the problem design is effective.

Thus, one path forward in overcoming this gap is to take a community-based approach to developing problems. Specifically, using proposed guidelines from engineering specific PBL papers in combination with more general design principles like 3C3R (Hung, 2006, 2016), a community of PBL researchers/implementers might co-develop and test the efficacy of problem design methods. This might allow for manipulation of problem design factors in a mixed design-based research/controlled experimental paradigm within a community of practice around PBL problem design.



## 6 References

- Chen, J., Kolmos, A., & Du, X. (2021). Forms of implementation and challenges of PBL in engineering education: A review of literature. *European Journal of Engineering Education*, 46(1), 90–115. <https://doi.org/10.1080/03043797.2020.1718615>.
- Diaz Lantada, A., Morgado, P., Munoz-Guijosa, J., Sanz, J., De la Guerra, E., Otero, J., & Chacón Tanarro, E. (2013). Towards Successful Project-Based Teaching-Learning Experiences in Engineering Education. *International Journal of Engineering Education*, 29.
- Felder, R. M., Brent, R., & Prince, M. J. (2011). Engineering instructional development: Programs, best practices, and recommendations. *Journal of Engineering Education*, 100(1), 89–122.
- Garcia-Barriocanal, E. & Sanchez-Alonso, S. (2011). Devising instruction from empirical findings on student errors: A case in usability engineering education. *International Journal of Engineering Education*, 27(1), 24–30.
- Graaff, E. D., & Kolmos, A. (2003). Characteristics of problem-based learning. *International Journal of Engineering Education*, 657–662.
- Hmelo-Silver, C. E., Bridges, S. M., & McKeown, J. M. (2019). Facilitating Problem-Based Learning. In *The Wiley Handbook of Problem-Based Learning* (pp. 297–319). John Wiley & Sons, Ltd. <https://doi.org/10.1002/9781119173243.ch13>.
- Holgaard, J. E., Guerra, A., Kolmos, A., & Petersen, L. S. (2017). Getting a hold on the problem in a problem-based learning environment. *The International Journal of Engineering Education*, 33(3), 1070–1085.
- Hung, W. (2006). The 3C3R model: A conceptual framework for designing problems in PBL. *The Interdisciplinary Journal of Problem-Based Learning*, 1(1).
- Hung, W. (2016). All PBL starts here: The problem. *The Interdisciplinary Journal of Problem-Based Learning*, 10(2).
- Jonassen, D. H. (2014). Engineers as Problem Solvers. In Aditya Johri & Barbara M Olds (Eds.), *Cambridge Handbook of Engineering Education Research* (pp. 103–118). Cambridge University Press.
- Khalaf, K., Newstetter, W., & Alsafar, H. (2013). Globalization of problem-driven learning: design of a system for transfer across cultures. In *Proceedings of the 4th International Research Symposium on Problem-Based Learning* (pp.3-8).
- McLoone, S., Lawlor, B., & Meehan, A. (2016). The implementation and evaluation of a project-oriented problem-based learning module in a first year engineering programme. *Journal of Problem Based Learning in Higher Education*, 4(1).
- Mitchell, J. E., Canavan, B., & Smith, J. (2010). Problem-Based Learning in Communication Systems: Student Perceptions and Achievement. *IEEE Transactions on Education*, 53(4), 587–594. <https://doi.org/10.1109/TE.2009.2036158>
- PRISMA. (2023). Retrieved February 28, 2023, from <http://www.prisma-statement.org/>
- Riis, J. O., Achenbach, M., Israelsen, P., Kyvsgaard Hansen, P., Johansen, J., & Deuse, J. (2017). Dealing with complex and ill-structured problems: Results of a Plan-Do-Check-Act experiment in a business engineering semester. *European Journal of Engineering Education*, 42(4), 396–412. <https://doi.org/10.1080/03043797.2016.1189881>
- Servant-Miklos, Norman, G. R., & Schmidt, H. G. (2019). A Short Intellectual History of Problem-Based Learning. In *The Wiley handbook of problem-based learning* (pp. 3–24). John Wiley & Sons, Inc. <https://doi.org/10.1002/9781119173243.ch1>
- Tik, C. C. (2014). Problems implementing problem-based learning by a private Malaysian University. *Journal of problem based learning in higher education*, 2(1).

# Work-in-Progress: STEMification - towards a framework for supporting teachers' professional development in PBL with a focus on engineering education transitions

Sanne Lisborg

Aalborg University, Denmark, [sali@plan.aau.dk](mailto:sali@plan.aau.dk)

Søren Hansen

Aalborg University, Denmark, [sha@plan.aau.dk](mailto:sha@plan.aau.dk)

Lykke Brogaard Bertel

Aalborg University, Denmark, [lykke@plan.aau.dk](mailto:lykke@plan.aau.dk)

Mette Møller Jeppesen

Aalborg University, Denmark, [mmje@adm.aau.dk](mailto:mmje@adm.aau.dk)

Bettina Dahl

Aalborg University, Denmark, [bdahls@plan.aau.dk](mailto:bdahls@plan.aau.dk)

Sofie Otto

Aalborg University, Denmark, [sio@plan.aau.dk](mailto:sio@plan.aau.dk)

Camilla Guldborg

Aalborg University, Denmark, [cgni@plan.aau.dk](mailto:cgni@plan.aau.dk)

Lars Bo Henriksen

Aalborg University, Denmark, [lbh@plan.aau.dk](mailto:lbh@plan.aau.dk)

Jakob Farian Krarup

University College of Northern Denmark, Denmark, [jfk@ucn.dk](mailto:jfk@ucn.dk)

## Summary

To ensure a more diverse group of engineering candidates in the future, increased attention to transitions is needed in STEM education, e.g. by implementing more student-centred and inclusive STEM teaching approaches and practices across all levels of education through professional development. In this abstract, we argue for a holistic understanding of transitions in engineering education both concerning *content* (transitions related to curriculum development and a shift in focus from scientific knowledge to STEM competencies); *cohesion* (transitions between subjects and transformation of disciplines toward integrated and interdisciplinary engineering education for sustainable development); and *continuity* (transitions in the education system through cross-institutional collaboration and coordinated pedagogical approaches). We introduce *STEMification* as a conceptual framework for facilitating engineering education transitions and trajectories, and as an approach to support teachers' professional development towards integrated and inclusive STEM teaching across all educational levels. The framework is developed within the Danish research project, LabSTEM North, and builds upon principles from problem-based learning, inquiry-based learning and creative platform learning to offer multiple pathways for supporting student motivation and the development of STEM competencies, applicable to all STEM disciplines at all levels of education.

**Keywords:** STEM, problem-based learning, engineering education transitions, design-based research, professional development

**Type of contribution:** Research extended abstracts

## 1 Introduction

There is a pressing need to better understand and ease ‘transitions’ in STEM education, both horizontally across subjects (Science, Technology, Engineering and Math) and vertically at all levels of education, if we are to establish a continuing interest in engineering education. Many students experience STEM teaching as abstract and difficult to relate to, why they lose interest in STEM during their school years (Osborne & Dillon, 2008). The decline interest in STEM, which is predicted to continue in the future, is both an industrial and societal problem as the lack of diverse and well-prepared engineering graduates affects both industry and society’s ability to respond to demands for green transition and sustainable solutions as well as the digital transformation accelerated by emerging technologies (European Commission, 2015; CEDEFOP 2020; UNESCO 2021). Thus, new and inclusive ways of teaching the STEM disciplines are needed, focusing on complex and interdisciplinary problem solving and the development of transversal STEM competences (Bertel, Winther, Routhe & Kolmos, 2021).

In this extended abstract, we argue that cross-institutional collaboration and a broad focus on transitions can contribute to ensuring a diverse group of engineering graduates, who are well-equipped to contribute to the fulfilment of the Sustainable Development Goals (UNESCO, 2021). We argue that an integrated STEM approach is needed and explore its possible structure and potential as a professional development tool, based on the following research questions:

*How can a focus on authentic problems (problem-based learning), personal motivation (inquiry-based learning), play and creativity (creative platform learning) facilitate an integrated framework for STEM teaching? And how can such a framework contribute as a professional development tool in teachers’ cross-institutional and collaborative professional learning communities?*

## 2 The LabSTEM North Project

The abstract is based on research and development conducted within LabSTEM North (2021-2024), a Danish design-based research project established to develop a framework for PBL-based and STEM-integrated teaching and to support interdisciplinary and cross-institutional collaboration to enhance students’ interest in STEM disciplines throughout the entire education system (Christiansen, Bertel & Dahl, 2022). In the project, STEM-integrated teaching is understood as teaching practices where a minimum of two or more STEM subjects are addressed and integrated (e.g. through a PBL approach) with the overall aim of increasing student interest and diversity in STEM. So far, thirteen educational institutions with more than 80 teachers from primary schools, (technical and general) high schools, pre-college engineering and vocational schools, and higher education institutions in the northern region of Denmark participate in the project. Thus, a central part of the project is to gather knowledge of best practices from programs or initiatives particularly successful in ensuring diversity in STEM (Bertel, Jeppesen, Henriksen, Hansen & Dahl, 2022) as well as to develop new approaches and practices through accessible and sustainable cross-institutional collaboration in ‘hybrid’ teacher communities, where practitioners can co-create and share ideas, digital resources, and teaching materials (Christiansen, Bertel & Dahl, 2022). This is done through a design-based research approach where teachers develop cross-institutional and cross-disciplinary designs for STEM teaching. The proposed STEMification framework is based on the development and implementations of these teaching designs and is continually being tested and refined as the project progresses (Edelson, 2020).

### 3 STEMification: An integrative *and* diversified approach to STEM

As part of the LabSTEM North project, we have explored different ways in which motivation for STEM can be enhanced, resulting in what we call the *STEMification framework*. To motivate more students for STEM-related educations we argue, that working with authentic problems related to the STEM professions and in connection to a personal learning experience and inner desire for learning in a creative, playful learning environment is crucial across all levels of education. Figure 1 below illustrates how the different learning principles are combined in the framework. It is important to note that while the framework draws on and highlights distinct aspects of these pedagogical models and methods, the purpose is not to distinguish these from one another. Rather, they represent shared principles and approaches, proposing multiple potential pathways towards a common goal; to facilitate curiosity and participation in STEM and to ease educational transitions and create diverse learning trajectories.

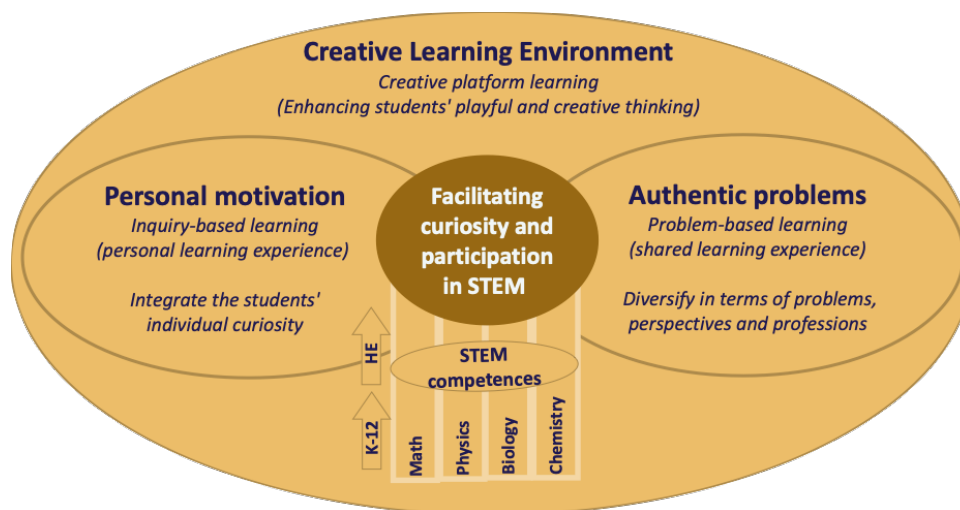

Figure 1. The STEMification framework

#### *Transversal STEM competencies*

As seen from figure 1, when teaching science (biology, chemistry, and physics) or mathematics, the content of the disciplines can be motivating to some students in and of itself, particularly if students believe they are capable within these subjects (Trujillo & Tanner, 2014; Webb-Williams, 2018; Bertel et al. 2022). This can be further encouraged by a focus on the transversal competencies that belong to and bridge each of the four areas of STEM, such as *posing research questions, develop a hypothesis, designing an experiment to answer the question, and critically assess the results*. By implementing an integrated approach, students learn that these competencies are transversal, i.e. recognizable and applicable across disciplines, and that practicing them in one subject will facilitate not only a deeper understanding of the specific subject, but also learning in other, related STEM disciplines.

#### *Authentic problems and problem-based learning*

Working with authentic, real-life problems as highlighted in problem-based learning (PBL), can be very motivating to students particularly as the knowledge is contextualized and often put to practical use in concrete engineering design and problem-solving processes (Kolmos et al., 2013). A focus on real-life and complex problems acknowledges the contribution of different and multifaceted disciplines and highlights the

need for interdisciplinary approaches to complex problem-solving (Bertel et al., 2021). This can be further reinforced if the teacher acts as a STEM role model that demonstrates how discipline-specific problems often represent broader societal challenges and thus the needs and pains that scientists and engineers face daily (Markula & Aksela, 2022).

#### *Personal motivation and curiosity*

Moreover, it is central to work with the student's personal motivation by encouraging them to ask and pursue questions, thus acting as an intrinsic motivator for the students' learning. Here, we are inspired by inquiry-based learning, where the student-driven investigation and engagement is the central element in the learning process (Pedaste et al., 2015; Bayram, Oskay, Erdem, Özgür & Şen, 2013). Asking questions and seeking answers can be highly motivating, if the questions are born out of curiosity – a desire for new knowledge that becomes an *inner* motivator. Therefore, one of the pedagogical principles in STEMification, is to facilitate learning processes that are grounded in the student's *own* curiosity. If we want to motivate more students for STEM-related educations, the real-life problems the students are working on must be related to a personal inner desire for learning; a burning curiosity to know more.

#### *Creative Learning Environment*

Finally, for students to engage with real-world problems and learning based on their own curiosity, the learning environment must offer focus, inspiration, and creative collaboration. Focus, to be able to connect a discipline, or a problem, to personal knowledge and experiences. Inspiration, facilitated by a teacher to help students connect their questions and experiences to disciplines. Creative collaboration, with the teacher and other students to co-construct new knowledge. It is a process of blending the content of disciplines with problems and personal experiences and where students engage with an open and curious mind, because the fear of failing and sense of judgement is suspended. This aspect of the STEMification framework is inspired by the creative platform (Hansen & Byrge 2009; Byrge & Hansen 2009).

## 4 STEMification in practice: Testing the framework as a professional development tool in interdisciplinary and cross-institutional teacher learning communities

So far, we have introduced the framework to 75 teachers and tested it in three iterations of workshops focusing on developing it in collaboration with the teachers. The first three iterations of workshops have highlighted a need to broaden our understanding of transitions in K-12 STEM and engineering education. Whereas the problem with existing STEM education is often that too many are excluded from participating in the problem solving due to gender, ethnicity, neurodiversity, or other socio-economic factors, this problem cannot be reduced to merely a matter of 'fixing the leaky pipeline' (European Parliament, 2021; CEDEFOP, 2020). Rather, increased attention to the narrative of 'what makes a good engineer' is needed as well as an overall strengthening of content, cohesion, and continuity in the transformation of STEM in the entire education system.

*Content* here refers to the need to redirect the focus from subjects and syllabi to competences and pressing issues and transitions in society and technology, i.e. sustainability issues and the impact of rapid digitalization accelerated by emerging technologies on society through working with authentic real-life problems across STEM disciplines at all levels. Particularly in higher engineering education, these problems and solutions should represent and serve as good examples of the students' future profession as well (Kolmos & Holgaard, 2017). *Cohesion*, on the other hand, refers to transitions *between* subjects and disciplines, i.e. to create solutions to global sustainability problems we need to work with an integrative and coherent approach, accepting that a single discipline alone cannot solve the complex wicked problems and global challenges of today and tomorrow. Thus, it is essential that STEM education becomes less silo-oriented and more engaged with interdisciplinary problem-solving, also involving the Arts and Humanities, sometimes referred to as

STEAM (Perignat & Katz-Buonincontro, 2019). Finally, we argue that it is important to establish *continuity* across all education levels through collaboration to create a community of practice that facilitates successful transition, e.g. by ensuring that pedagogical frameworks and approaches are inclusive and recognizable as the student proceeds through the educational system (Bertel et al, 2022). Thus, the STEM teaching that students encounter from primary school to higher education must be based on real-life problems that facilitate inclusion and enable diverse learning trajectories in STEM.

## 5 Conclusion and next steps

In this abstract we propose the *STEMification framework* as an approach to support teachers' professional development in PBL and explore how a focus on authentic problems, personal motivation, play and creativity can facilitate integrated and diverse approaches to STEM teaching. The framework encompasses principles from both problem-based learning, inquiry-based learning and creative platform learning and is developed in collaboration with teachers in cross-institutional and cross-disciplinary professional learning communities in the design-based research project LabSTEM North. The framework is proposed as a way to ease transitions in science and engineering education both in terms of content, cohesion, and continuity. In line with the used DBR approach the empirical results from the workshops and subsequent observations of teaching as well as student/teacher interviews will inform the further analysis of the STEMification framework's applicability as a professional development tool at all levels of education. The results will be shared through research papers, digital resources, and teaching materials applicable in different levels of STEM and engineering education.

## 6 References

- Bayram, Z., Oskay, Ö. Ö, Erdem, E.; Özgür, S. D., & Şen, Ş. (2013). Effect of Inquiry based Learning Method on Students' Motivation. *Procedia, social and behavioral sciences*, 106, 988-996.
- Bertel, L. B., Jeppesen, M. M., Henriksen, L. B., Hansen, S., & Dahl, B. (2022, October). Bridging the Gender Gap through Problem-Based Learning in STEM Labs: What can we learn from Biotechnology?. *2022 IEEE Frontiers in Education Conference (FIE)*, 1-5. doi: 10.1109/FIE56618.2022.9962400.
- Bertel, L. B., Winther, M., Routhe, H. W., & Kolmos, A. (2021). Framing and facilitating complex problem-solving competences in interdisciplinary megaprojects: an institutional strategy to educate for sustainable development. *International Journal of Sustainability in Higher Education* (Print Edition), 23(5), 1173-1191. <https://doi.org/10.1108/IJSHE-10-2020-0423>
- Byrge, C., & Hansen, S. (2009). The creative platform: a didactic approach for unlimited application of knowledge in interdisciplinary and intercultural groups. *European Journal of Engineering Education*, 34(3), 235-250, DOI: 10.1080/03043790902902914
- CEDEFOP (2020). *Annual report 2019*. Luxembourg: Publications Office. <http://data.europa.eu/doi/10.2801/79286>
- Christiansen, S. H., Bertel, L. B., & Dahl, B. (2022). Problem-based learning in STEM: Facilitating Diversity and Change in Pre-college Engineering Education through Online Collaborative Teacher Communities in virtual STEMLabs. Paper presented at *2022 ASEE Annual Conference & Exposition*, Minneapolis, MN <https://strategy.asee.org/41222>
- Edelson, D. C. (2002). Design research: What we learn when we engage in design. *Journal of the Learning Science*, 11(1), 105–122. [https://doi.org/10.1207/S15327809JLS1101\\_4](https://doi.org/10.1207/S15327809JLS1101_4)
- European Commission (2015). *Does the EU need more STEM graduates? Final report*. LU: Publications Office. Available: <https://data.europa.eu/doi/10.2766/000444>
- European Parliament (2021). *Report on promoting gender equality in science, technology, engineering, and mathematics (STEM) education and careers*. Committee on Women's Rights and Gender Equality. Available: [https://www.europarl.europa.eu/doceo/document/A-9-2021-0163\\_EN.pdf](https://www.europarl.europa.eu/doceo/document/A-9-2021-0163_EN.pdf)

- Hansen, S., & Byrge, C. (2009). The Creative Platform: a new paradigm for teaching creativity. *Problems of Education in the 21st Century*, 18, 33-50. [http://www.scientiasocialis.lt/pec/files/pdf/vol18/33-50.Byrge\\_Vol.18.pdf](http://www.scientiasocialis.lt/pec/files/pdf/vol18/33-50.Byrge_Vol.18.pdf)
- Kolmos, A., & Holgaard, J. E. (2017). Impact of PBL and company interaction on the transition from engineering education to work. In *6th International Research Symposium on PBL: Social Progress and Sustainability*, 87-98. Aalborg University Press. International Research Symposium on PBL [http://vbn.aau.dk/files/260094430/IRSPBL\\_2017\\_Proceedings\\_1\\_.pdf](http://vbn.aau.dk/files/260094430/IRSPBL_2017_Proceedings_1_.pdf)
- Kolmos, A., Mejlgaard, N., Haase, S., & Holgaard, J. E. (2013). Motivational factors, gender and engineering education. *European Journal of Engineering Education*, 38(3), 340-358.
- Markula, A., & Aksela, M. (2022). The key characteristics of project-based learning: how teachers implement projects in K-12 science education. *Disciplinary and interdisciplinary science education research*, 4, [4:2], 1-17. <https://doi.org/10.1186/s43031-021-00042-x>
- Osborne, J., & Dillon, J. (2008). *Science Education in Europe: Critical Reflections*. Available: [https://www.researchgate.net/publication/252404504\\_Science\\_Education\\_in\\_Europe\\_Critical\\_Reflections](https://www.researchgate.net/publication/252404504_Science_Education_in_Europe_Critical_Reflections)
- Pedaste, M., Mäeots, M., Siiman, L. A., De Jong, T., Van Riesen, S. A., Kamp, E. T., & Tsourlidaki, E. (2015). Phases of inquiry-based learning: Definitions and the inquiry cycle. *Educational research review*, 14, 47-61.
- Perignat, E., & Katz-Buonincontro, J. (2019). STEAM in practice and research: An integrative literature review. *Thinking Skills and Creativity*, 31, 31–43. <https://doi.org/10.1016/j.tsc.2018.10.002>
- Trujillo, G., & Tanner, K. D. (2014). Considering the role of affect in learning: Monitoring students' self-efficacy, sense of belonging, and science identity. *CBE—Life Sciences Education*, 13(1), 6-15.
- UNESCO (2021). *Engineering for sustainable development: delivering on the Sustainable Development Goals*. UNESCO.
- Webb-Williams, J. (2018). Science self-efficacy in the primary classroom: Using mixed methods to investigate sources of self-efficacy. *Research in Science Education*, 48(5), 939-961.



## PBL Design and Implementation



# Teaching differential calculus in engineering: an experience from PBL

Oscar Mariño

Universidad Distrital Francisco José de Caldas, Colombia, [oymarinob@correo.udistrital.edu.co](mailto:oymarinob@correo.udistrital.edu.co)

Lina Peña-Páez

Universidad de San Buenaventura, Colombia, [lpena@usbboq.edu.co](mailto:lpena@usbboq.edu.co)

Lyda Soto-Urrea

Universidad de San Buenaventura, Colombia, [lsoto@usbboq.edu.co](mailto:lsoto@usbboq.edu.co)

## Summary

Problem-based learning (PBL) has become an innovative and high-impact proposal in engineering programs' teaching and learning processes in basic and disciplinary courses. Among the most important reasons for this is the need to train professionals with the skills, attitudes, and knowledge to face the challenges of today's society. This writing is part of a study that seeks to identify the contributions that PBL has in understanding and applying conceptual references of a differential calculus course for engineering students, as well as articulating this learning methodology with representation models in mathematics. The study's theoretical framework and the methodological description of the learning activity, which was implemented in the first semester of 2022, are presented. The study of the results of the intervention is in the analysis stage and will be presented in the article completely.

**Keywords:** PBL, engineering education, mathematics education, differential calculus, models of representation

**Type of contribution:** best practice extended abstracts

## 1 Introduction

The PBL has stood out in the field of engineering education for proposing training experiences with a reflective, critical sense, self-directed learning, collaborative and contextualized work. This has allowed the development of skills and knowledge according to the needs of 21st-century society, as proposed by organizations such as ABET and IGIP worldwide, or ASIBEI and ACOFI at the Ibero-American level.

The field's interest in applying this methodology to improve teaching and learning processes lies in its contributions to the development of skills and competencies in professional contexts and environments. Similarly, in the effectiveness of problem-solving and the implementation of technological resources in learning activities (Ravn and Henriksen, 2017, Astriani et al., 2017 and Frank and Roeckerranth, 2016).

Like engineering education, mathematics education has shown significant contributions from PBL in the training processes of differential calculus. From this articulation of fields and the proposed experiences, activities have been developed for the understanding of conceptual references such as, for example, the study of limits of functions in the framework of didactic situations (Abou-Hayt et al., 2019), the application of the derivative in kinematics problems (Kattayat & Josey, 2019), or that of projects related to reasons of change to promote autonomous learning (Cargnin-Stieler et al., 2019). A complete and interesting development of this methodology for a differential calculus course is presented by Mariño and Peña-Páez (2020), and the reader is invited to consult.

## 2 Framework

## 2.1 Description of methodological analysis

The basis of the PBL is found in the approach of a complex problem situation in a real context to motivate the student to identify and investigate conceptual references and principles that provide a solution to the problem. Its objective is to develop critical and reflective thinking and foster communication skills, self-directed learning, and collaborative work, among others (Duch et al., 2001; Hmelo-Silver, 2004).

With respect to teaching and learning activities, the role of the teacher is fundamental and significant. The PBL focuses learning on the student, leaving teachers as guides and companions of the activity, focusing on content and references, and providing continuous feedback (Ertmer & Glazewski, 2015). It is recommended to start with small problematic units that become more complex, as far as possible, problems already established in curricular plans or content (Barrel, 2007).

Regarding the responsibility given to students in their training process, the PBL highlights self-directed learning, where on their own initiative they identify needs, propose objectives and goals, and identify the necessary resources to reach the expected results. For Candy (1991), self-directed learning is an objective and process that stems from autonomy, self-management, and an independent search for learning and control of instruction.

Finally, regarding the evaluation methods used, it is important to highlight that the evaluation corresponds to a systematic process focused on the student that must allow a quantitative assessment. A quality assessment is related to consequential validity if it addresses learning (Savin & Mayor, 2004). PBL seeks to promote an understanding of conceptual referents, collaborative work skills, and metacognition through self-directed learning. In that order of ideas, the evaluation must be programmatic (Van der Vleuten et al., 2012) and a very good alternative is to use the evaluating rubrics.

## 3 Methodology of practical activity and analysis

### 3.1 Description of the practical learning activity

The practical activity presented below was designed and implemented in a differential calculus course for engineering students. It was developed in the first semester of the year 2022 throughout 16 weeks of class, adjusting the stages, activities and evaluation to the three academic periods proposed by the university.

According to the analytical program of the corresponding course, the learning activity included the topics: slope and tangent lines, the concept of the derivative, optimization and graphical analysis of the curves, taking into account the forms of representation in mathematics (algebraic, numerical, graphic and verbal).

#### 3.2.1 Problem selection

An optimization problem (maximum volume) is selected according to the conditions proposed by Loyens and colleagues (2012) for the PBL, where the standout; prior knowledge, generation of discussions, self-directed learning, promotion of integration and knowledge transfer and lastly, be relevant for the future professionalization of the student.

It is based on the condition that solving optimization problems has been a pressing interest in the history of mathematics (Grötschel, 2012; Tikhomirov, 1990). These kinds of problems provide a rich means of creating mathematical descriptions of natural phenomena. Most of the optimization problems have to do with technological processes, tools and systems, that is, they have to do with practical requirements, as can be seen in the Kepler problem and the wine barrels (Tikhomirov, 1990).

The problem that is proposed is a construction of the authors (see *Figure 1:*) taking as reference calculus texts, historically presented problems, the possibility of applying conceptual referents of geometry, arithmetic and algebra, as well as those of the course, differential calculus.



Figure 1: Proposed optimization problem

### 3.2.2 Proposed stage, activities and scaffolding

After the selection of the problem, the obstacles and challenges to the development of the practical activity applying PBL were identified. For Ermet and Glazewski (2015) it is necessary to consider: creating a culture of collaboration and interdependence, adjusting to changing roles, and the scaffolding or orientations in student learning and performance. Each stage, activity and scaffolding that is proposed in the practical activity is presented in Figure 2 (preparation stage), Figure 3 (stage No. 1), Figure 4 (stage No. 2) y Figure 5 (stage No. 3) and corresponds to an academic period of the course, that is, three stages. However, there is an initial preparation stage within the first period of the course, aiming at the analysis of previous knowledge of the students.

STAGE (Preparation)	ACTIVITY	SCAFFOLDING
<p>At this stage, the referents and concepts that are related are:</p> <ul style="list-style-type: none"> <li>Equilateral triangle and Pythagorean theorem</li> <li>Area of a triangle and a rectangle</li> <li>Area and volume of a regular prism</li> </ul> <p>This stage took place between the first and third week of the course.</p>	<ul style="list-style-type: none"> <li>The following problem situation is proposed: There is a sheet of cardboard 21 cm X 27 cm in size and each group (2 or 3 students) is asked to build a box in the shape of a regular prism with a triangular base (equilateral triangle). <b>The only condition is: to have the largest possible volume and use all the available sheet.</b> Do not take into account the tabs to stick the box, do it with sticky tape.</li> <li>After building the box, each group is asked to determine which of the following hypotheses they consider correct to obtain the largest possible volume of the box. <b>It is requested not to consult any source of information, only their experience in practice and the previous knowledge they have.</b></li> </ul> <p><b>Hypothesis</b></p> <ul style="list-style-type: none"> <li>Have the greatest possible length <math>l</math> and the smallest possible width <math>w</math>.</li> <li>Have the largest possible width <math>w</math> and the smallest possible length <math>l</math>.</li> <li>Have a greater length <math>l</math> and a lesser width <math>w</math>.</li> <li>Have a greater width <math>w</math> and a lesser length <math>l</math>.</li> <li>Have the same length <math>l</math> and width <math>w</math>.</li> <li>It is not possible to establish the maximum volume of the box since the length <math>l</math> and the width <math>w</math> are not known.</li> </ul>	<p>In academic space, it was developed through tutoring and accompaniment in class and extra-class, reviewing:</p> <ul style="list-style-type: none"> <li>Guidance on the construction of the box using as much of the cardboard sheet as possible</li> <li>Accompaniment on the construction of a plane that contains the sides of the prism using geometry (Pythagorean theorem, right triangle, area and volume of a regular prism, among others)</li> <li>Accompaniment on making decisions about the proposed hypothesis through questions.</li> </ul>

Figure 2 : Summary of the preparation stage

STAGE No. 1	ACTIVITY – Construction	SCAFFOLDING
<p>At this stage, the referents and concepts that are related are:</p> <ul style="list-style-type: none"> <li>Equilateral triangle and Pythagorean theorem</li> <li>Area of a triangle and a rectangle</li> <li>Area and volume of a regular prism</li> </ul> <p>This stage was developed between the fourth and sixth week of the course.</p>	<ul style="list-style-type: none"> <li>Discussion and socialization of a plan that allows the construction of the box using all the available cardboard sheet.</li> </ul> <ul style="list-style-type: none"> <li>Each group is given a length <math>l</math> in a range of 12 cm to 18 cm, with steps of 0.5 cm. between 4 and 5 groups have the same <math>l</math> length. With this length, each group must build the plan for the construction of the box. From the plan determine the approximate value of the <math>w</math> width.</li> <li>Using the values obtained from <math>l</math> and <math>w</math>, determine the approximate value of the volume of the box.</li> </ul>	<p>In academic space, it was developed through tutoring and accompaniment in class and extra-class, reviewing:</p> <ul style="list-style-type: none"> <li>Guidance on the construction of the plane for the construction of the box according to the length <math>l</math> that was assigned to each group, starting from the equilateral triangle. Discussions and questions were held.</li> <li>Accompaniment in the approximate calculations of the width <math>w</math> and the volume of the box according to the length <math>l</math> assigned to each group. Discussions and questions were held.</li> </ul>

Figure 3 : Summary of stage No. 1

### 3.2.3 Evaluation methods implemented

For each stage and activity, evaluating rubrics of the products presented by the groups were designed and it is expected to be shared in the complete paper. This evaluation is articulated with the PBL proposal according to the programmatic evaluation presented by Van der Vleuten and colleagues (2015), which relates planned methods to optimize fitness for purpose, combining different instruments.

An important and significant point of the evaluation and development of the activities are the models of representation in mathematics (numerical, algebraic, graphic and verbal), it is these and their relationships,

where the greatest contributions to the development of skills are found and abilities in mathematics (Mainali, 2021; Rahmawati, D. et al., 2017).

STAGE No. 2	ACTIVITY – Numerical and graphic analysis	SCAFFOLDING												
<p>At this stage, the referents and concepts that are related are:</p> <ul style="list-style-type: none"> <li>Function</li> <li>Nonlinear regression</li> <li>Maximum and minimum of a function</li> <li>Use of software: MATLAB, Excel, GeoGebra</li> </ul> <p>This stage was developed between the eighth and tenth week of the course.</p>	<ul style="list-style-type: none"> <li>According to the values obtained from <math>l</math>, <math>w</math>, and the volume of each group (Stage No. 2), build with the whole class a table of values                     <table border="1" style="margin: 10px 0;"> <tr> <td>Length <math>l</math> (cm)</td> <td>12.0</td> <td>...</td> <td>18.0</td> </tr> <tr> <td>Width <math>w</math> (cm)</td> <td></td> <td></td> <td></td> </tr> <tr> <td>Volume <math>V</math> (cm)</td> <td></td> <td></td> <td></td> </tr> </table> </li> <li>Discussion and socialization of the concept of nonlinear regression (applications). Each group shares information consulted</li> <li>Each group must graph in Excel, GeoGebra, and MATLAB the volume <math>V</math> as a function of length <math>l</math> and determine the function that relates the variables <math>V(l)</math> through nonlinear regression in each of the software. Compare the functions and graphs found. Finally, each group must analyze from the graph the point of maximum volume <math>V</math> and what length <math>l</math> is found.</li> </ul>	Length $l$ (cm)	12.0	...	18.0	Width $w$ (cm)				Volume $V$ (cm)				<p>In academic space, it was developed through tutoring and accompaniment in class and extra-class, reviewing:</p> <ul style="list-style-type: none"> <li>Guidance on the construction of the data table of length <math>l</math>, width <math>w</math>, and volume <math>V</math>. Discussions and questions were held.</li> <li>Orientation in the use of the proposed software to carry out the graphs and the regression analysis. Discussions and questions were held.</li> <li>Guidance on graphical analysis to obtain the maximum volume. Discussions and questions were held.</li> </ul>
Length $l$ (cm)	12.0	...	18.0											
Width $w$ (cm)														
Volume $V$ (cm)														

Figure 4 : Summary of stage No. 2

STAGE No. 3	ACTIVITY – Numerical, graphic and algebraic analysis	SCAFFOLDING																																
<p>At this stage, the referents and concepts that are related are:</p> <ul style="list-style-type: none"> <li>Equation of the line</li> <li>Tangent line</li> <li>Concept of the derivative</li> <li>Optimization</li> </ul> <p>This stage was developed between the twelfth and fifteenth week of the course.</p>	<ul style="list-style-type: none"> <li>The problem situation originally raised is taken up again and a discussion and socialization of how the process developed in each stage seeks to solve the problem are made.</li> <li>A discussion of the steps to solve the problem using the optimization concept is made and a comparison is made with the stages of the project developed.</li> <li>Each group must develop the problem following a template that shows the steps to solve optimization problems.                     <table border="1" style="margin: 10px 0;"> <tr> <th colspan="4">Optimization template</th> </tr> <tr> <td><b>Step No. 1</b> Variable identification</td> <td colspan="3">Identify all the variables of the problem. It is necessary to use a figure. The variable to be optimized and the data given by the problem must be identified.</td> </tr> <tr> <td><b>Step No. 2</b> Model formulation</td> <td colspan="3">Identify the models (mathematical and physical equations) that allow the variables and data given to be related to the variable to be optimized. Fit the models to the problem.</td> </tr> <tr> <td><b>Step No. 3</b> Construction of the function to be optimized</td> <td colspan="3">According to the model determined in step No. 2, make them in such a way that a function of the variable to be optimized can be constructed in terms of a single variable.</td> </tr> <tr> <td><b>Step No. 4</b> Problem solution</td> <td colspan="3">According to the function obtained in step No. 3, determine its derivative using the respective rules and procedures. Note that to optimize a function, its derivative must equal zero and be solved as an equation to work out the problem situation.</td> </tr> </table> </li> <li>According to the function to be optimized found, each group must build a table that represents the equation of the tangent line at each of the points.                     <table border="1" style="margin: 10px 0;"> <tr> <td>Length <math>l</math> (cm)</td> <td>12.0</td> <td>...</td> <td>18.0</td> </tr> <tr> <td>Width <math>w</math> (cm)</td> <td></td> <td></td> <td></td> </tr> <tr> <td>Equation of the tangent line <math>y = mx + b</math></td> <td></td> <td></td> <td></td> </tr> </table> </li> <li>Plot the function to be optimized in MATLAB and the respective equations of the tangent line found in the table according to the data on the same graph. Finally, perform analysis and interpretation of the said graph.</li> </ul>	Optimization template				<b>Step No. 1</b> Variable identification	Identify all the variables of the problem. It is necessary to use a figure. The variable to be optimized and the data given by the problem must be identified.			<b>Step No. 2</b> Model formulation	Identify the models (mathematical and physical equations) that allow the variables and data given to be related to the variable to be optimized. Fit the models to the problem.			<b>Step No. 3</b> Construction of the function to be optimized	According to the model determined in step No. 2, make them in such a way that a function of the variable to be optimized can be constructed in terms of a single variable.			<b>Step No. 4</b> Problem solution	According to the function obtained in step No. 3, determine its derivative using the respective rules and procedures. Note that to optimize a function, its derivative must equal zero and be solved as an equation to work out the problem situation.			Length $l$ (cm)	12.0	...	18.0	Width $w$ (cm)				Equation of the tangent line $y = mx + b$				<p>In academic space, it was developed through tutoring and accompaniment in class and extra-class, reviewing:</p> <ul style="list-style-type: none"> <li>Guidance on the development of the optimization problem according to the proposed steps. Discussions and questions were held.</li> <li>Orientation in the construction of the table allows for determining the equations of the tangent line for each of the points. Discussions and questions were held.</li> <li>Socialization and analysis of the graph found from the volume function and how the maximum is related to the concept of slope of the tangent line.</li> <li>Socialization of the entire process done in the learning activity with the whole class.</li> </ul>
Optimization template																																		
<b>Step No. 1</b> Variable identification	Identify all the variables of the problem. It is necessary to use a figure. The variable to be optimized and the data given by the problem must be identified.																																	
<b>Step No. 2</b> Model formulation	Identify the models (mathematical and physical equations) that allow the variables and data given to be related to the variable to be optimized. Fit the models to the problem.																																	
<b>Step No. 3</b> Construction of the function to be optimized	According to the model determined in step No. 2, make them in such a way that a function of the variable to be optimized can be constructed in terms of a single variable.																																	
<b>Step No. 4</b> Problem solution	According to the function obtained in step No. 3, determine its derivative using the respective rules and procedures. Note that to optimize a function, its derivative must equal zero and be solved as an equation to work out the problem situation.																																	
Length $l$ (cm)	12.0	...	18.0																															
Width $w$ (cm)																																		
Equation of the tangent line $y = mx + b$																																		

Figure 5 : Summary of stage No. 3

## 4 Preliminary reflections on the practical activity

Students' conceptions of mathematics and how it is learned significantly influenced the development of the practice, as confirmed by Crawford and colleagues (1994). The students were skeptical and their conceptions were associated with the solution of a large number of algorithmic exercises and their complexity and not with the development of a problem with multiple activities.

Likewise, the importance of identifying learning difficulties and the reasons behind them is highlighted, since it conditions the results of the implementation of this practical activity or of any proposal that seeks to improve the teaching and learning processes, as stated by Lithner ( 2011).

Finally, regarding the understanding of the conceptual references worked on and the practical activity itself, it is important to highlight that the structured work (in stages) allowed monitoring of the learning processes, which correspond to the form of evaluation, giving students clarity on this process. However, as this implementation is in an analysis stage, we hope to confirm or refute this hypothesis.

## 5 References

Abou-Hayt, I., Dahl, B., & Rump, C. (2019). Teaching the limits of functions using The Theory of Didactical Situations and Problem-Based Learning. *In SEFI Annual Conference European Society for Engineering Education. Annual Conference proceedings* (pp. 58-69). SEFI: European Association for Engineering Education.

- Astriani, N., Surya, E., & Syahputra, E. (2017). The effect of problem-based learning to students' mathematical problem-solving ability. *International Journal of Advance Research and Innovative Ideas in Education*, 3(1), 3441-3446.
- Barrel, J. (2007). *Problem-Based Learning: An inquiry approach*. Thousand Oaks: Corwin Press.
- Candy, P. (1991). *Self-Direction for Lifelong Learning. A Comprehensive Guide to Theory and Practice*. Jossey-Bass, 350 Sansome Street, San Francisco, CA 94104-1310.
- Cargnin-Stieler, M., Malheiro, M. T., Alves, A. C., Lima, R. M., & Teixeira, M. (2019). Learning Calculus through PBL in an Industrial Engineering and Management Program-A Seven-Year Study. *Advances in Engineering Education*.
- Crawford, K., Gordon, S., Nicholas, J., & Prosser, M. (1994). Conceptions of mathematics and how it is learned: The perspectives of students entering university. *Learning and instruction*, 4(4), 331-345.
- Duch, B., Groh, S. y Allen, D. (2001) Why problem-based learning? A case study of institutional change in undergraduate education. *The power of problem-based learning*, 4, 189-200.
- Ertmer, P. A., & Glazewski, K. D. (2015). Essentials for PBL implementation: Fostering collaboration, transforming roles, and scaffolding learning. *Essential readings in problem-based learning*, 89-106.
- Frank, M., & Roeckerrath, C. (2016). Augmenting mathematics courses by problem-based learning. *International Journal of Engineering Pedagogy (iJEP)*, 6(1), 50-55.
- Grötschel, M. (Ed.). (2012). *Optimization stories*. Dt. Mathematiker-Vereinigung.
- Hmelo-Silver, C. (2004). Problem-based learning: What and how do students learn? *Educational Psychology Review*, 16(3), 235–266.
- Kattayat, S., & Josey, S. (2019, March). Improving Students Conceptual Understanding Of Calculus Based Physics Using Problem Based Learning Approach On An E-Learning Platform Applied To Engineering Education. In *2019 Advances in Science and Engineering Technology International Conferences (ASET)*(pp. 1-6). IEEE.
- Lithner, J. (2011). University mathematics students' learning difficulties. *Education Inquiry*, 2(2), 289-303.
- Loyens, S., Kirschner, P., y Paas, F. (2012). Problem-based learning. En S. Graham, A. Bus, S. Major, & L. Swanson (Eds.), *APA educational psychology handbook: Vol. 3. Application to learning and teaching* (pp. 403–425). Washington, DC: American Psychological Association.
- Mariño , O. y Peña-Paez, L (2020) Diseño y aplicación de una unidad didáctica a partir del aprendizaje baso en problemas En E. Serna (Ed.) *Revolución en la Formación y la Capacitación para el Siglo XXI.. Editorial Instituto Antioqueño de Investigación*. 3(2)104-116.
- Mainali, B. (2021). Representation in teaching and learning mathematics. *International Journal of Education in Mathematics, Science, and Technology (IJEMST)*, 9(1), 1-21.
- Rahmawati, D., Purwantoa, Subanji, Hidayanto, E., & Anwar, R. B. (2017). Process of Mathematical Representation Translation from Verbal into Graphic. *International Electronic Journal of Mathematics Education*, 12(3), 367-381.
- Ravn, O., & Henriksen, L. (2017). Engineering Mathematics in Context: Learning University Mathematics Through Problem Based Learning. *The International journal of engineering education*, 33(3), 956-962.
- Savin-Baden, M., & Major, C. (2004). *Foundations of problem-based learning*. Berkshire: SRHE & Open University Press.
- Tikhomirov, V. M. (1990) *Stories about maxima and minima*. Universities Press.

- Schmidt, H. (2000). Assumptions underlying self-directed learning may be false. *Medical Education*, 34, 243–245.
- Van der Vleuten, C. P., Schuwirth, L. W. T., Driessen, E. W., Dijkstra, J., Tigelaar, D., Baartman, L. K. J., & van Tartwijk, J. (2012). A model for programmatic assessment fit for purpose. *Medical teacher*, 34(3), 205-214.

# An odyssey of a maker seminar, Thoughts on teaching making for project-enhanced learning in first-year physics

Dave Custer

Massachusetts Institute of Technology, USA, [custer@mit.edu](mailto:custer@mit.edu)

## Summary

Increased adoption of hands-on, student-centered, project-based curriculum suggests an increased need for instruction in making, especially for the construction of experimental apparatus and the implementation of designed things. To meet this need, the Experimental Study Group at The Massachusetts Institute of Technology has incrementally developed a making seminar, a 3 hour a week opportunity for students to learn introductory making skills—wood working, electronics fabrication, 3D printing, laser cutting, sewing, and a smattering of CAD. This abstract outlines the current seminar, its development, and the instructor's perception of the benefit students might derive from learning to make things. This anecdotal description provides a data point about how making can be injected into pre-existing curriculum on a small scale.

**Keywords:** making, critical making, project-based learning, hands-on learning

**Type of contribution:** best practice extended abstracts

## 1 Introduction

Injecting open-ended, hands-on, project-based learning into STEM curriculum in many instances requires that students be taught how to make things. While there are options that do not necessitate teaching making—e.g. basing the curriculum on a prefabricated testbed (e.g. Legos) or software modelling—any curriculum that expects students to make things, like experimental apparatus or design prototypes, must somehow provide students the requisite making skills. My experience at the Experimental Study Group (ESG) at The Massachusetts Institute of Technology (MIT), a first-year learning community of about fifty students in which students learn MIT's core science curriculum, suggests that adding instruction on how to make things to an existing STEM course is challenging because these courses are already packed with content. Freeing time up to permit project work is difficult enough, and finding the time to add making instruction has the potential to be an unsurmountable barrier to hands-on work. Thus, the broad problem is how to find time to teach students maker skills, which we have solved by evolving an optional making seminar, ES.100.

The evolution started in the fall 2019 semester by adding eight hours of maker training to the first year, first semester physics (mechanics, about 35 students) and was to be followed up the 2<sup>nd</sup> semester with a similar amount of training regarding data analysis and visualization. The experience from the first semester made it quite clear that the training could not be made to fit into the time allotted to students for first semester physics. The maker training and some of the hands-on elements were jettisoned. The physics curriculum retained four or five in-class, hands-on explorations and a week-long final project, which could be computer/modelling based and thus does not require maker expertise for all students. In parallel with the development of the maker seminar, a variation of the Electrical Engineering and Computer Science Department's subject 6.100A, *Introduction to Computer Science Programming in Python*, a popular, six hours/week of student work subject has been modified so that the computer science curriculum is conveyed using problems that reinforce the first-year mechanics curriculum. Based on the first semester experience

that crowded the physics curriculum too much, during the spring semester a data analysis curriculum was spun off as an optional seminar. This initial seminar offering was abruptly interrupted by the covid pandemic. During the following, pandemic semester (fall 2020) the hands-on physics materials were developed to be shipped to students and no maker space training was possible. During the spring of 2021, a semester when students were mixed on and off campus, all attending class by zoom, and again working with shipped/hands-on toys, maker-space access and training was unavailable until the final month of the semester. Even then, the number of people permitted in the maker space was limited and only on-campus students could participate in training. Nonetheless, about ten on-campus students were provided with the training necessary for their project work. Throughout the pandemic disruption, the focus on how to provide hands-on experiences to support the physics curriculum continued. Lessons from this evolution path suggest that 1) maker training is simply not possible to shoehorn into the existing physics curriculum and time constraints, 2) providing an optional computer science subject that teaches the skills necessary for computational modelling prepares many (about 40%) of our students for modelling projects, and 3) students can succeed at many hands-on projects without maker training. These realizations have led ESG to provide maker training via an optional seminar that is separate from the physics subject.

## 2 What is done in ES.100

ES.100 is an opportunity to learn to make things, to use MIT's maker spaces to make things, and to think critically about making and the made world. It builds skills needed for completing hands-on projects, that may be encountered in undergraduate classwork and research activities. The seminar includes maker-space training—wood shop, laser cutting, vinyl cutting, 3D printing, electronics fabrication, sewing, a smattering of Fusion 360 and Adobe Illustrator, and other options as per student demand—and open-ended maker projects. Student time is spent being trained or making things, with the exception of an early semester framing lecture and an end-of-term show-and-tell and reflection session.

The seminar is staffed by one lecturer (the author) for about six hours/week of time commitment and two 2<sup>nd</sup> year undergraduate students who had taken the seminar the previous year, each four to five hours/week. Most of the staffing time is delivering training and hosting open hours in the maker space. Class size has varied between six and sixteen; nine to twelve students is about right, a reasonably large number of students from an efficient use of resources point of view and a reasonably small number of students to foster a sense of cohort; twelve students is also the ESG target for class size, again a trade-off of efficiency and cohort bonding. Even with this number of students, arranging training times that fit the schedules of all involved is a Herculean task.

Much of the training and making takes place in Metropolis, an MIT Project Manus (PM) maker space, which has a floor area of roughly 110 m<sup>2</sup> and houses bandsaws, drill presses, a bench sander, 3D printers, laser cutters, sewing machines, a CNC bed router, an electronics bench, a spray booth, and many smaller tools (Fig 1) (Hunt & Culpepper, 2017). Without this facility and PM support, the seminar would not be possible—because ESG does not have a half million dollars and 110 m<sup>2</sup> of campus real estate to create its own maker space. The arrangement between ESG and PM is that in exchange for maker space access, each member of the ESG seminar teaching staff provides two hours of training for PM (we can train our program students first, but then we train any takers) and two hours of PM open hours weekly. In return, ESG staff have access to the space, though they cannot reserve it solely for seminar use. In many ways similarities between ESG and PM have made the collaboration easy, especially their community focus, support of student instruction, and encouragement of student self-direction.

For the first ten weeks of the semester, students are trained on equipment, roughly one tool each week. Training is generally an hour or two in length and attended by three or four students. Training provides an introduction to the tool and often an opportunity to use the tool to create a thing of their choice. For the final month of the semester, seminar time is devoted to student projects, whatever they are inspired to make. A difference between this seminar and many other shop trainings is that, except for the electronics



fabrication, students are self-directing the things they create; they are free to conceive, design, and make the thing of their choice (Fig 1). An advantage to the open-ended nature of the opportunity is that it often provides a nucleation point for a class discussion of the several different ways whereby the thing they envision might be made. Further, once making commences, different projects exemplify different fabrication challenges.

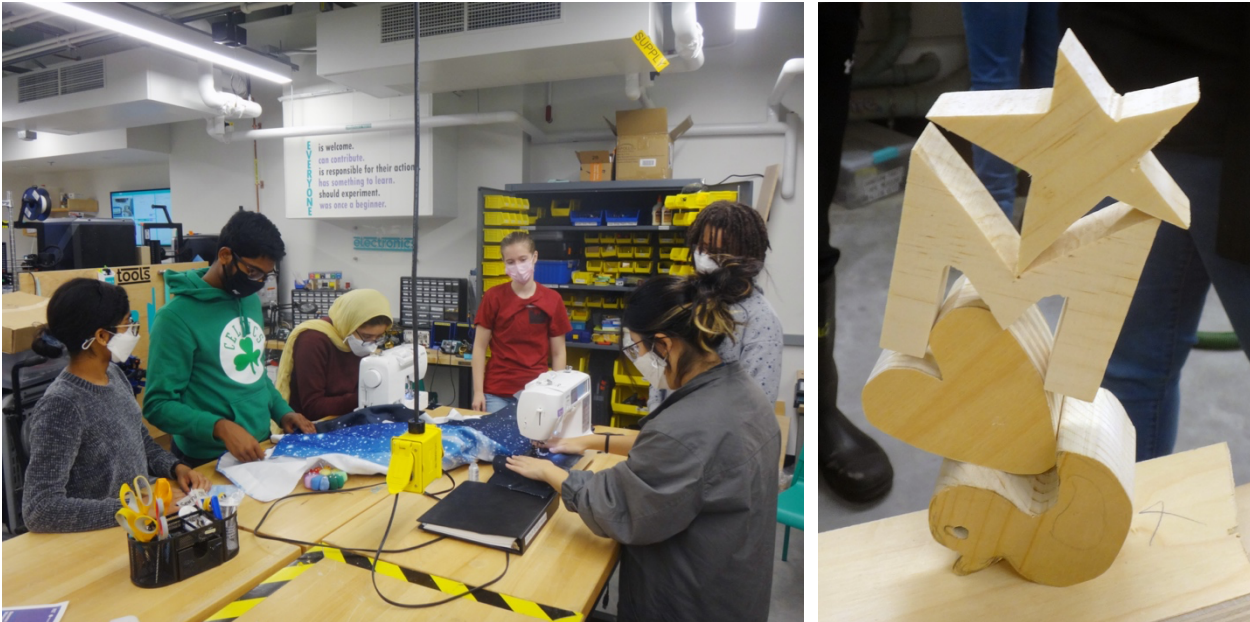

**Fig 1** Left, ES.100 seminar students working in Project Manus's *Metropolis* maker space; without access to this maker space, ES.100 would be impossible and the maker element of ESG's project-enhanced physics would be greatly curtailed. Right, student creations from a wood shop training. Students are tasked to conceive, design, and make whatever they want in about an hour's time; the variety of student directions is evident, and each creation introduces the class to a different set of challenges.

The seminar has a nominal budget of \$50 US per student for materials. In aggregate, seminar participants never come close on this expenditure. Usually, one enthusiastic student will come close to this limit each semester.

### 3 What I think students learn

What I tell students that they could learn is outlined in Table 1. I have no data to ascertain whether in fact Table 1 represents what students learn, only my obviously biased impression. For example, my impression of "empowerment" comes from watching students show off their new skills to their parents in a makerspace during MIT's family weekend, from seeing how in a few tens of minutes students can move from giving the band saw a wide birth because it might bite to confidently and skilfully using the machine to cut wood, or from seeing students excitedly video their first laser cut. I have much less direct evidence regarding how their seminar experience shapes their risk management or how their making fits into STEM work or their perception of the made world.

In end of term reflections, a recurring refrain is the observation that making is a time-consuming process and that allocating time for making is necessary to get things made and/or increase making expertise. I estimate that about one quarter of the seminar students put in the time needed to move beyond the novice level that their seminar training provides. I have made the explicit pedagogical choice NOT to penalize students for not putting in more time on seminar projects because I think it is important to protect the intrinsic motivation

that has brought them to the seminar in the first place. Another reoccurring set of comments revolves around the open-ended nature of the projects. Roughly 4 to 1, students prefer the open-ended projects to recipe/proscribed projects; even so, they acknowledge that the open-ended projects are intimidating and require a kind of thoughtfulness that they are not accustomed to applying to their academic STEM work.

**Table 1** What I tell students about how making might change them

Learning to use maker-space tools	changes you	<ul style="list-style-type: none"> <li>• by providing you with the skills understanding, experience, and empowerment to make things.</li> <li>• by preventing you from looking at a made object again without considering how it has been made.</li> <li>• by enabling you to envision alternate realities—how things could (come to) be.</li> </ul>
Critical making—making things to better understand the made world—		<ul style="list-style-type: none"> <li>• by replacing “words and maps” with tactile experience.</li> <li>• through the investigation of the relationship between being a consumer of things and a producer of things.</li> <li>• by conferring the superpower ability to recognize opportunities to change the world.</li> </ul>
Understanding the situation of making in relation to design, experiment, and model (& proof)		<ul style="list-style-type: none"> <li>• by making clear the connection of making to the other actions and outcomes of STEM work.</li> <li>• because now you can articulate how to add value in STEM work.</li> </ul>
Managing risk in the maker space		<ul style="list-style-type: none"> <li>• by extension of risk management into everyday life.</li> </ul>

As another anecdotal data point, former seminar students make up more than 10% of this semester’s PM mentors who are drawn from across undergraduate, graduate, and alumni populations, though ESG students comprise only 5% of the undergrad student population. Despite the small numbers cited here and the obvious possibility that the seminar merely correlates rather than causes the increased number of the mentors, such anecdotal evidence points to the plausibility that a maker seminar and the making therein can change students.

#### 4 Thoughts on where making might be headed

For ES.100, its current reason for existing—to support hands-on, constructive, physics projects—and its status as a 3 hours/week optional seminar, we don’t expect to be making big changes. The seminar provides a quorum of our students with the training and resources to be able to make things necessary for physics projects. The history of the development of the seminar over an unusual couple of years gives us confidence that further adjustments can be made should the situation change, and perhaps offers others who are interested in injecting making instruction into project-based learning within STEM curriculum an idea of the resources needed, the changes from the initial vision that might occur, and the effect that making might have on students.

Looking forward, a set of questions that ES.100 raises revolve around the discipline(s) in which making is situated. While it is clear that the exigency for the ES.100 seminar stems from the inclusion of making in project enhanced learning curriculum in first-year physics subjects, it is similarly unclear what discipline broadly claims making as its purview. At a college or university, which department should offer maker curriculum, an enterprise that has somehow acquired a whiff of vocational education? Does making belong as part of a fine arts? Is it a part of a manufacturing program, perhaps within an engineering department? Should it be housed under a critical making program in a humanities department? In STEM disciplines, it is easy to find subjects with specialized curriculum to teach students the details of discipline work: modelling, design, experiment, and proof, but the task of making rarely appears as the focus of curriculum. This

ambiguity regarding the disciplinary home of making poses challenges for those advocating for maker training and perhaps opens up opportunities for what can be learned from making.

## 5 References

Jonathan Hunt, J. & Culpepper, M. (2017). Makin' it Work - Growing Pains, Solutions and Lessons Learned in Creating a Maker Training Program for a Class of 1100 Freshmen, *ISAM 2017: Paper No.: 997*. <https://assets.pubpub.org/9xk7qxbq/21585585139132.pdf>

# Work In Progress: Design of a PBL-Centred Masters Programme in Nanoscale Manufacturing

Eral Bele

University College London, United Kingdom, [e.bele@ucl.ac.uk](mailto:e.bele@ucl.ac.uk)

Enrique Galindo-Nava

University College London, United Kingdom, [e.galindo-nava@ucl.ac.uk](mailto:e.galindo-nava@ucl.ac.uk)

Zareena Gani

University College London, United Kingdom, [z.gani@ucl.ac.uk](mailto:z.gani@ucl.ac.uk)

Liwei Guo

University College London, United Kingdom, [liwei.guo@ucl.ac.uk](mailto:liwei.guo@ucl.ac.uk)

Martyna Michalska

University College London, United Kingdom, [m.michalska@ucl.ac.uk](mailto:m.michalska@ucl.ac.uk)

## Summary

UCL East, the new campus of the University College London in East London will be opened in 2023. This is the single biggest expansion of the University since its foundation in 1826. With the aim to integrate research and education, theory, and practice – with cross-disciplinarity, innovation and public engagement, a need has emerged to build transformative programmes that will accommodate these objectives. This paper outlines the development of a Master’s-level (MSc) programme in Future Manufacturing and Nanoscale Engineering. The programme is highly experiential; with a focus on both “learning by doing”, and significant laboratory components (physical or computational) in all modules. A systematic process of programme design showed the need for a PBL-centred teaching and learning. The curriculum structure was designed to incorporate a “hub” of hands-on, open-ended activities in the form of manufacturing challenges. This practice may prove useful for the development of similar technical programmes, where the incorporation of PBL activities may be challenging due to the availability of specialist technology.

**Keywords:** Curriculum Design, Problem-Based Learning, Engineering Education, Active Learning, Skills Development

**Type of contribution:** Best practice extended abstract

## 1 Context: Programme Rationale and Development Framework

From modern diagnostics, construction materials to alternative energy solutions – a sustainable future relies on engineering strategies that can provide transformative solutions with ever-expanding applications. The field of nanoscale engineering fits many of these traits, and here we describe the development of a Master’s-level teaching programme in Future Manufacturing and Nanoscale Engineering. The programme will be housed in a new, collaborative research laboratory formed by the departments of Chemical, Biochemical and Mechanical Engineering, and Chemistry. This MSc programme aims to engage students in the design, characterisation, and applications of nanomaterials, and their manufacturing techniques, to enable them to be leaders in this growing field. Ultimately, the students will be able to design manufacturing methods, critically analyse structure-properties relationships, make informed decisions about material limitations, and assess the environmental impact of design choices. The programme is unique in that it is implicitly more applied than other degrees in the field of nanoscale manufacturing.

The programme development process consisted of the following stages: 1) Conceptualisation, 2) Definition of programme-level learning outcomes, 3) Curriculum design, 4) Evaluation by external stakeholders, and revision. In this paper, we describe the methodology and outcomes of each of these stages, describing the

rationale behind the choice for a problem-based learning (PBL)-centred curriculum. We expand on the design of these activities, their role within the curriculum and feedback received by independent reviewers.

## 2 Design of a PBL-Centred Curriculum

### 2.1 Programme Attributes and Learning Outcomes

The ideation of the programme started with a collection of 50-word summaries in a focus group of the development team. Subsequently, surveys of the current state of the art in education of this field were discussed, and a “wish-list” of the vision of the programme was generated as shown in Figure 1a. The above elements were used to generate programme-level learning outcomes in three main categories (Figure 1b; green). Here, “Subject-specific outcomes” relate to the application of a comprehensive knowledge of mathematics, statistics, natural science, and engineering principles to the solution of industry-relevant problems pertaining to advanced manufacturing and nanoscale engineering. “Intellectual, Academic and Research Skills”, focus on the interpretation of relevant literature to provide solutions to these problems. “Practical and transferable skills”, focus on providing confidence in working within a diverse research group through an emphasis on individual and team work, which is increasingly important in the execution of contemporary research projects.

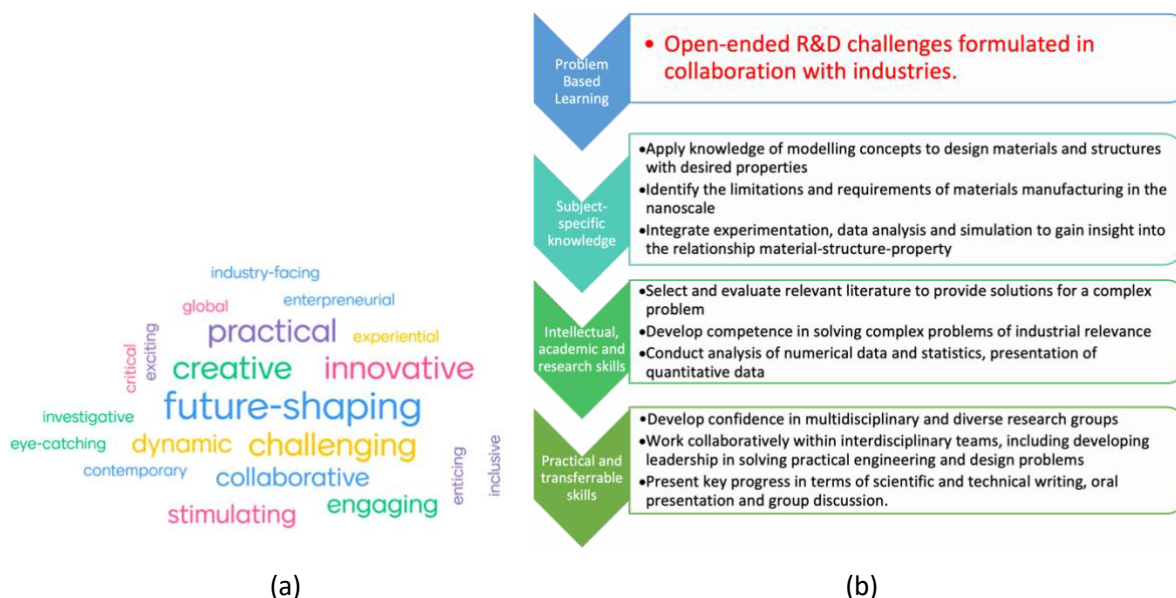

Figure 1: Programme vision attributes (a), and integration of learning outcomes (b)

The emphasis on demonstrable practical skills, and capability to respond competently to future challenges in this rapidly developing field made it clear that a comprehensive PBL methodology had to be developed. The role of PBL in Engineering Education has proven its effectiveness, especially in fostering competence in technical and durable skills (Aldert Kamp, 2020; Andersen et al., 2019; Andersen & Rösiö, 2021; ElMaraghy et al., 2021; Jamaludin et al., 2012; Kuppaswamy & Mhakure, 2020; Ríos et al., 2010). The inspiration for the incorporation of a “spine” of PBL activities that span the curriculum came from a successful application of this model within the Integrated Engineering Programme in our Faculty (Hailes et al., 2021; Mitchell et al., 2021). The main benefits of this model within the undergraduate curriculum have been to aid the development of design and professional skills. In our Master’s-level programme, the model’s intended primary functions are: 1) to integrate the distinct learning topics taught in the programme, and 2) to provide a venue for practical application and independent investigation of the taught topics within a design-build-test framework.

## 2.2 Integration of PBL Activities: Manufacturing Challenges

The programme structure is shown in Figure 2. It is taught in 3 Terms spanning 12 months, and consists of 6 taught modules. The Group Manufacturing Challenges contains a series of four 5-week challenges based on contents taught in modules 1-5. Examples of these challenges are: 1) Design and manufacturing of a nanoscale flexoelectric energy harvesting material, 2) Design/manufacture/test a microlattice material with high stiffness/weight, 3) Design of a new alloy for additive manufacturing, 4) Design, fabricate and analyse high-precision components produced by additive and subtractive manufacturing techniques.

This module acts as the hub that integrates the rest of the modules and equips the students with an overall comprehensive knowledge and hands-on skills of the emerging manufacturing technologies. As Graff et al. states, these challenges would not only focus on evaluating the students' depth and breadth of learning but also on their ability to "fill in the subject area gaps" in advanced manufacturing (Graff & Kolmos, 2003). The challenges are open-ended complex problems with multiple solutions; thus, the learning is directly driven by problem-solving. In some challenges (e.g. example of Section 2.3), the manufacturing challenge precedes the content of the taught module, thus providing a valuable opportunity to learn through PBL principles.

A second advantage of this design is the opportunity to provide hands-on practical experience with characterising, manufacturing and testing of materials at micro/nano scales. For this purpose, the teaching laboratory has been equipped with 5-axis CNC precision machines, fibre-composite 3D printers,  $\mu$ CMM, SEM & AFM (material characterization), profilometer (surface analysis), and metallographic preparation equipment. Various computational tools will be used, such as Thermocalc (materials development), CES Edupack (material selection, manufacturing process selection, sustainability analysis), Abaqus (FEA), and Fusion360 (CAD). This experience will thus: 1) enable students to apply a sophisticated knowledge base to solve real-world problems, and 2) provide evidence of practical skills which will be useful for employment.



Figure 2: Structure of the Programme

## 2.3 Implementation: Manufacturing Challenge on Structurally Efficient Microlattices

Here we describe the structure of one of the manufacturing challenges. The students are expected to design microlattice materials with the objectives of: 1) exploring the material property space, and 2) designing materials with high strength/weight ratio. Microlattices are highly porous and cellular structures which are composed of periodic network of beams. Their stiffness and strength can be tuned through geometric design choices, and material selection, setting a loosely-defined design space with a specific objective.

Students will be asked to work in groups of 3-4 to design a sample of microlattice material with dimensions of  $50 \times 50 \times 10$  mm. They will be guided through the following workflow. First, use ASTM standards to determine the number of cells necessary to mimic an infinite lattice, using three different unit cells: hexagonal, gyroid and triangular. Second, for each type of unit cell, analytical models and Finite Element Analysis (FEA) modelling to determine constitutive properties are introduced. Third, manufacturing of

prototypes in micro- and nano-scale with several additive manufacturing techniques is realised, and fourth, characterisation and mechanical testing is performed. The overall structure is shown in Figure 3.

The students work with their group members most of the time, with support and guidance provided from a series of lectures, example classes, workshop demonstrations and drop-in sessions, as below:

- Lectures; including introductory lecture to present the project brief and lectures by industrial guests to give students a vision of its impact in real-world scenarios,
- Example classes; to demonstrate how to use analytical models to obtain an initial design,
- Workshop demonstrations; including virtual lab to demonstration FEA for structural analysis and 3D printing lab for prototype manufacturing,
- Drop-in sessions; daily sessions run by tutors to help students with their individual questions.

This structure will make sure students can learn the technical knowledge by problem-solving before taking the taught module – Micro/Nano Architected Materials. This two-step learning process can give students both hands-on experience and further enhanced learning by more systematically structured lectures.

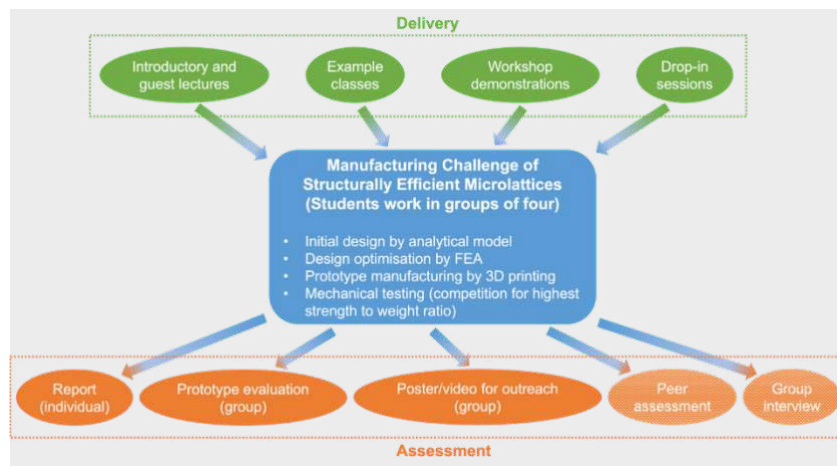

Figure 3: The overall structure of the manufacturing challenge

### 3 Evaluation of Effectiveness

The programme was evaluated by four groups of stakeholders: 1) an industrial advisory board, 2) an independent external scrutineer, 3) focus group of students external to the department, and 4) alumni of the department. Below, we summarise the main points of the feedback received.

The industrial advisory board included representatives from a range of industries, including Marine Engineering, Biomedical Engineering, Aerospace, and Manufacturing of Composite Materials. The audience included directors, CEOs, and CTOs of these companies. Their feedback focused on the involvement of industry on the Manufacturing Challenges.

The external scrutineer was a senior researcher with extensive specialist experience in nanoscale engineering, and in the design of similar programmes. The main improvement suggestions were in relation to the assessment of individual contributions in the group assessments in the Manufacturing Challenges and the Advanced Research Project modules, for which a detailed evaluation methodology was subsequently created and will be presented in our discussion in the conference.

The external student focus group highlighted the attractiveness of group work and hands-on training from the point of view of prospective students. The alumni praised the niche of the field and provided specific advice on marketing the programme to prospective students. Of the 14 students interviewed, 6 stated that they would choose the programme as is, with the rest highlighting changes that would sway their decision

towards their preferred careers, e.g. on finance, materials, design etc. The overall evaluation of the proposed curriculum was positive, with specific emphasis on the role and effectiveness of the PBL-centred design.

## 4 Current and Future Perspectives

In order to facilitate learning through PBL approach in this programme, adequate industrial/practical experience and up-to-date knowledge of industrial practice is required (Gani, 2019). The main challenge is to make nanoscale manufacturing accessible through a combination of bench-top experimentation and real-life industry-relevant experiential learning. This might be a common hurdle with many future-looking and highly specialist practical (engineering) programmes that are relatively niche. For example, manufacturing with nanoscale details and nano-inspection often require specialised equipment that students are not commonly exposed to, entering the programme with limited/none prior experimental skills to build upon. This partly has to do with an investment required to accommodate these tools and often, a special infrastructure.

While a wide access to the bench-top experimentation is one key element, the other concerns making the programme industry-relevant. To do so, we invested again in infrastructure – e.g., precision manufacturing lab - but we will also research closely with industrial partners through their supervision over a group project. In addition, we aim to equip our students with tools to effectively communicate their ideas to technical audiences and the public. All these PBL elements are designed to work synchronously so that graduating students will have the skills needed to work in any industry that uses design, manufacturing or materials.

## 5 References

- Aldert Kamp. (2020). *Navigating the Landscape of Higher Engineering Education*.
- Andersen, A. L., Brunoe, T. D., & Nielsen, K. (2019). Engineering education in changeable and reconfigurable manufacturing: Using problem-based learning in a learning factory environment. *Procedia CIRP*, 81, 7–12.
- Andersen, A. L., & Rösiö, C. (2021). Continuing Engineering Education (CEE) in Changeable and Reconfigurable Manufacturing using Problem-Based Learning (PBL). *Procedia CIRP*, 104, 1035–1040.
- ElMaraghy, H., Monostori, L., Schuh, G., & ElMaraghy, W. (2021). Evolution and future of manufacturing systems. *CIRP Annals*, 70(2), 635–658. <https://doi.org/10.1016/j.cirp.2021.05.008>
- Gani, Z. (2019). Project Based Learning for Computer Integrated Manufacturing Course. *2019 ASEE Annual Conference & Exposition Proceedings*. <https://doi.org/10.18260/1-2--33202>
- Graff, E. D., & Kolmos, A. (2003). Characteristics of Problem-Based Learning. *International Journal of Mechanical Engineering Education*, 19(5), 657–662.
- Hailes, S. , J. L. , M. M. , M. J. E. , N. A. , R. K. , . . . & T. F. (2021). The UCL Integrated Engineering Programme. *ASEE, Advances in Engineering Education*.
- Jamaludin, M. Z., Mohd.Yusof, K., Harun, N. F., & Hassan, S. A. H. S. (2012). Crafting Engineering Problems for Problem-Based Learning Curriculum. *Procedia - Social and Behavioral Sciences*, 56, 377–387.
- Kuppuswamy, R., & Mhakure, D. (2020). Project-based learning in an engineering-design course - Developing mechanical- engineering graduates for the world of work. *Procedia CIRP*, 91, 565–570.
- Mitchell, J.E., Nayamapfene, A., Roach, K, & Tilley, E. (2021). Faculty wide curriculum reform: the integrated engineering programme. *European Journal of Engineering Education*, 46:1, 48-66.
- Ríos, I. D. L., Cazorla, A., Díaz-Puente, J. M., & Yagüe, J. L. (2010). Project-based learning in engineering higher education: two decades of teaching competences in real environments. *Procedia - Social and Behavioral Sciences*, 2(2), 1368–1378.



# Strategies for embedding simulation in open-ended engineering design education

Francesco Ciriello

King's College London, United Kingdom, [francesco.ciriello@kcl.ac.uk](mailto:francesco.ciriello@kcl.ac.uk)

Claire Lucas

King's College London, United Kingdom, [claire.1.lucas@kcl.ac.uk](mailto:claire.1.lucas@kcl.ac.uk)

Antonio Elia Forte

King's College London, United Kingdom, [antonio.forte@kcl.ac.uk](mailto:antonio.forte@kcl.ac.uk)

Wei Liu

King's College London, United Kingdom, [wei.liu@kcl.ac.uk](mailto:wei.liu@kcl.ac.uk)

## Summary

A tension exists between the open-ended nature of project-based education and the skill gap that educators need to overcome so that learners extract value from simulation in engineering design.

Solutions to current global challenges will require disruptive innovation and engineers that can creatively dissect complex systems. The next generation of engineers will likely not be able to solve these challenges with off-the-shelf solutions, and it follows that instructors will not be able to accurately predict the solutions that they will conceive and develop. This uncertainty presents significant challenges for the design of learning activities and assessment that involve simulation-driven development around open-ended design challenges.

Modern engineering design greatly benefits from simulation. Problems are increasingly complex, multi-dimensional and multi-domained, and so engineers need to employ tools that allow for the abstraction and rapid exploration of design spaces to successfully leverage system-thinking principles in design. This need is compounded by the operational requirement to collaborate within and across organisations that use a variety of product development tools.

Herein, we present a case study that outlines our program strategy to embed simulation in the design modules of the General & Electronic Engineering programs at King's College London. We discuss the role of different simulation technologies in engineering design, how we scaffold simulation skill development in design modules and highlight the main barriers to overcome as we develop the next iterations of our curriculum.

**Keywords:** project-based learning, design education, simulation, engineering education

**Type of contribution:** Best practice extended abstracts

## 1 Introduction

Our General Engineering program at King's College London (KCL) was re-launched in 2019 with the aim to develop students who are shaped by the global role and impact of engineering. The curriculum is designed to address technological and societal challenges, and learners are continuously guided to tackle *wicked problems* (Rittel & Webber 1973) that are prevalent in professional practice. Rather than specialising in traditional engineering domains, we offer modules that broaden in scope as student progress through year

levels, in what we have coined as a *curriculum of possibilities* and rely heavily on learning through design and creative work. Students experience a variety of approaches to design through four core modules, which compose 25% of learning time for the first two years of undergraduate study and serve as a capstone to what is learnt in other broadly defined modules (see Figure 1).

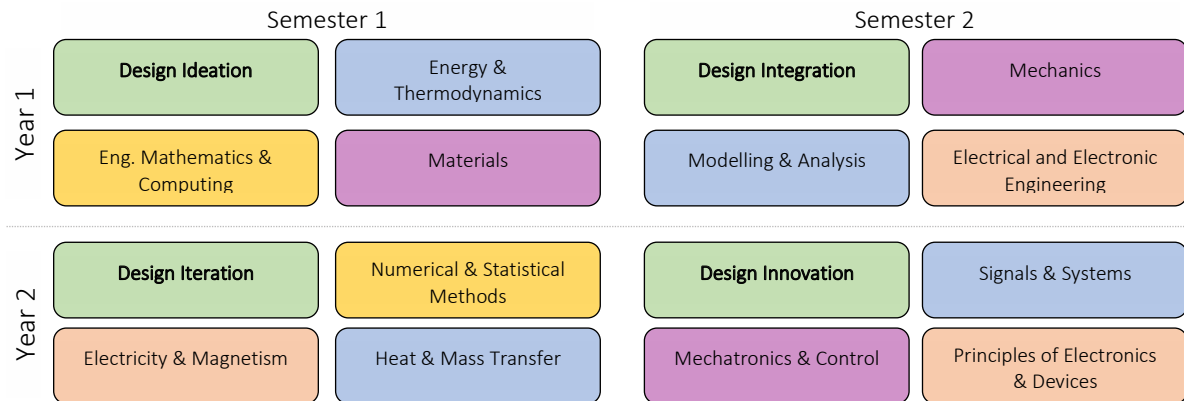

Figure 1: Module titles and timeline for the first and second years of undergraduate teaching for the joint General & Electronic Engineering programs at KCL.

Within this opportunity for a major program re-design, we recognise that there is a growing requirement from higher education accrediting bodies to develop learning areas in engineering practice and analysis (AHEP 2020) and from industry to hire graduate engineers that are proficient in computational modelling and simulation (Boucher 2017). Technical literacy requirements for engineers are, however, growing at a rate that is much faster than the frequency with which higher education institutes can review and digitise their curriculum. This has widened a skill gap between the materials we teach as educators and what is expected of graduates from employers, which is often patched or retrofitted within the graduate training programs of medium to large scale enterprise. A recent survey from ASEE (2020) highlighted that only 13% of recent graduates felt prepared in using simulation entering their first job, which reduces to 3% for emerging technologies such as extended reality and digital twinning. On the other hand, 96% of companies expect new graduates with engineering software experience and report that the skill gap causes loss of competitiveness, poor design and innovation, and undesired financial impacts (Boucher 2017). It is unclear how this gap is filled in small business and entrepreneurship and what its impact is on the global workforce.

Herein, we share the reflections from the design module team on an ongoing project whose aim is to narrow this skill gap in our program by developing a strategy for how to integrate simulation within first- and second-year design modules. We discuss how to stage simulation technologies to vertically integrate simulation skills across modules, elicit the role of computer-aided design in the transition from technical drawing to parametric simulation, and outline the role of the educator in supporting the creation of simulations by learners.

## 2 Simulation in Engineering Design Modules

Engineers use models to idealise and analyse a system. The transition from modelling to simulation stems from the use of a computational tool to support modelling. The value of modelling and simulation in the support of learning is mainly derived from conceiving and validating models, investigating parameters and variants, visualising responses, formulating and selecting appropriate design options and monitoring a solution during its operational lifecycle (reviews in Magana & de Jong 2018, Campos et al. 2020). In simulation-based design projects, there are also reported benefits in collaborative skill development, which

include an increased awareness of systems engineering principles and testing procedures, and an improved communication across stakeholders in the design team (Ciriello 2022).

Simulation supports the design process by better informing decision-making, allowing to improve the performance and reduce the risk of engineering solutions. This value proposition has given rise to design movements in model-driven development that use simulation as the continual testbed for product development. These design philosophies originated in safety-critical industries such as aerospace and automotive and are now ubiquitous in engineering practice (INCOSE 2022). Model-based development is also receiving increased attention in project-based learning and design-led modules with evidence of improved physical intuition and design outputs (Davidovitch 2006, Andersson 2012, Ciriello 2022).

*Why simulate in engineering design modules?* As instructors, our principal justification for introducing simulation in design is the testing of product requirements via simulation-based Design of Experiments (DoE). These experiments are used for virtual (or mixed reality):

- **design exploration** - investigating the effect of a parameter or of design variants;
- **design optimisation** – sweeping, investigating, or searching through a parameter space;
- **component verification** – proving a product requirement for a component;
- **integrated system verification** - proving product requirements hold after integration;
- **variation analysis & scenario-based verification** – testing product requirement over a range of operations and non-deterministic conditions;
- **system optimisation** – analysing, and tuning design parameters;
- **system validation & commissioning** - proving to an assessor or other third-party the solution complies with standards and requirements;
- **operations research** – analysing latency, throughput, bottlenecks and deadlocks, and forecasting for capacity planning and supply-chain management;

and can be compared to testing on hardware prototypes. Simulation can also be used to better develop product requirements by supporting feedback collection from stakeholders and operators.

*How should learners simulate?* Simulation approaches are selected based on the trade-off of multiple criteria, including the physical domain of the modelled process, requirements for fidelity, resolution and inference speed and the availability of resources weighted against cost, proficiency, and preferences. Design teams do not take a singular approach to simulation, but more often develop and integrate multiple techniques (so-called *hybrid modelling*). The modern landscape of professional simulation tools is also closely interconnected with product lifecycle management (PLM), testing frameworks, and tools for interfacing to hardware (see Table 1). It follows that to prepare learners for their graduate roles we must help navigate this complex landscape and make informed decisions about the adequacy of simulation techniques.

### 3 Scaffolding Simulation Skill Development

The development of analytical skills for modelling, such as drawing free body diagrams, deriving equations from first principles, and drawing engineering components, is the natural pre-requisite to the successful adoption of simulation for developing engineers. In engineering programs, this analytical skill development is commonly followed by instructors guiding learners to develop simulations from first principles, *e.g.* implementing numerical solvers in a function or implementing equations in block diagrams, and indeed this is a useful exercise to understand the inner workings of simulation tools. The main barrier of solely relying on first-principle approaches in design are those of scalability and abstraction – these are needed to model systems.

Table 1: A summary of simulation applications against example design tools from engineering simulation providers.

	Autodesk	Siemens	MathWorks	Ansys	Dassault Systèmes	Open Source* / Specialist Prod.
<b>Integrated CAD, CAE, CAM</b>	AutoCAD, Fusion 360	NX, Solid Edge	n/a	Discovery, SpaceClaim	SolidWorks, CATIA	Creo*
<b>Programmable numerical solvers</b>	n/a	NX Open	MATLAB & Simulink	APDL	SIMULIA Abaqus Scripting	SciPy*
<b>1D Component-based modelling</b>	n/a	Simcenter Amesim	Simscape	SCADE	Dymola	Modelica*, LT Spice
<b>Multibody</b>	Inventor	Simcenter 3D	Simscape Multibody	Ansys Motion	Simpack	MuJoCo*, Gazebo*
<b>Finite Element Analysis (FEA)</b>	Inventor Nastran	Simcenter FeMap / Nastran	PDE Toolbox	Ansys Mechanical	SIMULIA Abaqus	FENICS*
<b>Computational Fluid Dynamics (CFD)</b>	Autodesk CFD	Simcenter Star-CCM+	n/a	Ansys Fluent	SIMULIA Abaqus	OpenFOAM*
<b>Multiphysics (3D)</b>	Inventor	Simcenter Star-CCM+	n/a	n/a	SIMULIA Abaqus	COMSOL
<b>Discrete Event Simulation &amp; Agents</b>	ProModel as Plug-in	Technomatix	Stateflow, SimEvents	n/a	DELMIA	Anylogic, Arena
<b>Electronic Design Automation (EDA)</b>	Eagle	Valor	n/a	Ansys Electronics	CST Studio Suite	Cadence

**Other example applications that use purpose-built design simulation tools include** *acoustics, optics, chemistry, material failure, electromagnetism, motors, lifecycle analysis, information modelling, automotive, flight, photorealistic scenarios, extended reality, robotics, software architectures, transportation*

To support system modelling, educators turn to object- or component-based methods. Component-based methods extract models from either 1D schematics, such as pipe networks or electric circuits, or from 3D CAD models. These methods further branch into continuous (FEA, CFD, Multiphysics) and lumped parameter (1D, Multibody) modelling. Model management & architecture quickly becomes important and design exploration is enabled by the appropriate management of parameters (parametric modelling) and of variants (*i.e.* design choices).

A variety of modelling paradigms are then better suited to handle the time evolution and interconnectivity of systems, *e.g.* tools that can handle kinematics, dynamics, events, stochastic behaviour or graphical networks. Engineering practice is also seeing increased attention in real-time processing for simulation synchronisation and for interoperability with immersive visualisations for improved product development. In figure 2, we demonstrate how we stage these simulation skills at a program-level, where they are grouped in three complementary categories. Within the design modules, we run a series of learning activities that typically start with instructor-led workshops and are then followed by self-paced tutorials. Example learning activities include:

- the instructor guides the learner to create component or system simulation from scratch to develop a design;
- the instructor provides a simulation template, with customisable or missing components, for learners to better inform or develop a design (see Figure 3);
- the instructor provides an experimental activity or dataset and ask learners to model and validate;
- learner teams maintain a master datasheet in a design project shared among team members;
- learner and instructor perform a simulation design review (as a validation procedure), also discussing appropriate model management and quality control procedures.

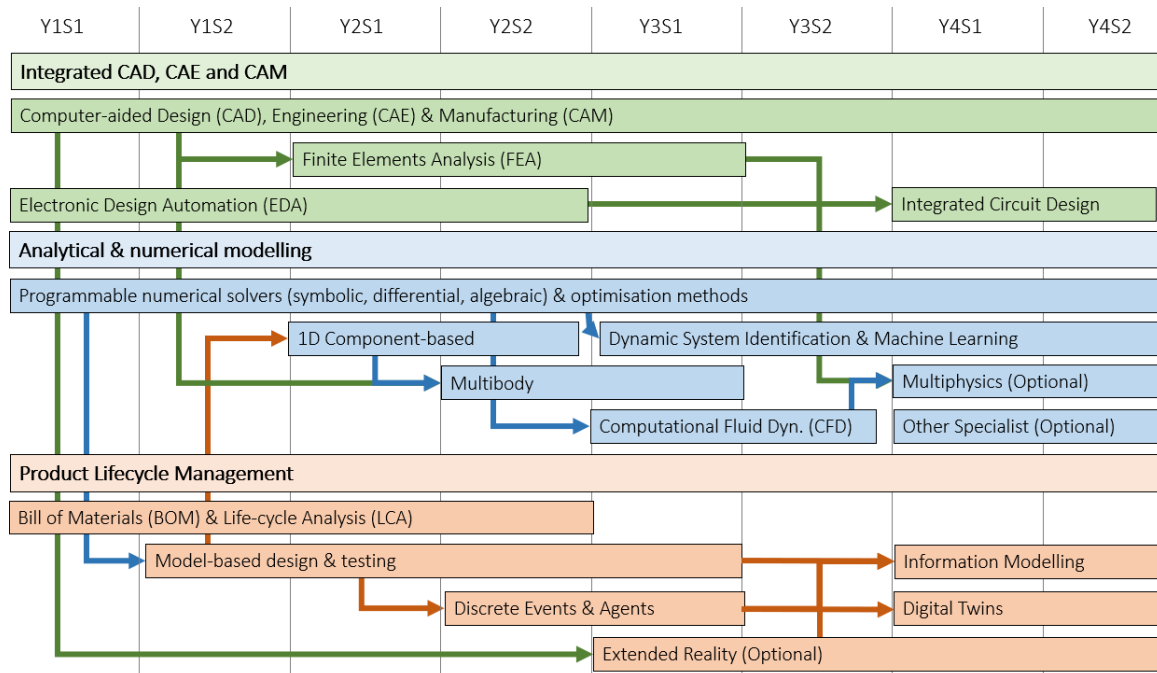

Figure 2: Sample staging of simulation technologies in an undergraduate program

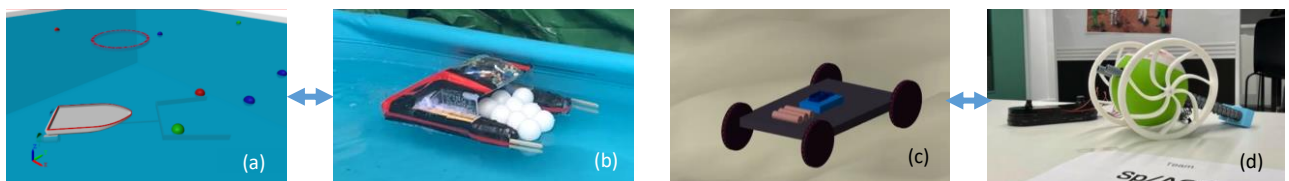

Figure 3: Customisable simulation templates for the design, build & test activities in year 1 (a)-(b) and 2 (c)-(d).

#### 4 Barriers to Simulation in Engineering Education, Feedforward Reflections & Future Vision

As we developed our program strategy, the following challenges were identified for the successful development and running of simulation-based content in our modules:

- **simulation as a barrier to creative design** – the limited proficiency of learners with professional design tools can force them to only use techniques that they already know or are aware of. It is best to sketch models on paper before moving to a computational tool to prevent this inhibition. It is also important that instructors provide a high-level overview of simulation tools to guide learners on the complete workflow before detailing out each step.
- **leveraging collaborative workflows** – While collaborative software features exist in most professional simulation packages, these can often be neglected by learners if not taught explicitly and we have observed a substantial lack of awareness on appropriate collaborative model management and version control. We recommend explicitly instructing learners on how to manage models and using simulation design reviews to provide feedback on best practices.

- **navigating interoperability** – the engineering simulation landscape is fragmented and uses a variety of often proprietary formats. We have identified the need to teach students how to interoperate between tools (an example project is shown in Figure 4), which is also expected to consolidate their ability to critique the limitations of respective simulation tools.
- **learner skill gap** – there is a trade-off between the time required to learn a simulation tool and that available to implement a project. To better align with professional workflows, we often ask students to improve or complete existing simulations and learn features as needed by the project.
- **instructor skill gap** – engineering simulation is a fast-evolving field, and it can be hard for instructors to stay up to date with new features. It is important for HE institutions to invest in instructor training and to nurture relationships with engineering software developers.
- **maintenance of software assets & infrastructure** – software can be harder to maintain than a traditional set of paper-based lecture notes. We are exploring possible solutions for version control and automated testing of software content.
- **computational resources & inclusivity** – students do not have equal access to computational resources. This is compounded by the high computational cost of high-fidelity simulations (e.g. FEA, CFD) and high-performance graphics (e.g. CAD, XR). We have developed a virtual machine solution for the university that uses AWS Appstream services to provide a more inclusive environment for students.

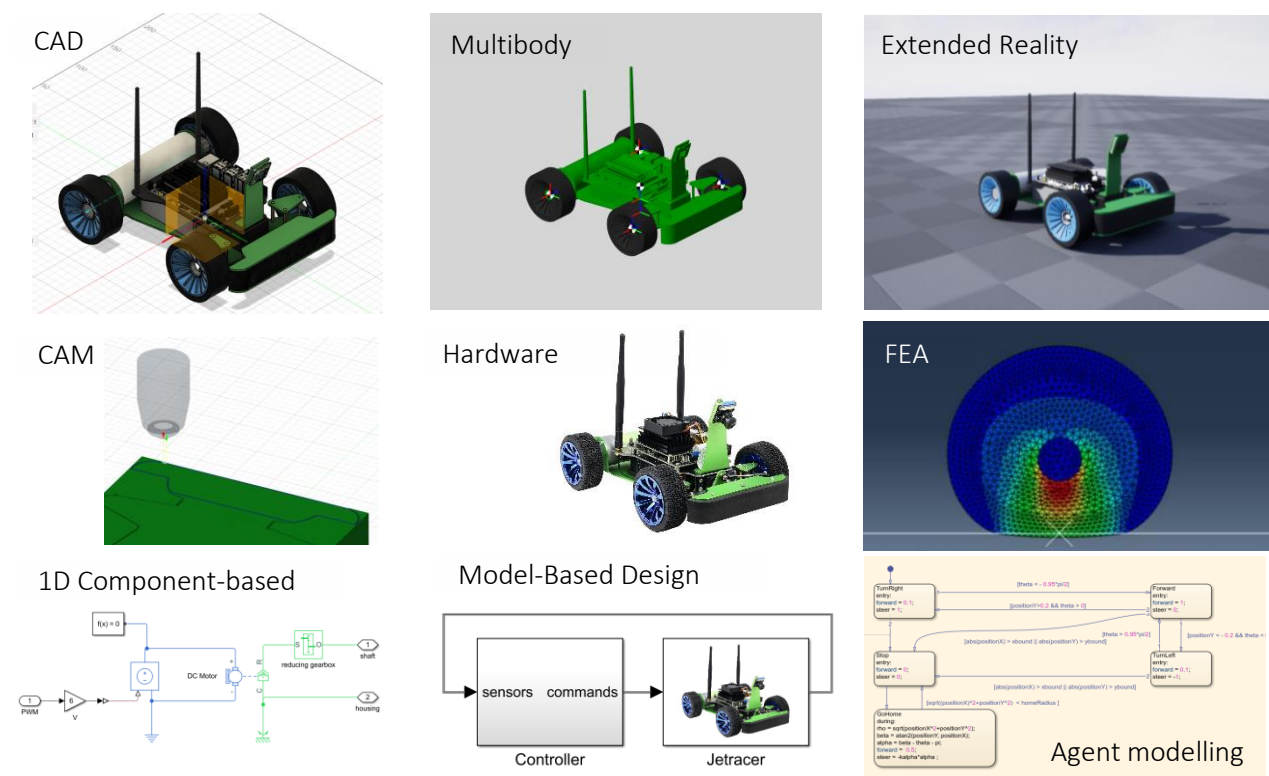

Figure 4: Sample images from a proof-of-concept example for teaching simulation interoperability in a third-year extended group project at KCL based on the Waveshare NVIDIA JetRacer autonomous race car.

## 5 Conclusion

We have established a program-level strategy for engineering simulation and commented on its use in design-led education at KCL. We provided sample learning activities and commented on barriers and future directions for integration into engineering programs. Our next steps are to systematically review the strategy and track the proficiency of learners throughout and beyond the program.

## 6 References

- AHEP, (2020). The Accreditation of Higher Education Programmes. 4<sup>th</sup> ed. *Engineering council*. (n.d.).
- Andersson, K. (2012). Using Model-Based Design in Engineering Design Education. *Proceedings of the ASME 2012 International Design Engineering Technical Conferences and Computers and Information in Engineering Conference*. Chicago, Illinois, USA. August 12–15: 69-76. ASME.
- ASEE (2020). 2020 Survey for Skills Gaps in Recent Engineering Graduates. *ASEE Corporate Member Council*.
- Boucher, M. (2017). Close the Engineering Skills Gap: Prepare New Graduates to Be Real-World Ready. *Tech-Clarity*.
- Campos, N., Nogal, M., Caliz, C. & Juan, A.A. (2020). Simulation-based education involving online and on-campus models in different European universities. *International Journal of Education Technology in Higher Education* 17, 8.
- Ciriello, F. (2022). Scaffolding Project-based Learning (PjBL) at scale with Model-based Design (MBD) & Systems Engineering (MBSE). *Proceedings of the 8th International Symposium for Engineering Education*. University of Strathclyde.
- Davidovitch, L., Parush, A. and Shtub, A. (2006). Simulation-based Learning in Engineering Education: Performance and Transfer in Learning Project Management. *Journal of Engineering Education*, 95: 289-299.
- Magana, A.J. & de Jong, T. (2018). Modelling and simulation practices in engineering education. *Computer Applications in Engineering Education*. 26. 10.1002/cae.21980.
- Rittel, H.W.J. & Webber, M.M. (1973). Dilemmas in a General Theory of Planning. *Policy Sciences*. 4 (2): 155–169.

# Work in progress – Imagining / Designing Informal Learning Spaces for PBL

Isabelle Lermigeaux-Sarrade

Teaching Advisor, Ecole Polytechnique Fédérale de Lausanne (EPFL), Switzerland, [isabelle.lermigeaux-sarrade@epfl.ch](mailto:isabelle.lermigeaux-sarrade@epfl.ch)

Ingrid Le Duc

Teaching Advisor, Ecole Polytechnique Fédérale de Lausanne (EPFL), Switzerland, [Ingrid.leduc@epfl.ch](mailto:Ingrid.leduc@epfl.ch)

## Summary

The paper presents ICAP (interactive, constructive, active and passive) as the theoretical framework to understand the role of informal learning spaces as an active learning tool when students have informal meetings to work on projects.

Students in our Engineering school were asked to illustrate poor and active informal learning spaces using tangibles.

Data was collected during focus groups with Master-level students from various STEM disciplines.

The principles for learning drawn from the imagined spaces were then drafted as recommendations for the architects who are currently designing new learning spaces for 2028 at our school.

The added value for using ICAP to carry out a collaborative task is that the student-as-client vision clearly incorporates active learning principles from the outset of their architectural design.

**Keywords:** ICAP, Informal spaces, empathic design, tangibles, STEM

**Type of contribution:** Best practice extended abstracts

## 1 Interacting in informal spaces with learning in mind -Introduction/context

Constructive discussion among students is a most desirable learning opportunity; and in this paper we propose a format for informal learning spaces that provides students key opportunities to consolidate Project Based learning.

Informal working spaces represent all the physical spaces on campus that can be used for working without direct supervision (Ellis & Goodyear, 2016). Developing informal learning spaces that meet student needs and stimulate active learning is a timely project that complements well our current architectural initiatives.

To support the reflection on the development of informal learning spaces in our institution, in Spring 2022 we collected data about three informal learning spaces. These spaces were rated using the third version of the Learning Space Rating System (LSRS) developed by Brown, et al (2017) for the EDUCAUSE Learning Initiative®. The results from the surveys gave us significant data about students' perception of the existing informal learning spaces.

Accordingly, our recent post-COVID survey exploring learning habits on campus found that while students often miss lectures and instead they are present elsewhere on campus to meet with peers and carry out teamwork or advance projects. It became obvious to us that student expectations on informal learning spaces deserved a closer look. Therefore, this study aimed to find out *what* students want and *need* in informal



learning spaces. We used focus groups interviews with an empathic-design approach (Kouprie and Visser, 2009).

### 1.1 The ICAP framework

We used the ICAP framework proposed by Michelene T.H. Chi and Ruth Wiley (2014) because it explains well the formal and the informal set-ups scaffolding student learning. ICAP is the acronym for Interactive-Constructive-Active and Passive; four observable student behaviours. These are underpinned by specific cognitive mechanisms improving concept assimilation, accommodation, retention and recall; the key mechanisms of learning.

In formal spaces, Passive is point blank and students don't engage with content, no learning is expected as students sit and watch a lecture or a class passively. Learning begins when students engage with content by activating their attention. Thus, 'Active' could be taking notes, underlining key passages in a text and manipulating equipment; movements which are semi-automatic; such as manipulating objects for experiments to run smoothly and safely. Active is a first step for constructive learning as it requires attention and memorization. Once students engage at an active phase, they can then become Constructive and then Interactive. 'Constructive' is where students engage with content by producing an additional output to what has been presented. For example, they fill in a blank, give an opinion or speculate and recommend. In lecture halls, seminars or group work sessions, the teacher would facilitate the constructive engagement with content by monitoring equal participation, valuable input and give feedback. Accordingly, only once students have engaged constructively, they are ready to engage Interactively and share their input with peers, get feedback, review, correct and consolidate learning. The ICAP framework has been iteratively applied and tested for better learning, for example in seminar discussions with health professionals (Lim, 2019) and journal article understanding in material science undergraduates (Menekse, et al, 2013).

In this paper we frame the use of informal spaces into a template for active, constructive and interactive engagement with disciplinary content using ICAP. Our hypothesis is that this template will help explain why the existing informal spaces boost or hinder learning. A secondary aim is to make concrete pedagogical recommendations for architectural design of informal learning spaces. One aspect that is important to remember about informal spaces is their implicit role in students learning when it promotes a fair distribution of time to talk, time to listen, time to produce and time and conditions to share.

## 2 Focus groups and population

Berman (2020) underlined the need of exploring informal learning spaces through the lenses of qualitative methods, such as focus groups. These group discussion-based investigative methods was first developed during the after-war period out of the one-to-one interviews by Merton & Kendall (1990). Focus groups have since been popularised and applied for research in various domains such as management studies to test the acceptance to change, marketing research to test new products (Kamberelis G. & Dimitraidis, G., 2005). Later, they were adopted for scientific research in the human sciences and social psychology to study societal problems such as racism, prejudice and exclusion (Howarth, C.S., 2006). Nowadays, focus groups can be set-up and carried out virtually using a range of digital technologies. It can be said then, that focus groups have a long history of investigating perception, opinions and values that are commonly shared by groups and in various scenarios (Rodriguez, et al, 2011; Turney & Pocknee, 2005).

In the context of this study, we used focus groups during a workshop and participants discussed their experience of doing an activity that was created to develop different transversal skills using tangibles (Jalali, et al, 2022). The combination of activities with tangibles aimed to validate the production of the activity.

Following the protocol (around 4 to 20 participants) our focus groups were monitored by facilitators who ensure that participants got equal opportunities to share their personal views. At times, focus groups led to an agreement. Combining focus group results with other qualitative or numerical data is often used to

validate the data. The combination of methods, known as triangulation, validates results and test their potential outreach.

## 2.1 The population

70 students from at least 10 engineering programs were presented the ICAP framework and the concept of empathic design and were invited to participate in a focus group dedicated on both informal learning spaces and future lecture halls. Of these students, 28 were specifically assigned in examining informal learning spaces. Participation was anonymous therefore no data on gender was collected. Students had to work in small groups on the situation described as: Please have an informal meeting with teammates about your project.

## 2.2 Data collection

As a first step, the 23 students assigned to the informal learning task were asked to individually imagine a nightmare learning space and represent it concretely using white paper, colored pens, post-its and bricks. They were then asked to discuss in small groups and to choose the one construction depicting the worst scenario. Finally, each group created a poster setting their chosen building at its centre and adding descriptive or supporting legends around it. Figure 1 is an 'nightmare' scenario example (Figure 1).

A second step invited students to think back to the ICAP model presented previously in the lecture and to build together an informal learning space adapted for interactive learning on projects. The result of this discussion was again represented in poster, with a construction and they also had to give 4 written recommendations for architects that will be in charge of conceiving a new building in our school (Figure 2).

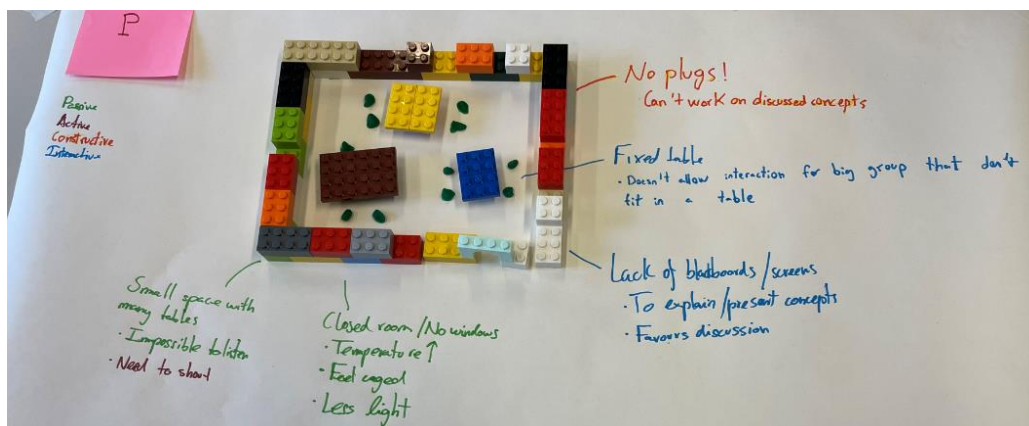

Figure 1: A nightmare informal learning scenario

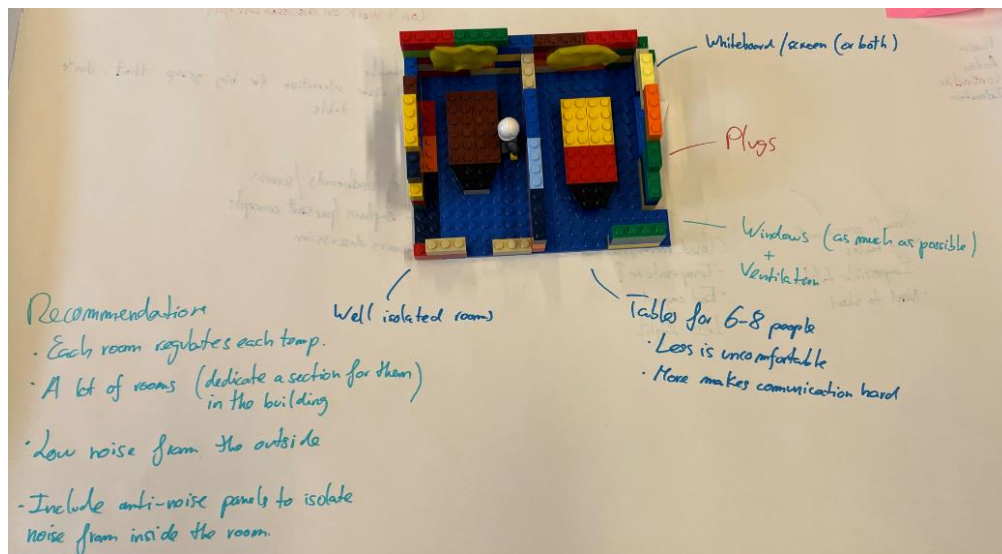

Figure 2: An informal learning space intended to promote active learning

### 3 Results – pictures and mind-mapping

Some students used legends that explicitly refer to the ICAP framework, using different colours to indicate factors that limited Passive, Active, Collaborative and Interactive Learning (See Table 1).

The legends of the 'nightmare' posters were put together into a list of expectations. The full list provides us with a glimpse of students' basic fundamental needs for transforming these nightmares into functional informal learning spaces. A 'hollow' reading of this list allows us to list their expectations. In Table 1, we associate the items of the list with ICAP.

Table 1: Student expectations of informal learning spaces

Expectation	ICAP
access to sockets and wifi connection	P, A
sufficiently large tables (no shelves attached to seats)	P, C
tables spaced out so that they do not feel crowded, with easy access between tables	C, I
boards for writing and presentations	C, I
space to isolate oneself from the crowd	C

To structure the texts and recommendations provided we created the mind map shown in Figure 3.

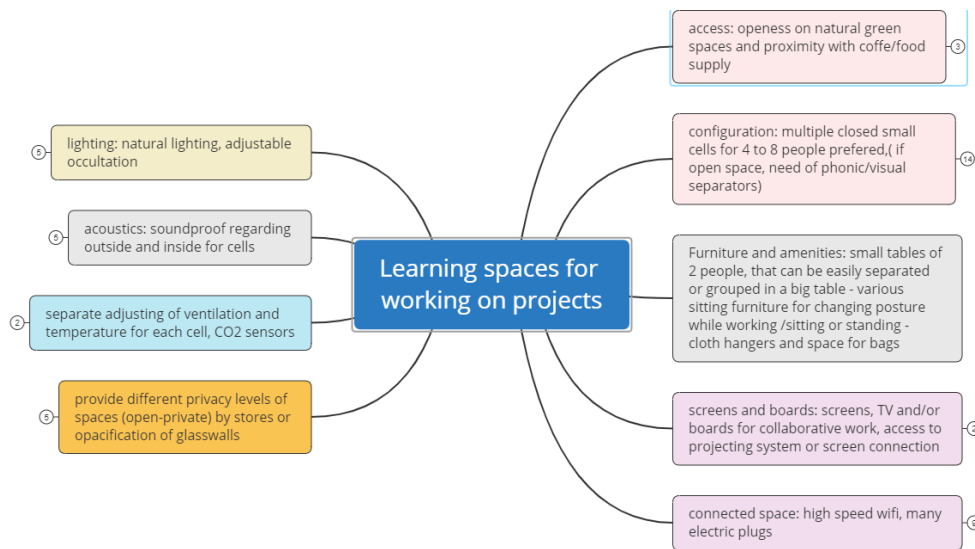

Figure 3: Mind-map showing a summarising of the student recommendations that were forwarded to the architects

#### 4 Discussion and conclusions

The results confirm our hypothesis that using the ICAP template helps to identify the reasons why the existing informal spaces boost or hinder learning. Our results also show that working on tangibles help to formulate concrete pedagogical recommendations.

First, informal spaces boost student learning by providing basic infrastructure for meetings, such as plugs, connections, etc. These results are comparable to the findings of Harrop and Turpin (2013). For instance, their observations and interviews on the Sheffield campus showed that students search for privacy with access to catering and comfort in facilities, a kind of “home-way” conditions for learning on campus.

Second, and also similar to Harrop and Turpin (2013), we found that students actively search for a set-up that allows for flexible learning, one that will allow them to fix online meetings and group work at a distance, and where 80% of seated individuals in informal spaces and groups used PCs. We believe that the numbers increased since the COVID pandemic.

Third, our workshop format combining tangible and focus group discussion effectively encouraged participants to reflect on a specific set-up: working on campus on projects with your teammates. It is possible that this format led students to work on a larger group composition than studies drawing conclusions solely on expert observations. Seemingly, in our case, students viewed groups of 4 to 8 students, differently to the ethnographic observations of smaller group interaction in informal spaces (Harrop and Turpin, 2013).

Fourth and last, the appropriation of informal spaces relies on offering the possibility to accommodate the setup. For example, by moving furniture around and accommodating chairs, table height, room temperature, boards and other material. Additionally, our results show that students attribute a high value to possibility for changing posture, seating or standing during discussions supports their engagement with group work.

Finally, the ICAP framework seems a well-suited framework to nurture user reflection on learning spaces as well as for orienting the construction of informal spaces to support active learning. Users surveyed on informal spaces could rely on the different aspects of the model for examining the existing features of a given space. Having active learning in mind, ICAP may also help to articulate improvements on space design. We could even think that using ICAP will prevent a superficial opposition of informal and formal spaces for learning as described by Boys (2009) and thus, offering a fruitful exploration of the complex relationships between space and learning.

## 5 References

- Berman, N. (2020). A critical examination of informal learning spaces. *Higher Education Research & Development*, 39(1), 127-140.
- Boys, J. (2009). Beyond the beanbag? Towards new ways of thinking about learning spaces. *Networks*, 8(Autumn).
- Brown, M., Cevetello, J., Dugdale, S., Finkelstein, A., Holeton, R., Long, P., Meyers, C. (2017). The Learning Space Rating System (version 2), EDUCAUSE Learning Initiative.
- Chi, M.T.H and Wylie, R. (2014). The ICAP Framework: Linking Cognitive Engagement to Active Learning Outcomes, *Educational Psychologist*, 49(4), 219-243.
- Ellis, R. A., & Goodyear, P. (2016). Models of learning space: Integrating research on space, place and learning in higher education. *Review of Education*, 4(2), 149-191.
- Jalali, Y., Kovaks, H., Isaac, S., & Dehler Zufferey, J. (2022). Bringing Visibility to Transversal Skills in Engineering Education: Towards an Organizing Framework. *Proceedings of the 50th Annual Conference of the European Society of Engineering Education SEFI 2022*. Barcelona, Spain. ISBN 978-84-123222-6-2.
- Howarth, Caroline (2006) Race as stigma: positioning the stigmatized as agents, not objects. *Journal of community and applied social psychology*, 16 (6). pp. 442-451 DOI: 10.1002/casp.898 .2006 John Wiley & Sons, Ltd.
- Harrop, D., & Turpin, B. (2013). A study exploring learners' informal learning space behaviors, attitudes, and preferences. *New Review of Academic Librarianship*, 19(1), 58-77.
- Kamberelis, G., & Dimitriadis, G. (2005). Focus Groups: Strategic Articulations of Pedagogy, Politics, and Inquiry. In N. K. In Denzin & Y. S. Lincoln (Eds.), *The Sage handbook of qualitative research* (pp. 887–907). Sage Publications Ltd.
- Kouprie, M., & Visser, F. S. (2009). A framework for empathy in design: stepping into and out of the user's life. *Journal of Engineering Design*, 20(5), 437-448.
- Lim, Jaeseo, Hyunwoong Ko, Ji Won Yang, Songeui Kim, Seunghee Lee, Myung-Sun Chun, Jungjoon Ihm, & Jooyong Park. (2019). Active learning through discussion: ICAP framework for education in health professions. *BMC Medical Education* 19, n° 1 (30 December 2019): 477. <https://doi.org/10.1186/s12909-019-1901-7>.
- Menekse M, Stump G, Krause S, & Chi M. (2013). Differentiated Overt Learning Activities for Effective Instruction in Engineering Classrooms. *Journal of Engineering Education*, 102 (3), 346-374.
- Merton R. K., Fiske M., & Kendall P. L. (1990). *The focused interview: A manual of problems and procedures*. New York (2<sup>nd</sup> ed). Free Press.
- Rodriguez, K. L., Schwartz, J. L., Lahman, M. K. E., & Geist, M. R. (2011). Culturally Responsive Focus Groups: Reframing the Research Experience to Focus on Participants. *International Journal of Qualitative Methods*, 10(4), 400-417. <https://doi.org/10.1177/160940691101000407>
- Turney, L., & Pocknee, C. (2005). Virtual focus groups: New frontiers in research. *International Journal of Qualitative Methods*, 4(2), Article 3. Retrieved [29.03.2023] from [http://www.ualberta.ca/~ijgm/backissues/4\\_2/pdf/turney.pdf](http://www.ualberta.ca/~ijgm/backissues/4_2/pdf/turney.pdf)

# A Learning Ecosystems framework for Engineering Education

Renate G. Klaassen

4TU Centre for Engineering Education/ DIAM -EEMCS TU Delft, Netherlands, [r.g.klaassen@tudelft.nl](mailto:r.g.klaassen@tudelft.nl)

Hans Hellendoorn

Cognitive Robotics – 3ME -TU Delft, Netherlands, [J.hellendoorn@tudelft.nl](mailto:J.hellendoorn@tudelft.nl)

Linette Bossen

3ME- TU Delft, [R.H.Bossen@tudelft.nl](mailto:R.H.Bossen@tudelft.nl)

Birgit de Bruin

3ME- TU Delft, [B.J.E.deBruin@tudelft.nl](mailto:B.J.E.deBruin@tudelft.nl)

## Summary

In Delft, we are transforming the education system on three levels: (1) New courses and projects in existing BSc and MSc programmes for multi/inter/transdisciplinary and reflective learning, with a focus on personal development, and professional skills (3) Elective Joint Interdisciplinary Projects (JIP) for students from different disciplinary programmes. The university aims to offer students a learning ecosystem in which identity building can occur, interdisciplinary teamwork is fostered and intense interaction with the professional world (industry & government) sets a new standard necessary to address complex societal challenges. In this paper, we will explain the ecosystem and share the results of a focused group interview with students who experienced learning in this ecosystem. The results show that students better understand their future role in the community as engineers, feel that they have acquired new skills, are better at framing complex problems and are more competent to work in the industry.

**Key words:** Learning Ecosystems, Transformative Education, Challenges-based learning, Reflection

**Type of contribution:** best practice extended abstracts

## 1 Introduction

University, government and business partnerships have been on the rise in the past decade, stimulated by governments who consider the contribution of academic researchers towards scientific integration and technological advances as preconditional for economic welfare in society (Hillebrand & Werker, 2019). The belief that universities are responsible for major societal transformations continues to grow (van Damme, 2022). In Delft, this persuasive belief of the "Innovative University" has led to more collaborative activities. Various collaborative learning projects have been set up with external partners. These range from different fields and living labs to convergence partnerships, as well as community-based practices and industry or civil society collaborations (Prieto et al., 2023). It even includes students with different learning levels who work together on societal challenges, e.g., Blue Engineering projects, Hackathons and other formats. The involvement of various stakeholders leads to collaborative partnerships that require cross-boundary knowledge, value and target systems (Fung, 2017).

In Delft, the focus is on incremental and dynamic change. New forms of education are developed within an overarching mission-driven framework supported by institutional management. However, it is initiated bottom-up through staff ideas and motivation (Graham, 2018). The framework encourages the implementation of civic university collaborations, creating an expanded learning ecosystem for engineering students' learning.

We use the term 'learning ecologies' or 'learning ecosystems' to describe ecological elements characterising the educational ambitions of Delft: (1) the curriculum has a multi/interdisciplinary or transdisciplinary nature, involving multiple non-scientific and scientific stakeholders and perspectives to solve complex problems and a flexibilization of problem-solving processes (Crawley et al., 2019). Critical criteria for inter/transdisciplinary working are collaboration, reflection, an open mindset, integration of knowledge, and critical thinking (Menken, 2016). (2) Stakeholders become co-creators of knowledge in their respective knowledge systems (3) in authentic and real-life and open learning environments (4) which engender performance modelling in addition to classic assessment and (5) involve continuous reflection on task, process and personal growth (Barnett, 2020; den Brok, 2018). Where possible, these include high-level technological innovations using the latest digitised tools.

The learning ecosystem fosters formal and informal learning formats, including challenges, aiming to solve and or embed meaningful and responsible change (free definition adapted from Arjen Wals, 2020).

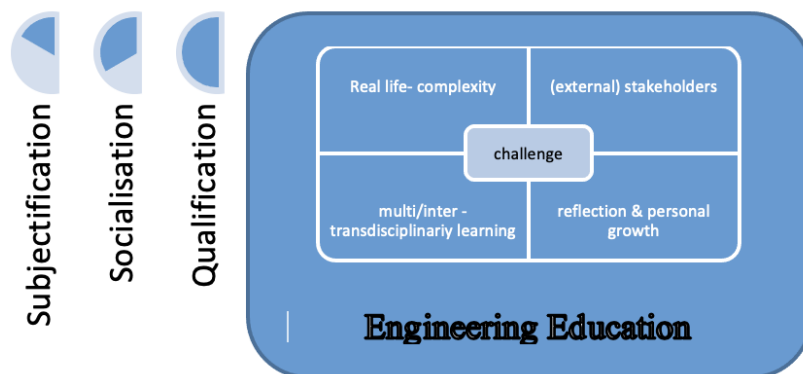

Fig. 1. Engineering Education Model TU Delft

Complementary to this learning ecologies paradigm, we have included societal responsibility towards the learner in the curriculum design. Biesta (2017, pp. 29-30), who coined this "pedagogical responsibility", stated; that pedagogy should involve the tripartite development of qualification, socialisation and subjectification to allow engineers to become complete and worthy human being and citizen. Qualification covers domain and discipline-specific knowledge and skills. Socialisation is the position the discipline holds in relation to the world. Subjectification is: knowing who you are as a person and how this self-knowledge relates to the surroundings, allowing for personal growth.

Consequently, the learning Ecosystem is defined as; a mediated configuration of formal and informal learning allowing engineering students to define and solve (societally embedded) challenges while building their profile as whole new engineers who have gone through the process of Subjectification, Socialisation and Qualification. With these learning ecosystem elements, identity building can occur, inter and or transdisciplinary teamwork is fostered, and intense interaction with the professional world and government is necessary to finish any engineering challenge.

**Guiding principles:**

- Students are responsible for their learning (trajectories **(subjectification – responsibility for their learning)**)
- Students learn how to design their engineering profile and their life: **(life-long learning - subjectification)**
- Student can apply their knowledge in a changing and dynamic field/domain **(life-long learning/ subjectification)**
- Students value and respect the contributions of other disciplines **(socialization)**
- Students can reflect on their role in a team and know their strengths and weaknesses and are willing to work on them. **(socialization)**
- Students master transferable skills. **(socialization – subjectification, qualification)**
- Students know about and embrace the UNESCO Sustainable Development Goals **(qualification – subjectification-socialisation)**
- Students learn how to become ethical and responsible engineers **(subjectification-, socialisation-qualification)**

(fig.2). Guiding Principles TU Delft

In Delft, we are transforming the education system towards incorporating these learning ecosystem elements and guiding principles in different configurations. This initiative means that education is designed around societal challenges and that the three pillars of qualification, socialisation and subjectification are taught in conjunction. The transition takes place through new challenge-oriented courses in existing BSc and MSc programmes, including multi/inter/transdisciplinary, reflective learning, and transversal or professional skills development.

The main question is: “What is the contribution of these learning ecosystem elements towards professional behaviour we defined in these principles?”

We will briefly describe a 60 EC first-year Robotics master’s programme and a 15EC Joint Interdisciplinary Project (JIP) (1EC=28 hours). To clarify which elements are embedded in the learning ecosystems configuration, we have made a dashboard for each about the extent to which external stakeholders, real-life cases, multi, inter, transdisciplinary focus and reflection are incorporated. We will briefly describe the essential learning ecosystem elements and how students perceived the course based on focus-group interviews.

## 1 First-year MSc Robotics (RO, 60EC)/ Joint Interdisciplinary Project (15 EC)

New MSc programs focused on multi-disciplinarity, personal development, and professional skills have been developed: (1) Robotics and (2) Quantum Information Systems and Technology. The Robotics programme started in 2020. The robotics engineer understands industrial and logistics processes and can advise on using robots. Similarly, the Quantum engineer understands industrial and logistics processes and can advise on using quantum computing. The robotics programme is an entire year, includes a multidisciplinary project (5EC), and heavily emphasises reflection throughout the programme.



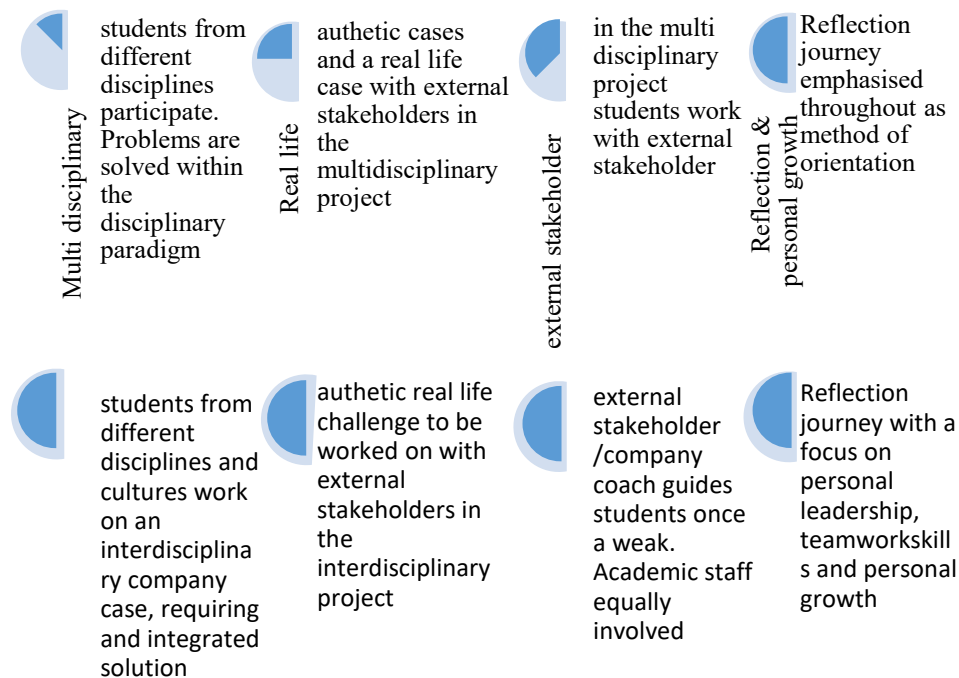

Fig. 3 Dashboard Robotics Programme/JIP programme

In the multidisciplinary project, students work with 4 Robot (driven) companies (Lely, Ahold Delhaize, Festo and SamXL) on real-life cases or challenges to find robot-integrated solutions. Student teams of four develop a complete, integrated software package for a complex robot system while regularly consulting with the company. They do the development and testing in a simulated environment and then implement it in a real robot at the end of the course. At the beginning of the first year, the students describe their goals, ambitions, interests, and networks and design a picture of their future role as robotics engineers, including the required competencies. Throughout the program, students work on individual portfolios to reflect on their acquired skills and ambitions while receiving peer group input.

The second course discussed in the learning ecosystem is the Joint interdisciplinary Project (JIP). The 2nd year master course is offered yearly to 200+ students. In the JIP project (bottom of fig. 3), four or five students from different MSc programs and with different gender and cultural backgrounds cooperate in a 10-week full-time real-life engineering or design challenge offered through the company's R&D department. A company representative is available one or two days a week for the student team, and regular or frequent company visits are part of the project. Problem-solving is a co-creative process with the company and academics in interdisciplinary teams and 360-degree feedback on results and should contribute to the Sustainable Development Goals. For personal growth, there is a series of reflections and 360-degree feedback from team members to grow leadership skills over time. Teams regularly provide each other with feedback on personal growth goals and team collaboration.

#### 4 Focused Interview results

We have held focus group meetings with students and Mentors of Robotics. 11 students and mentors participated in this focus group meeting on Robotics, and the JIP students left testimonials. A journey map evaluation, showing touch points of the course elements that could be scored high, low or neutral, was used

to investigate student likes and dislikes of the learning ecosystem. Content arguments on post-its were given on what worked and did not work, pasted on the journey map and were the basis for further discussions. The analysis focused on frequencies, e.g., helping in personal development occurred seven times. Testimonial transcripts are similarly scored on the levels of Biesta and based on the occurrence of emergent categories and frequencies. Some of the students' preliminary quotes are included on the elements of Subjectification, Socialisation and Qualification. One of the questions we have asked the student is what they acquired in terms of professional skills during the Robotics programme and for the testimonials from JIP.

### **Subjectification**

Robotics: 'The portfolio was hard to set up in the beginning but helped me in my personal development, and I think it was very good to have, by design, spread out over the 1.5 years.' Student 1

JIP: "I really enjoyed, but I don't quite see how this course fits in my academic career. It felt more like a personal development project." Student 45

### **Socialisation – life-long learning**

Robotics: 'I like the variety of the assignments and the connection to developments in the outside world; it always felt like we were working on contemporary topics.' Student 6

JIP: "Broad connection with both academic and professional" student 30

### **Qualification- Engineering knowledge**

Robotics: 'It is always important to go back to the general question and not to get lost in detail.' Student 3

'Breaking down the problem helps with developing a solution.' Student 4

JIP: "I failed to use previously learned theories in the project to the extent I thought should be used. The reason was that I couldn't convince the team that this is the way to do it. I think I was not able to convince them because I didn't feel confident about the method and if it would be useful to the specific problem we had. I was also not good at familiarizing my teammates with my discipline." Student 20

The Robotics students pointed out that mentor guidance and continuous reflection helped them to become more autonomous learners. In JIP, we have seen a transformative learning experience in which students quickly need to become interdependent and autonomous learners. Pushed out of their comfort zone, they need to recognise that many assumptions concerning subjectification/socialisation behaviour no longer hold and must adapt to the challenges they meet in the course. Available staffing and support are essential in making this work.

## **5 Conclusions**

Overall, it showed that students feel they have acquired new skills, feel better about framing complex problems, and feel more competent to work in industry after completing one of these Courses, including these learning ecosystem elements. We have started with the following main question; "What is the contribution of these learning ecosystem elements towards becoming an engineer as defined by the guiding principles?" Based on the student's feedback, the following assumptions are made; (1) if the learning ecosystem includes the described elements and guiding principles, students' perceived subjectification/ socialisation capacities increase over time. (2) Reflection and confrontation with the self, contribute to subjectification, creating a foundation to question both self and others. Agency helps students to take responsibility for their actions in relation to others, including ethical deliberation, responsible action and consideration of the SDG's. (3) Peer-review activities and benchmarking with team members and the professional field support the socialisation process. Indeed, the most effective on all levels is a confrontation with real-life cases, external stakeholders, complex challenges and a diverse student population, with the side observation that only if sufficient guidance is offered Biesta's model will work (Kahu,2018). The essence is that students in the learning ecosystems courses that include the three

pedagogical components of Biesta's subjectification, socialisation and qualification become engaged in constant dialogue with the world's technological artefacts, stakeholders, and society. They seem to become more rounded engineers.

With these newly developed courses, the university offers students an emerging learning ecosystem in which identity-building can take place (Barnett, 2020), interdisciplinary teamwork is fostered (Picard et al., 2021), and intense interaction with the changing society and professional world like companies, government, hospitals necessary to solve the presented challenges are encountered (Lattuca et al., 2010)

## 6 References

- [1] Barnett, R. & Jackson, N. (eds) (2020), *Ecologies for Learning and Practice, Emerging Ideas, Sightings, and Possibilities*, Routledge Taylor & Francis Group, ISBN: 978-1-138-49688-0
- [2] Biesta, G. (2017). *The Rediscovery of Teaching* (1st ed.). Routledge. <https://doi.org/10.4324/9781315617497>
- [3] Crawley, E.F., Hosoi, A.E. (2019), Moving Forward with the New Engineering Education Transformation (NEET) program at MIT-Building Community, developing, projects and connecting with industry, American Society for Engineering Education.
- [4] Den Brok, P. (2018), *Cultivating the Growth of Life-science Graduates; on the role of educational ecosystems*, Inaugural address Wageningen University
- [5] Fung, D. (2017) , *A Connected Curriculum for Higher Education*, London – UCL press, [doi.org/10.14324/111.9781911576358](https://doi.org/10.14324/111.9781911576358)
- [6] Graham, R. (MIT report) The global state of the art in engineering education, march 2018
- [7] Hillerbrand, R. & Werker, C. (2019), Values in University Industry Collaborations: The case of Academics Working at Universities of Technology, *Science and Engineering Ethics*, 25: 1633 – 1656, <https://doi.org/10.1007/s11948-019-00144-w>
- [8] Kahu, E.R. & Nelson, K. (2018) Student engagement in the educational interface: understanding the mechanisms of student success, *Higher Education Research & Development*, 37:1, 58-71, DOI: 10.1080/07294360.2017.1344197
- [9] Lattuca, L. R., Terenzini, P. T., Harper, B. J., & Yin, A. C. (2010). Academic Environments in Detail: Holland's Theory at the Subdiscipline Level. *Research in Higher Education*, 51(1), 21–39. <http://doi.org/10.1007/s11162-009-9144-9>
- [10] Menken & Keestra, (2016), *An Introduction to Interdisciplinary Research*, Amsterdam University Press, DOI:[10.5117/9789462981843](https://doi.org/10.5117/9789462981843)
- [11] Picard, C., Hardebolle, C., Tormey, R. & Schiffmann, J. (2021) Which professional skills do students learn in engineering team-based projects?, *European Journal of Engineering Education*, DOI: 10.1080/03043797.2021.1920890
- [12] Prieto, L. , Ruiz-Cantisani, V. , Arrambide-Leal, M. I., Cruz-Hinojosa E. J., Mojika J., Rivas-Pimentel M., J. R. & Membrillo- Hernández, J. (2023). Challenge-based learning strategies using technological innovations in industrial, mechanical and mechatronics engineering programs. *International Journal of Instruction*, 16(1), 261-276.
- [13] Reymen, I. , Bruns, M., Lazendic-Galloway, Helker, K., Valencia, A., Vermunt, J. (2022), Fostering Challenge-based learning Through TU/e innovation Space, in *The Emerald Handbook of Challenge Based learning*, Emerald, DOI: 10.1108/978-1-80117-490-920221002
- [14] Van Damme, D. (9 March 2022), *Higher education in transition or transformation?* Lecture Dirk van Damme, 104th Dies Natalis Wageningen University & Research.
- [15] Wals, A.E.J., (2020), Sustainability- oriented Ecologies of Learning as a response to systemic global dysfunction, in Barnett, R. & Jackson, N. (eds) (2020), *Ecologies for Learning and Practice, Emerging Ideas, Sightings, and Possibilities*, Routledge Taylor & Francis Group, ISBN: 978-1-138-49688-0

# A Transformation in Teaching Software Engineering Novices Based on Their Errors When Learning Design Patterns

Tammar Shrot

Shamoon College of Engineering, Israel, [tammash@sce.ac.il](mailto:tammash@sce.ac.il)

Ayelet Raz

Shamoon College of Engineering, Israel, [ayelera@ac.sce.ac.il](mailto:ayelera@ac.sce.ac.il)

Ronit Shmallo

Shamoon College of Engineering, Israel, [ronits1@sce.ac.il](mailto:ronits1@sce.ac.il)

Lior Aronstham

Shamoon College of Engineering, Israel, [liorar1@sce.ac.il](mailto:liorar1@sce.ac.il)

## Summary

Design patterns (DPs) are a powerful tool broadly used by experienced programmers to fine-tune their code systems. They are extremely useful for solving commonly accruing coding and design problems. Therefore, DPs are a requirement for software engineers. Unfortunately, DPs are difficult to learn and use correctly without extensive practical experience. Thus, this paper re-examines the method for learning DPs. We conducted an experiment with software engineering students. The students were given the description of a system and asked to identify what DPs were needed. We analyzed their errors and classified them.

The analysis shows that students have more difficulty understanding some DPs, such as Visitor, while other DPs are easier. Students tend to use some DPs more than others, even though they do not fit the context; these are usually DPs with a wide range of uses, such as Proxy. Given these findings, we formulated a more specific teaching approach to help novices overcome these problems. We suggest a transformation in the learning method to help students, and later engineers, develop a deeper and better understanding of DPs.

**Keywords:** design patterns, software engineering education, error analysis, transformation of teaching method

**Type of contribution:** Research extended abstract

## 1 Introduction

Many repetitive problems tend to arise when programmers are trying to build an efficient and flexible software system. These problems can be solved by the correct use of existing software tools in a specific design. Such a solution is called a *design pattern* (DP) (Fojtik, 2014; Gamma et al., 1994). All DPs are grouped into three main types: creational, collaborational, and concurrency.

Learning DPs effectively gives students the skills needed to combine theory and practice (Berdun et al., 2014) and helps them build better quality products (Karre et al., 2021). Unfortunately, traditional teaching yields insufficient results (Zhang, 2021). When students are first introduced to DPs, they usually have difficulty grasping the aspects and nuances of identifying and implementing these design solutions (Reischmann & Kuchen, 2018). These difficulties arise from the need to understand the concept at a high level of abstraction and to realize how to effectively use DPs (da Cruz Silva et al., 2019).

The difficulty in teaching DPs has led many educators to try a variety of teaching methods, such as gaming and project-based learning, to improve students' understanding of DPs (da Cruz Silva et al., 2019; Jeremic et

al., 2011; Karre et al., 2021). Each method has its advantages. However, even when students acquire knowledge about DPs, they still lack a deep understanding of them. This is reflected, for example, in difficulties identifying DPs in real-life scenarios (da Cruz Silva et al., 2019).

The aim of this research was to improve students' understanding of DPs. Hence, we identified and analyzed common errors that students make, using DPs in real-life scenarios, and we sought the source of these errors. We drew the conclusion that after students first acquire basic knowledge about DPs, it is important to sharpen their understanding of the practical differences between them. Thus, we offer a transformation from the common one-stage teaching method to a more effective and focused two-stage teaching method. In the second stage, after students acquire the knowledge, educators will conduct more sessions in which they follow the recommendations introduced at the end of this paper. The novelty of the research is that our approach relies on common errors students make when they implement what they have learned about DPs.

## 2 Study description

### 2.1 Research rationale and questions

Students have difficulties when trying to identify, use, or understand DPs. Hence, the rationale of our study was to analyze students' work with DPs, characterize their errors, and try to identify the source of those errors. Next, we used the information gained to transform the current teaching method into a two-stage teaching approach to give students a deeper understanding of the real-life use of DPs. The following research questions were posed: (1) Which DPs are more problematic for students to understand and use correctly? (2) What common replacements can we detect among the DPs? (3) How many of the wrongly exchanged DPs were the right type and how many were not?

### 2.2 Study population

The study was conducted with 82 undergraduate students in the department of software engineering at an engineering college. The students were in their second semester in their second year. The Advanced Object Oriented Programming (AOOP) course was taught for 13 weeks using the Java programming language. The course consisted of 3 hours of teacher-centred lectures and 2 hours of practical training per week. The final grade was based on a practical project that consisted of four programming exercises and a comprehensive exam with open material at the end of the semester. The DP subject is integrated throughout the entire AOOP course. However, in the final 4 weeks of the course, the syllabus focuses solely on DPs. Teaching the DPs includes frontal lectures, implementing DPs in the lab, and solving theoretical and practical questions related to the DPs learned.

### 2.3 Research tools and methods

The main research tool was a question (out of 5) from the final exam of the course, which focused on identifying DPs in a specific system description. The question described a system that needed to be designed and had several requirements. The students needed to (1) describe six required DPs in this story (one point per correct DP); (2) identify the type of DP (one point per correct DP); and (3) explain (including quotes from the story) why this pattern was required in this story (two points per correct DP). The study applied a qualitative method of analyzing students' answers, focusing on the wrong answers and the students' explanations, since their justifications revealed their perceptions and misconceptions.

## 3 Preliminary results

### Q1: Which DPs are more problematic for students to understand and use correctly?

Figure 1 shows how students wrongly used the six DPs that were studied. It can be seen that the Adapter DP was the one with the least errors.

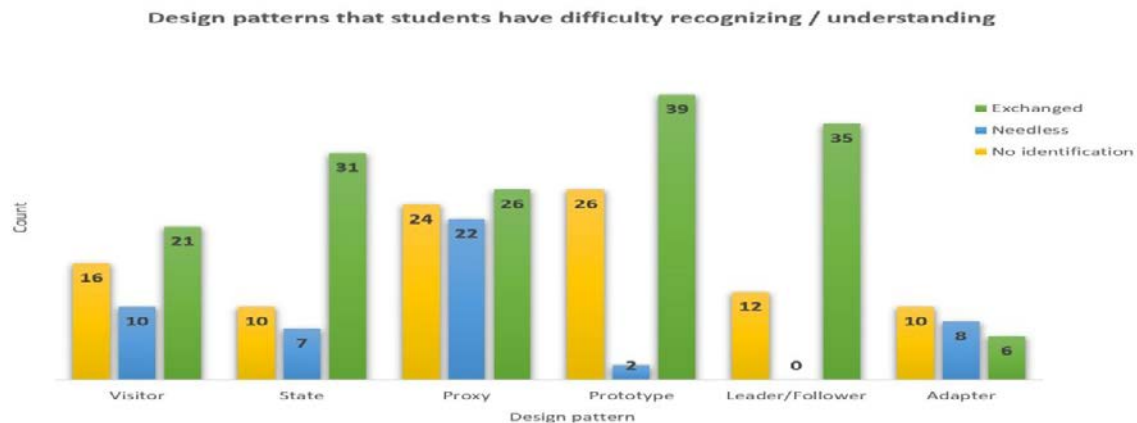

Figure 1: The graph shows the errors students made with the six design patterns (DPs). *Exchanged* means the DP was needed but another DP was wrongly used; *Needless* means that this DP was wrongly used; *No identification* means this DP was needed, but no DP was used.

The other five DPs were all highly exchanged for other DPs when needed. This implies that students have a harder time trying to comprehend the other DPs and fail to grasp their meaning and purpose. We find the high exchange rate extremely interesting, especially in regard to the Prototype DP. To better understand its origin, we further investigate several of the DP exchanges. Detailed results and discussion appear below.

The additional finding that appears in Figure 1 is the needless use of DPs (i.e., the DP was wrongly used where it was not needed). It seems that Leader/Follower and Prototype were the least used needlessly. This means that while students may find it hard to recognize when these DPs are needed, they at least understand the purpose of these DPs enough to know when not to use them. This finding is consistent with the fact that these DPs are used to solve problems of a narrow scope (i.e., in very unique situations).

Finally, Prototype and Proxy DPs were the most unrecognized when needed (“No identification” in Figure 1). This finding is interesting, since Proxy is a highly used DP with a wide variety of uses. On the other hand, Prototype is tailored for use in a narrow range of situations. Yet, we see that they were both ignored. We believe this is a result of two factors. Proxy is a complex DP to understand due to its high variety. Hence, students tend to overlook it. The Prototype DP was ignored because students tend to neglect creational DPs and rarely use more than one, if at all, in any system. This is due to their misconception that creating new things in the system only happens once.

## Q2: What common replacements can we detect among the DPs?

For thorough analysis of replacements made, we chose three DPs: Prototype and State DPs, due to the results of the previous analysis; and Visitor DP, due to known results in the literature.

The State DP was mostly replaced by the Factory Method (32% of all replacements) and Proxy (23%) DPs. The error of exchanging the State DP with the Factory Method DP is due to the students’ inability to correctly separate the object’s behavior from its identity. Hence, students fail to understand that the same object may exhibit different behaviors; they think that different objects must be built to have different behaviors.

The error of exchanging State DP with Proxy DP also points to students’ inability to comprehend object behavior. They think a different object needs to exist and control the original object’s behavior for us to exhibit different behavior for the same object. In both cases, we see that the error is rooted in students’ misconceptions regarding the object’s behavior.

The Prototype DP was mostly replaced by the Builder DP (54%). The students’ explanations reveal that when they noticed the phrase “complex structure” they immediately assumed it was the Builder DP, despite the fact that the wording did not specify a constructing process. Students appear to generalize all the problems that arise from the complex construction of an object and categorize them under the Builder DP.

The Visitor DP was replaced by many different DPs from a large variety, but mostly by Delegator and Decorator DPs (22% each). The large variety indicates that students find this DP much harder to understand. This result is supported by previous results (Lartigue & Chapman, 2018). Yet, it seems that the increased use of Delegator and Decorator DPs is due to the fact that, like Visitor DP, they too use other specialized systems as sub-systems that execute part of their task. Hence, students were confused by the similar structure of the DPs and failed to grasp the differences between them.

### Q3: How many of the wrongly exchanged DPs were the right type and how many were not?

Exchanging the needed DP with the wrong one is always an error. Sometimes students exchange the DP with a DP of the same type, and sometimes with a DP of a completely different type. Table 1 shows what percentage of the exchange errors were with DPs of the same type (IN) and how many were not (OUT).

Table 1: The percentage of errors made inside vs. outside the same type.

	Adapter (%)	Prototype (%)	L/F (%)	Proxy (%)	State (%)	Visitor (%)	All (%)
IN	50	79	74	19	23	14	45
OUT	50	21	26	81	77	86	55

If we ignore the Adapter results due to their redundant size, it appears that students have a good grasp of the creational and concurrency types. Even when they chose the wrong DP, they still understood the logic of the problem enough to understand what type of DP would be able to solve it. However, we found the reverse when looking at the structural and behavioral types. It seems students fail to understand the uniqueness of those types and need a thorough explanation of each type's role and specific use.

## 4 Recommendations for educators

Given the error analysis and our experience teaching DPs, we propose to transform the teaching method by adding a second stage to the process. In the first stage, the students learn DPs by following one of the common methods (see Introduction). The second stage will consist of several sessions that emphasize the following contents.

1. Students tend to mistakenly use other DPs of a type that is not behavioral, instead of using DPs that are behavioral (see analysis of State DP's replacements). Hence, educators need to highlight the idea of the object's behaviors and make sure students understand the separation between the object's identity and its implementation. After teaching students DP types and their fundamental differences, educators should show several examples to help students differentiate the use of each type and have a better, separate cognitive model of each DP type.
2. Students sometimes use creational DPs needlessly. However, when a process of creation is needed, they have no difficulties in identifying it (as can be seen in Table 1 - Prototype). Yet, they have difficulties identifying which DP is needed (Prototype DP's replacement analysis). Hence, educators need to help students better differentiate the different processes of creation and the motivation for and use of each process. This will help students recognize and understand the different needs that led to the creation of different creational DPs. We recommend that educators present the various attributes of each creating process to help students understand and fine-tune features needed for each of the different processes. Using recurring student errors will help students understand which features are important and which should be neglected because they are not relevant.
3. In light of our results and the literature, it is clear that a few DPs are more complex, and students find those ones especially hard to comprehend. To help with this, educators can use examples from students' day-to-day life they can relate to. The examples will help students create a clear model of

those DPs. For example, use online paying platforms as an example of the need for Visitor DPs, or use character building in online games as an example for Bridge DP. Using examples from different environments enhances students' understanding and is a viable educational tool that can be used throughout their engineering studies.

## 5 Conclusions and future work

DPs are important tools for software engineering. However, current teaching approaches do not help students grasp the small differences between the DPs or understand the underlying meaning of each DP. Hence, novices and student software engineers rarely master these tools until they gain extensive experience in the field. To the best of our knowledge, no research has been conducted on teaching novices based on their errors when learning DPs, and no comprehensive research has been done on students' errors in DPs.

This research emerged from the need to transform the current teaching approach. We analyzed students' errors and the sources of those errors, which gave us a deeper understanding of the reasons why students have difficulties in identifying the right use of DPs. This analysis led us to the understanding that there is a need to add a second stage in teaching. This stage will highlight and enhance knowledge about the fine-tuned details and differences between the DPs.

In continuing this work, we would like to follow our own recommendations, check their effectiveness, and further develop a full, new teaching approach that will assist students in learning DPs based on recurring errors. We believe that this will result in easier and better knowledge transfer to the students and help them master the use of DPs more quickly.

## 6 References

- Berdun, L., Amandi, A., & Campo, M. (2014). An intelligent tutor for teaching software design patterns. *Computer Applications in Engineering Education*, 22(4), 583–592.
- da Cruz Silva, D. S., Schots, M., & Duboc, L. (2019). Fostering design patterns education: An exemplar inspired in the Angry Birds game franchise. In *Proceedings of the XVIII Brazilian Symposium on Software Quality* (pp. 168–177).
- Fojtik, R. (2014). Design patterns in the teaching of programming. *Procedia – Social and Behavioral Sciences*, 143, 352–357.
- Gamma, E., Helm, R., Johnson, R., & Vlissides, J. (1994). *Design patterns: Elements of reusable object-oriented software*. Addison-Wesley Professional.
- Jeremic, Z., Jovanovic, J., & Gasevic, D. (2011). An environment for project-based collaborative learning of software design patterns. *International Journal of Engineering Education*, 27(1), 41.
- Karre, S. A., Sanagavarapu, L. M., & Reddy, Y. R. (2021, February). Using project-based approach to teach design patterns: An experience report. In *14th Innovations in Software Engineering Conference (formerly known as India Software Engineering Conference)* (pp. 1–5).
- Lartigue, J. W., & Chapman, R. (2018). Comprehension and application of design patterns by novice software engineers: An empirical study of undergraduate software engineering and computer science students. In *Proceedings of the ACMSE 2018 Conference* (pp. 1–10).
- Reischmann, T., & Kuchen, H. (2018). An interactive learning environment for software engineering design patterns. In *Proceedings of the 18th Koli Calling International Conference on Computing Education Research* (pp. 1–2).
- Zhang, J. (2021). Teaching design and implementation of design mode in the course of Java programming in higher vocational colleges. *Journal of Physics: Conference Series*, 1856(1), 012039.





## Student Learning

# Work-in-Progress: Project-based learning and culturally-responsive pedagogy: An approach to foster self-efficacy and inclusivity in Undergraduate Engineering Education

Bonolo Mokoka

University of Pretoria, South Africa, [bonolo.mokoka@up.ac.za](mailto:bonolo.mokoka@up.ac.za)

Lelanie Smith

University of Pretoria, South Africa, [lelanie.smith@up.ac.za](mailto:lelanie.smith@up.ac.za)

Karin Wolff

University of Stellenbosch, South Africa, [wolffk@sun.ac.za](mailto:wolffk@sun.ac.za)

Lykke Brogaard Bertel

Aalborg University, Denmark, [lykke@plan.aau.dk](mailto:lykke@plan.aau.dk)

## Summary

South African universities are shifting towards project-based learning teaching and learning approaches which combine theory and practice, such as service learning (SL) and work-integrated learning (WIL). Project-based Learning (PBL) is an effective teaching method that motivates students from diverse backgrounds to persist in learning, and engage in projects that are culturally relevant, build community, and enable them to apply their learning in a real-world context. Although recognized as effective teaching methods to develop life-long learning skills and competences, it is unclear how and to what extent PBL, SL and WIL support diverse learning needs and styles of engineering students. The Enneagram will be introduced as a lens to help design culturally-responsive PBL activities that are tailored to meet these diverse learning needs, while also understanding their intrinsic motivation. Research illustrates that self-efficacy in students is based on teachers'/facilitators' implementation level of culturally-responsive teaching and learning, therefore combining PBL and culturally-responsive pedagogy can foster self-efficacy and inclusivity. skills, which can foster self-efficacy and inclusivity. This paper explores how combining PBL and culturally-responsive pedagogy can potentially redefine the student-facilitator relationship, by creating a positive, supportive and inclusive learning environment that can contribute to undergraduate engineering students' sense of self-efficacy.

**Keywords:** project-based learning, culturally-responsive pedagogy, inclusivity, engineering education

**Type of contribution:** Research extended abstracts

## 1. Introduction

Project-based Learning (PBL) is a teaching method in which students learn by actively engaging in real-world and personally meaningful projects. PBL is an active learning philosophy which can provide engineering students with a deep understanding of their impact, as well as allow them to practise fundamental skills that are essential to the engineering profession (Du et al., 2009). In engineering education, PBL is conducted in

different ways through service learning (SL) and work-Integrated learning (WIL). SL is a pedagogical approach which combines learning objectives with community partner needs through active engagements (Bringle et al., 2006). Additionally, WIL is an educational approach that integrates academic learning of a specific discipline with practical application where students are able to participate in activities as they learn (Winberg et al., 2011). In the engineering education context, SL and WIL are effective strategies to challenge engineering students by placing them in complex situations that encourage them to engage with the learning process through a community service experience. This paper explores the following research question: *How do we create a culturally-sensitive/culturally-responsive/inclusive curriculum to engage and meet diverse students' needs?*

## 2. PBL, SL & WIL

In literature, definitions of project-based learning (PBL), service learning (SL) and work-integrated learning (WIL) overlap. SL and WIL are specialised PBL pedagogical approaches known to develop skills, and boost engagement and retention. SL and WIL can be regarded closely-related PBL teaching methods, because of their ability to focus on authenticity and meaningful work for communities, aligning curriculum content and skills, reflection, and collaboration and cooperation.

### 2.1 Project-Based Learning

Project-based learning is a student-centred pedagogy in which students are actively involved in the learning process with the intention of developing knowledge and skills through engaging real-life problems (Kokotsaki et al., 2016). PBL has the ability to remove barriers to learning because of its collaborative and cooperative nature, and teamwork approach.

### 2.2 Service Learning

Service Learning is considered to be a course-based, credit-bearing educational experience in which students participate in an organized service activity that meets identified community needs. It includes reflecting on the service activity in such a way as to gain further understanding of course content, a broader appreciation of the discipline, and an enhanced sense of personal values and social responsibility (Bringle et al., 2006). Service learning aims to connect student learning in the classroom with real-world experiences in the community.

### 2.3 Work-Integrated Learning

Work-integrated learning (WIL) is a means of addressing concerns around student development and graduate attributes. There has been interest in fostering university learning that is less didactic and more situated, participative, and “real world” oriented (Winberg et al., 2011). The objective of WIL is to combine academic learning of a specific field of study, with the practice of work through a specific programme.

### 2.4 Self-efficacy and the Enneagram

Using PBL as an educational approach enables students to independently construct their own knowledge, and reflect upon their learning experience, resulting in increased motivation and self-efficacy (Shin, 2018). PBL allows for iterative cycles of practice and reflection that can support engineering students to discover and understand their intrinsic motivation and the role it plays in the overall success. PBL provides opportunities for independence, understanding, social responsibility and makes the learning experience relevant for students, therefore making it an effective tool for fostering intrinsic motivation (Cakiroglu, 2017).

While not widely considered as a scientifically-validated approach to personality assessment, the Enneagram is a useful tool to understand personal growth and self-awareness (Powers, 2017). Introducing the Enneagram as a lens through which to explore intrinsic motivation, we will aim to define and understand

what fosters self-efficacy, inclusivity, social responsibility, leadership and cultural competence in engineering students. Individuals with high self-efficacy beliefs are more inclined to intrinsically motivated (Bandura, 1997). Although there is limited research on the connection between self-efficacy and the Enneagram, both these concepts are relevant to intrinsic motivation and personal development. Self-efficacy refers to a person's belief in their own abilities and competencies to complete tasks and achieve goals (Bandura & Wessels, 1994). The Enneagram is an emotionally-focused system of personality which describes people in terms of nine types, each with their own motivations, fears, and internal dynamics (Sutton, 2012).

One's Enneagram type may have an impact on their sense of self-efficacy in particular situations. According to Hurst (1992) the Enneagram can potentially help to explore the interplay between attitude, behaviour, action, defences and motivations. This can be an appropriate tool to determine diverse students' various learning needs and styles. Furthermore, understanding motivational styles through the Enneagram can help facilitators see how well students are understanding fundamental concepts of fulfilling learning objectives, completing tasks, working independently and collaboratively. This also creates an opportunity for the classroom to be less teacher-driven and more student-centred, and helps students develop metacognitive and lifelong learning skills to prepare them for new challenges personally, academically, and professionally.

### 3. Inclusivity through PBL

According to Deepwell and Malik (2008) universities need to develop suitable teaching and learning models and strategies that address the learning needs and expectations of all their students. Learners come in many forms, therefore differentiated instruction can engage different types of learners. Providing instruction that supports individual learning needs also encourages them towards becoming more independent (Gentry et al., 2013). Combining PBL with culturally-responsive pedagogy can be specifically effective, as it allows students to connect their learning to the world around them, while also providing opportunities to see themselves and their cultural experiences reflected in the curriculum. This can help students build their cultural competence, develop a sense of belonging, and become more engaged and motivated learners.

Cultural inclusion addresses and recognises the needs of people of diverse cultures, and values their unique contributions. Therefore, understanding the learning styles of diverse students provides more information about their specific preferences, thus making it easier to develop new and inclusive educational models and curricula, or modify existing ones (İlçin et al., 2018). Using the Enneagram as a lens through PBL can be an effective tool to design culturally-responsive pedagogy, in order to create learning experiences that are engaging, meaningful, and inclusive for all students.

In the educational context, culture and motivation are linked. Culture and motivation influence the way students interact with the world, learn, work, and communicate (Chen, 2005). The Enneagram enables one to become culturally competent in understanding that people lead with different core values, and are responsive to different motivational styles. Introducing the Enneagram as a lens through which to explore intrinsic motivation, we will aim to define and understand what stimulates self-regulation, social responsibility, leadership and cultural competence in engineering students. Research illustrates that PBL approaches such as SL and WIL help students develop non-technical attributes such as self-regulation, leadership, social responsibility, and cultural competence (Azlin & Ruhaya, 2018; Shin, 2018; Mohamed, 2021). Ultimately, PBL can foster inclusivity by providing opportunities for diverse students to engage in their learning, while also removing barriers to learning due to its equitable, collaborative and inclusive approach.

### 4. Context of Study

In the Faculty of Engineering, Built Environment and Information Technology at the University of Pretoria, a service learning module called Joint Community Projects (JCP) is compulsory for all second-year students.

Students are divided into transdisciplinary teams, 18 Departments from Engineering, Built Environment and Information Technology, working with community partners/stakeholders (NGOs, health and educational professionals) towards solving or contributing to the upliftment of that community. JCP intends for the student to develop, through reflection, understanding of their own experience in a team-based workspace as well as a broader understanding of the application of their discipline knowledge and its potential impact in their communities.

## 5. Methodology

As of 2021, each 2nd year cohort has completed the Chestnut Paes Micro Test - “Two questions away from discovering your Enneagram type” - a self-assessment to determine their leading Enneagram style. This study will focus on the 2023 cohort (1600+), all of whom will similarly complete the test. A quantitative diversity profile will be conducted on the cohort to enable the identification of a purposive sample of students to include in semi-structured one-on-one interviews and interactive focus groups. All interviews and discussions will be recorded and transcribed in accordance with ethical research guidelines. The qualitative data will be analysed through thematic analysis (partially informed by the Enneagram motivational styles), sorted and categorised into preliminary codes to identify the most salient patterns and themes. A number of analytical mapping tools are currently being investigated through which to better understand, describe, explore and potentially improve culturally-responsive PBL activity systems.

## 6. Status, Challenges and Future Work

As part of the ongoing review and improvement of an existing service learning module as well as a PhD study, this research can make a significant contribution to understanding and problematising the concept of inclusive pedagogy that takes cultural-responsiveness into account. The challenges are finding a coherent and clear definition of what each of the active, situated and participative modalities mean in implementation and practice.

## 7. REFERENCES

- Bandura, A. & Wessels, S. (1994). *Self-efficacy*. na.
- Bringle, R.G., Hatcher, J.A. & McIntosh, R.E. 2006. Analyzing Morton's typology of service paradigms and integrity. *Michigan Journal of Community Service Learning*, 13(1), 5-15.
- Cakiroglu, E., Cakiroglu, J., & Ercan, O. (2017). Project-based learning and self-efficacy: Impact on pre-service teachers. *Educational Research and Reviews*, 12(17), 737-744.
- Chen, S. X., Cheung, F. M., Bond, M. H., Leung, J. P., & Mak, W. W. (2005). The role of culture in the motivational process. *Journal of Applied Psychology*, 90(5), 952–969.
- Deepwell, F. & Malik, S. (2008). On campus, but out of class: an investigation into students' experiences of learning technologies in their self-directed study. *ALT J*, 16(1), 5-14.
- Du, X., de Graaff, E. & Kolmos, A. (2009). *Research on PBL practice in engineering education*. BRILL.
- Gentry, R., Sallie, A.P. & Sanders, C.A. (2013). *Differentiated Instructional Strategies to Accommodate Students with Varying Needs and Learning Styles*. [Place of publication not identified]: Distributed by ERIC Clearinghouse. [Online] Available from: <https://eric.ed.gov/?id=ED545458>.

- İlçin, N., Tomruk, M., Yeşilyaprak, S.S., Karadibak, D. & Savcı, S. 2018. The relationship between learning styles and academic performance in TURKISH physiotherapy students. *BMC Medical Education*, 18(1):1-8. [Online] Available from: <http://dx.doi.org/10.1186/s12909-018-1400-2>.
- Kokotsaki, D., Menzies, V. & Wiggins, A. 2016. Project-based learning: A review of the literature. *Improving Schools*, 19(3):267-277.
- Shin, M.-H. 2018. Effects of Project-Based Learning on Students' Motivation and Self-Efficacy. *English Teaching*, 73(1):95-114.
- Sutton, A. 2012. But is it real? A review of research on enneagram. *Enneagram Journal*, 5.
- Winberg, C., Engel-Hills, P., Garraway, J. & Jacobs, C. 2011. Work-integrated learning: Good practice guide– HE Monitor No. 12: Council on Higher Education (CHE).

# Work-In-Progress: Examining Engineering Students' Perception of Student Agency in Solving Complex Engineering Problem

Faris Tarlochan

Technology Innovation and Engineering Education, *College of Engineering, Qatar University, Qatar*, [faris.tarlochan@qu.edu.qa](mailto:faris.tarlochan@qu.edu.qa)  
*Department of Mechanical and Industrial Engineering, College of Engineering, Qatar University, Qatar.*

Wadha Khalid Labda

Technology Innovation and Engineering Education, *College of Engineering, Qatar University, Qatar*, [wadha.lebda@qu.edu.qa](mailto:wadha.lebda@qu.edu.qa)

Khalid Kamal A A Naji

*Department of Civil and Architectural Engineering, College of Engineering, Qatar University, Qatar*, [knaji@qu.edu.qa](mailto:knaji@qu.edu.qa)

Xiangyun Du

UNESCO PBL Centre, Aalborg University, Denmark, [xiangyun@plan.aau.dk](mailto:xiangyun@plan.aau.dk)

## Summary

The general source of engineering education knowledge is content driven where engineering is considered as a process of solving problems using a reductionist approach. Once each sub-system is solved, within certain assumptions and hypotheses, they are brought back together to provide an overview of the potential solution for the problem. It promotes mechanistic thinking to solve well-structured problems with known solution paths (process) and convergent answers. Little emphasis is given to solving complex engineering problems. One approach to cultivating solving complex engineering problems is through learners/ student agency. Student agency is based on the guiding principle that students have the ability and will to influence their own lives and the world around them. The aim of this is then to investigate the role of Problem-Based Learning (PBL) as an environment setting to encourage students' agency in solving complex engineering problems. The work will incorporate existing theories in relation to students' agency.

**Keywords:** Student agency; problem-based learning, engineering education; complex engineering problem; problem-solving

**Type of contribution:** Research extended abstracts.

## 1 Introduction

Engineering is one of the oldest professions and is responsible for the rise of civilizations. Through engineering applications and innovations, societies have experience waves of innovations, from mechanization to steam power, and from electricity to digital networks. The current question being asked is: *what will be the next wave of innovations/challenges and how would 21<sup>st</sup> century engineering education transform to address these challenges?* This is a common question asked by several stakeholders, from students to engineering educators and from employers to policymakers. This was highlighted and echoed heavily by the National Academy of Engineering (2004). Several stakeholders have tried to answer this call through providing resources, improving courses, and developing innovative teaching pedagogies, Graham (2018), Johri & Olds (2014). However, looking at most engineering programs, such profound innovations in engineering education, are not obvious, and many engineering programs are still within the *classical engineering education* framework (Frei & Serugendo 2011; Kolmos et al. 2016; Zilbovicius et al. 2020).

The history of engineering education can be traced back to 1702 with the establishment of school of mining and metallurgy in Freiberg, Germany (UNESCO 2010). In France, the need for engineering education helped

the development of *Ecole Nationale des Ponts et Chaussees* (1747) (UNESCO 2010). However, after the French Revolution, Napoleon influenced the development of formal schooling in engineering focusing on theoretical and military fundamentals (UNESCO 2010). This influenced the formation of other engineering schools across Europe with a focus on science and mathematics. In Britain, engineering education was primarily based on an apprenticeship in the early years of the Industrial Revolution. Due to fear of lagging behind European counterparts, the British adopted *engineering science and mathematics* in its engineering education framework (UNESCO 2010). By the end of the nineteenth century, these countries in Europe had established engineering education systems based on the French and German ‘Humboldtian’ model (holistic combination of research and studies) (UNESCO 2010). Unfortunately, this model was one of the contributing factors to the decline in engineering interest. This led to educators' increase interest in the problem and activity-based learning. Documented details on engineering education can be traced back to 1893 when the Society for the Promotion of Engineering Education launched the Journal of Engineering Education.

Today, in most universities, classical engineering is the evolution from the Humboldtian model with an emphasis on engineering design to bridge ties between universities and industries (Froyd et al. 2012). The general source of scholarly knowledge is textbook-driven (content-driven), where engineering is considered as a process to solve problems using a reductionist approach (Frei & Serugendo 2011). In the reductionist approach, an engineering problem is broken up into its simplest forms (sub-system, components, etc.) where each one is treated separately. Once each is solved, within certain assumptions and hypotheses, they are brought back together to provide an overview of the potential solution for the problem (Frei & Serugendo 2011). It promotes mechanistic thinking to solve *well-structured problems* with known solution paths (process) and convergent answers (Sigahi & Sznelwar 2022). Little emphasis is given to solving complex engineering problems.

Real world problems solved by engineers are never simple. Examples of such problems can be found in the National Academy of Engineering Grand Challenges (NAE 2017). Real-world problems are ill-defined, unpredictable, possess conflicting goals, consists of engineering and non-engineering constraints, multidisciplinary and possess many facets to define the problem (Sigahi & Sznelwar 2022). According to ABET 2018, “*Complex engineering problems include one or more of the following characteristics: involving wide-ranging or conflicting technical issues, having no obvious solution, addressing problems not encompassed by current standards and codes, involving diverse groups of stakeholders, including many component parts or sub-problems, involving multiple disciplines, or having significant consequences in a range of contexts*”. This is total contrast with classical engineering education, which often neglects broader social, environmental, and economy issues. There is an urgent need to develop our engineering students to solve complex engineering problems. We require future engineers today.

One approach to cultivating solving of complex engineering problems is through learners/ student agency. Student agency is based on the guiding principle that students have the ability and will to influence their own lives and the world around them (Jääskelä et al. 2017; OECD 2019). Universities are heavily engaged on teaching theoretical and formal knowledge (content-based knowledge construction), but do not address the need to prepare students for professional work and complex world (Jääskelä et al. 2017). In this context, student agency is important in learning situations to offer students the possibility to participate and influence solutions (Jääskelä et al. 2017; Du et al. 2022). Student agency is a complex and dynamic system that includes the sense of agency, agentic behavior, and interaction with the environment (Du et al. 2022). In addition to this, the concept of co-agency should be emphasized. Co-agency implies relations with others such as instructors, parents, peers, etc. developing an effective learning environment (OECD 2019). The aim of this ongoing work, through a complexity theory lens (Du et al. 2022), is to conceptualize student agency in solving complex engineering problems within a Problem-Based Learning (PBL) environment.



## 2 Research Design

The research has two parts to it. The initial part was an exploratory research, conducted in Spring 2022 based on questionnaires developed in-house, whereas the second part will be conducted in Spring 2023 as an extension to the first part. The initial part of the study had the aim of understanding which ways students perceive their learner agency in a PBL setting. The focus is on two basic dimensions of student agency namely active participation (Lipponen & Kumpulainen 2011) and team dynamics (Edwards 2005). The questions developed for each dimension are listed in Table 1. The questionnaire used a Likert-Scale from 1 – 5, 1 being *Never* and 5 being *Always*. During this time, the delivery mode was online due to Covid-19. The course was at the sophomore level in the mechanical engineering program with the title *Introduction to Design*. This course is offered once every academic year in Spring. The course instructor had implemented PBL in this course for previous offerings. In this PBL teamwork-setting environment, an ill-structured project (complex problem) given at the beginning of the semester where students were required to use the project to organize the learning process. Each team comprised between 4-5 students. Most students in this course will have no prior PBL experience. This course typically sees around 50 students on each offering. In running the project, the Sun Model of co-agency will be adopted (OECD 2019). This model depicts eight levels of different degrees of co-agency. *Level 0* (lowest) is where the students and the instructors believe that students cannot contribute, and all initiatives and decisions will be taken by the instructor. *Level 8* (highest) is where the students initiate a project, and the decision-making is shared between the student and instructor. Since the class is at a sophomore level and due to internal academic policies, for this class a *Level 6* is adopted. The *Level 6* is where students are part of the decision-making process of a project, however the project definition and initiation is by the course instructor.

Table 1: Initial Dimensions in student agency.

Dimensions	Questions
Active Participation	<ul style="list-style-type: none"> <li>• I actively participate in the assignment of roles for the team members</li> <li>• I clearly express my ideas</li> <li>• I don't feel intimidated to make mistakes working on the team</li> </ul>
Team dynamics	<ul style="list-style-type: none"> <li>• I can ask members of my team for help with my task</li> <li>• I am are open to discuss ideas</li> <li>• I feel comfortable discussing difficult issues in the team</li> <li>• I support other team members with the accomplishment of their tasks</li> </ul>

After the initial study done in Spring 2022, more literature on student agency was researched to better define student agency. The literature on student agency is very discipline specific (Jääskelä et al. 2017). After much research, based on the work of (Jääskelä et al. 2017), the following domains of agency was identified for the second part of the study: (1) Individual, (2) Relation and (3) Contextual. In the *Individual* resource domain, the underlining concepts are meaning-oriented studying, self-efficacy, competence, belief and participation activity. For the *Relation* resource domain, the key concepts are equality among students, reciprocal relation between instructor and learner, peers as resource for learning and emotional atmosphere. Finally, for the *Contextual* domain, the underlining concepts are participatory pedagogy, opportunity to influence and opportunity to make choices. Here student agency deals with subjective thinking, goal oriented, autonomous and characteristics such as beliefs, feelings, thoughts and learning behavior. The second part of this study will be conducted in Spring 2023 for the same course setting. The research question being investigated here is the students' experiences and sense of agency for engaging in knowledge construction through the complex problem scenario within a PBL environment. In terms of assessing student agency in a more detail manner, validated questions (Jääskelä et al.2017), will be given to students. These questions are centered on

the three resource domains described earlier (Individual resources – 19 items, Relational resource – 18 items and Contextual resource – 17 items). The questions were developed by using a 5-point Likert scale. Ten factors emerged from the study reported in (Jääskelä et al. 2017). These factors are: (a) interest and motivation, (b) self-efficacy, (c) competence belief, (d) participation activity, (e) equal treatment, (f) teacher support, (g) peer support, (h) trust, (i) opportunities to influence and (j) opportunities to make choices. Besides this, students will be interviewed randomly to allow for a mixed research approach. The interviews will help to gain better understanding of the quantitative data obtained from the questionnaire. This study will be administered in class to the students during the last week of the Spring 2023 semester. There are around 50 students registered for this course. The students have 30 minutes to fill the survey, where a pen and paper format will be adopted for the administration of this questionnaire. Students will fill the questionnaire anonymously. This will be followed by selecting randomly 20% of the students for the interview session, where each interview session will not take more than 15 minutes per student. We will use established statistical analysis such as exploratory factor (EPA), reliability test and descriptive statistics to analyze the data and to draw conclusions.

### 3 Preliminary Results

The initial phase of this study in Spring 2022 showed that students had some elements of student agency when working in together in solving complex design problem. The students felt confident in active participation and using peers as support. However, not much could be said about knowledge creation from this survey. It goes to show that PBL team-settings supports student agency to a certain extent, but further domains of student agency need to be explored. Table 2 shows the average response for each on this question (qualitatively). The second part of this study will commence in Spring 2023.

Table 2: Results from the exploratory research conducted in Spring 2022.

<b>Dimension</b>	<b>Questions</b>	<b>Average Response</b>
1	I can ask members of my team for help with my task	Frequently
2	I actively participate in the assignment of roles for the team members	Always
3	I clearly express my ideas	Frequently
4	I am open to discuss ideas	Always
5	I feel comfortable discussing difficult issues in the team	Always
6	I support other team members with the accomplishment of their tasks	Always
7	I don't feel intimidated to make mistakes working on the team	Frequently

### 4 Conclusion

This study is a work in progress in nature. The study is to be completed by end of Spring 2023 through a more comprehensive mixed research approach. The overall research aim of this study is to investigate the sense of agency in constructing knowledge through solving complex engineering design problems. The initial phase of the study (exploratory) looked at how PBL settings supports student agency. The results showed that students are comfortable in working in to solve the engineering problem assigned to them. However, these findings do not display sufficient information on the sense of creating knowledge in a complex problem scenario. Other dimensions of agency such as self-efficacy (effort to take up challenge), competency beliefs (understanding of course content), opportunity to influence (own studying), to name a few are required to obtain a full picture on the student self-agency in knowledge creation.

## 5 References

- ABET (2018) <https://www.abet.org/accreditation/accreditation-criteria/criteria-for-accrediting-engineering-programs-2018-2019/#4>
- Bruce E. Seely. Patterns in the History of Engineering Education Reform: A Brief Essay. *Educating the Engineer of 2020: Adapting Engineering Education to the New Century*.
- Du, X., Lundberg, A., Ayari, M. A., Naji, K. K., & Hawari, A. (2022). Examining engineering students' perceptions of learner agency enactment in problem- and project-based learning using Q methodology. *Journal of Engineering Education*, 111( 1), 111– 136.
- Edwards, A. (2005). Relational Agency: Learning To Be a Resourceful Practitioner. *International Journal of Educational Research* 43 (3): 168-82.
- Frei, R., & Serugendo, G. D. M. (2011). Advances in complexity engineering. *International Journal of Bio-Inspired Computation*, 3(4), 199–212. <https://doi.org/10.1504/IJBIC.2011.041144>
- Froyd, J. E. , P. C. Wankat and K. A. Smith (2012). Five Major Shifts in 100 Years of Engineering Education. *Proceedings of the IEEE*, vol. 100, no. Special Centennial Issue, pp. 1344-1360.
- Graham, R. (2018). *The global state of the art in engineering education*. MIT Press.
- Johri, A., & Olds, B. M. (2014). *Cambridge handbook of engineering education research*. Cambridge University Press.
- Kolmos, A., Hadgraft, R. G., & Holgaard, J. E. (2016). Response strategies for curriculum change in engineering. *International Journal of Technology and Design Education*, 26(3), 391–411.
- Lipponen, L. and K. Kumpulainen (2011). Acting as Accountable Authors: Creating Interactional Spaces for Agency Work in Teacher Education. *Teaching and Teacher Education* 27 (5): 812-19.
- National Academy of Engineering—NAE. (2004). *The engineer of 2020: Visions of engineering in the new century*. The National Academies Press. <https://doi.org/10.17226/10999>
- National Academy of Engineering—NAE. (2017). *NAE grand challenges for engineering*. The National Academies Press.
- OECD (2019). *Conceptual Learning Framework: Student Agency for 2030*. OECD Future of Education and Skills 2030 Concept Note © OECD 2019. <https://www.oecd.org/education/2030-project/>
- Jääskelä, P., Poikkeus, A. M., Vasalampi, K., Valleala, U. M., & Rasku-Puttonen, H. (2017). Assessing agency of university students: validation of the AUS Scale. *Studies in Higher Education*, 42(11), 2061-2079.
- Sigahi, T. F. A. C., & Szelwar, L. I. (2022). Exploring applications of complexity theory in engineering education research: A systematic literature review. *Journal of Engineering Education*, 111(1), 232–260.
- UNESCO Report *Engineering: Issues, Challenges and Opportunities for Development* (2010). United Nations Educational, Scientific and Cultural Organization.
- Zilbovicius, M., Piqueira, J. R. C., & Szelwar, L. (2020). Complexity engineering: New ideas for engineering design and engineering education. *Annals of the Brazilian Academy of Sciences*, 92(3).

# Discussions on how Self-directed Learning is a by-product of Problem-based Learning through the conception of “Divide and Conquer”

Thitiwat Piyatamrong

Centre for Engineering Education, UCL, United Kingdom, [thitiwat.piyatamrong.19@ucl.ac.uk](mailto:thitiwat.piyatamrong.19@ucl.ac.uk)

Gouri Vinod

Centre for Engineering Education, UCL, United Kingdom, [gouri.vinod.20@ucl.ac.uk](mailto:gouri.vinod.20@ucl.ac.uk)

Yiwen Xu

Centre for Engineering Education, UCL, United Kingdom, [yiwen.xu.22@ucl.ac.uk](mailto:yiwen.xu.22@ucl.ac.uk)

Yifan Xie

Centre for Engineering Education, UCL, United Kingdom, [yifan.xie.22@ucl.ac.uk](mailto:yifan.xie.22@ucl.ac.uk)

Abel Nyamapfene

Centre for Engineering Education, UCL, United Kingdom, [a.nyamapfene@ucl.ac.uk](mailto:a.nyamapfene@ucl.ac.uk)

## Abstract

This extended abstract offers a new perspective on the value of problem/project-based learning (PBL) through students' experiences, using autoethnography as a methodological framework. The findings suggest that PBL tasks promote self-directed learning, a critical skill that is essential for students' growth and development. As students engage in PBL tasks, they tend to adopt problem-solving approaches that can be likened to the "divide and conquer" algorithmic approach in computing. In this approach, students break down complex PBL objectives into smaller, more manageable sub-mini projects, conquer each task, and integrate them to achieve their learning objectives. Our work contributes to the notion that "divide and conquer" learning strategy is an integral element of self-directed learning in PBL, helping students to develop critical thinking, problem-solving, and decision-making skills. Overall, this study highlights the significance of self-directed project-based learning and its potential to foster and prepare students for the demands of contributing to a larger problem/project-based learning.

**Keywords:** Self-directed Learning, Problem-based Learning, Divide and Conquer, Learning Capstones

**Type of contribution:** Research extended abstract

## 1. Introduction

Problem/project-based learning (PBL) is often seen by engineering educators and students as a collaborative approach to problem-solving. This collaboration typically involves discussions between educators and students on the ways to approach a given problem, as well as the implementation of suggested strategies. However, even when participating in collaborative learning tasks during PBL, students also engage in individual self-directed learning. This paper will examine the role of self-directed learning as a foundation for completing PBL assignments. The authors argue that this self-directed learning can be seen as individualized mini-projects consisting of "divide and conquer" learning capstones from the students' perspectives. For the purpose of this study, we adopt Hiemesta's conceptualization of self-directed learning as "any study form in

which individuals have primary responsibility for planning, implementing, and even evaluating the effort," (Hiemesta, 1994).

In our study, we observed that students carrying out PBL assignments often engage in a range of individual project-style learning tasks, ultimately leading to the solution of the assigned problem. To highlight how students approach these individual self-directed learning tasks to solve the overall problem, we will introduce the algorithmic term "divide and conquer" to define students' various learning capstones. The capstones are integrated into what the students ultimately achieve while solving a problem-based learning problem. This paper will use autoethnography from the authors who have completed undergraduate engineering programs to analyze how students divide assigned PBL tasks into multiple self-directed projects with the objective of successfully conquering the given problem. This study is a form of collaborative autoethnography, where students share their reflections with each other in a safe, supportive environment. While most PBL projects have a reflective component, this practice is normally an individual student exercise. This study demonstrates that the project reflective component could be considerably enhanced by transforming it into a collaborative group exercise where good practice is identified, shared, and reinforced through discussion, whilst troublesome aspects are queried and collaboratively researched and analyzed, which, in turn, contributes to deeper learning within the group.

Overall, our research sheds light on the importance of self-directed learning as a foundation for PBL and the crucial role it plays in student success. By breaking down complex PBL tasks into smaller self-directed projects, students can develop their critical thinking, problem-solving, and decision-making skills. This approach enables students to take responsibility for their own learning, work at their own pace, and take ownership of their projects. Ultimately, the "divide and conquer" approach to self-directed learning can enhance students' motivation, engagement, and confidence in their ability to solve complex problems.

## 2. Review of problem-based learning in self-directed learning skills

Malan and Ndlovu (2014) explored the impact of problem-based learning (PBL) on developing students' self-directed learning skills in a foundation program. Their findings revealed that a project-based learning framework designed by educators positively impacted students' learning patterns. In particular, their results showed a shift towards meaning-directed and application-directed learning patterns, indicating a reduction in undirected learning patterns. Introducing students to a PBL approach with reduced undirected learning patterns led to more meaningful learning patterns, characterized by critically processing the subject matter and self-regulating learning processes. In contrast, César Baluarte-Araya (2022) studied the impact of PBL from the perspective of engineering students and evaluated its influence on developing technical, methodological, participatory, and personal competencies. Their findings revealed that PBL has a moderate to high impact on the development of personal competencies. PBL helps students to discover knowledge for themselves, analyze, synthesize, and evaluate problems to develop self-directed learning skills.

These studies demonstrate the potential of PBL in developing students' self-directed learning skills. Malan and Ndlovu's (2014) study focuses on curriculum design and demonstrates the impact of PBL on learning patterns, while César Baluarte-Araya's (2022) research focuses on the evaluation of the learning outcomes of PBL from the perspective of students. Together, these studies provide a foundation for further research on the relationship between PBL and self-directed learning. This extended abstract seeks to provide another perspective on the relationship between PBL and self-directed learning. We argue that self-directed learning is integral to PBL, and our study explores students' perspectives on approaching PBL as self-directed project-style learning. As students take on their PBL objectives, they view the problem as a project consisting of various capstone objectives that need to be self-directed. We will discuss this perspective in further detail in the discussion section of this extended abstract.

## 3. Research Design

This paper adopts autoethnography as a qualitative methodological framework to reflect on and discuss the experiences of three of the co-authors in understanding the learning approach taken in their problem-based learning dilemma. Autoethnography is defined as a method of research that describes and systematically analyses personal experience to understand cultural experience (Ellis, 2004; Holman Jones, 2005). Ellis et al. (2014) situate autoethnography as a research method where researchers retrospectively and selectively write about epiphanies that stem from being part of a culture or cultural identity. This paper adopts this qualitative approach to retrospectively and selectively write about the experiences reflecting on problem-based learning and analyze how self-directed project-style learning is a foundational element of problem-based learning.

In this autoethnographic study, three recently graduated engineering students conducted individual reflections on their undergraduate PBL experiences. They then shared their reflections with the rest of the study team in a focus-group-style setting that included an engineering academic and a postgraduate teaching assistant. Transcripts from this focus group were then independently analyzed and coded. The findings revealed a trend in the same direction, despite the different circumstances relating to the various stages of undergraduate engineering studies.

#### 4. Discussion

This extended abstract uses the "divide and conquer" approach from computer science's algorithm design to illustrate how the authors, as engineering students, utilized self-directed project-style learning to solve an engineering learning problem. Smith (1985) presents parallel implementation as one reason why a programmer may structure their algorithm this way, aligning with the authors' perception of how engineering students approach a larger problem. This paper will analyze key quotes from the authors' reflections to demonstrate how they followed a similar approach to solve a larger problem during their undergraduate engineering programs. Despite varying methods for creating subproblems, all authors used the "divide and conquer" approach to solve specific projects or problems. The authors' experiences highlight how the "divide and conquer" approach is an effective strategy for self-directed project-style learning and problem-based learning, as shown by their ability to conquer subproblems independently and integrate them into the overall solution.

Author 1 (Discipline: Electrical Engineering)

Context prior to situating a "Divide and Conquer" self-directed project-style learning on the PBL:

- The author studied abroad in Singapore for their second year with minimal research experience and was required to solve a problem in a lab using machine learning (ML), a new concept to the author.

*"He (the supervisor in Singapore) asked us to tell him how neural networks could be applied to our project. At this point, I realized that my understanding of machine learning (ML) was not going to be sufficient enough to complete our project within the allotted period."*

Author 1, without prior knowledge of machine learning or extensive experience in programming, realized that they were given a general problem to solve without a straightforward approach.

*"I tried to watch videos to learn more about ML when I had the time, but I still felt that my knowledge was not built on the same strong, foundational understanding that some of the other students. .... I felt embarrassed for having to ask my peers novice questions when I was about the project when I was supposed to be an equal contributor to our work. .... Before I had self-taught myself, I often did not understand what others were talking about.... This learning improved my ability to finish the project as it allowed me to work better with my teammates and ask valuable questions about improvements we could make whilst still maintaining the specialist scope of advanced ML,"*

The author recognizes that they had to divide the more significant problem by asking for extra help from the professor and creating a self-directed course on ML by watching tutorial videos online. The author was able to successfully “divide and conquer” and solve the overall engineering problem by first completing the learning capstones they had divided and given to themselves.

Author 2 (Discipline: Electronic Information Engineering)

Context prior to situating a “Divide and Conquer” self-directed project-style learning on the PBL:

- The author has finished the four-year undergraduate program on a campus that put significant focus on STEM and was required to complete an individual project in an unfamiliar field: Energy efficiency.

*“I was asked to complete an individual project. ‘Efficiency of Low carbon Energy,’ and I needed to decide the specific subjects to investigate.... After deciding to operate data analysis with comparison of different business quantitative analysis modules, .... Therefore, I basically had to learn everything about the project on my own,”*

Similar to Author 1, Author 2, who had had four years of training as an electrical engineer, was assigned to a new study field using a technique that was foreign to the author. Consequently, the author faced the challenge of completely starting from the beginning and learning everything independently.

*“... I began the project by searching a lot of papers in this field and tried to identify those modules step by step. What are the principles, why are they better choices than other methods, and how can I integrate them into my project? .... I read all the software handbooks and watched several tutorial videos on YouTube to figure out how those things work .... It took me eight months to finish the project. Throughout this time, I had to learn on my own in almost every area of my project,”*

After realizing the learning situations, the author realized that these unfamiliar modules might be mastered by breaking them up into several portions, which handbook reviews and online videos can tackle. By splitting the whole study into smaller chunks, the author exemplified how the “Divide and Conquer” strategy can be perceived in self-directed learning and favourably influence future approaches to research.

Author 3 (Discipline: Network Engineering)

Context prior to situating a “Divide and Conquer” self-directed project-style learning on the PBL:

- The author needed to code a hospital registration system in the third year of undergraduate study.

*“... I tried to program directly using what I had learned from school, but it didn’t work. It was like I could make pieces but couldn’t put them into a complete puzzle. .... I decided to work in three steps: understanding, designing, and programming. I analyzed the programming languages and software used in many hospital registration systems, understood the logical links between various functions, and went to hospitals to learn more about the registration process and users’ requirements. I integrated and analyzed this information to complete the design of my system. Then, I used online resources to learn new programming languages and techniques, searched for open-source code, and posted to find out how to fix bugs through programmer forums,”*

Author 3, without guidelines and lengthy experience in programming, tried to solve the problem directly. After failing, the author recognized that learning new knowledge and finding new ways to complete the project is required. The author divided the big problem into several steps, learned the skills needed at each stage through self-directed learning, such as online resources and forums, and completed the big project.

## 5. Concluding Remarks and Reflection

In these discussions, each author reflected on their experiences, which led to two common themes. The first theme is that although each author was tasked with a problem under PBL lessons, all of them approached the situation as a project-based learning approach, utilizing the "divide and conquer" strategy to situate their self-directed learning projects. The second theme that emerged from these discussions is that self-directed learning was a by-product of all the situations experienced by each author. Self-directed learning was thoroughly practiced, persevered, and learned, thus supporting the connection between PBL/PjBL (Problem and Project Based Learning), and the practice of self-directed learning. These themes illustrate how the "divide and conquer" approach is a useful strategy for engineering students when tackling complex problems under PBL or PjBL. Additionally, these themes show how the practice of self-directed learning is an essential element of both PBL and PjBL, which can lead to more meaningful and impactful learning outcomes. By examining these experiences, this paper contributes to the ongoing discussion on the effectiveness of PBL and PjBL and the role of self-directed learning in these approaches.

*"It's like I've created a self-directed learning cycle by dividing a big problem ... I didn't even notice I was engaging in self-directed learning. I just focused on completing each step," – Author 3.*

The authors' shared reflection reveals that the "divide and conquer" approach fosters self-directed learning and that this form of learning often extends beyond the completion of the PBL activity. In addition, whilst studies on PBL/PjBL have primarily focused on team-working in PBL/PjBL, limited attention has been paid to the individual learning tasks within PBL/PjBL. This work suggests that researchers and educators should also pay equal attention to the individualized self-directed learning taking place within PBL/PjBL. Notably, this self-directed, individual project-style learning phase is characterized by high levels of stress and uncertainty, and educators need to develop strategies to make this phase of learning more student-friendly. Overall, this paper contributes to the ongoing discussion on the effectiveness of PBL and PjBL, the role of self-directed learning in these approaches, and the importance of individual learning tasks within PBL.

## References

- Baluarte-Araya, C., & Bedregal-Alpaca, N. (2022). Influence of problem-based learning on the development of technical, methodological, participatory, and personal competencies. *Valuation by engineering students. 2022 IEEE World Engineering Education Conference (EDUNINE), 1–6.*
- Ellis, C. (2004). *The ethnographic I: A methodological novel about autoethnography. Walnut Creek, CA: AltaMira Press.*
- Hiemstra, R. (1994). Self-Directed Learning. IACE Hall of Fame Repository.
- Holman Jones, Stacy (2005). Autoethnography: Making the personal political. *In Handbook of qualitative research, ed.*
- Malan, S. B., Ndlovu, M., & Engelbrecht, P. (2014). Introducing problem-based learning (PBL) into a Foundation Programme to develop self-directed learning skills. *South African Journal of Education, 34(1), 1–16.*
- Smith, D.R. (1985). The design of divide and conquer algorithms. *Science of Computer Programming, 5, 37–58.*



# Work-In-Progress: Using research-focused PBL to support computer engineering students' learning engagement in a systemic PBL environment

Yan Zhao

Department of Computer Science, Aalborg University, Denmark, [yanz@cs.aau.dk](mailto:yanz@cs.aau.dk)

Xiangyun Du

Department of Planning, Aalborg University, Denmark, [xiangyun@plan.aau.dk](mailto:xiangyun@plan.aau.dk)

## Summary

Problem-Based Learning (PBL) anchors learning to special problems and enables effective teaching. The systemic PBL model which has been implemented at Aalborg university provides students with the opportunity to solve problems of a given field in a team. In this work, by applying the experience of research-based learning to PBL teaching, we explore PBL and propose a research-focused PBL framework, which integrates three focuses: research-focused project through research proposal design, enhancing student's learning engagement through research, and co-creation of mutual learning with the project supervisor. The framework was piloted through a one-semester long project with initial feedback from students collected through a survey. The preliminary results demonstrated their positive reaction to the pilot and willingness to engage to further similar practices. Practical implications are provided based on the initial results.

**Keywords:** effective teaching, senior students' enthusiasm, research integration, problem-based learning

**Type of contribution:** Best practice extended abstracts

## 1 Introduction

Problem-Based Learning (PBL), defined as “an instructional learner-centred approach that empowers learners to conduct research, integrate theory and practice, and apply knowledge and skills to develop a viable solution to a defined problem” (Savery, 2015), is one of the latest innovations in active learning for which a wide range of positive outcomes for students are claimed. Such an innovation facilitates deep learning through better understanding of concepts and the development of skills, as well as fostering student engagement and enthusing classes (Du et al., 2019). In PBL, students tend to use a more in-depth approach of learning and understand the meaning of materials being studied, which increases deep learning and decreases surface learning for students especially in practical courses (Du et al., 2019), e.g., computer science and software engineering. In PBL, the teaching goal is to create an interesting environment that is conducive to active, engaged learning study and allows for supervised exploration. The most important learning occurs in situations that are both meaningful and practical, and student-centred teaching promotes purposeful and continuous learning.

In such an environment, the exchange of ideas between teachers and students can collide with some valuable and creative ideas. In addition to playing the role of knowledge disseminator, teachers also play other roles like discipline enforcers, students' friends, and team leaders. University students have a variety of personality characteristics and particularities. They are not as profound as their teachers in terms of specific professional

knowledge and knowledge, but they also have their own ideas and dignity. When teachers get along with students, they must respect the personality and individuality of students and learn with students modestly. It is also an important role for teachers to understand who the students (i.e., learners) are, what knowledge and experience they have, and what they want to achieve, so that they can customize the teaching activities meeting students' needs. Accordingly, in a PBL environment, teacher-student relationships play a key role in the teacher-student experience and have been found to be related to learning. Teacher-student communication is an educational process where teachers influence students purposefully according to a predetermined direction (Savery, 2015). When teachers have an influence on students, students will inevitably influence teachers. The field of literature on PBL in engineering education has reported PBL's effectiveness regarding students' improvement of deep approach to learning (Du et al., 2019), learning engagement (Naji et al., 2020), diverse professional competencies such as problem solving and teamwork (Du et al., 2020). Nevertheless, most of the current literature were embedded in PBL implementation at a course level, while the PBL implementation at a curriculum level is little practiced and researched.

Aalborg University (AAU) has been over decades practiced a systemic PBL approach, namely the AAU PBL model, integrating a problem-based and a project-organized teamwork approaches (Kolmos et al., 2004). Within the systemic PBL model, students' learning process is guided by problems as a start of the learning, and students work together in team to solve the problem through a process organized in a format of project, within a timeline of the whole semester (five months) which accounts for half of their semester credits. Within the AAU PBL model, the problems can be developed in various ways ranging from discipline knowledge focused and well-structured problems to ill-defined real-life problems from industry (Kolmos, 2017). While students develop their engagement to learning at different levels depending on the ways PBL is implemented (Naji et al., 2020), there is a need for more research on impact of diverse practices on student engagement within a systemic PBL approach like AAU PBL model. To address such a need, this paper reports a pilot study of designing and implementing a research-focused approach to PBL involving students to work on research in the field as the 'problem' of their team-based project work.

## 2 Concepts and design of the study

The objective of PBL includes two sub-problems: 1) how to improve on the learning experience for junior students; and 2) how to improve on the learning experience for senior students. Student bias related to age, with younger students preferring younger supervisors and older students preferring older supervisors (Sprinkle, 2008). Compared with junior students that have a sense of freshness and passion for university environment and the knowledge they learn, senior students are no longer interested in them and may just study for exams. Besides, senior students are faced with different pressures, e.g., academics, employment, and self-development. These pressures suppress the students, causing them to lose interest in studies. If the pressures cannot be transformed into positive motivation, it affects senior students' ability to judge and learn. More seriously, it affects the personal development of senior students. Therefore, it is difficult and necessary to motivate senior students. To tackle this issue, this study was guided by the research question: In which ways engineering students may develop learning engagement in a research-focused PBL setting?

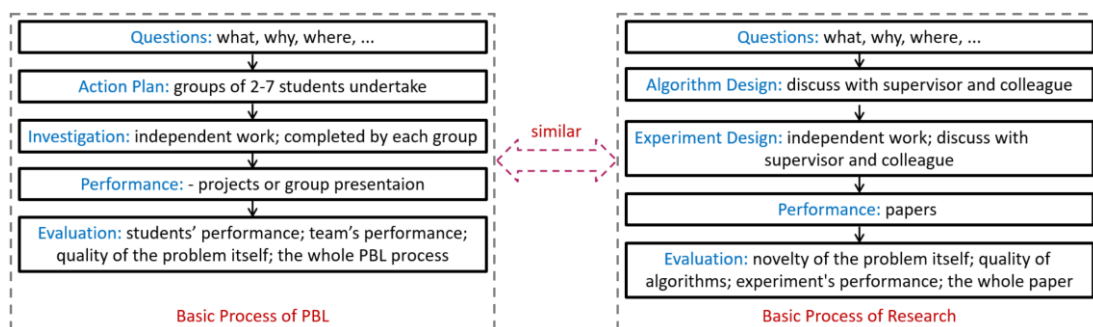

Figure 1: PBL vs. Doing Research

**The study assumes that involving senior students to conduct research work as the supervisors do in their academic work. Figure 1 illustrates a connection between a PBL approach to a typical research process.** PBL includes raising questions, making action plans and investigation by students, and finally evaluating the performance of students, teams, the proposed problem, and the whole PBL process. The process is similar with that of research-based learning, which also includes raising questions, designing algorithms, conducting experiments, writing papers, and evaluating the novelty of the problem, the quality of algorithms, the experimental performance, and the whole paper. To enhance supervisor-student relation and motivate students' engagement, the study designed a pilot initiative of involving students to work on ongoing academic research as their semester project work. The remaining of the study reports the design, process of implementation as a pilot, and initial evaluation of student feedback.

### 3 Methodology and implementation

In this section, a framework for research-focused PBL is proposed with three dimensions: research-focused project through research proposal design, enhancing student's learning engagement through research, and co-creation of mutual learning with the project supervisor.

#### 3.1 Research-focused project through research proposal design

**Research-focused proposal.** A proposal is a document creating a plan for a designed project, and a solid proposal acts as a source of truth for students, where supervisors can provide advice and integrate their research and PBL. The most suitable advice means that the supervisor can assist students with what needs to be done. Therefore, a good proposal should clearly focus on the semester topic and explain the problem. However, it is also important to be clear that proposals do not have to exist purely for the benefit of students. It needs to contribute to the work and development of the supervisor. To achieve this, a good solution is to integrate the research of supervisors and PBL into proposals. Besides, a good proposal should meet PBL objectives, e.g., improving the self-directed learning and problem solving of students. A well-written research-focused proposal allows the supervisor to demonstrate the value provided and show that the supervisor is the right person for the project.

**Practice.** The first author of the study, who served as the project supervisor of students proposed an initial design of research topics. To integrate research, objectives of PBL, and the project of DAT5 students as well as to achieve the semester goal/topic (i.e., Experimental Data Analysis and Modelling or Theory-Driven Data Analysis and Modelling), the first author proposed two proposals, i.e., Effective and Efficient Task Assignment in Spatial Crowdsourcing and Unsupervised Time Series Anomaly Detection. These two proposals are based on the research fields of the first author, where the first author has published several papers. Students in group DAT-05-03 selected the first proposal and defined a novel problem, namely Heart Runner AI, in spatial crowdsourcing. They explore and develop a new method combining reinforcement learning and genetic evolutionary, achieving the PBL objectives and inspiring the first author to find new problems and solutions.

#### 3.2 Enhancing student's learning engagement through research

**Students' research awareness.** Students' research awareness also plays a crucial role in research-teaching integration. Claims that teaching is research-led are not credible if students have negative or no idea about the university as a research environment (Brew, 2020). Research on the student perspectives shows the extent to which students see themselves as part of the research community. Geography students, for example, feel that research is most visible 'in the field' and is done by lecturers and students. However, physics majors indicate that research is visible in the presence of laboratories and machinery, which is believed to be done by lecturers 'over there' (Brew, 2020). There is evidence showing that many of a university's initiatives in research-led teaching are initially teacher-centred. An interesting aspect of development is the constant awareness that the concept of research-led teaching is not well defined and requires evolving understanding.

**Practice.** A good way to enhance students' awareness of research in their project is to encourage students to present their project and results in public (e.g., uploading reports and codes to GitHub), which is beneficial for them to broadcast the project results. During the supervision for group DAT-05-03, the first author suggests students to submit their report and codes to GitHub and stresses the necessity, e.g., it is helpful to pursue higher education and find a satisfied job. The students show great interest about it, which enhances their awareness of research to a certain extent.

### 3.3 Co-creation of mutual learning with the project supervisor

**Co-creation of mutual learning.** Working on a student's project is a period of inspiration and learning, but it can also be chronic stress and concern about unfinished reports. The primary task of the supervisor is to help students work through the project and understand what has been learned from the relevant courses. Rather than offering support and advice, supervisors should encourage students to actively organize information. By doing so, supervisors can also learn more about what happens during supervision and how to encourage mutual learning. It is necessary to learn from students, creating an environment where supervisors understand that they do not have a wealth of knowledge in every field. Harnessing the wisdom of students not only helps supervisors grow but often inspires students to learn further and share their expertise.

**Practice.** When supervising DAT-05-03 students, they explore a new problem, Heart Runner AI, which is a three-party task assignment problem including workers (i.e., runners), tasks (i.e., patients), and defibrillators. Besides, they explore the combination between reinforcement learning and genetic evolutionary. While the supervisor has broad knowledge in spatial crowdsourcing, the supervisor admits that the knowledge about these techniques is limited. The supervisor often asks students to share their knowledge and expertise, or to help the supervisor when getting stuck. They build relationships that enable them to learn from each other.

## 4 Data for piloting

In the 2022 fall semester, the first author conducted student evaluations in the DAT5-03 supervision. Six students returned the questionnaire, where the questions are shown below.

Table 1: The questionnaire and its statistical results, where Q denotes Question.

Q1. Do you prefer a research-related proposal or a course-related proposal?	Q9. Do you think it enhances your interest of research by a research-related project?
Q2. How much benefit by a research-related proposal?	Q10. Which way do you think is the best to present and broadcast the project results?
Q3. What do you think of a research-related proposal?	Q11. Do you think it is helpful for knowledge sharing among group member by a research-related project?
Q4. Do you think it is helpful if the project is related to the research field of your supervisor?	Q12. Do you feel better if the teachers/supervisors can give you feedback on time?
Q5. Do you think a research-related project is helpful for finding a job in industry?	Q13. Do you feel better if the teachers/supervisors share related publications to you?
Q6. Do you think a research-related project is helpful for pursuing higher education?	Q14. Which way do you prefer to find a suitable solution to your problem in the project?
Q7. Do you feel stressful when conducting a research-related project?	Q15. Do you believe your project/report can help the supervisors to improve or inspire their research?
Q8. Do you think it enhances your awareness of research by a research-related project?	

## 5 Analysis and initial results

Based on the questionnaire results, the following analysis can be summarized:

1) *Evaluation for research-focused project through research proposal design (Q1-Q3).* Most students (66.67%) prefer a research-based proposal. 50% of the students think they can benefit a lot from a research-based proposal, which is a good way for learning knowledge.

2) *Evaluation for enhancing student's learning engagement through research (Q4-Q10)*. All students believe it is helpful if the project is related to the research field of the supervisor, and 83.33% believe that a research-based project can help them for pursuing higher education. As expected, only 33.33% of the students think a research-related project is useful for finding a job in industry. Most students (83.33%) feel stress-free to conduct a research-based project, which means that it is easy for them to deal with it. Half of the students think a research-based project enhances their awareness of research, and 83.33% claim that such a project enhances their research interest, which demonstrates the superiority of a research-based project. In terms of the way to present and broadcast project results, 66.67% of the students tend to use a project report and share their codes by GitHub. It shows that they promote the dissemination of research results actively.

3) *Evaluation for co-creation of mutual learning with the project supervisor (Q11-Q15)*. A majority (66.67%) of the students believe it is helpful for knowledge sharing among group members by a research-based project. All students feel better if supervisors give feedback on time, which means that the feedbacks from supervisors are helpful and valuable. 83.33% of them hope that supervisors could share related publications to them, from which they can explore the solution by themselves. 66.67% of the students believe that their project/report can improve or inspire the research of supervisors.

## 6 Reflection and future work

In AAU, the pedagogical learning goal is to develop teaching skills to engage students in teaching process (Kolmos, 2017). In this work, a new problem aiming to integrate research and teaching for improving the enthusiasm of senior students on learning is proposed. To solve it, a theoretical analysis and an empirical study are given. The results show that the proposed methodology can integrate research and teaching, thus enhancing the enthusiasm and interest of senior students on learning to maximize the teaching and supervising effect (Kolmos et al., 2004). The paper reports the initial results of the piloting approach using research-focused PBL to support student learning engagement. The approach shall be further revised, and more data are needed in the future including both qualitative and quantitative sources to provide a comprehensive understanding of students' learning. Based on the preliminary results, it can be suggested that future design of such an approach shall focus on some research-driven practical applications that benefit students for finding a job in industry and enhance their awareness of research more effectively.

## References

- Brew, A. (2010). Imperatives and challenges in integrating teaching and research. *Higher Education Research & Development*, 29(2), 139-150.
- Du, X., Ebead, U., Sabah, S., Ma, J., & Naji, K. K. (2019). Engineering students' approaches to learning and views on collaboration: How do both evolve in a PBL environment and what are their contributing and constraining factors? *EURASIA Journal of Mathematics, Science and Technology Education*. 15(11), 1-15.
- Du, X. Y., Naji, K. K., Sabah, S., & Ebead, U. (2020). Engineering students' group-based strategy use, forms of collaboration and perceptions of assessment in team projects—a case study in Qatar. *International Journal of Engineering Education*. 36(1), 296-308.
- Kolmos, A., Fink, F. K., and Krogh, L. (2004). The Aalborg model-problem-based and project-organized learning. *The Aalborg PBL Model-progress, Diversity and Challenges*, 9-18.
- Kolmos, A. (2017). PBL Curriculum Strategies: From Course Based PBL to a Systemic PBL Approach. *PBL in Engineering Education*, 1-12.
- Naji, K. K., Ebead, U., Al-Ali, A. K., & Du, X. (2020). Comparing models of problem and project-based learning (PBL) courses and student engagement in civil engineering in Qatar. *EURASIA Journal of Mathematics, Science and Technology Education*. 16(8), 1-16.
- Savery, J. R. (2015). Overview of problem-based learning: Definitions and distinctions. *Essential readings in problem-based learning: Exploring and extending the legacy of Howard S. Barrows*, 9(2), 5-15.
- Sprinkle, J. E. (2008). Student perceptions of effectiveness: An examination of the influence of student biases. *College Student Journal*, 42(2), 276-294.

# Kumaraguru Project Based Learning (KPBL) Framework: The Futuristic Pedagogy for Gen Z Learners

Dr.M.Ezhilarasi

Associate Dean – Academics, Kumaraguru College of Technology, Coimbatore, India, [ezhilarasi.m.eie@kct.ac.in](mailto:ezhilarasi.m.eie@kct.ac.in)

Dr.S.G.Mohanraj

Assistant Professor, Kumaraguru College of Technology, Coimbatore, India, [mohanraj.sg.sci@kct.ac.in](mailto:mohanraj.sg.sci@kct.ac.in)

## Summary

Kumaraguru Project Based Learning (KPBL) Model attempts to solve the challenges faced by higher education institutions by providing an enhanced teaching methodology that would cater to the needs of the current generation of learners. This model is feasible to be scaled up and implemented in higher education institutions across India and other parts of the globe without altering the existing curricula defined by the individual institution. KPBL is a combination of Problem Based Learning (PrBL) and Project Based Learning (PBL), and it provides the right blend of learning ecosystem to the learners. In this model, learning of courses offered under curricula happens through design-oriented problem guided approach, and beyond the curricula, the learners work on projects to provide technology solutions to existing real-world problems. It is evident that the learners engage themselves in active learning and learn new technologies that are required for their respective projects, which is obviously beyond their regular learning. This model also ensures deep learning of scientific and technological concepts thereby enabling the learners to apply the same in their professional life.

**Keywords:** *Problem and Project Based Learning, Innovative Pedagogy, Teaching-Learning Model*

## 1 PBL in India: An Overview

The dire need for an effective pedagogy to engage the current generation of learners has become the greatest challenge in recent days (Boss & Krauss, 2022). Educational institutions all around the world have started hunting for new teaching-learning methodologies to cater to their requirements. Problem and Project Based Learning are regarded as one of the successful pedagogies (Boss & Krauss, 2022; Shinde & Inamdar, 2013). National Education Policy (NEP 2020) of Government of India and All India Council for Technical Education (AICTE) have included Problem and Project Based Learning as effective pedagogies in their policy documents, but the statistical reports state that only 15 institutions in India (i.e., 0.02% of existing higher education institutions) are trying with the new pedagogical approaches like PBL with less intensity. To name a few, KLE University in Karnataka is offering Project Based Learning as one course in the first year of engineering, JK Lakshmi Patil University has adopted the Olin College PBL model, and Vishwaniketan College of Engineering is following Aalborg University, Denmark, model of Project Based Learning. These models either demand less student strength or require complete modification of the existing curriculum. Also, young learners find it difficult to transform from the rote learning experience that they underwent in school to Problem Based Learning which demands self-learning, discussions, extensive exploration, and creative thinking (Allen et al, 2011; Shinde & Inamdar, 2013). In this setting, Kumaraguru Project Based Learning (KPBL) Model attempts

to solve these challenges. This serves as the best-proven pedagogy to enhance student learning, especially in India where the student-teacher ratio (25:1) is low.

## 2 Kumaraguru Project Based Learning (KPBL) Framework

KPBL Framework attempts to provide experiential learning aligned with real-world problems to the students pursuing higher education. This serves as a unique model from other existing types by serving as a nexus of Project and Problem Based learning. KPBL comprises two categories of learners for Project Based Learning (PBL). The first category is the advanced learners who volunteer themselves to carry out projects. Around 25% of the total strength show their willingness for this mode and around 5% of students are given an opportunity to take up this mode. The applicants undergo a selection process in the form of an aptitude test and a personal interview. These students take up projects with industry standards during their first year of the engineering program onwards. The second category comprises average and slow learners. These students take up a lighter version of the project-making exercise. These learners are oriented on the nuances of project making and are given demonstrations on how to make projects. Subsequently, they are provided with project ideas and also handheld to complete their projects. For both these categories of learners, their regular curriculum is covered through Problem Based Learning (PrBL) in the form of design integrated problem-guided approach.

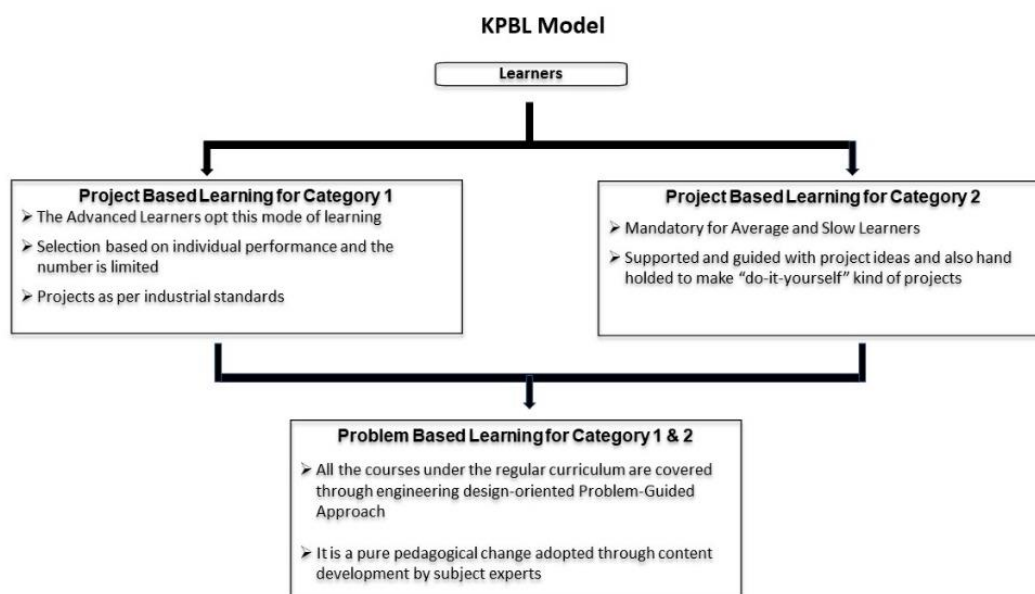

Figure 1: Kumaraguru Project Based Learning Model

This model was started as an experiment in the year 2021 for a smaller group of undergraduate engineering students (58 students - Category 1) who got inspired and opted to learn through this mode. Table 1 demonstrates the total number of learners who opted to learn through this mode through various cohorts.

Table 1: Cohortwise Student Details for Category 1

Cohort Number	Cohort I	Cohort II	Cohort III	Cohort IV
<b>Number of Learners</b>	58	97	75	140

Now, the model has been scaled up to the next level, where an entire lot of the freshers (around 1350 first-year students pursuing B.E. / B.Tech Programmes) are taking up their learning through this mode (inclusive of categories 1 & 2). Advanced learners from category 1 strive to solve highly complex societal problems and the learners from category 2 are supported with project ideas and carry out “do-it-yourself” kind of projects. Problem Based Learning is given uniformly to all the students covering the entire curriculum; however, the intensity of learning differs from one group to the other depending upon their knowledge level. The innovative aspect of KPBL Framework is that this model gives phenomenal outcomes and can be implemented effectively without making changes in the curriculum since all the topics in the syllabus are covered with the pedagogy of Problem Based Learning (Problem-Guided Approach), and it is possible for almost all the courses in all the disciplines (Kolmos et al, 2019).

Adopting both Problem and Project Based Learning together yields better outcomes. Both these strategies go hand-in-hand and supplement each other extensively. Dealing with real-world problems serves as a key for both these approaches. PrBL focuses more on the fundamental engineering and scientific concepts related to the topics in the syllabus while solving real-world problems. Solutions for the problem are given mostly as engineering designs validated via simulation to the most possible extent. This helps learners to explore the possible solutions for their projects and also equips them with the ability to apply basic scientific concepts to their projects. All these learners spend approximately 20 to 25 hours per week on PrBL and the remaining time on their project-making exercise (PBL). The duration of the project is one semester, which is approximately 15 weeks, and this model provides the right blend of learning ecosystems for the learners where they are able to develop their skills.

### 3 Role of Project Based Learning in KPBL

The top-down approach of Project Based Learning hones the learners’ higher-order thinking, applied research skills and collaborative skills (Boss & Krauss, 2022). In this process, they collaborate in smaller teams, identify a problem statement, and deep dive into the same as a team to arrive at plausible solutions under the guidance of mentors. The learners go through a series of training programs on literature survey, design thinking, effective use of modern software tools, etc., to equip themselves with necessary skill sets. A three-tier mentoring system is being followed in this model where each project team is guided by senior students having similar project-making experience, alumni or industry professionals working in the related field, and by faculty members having a similar area of expertise. The mentors steer the learners towards achieving the desired results and make certain that the learners have a deep understanding of the concepts being investigated for their projects.

### 4 Role of Problem Based Learning in KPBL

Problem Based Learning enables the candidates to develop their skills in searching for relevant information, apply the course content to real-world problems and think of possible solutions which are multidisciplinary (Kolmos et al, 2019). It also facilitates the learners to think independently to come up with scientific design solutions to real-world problems. This also enables the learners to use technology in meaningful ways to investigate, collaborate, analyze, synthesize, and present their learning (Allen et al, 2011; De Graaf & Kolmos, 2003). In this process, the subject experts create design-oriented content with the help of industry experts & other faculty members. The instructor handholds the candidates through a closed-ended problem by



providing viable technological solutions and motivates student discussions in small groups. During this practice, all the related engineering and scientific core concepts are explained inclusive of topics from the curriculum and beyond. Subsequently, the learners are provided with similar open-ended problems, and they are asked to work towards providing design solutions, which range from simple mathematical models to complex engineering designs. The assessments are carried out based on the originality of the work, probability of executing the proposed solution, uniqueness of the design, efforts put in by the candidate, and so on.

## 5 Learnings and Outcomes

The outcomes of KPBL model stand evident with the active involvement and performance of the learners. One of the phenomenal outcomes was that 7 second-year students of engineering who were trained through this framework designed an energy-efficient boat without any prior experience of making boats and participated in an international competition titled Monaco Energy Boat Challenge 2022. The team successfully secured the sixth position in the challenge and was able to win the Communication Prize worth 2000 Euros. The learners through this mode have also participated in many national-level competitions and won prizes. The students also enthusiastically engage in project discussions beyond working hours exploring new technologies that are required for their respective projects. The regularity of students in attending the classes and project discussion sessions also indicate their interest in involving in this mode of learning. It is also visible that the learning of the candidates is deep, and this is showcased when they were able to connect with industries and take up entrepreneurship during their early stages of higher education. Table 2 shows the list of outcomes in terms of projects, publications, prototypes and patents.

Table 2: Outcomes from KPBL

No of Projects Completed	No of Prototypes	Number of Research Publications	Number of Patents Filed
83	34	17	01

The comments of the employers / industry reviewers given during the project reviews stand testimony to the fact. Their admiration of how a first-year engineering student can complete a real-time project which even the final-year students would find difficult best showcases the development of skills in the learners. The students learning through this mode have developed websites, CAD Designs and prototypes as a result of their projects. They have also published research articles, book chapters and have filed patents in the very first year of their undergraduate engineering program which is unusual for any learner who undergoes the regular mode of learning. Also, many learners have completed their internships with reputed organizations and have successfully improved their expertise in the field of their choice. Companies have offered internships with a high stipend (\$100 / month) to a few candidates by identifying their potential. This stands evident for the employability skills that the learners have developed through this mode. The prime factor that makes KPBL relevant to the present scenario is that it gets fully aligned to the graduate outcomes defined by National Board of Accreditation (Washington Accord). This model also lines up with the learning style of Generation Z and Generation Alpha, and it equips the learners with 21<sup>st</sup>-century skills, which is the need of the hour.

## 5 References

1. Allen, D. E., Donham, R. S., & Bernhardt, S. A. (2011). Problem-based learning. *New directions for teaching and learning*, 2011(128), 21-29.
2. Boss, S., & Krauss, J. (2022). *Reinventing project-based learning: Your field guide to real-world projects in the digital age*. International Society for Technology in Education.
3. De Graaf, E., & Kolmos, A. (2003). Characteristics of problem-based learning. *International journal of engineering education*, 19(5), 657-662.
4. Kolmos, A., Bøgelund, P., & Spliid, C. M. (2019). Learning and Assessing Problem-Based Learning at Aalborg University: A Case Study. *The Wiley Handbook of Problem-Based Learning*, 437-458.
5. Shinde, V. V., & Inamdar, S. S. (2013). Problem based learning (PBL) for engineering education in India: Need and recommendations. *Wireless personal communications*, 69(3), 1097-1105.

# Considering PBL in Engineering Science from an Epistemological Perspective

Philippe Chang

Universidad Nacional de Colombia Sede Manizales, Colombia, [pchang@unal.edu.co](mailto:pchang@unal.edu.co)

## Summary

Problem based learning (PBL) has been recognized as a valid inductive teaching model that has been implemented successfully on many occasions and appears to offer a number of benefits. Nevertheless, implementation of PBL in engineering science curriculum remains limited and its suitability in such context is still debated. Institutions report that some obstacles appear to hinder its ability to provide holistic skills that can be applied in actual engineering practice. The current study relates the PBL methodology to fundamental epistemology by identifying its attributes and limitations. The demonstration suggests that the adequacy of PBL may be related to how problems are defined and construed and the level of guidance provided. Unlike design problems, ill-defined and undefined problems, like those often encountered in many real-world engineering applications require a degree of investigative and exploratory skills that simply cannot be imparted in conventional PBL. Involving students in research group and outreach projects may be a better way to complement PBL and convey such skills that stem from it.

**Keywords:** Operational knowledge, Propositional knowledge, Structure of scientific knowledge, Undefined problem, Scientific method

**Type of contribution:** Best Practice extended abstracts.

## 1 Introduction

The advantages of PBL relative to traditional educational models have been highlighted in a number of studies and nowadays are not in dispute. Nonetheless, the practice is still far from common in engineering academic programs. In particular, the process of integrating PBL in Engineering Studies at the undergraduate level has had its detractors and there appears to be questions about the validity of such process and obstacles to its implementation across a whole engineering program. On the other hand, some institutions of higher learning have embraced enthusiastically the methodology and described it as a uniquely holistic schooling approach presenting new opportunities to students. The present analysis attempts to explain in what circumstances PBL may be successful in engineering science education by examining the construct of scientific knowledge. Firstly, the general characteristics of PBL will briefly be examined. Subsequently, epistemology as propositional knowledge will be explored, before a clear relationship can be established and analysed. Finally, the consequences of such association will be explained, considering the importance of problem delineation and how it may relate to investigative processes.

## 2 Context of PBL

Within the wide range of other active learning methods that are learner centred, PBL provides for a unique and specifically inductive development model. The benefits of PBL have been widely recognized to be: effective long-term retention of information, higher order cognitive skill development, deeper approach to learning, improved conceptual understanding, student satisfaction, positive effects on reasoning and metacognitive skills and strengthening of problem-solving abilities to name only a few (Strobel & van Barneveld, 2009; Woods, 2012). Hmelo-Silver (2004, p. 1), as related by Vemury et al. (2017) highlights that

“PBL is an instructional method in which students learn through facilitated problem solving. In PBL, student learning centers on a complex problem that does not have a single correct answer.” Furthermore, Vemury et al. (2017) mentions that: “As PBL engages with problems that are open-ended and require students to invest their critical thinking skills, it is an ideal pedagogical strategy for imparting ESD (Steinemann, 2003; Thomas, 2009; UNESCO, 2010).” Such attributes would appear to make PBL a well-adapted teaching model for engineering studies. The implementation of PBL may be related simply to the engineering design process, that proceeds generally according to the following steps: i. Explore the issue: formulate a challenge or a given problem; ii. Define the problem: what is known and its cause; iii. Gather information and develop a plan; iv. Implement the plan and generate possible solutions; and v. Validate and refine proposed solution.

It is believed (Vemury et al., 2017) that the professional skills which students develop as a consequence of PBL will prove invaluable when they enter the workplace (Dobson et al., 2013; HEA, 2014). In engineering science, since design and construction projects have many similarities and are easily adaptable to the PBL model, they are often implemented at the undergraduate level in the form of course projects or as capstone projects to assess acquired skills and program outcomes.

Nonetheless, Mills & Treagust, (2003) emphasizes that “PBL has certain limitations, which make it less suitable as an overall strategy for engineering education (Perrenet, 2000) p. 345)”; and that Feletti (1993) mentions “professional practice is typically not the process of solving well-defined problems (p. 146)”. Hence two elements are problematic:

- i. The constructivist nature of PBL is incompatible with the hierarchical knowledge structure of engineering; topics must be learned in a certain order: “The issue of the particular hierarchical knowledge structure of much of engineering is possibly the most fundamental obstacle for implementation of problem-based engineering [...]” (Mills & Treagust, 2003).
- ii. Problem-solving skills in engineering require the ability to reach a solution using data that is usually incomplete and competing demands, one may have good knowledge of fundamental engineering but be unable to apply it in practice (Mills & Treagust, 2003). Mills & Treagust (2003), concludes that the “PBL approach may be insufficient for the acquisition of professional problem-solving skills in engineering due to the usual time scale of the problems and the range of activities that they include.”

### 3 Basis of Epistemology Science

Epistemology is the branch of philosophy that studies knowledge: its nature, its scope and its foundations. Classical epistemology (see Plato and Kant) identifies at a minimum 3 distinct types of knowledge: familiarity, operational and propositional. Familiarity is not considered relevant here. On the other hand, when examined in terms of engineering skills, operational knowledge can be related to the idea of “applying” knowledge, (e.g. calculating a mean, evaluating the shear stress distribution across a beam, or operating a technical instrument or a lab. bench). It may be interesting to note that operational knowledge and skills have traditionally been conveyed through deductive teaching, but can also be imparted and assessed using PBL. Conversely propositional knowledge is related to contextualization, investigative skills and processes. Propositional knowledge is based on one’s ability to engage in: theoretical construct, hypothetical elaboration, empirical generalization, research design, and deriving sound inference by applying logical deduction or establishing coherent induction. Epistemology associates additionally a fundamental characteristic to propositional knowledge: the construct of scientific knowledge. As such, propositional knowledge requires one to establish, through an empirically process, determinism by evidentiary elements. It cannot be disputed that students who better understand the nature of science, will be better prepared and equipped to distinguish themselves as researchers by strengthening decision making abilities and improved scientific literacy when facing socio-cultural and conflicting problems (McCain, 2016).

McCain (2016) in his book “The Nature of Scientific Knowledge”, highlights why, according to Kampourakis & McCain (2016), familiarity with the methods by which scientific knowledge is generated and the factors

associated with it, are equally if not more relevant than operational knowledge in the development of proficient and capable professionals. According to McCain (2016), it provides the individual with an understanding of the importance of science in contemporary culture, ability to manage technological objects, making informed decisions, and understanding the norms and moral commitments to society (Feng Deng et al., 2011). McCain (2016) further points out that such concept has been communicated by the Central Association of Science and Mathematics Teacher (1907) as a legitimate objective in the academic curriculum and has been defended and encouraged as a critical educational objective as observed in multiple educational reforms in science education (National Research Council, 2012; NGSS Lead State, 2013). The construct of science, as understood by propositional knowledge, progresses according to the common steps associated with the scientific method: i. Observation, ii. Hypothesis, iii. Experimental Model, iv. Analysis and Interpretation of Results and v. Validation.

#### 4 PBL through an Epistemological Perspective

It is often emphasised that, to be effective in implementing PBL, great consideration is required in developing and formulating the problem or project statement. A well-defined problem in PBL usually accounts for: real world applications; open-ended problems; omitting valuable information and/or adding extraneous information; the need for students to justify assumptions; and other economic, ethical or societal components. Notwithstanding those elements, the problem statement will include specific goals, clearly defined solution paths, and expected or foreseeable solutions. The need for a well-defined problem is quite understandable: the path to coherent solutions must be based on developed, acquired or remembered operative skills in accordance with the valued activity outcomes, possibly of the higher order of thinking. The development of solution may also involve strengthening soft skills like: teamwork, time management, communication skills, analysis and critical thinking. If the problem statement is well defined, although it may be open ended, the anticipated solutions will be expected to meet a specific standard, requirement or specifications. In such context PBL may be highly effective as reported and exemplified in engineering design projects, term course problems, project assignments and program capstone projects.

On the other hand, Perrenet et al. (2000, p. 349) indicates that PBL may or may not be useful for engineering education with regard to “the acquisition of knowledge that can be retrieved and used in a professional setting”. The issue here may relate to the nature of engineering knowledge called for and how PBL problems are presented. On this issue Feletti (1993) mentions “professional practice is typically not the process of solving well-defined problems” (p. 146) and Perrenet et al. (2000) also indicates that “Engineers must be able to apply concepts that they learn [...] to solve problems [...] certainly different from any they encountered at university”. Indeed, in engineering practice, professionals are confronted often by ill-defined or undefined problem where specifically propositional knowledge is called for. Symptomatic of this situation is that: “although students are graduating with good knowledge of fundamental engineering [...] they don’t know how to apply that in practice” (Mills & Treagust, 2003). It appears useful to better define, “ill-defined” and “undefined” problems, that are most common in engineering practice and that will confront our future professional. An “ill-defined problem” may be understood as a problem originating from unknown circumstances with contradictory or inconsistent aims, lack social, political, economic and scientific contextualization and may involve unforeseen or unlikely consequences. Additionally, an “undefined problem”, could be understood as a set of events or observations recognisable in time and space that cannot be explained a priori, that may or may not be correlated or hold a causality relationship, and that may or may not require outside intervention given a set of social, economic and cultural variables amongst other considerations. Table 1 summarizes how problem definition relates to assessed knowledge, PBL and its adequacy in solving real world problems.

Table 1: Set PBL Challenge and characteristics as it relates to expected outcomes

Context of the assessed challenge	Traditional PBL Suitability	Type of knowledge called for	Context and adequacy of entertained solutions
Well defined problem	Yes Traditional PBL	Operational with soft skills	<b>Idealized or theoretical setting</b> <ul style="list-style-type: none"> <li>– Common engineering design problem or project</li> <li>– Apply or validate acquired knowledge</li> <li>– Course or term projects</li> <li>– Open ended solutions in accordance with specs.</li> </ul>
Ill-defined problem	Vary according to delivery May be inefficient or inconclusive	Operational with other societal skills	<b>Mimic real world with incomplete contextualization</b> <ul style="list-style-type: none"> <li>– Capstone Projects</li> <li>– Course based graduate degree dissertation</li> <li>– Solution given specific assumptions</li> <li>– Contract work style application</li> </ul>
Open ended question or Undefined problem	Not recommended	Propositional	<b>Common engineering problems</b> <ul style="list-style-type: none"> <li>– Engineering research and investigation</li> <li>– Relate to Master or Doctoral Studies</li> <li>– Acceptable solutions in view of observed data and perceived priorities social, resources, expectations etc.</li> </ul>

The implications here are important: when confronted in the real world by an ill-defined or undefined problem, operational knowledge is insufficient in offering acceptable solutions and fundamental discrepancies begin to appear in the proposed solutions and expected outcomes. At its core, PBL provides operational knowledge; the process by which one remembers or identifies, applies, analyzes, or evaluates data or processes does not amount to the construct of knowledge. Clearly, a PBL trained alumni will not be required to empirically demonstrate the solution he advocates, rather he will rely on accepted knowledge as a basis to substantiate it. PBL confronts students with real world problems within a restricted theoretical known context (available data, current knowledge and taught methods). The student remains mainly focused in identifying or recalling such knowledge and applying it effectively. In the absence of such theoretically known context, one has unescapably to engage beyond problem solving, in investigative processes or experiences that meet the threshold of current accepted knowledge. To adequately examine broader ill-defined or undefined problems requires abilities not of the higher order of thinking but rather of the highest order of thinking. An investigative process based on propositional knowledge develops such abilities where acceptable solutions are offered despite an incomplete set of information and unknowns or unclear relationships. PBL as an inductive educational model does not on its own translate in innovation or the adaptation of solutions. As Marzano et al. (2010) mentions, PBL does not necessarily develop inference although inference is a prerequisite for higher-order thinking.

Hence, an education model in engineering science with an emphasis on exploration, what one may call research-based, is perhaps the correct pathway to better develop capable engineering skills. This would further highlight the need and importance for tutoring and coaching, facilitation and feedback throughout the PBL learning experience that may lead one to eventually acquire propositional knowledge. It may be suggested that this situation has been observed in PBL schooling. Obviously, infrastructure, resources and time constraints may limit the degree of proficiency that may be achieved in such process considering the limited level of support that may be offered.

## 5 Conclusion

This paper explained the relationship between the PBL educational model and the nature of scientific knowledge. It has highlighted the concepts behind PBL as well as the obstacles mentioned by some authors in implementing it on a large scale in engineering science curriculum. Classical epistemology differentiates

between operational and propositional knowledge. It has been argued that the latter embodies the fundamental aspects associated with the construct of knowledge. Problem solving is associated with specific components of operational knowledge, and therefore its success as an education tool will depend on how well the problem statement is presented. It is suggested that when PBL is implemented within the context of a well-defined problem, students can effectively apply or validate their operational skills. Ill-defined or undefined problems require the development of propositional knowledge or abilities that may better relate to professional life since they require insightful contextualization and problem interpretation. Involving students in research group and outreach projects may be a better way to complement PBL and convey such skills that stem from it.

## 6 References

Dobson, A., Hedderman, M. and D’Cruz, B., (2011), Opening the conceptual gateway: a multi-faceted approach to transformational learning in a business school context, *Learning and Teaching in Higher Education*, Vol. 5, pp. 114-130.

Feng Deng, D.C., Tsai, C., & Chai, C.S. (2011). Student’s views of the nature of science: A critical review of research. *Science Education*, 95, 961-999

Feletti, G., (1993). Inquiry based and problem-based learning: How similar are these approaches to nursing and medical education? *Higher Education Research and Development*, 12, 2, 143-156.

HEA (The Higher Education Academy) (2014), “Education for sustainable development: Guidance for UK higher education providers”, available at: [www.heacademy.ac.uk/sites/default/files/resources/education-sustainable-development-guidance-june-14.pdf](http://www.heacademy.ac.uk/sites/default/files/resources/education-sustainable-development-guidance-june-14.pdf).

Hmelo-Silver, C.E. (2004), “Problem-based learning: what and how do students learn?”, *Educational Psychology Review*, Vol. 16 No. 3, pp. 236-266.

Kampourakis, K., & McCain, K. (2016). Belief in or about evolution? *BioScience*, 66, 187-188.

Marzano, R. J., Pickering, D. J. and Heflebower, T., (2011). *The Highly Engaged Classroom: The Classroom Strategies Series (Generating High Levels of Student Attention and Engagement)*, Marzano Research Laboratory

Mills, J.E., Treagust, D.F., (2003). ENGINEERING EDUCATION – IS PROBLEM BASED OR PROJECT-BASED LEARNING THE ANSWER? Curtin University, Perth, Western Australia, Australia, The Australasian Association for Engineering Education [Inchttp://www.aae.com.au/journal/2003/mills\\_treagust03.pdf](http://www.aae.com.au/journal/2003/mills_treagust03.pdf)

McCain, K. (2016). *The Nature of Scientific Knowledge*, Springer Undergraduate Texts in Philosophy, Springer International Publishing Switzerland

NGSS Lead State. (2013). *Next generation science standards: For states, by states*. Washington, DC: The National Academic Press.

Perrenet, J.C., Bouhuijs, P.A.J. & Smits, J.G.M.M., (2000). The suitability of problem-based learning for engineering education: theory and practice. *Teaching in higher education*, 5, 3, 345-358.

Steinemann, A. (2003). Implementing sustainable development through problem-based learning: pedagogy and practice, *Journal of Professional Ethics in Eng. Education and Practice*, Vol. 129 No. 4, pp. 216-224.

Strobel, J. & van Barneveld, A. (2009). When is PBL more effective? A meta-synthesis of meta-analyses comparing PBL to conventional classrooms, *Interdisciplinary Journal of Problem-based Learning*, 3(1),44-58.

Thomas, I. (2009). Critical thinking, transformative learning, sustainable education, and problem-based learning in universities”, *Journal of Transformative Education*, Vol. 7 No. 3, pp. 245-264.

UNESCO (United Nations Educational, Scientific and Cultural Organization) (2010), *Engineering: Issues, Challenges and Opportunities for Development*, United Nations, New York, NY.

Vemury, C.M., Heidrich, O., Thorpe, N. and Crosbie, T. (2017). A holistic approach to delivering sustainable design education in civil engineering, *International Journal of Sustainability in Higher Education*, Vol. 19 No. 1, pp. 197-216. <https://doi.org/10.1108/IJSHE-04-2017-0049-04-2017-0049>

Woods, D. (2012). PBL: An Evaluation of the Effectiveness of Authentic Problem-based Learning (aPBL), *Chemical Engineering Education*, 46, 135-144.



# Transforming First-Year Calculus Teaching for Engineering Students — Field Specific Examples, Problems, and Exams

René Bødker Christensen

Department of Mathematical Sciences, Aalborg University, Denmark, [rene@math.aau.dk](mailto:rene@math.aau.dk)

Bettina Dahl

Department of Planning, Aalborg University, Denmark, [bdahls@plan.aau.dk](mailto:bdahls@plan.aau.dk)

Lisbeth Fajstrup

Department of Mathematical Sciences, Aalborg University, Denmark, [fajstrup@math.aau.dk](mailto:fajstrup@math.aau.dk)

## Summary

Many first-year engineering students perceive mathematics courses as being too abstract and far from their chosen study programme. This may lead to a lack of motivation and effort, thus decreasing the learning outcomes. We demonstrate that it is feasible to include field specific problems in introductory mathematics courses to motivate engineering students. This is done in a way that still allows large parts of the course to be common to all students, ensuring economic viability. The courses have been restructured into smaller subunits, each of which has a corresponding workshop treating a real-world problem from the specific field of a given group of students. These workshops are developed in consultation with the relevant fields of study, and they are given a prominent role in the course for instance by forming the basis for the oral exams. Based on the feedback from students, we find that inclusion of field specific problems does help to highlight the applicability and importance of mathematics in engineering. When implementing such a solution, however, there are a number of challenges to keep in mind.

**Keywords:** Calculus, linear algebra, engineering, motivation, field-specific problems, video, streamed lectures

**Type of contribution:** Best practice extended abstracts

## 1 Introduction

Generating student motivation can be especially challenging in introductory mathematics courses for engineering students. Research shows that first-year engineering students often complain about having to study calculus (Härterich et al., 2012). Engineering students furthermore do not develop mathematical concepts the same way as mathematics students, and the concepts have different meaning to them (Maull & Berry, 2000). Studies also show that engineering students see mathematics as a tool and wish to see applications as part of a course (Bingolbali et al., 2007), and engineering students who are at risk of demotivation and drop-out list the level of mathematics and theory as being too high as one of the issues (Baillie & Fitzgerald, 2000). Therefore, integrating mathematics education into the engineering field and work on real-life professional problems may help this student group see the use of mathematics in engineering (Pepin et al., 2021).

In this work, we evaluate a recent change in the structure of the calculus and linear algebra courses at Aalborg University (AAU) in Denmark. These courses, both 5 ECTS, are followed by all engineering students, primarily in their first year of study. Both courses follow a similar structure. To simplify the exposition, we will therefore

focus on calculus in the descriptions and examples given in this work. We note, however, that our evaluation (see Section 5) treats both courses, not only calculus.

## 2 Institutional setting

The education at AAU is based on the principles of problem-based learning (PBL). That is, in any given semester, the students are organized into small groups, writing a project around half of the time. Here, the groups choose an ill-structured and authentic problem, and the students work on a solution or answer to this problem, documenting this in a joint report. This is based on six PBL principles that are common for the whole university: (1) The *problem* is the point of departure and guides the project work, (2) The *projects* are organised in groups of up to eight students, (3) The projects are supported by *courses*, (4) *Collaboration* with a facilitator/supervisor and sometimes an external partner, (5) *Exemplarity*, meaning that the project's learning outcomes are transferable to similar future professional problems, (6) *Students* are responsible for their own learning and organise the work themselves (Askehave et al., 2015). The project groups carry over to other parts of university programmes, meaning that exercises for courses are typically solved in these groups as well. That is, there is no need to form *ad hoc* groups in teaching situations. Instead, teachers simply piggyback on the existing project groups. Another by-product of the group-based education is the continuous feedback from students via the *steering group* meetings. Each programme typically has two or three such meetings during the semester, and at these meetings, each group sends a representative to discuss any issues that may have arisen with their courses, projects, or practicalities with IT, maintenance etc. The steering group meetings are typically organized by a *semester coordinator*, and teachers are invited to participate as well. These meetings are devoted to continual evaluation of all parts of the semester, ensuring that potential issues can be addressed — and hopefully rectified — quickly.

## 3 Research methodology

The roll-out of the new course structure happened at the same time as SARS-CoV-2 (i.e. the virus causing COVID-19) spread across the world. In Denmark, this caused large parts of society to be shut down in an attempt to slow down transmission of the virus. Naturally, this also affected universities, and courses had to be digitalized 'on-the-fly'.

The changes caused by COVID-19 are very likely to have had a negative impact on student well-being and student motivation, which is in turn likely to affect dropout rates and overall performance. A US study on students' responses to this situation found that nearly half of the engineering and computer science students in the study listed motivation during lockdown as a challenge that affected their ability to perform (Casper et al., 2022). Another US study on the impact of COVID-19's remote instructions on engineering students' learning, found that students experienced a decline in their engagement and learning of new concepts. However, the study also found "that students' motivation could be the outcome of their learning experiences" (Anwar & Menekse, 2023, p. 7).

Hence, evaluating the new structure based solely on grades, dropout rates etc. would not give meaningful results. Instead, we performed a qualitative analysis based on comments given by the students in the minutes of the steering group meetings. These minutes also contain the students' thoughts on the calculus and linear algebra courses and their structure, so they will help in gauging the students' perception of the revised structure and the use of programme-specific workshops. These minutes are written following a fairly uniform template across the university and although sometimes written by students and other times by faculty, the minutes are always approved. Our analysis is based on all the steering group minutes we have access to from the autumn semester 2021 and the spring semester 2022. This amounts to a total of 57 meeting minutes spread across 11 study programmes.

## 4 Course structure

To allow the study programmes to tailor the course for their specific needs, they select among topics predefined by the Department of Mathematical Sciences. In this structure, each topic corresponds to a subunit, which we refer to as a *block*. The initial block treats multivariate functions and their role in calculus. This includes the concept of partial derivatives and the basic principles of optimization. This block is mandatory for all students following the calculus course, and to cover the required topics, this block is larger than the others, comprising six lectures. The remaining seven blocks all consist of two lectures and focus on a more specialized topic within the curriculum such as differential equations, complex numbers, or the Laplace transform. Each study programme will only follow three of these blocks, and the choice of blocks is made by the study board responsible for the given programme. At AAU, the lectures in the elective blocks are livestreamed to the group rooms of the students followed by on-site exercises. Using livestreams is not vital to the structure described in this work, however, and other educational institutions seeking to implement a similar course structure can opt for online or on-site lecturing as they see fit. Once a study programme has chosen the blocks for their calculus course, academic staff from the Department of Mathematical Sciences will meet with representatives from the given field of study to discuss potential problems that could form a basis for each of the four workshops.

A suitable problem for a specific block will need to satisfy two criteria. First, it should be something the students might see later in their studies or something that is currently worked on by researchers within the given field of study. Second, it must somehow rely on the mathematical concepts and results contained in the given block. The main purpose of the problem is to provide motivation, so it can exceed the current skill level of the students. The actual exercise problems that students will solve when doing the workshop will, for the most part, only be small ‘toy examples’ that explore certain parts of the grand solution to the problem as a whole. Moreover, the design of the workshop ensures that solving these exercises will require essential parts of the mathematics concepts and skills.

The course is evaluated through an oral exam. At the exam each student draws at random one of the four workshops that the student has solved during the course. The student is then given approximately five minutes to present exercises of their choice from the given workshop. Afterwards, the examiners have approximately five minutes to ask follow-up questions or other questions to the curriculum in general. Thus, including grade deliberations and other exam logistics, the examination lasts 15 minutes per student. Two examiners grade the student. One examiner is well-known to the students through the course, the other is in most cases a researcher from the students' engineering subject area. Note here that students do not hand in material in relation to the workshops, so the grade is based purely on the oral presentation given by the individual student.

### 4.1 Scheduling and administration

Before implementation of the new structure, we would have several parallel calculus courses where the study programmes were divided between these to fully utilize the capacity of the lecture halls. With the increased flexibility in the curriculum, this is no longer possible. We now must consider the many different combinations of blocks, each of which is likely to have a small number of students (in some cases as low as ~20 students). Running these as separate courses is not economically sustainable and would entail many duplicate lectures. Consequently, we now organize the course schedule based on the blocks, and then add study programmes as appropriate. As an example, the block on differential equations is conducted for thirteen programmes at the same time. That is, each group of students follow the chosen combination of blocks, but they will share lectures and exercise sessions with different programmes for each block. Note though that they do *not* share workshops since the workshop problems are tailored to each individual programme.

## 4.2 Example workshop

In this section, we give an example of a problem that is used as a motivating example in the workshops. More examples can be found in Christensen et al. (2023).

The health technology students follow the block on integration. For their workshop, it was decided to consider two different problems related to human health. The first is to determine the total flow of blood through a vein with a given radius and its relation to blood pressure. Using the Hagen-Poiseuille equation, the velocity of flow can be described as the solution to a differential equation, and the students are given this solution in the introduction. Determining the total flow then corresponds to integrating the velocity of flow over a cross section of the vein. The first exercise problems revolve around this as well as computing the flow in the case of a more advanced cross section.

The second problem in this workshop is the estimation of muscle volume when scanning results provide a finite number of cross-sectional images along the muscle in question. The students are then guided through this estimation using truncated cones in the setting where each cross section is circular. Afterwards, they consider an example with rectangular cross sections to see the approach in more general settings. In solving these exercises, they will use solids of revolution as well as triple integrals.

To conclude the workshop, they are asked to consider a muscle with circular cross sections given by a specific function. We provide a MATLAB-script computing the true volume, the estimated volume using truncated cones, and the estimated volume using cylinders. The students are asked to sketch the shapes whose volumes are computed and compare the results of the three calculations. Finally, they are asked to experiment with the parameters to confirm for both estimations that the precision increases as the number of available cross sections grows.

## 5 Evaluation

To aid the validity of our analysis of the steering group minutes, we used multiple interpreters and explication of the procedures (Kvale, 1996, pp. 207—208). First, the first author analysed all the minutes, coding each utterance as *Workshop*, *Teacher*, *Structure*, or *General* comments, respectively. The utterances were also tagged as being *Positive*, *Balanced*, or *Negative*. Next, a random programme was picked for each course using random.org, and the minutes corresponding to these programmes were then coded separately by the two other authors to check for coder reliability. In the first round of samples, we discovered that the four categories were not sufficiently well-defined. In order to improve coder reliability, we decided to do two things. First, reduce the categories to *Workshop*, *General*, and *Teacher*, and defined these more precisely as detailed in (Christensen et al., 2023). Second, we decided that other coders would be given the division of utterances used by the initial coder to circumvent the second type of problem seen in the first round of samples. With these changes, a second round of samples — different from the first round of samples — gave an agreement of 72% with respect to sentiment, 56% with respect to category, and 40% with respect to both at the same time. However, for every utterance at least two coders agreed on both category and sentiment. In addition, we note that any disagreement regarding the sentiments were between balanced and negative or balanced and positive. After computing agreement percentages, we discussed the cases that we had coded differently in order to figure out why we disagreed and to obtain consensus on the most appropriate code. An overview of the comments sorted by their final codes is given in the table below. We now proceed to analyse the overall tendencies in the comments in greater detail.

Table 1: Student comments sorted by codes.

Category	Count	Negative	Balanced	Positive
General	70	49%	16%	36%
Workshops	29	48%	24%	28%
Teacher	23	43%	22%	35%

## 5.1 Student comments

In the initial minutes from the students in structural engineering, the motivating problems are mentioned explicitly: *“during workshops, [the topics] are pinned to something tangible—works well”*. Thus, it seems like the students initially recognize the effort put into connecting terms from calculus to applications in their own field of study. At the following meeting, however, they comment that the course *“can sometimes be difficult to relate to, and [to see] how to apply it in other contexts.”* This could indicate that even though the students see calculus used in context during the workshops, they still find it difficult to relate to the course as a whole.

A point of critique appearing in the minutes from health technology is that their workshops tended to be too extensive. Along the same lines, students from chemistry and biology state that *“the topic worked on during the workshop seemed to be outside the curriculum [...]”*. This highlights a challenge regarding the choice of motivating problem. On the one hand, the problem must be as close as possible to the field of the students, but at the same time, it should not act as a hindrance to solving the underlying calculus problems. Some of the negative comments regarding the course structure were not related to what *had happened* in the course, but to the expectation of what *will happen*. These comments all relate to the streaming of the elective blocks, stating concern with the prospect of online teaching. We see this at the first meeting of 2022 for the Danish programmes in Esbjerg, where they say, *“we are happy that it is not yet virtual”*. Interestingly, at their last meeting where the streamed lectures have taken place, their sentiment has changed: *“[The] online part went well compared to last semester.”*

A benefit of the streamed lectures is that students can watch it (or parts of it) again, which we also see in the minutes. For instance, we find comments such as *“the students like that videos stay online from the digital lectures, so that one has a resource to look back on”* and *“Lectures have been recorded, which has been nice”*. A reoccurring theme in many of the minutes is the number of teachers involved in the course. We found comments such as *“[We] do not understand why we need different lecturers”* and *“is it possible to reduce the number of lecturers [...]”*. Part of the problem seemed to stem from us not providing enough (or sufficiently clear) information about the course structure and the assigned teachers at the beginning of the course. As a result, we now spend more time during the first lecture to explain the structure of the course and which teacher will be responsible for which parts. The latter is especially important with respect to the examiner; it should be clear to students who will conduct their exam.

## 6 Discussion

Through our reading of all the minutes, we see that students generally see the relevance of the workshop problems, exemplified by the quotes in Section 5.1. While this is not a direct measure of their motivation to learn, studies do suggest that perceived relevance is a major motivating factor (Kember et al., 2008). As the comments also suggest, however, the workshop problems must be chosen carefully to match the study programme, and sufficient support must be provided for the students.

The perceived relevance depends on giving students a sufficient understanding of the engineering context. In many of these workshops, the context is not introduced as an engineering subject until much later in their studies. This balance between what fits the curriculum in the mathematics courses and what engineering topic can be explained well enough for the students to buy into it being their engineering subject is the core of this approach.

What seems to cause more concern for students is the modularized structure of the course, which they in some cases found confusing. With limited funds available to run courses, some level of modularization and common scheduling is likely necessary. Based on the feedback we have collected, though, it is clear that care must be taken to make the structure transparent to students — more-so than what is needed for normal courses.

The study also has some limitations. First and foremost, that it is based on the steering group meeting minutes alone. Questionnaires or interviews of students could have provided triangulation of the results. However, steering groups, at least in principle, is a summary of the experience of all students, since the group representative should not only state their own opinions but present the experience from all the group members. Questionnaires are usually not answered by the whole population. Also, steering groups tend to focus on the negative experience.

## 7 Conclusion

In this work, we have described the restructuring of the calculus and linear algebra courses at Aalborg University in Denmark. Aiming to motivate students and to give them examples closer to their own field of study, the restructuring divides the courses into blocks, i.e., smaller subunits, chosen by the respective study programmes. Each block has a corresponding workshop treating a ‘real-world’ problem relevant to the given set of students, and these workshops form the basis of the oral exam. Through evaluation of the comments given by students at the steering group meetings during the semesters of autumn 2021 and spring 2022, we see that students do tend to appreciate the workshop problems if they are sufficiently close to their prospective field of study. One needs to choose problems carefully, though, as problems that veer too far from the lecture contents may overwhelm students. As we also highlight, however, performing such a restructuring is non-trivial, and there are a number of administrative challenges that one needs to keep in mind when implementing a similar structure. In particular, giving each study programme more flexibility in designing their curricula results in less flexibility when scheduling courses.

## 8 References

- Askehave, I., Prehn, I. H., Pedersen, J., & Pedersen, M. T. (Eds.) (2015). *PBL: Problem-Based Learning*. Aalborg University.
- Anwar, S., & Menekse, M. (2023). First-Year Engineering Students Experiences and Motivation Amid Emergency Remote Instruction. *IEEE Transactions on Education*. PP(99), 1–9.
- Baillie, C., & Fitzgerald, G. (2000). Motivation and attrition in engineering students. *European Journal of Engineering Education*, 25(2), 145–155.
- Casper, A. M. A., Rambo-Hernandez, K. E., Park, S., & Atadero, R. A. (2022). The Impact of Emergency Remote Learning on Students in Engineering and Computer Science in the United States: An Analysis of Four Universities. *Journal of Engineering Education*, 111(3), 703–728.
- Christensen, R. B., Dahl, B., & Fajstrup, L. (2023). Transforming First-Year Calculus Teaching for Engineering Students -- Blocks with Field Specific Examples, Problems, and Exams. <https://arxiv.org/abs/2302.05904>
- Härterich, J., Kiss, C., Rooch, A., Mönningmann, M., Darup, M. S., & Span, R. (2012). MathePraxis – connecting first-year mathematics with engineering applications. *European Journal of Engineering Education*, 37(3), 255–266.
- Kember, D., Ho, A., & Hong, C. (2008). The importance of establishing relevance in motivating student learning. *Active Learning in Higher Education*, 9(3), 249–263.
- Kvale, S. (1996). *InterViews*. SAGE Publications.
- Maull, W. & Berry, J. (2000). A questionnaire to elicit concept images of engineering students. *International Journal of Mathematical Education in Science and Technology*, 31(6), 899–917.
- Pepin, B., Biehler, R., & Gueudet G. (2021). Mathematics in engineering education: A review of the recent literature with a view towards innovative practices. *International Journal of Research in Undergraduate Mathematics Education*, 7(2), 163–188.

## Large-Scale Interdisciplinary Project-based Learning: Staff Experiences of Leading Multi-departmental Projects for Year 1 Engineering Students

Fiona Truscott

Integrated Engineering Programme and Centre for Engineering Education, Faculty of Engineering Science, University College London, London, UK, [f.truscott@ucl.ac.uk](mailto:f.truscott@ucl.ac.uk)

Emanuela Tilley

Integrated Engineering Programme and Centre for Engineering Education, Faculty of Engineering Science, University College London, London, UK, [e.tilley@ucl.ac.uk](mailto:e.tilley@ucl.ac.uk)

John Mitchell

Department of Electrical and Electronic Engineering and Centre for Engineering Education, Faculty of Engineering Sciences, University College London, London, UK, [j.mitchell@ucl.ac.uk](mailto:j.mitchell@ucl.ac.uk)

Abel Nyamapfene

Centre for Engineering Education, Faculty of Engineering Sciences, University College London, London, UK and Institute for Education, University College London, UK, [a.nyamapfene@ucl.ac.uk](mailto:a.nyamapfene@ucl.ac.uk)

### Summary

There is increasing consensus that Engineering programmes need to include space for skills learning, particularly in interdisciplinary contexts. Active learning methods, such as project-based learning, are the gold standard for teaching interdisciplinary skills. However much of the literature on these approaches focuses on relatively small class sizes, making the application in larger contexts seem unfeasible. The Integrated Engineering Programme (IEP) at University College London (UCL), is one of the most comprehensive and largest applications of active learning methodologies within undergraduate engineering curricula in the UK. A key part is the cornerstone module, Engineering Challenges. This first-year undergraduate module aims to introduce students to project work and key skills such as teamwork and communication through undertaking an interdisciplinary project. Taken by close to 1000 students across seven departments, this is a complex undertaking and we have had to develop approaches to delivering large-scale interdisciplinary project work. Team teaching is central to this; with the Engineering Challenges teaching team led by a faculty-level Module Lead, with one to four academics from each department. This paper focuses on the role of the Module Lead in this unusual situation, how this role differs from a more typical role and how this links to module success.

**Keywords:** Project Based Learning, Large Scale Teaching, Team Teaching

**Type of contribution:** Research extended abstracts

## 1 Introduction

There is an increasing focus within the Engineering Education community on preparing students for the careers after university with the inclusion of space within the curriculum for skills learning. The World Economic Forum's Future of Jobs Report consistently discusses the need for new graduates to have a mix of professional skills, global competency and technical knowledge (WEF, 2020). Given the complexity of future work places and the problems our graduates will be asked to tackle, learning these skills in an interdisciplinary context is increasing necessary. Active learning methods, such as project-based learning (PjBL), are the gold standard for teaching skills in a wide range of contexts (Kolb, 2015). Leaders within Engineering Education have incorporated these methods in their curricula for several years now and wide spread adoption is rapidly becoming the norm (Graham, 2018).

Engineering programmes are commonly very popular and tend to have relatively large class sizes. However much of the literature on active learning is focused around small class sizes (Graham, 2018, Guo, 2020, Hernández-de-Menéndez, 2019). It is not as simple as scaling up small class methodologies due to the unrealistic volume of resources, people, time and space required. So modified active learning approaches that are practical for large classes are required. The Integrated Engineering Programme (IEP) at University College London (UCL), is one of the most comprehensive and largest applications of active learning methodologies within undergraduate engineering curricula in the UK (Mitchell et al, 2019). Active learning is central to the IEP experience and are threaded throughout the common, cross-faculty teaching framework. While creating framework, we developed, and continue to develop, approaches that allow for practical delivery of active learning experiences with large numbers of students.

A key part of the IEP is the cornerstone module, Engineering Challenges. This first year undergraduate module aims to introduce students to project work and key skills such as teamwork and communication through an interdisciplinary project. Taken by close to 1000 students each year across seven departments, with material tailored to students' disciplines, this is a complex undertaking (Truscott et al, 2021).

Engineering Challenges is a significantly different to what we might consider a typical university module. For our purposes, a typical module is one that takes place within a single department and where one or two academics, plan and deliver all of the teaching and assessment. This typical module is taken by a number of students that can easily be accommodated in most classrooms and provides a reasonable teaching load for the one or two academics running the module. This will vary between universities depending on resources and estate but at UCL we estimate this to be between 50 and 100. In this typical module, the person leading it has control of all the pedagogical aspects of the module, while administrative support is provided by a member of the department's teaching and learning administration team.

Team-teaching is used extensively within the IEP to deliver large-scale interdisciplinary teaching but Team-teaching has not been widely used generally in HE contexts (Nyamapfene, 2016). For Engineering Challenges, the teaching team is lead by the Module Lead based at faculty level and contains one to four leads from each department that takes the module. Given the relative rarity of this situation, this study sets out to understand how staff working on the module describe their experience of active learning and team-teaching within this large-scale context, key elements for the success, what barriers and challenges they have faced and how they overcame them.

## 2 Methodology

The data discussed in this paper comes from a slightly larger review project on the views of those teaching within Engineering Challenges at all levels. In that project staff who have held the Module Lead role in the past and currently were interviewed, and the current and most recent Departmental Leads were invited to join focus groups. In this paper we have focused on the data collected during the Module Lead interviews.

Three staff members were interviewed for this small study: two past Module Leads and the person holding the role currently. As two of the authors are part of this group (ML1 and ML3), interviews were conducted by one of the other two authors who isn't involved in the delivery of the module. The interviews were semi-structured with topics decided beforehand by all four authors, but questions chosen by the interviewer. Interviews were conducted online via Microsoft Teams, recorded and auto-transcribed. The first Module Lead, referred to as ML1 in this paper designed, delivered and established the module from the start of the IEP in 2014, for two academic years until 2016. The second Module Lead, ML2, took over the leadership and continued in the role for two academic sessions until 2018. At which time the lead role changed hands again to ML3, who has led the module for last 5 academic sessions including through the recent pandemic years and is still Module Lead.

A thematic analysis was conducted of the Module Lead interviews by two of the authors followed by discussion and consolidation of the final themes list amongst all authors, as well as comparison to the themes



that came from the focus group data (not part of this paper). Interviewees were asked to discuss what the Module Lead role involved, their approach to it, the impact of scale, their thoughts on active learning approaches, the advantages and disadvantages of interdisciplinary teaching and if they could identify and comment on success factors and barriers in delivering the module.

### 3 Results and Discussion

Although the sample size is by definition very small, one clear conclusion comes through in all three interviews. The role of Module Lead within Engineering Challenges is substantially different to what is required of someone leading a typical module. This seems to come from both the size of the module and the interdisciplinary nature of it. The Engineering Challenges Module Lead involves much more executive function; co-ordinating groups of staff (both academic and administrative), providing vision, direction and resources; and is involved much less in the day to day business of the classroom than we might expect. It is probably more accurate to think of the Module Lead role as similar to a programme lead or, given the cross-departmental nature of the module, a faculty head of education, than a typical lecturer role. There are several strong themes that emerge from the interviews conducted related to what the role requires and what is needed for success. Leadership was by far the most discussed theme in all three interviews, with interdisciplinary and interdepartmental working, student experience and scale all also featuring within the discussions on success factors.

#### 3.1 Leadership

For all three interviewees, as the job title of Module Lead suggests, leadership was key to their conception of what their role within the module was. This covered a wider range of aspects of leadership, which included the day-to-day project management of the module as well as providing vision and a path forward in times of large-scale change. We can break down the quite broad concept of leadership into four key aspects within the Module Lead role: Pedagogical, Organisational, Advocational and Facilitative.

Pedagogical leadership covers both educational standardisation across the module, as noted by ML1, “Module Lead has to make sure there's consistency of assessment”, as well as providing the way forward in times of large scale change such as the move to online teaching in 2020 as a result of the COVID pandemic, as outlined by ML3, “you're the Module Leader. We don't know what we wanna do, come up with a kind of way forward for us.”. While the need for pedagogical vision could be argued to be necessary in a typical Module Lead role, the need for someone to be thinking about consistency across the module is unique to large scale and/or interdisciplinary teaching where multiple people involved in the delivery of the module and need to be on the same page.

Organisational leadership within the module is likened to project management by ML2, “So it's very much like a project managers.”. There is a key troubleshooting element during the running of the module as well as the structural work done prior. Again, while planning and problem solving again can be argued to be necessary for any type of teaching, the large scale, interdisciplinary nature of the module makes it a much larger and more complicated aspect of the Module Lead role.

Related is the need to advocate for the module, the teaching approach it uses and the resources and requirements it needs, effectively being the voice of the module. This is a key part of the Module Lead role due to the relative unusualness of the scale and approach as discussed by ML3, I “do a lot of representing the module to do with timetabling and central UCL for example, and the faculty.”. This also requires the Module Lead to be more involved with the administrative and logistical sides of the module than we might typically expect.

Central to the educational success of Engineering Challenges is the facilitative leadership aspect of the Module Lead's role, as this enables the other three aspects. The ability to build and develop relationships with a wide range of people across the engineering departments and the wider UCL community is essential.

ML2 comments on this central importance, “It's having the skills to make the relationships and sort of bring people with you without trying to force issues.”. Again, this is very different to a typical Module Lead role and is a function of both the large scale the module works on and the interdisciplinary nature of it as well as being key to the success of the team teaching approach to module delivery. (“The team teaching means that you need someone with Module Leadership to be there.” [ML1])

### 3.2 Success Factors

Three themes came out of the discussion on success factors; student experience, interdisciplinary and interdepartmental working, scale and teaching team. Student experience is a familiar consideration for anyone teaching and within the context of Engineering Challenges, this is the most familiar topic to come up in discussion with similar ideas and issues being raised to the majority of other modules. The other two themes are more specific to the context and specifics of Engineering Challenges.

Interdisciplinary teaching within Engineering Challenges comes in two forms, 1) between Engineering disciplines and 2) through bringing in topics and disciplinary studies perceived to be outside of Engineering such as ethics. This can lead to clashes between disciplinary approaches that need to be resolved by the Module Lead. Moreover, as indicated by ML2, interdisciplinary teaching combined with scale can result in not having enough space to fully explore a topic, “So if you're trying to so fuse it with some kind of social context or considerations, that's actually really difficult, with the scale of the students involved.”. An interdisciplinary approach also means working across departments at an operational level. Within UCL, central educational administrative systems and services function around a department model, allowing for departments to each having their own approach to, for example, communication or student support. In order for a faculty level module such as Engineering Challenges to function the Module Lead needs to try and find consensus across departments as well as tap into central systems that assume teaching is happening at a departmental level. This has become even more important in the context of the pandemic emergency teaching when changes were prevalent and occurred at pace. The Module Lead needs to be able to bring groups, information and approaches together, to find and construct consensus and, crucially, know when provide flexibility for different approaches to successfully deliver the module.

Engineering Challenges is one of the biggest modules, if not the biggest module, at UCL and one of the biggest PjBL modules in Engineering globally. That scale, in and of itself, can be a barrier to what can be done within the module. ML2 described the implications of scale as the person leading the module, “The scale of it sometimes means, I think that you can do a bit less than you would like. That's the downside of it.”. ML3 also mentions it indicating that even normal straightforward parts of the module become complex and time consuming, “as the number of students goes up, the logistics and everything isn't linear.”. A key success factor is knowing how to handle the complexities of scale and working in a supportive context that understands the difficulties that scale can introduce to any teaching activity.

## 4 Conclusion

The need for an unconventional Module Lead role in a central position is key in the success of large scale interdisciplinary active learning modules. Within Engineering Challenges, the large scale, interdisciplinarity nature and active learning approach combine to create the complex and relatively unique nature of the Module Lead's role. However, it is clear that when implementing new educational activities within any of these three aspects, anyone leading the development and running of these activities will need to employ a different set of approaches and skills to those that are typically used. Different structures will also be needed particularly when creating new interdisciplinary or large scale educational activities as centralised leadership seems to be key to the success of these. Institutional leadership will need to understand the non-typical nature of the Module Lead role and will need to think outside the box when putting in place large scale and/or interdisciplinary structures as well as the support needed for those leading this type of module or educational change. All three interviewees identified institutional buy-in and backing to be a key success factor, for

example from ML2, “We had to stamp of approval”. Also, as we approach ten years of Engineering Challenges and the IEP, it’s clear that, in contrast to the stereotype of traditional lecturing, this approach to teaching isn’t static and provides opportunities for constant innovation and improvement, as highlighted by ML3, “it’s always a work in progress, it’s always evolving”. This is can be very useful way to improve student experience and reflect on current events or thinking but does incur a resource penalty which needs to factored into things like teaching load.

## 5 References

- Graham, R., (2018), ‘The Global State of the Art in Engineering Education’, MIT School of Engineering (USA)
- Guo, P., Saab, N., Post, L. S., Admiraal, W., (2020), ‘A review of project-based learning in higher education: Student outcomes and measures’, *International Journal of Educational Research*, 102, 101586-101598, <https://doi.org/10.1016/j.ijer.2020.101586>.
- Hernández-de-Menéndez, M., Vallejo Guevara, A., Tudón Martínez, J. C., Hernández Alcántara, D., Morales-Menendez, R., (2019), ‘Active learning in engineering education. A review of fundamentals, best practices and experiences’, *International Journal on Interactive Design and Manufacturing*, 13, 909–922. <https://doi.org/10.1007/s12008-019-00557-8>
- Kolb, D. A., (2015), ‘*Experiential Learning : Experience as the Source of Learning and Development*’, Second ed., Pearson Education, Inc
- Mitchell, J. E., Nyamapfene, A. Z., Roach, K., and Tilley, E., (2019), Faculty Wide Curriculum Reform: the Integrated Engineering Programme. *European Journal of Engineering Education*, 46:1, p46-66, DOI: 10.1080/03043797.2019.1593324
- Mitchell, J. E. and Rogers, L., (2020), Staff perceptions of implementing project-based learning in engineering education, *European Journal of Engineering Education*, 45:3, 349-362, DOI: 10.1080/03043797.2019.1641471
- Nyamapfene, A. Z., (2016), Team-teaching on a Large Multidisciplinary Engineering Mathematics Class: The Lessons We Have Learnt so far, in P. Kapranos (ed) *ISEE 2016: Sixth International Symposium of Engineering Education* (pp. 285-292)
- Truscott, F. R., Tilley, E., Roach, K., and Mitchell, J. E., (2021), Perspectives on putting a large scale first year interdisciplinary project module online, PBL 2021, DOI: 10.26226/morressier.60ddad35e537565438d6c49b
- World Economic Forum, (2020), ‘Future of Jobs Report 2020’, World Economic Forum.

## List of Authors

( In alphabetic order)

<b>Name</b>	<b>Country</b>	<b>Affiliation</b>
Abel Nyamapfene	United Kingdom	University College London
Adam Hendry	Australia	Parramatta Marist High School
Aderonke Sakpere	Nigeria	University of Ibadan
Afandi Ahmad	Malaysia	Universiti Tun Hussein Onn Malaysia
Aida Guerra	Denmark	Aalborg University
Alessandro Gabbana	Netherlands	Eindhoven University of Technology
Alessia Napoleone	Denmark	Aalborg University
Amanda Horn	United States	University at Buffalo
Andres Lopez	Colombia	Universidad Icesi
Andrew Olewnik	United States	University at Buffalo
Anette Kolmos	Denmark	Aalborg University
Ann-Louise Andersen	Denmark	Aalborg University
Anna Karlsson-Bengtsson	Sweden	Chalmers Universtiy of Technology
Anneke Boonacker-Dekker	Netherlands	Eindhoven University of Technology
Antonio Elia Forter	United Kingdom	King's College London
Asbjørn Romme	Denmark	Aalborg University
Ashlee Pearson	Australia	The University of Melbourne
Ashraf Kassim	Singapore	Singapore University of Technology and Design
Avinash R	India	Vidyavardhaka College of Engineering
Ayelet Raz	Israel	Shamoon College of Engineering
Bart Johnson	United States	Minnesota North College
Bente Nørgaard	Denmark	Aalborg University
Bettina Dahl	Denmark	Aalborg University
Birgit de Bruin	Netherlands	TU Delft
Bonolo Mokoka	South Africa	University of Pretoria
Camila Pizano	Colombia	Universidad Icesi
Camilla Guldborg	Denmark	Aalborg University
Carola Hernandez	Colombia	Universidad de Los Andes

Chee Huei Lee	Singapore	Singapore University of Technology and Design
Christian Skelmosse	Denmark	University of Copenhagen
Christian Stöhr	Sweden	Chalmers University of Technology
Claire Lucas	United Kingdom	King's College London
Daniel Bateman	Australia	Parramatta Marist High School
Dave Custer	United States	Massachusetts Institute of Technology
Diana Carolina Latorre	Colombia	Universidad Pedagógica y Tecnológica de Colombia
Divine Nwabuife	Nigeria	University of Ibadan
Edwin Koh	Singapore	Singapore University of Technology and Design
Emanuela Tilley	United Kingdom	University College London
Enrique Galindo-Nava	United Kingdom	University College London
Eral Bele	United Kingdom	University College London
Erastus Abonyo	Kenya	University of Nairobi
Euan Lindsay	Denmark	Aalborg University
Faris Tarlochan	Qatar	Qatar University
Federico Toschi	Netherlands	Eindhoven University of Technology
Fenton Hughes	United States	Unicity International
Fernando Rodriguez-Mesa	Colombia	Universidad Nacional
Fiona Truscott	United Kingdom	University College London
Francesco Ciriello	United Kingdom	King's College London
Gabriel Astudillo	Chile	Pontificia Universidad Católica de Chile
Gesa Ruge	Australia	Central Queensland University
Giajenthiran Velmurugan	Denmark	Aalborg University
Gouri Vinod	United Kingdom	University College London
Goutham B	India	Vidyavardhaka College of Engineering
Gowtham N	India	Manipal Academy of Higher Education
Halleluyah Aworinde	Nigeria	Bowen University
Hans Hellendoorn	Netherlands	TU Delft
Henrik Worm Routhé	Denmark	Aalborg University
Hyejeong Lee	South Korea	Hanyang University
Hyunmi Park	South Korea	Hanyang University

Ida Marie Lybecker Korning	Denmark	Aalborg University
Ignacio Laiton	Colombia	Escuela Tecnológica Instituto Técnico Central
Imad Abou-Hayt	Denmark	Aalborg University
Ingrid Le Duc	Switzerland	École Polytechnique Fédérale de Lausanne
Isabel Hilliger	Chile	Pontificia Universidad Católica de Chile
Isabelle Lermigeaux- Sarrade	Switzerland	École Polytechnique Fédérale de Lausanne
Jaco Fourie	South Africa	Curiosity Campus
Jacob Chen	Singapore	Singapore University of Technology and Design
Jakob Farian Krarup	Denmark	University College of Northern Denmark
Jasmina Lazendic- Galloway	Netherlands	Eindhoven University of Technology
Jeonga Yang	South Korea	Hanyang University
Jette Egelund Holgaard	Denmark	Aalborg University
Jianxi Luo	Singapore	Singapore University of Technology and Design
Johanna Larsson	Sweden	Chalmers Universtiy of Technology
John Mitchell	United Kingdom	University College London
Jorge A Baier	Chile	Pontificia Universidad Católica de Chile
Joshua Bryers	Australia	Parramatta Marist High School
Jovana Jezdimirovic Ranito	Netherlands	University of Twente
Jun Hua Ong	Singapore	Singapore University of Technology and Design
Karin Wolff	South Africa	Stellenbosch University
Katherine Ortegon	Colombia	Universidad Icesi
Khalid Naji	Qatar	Qatar University
Kristina Henricson Briggs	Sweden	Chalmers Universtiy of Technology
Kwan Chee Goh	Singapore	Singapore University of Technology and Design
Laine Schrewe	United States	University at Buffalo
Lama Hamadeh	United Kingdom	University College London
Lars Bo Henriksen	Denmark	Aalborg University

Lee Siang Tai	Singapore	Singapore University of Technology and Design
Lelanie Smith	South Africa	University of Pretoria
Leonidah Kerubo	Kenya	University of Nairobi
Lilia Bárcena-Caballero	Mexico	Tecnologico de Monterrey
Liliana Fernández-Samacá	Colombia	Universidad Pedagógica y Tecnológica de Colombia
Lina Peña-Páez	Colombia	Universidad de San Buenaventura
Linette Bossen	Netherlands	TU Delft
Lior Aronstham	Israel	Shamoon College of Engineering
Lisbeth Fajstrup	Denmark	Aalborg University
Liwei Guo	United Kingdom	University College London
Loreto Valenzuela	Chile	Pontificia Universidad Católica de Chile
Louise Møller Haase	Denmark	Aalborg University
Lucienne Blessing	Singapore	Singapore University of Technology and Design
Lui Albaek Thomsen	Denmark	Aalborg University
Lyda Soto-Urrea	Colombia	Universidad de San Buenaventura
Lykke Brogaard Bertel	Denmark	Aalborg University
M Ezhilarasi	India	Kumaraguru College of Technology
Mahipal Bukya	India	Manipal Academy of Higher Education
Marc Zolver	Kenya	University of Nairobi
María Cristina Corrales Mejía	Colombia	Universidad Pedagógica y Tecnológica de Colombia
Maria Leon	Colombia	Universidad de Los Andes
Martyna Michalska	United Kingdom	University College London
Matías Piña	Chile	Pontificia Universidad Católica de Chile
Mattias Bingerud	Sweden	Chalmers University of Technology
Melvin Lee Ming Jun	Singapore	Singapore University of Technology and Design
Mette Møller Jeppesen	Denmark	Aalborg University
Michael O'Connell	Sweden	Chalmers University of Technology
Mikael Enelund	Sweden	Chalmers University of Technology
Mogens Rysholt Poulsen	Denmark	Aalborg University

Mohan Rajesh Elara	Singapore	Singapore University of Technology and Design
Muhammad Muzakkir Mohd Nadzri	Malaysia	Universiti Tun Hussein Onn Malaysia
Natalia Rodriguez	Colombia	Universidad Icesi
Oka Kurniawan	Singapore	Singapore University of Technology and Design
Olav Geil	Denmark	Aalborg University
Olga Timcenko	Denmark	Aalborg University
Oscar Ivan Higuera-Martinez	Colombia	Universidad Pedagógica y Tecnológica de Colombia
Oscar Mariño	Colombia	Universidad Distrital Francisco José de Caldas
Pascal Wilhelm	Netherlands	University of Twente
Patric Wallin	Norway	Norwegian University of Science and Technology
Patricia Caratozzolo	Mexico	Tecnologico de Monterrey
Pauli Lai	Hong Kong	The Hong Kong Polytechnic University
Philippe Chang	Colombia	Universidad Nacional de Colombia Sede Manizales
Pilar Acosta	Colombia	Universidad Icesi
Raffaella Negretti	Sweden	Chalmers University of Technology
Rakshith P	India	Vidyavardhaka College of Engineering
Renate G. Klaassen	Netherlands	TU Delft
René Bødker Christensen	Denmark	Aalborg University
Richa Mishra	India	Nirma University
Ronald Ulseth	United States	Iron Range Engineering
Ronit Shmallo	Israel	Shamoon College of Engineering
Ryan Lundell	United States	Santa Clara University
S G Mohanraj	India	Kumaraguru College of Technology
Sally Male	Australia	The University of Melbourne
Sanne Lisborg	Denmark	Aalborg University
Savyasachi G K	India	Vidyavardhaka College of Engineering
Sebastian Munk Andersen	Denmark	Aalborg University
Shamsul Mohamad	Malaysia	Universiti Tun Hussein Onn Malaysia
Shobha Shankar	India	Vidyavardhaka College of Engineering



Shubhakar Kalya	Singapore	Singapore University of Technology and Design
Sofie Otto	Denmark	Aalborg University
Sonia Esperanza Díaz Marquéz	Colombia	Universidad Pedagógica y Tecnológica de Colombia
Søren Hansen	Denmark	Aalborg University
Stine Ejsing-Duun	Denmark	Aalborg University
Tammar Shrot	Israel	Shamoon College of Engineering
Tee Hui Teo	Singapore	Singapore University of Technology and Design
Thitiwat Piyatamrong	United Kingdom	University College London
Thomas Ochuku Mbuya	Kenya	University of Nairobi
Troels Frøkjær Christensen	Denmark	Aalborg University
Wadha Labda	Qatar	Qatar University
Wei Lek Kwan	Singapore	Singapore University of Technology and Design
Wei Liu	United Kingdom	King's College London
Wonderful Osalor	Nigeria	University of Ibadan
Xiangyun Du	Denmark	Aalborg University
Ximena Hidalgo	Chile	Pontificia Universidad Católica de Chile
Yakhoub Ndiaye	Singapore	Singapore University of Technology and Design
Yan Zhao	Denmark	Aalborg University
Yifan Xie	United Kingdom	University College London
Yiwen Xu	United Kingdom	University College London
Yvonne Vervuurt	Netherlands	Eindhoven University of Technology
Zareena Gani	United Kingdom	University College London

# Acknowledgements

## List of Reviewers

( In alphabetic order)

<b>Name</b>	<b>Country</b>
Afandi Ahmad	Universiti Tun Hussein Onn Malaysia, Malaysia
Anders Melbye Boelt	Aalborg University, Denmark
Anna Markman	Aalborg University, Denmark
Azneeal Ar Rashid Bin Mohd Ramli	Pejabat Pendidikan Daerah Kuala Kangsar, Malaysia
Bettina Dahl	Aalborg University, Denmark
Carlos Fernando Vega Barona	Universidad Autonoma de Occidente, Colombia
Carlos Mora	La Laguna University, Spain
Carola Hernandez	Universidad de los Andes, Colombia
Dan Jiang	Aalborg University, Denmark
Euan Lindsay	Aalborg University, Denmark
Faris Tarlochan	Qatar University, Qatar
Fatin Aliah Phang	Universiti Teknologi Malaysia, Malaysia
Fernando Rodriguez-Mesa	Universidad Nacional de Colombia, Colombia
Giajenthiran Velmurugan	Aalborg University, Denmark
Gunes Korkmaz	Gazi University, Turkey
Ibrahim H Yeter	Nanyang Technological University, Singapore
Ida Marie Lybecker Korning	Aalborg University, Denmark
Jens Myrup Pedersen	Aalborg University, Denmark
Jette Holgaard	Aalborg University, Denmark
Jose Ramirez	Universidad del Valle, Colombia
Juebei Chen	Aalborg University, Denmark
Liliana Fernández-Samacá	Universidad Pedagógica y Tecnológica de Colombia, Colombia
Luiz Ney d'Escoffier	CEFET/RJ, Brazil
Maiken Winther	Aalborg University, Denmark
Marco Braga	CEFET/RJ, Brazil
Mia Thyrre Sørensen	Aalborg University, Denmark

Mohamad Termizi Borhan	Universiti Pendidikan Sultan Idris, Malaysia
Niels Erik Ruan Lyngdorf	Aalborg University, Denmark
Roger Hadgraft	University of Technology Sydney, Australia
Rui M Lima	University of Minho, Portugal
Sofie Otto	Aalborg University, Denmark
Stine Ejsing-Duun	Aalborg University, Denmark
Thomas Ryberg	Aalborg University, Denmark
Ulisses Araujo	University of São Paulo, Brazil



# Summary

**Transforming engineering education** is the theme of the **9<sup>th</sup> International Research Symposium on Problem-Based Learning (IRSPBL2023)**, convened by the MIT School of Engineering, Harvard's John A. Paulson School of Engineering and Applied Sciences, and the Aalborg Centre for Problem-Based Learning in Engineering Science and Sustainability under the auspices of UNESCO. This book presents the 54 contributions from 16 different countries from this IRSPBL edition.

The contributions cover a relevant number of topics, from **Collaboration with Industry** to **Creativity and Interdisciplinarity**, **Development of Professional Competences**, **Digitalization and Online Learning**, and **Education for Sustainability**, just name a few. They all aim to contribute for same vision, which is how to prepare next generation of professional engineers with the right set of skills, such as complex problem-solving, systems thinking and interdisciplinary collaboration, to address global challenges, whilst taking different strategies, lines of research and involvement.

This book represents some of the **newest results from research on PBL and best practices** to inspire researchers and practitioners to transform their practice and their institutions.