



AALBORG UNIVERSITY
DENMARK

Aalborg Universitet

Ancillary Frequency Control of Direct Drive Full-Scale Converter Based Wind Power Plants

Hu, Weihao; Su, Chi; Fang, Jiakun; Chen, Zhe; Hu, Yanting

Published in:

Proceedings of the 2013 IEEE Grenoble PowerTech (POWERTECH)

DOI (link to publication from Publisher):

[10.1109/PTC.2013.6652386](https://doi.org/10.1109/PTC.2013.6652386)

Publication date:

2013

Document Version

Early version, also known as pre-print

[Link to publication from Aalborg University](#)

Citation for published version (APA):

Hu, W., Su, C., Fang, J., Chen, Z., & Hu, Y. (2013). Ancillary Frequency Control of Direct Drive Full-Scale Converter Based Wind Power Plants. In *Proceedings of the 2013 IEEE Grenoble PowerTech (POWERTECH)* IEEE Press. <https://doi.org/10.1109/PTC.2013.6652386>

General rights

Copyright and moral rights for the publications made accessible in the public portal are retained by the authors and/or other copyright owners and it is a condition of accessing publications that users recognise and abide by the legal requirements associated with these rights.

- Users may download and print one copy of any publication from the public portal for the purpose of private study or research.
- You may not further distribute the material or use it for any profit-making activity or commercial gain
- You may freely distribute the URL identifying the publication in the public portal -

Take down policy

If you believe that this document breaches copyright please contact us at vbn@aub.aau.dk providing details, and we will remove access to the work immediately and investigate your claim.

Ancillary Frequency Control of Direct Drive Full-Scale Converter Based Wind Power Plants

Weihaohu, Chi Su, Jiakun Fang and Zhe Chen

Department of Energy Technology
Aalborg University
Denmark

whu@et.aau.dk, csu@et.aau.dk, jfa@et.aau.dk and
zch@et.aau.dk

Yanting Hu

Electrical Engineering of the Institute of Art, design and
Technology

Glyndwr University
United Kingdom
y.hu@glyndwr.ac.uk

Abstract—This paper presents a simulation model of a wind power plant based on a MW-level variable speed wind turbine with a full-scale back-to-back power converter developed in the simulation tool of DigSILENT Power Factory. Three different kinds of ancillary frequency control strategies, namely inertia emulation, primary frequency control and secondary frequency control, are proposed in order to improve the frequency stability of power systems. The modified IEEE 39-bus test system with a large-scale wind power penetration is chosen as the studied power system. Simulation results show that the proposed control strategies are effective means for providing ancillary frequency control of variable speed wind turbines with full-scale back-to-back power converters.

Index Terms-- ancillary frequency control, inertia emulation, primary frequency control, secondary frequency control, direct-drive-full-converter-based wind turbines.

I. INTRODUCTION

Because of energy shortage and environment pollution, the renewable energy, especially wind energy has attracted more attentions all over the world. Large-scale wind power plants are increasingly integrated into the modern power systems. In Denmark, the wind energy supplies around 20% of the annual electricity demand in 2009, which is the highest among other countries in the world [1]. The wind power is expected to be around 50% of total power generation in Denmark by 2025 and the total installed wind power capacity is proposed as 6500 MW. Then the traditional central power plants will have to be reduced [2]. However, integration of such a lot of wind energy into power grids presents a major challenge to power system operators because of the high uncertainty and variability in the wind power characteristic nature [3]. New power system frequency control solutions, such as frequency control from wind power plants may be needed in this situation.

Variable speed wind turbines with multipole permanent magnet synchronous generator (PMSG) and full-scale back-to-back converters are becoming more popular worldwide,

because of some advantages such as no gearbox, high power density and easy to control [4]. In this paper, a wind power plant based on variable speed wind turbines with PMSGs and full-scale back-to-back converters is chosen as the study case.

Traditionally, the power system frequency control is normally provided by conventional synchronous generators. With the proportion of wind farm into power system increasing, the transmission system operators start putting on new requirements in the grid codes for wind farm integration [5, 6]. However, the wind turbine rotation speed is decoupled from the power system frequency by power electronic converters in wind turbines with PMSGs and full-scale converters [7]. The inertia emulation control and primary frequency control strategies of doubly fed induction machine (DFIG) and PMSG based wind turbines have been proposed [7-10].

In this paper, three different kinds of ancillary frequency control strategies, namely inertia emulation, primary frequency control and secondary frequency control, are proposed and combined together in order to improve the frequency stability of power systems. This paper is organized as follows. The wind turbine model and its control schemes are presented in Section II and Section III, respectively. Then three different kinds of ancillary frequency control strategies of direct drive full-scale converter based wind power plants are discussed in Section IV. The simulation results are presented in Section V and Conclusions are given in Section VI.

II. WIND TURBINE MODEL

The wind turbine considered in this paper applies a PMSG, using a back-to-back full-scale PWM voltage source converter connected to the grid. Variable speed operation of the wind turbine can be realized by appropriate adjustment of the rotor speed and pitch angle.

A complete wind turbine model includes the wind speed model, the aerodynamic model of the wind turbine, the

mechanical model of the transmission system and models of the electrical components, namely the PMSG, PWM voltage source converters, transformer, and the control and supervisory system. Figure 1 illustrates the main components of the grid connected wind turbine. The control schemes are also shown in this figure, which will be discussed in Section III.

A simplified aerodynamic model is normally used when the electrical behavior of the wind turbine is the main interest of the study. The relation between the wind speed and aerodynamic torque may be described by the following equation:

$$T_w = \frac{1}{2} \rho \pi R^3 v_{eq}^2 \frac{C_p(\theta, \lambda)}{\lambda} \quad (1)$$

where T_w is the aerodynamic torque extracted from the wind (Nm); ρ is the air density (kg/m^3); R is the wind turbine rotor radius (m); v_{eq} is the equivalent wind speed (m/s); θ is the pitch angle of the rotor (deg), $\lambda = \omega R / v_{eq}$ is the tip speed ratio; ω is the wind turbine rotor speed (rad/s); and C_p is the aerodynamic efficiency of the rotor.

As for the mechanical model, emphasis is put on the parts of the dynamic structure of the wind turbine that contribute to the interaction with the grid. Therefore, only the drive train is considered, while the other parts of the wind turbine structure, e.g. tower and flap bending modes, are neglected. A two-mass model is applied in this paper to represent the drive train.

In this paper, the PMSG is modeled by the synchronous generator model in DIgSILENT Power Factory library, with a constant excitation current setting. For a detailed PWM voltage source converter model, the power electronic components should be switched on and off at a high frequency, which requires a very small simulation time step to well represent the PWM waveforms. The simulation speed is thus fairly slow. Since the study interest is not in the switches of the PWM converter, an average model without switches is used instead of a detailed PWM voltage source converter model so that the simulation can be carried out with a larger time step resulting in a simulation speed improvement [11].

III. CONTROL SCHEMES

For a variable speed wind turbine with a PMSG and a back-to-back full-scale converter, it is possible to control the electromagnetic torque at the generator directly. In low to moderate wind speeds, the control goal is maintaining a constant optimum tip speed ratio for maximum aerodynamic efficiency. At this tip speed ratio the aerodynamic efficiency, C_p , is at maximum, which means that the energy conversion is maximized. It is normally referred to as maximum power point tracking (MPPT) [12]. In high wind speeds, the control goal is to keep the rated output power fixed in order not to overload the system.

Vector control techniques have been well developed for PMSG using back-to-back PWM converters [13]. Two vector control schemes are designed respectively for the generator-side and grid-side PWM converters, which are also shown in

Figure 1. The objective of the vector-control scheme for the grid-side PWM converter is to keep the DC-link voltage constant regardless of the magnitude of the generator power, while keeping sinusoidal grid currents. It may also be responsible for controlling reactive power flow between the grid and the grid-side converter by adjusting Q_{g_ref} .

The objective of the vector-control scheme for the generator-side PWM converter is to control the optimal power tracking for maximum energy capture from the wind by adjusting the speed of the wind turbine. Normally, the reference values of both generator-side and grid-side converters, Q_{s_ref} and Q_{g_ref} are set to zero to ensure unity power factor operation and reduce currents of both generator-side and grid-side converters.

The aerodynamic model of the wind turbine has shown that the aerodynamic efficiency is strongly influenced by variation of the blade pitch with respect to the direction of the wind or to the plane of rotation. Small changes in pitch angle can have a dramatic effect on the power output. For wind speeds above the rated value, the pitch control scheme takes over the wind turbine control to limit the output power [14]. Reference [15] illustrates a relationship between the pitch angle and the wind speed.

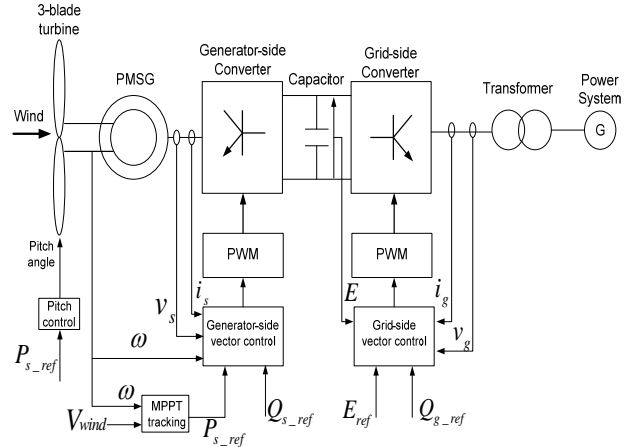

Figure 1. Block diagram of a grid connected wind turbine with a PMSG and a full-scale converter.

IV. ANCILLARY FREQUENCY CONTROL

If a wind turbine always works at the maximum power point under all wind speed condition, it is impossible for the wind turbine to provide extra power to the power system when the system frequency is decreased. Therefore, a wind turbine has to generate lower power than the maximum power under all wind speed condition, if the wind turbine is adopted to provide ancillary frequency control. In this paper, it is assumed that the wind turbine always works at 95% of its maximum power.

A. Primary Frequency Control

Primary frequency control acts within the first few seconds following a change in system frequency (disturbance) to stabilize the system. The purpose of primary control, in short,

is to respond immediately to these variations and maintain the system frequency within specified limits [16].

Figure 2 illustrates the inertia emulation and primary frequency control of wind power plants. The upper loop is the inertia emulation loop. The inertia emulation output is proportional to the changing rate of the system frequency and the emulated inertia is proportional to the gain K_{ie} .

The lower loop is the primary frequency control loop and the output is decided by the deviation of system frequency from its rated value. A dead band of $\pm 0.1\text{Hz}$ is used in the primary frequency control loop. The sum of the outputs of these two control loops is sent to a gradient limiter to obtain the final output of the frequency controller.

Under low wind speed conditions, the control signal of the primary frequency control loop is sent to the generator-side convertor controller (see Figure 1) and combined into rotation speed reference of the generator. Under high wind speeds, the control signal of the primary frequency control loop is sent to pitch controller (also see Figure 1). When the control signal of the primary frequency control loop is positive, which means that less power is needed from the wind farm, the rotation speed of the generator or the pitch angle will be adjusted in order to decrease the wind power generation. Therefore, the wind farms are able to provide an extra power output to the connected power system when the system experiences an active power imbalance and frequency variation.

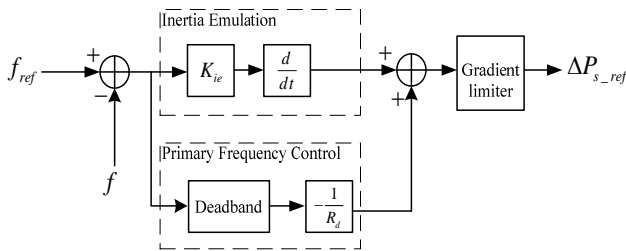

Figure 2. Inertia emulation and primary frequency control of wind power plants.

B. Secondary Frequency Control

The primary frequency control normally results in steady-state frequency errors. The secondary frequency control is to eliminate this frequency deviation and to correct errors in the power interchanges between different areas. The control action is slower than the primary frequency control and typical in the range from few tens of seconds to minutes [16-18].

The load frequency control (LFC) is a centralized automatic control and the transmission system operator (TSO) normally sends real-time power control signals directly to the big power plants. The wind power plants based on direct drive full-scale converter and PMSG may also provide the secondary frequency control in order to maintain the power system stability and security.

The secondary frequency control of wind power plants is shown in Figure 3. The input of the control is area control error (ACE) and the load frequency control is applied to

maintain the system frequency and the power transferred through the major tie-line is kept the same.

The area control error of an interconnected system due to power imbalance may be described by the following equation:

$$ACE = \Delta P_t + B\Delta f \quad (2)$$

where ACE is the area control error, B is the frequency bias factor, Δf is the frequency deviation, ΔP_t is the total power deviation between the interconnected power systems.

The ACE signal is then passed through a LFC block, which is typical consist of a low pass filter, a dead band, a delay block and a conventional proportional-integral (PI) controller. As per UCTE guidelines, the typical values of the controller gain and the time constant recommended for the control areas are 0.1-0.5 and 50-200 seconds, respectively [17]. After that, some part of the power is dispatched to the wind power plants using simple participation factor method [18, 19]. Finally, the reference power of the wind power plants is adjusted according to the secondary ancillary frequency control strategies.

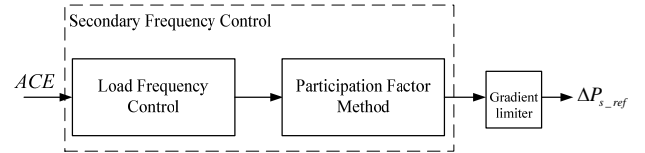

Figure 3. The secondary frequency control of wind power plants.

V. SIMULATION AND RESULTS

The modified IEEE 39-bus test system with a large-scale wind power plant connection is chosen the studied power system, as shown in Figure 4 [20]. An 1000 MW wind power plant based on PMSG and back-to-back full-scale converters is connected at bus 29 in the test system. It can cover around 16.4% of the load in the test system when fully operated. One aggregated big wind turbine is used to represent the wind power plant instead of several small wind turbines in DIGSILENT Power Factory.

A. Simulation Results of Primary Frequency Control

Figure 5 and Figure 6 illustrate the performance of the ancillary primary frequency control under low wind speed (8 m/s) and high wind speed (15 m/s) when the system frequency increases. Several loads in the power system are decreased at 100 s to create a frequency disturbance. It can be seen both the inertia emulation control and primary frequency control of wind power plants can provide frequency control ability to power systems. The inertia emulation control only provides extra power during the dynamic operation and the primary frequency control is able to provide extra power in the steady-state. However, the primary frequency control results in steady-state frequency errors, which means that the system frequency never return to the reference value after the primary frequency control. It can be also observed that the frequency control ability of wind power plants is higher when the wind speed is higher, which means that the wind power generation is higher.

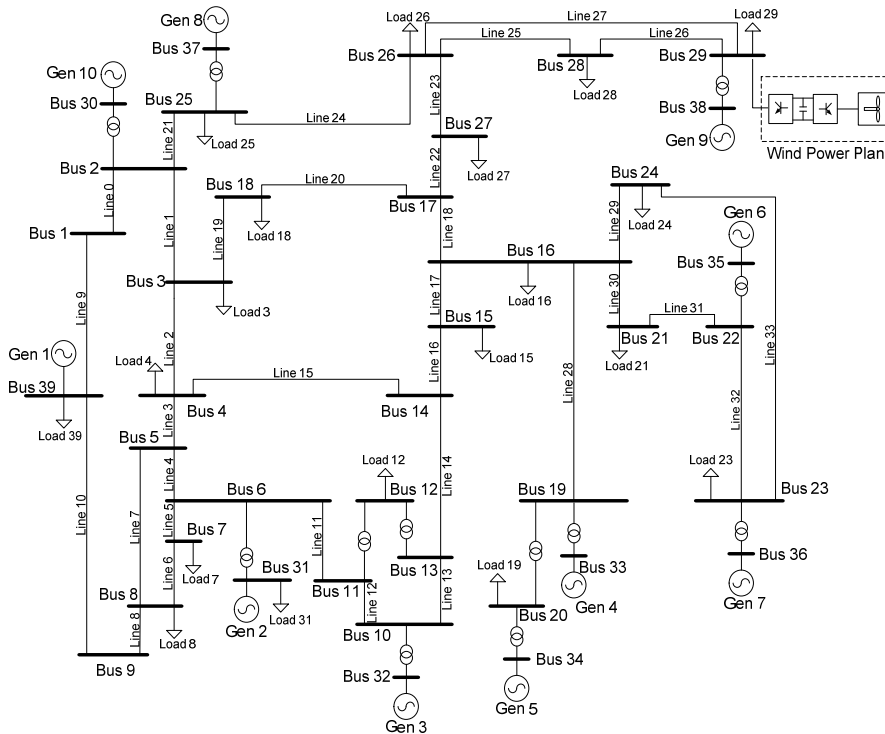
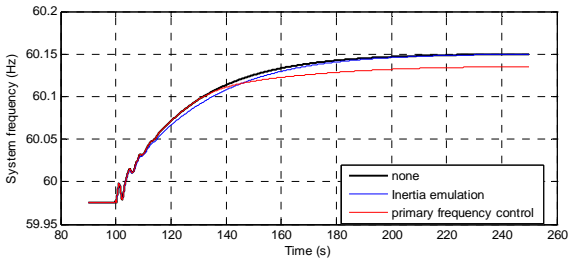
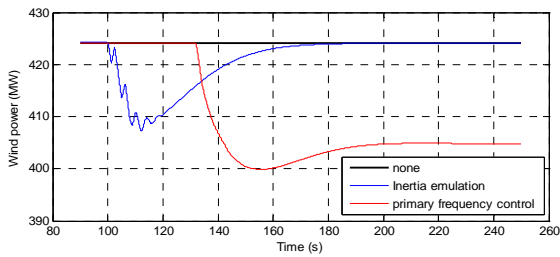

Figure 4. The modified IEEE 39-bus test system with a large-scale wind power plant connected at bus 29.



(a) System frequency



(b) Wind power

Figure 5. Ancillary primary frequency control performance at wind speed 8m/s when the system frequency increases (black: no control, blue: inertia control, red: primary frequency control).

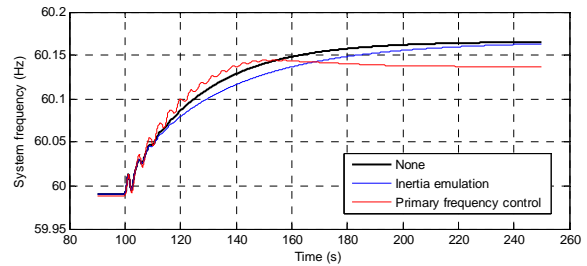

(a) System frequency

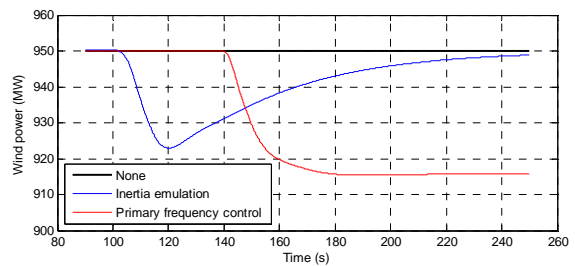

(b) Wind power

Figure 6. Ancillary primary frequency control performance at wind speed 15m/s when the system frequency increases (black: no control, blue: inertia control, red: primary frequency control).

Another set of simulations is also conducted when the system frequency increases after some disturbance. Several loads in the power system are increased at 100 s to create a frequency disturbance. The performances of the ancillary primary frequency control under low wind speed (8 m/s) and high wind speed (15 m/s) when the system frequency

increases are shown in Figure 7 and Figure 8. Both the inertia emulation control and primary frequency control of wind power plants can also provide frequency control ability to power systems when the system frequency increases after some disturbance. It can be seen that the frequency control ability of wind power plants is higher when the wind speed is

higher, which indicates that the wind power generation is higher. However, it should also be noted that the primary frequency control ability is limited when the system frequency decreases, because it is assumed that the wind turbine always works at 95% of its maximum power in this paper, which implies that only 5% of the maximum power is reserved to provide the primary frequency control.

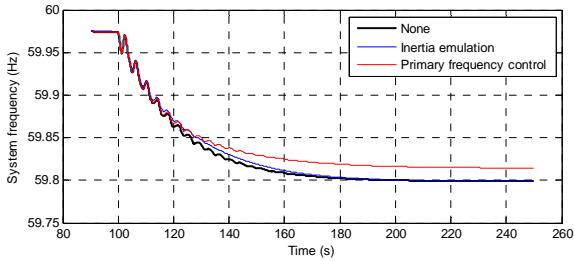

(a) System frequency

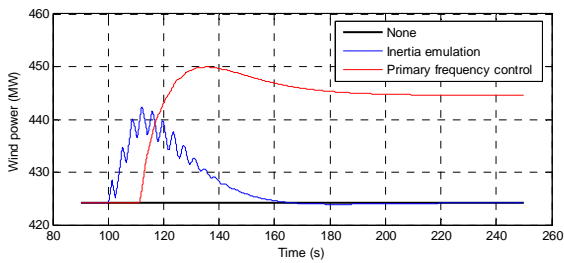

(b) Wind power

Figure 7. Ancillary primary frequency control performance at wind speed 8m/s when the system frequency decreases (black: no control, blue: inertia control, red: primary frequency control).

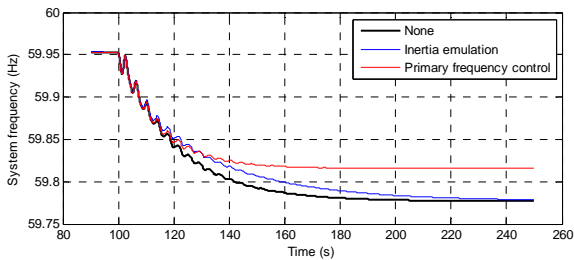

(a) System frequency

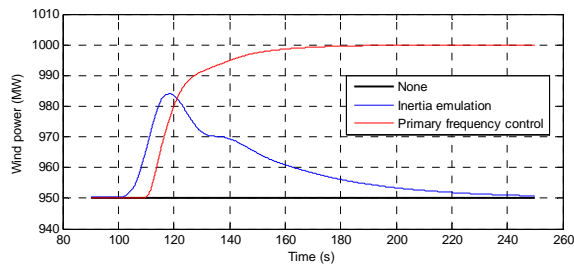

(b) Wind power

Figure 8. Ancillary primary frequency control performance at wind speed 15m/s when the system frequency decreases (black: no control, blue: inertia control, red: primary frequency control).

B. Simulation Results of Secondary Frequency Control

The studied IEEE 39-bus test system is an isolated power system and there is no connection with other power systems. Therefore, only the frequency deviation in equation (2) is used as the ACE signal. Figures 9 and Figure 10 show the performance of the ancillary secondary frequency control under low wind speed (8 m/s) when the system frequency increases (Figure 9) and decreases (Figure 10). It can be seen the secondary frequency control of wind power plants can provide secondary frequency control ability to power systems. The secondary frequency control is able to eliminate the steady-state frequency error. The wind power plants can provide extra power depending on the centralized LFC control, which will be very important for power systems with high wind power penetrations, such as Danish power system [1, 2].

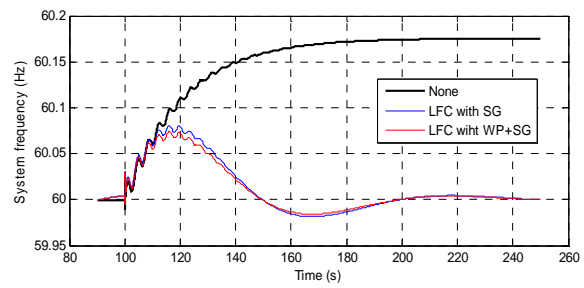

(a) System frequency

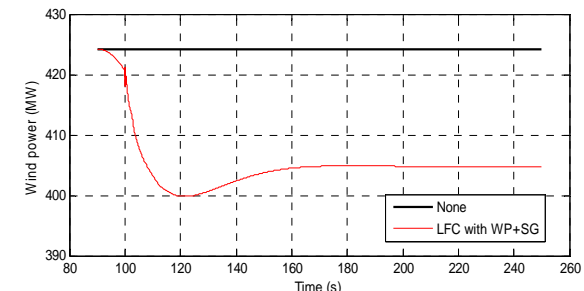

(b) Wind power

Figure 9. Ancillary secondary frequency control performance at wind speed 8m/s when the system frequency increases (black: no control, blue: LFC control using only synchronous generators, red: LFC control using both wind power plants and synchronous generators).

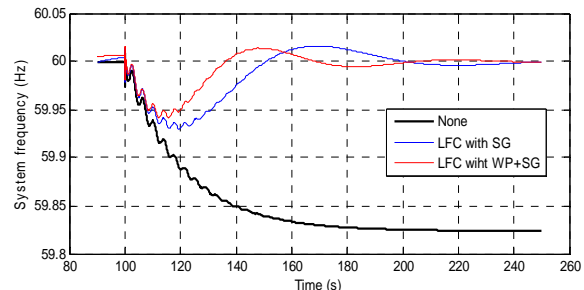

(a) System frequency

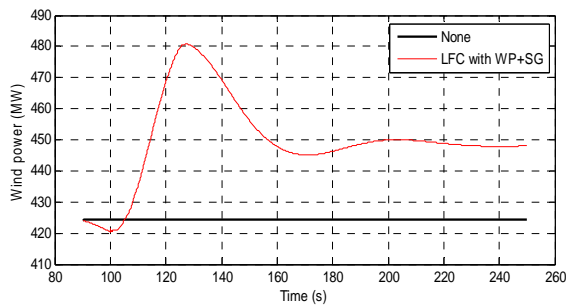

(b) Wind power

Figure 10. Ancillary secondary frequency control performance at wind speed 8m/s when the system frequency decreases (black: no control, blue: LFC control using only synchronous generators, red: LFC control using both wind power plants and synchronous generators).

VI. CONCLUSIONS

This paper built a direct-drive-full-converter-based wind turbine model to represent an aggregated wind power plant model. A modified IEEE 39-bus test system with a large-scale wind power plant is used as the test system. Three different kinds of ancillary frequency control strategies, namely inertia emulation, primary frequency control and secondary frequency control, are proposed in order to improve the frequency stability of power systems. It can be concluded that the proposed control strategies are effective means for providing ancillary frequency control of variable speed wind turbines with full-scale back-to-back power converters. The ancillary frequency control ability of wind power plants is generally higher when the wind speed is higher. The ancillary frequency control ability is limited when the system frequency increases and wind power plants have to increase their output power.

REFERENCES

- [1] World Wind Energy Association. (2010, Mar.). *World Wind Energy Report 2009*. [Online]. Available: http://www.wwindea.org/home/images/stories/worldwindenergyreport2009_s.pdf
- [2] System Plan Energinet.dk, Oct. 2007 [Online]. Available: <http://www.energinet.dk/NR/rdonlyres/55E4CE52-8412-4FB1-A62D-5BC321E3C792/0/Systemplan2007GB.pdf>
- [3] R. Zavadil, N. Miller, A. Ellis, E. Muliadi, 'Wind energy delivery issues', *IEEE Power Energy Mag.*, 2005, 3(6), pp. 26–37.
- [4] M. Tsili and S. Papathanassiou, "A review of grid code technical requirements for wind farms," *IET Renewable Power Generation*, vol. 3, pp. 308-332, Mar. 2009.
- [5] M. Altin, O. Goksu, R. Teodorescu, P. Rodriguez, B. B. Jensen and L. Helle, "Overview of recent grid codes for wind power integration," in *Proc. 12th International Conference on Optimization of Electrical and Electronic Equipment (OPTIM)*, pp. 1152-1160, 2010.
- [6] M. Chinchilla, S. Arnaltes, and J. C. Burgos, "Control of permanent-magnet generators applied to variable-speed wind-energy systems connected to the grid," *IEEE Trans. Energy Convers.*, vol. 21, no. 1, pp. 130–135, May. 2006.
- [7] J. Morren, Sjoerd W. H. de Haan, Wil L. Kling and J. A. Ferreira, "Wind turbines emulating inertia and supporting primary frequency control," *IEEE Trans. Power System*, vol. 21, no. 1, pp. 433-434, Feb. 2006.
- [8] R. de Almeida, E. D. Castronuovo and J. A. Pecos Lopes, "Optimum generation control in wind parks when carrying out system operator requests," *IEEE Trans. Power System*, vol. 21, no. 2, pp. 718-725, May. 2006.
- [9] N. R. Ullah, T. Thiringer and D. Karlsson, "Temporary primary frequency control support by variable speed wind turbines – Potential and Applications," *IEEE Trans. Power Systems*, vol. 23, no. 2, pp. 601-612, May. 2008.
- [10] C. Su and Z. Chen, "Influence of Wind Plant Ancillary Frequency Control on System Small Signal Stability," in *Proc. PES General Meeting*, pp. 1-8, 2012.
- [11] P. Giroux, G. Sybille, and H. Le-Huy, "Modeling and simulation of a distribution STATCOM using simulink's power system blockset," in *Proc. 27th Annual Conf. IEEE Industrial Electronics Society*, Denver, USA, Nov. 2001, pp. 990–994.
- [12] G.D. Moor, and H.J. Beukes, "Maximum power point trackers for wind turbines," in *Proc. of 35th Annual IEEE Power Electronics Specialists Conference*, Aachen, Germany, Jun. 2004, pp. 2044–2049.
- [13] M. Chinchilla, S. Arnaltes, and J. C. Burgos, "Control of permanent-magnet generators applied to variable-speed wind-energy systems connected to the grid," *IEEE Trans. Energy Convers.*, vol. 21, no. 1, pp. 130–135, May. 2006.
- [14] T. Burton, D. Sharpe, N. Jenkins, and E. Bossanyi, *Wind energy handbook*. New York: Wiley 2001.
- [15] T. Sun, Z. Chen, and F. Blaabjerg, "Flicker study on variable speed wind turbines with doubly fed induction generators," *IEEE Trans. Energy Convers.*, vol. 20, no. 4, pp. 896–905, Dec. 2005.
- [16] B. Lucus, L. F. Castro Ribeiro and P. Brown. *Load-Frequency Control UCTE Operation Handbook*. [Online]. Available: <http://paginas.fe.up.pt/~fmb/DESE/Trabalhos/DESE-ManualDoGestor.pdf>
- [17] European Network of Transmission System Operators for Electricity. (2009). Load-Frequency Control and Performance. [Online], Available: https://www.entsoe.eu/fileadmin/user_upload/_library/publications/ce/oh/Policy1_final.pdf
- [18] J. R. Pillai and B. Bak-Jensen, "Integration of vehicle-to-grid in the western Danish power system," *IEEE Trans. Sustainable Energy*, vol. 2, no. 1, pp. 12–19, Jan. 2011.
- [19] T. Gjengedal, "System control of large scale wind power by use of automatic generation control (AGC)," in *Proc. 2003 CIGRE/PES Quality and Security of Electric Power Delivery Systems*, pp. 15-21, Oct. 2003.
- [20] M. A. Pai, *Energy Function Analysis for Power System Stability*. Norwell, MA: Kluwer, 1989.