



Aalborg Universitet

AALBORG UNIVERSITY
DENMARK

Characterization of the Airflow from a Bottom Hung Window under Natural Ventilation

Svidt, Kjeld; Heiselberg, Per; Nielsen, Peter V.

Publication date:
2000

Document Version
Publisher's PDF, also known as Version of record

[Link to publication from Aalborg University](#)

Citation for published version (APA):
Svidt, K., Heiselberg, P., & Nielsen, P. V. (2000). *Characterization of the Airflow from a Bottom Hung Window under Natural Ventilation*. Dept. of Building Technology and Structural Engineering, Aalborg University. Indoor Environmental Engineering Vol. R0041 No. 116

General rights

Copyright and moral rights for the publications made accessible in the public portal are retained by the authors and/or other copyright owners and it is a condition of accessing publications that users recognise and abide by the legal requirements associated with these rights.

- Users may download and print one copy of any publication from the public portal for the purpose of private study or research.
- You may not further distribute the material or use it for any profit-making activity or commercial gain
- You may freely distribute the URL identifying the publication in the public portal -

Take down policy

If you believe that this document breaches copyright please contact us at vbn@aub.aau.dk providing details, and we will remove access to the work immediately and investigate your claim.

Characte

Characterization of the
Airflow from a Bottom
Hung Window under
Natural Ventilation

K. Svidt, P. Heiselberg, P.V. Nielsen

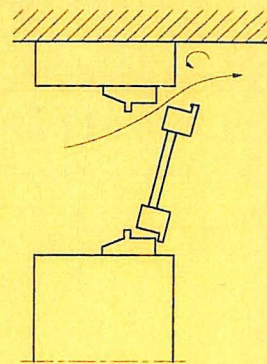

Paper No 116

Indoor Environmental Engineering

In: Proceedings of ROOMVENT 2000, 7th International
Conference on Air Distribution in Rooms, Reading, UK,
July 9-12, 2000, Vol. II, pp. 755-760

The *Indoor Environmental Engineering* papers are issued for early dissemination of research results from the Indoor Environmental Engineering Group at the Department of Building Technology and Structural Engineering, Aalborg University. These papers are generally submitted to scientific meetings, conferences or journals and should therefore not be widely distributed. Whenever possible, reference should be given to the final publications (proceedings, journals, etc.) and not to the Indoor Environmental Engineering papers.

Characterization of the
Airflow from a Bottom
Hung Window under
Natural Ventilation

K. Svidt, P. Heiselberg, P.V. Nielsen



CHARACTERIZATION OF THE AIRFLOW FROM A BOTTOM HUNG WINDOW UNDER NATURAL VENTILATION

Kjeld Svidt, Per Heiselberg and Peter V. Nielsen

Department of Building Technology and Structural Engineering, Aalborg
University, Sohngaardsholmsvej 57, 9000 Aalborg, Denmark

ABSTRACT

For natural ventilation of rooms there is a wide range of possibilities with regard to the selection of window type, size and location. A bottom hung window mounted near the ceiling is often used as it has proved to work well with regard to draught risk and thermal comfort in the room. However, there is a need for more detailed information on the performance of this and other types of windows to make it possible to use improved design methods for natural ventilation systems.

This paper describes the results of laboratory measurements of the airflow from a bottom hung window mounted near the ceiling of a ventilated room. In the laboratory set-up it was possible to control the temperature difference and the airflow rate through the window. The pressure drop through the window was measured as well as the velocity distribution in the incoming airflow. Airflow patterns and penetration depth of a cold jet were studied with smoke visualisation.

KEYWORDS

Natural ventilation, windows, air velocity, air distribution, cold jet, penetration depth, full-scale laboratory measurements.

INTRODUCTION

In buildings ventilated by natural or hybrid ventilation the air is often supplied and in some cases exhausted through open windows. There is a need for information on the performance of such windows to make it possible to use improved design methods for natural ventilation systems. This study focuses on the airflow from a bottom hung window which acts as an inlet only, i.e. no air is exhausted through the window. The window is tested at different opening sizes, inlet velocities and different indoor and outdoor temperatures. Velocity characteristics of the inlet air jet have been studied under isothermal conditions and penetration depth of the jet has been studied under non-isothermal conditions.

LABORATORY SET-UP

The investigations are performed in a laboratory test room with the size of Length \times Width \times Height = 8 m \times 6 m \times 3 m, a plane view of the room is shown in Figure 1. The room is divided into two separate rooms by an insulated wall. The small room can be cooled, while the large room can be kept at normal room temperature with a floor heating system. The bottom hung window is mounted in the insulated wall 10 cm below the ceiling (Figure 2). Another window is also mounted in the wall for other purposes (measurements by Heiselberg et al. 1999, 2000). Three different opening areas have been studied. The opening areas were defined as a slot width of 10 mm, 15 mm and 30 mm (see Figure 3 for details).

The pressure difference between the two rooms is measured by pressure taps mounted 20 cm below the ceiling beside the window. In the non-isothermal experiments the small room is continuously ventilated by cold air at a flow rate of 1500 m³/h. The airflow rate through the window is controlled by valves in the supply and exhaust ducts. The actual flow rate is determined from previously measured pressure characteristics of the window and leakage characteristics of the room (Heiselberg et al. 1999, 2000).

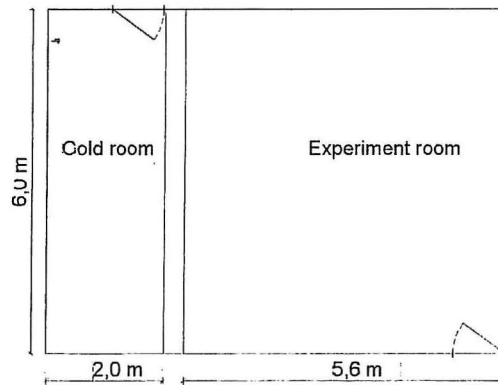

Figure 1: The test room is divided into a cold room simulating outdoor conditions and an experiment room with normal room temperature. The window is mounted in the insulated wall between the rooms.

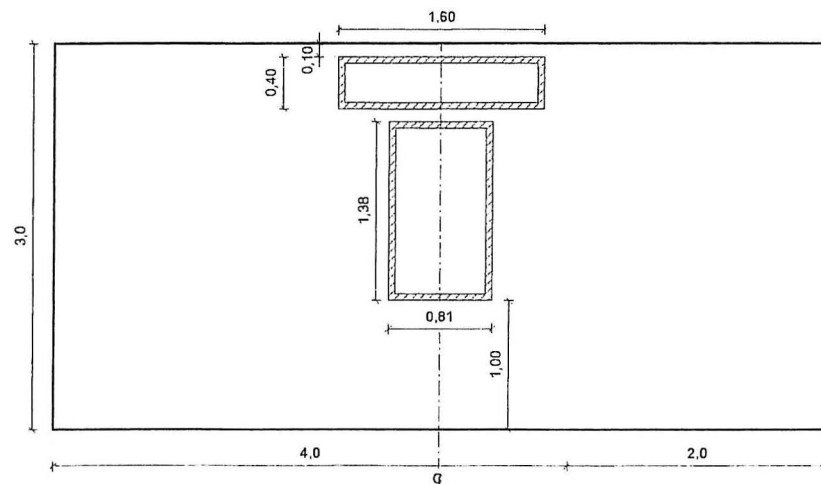

Figure 2: The bottom hung window is mounted in the insulated wall 10 cm below the ceiling. Another window is also mounted in the wall for other purposes.

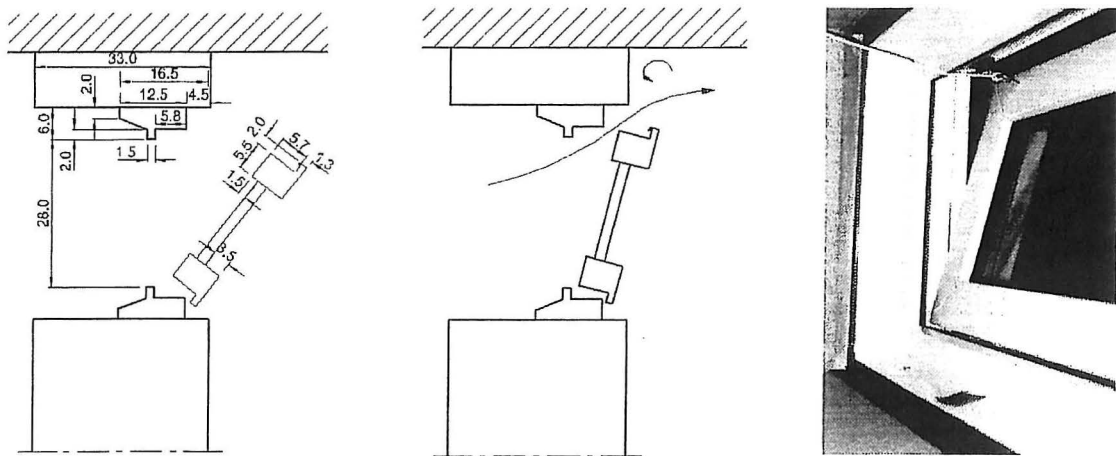

Figure 3: Section view with details of the window (left), the slot width is measured at the narrowest passage for the flow (in the middle), photo from outside of the window with 30 mm slot opening (right).

RESULTS

Isothermal measurements

Under isothermal conditions the inlet flow from the window will form a three-dimensional wall jet along the ceiling. It is assumed that the maximum velocity in the jet follows Eqn. (1):

$$\frac{u}{u_o} = K_a \frac{\sqrt{a_o}}{x - x_o} \quad (1)$$

where

- u is the maximum velocity at the distance x from the inlet [m/s]
- $u_o = (2\Delta p/\rho)^{0.5}$ is the calculated inlet velocity [m/s]
- $a_o = q/u_o$ is the effective opening area of the window [m²]
- K_a is a constant related to the opening
- x_o is a virtual origin of the jet [m]
- Δp is the pressure difference between the rooms [Pa]
- ρ is the density of the incoming air [kg/m³]
- q is the airflow rate through the window [m³/h]

The wall jet thickness is assumed to follow Eqn. (2):

$$\frac{\delta_y}{\sqrt{a_o}} = D_{ay} \frac{x - x_{oy}}{\sqrt{a_o}} \quad (2)$$

where δ_y is the wall jet thickness at the distance x from the inlet. It is defined as the distance from the ceiling to the height where the velocity is 50% of u . With respect to wall jet thickness the virtual origin is x_{oy} and D_{ay} is the growth rate.

Velocity profiles of the wall jet have been measured at eight different distances from the inlet. By rearranging equation 1 the characteristic constants of the jet can be determined graphically as shown in Figure 4. The measurements were performed for two different slot openings h and two different inlet velocities. Table 1 shows the results. There is some variation in the values of K_a and x_o . If x_o is fixed to be -2.0 m there is less variation in the calculated values of K_a as shown in the table.

TABLE 1
RESULTS OF THE ISOTHERMAL MEASUREMENTS

Exp. no	h [mm]	Δp [Pa]	a_o [m ²]	K_a	x_o [m]	$K_a @ x_o = -2.0$	D_{ay}	x_{oy}
1	15	12	.0236	6.1	-1.6	6.6	.077	-.75
2	15	6	.0222	7.9	-2.5	7.1	.077	-.92
3	30	6	.0396	7.5	-1.9	7.6	.083	-.42
4	30	2.2	.0368	8.1	-2.3	7.6	.073	-.90

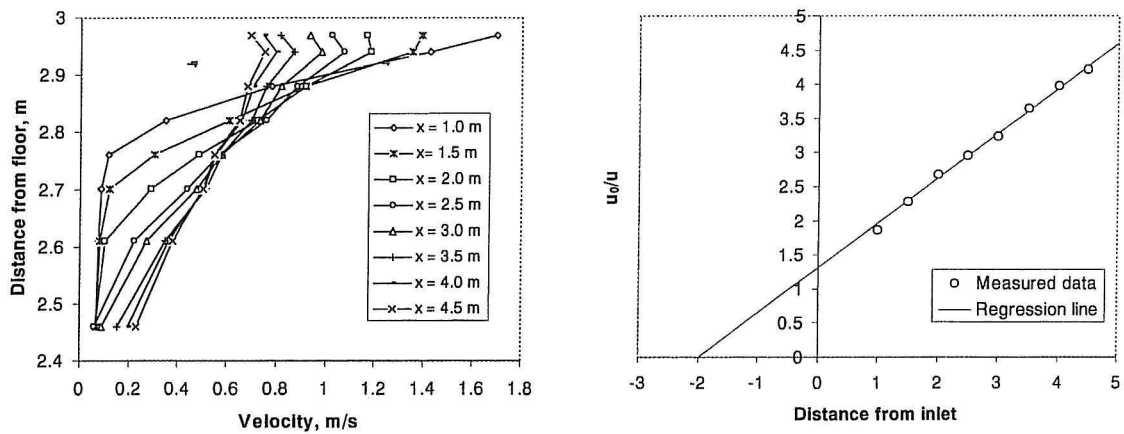

Figure 4: Isothermal experiment no 3. Velocity profiles in the centreline of the room (left). K_a and x_o are determined from the regression line (right).

Non-isothermal measurements

Under non-isothermal conditions the penetration depth of the cold jet has been studied. 55 experiments have been performed at three different slot openings and a number of different inlet velocities as well as two different temperature differences. During each experiment the pressure difference between the rooms is recorded as well as the air temperature in a number of positions in each room. The penetration depth is determined by adding smoke to the air outside the window (Figure 5). Each smoke experiment has been videotaped for documentation.

As described by Nielsen et al. (1987) the penetration depth is expected to follow Eqn. (3):

$$\frac{x_s - x_{oy}}{\sqrt{a_o}} = K \sqrt{\frac{u_o^2}{\Delta T_o \sqrt{a_o}}} \quad (3)$$

where x_s is the penetration depth and ΔT_o is the temperature difference between inside and outside.

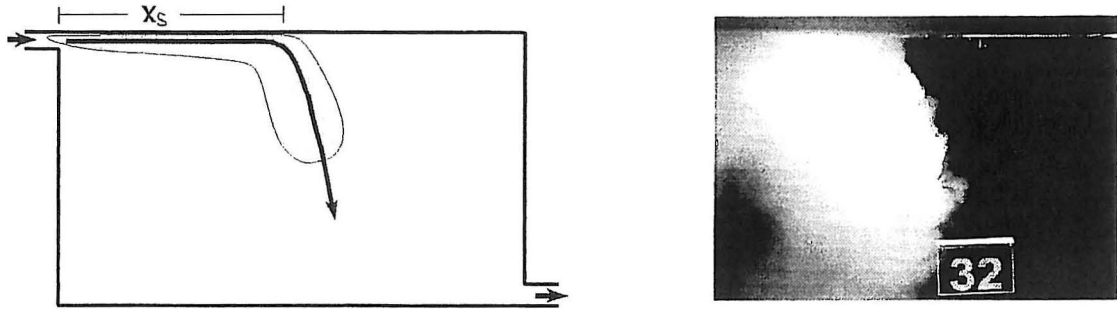

Figure 5: The jet penetrates to the distance x_s (left). Photo from smoke experiment no 32 shows where the jet no longer attaches to the ceiling (right).

The measured results are plotted in figure 6. It shows that the data fit well with Eqn. (3) within each slot opening. However, it is clear that the curves for each opening differ from each other although the opening area is included in the equation. A possible explanation is that not only the opening area changes when the window is opened more or less, but also the direction of the incoming air is changed.

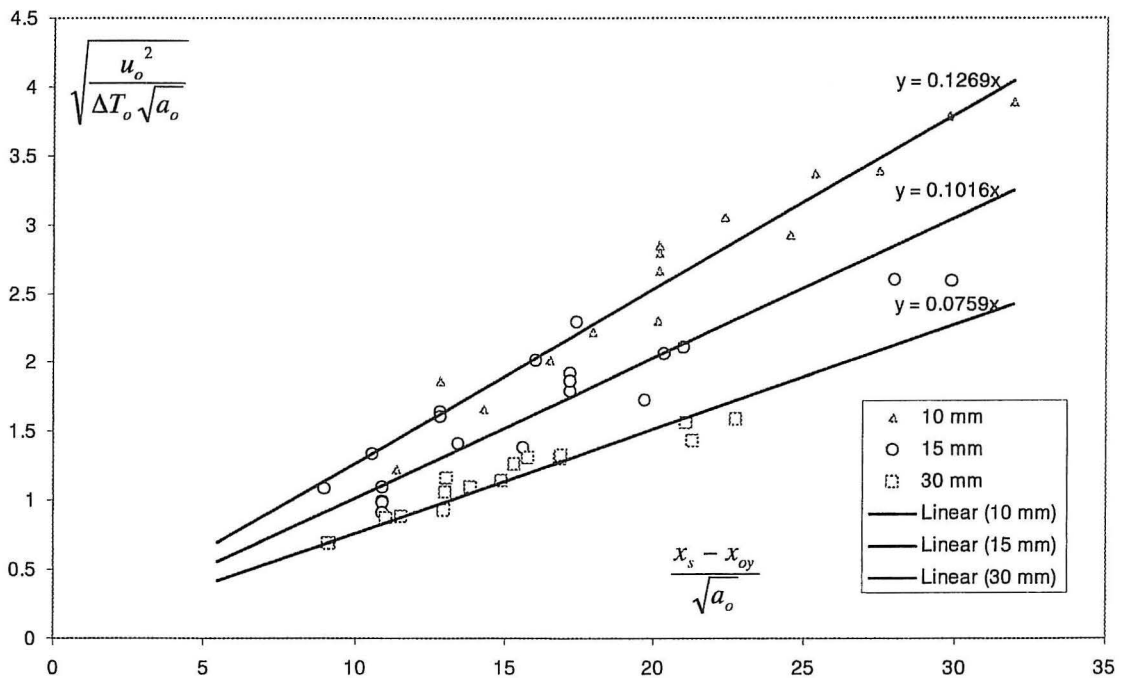

Figure 6: Penetration depth results for slot openings 10 mm, 15 mm and 30 mm.

CONCLUSION

The airflow from a bottom hung window has been analysed under isothermal and non-isothermal conditions.

It was found that the incoming air jet under isothermal conditions could be described well with traditional jet theory.

The penetration depth of a cold jet from the window matched well with an equation based on the archimedes number of the jet.

ACKNOWLEDGEMENT

This work is a part of the co-operative work within IEA-ECB&CS Annex 35, Hybrid Ventilation in New and Retrofitted Office Buildings. It has been supported by the Danish Energy Agency.

REFERENCES

Heiselberg P., Dam H., Sørensen L. C., Nielsen P. V. and Svidt K. (1999). Characteristics of Air Flow through Windows. Presented at the First International One Day Forum on Natural and Hybrid Ventilation, HybVent Forum'99, 09/1999, Sydney, Australia.

Heiselberg P., Svidt K., Nielsen PV (2000). Windows, Measurements of Air Flow Capacity. *Proceedings of ROOMVENT 2000*, July 2000, Reading, UK.

Nielsen P.V., Möller Å.T.A. (1987). Measurements on Buoyant Wall Jet Flows in Air-Conditioned rooms. *Proc. of the First International Conference on Air Distribution in Rooms. ROOMVENT '87.*

RECENT PAPERS ON INDOOR ENVIRONMENTAL ENGINEERING

PAPER NO. 109: E. Bjørn: *Simulation of Human Respiration with Breathing Thermal Manikin*. ISSN 1395-7953 R9944.

PAPER NO. 110: P. Heiselberg: *Hybrid Ventilation and the Consequences on the Development of the Facade*. ISSN 1395-7953 R0033.

PAPER NO. 111: P. Heiselberg, M. Pedersen, T. Plath: *Local Exhaust Optimization and Worker Exposure*. ISSN 1395-7953 R0034.

PAPER NO. 112: K. Svidt, P. Heiselberg: *Push-Pull Ventilation in a Painting Shop for Large Steel Constructions*. ISSN 1395-7953 R0035.

PAPER NO. 113: P. Heiselberg: *Design Principles for Natural and Hybrid Ventilation*. ISSN 1395-7953 R0036

PAPER NO. 114: A. Andersen, M. Bjerre, Z.D. Chen, P. Heiselberg, Y. Li: *Experimental Study of Wind-Opposed Buoyancy-Driven Natural Ventilation*. ISSN 1395-7953 R0037

PAPER NO. 115: P. Heiselberg, K. Svidt, P.V. Nielsen: *Windows - Measurements of Air Flow Capacity*. ISSN 1395-7953 R0040

PAPER NO. 116: K. Svidt, P. Heiselberg, P.V. Nielsen: *Characterization of the Airflow from a Bottom Hung Window under Natural Ventilation*. ISSN 1395-7953 R0041

PAPER NO. 117: Z. Yue, P.V. Nielsen: *Flow Pattern in Ventilated Rooms with Large Depth and Width*. ISSN 1395-7953 R0042.

PAPER NO. 118: P.V. Nielsen, H. Dam, L.C. Sørensen, K. Svidt, P. Heiselberg: *Characteristics of Buoyant Flow from Open windows in Naturally Ventilated Rooms*. ISSN 1395-7953 R0043.

PAPER NO. 119: P.V. Nielsen, C. Filholm, C. Topp, L. Davidson: *Model Experiments with Low Reynolds Number Effects in a Ventilated Room*. ISSN 1395-7953 R0044.

PAPER NO. 120: P. Lengweiler, P.V. Nielsen, A. Moser, P. Heiselberg, H. Takai: *Experimental Method for Measuring Dust Load on Surfaces in Rooms*. ISSN 1395-7953 R0045.

PAPER NO. 121: L. Davidson, P.V. Nielsen, C. Topp: *Low-Reynolds Number Effects in Ventilated Rooms: A Numerical Study*. ISSN 1395-7953 R0046.

PAPER NO. 122: F. Haghghat, H. Brohus, C. Frier, P. Heiselberg: *Stochastic Prediction of Ventilation System Performance*. ISSN 1395-7953 R0047.

PAPER NO. 123: H. Brohus, F. Haghghat, C. Frier, P. Heiselberg: *Quantification of Uncertainty in Thermal Building Simulation. Part 1: Stochastic Building Model*. ISSN 1395-7953 R0048.

PAPER NO. 124: H. Brohus, F. Haghghat, C. Frier, P. Heiselberg: *Quantification of Uncertainty in Thermal Building Simulation. Part 2: Stochastic Loads*. ISSN 1395-7953 R0049.

Complete list of papers: <http://iee.civil.auc.dk/i6/publ/iee.html>

Character

ISSN 1395-7953 R0041

Dept. of Building Technology and Structural Engineering

Aalborg University, December 2000

Sohngaardsholmsvej 57, DK-9000 Aalborg, Denmark

Phone: +45 9635 8080 Fax: +45 9814 8243

<http://iee.civil.auc.dk>