



Aalborg Universitet

AALBORG UNIVERSITY
DENMARK

Laboratory tests on mineral deposition under sea water electrolysis

Margheritini, Lucia; Simonsen, Morten Enggrob; Bjørgård, Trine Larsen

Publication date:
2019

Document Version
Publisher's PDF, also known as Version of record

[Link to publication from Aalborg University](#)

Citation for published version (APA):

Margheritini, L., Simonsen, M. E., & Bjørgård, T. L. (2019). *Laboratory tests on mineral deposition under sea water electrolysis*. Department of Civil Engineering, Aalborg University. DCE Technical Reports No. 268

General rights

Copyright and moral rights for the publications made accessible in the public portal are retained by the authors and/or other copyright owners and it is a condition of accessing publications that users recognise and abide by the legal requirements associated with these rights.

- Users may download and print one copy of any publication from the public portal for the purpose of private study or research.
- You may not further distribute the material or use it for any profit-making activity or commercial gain
- You may freely distribute the URL identifying the publication in the public portal -

Take down policy

If you believe that this document breaches copyright please contact us at vbn@aub.aau.dk providing details, and we will remove access to the work immediately and investigate your claim.



DEPARTMENT OF CIVIL ENGINEERING
AALBORG UNIVERSITY

Laboratory tests on mineral deposition under sea water electrolysis

**Lucia Margheritini
Morten Enggrob Simonsen
Trine Larsen Bjørgård**

Aalborg University
Department of Civil Engineering
Water and Environment

DCE Technical Report No. 268

Laboratory tests on mineral deposition under sea water electrolysis

by

Lucia Margheritini
Morten Enggrob Simonsen
Trine Larsen Bjørgård

February 2019

© Aalborg University

Published 2017 by
Aalborg University
Department of Civil Engineering
Sofiendalsvej 9-11
DK-9200 Aalborg SV, Denmark

Printed in Aalborg at Aalborg University

ISSN 1901-726X
DCE Technical Report No. 268

Recent publications in the DCE Technical Report Series

Contents

1. Introduction	2
2. Objectives	3
3. Laboratory set up.....	4
a. Equipment.....	4
b. Test plan and tested parameters	5
4. Results.....	8
a. Visualization of mineral deposition on the cathode and material collection.....	11
5. Analysis	33
6. Conclusions.....	35
7. References	36

1. Introduction

This report is prepared to document the first phase of the project “**New material for wave energy sub-structures**”. Funding body: Energiteknologisk Udviklings- og Demonstrations Program (EUDP) . Area: wave energy and new sustainable materials for marine environment. Leading: Aalborg University Civil and Chemical, Esbjerg (DK). Other Partners: Resen waves (DK), Electrocell (DK), Wave Piston (DK), Biorok.inc.(USA). Case number: 50520010

The purpose of the project is to demonstrate the feasibility of Biorock Technology in cold waters, characterize the resulting material and indicate applicability areas.

Electrodeposition of calcium carbonate (CaCO₃) on steel structures have been suggested as an environmentally friendly method for production of a subsea construction material. The deposited material has similar mechanical properties as concrete (Goreau 2012) and the material is continuously deposited as long as current is applied. As current is applied to the steel structure it is not prone to corrosion although it is placed in corrosive seawater.

When electrolysis is carried out in seawater the following reactions can take place at the anode and cathode, respectively.

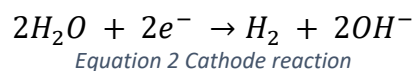
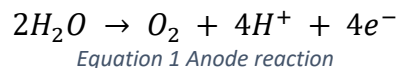

The reduction of water taking place at the cathode results in an increase of pH close to the cathode surface. When the pH increases the carbonate equilibrium is shifted towards carbonate (CO₃²⁻), and CaCO₃ precipitates at the surface of the electrode (Karoui et al. 2013).

CaCO₃ can form two different polymorphs at typical seawater conditions, aragonite and calcite. Preliminary experiments has shown that increasing the current above a certain level results in electrodeposition of magnesium hydroxide (Mg(OH)₂, brucite) rather than CaCO₃. The deposition of brucite takes place when the pH of the surface of the electrode reaches 9.2 (Barchiche et al. 2004). Because the main interest of the partners revolves around structures and Aragonite has a higher hardness compared to Brucite, (Mohs scale hardness: 3.5-4 vs 2.5 to 3), the latest one has been considered less desirable.

2. Objectives

The ultimate purpose of the EUDP project is to investigate the possibility of producing a construction material under sea water electrolysis from the mineral deposition accumulated over the cathode. As we know from literature (Goreau 2012), mainly three different kinds of materials can be obtained: Aragonite and Brucite and Calcite.

Brucite is friable and brittle and we decided to focus on the production of Aragonite in these first investigations, because, given its mechanical properties ((Goreau 2012), carrying loads, hardness...) it is more interesting for the purpose.

This report describes the results from the parametric experiments that were carried out from April to November 2018 at the Chemical Engineering Laboratories of Aalborg University, Esbjerg.

The objectives of the study are:

- 1) To design and realize a laboratory setup (experimental facility) for the investigation of mineral deposition in controlled environment.
- 2) To understand the influence of different parameters on the process of the mineral deposition over a cathode after sea water electrolysis. These parameters are: temperature, sea water composition (conductivity), anode material and applied electrical current.
- 3) To analyze the chemical composition of the mineral deposition using X-ray diffraction (XRD). XRD data are used in Rietveld refinement to find the percentage of aragonite, calcite or brucite.
- 4) To quantify the deposition in time
- 5) To investigate the reproducibility of the results
- 6) To define the governing conditions for the production of Aragonite

3. Laboratory set up

a. Equipment

The setup for electrodeposition of CaCO_3 from seawater consisted of a plastic tank (20 x 20 x 31 cm), containing approximately 9 L of water, with stirring, water inlet and outlet and a pump for water exchange. The water inlet was placed 4 cm from the bottom of the tank, while the outlet was placed 15 cm from the bottom. The tank was either placed in room temperature or in a fridge, depending on the temperature of the experiment. The experimental setups for room tempered water and cold water are shown in Figure 3.

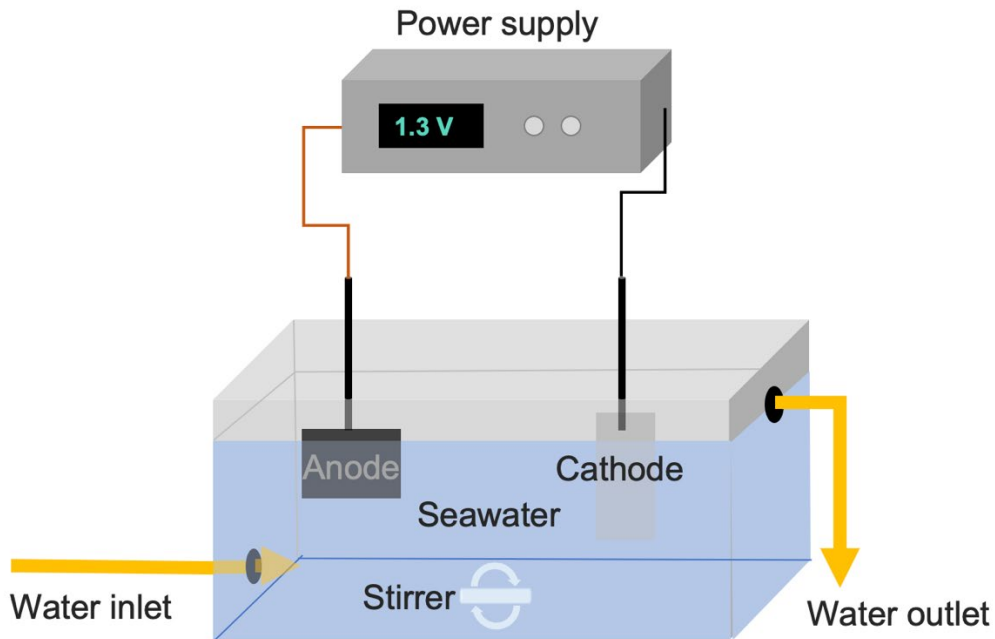

Figure 1 Overview of experimental setup

The pump used in the experiments was a Masterflex peristaltic tubing pump, as shown in Figure 2, pumping water at a flowrate of 300 mL/h. Two pump heads were connected to each pump, supplying to experimental setups with water. Two similar pumps were used in the experiment with the capacity of supplying four experimental setups in total.



Figure 2 Masterflex peristaltic tubing pump

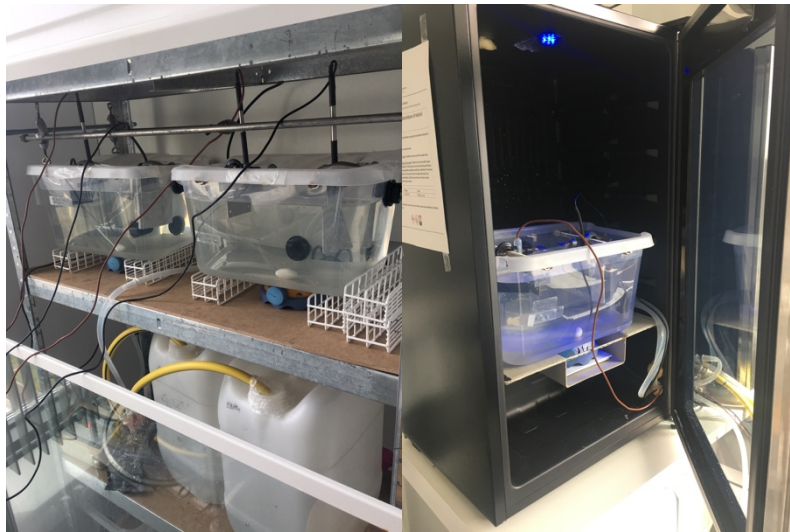

Figure 3 Experimental setup in room temperature and cold water, respectively

The power supply used to supply the experimental setup with power was a Powerbox LBX 30-200 Digital DC Power Supply (0-30 V, 0-200 A) as shown in Figure 4. The electrodes were connected to the power supply with bolts through a metal ring in the end of the electrode cable. Up to four experiments were connected to the power supply. The power supply made it possible to run experiments at either constant current (voltage is varied) and at constant voltage (current is varied). The experiments described in this report were running at constant current, as it was seen as convenient to have a constant current density at the cathode for production of electrodeposited mineral material.



Figure 4 Power supply

b. Test plan and tested parameters

Two current levels were tested during the experiments. From preliminary experiments it has been found that a constant applied current of 0.25 A made it possible to produce aragonite, and this was chosen as the low level. After the first run of samples at 0.25 A it was observed that the material consisted of more brucite than aragonite. It was therefore decided to reduce the low level of the experiments to 0.22 A. Application of current lower than this level resulted in no mineral deposition. The high-level current is level where it is expected that brucite will be precipitated, and it was known from preliminary experiments that application of 0.31 A was within the range where brucite could be produced.

Synthetic seawater of two compositions was prepared for the experiments. One was prepared according to American Society of Testing and Materials (ASTM) standard seawater solution (ASTM D1114-98), while the other had the local concentration of Mg^{2+} and Ca^{2+} (later referred to as ESBJ). The compositions of the two seawater solutions are given in **Error! Reference source not found.**

Table 1 Composition of artificial seawater used in experiments

Component	ASTM	Local (ESBJ)
NaCl	24.53 g/L	24.53 g/L
MgCl ₂	5.20 g/L	3.17 g/L
Na ₂ SO ₄	4.09 g/L	4.09 g/L
CaCl ₂	1.16 g/L	0.942 g/L
KCl	0.695 g/L	0.695 g/L
NaHCO ₃	0.201 g/L	0.201 g/L

The synthetic seawater was prepared in batches of 10 L. NaCl, Na₂SO₄, KCl and NaHCO₃ were dissolved in 1 L deionized water, MgCl₂ was dissolved in 2 or 3 L of water for ASTM and ESBJ, respectively, and CaCl₂ was dissolved in 1 L deionized water. This procedure was necessary to avoid salt precipitation during preparation. When all the salts were dissolved they were mixed together in deionized water to a total of 10 L, followed by a pH adjustment to 8.2 by addition of 0.1 M NaOH.

Two temperature levels, 7°C (low level) and room temperature (22°C, high level). The low level is a typical temperature of the local seawater, while the high temperature is in the range where electrodeposition has been described in the literature.

The anodes used in electrolysis reaction need to be inert in order not to be consumed during the reaction. Two electrode materials were tested, dimensionally stable anode (DSA) optimized for the oxygen reaction and a platinum covered titanium anode (Pt-Ti). The DSA anode consisted of a titanium plate covered with mixed metal oxides. Both anodes are manufactured for the purpose of electrolysis and were provided by ElectroCell. The area of the anode immersed in the seawater was 9.5 x 4.6 x 0.2 cm giving a surface area of 73.6 cm². The anode was ensembled as shown in Figure 5. The connection between the anode and the cable were moulded in silicone as water contact with the connection would corrode it and eventually break it.

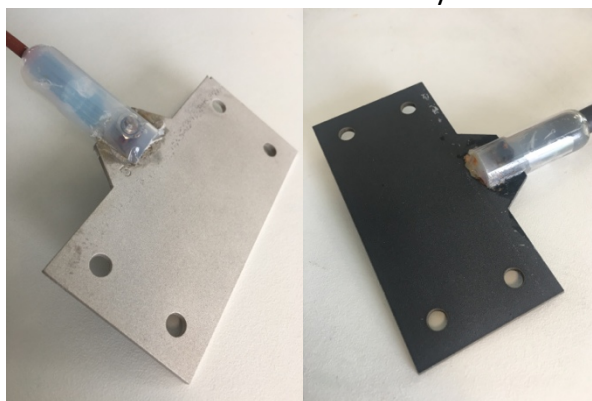

Figure 5 Pt-Ti anode and DSA anode

The cathodes were 2 mm carbon steel plates cut into pieces measuring 6 x 10 mm. To ensure that the same cathode surface area is immersed in water, silicone was added to the 2 upper cm of the cathode avoiding this part to react with the seawater. A hole was drilled within this silicon cover for the connection of the cathode to the power supply. The total surface area of the cathode was 100.4 cm².

Before the experiment was started the cathodes were pretreated at constant voltage for 24 h to make an initial material layer. This initial layer was required to increase the resistance in the system to achieve the required voltage at a given applied current. The procedure for the pretreatment was preparation of approximately 3 L of ASTM seawater solution for each cathode that was to be pretreated. There was no flow of water during these 24 h. DSA anodes were always used for pretreatment, and it was running at constant voltage of 2.2 V.

The experiments were divided into “groups” of four that were connected to the same power supply and run simultaneously at the same applied current (Table 1). Two experiments were running at low temperature while the other two used the setup at room temperature. The water composition and the electrode materials were randomly distributed between the experiments. Each experiment lasted for 14 days. For a total of 20 experiments (21 if we consider 5NY).

Some of the experiments had to be repeated as the applied current was too high to produce aragonite (0.25 A). These experiments were repeated (marked N) at 0.22 V. Material produced applying 0.25 A was only analyzed once, while the other samples were analyzed three times on the XRD.

Table 2. Summary of experiments

Group 1	Run: 1, 5, 20, 32	I = 0.31 A
Group 2	Run: 2, 3, 7, 8	I = 0.25 A
Group 3	Run: 9, 10, 11, 12	I = 0.31 A
Group 4	Run: 13, 15, 22, 26	I = 0.22 A
Group 2 - Rerun	Run: 2N, 3N, 7N, 8N	I = 0.22 A
Replicate Run 5	Run: 5NY	I = 0.31 A

4. Results

After 14 days of testing, the cathode was removed from the tank. The cathodes were washed in demineralized water to avoid deposition of crystals from the synthetic seawater (e.g. NaCl) on top of the electrodeposited material during drying. The cathodes were drying for minimum 24 hours before the weight of the material was measured using a four-digit laboratory scale. The weight of the cathodes including the deposited material was measured and the weight of the cathodes were subtracted to obtain the weight of the electrodeposited material. Following, pictures were taken and the deposited material, and it was removed using a stainless-steel laboratory spatula. The removed material was grinded using a mortar and pestle to obtain a fine powder for XRD analysis.

The powder was analysed using XRD (PANalytical AERIS) illustrated in Figure 8. The samples were scanned from at the detector angle from $15-90^\circ\theta$. The XRD results were used to identify the components the produced material consisted of, and was followed by Rietveld refinement to find the distribution of the components. All samples were analysed three times with a few expectations (stated in Table 4 to Table 24).

When sufficient amounts of material were available a tablet was prepared as shown in Figure 6, but if less material was available the powder were spread on a zero-background plate shown in Figure 7.



Figure 6 Tablet prepared for XRD analysis



Figure 7 Powder sample prepared for XRD



Figure 8 XRD instrument

The results of the laboratory experiments are here presented in terms of material composition, and weight after 14 days of testing (Table 3). Three different constant currents were applied in the experiments, 0.22 A, 0.25 A and 0.31 A. The corresponding voltage ranged from 2.05-3.20 V depending on the experimental conditions.

In the next Section, images and relevant annotations for each of the 21 runs are presented.

Table 3. Results overview.

Run	Anode	Temperature [°C]	Constant current [A]	Water	Material weight [g]	Material composition
1	DSA	7	0.31	ASTM	<u>3.9815</u>	A: 2.6 % B: 97.3 % C: 0.0 %
2	DSA	22	0.25	ASTM	<u>2.6434</u>	A: 58.9 % B: 40.9 % C: 0.2 %
2N	DSA	22	0.22	ASTM	<u>2.7212</u>	A: 44.1 % B: 55.9 % C: 0.0 %
3	Pt-Ti	22	0.25	ESBJ	<u>3.7891</u>	A: 6.8 % B: 93.2 % C: 0.0 %
3N	Pt-Ti	22	0.22	ESBJ	<u>2.5981</u>	A: 49.1 % B: 50.8 % C: 0.1 %
5	Pt-Ti	22	0.31	ASTM	<u>3.4643</u>	A: 28.8% B: 71.1 % C: 0.0 %
5NY	Pt-Ti	22	0.31	ASTM	<u>12.9968</u>	A: 0.2% B: 99.8 % C: 0.0 %
7	Pt-Ti	7	0.25	ASTM	<u>2.3055</u>	A: NA B: NA

						C: NA
7N	Pt-Ti	7	0.22	ASTM	<u>2.0922</u>	A: 75.9 % B: 24.1 % C: 0.0 %
8	DSA	7	0.25	ESBJ	<u>2.8110</u>	A: 35.7 % B: 64.3 % C: 0.0 %
8N	DSA	7	0.22	ESBJ	<u>1.9526</u>	A: 41.5 % B: 58.3 % C: 0.2 %
9	Pt-Ti	7	0.31	ESBJ	<u>3.0697</u>	A: 30.0 % B: 69.9 % C: 0.0 %
10	DSA	7	0.31	ESBJ	<u>2.6577</u>	A: 14.7 % B: 85.3 % C: 0.0 %
11	DSA	22	0.31	ASTM	<u>9.8694</u>	A: 1.5 % B: 98.5 % C: 0.0 %
12	Pt-Ti	22	0.31	ESBJ	<u>3.4800</u>	A: 22.0 % B: 78.0 % C: 0.0 %
13	DSA	7	0.22	ASTM	<u>0.9534</u>	A: 80.4 % B: 19.5 % C: 0.0 %
15	DSA	22	0.22	ESBJ	<u>2.8917</u>	A: 21.3 % B: 78.6 % C: 0.1 %
20	DSA	22	0.31	ESBJ	<u>8.0931</u>	A: 2.7 % B: 97.2 % C: 0.0 %
22	Pt-Ti	7	0.22	ESBJ	<u>1.3819</u>	A: 81.0 % B: 19.0 % C: 0.0 %
26	Pt-Ti	22	0.22	ASTM	<u>0.9650</u>	A: 99.4 % B: 0.6 % C: 0.0 %
32	Pt-Ti	7	0.31	ASTM	<u>2.9358</u>	A: 36.0 % B: 63.9 % C: 0.0 %

A: Aragonite, B: Brucite, C: Calcite

a. Visualization of mineral deposition on the cathode and material collection



We include here visual reports of the material deposited on the cathodes (one picture for each side), its collection and appearance after grinding, before weighting and XRD analysis of each of tests listed in Table 2.

For each test we indicate:

- tested parameters,
- weight of mineral deposition
- mineral composition after XRD (average of three XRD measurements of sample)

Run 1

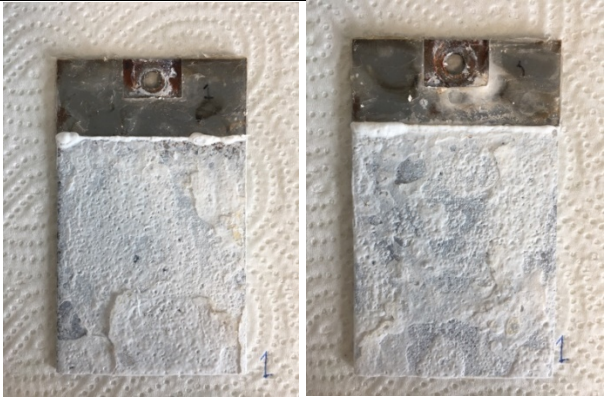
Table 4. Run 1

		<table border="1"> <thead> <tr> <th>Parameter</th> <th>Value</th> </tr> </thead> <tbody> <tr> <td>Temperature</td> <td>7 C</td> </tr> <tr> <td>Water</td> <td>ASTM</td> </tr> <tr> <td>Anode</td> <td>DSA</td> </tr> <tr> <td>Current</td> <td>0.31 A</td> </tr> <tr> <td>Start/end voltage</td> <td>2.40 V/2.43 V</td> </tr> </tbody> </table>		Parameter	Value	Temperature	7 C	Water	ASTM	Anode	DSA	Current	0.31 A	Start/end voltage	2.40 V/2.43 V
Parameter	Value														
Temperature	7 C														
Water	ASTM														
Anode	DSA														
Current	0.31 A														
Start/end voltage	2.40 V/2.43 V														
		<table border="1"> <thead> <tr> <th>Weight bf. [g]</th> <th>Weight af. [g]</th> <th>Weight gain [g]</th> </tr> </thead> <tbody> <tr> <td><u>99.4571</u></td> <td><u>103.4386</u></td> <td><u>3.9815</u></td> </tr> </tbody> </table>	Weight bf. [g]	Weight af. [g]	Weight gain [g]	<u>99.4571</u>	<u>103.4386</u>	<u>3.9815</u>							
Weight bf. [g]	Weight af. [g]	Weight gain [g]													
<u>99.4571</u>	<u>103.4386</u>	<u>3.9815</u>													
	<table border="1"> <thead> <tr> <th></th> <th>% Aragonite</th> <th>% Brucite</th> <th>% Calcite</th> </tr> </thead> <tbody> <tr> <td>Avg</td> <td>2.6</td> <td>97.3</td> <td>0.0</td> </tr> <tr> <td>SD</td> <td>1.8</td> <td>1.8</td> <td>0.1</td> </tr> </tbody> </table>		% Aragonite	% Brucite	% Calcite	Avg	2.6	97.3	0.0	SD	1.8	1.8	0.1		
	% Aragonite	% Brucite	% Calcite												
Avg	2.6	97.3	0.0												
SD	1.8	1.8	0.1												

1.0380 g removed for XRD analysis corresponding to the material at one side of the cathode. The material is white and relatively thick. It was surprisingly hard to remove the material compared to the other cathodes.

Run 2

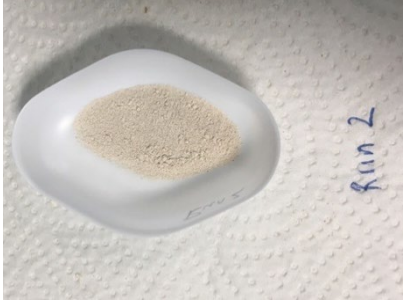

Table 5. Run 2

		<table border="1"> <thead> <tr> <th>Parameter</th> <th>Value</th> </tr> </thead> <tbody> <tr> <td>Temperature</td> <td>22 C</td> </tr> <tr> <td>Water</td> <td>ASTM</td> </tr> <tr> <td>Anode</td> <td>DSA</td> </tr> <tr> <td>Current</td> <td>0.25 A</td> </tr> <tr> <td>Start/end voltage</td> <td>2.05 V/2.37 V</td> </tr> </tbody> </table>		Parameter	Value	Temperature	22 C	Water	ASTM	Anode	DSA	Current	0.25 A	Start/end voltage	2.05 V/2.37 V
Parameter	Value														
Temperature	22 C														
Water	ASTM														
Anode	DSA														
Current	0.25 A														
Start/end voltage	2.05 V/2.37 V														
		<table border="1"> <thead> <tr> <th>Weight bf. [g]</th> <th>Weight af. [g]</th> <th>Weight gain [g]</th> </tr> </thead> <tbody> <tr> <td><u>100.0798</u></td> <td><u>102.7232</u></td> <td><u>2.6434</u></td> </tr> </tbody> </table>		Weight bf. [g]	Weight af. [g]	Weight gain [g]	<u>100.0798</u>	<u>102.7232</u>	<u>2.6434</u>						
Weight bf. [g]	Weight af. [g]	Weight gain [g]													
<u>100.0798</u>	<u>102.7232</u>	<u>2.6434</u>													
		<table border="1"> <thead> <tr> <th></th> <th>% Aragonite</th> <th>% Brucite</th> <th>% Calcite</th> </tr> </thead> <tbody> <tr> <td>Avg</td> <td>58.9*</td> <td>40.9*</td> <td>0.2*</td> </tr> <tr> <td>SD*</td> <td></td> <td></td> <td></td> </tr> </tbody> </table>			% Aragonite	% Brucite	% Calcite	Avg	58.9*	40.9*	0.2*	SD*			
	% Aragonite	% Brucite	% Calcite												
Avg	58.9*	40.9*	0.2*												
SD*															
		<p>*The sample was analyzed once, statistics could not be calculated.</p>													

Material from Run 2. Large flakes that is easily removed. White material under the outer flakes. The layers are white with some brown-orange color, and probably iron (rust) from the cathode. The cathode seems to have been relatively well corrosion protected. 0.9042 g of material (mainly from the material surface) was removed and used for XRD analysis.

Run 3



Table 6 Run 3

		<table border="1"> <thead> <tr> <th>Parameter</th> <th>Value</th> </tr> </thead> <tbody> <tr> <td>Temperature</td> <td>22 C</td> </tr> <tr> <td>Water</td> <td>ESBJ</td> </tr> <tr> <td>Anode</td> <td>Pt-Ti</td> </tr> <tr> <td>Current</td> <td>0.25 A</td> </tr> <tr> <td>Start/end voltage</td> <td>2.05 V/2.37 V</td> </tr> </tbody> </table>		Parameter	Value	Temperature	22 C	Water	ESBJ	Anode	Pt-Ti	Current	0.25 A	Start/end voltage	2.05 V/2.37 V
Parameter	Value														
Temperature	22 C														
Water	ESBJ														
Anode	Pt-Ti														
Current	0.25 A														
Start/end voltage	2.05 V/2.37 V														
		<table border="1"> <thead> <tr> <th>Weight bf. [g]</th> <th>Weight af. [g]</th> <th>Weight gain [g]</th> </tr> </thead> <tbody> <tr> <td><u>100.7363</u></td> <td><u>104.5254</u></td> <td><u>3.7891</u></td> </tr> </tbody> </table>		Weight bf. [g]	Weight af. [g]	Weight gain [g]	<u>100.7363</u>	<u>104.5254</u>	<u>3.7891</u>						
Weight bf. [g]	Weight af. [g]	Weight gain [g]													
<u>100.7363</u>	<u>104.5254</u>	<u>3.7891</u>													
		<table border="1"> <thead> <tr> <th></th> <th>% Aragonite</th> <th>% Brucite</th> <th>% Calcite</th> </tr> </thead> <tbody> <tr> <td>Avg</td> <td>6.8*</td> <td>93.2*</td> <td>0.0*</td> </tr> <tr> <td>SD*</td> <td></td> <td></td> <td></td> </tr> </tbody> </table>			% Aragonite	% Brucite	% Calcite	Avg	6.8*	93.2*	0.0*	SD*			
	% Aragonite	% Brucite	% Calcite												
Avg	6.8*	93.2*	0.0*												
SD*															
		<p>*The sample was analyzed once, statistics could not be calculated.</p>													

A part of the electrode is covered by a white material. The rest of the cathode is covered by corrosion material. The thickness of the material is approximately 1 mm, and sticks out of the cathode. The white material was removed. The material is easy to remove and consist of an outer material and an inner material. The outer material is easy to remove and the inner layer is harder to remove from the cathode. 0.9471 g was removed from one side of the cathode for XRD-analysis.

Run 5



Table 7 Run 5

		<table border="1"> <thead> <tr> <th>Parameter</th> <th>Value</th> </tr> </thead> <tbody> <tr> <td>Temperature</td> <td>22 C</td> </tr> <tr> <td>Water</td> <td>ASTM</td> </tr> <tr> <td>Anode</td> <td>Pt-Ti</td> </tr> <tr> <td>Current</td> <td>0.31 A</td> </tr> <tr> <td>Start/end voltage</td> <td>2.40 V/2.43 V</td> </tr> </tbody> </table>		Parameter	Value	Temperature	22 C	Water	ASTM	Anode	Pt-Ti	Current	0.31 A	Start/end voltage	2.40 V/2.43 V
Parameter	Value														
Temperature	22 C														
Water	ASTM														
Anode	Pt-Ti														
Current	0.31 A														
Start/end voltage	2.40 V/2.43 V														
		<table border="1"> <thead> <tr> <th>Weight bf. [g]</th> <th>Weight af. [g]</th> <th>Weight gain [g]</th> </tr> </thead> <tbody> <tr> <td><u>98.7371</u></td> <td><u>102.2014</u></td> <td><u>3.4643</u></td> </tr> </tbody> </table>	Weight bf. [g]	Weight af. [g]	Weight gain [g]	<u>98.7371</u>	<u>102.2014</u>	<u>3.4643</u>							
Weight bf. [g]	Weight af. [g]	Weight gain [g]													
<u>98.7371</u>	<u>102.2014</u>	<u>3.4643</u>													
		<table border="1"> <thead> <tr> <th></th> <th>% Aragonite</th> <th>% Brucite</th> <th>% Calcite</th> </tr> </thead> <tbody> <tr> <td>Avg</td> <td>28.8</td> <td>71.1</td> <td>0.0</td> </tr> <tr> <td>SD</td> <td>1.9</td> <td>1.8</td> <td>0.1</td> </tr> </tbody> </table>		% Aragonite	% Brucite	% Calcite	Avg	28.8	71.1	0.0	SD	1.9	1.8	0.1	
	% Aragonite	% Brucite	% Calcite												
Avg	28.8	71.1	0.0												
SD	1.9	1.8	0.1												

The material has a thin, brittle outer layer. The material is white, with light yellow areas. The material is hard to remove. No obvious inner layer as seen on many of the other samples. 1.1669 g material was removed from the cathode for XRD-analysis.

Run 5NY

Table 8 Run 5NY

		<table border="1"> <thead> <tr> <th>Parameter</th> <th>Value</th> </tr> </thead> <tbody> <tr> <td>Temperature</td> <td>22 C</td> </tr> <tr> <td>Water</td> <td>ASTM</td> </tr> <tr> <td>Anode</td> <td>Pt-Ti</td> </tr> <tr> <td>Current</td> <td>0.31 A</td> </tr> <tr> <td>Start/end voltage</td> <td>2.72 V/3.20 V</td> </tr> </tbody> </table>		Parameter	Value	Temperature	22 C	Water	ASTM	Anode	Pt-Ti	Current	0.31 A	Start/end voltage	2.72 V/3.20 V
Parameter	Value														
Temperature	22 C														
Water	ASTM														
Anode	Pt-Ti														
Current	0.31 A														
Start/end voltage	2.72 V/3.20 V														
		<table border="1"> <thead> <tr> <th>Weight bf. [g]</th> <th>Weight af. [g]</th> <th>Weight gain [g]</th> </tr> </thead> <tbody> <tr> <td><u>97.5584</u></td> <td><u>110.5552</u></td> <td><u>12.9968</u></td> </tr> </tbody> </table>		Weight bf. [g]	Weight af. [g]	Weight gain [g]	<u>97.5584</u>	<u>110.5552</u>	<u>12.9968</u>						
Weight bf. [g]	Weight af. [g]	Weight gain [g]													
<u>97.5584</u>	<u>110.5552</u>	<u>12.9968</u>													
		<table border="1"> <thead> <tr> <th></th> <th>% Aragonite</th> <th>% Brucite</th> <th>% Calcite</th> </tr> </thead> <tbody> <tr> <td>Avg</td> <td>0.2</td> <td>99.8</td> <td>0.0</td> </tr> <tr> <td>SD</td> <td>0.2</td> <td>0.2</td> <td>0.0</td> </tr> </tbody> </table>			% Aragonite	% Brucite	% Calcite	Avg	0.2	99.8	0.0	SD	0.2	0.2	0.0
	% Aragonite	% Brucite	% Calcite												
Avg	0.2	99.8	0.0												
SD	0.2	0.2	0.0												

The material was white, with large flakes that fell off when moved. The material was relatively thick ($\approx 1\text{mm}$), and therefore hard to make into a powder. The material that had already fallen off, was used for the XRD-analysis (4.4468 g). It was enough material to make three tablets for the XDR-analysis.



Comparing Run 5 and Run 5NY

Run 5 and Run 5NY were supposed to give the same results, but there is a large difference. The Run 5 sample gave 69.5% brucite while 99.6% brucite was produced when the experiment was repeated. The mass of the produced samples also indicates that the conditions for production was different, as four times more material was produced when the experiment was repeated.

The applied current was the same in each of the experiments, but the applied voltage was much higher (up to $\approx 3.2\text{ V}$) in Run 5NY than in Run 5 (up to 2.43 V). In Run 5NY only one setup was connected to the power supply. Can this have caused the difference?

Run 7



Table 9 Run 7

		<table border="1"> <thead> <tr> <th>Parameter</th> <th>Value</th> </tr> </thead> <tbody> <tr> <td>Temperature</td> <td>7 C</td> </tr> <tr> <td>Water</td> <td>ASTM</td> </tr> <tr> <td>Anode</td> <td>Pt-Ti</td> </tr> <tr> <td>Current</td> <td>0.25 A</td> </tr> <tr> <td>Start/end voltage</td> <td>2.05 V/2.37 V</td> </tr> </tbody> </table>		Parameter	Value	Temperature	7 C	Water	ASTM	Anode	Pt-Ti	Current	0.25 A	Start/end voltage	2.05 V/2.37 V
Parameter	Value														
Temperature	7 C														
Water	ASTM														
Anode	Pt-Ti														
Current	0.25 A														
Start/end voltage	2.05 V/2.37 V														
		<table border="1"> <thead> <tr> <th>Weight bf. [g]</th> <th>Weight af. [g]</th> <th>Weight gain [g]</th> </tr> </thead> <tbody> <tr> <td><u>98.6468</u></td> <td><u>100.9523</u></td> <td><u>2.3055</u></td> </tr> </tbody> </table>		Weight bf. [g]	Weight af. [g]	Weight gain [g]	<u>98.6468</u>	<u>100.9523</u>	<u>2.3055</u>						
Weight bf. [g]	Weight af. [g]	Weight gain [g]													
<u>98.6468</u>	<u>100.9523</u>	<u>2.3055</u>													
		<table border="1"> <thead> <tr> <th></th> <th>% Aragonite</th> <th>% Brucite</th> <th>% Calcite</th> </tr> </thead> <tbody> <tr> <td>Avg</td> <td>NA</td> <td>NA</td> <td>NA</td> </tr> <tr> <td>SD</td> <td>NA</td> <td>NA</td> <td>NA</td> </tr> </tbody> </table>			% Aragonite	% Brucite	% Calcite	Avg	NA	NA	NA	SD	NA	NA	NA
	% Aragonite	% Brucite	% Calcite												
Avg	NA	NA	NA												
SD	NA	NA	NA												

The material from Run 7 is light yellow, and seems to appear as a layer at the surface of the cathode. Parts of the material is hard the remaining material is hard to remove from the metal surface. 0.7225 g material was removed from the cathode for XRD analysis.

Run 8

Table 10 Run 8



		<table border="1"> <thead> <tr> <th>Parameter</th> <th>Value</th> </tr> </thead> <tbody> <tr> <td>Temperature</td> <td>7 C</td> </tr> <tr> <td>Water</td> <td>ESBJ</td> </tr> <tr> <td>Anode</td> <td>DSA</td> </tr> <tr> <td>Current</td> <td>0.25 A</td> </tr> <tr> <td>Start/end voltage</td> <td>2.05 V/2.37 V</td> </tr> </tbody> </table>		Parameter	Value	Temperature	7 C	Water	ESBJ	Anode	DSA	Current	0.25 A	Start/end voltage	2.05 V/2.37 V
Parameter	Value														
Temperature	7 C														
Water	ESBJ														
Anode	DSA														
Current	0.25 A														
Start/end voltage	2.05 V/2.37 V														
		<table border="1"> <thead> <tr> <th>Weight bf. [g]</th> <th>Weight af. [g]</th> <th>Weight gain [g]</th> </tr> </thead> <tbody> <tr> <td><u>98.7426</u></td> <td><u>101.5536</u></td> <td><u>2.8110</u></td> </tr> </tbody> </table>		Weight bf. [g]	Weight af. [g]	Weight gain [g]	<u>98.7426</u>	<u>101.5536</u>	<u>2.8110</u>						
Weight bf. [g]	Weight af. [g]	Weight gain [g]													
<u>98.7426</u>	<u>101.5536</u>	<u>2.8110</u>													
	% Aragonite	% Brucite	% Calcite												
Avg	35.7*	64.3*	0.0*												
SD*															

*The sample was analyzed once, statistics could not be calculated.

The material was thin and was relatively easy to remove. The material is white with some corrosion. 0.6879 g was removed for XRD-analysis.

Run 9



Table 11 Run 9

		<table border="1"> <thead> <tr> <th>Parameter</th> <th>Value</th> </tr> </thead> <tbody> <tr> <td>Temperature</td> <td>7 C</td> </tr> <tr> <td>Water</td> <td>ESBJ</td> </tr> <tr> <td>Anode</td> <td>Pt-Ti</td> </tr> <tr> <td>Current</td> <td>0.31 A</td> </tr> <tr> <td>Start/end voltage</td> <td>2.3 V/2.36 V</td> </tr> </tbody> </table>		Parameter	Value	Temperature	7 C	Water	ESBJ	Anode	Pt-Ti	Current	0.31 A	Start/end voltage	2.3 V/2.36 V
Parameter	Value														
Temperature	7 C														
Water	ESBJ														
Anode	Pt-Ti														
Current	0.31 A														
Start/end voltage	2.3 V/2.36 V														
		<table border="1"> <thead> <tr> <th>Weight bf. [g]</th> <th>Weight af. [g]</th> <th>Weight gain [g]</th> </tr> </thead> <tbody> <tr> <td><u>98.9525</u></td> <td><u>102.0222</u></td> <td><u>3.0697</u></td> </tr> </tbody> </table>		Weight bf. [g]	Weight af. [g]	Weight gain [g]	<u>98.9525</u>	<u>102.0222</u>	<u>3.0697</u>						
Weight bf. [g]	Weight af. [g]	Weight gain [g]													
<u>98.9525</u>	<u>102.0222</u>	<u>3.0697</u>													
		<table border="1"> <thead> <tr> <th></th> <th>% Aragonite</th> <th>% Brucite</th> <th>% Calcite</th> </tr> </thead> <tbody> <tr> <td>Avg</td> <td>30.0</td> <td>69.9</td> <td>0.0</td> </tr> <tr> <td>SD</td> <td>1.2</td> <td>1.2</td> <td>0.1</td> </tr> </tbody> </table>			% Aragonite	% Brucite	% Calcite	Avg	30.0	69.9	0.0	SD	1.2	1.2	0.1
	% Aragonite	% Brucite	% Calcite												
Avg	30.0	69.9	0.0												
SD	1.2	1.2	0.1												

The material is white. It has a springly outer layer that is easy to remove. A large inner layer that is harder to remove. The outer layer is brittle, the inner layer is thicker and more porous. 1.0826 g was removed from one side of the cathode for XRD-analysis.

Run 10



Table 12 Run 10

		<table border="1"> <thead> <tr> <th>Parameter</th> <th>Value</th> </tr> </thead> <tbody> <tr> <td>Temperature</td> <td>7 C</td> </tr> <tr> <td>Water</td> <td>ESBJ</td> </tr> <tr> <td>Anode</td> <td>DSA</td> </tr> <tr> <td>Current</td> <td>0.31</td> </tr> <tr> <td>Start/end voltage</td> <td>2.3 V/2.36 V</td> </tr> </tbody> </table>		Parameter	Value	Temperature	7 C	Water	ESBJ	Anode	DSA	Current	0.31	Start/end voltage	2.3 V/2.36 V
Parameter	Value														
Temperature	7 C														
Water	ESBJ														
Anode	DSA														
Current	0.31														
Start/end voltage	2.3 V/2.36 V														
		<table border="1"> <thead> <tr> <th>Weight bf. [g]</th> <th>Weight af. [g]</th> <th>Weight gain [g]</th> </tr> </thead> <tbody> <tr> <td><u>98.2700</u></td> <td><u>100.9277</u></td> <td><u>2.6577</u></td> </tr> </tbody> </table>		Weight bf. [g]	Weight af. [g]	Weight gain [g]	<u>98.2700</u>	<u>100.9277</u>	<u>2.6577</u>						
Weight bf. [g]	Weight af. [g]	Weight gain [g]													
<u>98.2700</u>	<u>100.9277</u>	<u>2.6577</u>													
		<table border="1"> <thead> <tr> <th></th> <th>% Aragonite</th> <th>% Brucite</th> <th>% Calcite</th> </tr> </thead> <tbody> <tr> <td>Avg</td> <td>14.7</td> <td>85.3</td> <td>0.0</td> </tr> <tr> <td>SD</td> <td>6.4</td> <td>6.5</td> <td>0.1</td> </tr> </tbody> </table>			% Aragonite	% Brucite	% Calcite	Avg	14.7	85.3	0.0	SD	6.4	6.5	0.1
	% Aragonite	% Brucite	% Calcite												
Avg	14.7	85.3	0.0												
SD	6.4	6.5	0.1												

The material is white, there is some corrosion on the cathode. The material consists of a brittle outer layer that is easy to remove. An inner layer is hard and harder to remove. 0.9288 g was removed from one side of the cathode for XRD-analysis.

Run 11



Table 13 Run 11

		<table border="1"> <thead> <tr> <th>Parameter</th> <th>Value</th> </tr> </thead> <tbody> <tr> <td>Temperature</td> <td>22 C</td> </tr> <tr> <td>Water</td> <td>ASTM</td> </tr> <tr> <td>Anode</td> <td>DSA</td> </tr> <tr> <td>Current</td> <td>0.31 A</td> </tr> <tr> <td>Start/end voltage</td> <td>2.3 V/2.36 V</td> </tr> </tbody> </table>		Parameter	Value	Temperature	22 C	Water	ASTM	Anode	DSA	Current	0.31 A	Start/end voltage	2.3 V/2.36 V
Parameter	Value														
Temperature	22 C														
Water	ASTM														
Anode	DSA														
Current	0.31 A														
Start/end voltage	2.3 V/2.36 V														
		<table border="1"> <thead> <tr> <th>Weight bf. [g]</th> <th>Weight af. [g]</th> <th>Weight gain [g]</th> </tr> </thead> <tbody> <tr> <td><u>97.7016</u></td> <td><u>107.5710</u></td> <td><u>9.8694</u></td> </tr> </tbody> </table>		Weight bf. [g]	Weight af. [g]	Weight gain [g]	<u>97.7016</u>	<u>107.5710</u>	<u>9.8694</u>						
Weight bf. [g]	Weight af. [g]	Weight gain [g]													
<u>97.7016</u>	<u>107.5710</u>	<u>9.8694</u>													
		<table border="1"> <thead> <tr> <th></th> <th>% Aragonite</th> <th>% Brucite</th> <th>% Calcite</th> </tr> </thead> <tbody> <tr> <td>Avg</td> <td>1.5</td> <td>98.5</td> <td>0.0</td> </tr> <tr> <td>SD</td> <td>1.4</td> <td>1.4</td> <td>0.0</td> </tr> </tbody> </table>			% Aragonite	% Brucite	% Calcite	Avg	1.5	98.5	0.0	SD	1.4	1.4	0.0
	% Aragonite	% Brucite	% Calcite												
Avg	1.5	98.5	0.0												
SD	1.4	1.4	0.0												

The cathode seemed to be corroded, and the produced material was very dark in color compared to all the other samples. On one side, parts of the material are completely black. The material is also thicker than the other samples. White material is hidden below the outer layer. The inner layer is very porous. 3.0176 g was removed from the cathode for XRD-analysis. The material is thick and it is more difficult to make it into a powder compared to the other samples.

Run 12



Table 14 Run 12

		<table border="1"> <thead> <tr> <th>Parameter</th> <th>Value</th> </tr> </thead> <tbody> <tr> <td>Temperature</td> <td>22 C</td> </tr> <tr> <td>Water</td> <td>ESBJ</td> </tr> <tr> <td>Anode</td> <td>Pt-Ti</td> </tr> <tr> <td>Current</td> <td>0.31 A</td> </tr> <tr> <td>Start/end voltage</td> <td>2.3 V/2.36 V</td> </tr> </tbody> </table>		Parameter	Value	Temperature	22 C	Water	ESBJ	Anode	Pt-Ti	Current	0.31 A	Start/end voltage	2.3 V/2.36 V
Parameter	Value														
Temperature	22 C														
Water	ESBJ														
Anode	Pt-Ti														
Current	0.31 A														
Start/end voltage	2.3 V/2.36 V														
		<table border="1"> <thead> <tr> <th>Weight bf. [g]</th> <th>Weight af. [g]</th> <th>Weight gain [g]</th> </tr> </thead> <tbody> <tr> <td><u>98.6763</u></td> <td><u>102.1563</u></td> <td><u>3.4800</u></td> </tr> </tbody> </table>		Weight bf. [g]	Weight af. [g]	Weight gain [g]	<u>98.6763</u>	<u>102.1563</u>	<u>3.4800</u>						
Weight bf. [g]	Weight af. [g]	Weight gain [g]													
<u>98.6763</u>	<u>102.1563</u>	<u>3.4800</u>													
		<table border="1"> <thead> <tr> <th></th> <th>% Aragonite</th> <th>% Brucite</th> <th>% Calcite</th> </tr> </thead> <tbody> <tr> <td>Avg</td> <td>22.0</td> <td>78.0</td> <td>0.0</td> </tr> <tr> <td>SD</td> <td>0.6</td> <td>0.6</td> <td>0.0</td> </tr> </tbody> </table>			% Aragonite	% Brucite	% Calcite	Avg	22.0	78.0	0.0	SD	0.6	0.6	0.0
	% Aragonite	% Brucite	% Calcite												
Avg	22.0	78.0	0.0												
SD	0.6	0.6	0.0												

The material is white and brittle. It was easy to remove. There was an inner and an outer layer. Small amount of the inner layer that is relatively hard to remove. Some corrosion under the material. 1.7810 g was removed from one side for XRD-analysis.

Run 13

Table 15 Run 13

		<table border="1"> <thead> <tr> <th>Parameter</th> <th>Value</th> </tr> </thead> <tbody> <tr> <td>Temperature</td> <td>7 C</td> </tr> <tr> <td>Water</td> <td>ASTM</td> </tr> <tr> <td>Anode</td> <td>DSA</td> </tr> <tr> <td>Current</td> <td>0.22 A</td> </tr> <tr> <td>Start/end voltage</td> <td>2.11 V/2.37 V</td> </tr> </tbody> </table>		Parameter	Value	Temperature	7 C	Water	ASTM	Anode	DSA	Current	0.22 A	Start/end voltage	2.11 V/2.37 V
Parameter	Value														
Temperature	7 C														
Water	ASTM														
Anode	DSA														
Current	0.22 A														
Start/end voltage	2.11 V/2.37 V														
		<table border="1"> <thead> <tr> <th>Weight bf. [g]</th> <th>Weight af. [g]</th> <th>Weight gain [g]</th> </tr> </thead> <tbody> <tr> <td><u>99.3685</u></td> <td><u>100.3219</u></td> <td><u>0.9534</u></td> </tr> </tbody> </table>		Weight bf. [g]	Weight af. [g]	Weight gain [g]	<u>99.3685</u>	<u>100.3219</u>	<u>0.9534</u>						
Weight bf. [g]	Weight af. [g]	Weight gain [g]													
<u>99.3685</u>	<u>100.3219</u>	<u>0.9534</u>													
		<table border="1"> <thead> <tr> <th></th> <th>% Aragonite</th> <th>% Brucite</th> <th>% Calcite</th> </tr> </thead> <tbody> <tr> <td>Avg</td> <td>80.4</td> <td>19.5</td> <td>0.0</td> </tr> <tr> <td>SD</td> <td>3.8</td> <td>3.8</td> <td>0.1</td> </tr> </tbody> </table>			% Aragonite	% Brucite	% Calcite	Avg	80.4	19.5	0.0	SD	3.8	3.8	0.1
	% Aragonite	% Brucite	% Calcite												
Avg	80.4	19.5	0.0												
SD	3.8	3.8	0.1												

The cathode is corroded with only a thin white material. It seems like there has been a disconnection from the power supply. The material is relatively easy to remove, but in small amounts. Material removed from one side for XRD-analysis.

Run 15

Table 16 Run 15

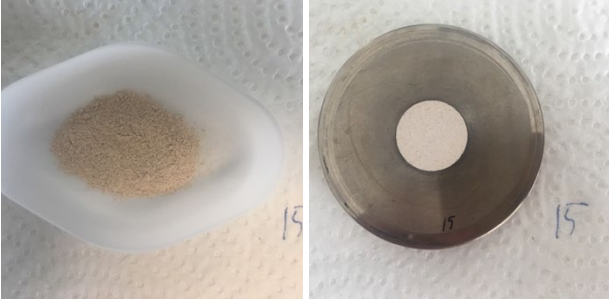
		<table border="1"> <thead> <tr> <th>Parameter</th> <th>Value</th> </tr> </thead> <tbody> <tr> <td>Temperature</td> <td>22 C</td> </tr> <tr> <td>Water</td> <td>ESBJ</td> </tr> <tr> <td>Anode</td> <td>DSA</td> </tr> <tr> <td>Current</td> <td>0.22 A</td> </tr> <tr> <td>Start/end voltage</td> <td>2.11 V/2.37 V</td> </tr> </tbody> </table>		Parameter	Value	Temperature	22 C	Water	ESBJ	Anode	DSA	Current	0.22 A	Start/end voltage	2.11 V/2.37 V
Parameter	Value														
Temperature	22 C														
Water	ESBJ														
Anode	DSA														
Current	0.22 A														
Start/end voltage	2.11 V/2.37 V														
		<table border="1"> <thead> <tr> <th>Weight bf. [g]</th> <th>Weight af. [g]</th> <th>Weight gain [g]</th> </tr> </thead> <tbody> <tr> <td><u>97.9756</u></td> <td><u>100.8673</u></td> <td><u>2.8917</u></td> </tr> </tbody> </table>		Weight bf. [g]	Weight af. [g]	Weight gain [g]	<u>97.9756</u>	<u>100.8673</u>	<u>2.8917</u>						
Weight bf. [g]	Weight af. [g]	Weight gain [g]													
<u>97.9756</u>	<u>100.8673</u>	<u>2.8917</u>													
		<table border="1"> <thead> <tr> <th></th> <th>% Aragonite</th> <th>% Brucite</th> <th>% Calcite</th> </tr> </thead> <tbody> <tr> <td>Avg</td> <td>21.3</td> <td>78.6</td> <td>0.1</td> </tr> <tr> <td>SD</td> <td>1.8</td> <td>1.9</td> <td>0.2</td> </tr> </tbody> </table>			% Aragonite	% Brucite	% Calcite	Avg	21.3	78.6	0.1	SD	1.8	1.9	0.2
	% Aragonite	% Brucite	% Calcite												
Avg	21.3	78.6	0.1												
SD	1.8	1.9	0.2												

The material is easy to remove from the cathode. It is divided into two layers, an outer brown (corrosion) layer and an inner white layer. The inner layer is thicker and more porous (brucite?), while the outer is thinner and brittle. 1.0826 g was removed from one side of the cathode was removed for XRD-analysis.

Run 20

Table 17 Run 20

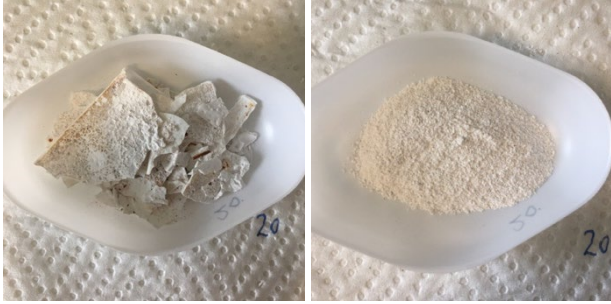
		<table border="1"> <thead> <tr> <th>Parameter</th> <th>Value</th> </tr> </thead> <tbody> <tr> <td>Temperature</td> <td>22 C</td> </tr> <tr> <td>Water</td> <td>ESBJ</td> </tr> <tr> <td>Anode</td> <td>DSA</td> </tr> <tr> <td>Current</td> <td>0.31 A</td> </tr> <tr> <td>Start/end voltage</td> <td>2.40 V/2.43 V</td> </tr> </tbody> </table>		Parameter	Value	Temperature	22 C	Water	ESBJ	Anode	DSA	Current	0.31 A	Start/end voltage	2.40 V/2.43 V
Parameter	Value														
Temperature	22 C														
Water	ESBJ														
Anode	DSA														
Current	0.31 A														
Start/end voltage	2.40 V/2.43 V														
		<table border="1"> <thead> <tr> <th>Weight bf. [g]</th> <th>Weight af. [g]</th> <th>Weight gain [g]</th> </tr> </thead> <tbody> <tr> <td><u>99.2911</u></td> <td><u>107.3842</u></td> <td><u>8.0931</u></td> </tr> </tbody> </table>		Weight bf. [g]	Weight af. [g]	Weight gain [g]	<u>99.2911</u>	<u>107.3842</u>	<u>8.0931</u>						
Weight bf. [g]	Weight af. [g]	Weight gain [g]													
<u>99.2911</u>	<u>107.3842</u>	<u>8.0931</u>													
		<table border="1"> <thead> <tr> <th></th> <th>% Aragonite</th> <th>% Brucite</th> <th>% Calcite</th> </tr> </thead> <tbody> <tr> <td>Avg</td> <td>2.7</td> <td>97.2</td> <td>0.0</td> </tr> <tr> <td>SD</td> <td>2.2</td> <td>2.3</td> <td>0.1</td> </tr> </tbody> </table>			% Aragonite	% Brucite	% Calcite	Avg	2.7	97.2	0.0	SD	2.2	2.3	0.1
	% Aragonite	% Brucite	% Calcite												
Avg	2.7	97.2	0.0												
SD	2.2	2.3	0.1												

The material is thick and white. The material (outer layer) is easy to remove. The inner layer is some have harder to remove. The material from one side (+ a little piece from the other) was removed for XRD analysis, in total 3.0345 g.

Run 22

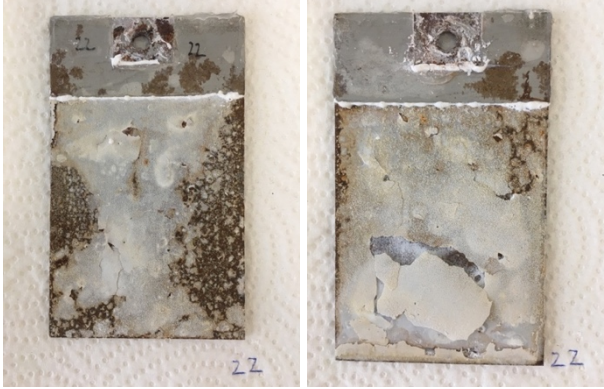
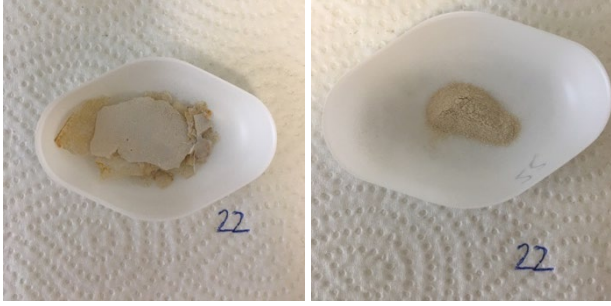

Table 18 Run 22

		<table border="1"> <thead> <tr> <th>Parameter</th> <th>Value</th> </tr> </thead> <tbody> <tr> <td>Temperature</td> <td>7 C</td> </tr> <tr> <td>Water</td> <td>ESBJ</td> </tr> <tr> <td>Anode</td> <td>Pt-Ti</td> </tr> <tr> <td>Current</td> <td>0.22 A</td> </tr> <tr> <td>Start/end voltage</td> <td>2.11 V/2.37 V</td> </tr> </tbody> </table>		Parameter	Value	Temperature	7 C	Water	ESBJ	Anode	Pt-Ti	Current	0.22 A	Start/end voltage	2.11 V/2.37 V
Parameter	Value														
Temperature	7 C														
Water	ESBJ														
Anode	Pt-Ti														
Current	0.22 A														
Start/end voltage	2.11 V/2.37 V														
		<table border="1"> <thead> <tr> <th>Weight bf. [g]</th> <th>Weight af. [g]</th> <th>Weight gain [g]</th> </tr> </thead> <tbody> <tr> <td><u>98.8727</u></td> <td><u>100.2546</u></td> <td><u>1.3819</u></td> </tr> </tbody> </table>		Weight bf. [g]	Weight af. [g]	Weight gain [g]	<u>98.8727</u>	<u>100.2546</u>	<u>1.3819</u>						
Weight bf. [g]	Weight af. [g]	Weight gain [g]													
<u>98.8727</u>	<u>100.2546</u>	<u>1.3819</u>													
		<table border="1"> <thead> <tr> <th></th> <th>% Aragonite</th> <th>% Brucite</th> <th>% Calcite</th> </tr> </thead> <tbody> <tr> <td>Avg</td> <td>81.0</td> <td>19.0</td> <td>0.0</td> </tr> <tr> <td>SD</td> <td>0.8</td> <td>0.7</td> <td>0.1</td> </tr> </tbody> </table>			% Aragonite	% Brucite	% Calcite	Avg	81.0	19.0	0.0	SD	0.8	0.7	0.1
	% Aragonite	% Brucite	% Calcite												
Avg	81.0	19.0	0.0												
SD	0.8	0.7	0.1												

The material is easy to remove from the cathode. Can be removed in large pieces. Under this easily removable layer there is a layer that is harder to remove. The outer material is brown (corrosion) and the inner layer is white. 0.4572 g material was removed for XRD analysis (one side of the cathode).

Run 26



Table 19 Run 26

	<table border="1"> <thead> <tr> <th>Parameter</th> <th colspan="2">Value</th> </tr> </thead> <tbody> <tr> <td>Temperature</td> <td colspan="2">22 C</td> </tr> <tr> <td>Water</td> <td colspan="2">ASTM</td> </tr> <tr> <td>Anode</td> <td colspan="2">Pt-Ti</td> </tr> <tr> <td>Current</td> <td colspan="2">0.22 A</td> </tr> <tr> <td>Start/end voltage</td> <td colspan="2">2.11 V/2.37 V</td> </tr> </tbody> </table>			Parameter	Value		Temperature	22 C		Water	ASTM		Anode	Pt-Ti		Current	0.22 A		Start/end voltage	2.11 V/2.37 V	
	Parameter	Value																			
Temperature	22 C																				
Water	ASTM																				
Anode	Pt-Ti																				
Current	0.22 A																				
Start/end voltage	2.11 V/2.37 V																				
	<table border="1"> <thead> <tr> <th>Weight bf. [g]</th> <th>Weight af. [g]</th> <th>Weight gain [g]</th> </tr> </thead> <tbody> <tr> <td><u>98.2139</u></td> <td><u>99.1789</u></td> <td><u>0.9650</u></td> </tr> </tbody> </table>			Weight bf. [g]	Weight af. [g]	Weight gain [g]	<u>98.2139</u>	<u>99.1789</u>	<u>0.9650</u>												
	Weight bf. [g]	Weight af. [g]	Weight gain [g]																		
<u>98.2139</u>	<u>99.1789</u>	<u>0.9650</u>																			
	<table border="1"> <thead> <tr> <th></th> <th>% Aragonite</th> <th>% Brucite</th> <th>% Calcite</th> </tr> </thead> <tbody> <tr> <td>Avg</td> <td>99.4</td> <td>0.6</td> <td>0.0</td> </tr> <tr> <td>SD</td> <td>0.3</td> <td>0.3</td> <td>0.1</td> </tr> </tbody> </table>				% Aragonite	% Brucite	% Calcite	Avg	99.4	0.6	0.0	SD	0.3	0.3	0.1						
	% Aragonite	% Brucite	% Calcite																		
Avg	99.4	0.6	0.0																		
SD	0.3	0.3	0.1																		

The cathode is totally corroded. Small amount of material, but it is all brown (corrosion material). A small area of the cathode is covered by a white material (0.5x0.5 cm). 0.2988 g was removed for XRD analysis (material from one side of the cathode). The material is brown, possibly corrosion.

Run 32



Table 20 Run 32

		<table border="1"> <thead> <tr> <th>Parameter</th> <th>Value</th> </tr> </thead> <tbody> <tr> <td>Temperature</td> <td>7 C</td> </tr> <tr> <td>Water</td> <td>ASTM</td> </tr> <tr> <td>Anode</td> <td>Pt-Ti</td> </tr> <tr> <td>Current</td> <td>0.31 A</td> </tr> <tr> <td>Start/end voltage</td> <td>2.40 V/2.43 V</td> </tr> </tbody> </table>		Parameter	Value	Temperature	7 C	Water	ASTM	Anode	Pt-Ti	Current	0.31 A	Start/end voltage	2.40 V/2.43 V
Parameter	Value														
Temperature	7 C														
Water	ASTM														
Anode	Pt-Ti														
Current	0.31 A														
Start/end voltage	2.40 V/2.43 V														
		<table border="1"> <thead> <tr> <th>Weight bf. [g]</th> <th>Weight af. [g]</th> <th>Weight gain [g]</th> </tr> </thead> <tbody> <tr> <td><u>99.0708</u></td> <td><u>102.0066</u></td> <td><u>2.9358</u></td> </tr> </tbody> </table>		Weight bf. [g]	Weight af. [g]	Weight gain [g]	<u>99.0708</u>	<u>102.0066</u>	<u>2.9358</u>						
Weight bf. [g]	Weight af. [g]	Weight gain [g]													
<u>99.0708</u>	<u>102.0066</u>	<u>2.9358</u>													
		<table border="1"> <thead> <tr> <th></th> <th>% Aragonite</th> <th>% Brucite</th> <th>% Calcite</th> </tr> </thead> <tbody> <tr> <td>Avg</td> <td>36.0</td> <td>63.9</td> <td>0.0</td> </tr> <tr> <td>SD</td> <td>4.2</td> <td>4.3</td> <td>0.1</td> </tr> </tbody> </table>			% Aragonite	% Brucite	% Calcite	Avg	36.0	63.9	0.0	SD	4.2	4.3	0.1
	% Aragonite	% Brucite	% Calcite												
Avg	36.0	63.9	0.0												
SD	4.2	4.3	0.1												

The material is white. Thin and brittle outer layer. Inner layer composed of a layer that sticks tight to the cathode surface. The inner layer is more porous than the outer layer. 0.9376 g was removed for XRD-analysis.

Run 2N

Table 21 Run 2N

		<table border="1"> <thead> <tr> <th>Parameter</th> <th>Value</th> </tr> </thead> <tbody> <tr> <td>Temperature</td> <td>22 C</td> </tr> <tr> <td>Water</td> <td>ASTM</td> </tr> <tr> <td>Anode</td> <td>DSA</td> </tr> <tr> <td>Current</td> <td>0.22 A</td> </tr> <tr> <td>Start/end voltage</td> <td>2.25 V/2.31 V</td> </tr> </tbody> </table>		Parameter	Value	Temperature	22 C	Water	ASTM	Anode	DSA	Current	0.22 A	Start/end voltage	2.25 V/2.31 V
Parameter	Value														
Temperature	22 C														
Water	ASTM														
Anode	DSA														
Current	0.22 A														
Start/end voltage	2.25 V/2.31 V														
		<table border="1"> <thead> <tr> <th>Weight bf. [g]</th> <th>Weight af. [g]</th> <th>Weight gain [g]</th> </tr> </thead> <tbody> <tr> <td><u>99.7217</u></td> <td><u>102.4429</u></td> <td><u>2.7212</u></td> </tr> </tbody> </table>		Weight bf. [g]	Weight af. [g]	Weight gain [g]	<u>99.7217</u>	<u>102.4429</u>	<u>2.7212</u>						
Weight bf. [g]	Weight af. [g]	Weight gain [g]													
<u>99.7217</u>	<u>102.4429</u>	<u>2.7212</u>													
		<table border="1"> <thead> <tr> <th></th> <th>% Aragonite</th> <th>% Brucite</th> <th>% Calcite</th> </tr> </thead> <tbody> <tr> <td>Avg</td> <td>38.2</td> <td>61.8</td> <td>0.0</td> </tr> <tr> <td>SD</td> <td>5.4</td> <td>5.4</td> <td>0.0</td> </tr> </tbody> </table>			% Aragonite	% Brucite	% Calcite	Avg	38.2	61.8	0.0	SD	5.4	5.4	0.0
	% Aragonite	% Brucite	% Calcite												
Avg	38.2	61.8	0.0												
SD	5.4	5.4	0.0												

The material is light yellow-orange, and it is just partly attached to the cathode. Small flakes of the material are easy to remove, but other places, the material is tightly fastened to the cathode. Inner and outer layer, the two layers sticks together and is impossible to separate at some places. 0.8996 g was removed for XRD-analysis.

Run 3N

Table 22 Run 3N

		<table border="1"> <thead> <tr> <th>Parameter</th> <th>Value</th> </tr> </thead> <tbody> <tr> <td>Temperature</td> <td>22 C</td> </tr> <tr> <td>Water</td> <td>ESBJ</td> </tr> <tr> <td>Anode</td> <td>Pt-Ti</td> </tr> <tr> <td>Current</td> <td>0.22 A</td> </tr> <tr> <td>Start/end voltage</td> <td>2.25 V/2.31 V</td> </tr> </tbody> </table>		Parameter	Value	Temperature	22 C	Water	ESBJ	Anode	Pt-Ti	Current	0.22 A	Start/end voltage	2.25 V/2.31 V
Parameter	Value														
Temperature	22 C														
Water	ESBJ														
Anode	Pt-Ti														
Current	0.22 A														
Start/end voltage	2.25 V/2.31 V														
<table border="1"> <thead> <tr> <th>Weight bf. [g]</th> <th>Weight af. [g]</th> <th>Weight gain [g]</th> </tr> </thead> <tbody> <tr> <td><u>98.3355</u></td> <td><u>100.9336</u></td> <td><u>2.5981</u></td> </tr> </tbody> </table>	Weight bf. [g]	Weight af. [g]	Weight gain [g]	<u>98.3355</u>	<u>100.9336</u>	<u>2.5981</u>									
Weight bf. [g]	Weight af. [g]	Weight gain [g]													
<u>98.3355</u>	<u>100.9336</u>	<u>2.5981</u>													
	% Aragonite	% Brucite	% Calcite												
Avg	49.8	50.2	0.0												
SD	7.1	7.1	0.1												

The material consists of an inner and an outer layer. The outer layer can easily be removed in one single piece. The outer layer was light orange in color. Not much corrosion on the cathode. The inner layer is whiter than the outer layer and is thinner. The inner layer is harder to remove opposite the outer layer. 0.8394 g was removed for XRD analysis and was taken from the inner and the outer layer.

Run 7N

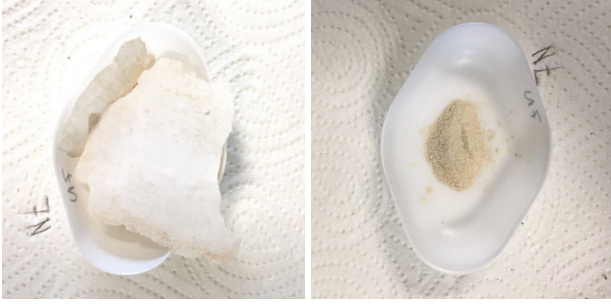

Table 23 Run 7N

		<table border="1"> <thead> <tr> <th>Parameter</th> <th>Value</th> </tr> </thead> <tbody> <tr> <td>Temperature</td> <td>7 C</td> </tr> <tr> <td>Water</td> <td>ASTM</td> </tr> <tr> <td>Anode</td> <td>Pt-Ti</td> </tr> <tr> <td>Current</td> <td>0.22 A</td> </tr> <tr> <td>Start/end voltage</td> <td>2.25 V/2.31 V</td> </tr> </tbody> </table>		Parameter	Value	Temperature	7 C	Water	ASTM	Anode	Pt-Ti	Current	0.22 A	Start/end voltage	2.25 V/2.31 V
Parameter	Value														
Temperature	7 C														
Water	ASTM														
Anode	Pt-Ti														
Current	0.22 A														
Start/end voltage	2.25 V/2.31 V														
		<table border="1"> <thead> <tr> <th>Weight bf. [g]</th> <th>Weight af. [g]</th> <th>Weight gain [g]</th> </tr> </thead> <tbody> <tr> <td><u>97.7100</u></td> <td><u>99.8022</u></td> <td><u>2.0922</u></td> </tr> </tbody> </table>	Weight bf. [g]	Weight af. [g]	Weight gain [g]	<u>97.7100</u>	<u>99.8022</u>	<u>2.0922</u>							
Weight bf. [g]	Weight af. [g]	Weight gain [g]													
<u>97.7100</u>	<u>99.8022</u>	<u>2.0922</u>													
		<table border="1"> <thead> <tr> <th></th> <th>% Aragonite</th> <th>% Brucite</th> <th>% Calcite</th> </tr> </thead> <tbody> <tr> <td>Avg</td> <td>77.2</td> <td>22.8</td> <td>0.0</td> </tr> <tr> <td>SD</td> <td>1.6</td> <td>1.6</td> <td>0.0</td> </tr> </tbody> </table>		% Aragonite	% Brucite	% Calcite	Avg	77.2	22.8	0.0	SD	1.6	1.6	0.0	
	% Aragonite	% Brucite	% Calcite												
Avg	77.2	22.8	0.0												
SD	1.6	1.6	0.0												

The material is white, thin and brittle. Some of the material at one side of the cathode fell off when the cathode was moved. At some places of the cathode, it is possible to look directly at the bare steel, something that might explain why the material do not stick to the cathode surface. The material was removed in large flakes from both sides of the cathode, simply because the flakes fell off. Small amount of white layer covers some parts of the cathode surface, and this was not removed. In total 0.7855 g material was removed from the cathode for XRD analysis.

Run 8N

Table 24 Run 8N

		<table border="1"> <thead> <tr> <th>Parameter</th> <th>Value</th> </tr> </thead> <tbody> <tr> <td>Temperature</td> <td>7 C</td> </tr> <tr> <td>Water</td> <td>ESBJ</td> </tr> <tr> <td>Anode</td> <td>DSA</td> </tr> <tr> <td>Current</td> <td>0.22 A</td> </tr> <tr> <td>Start/end voltage</td> <td>2.25 V/2.31 V</td> </tr> </tbody> </table>		Parameter	Value	Temperature	7 C	Water	ESBJ	Anode	DSA	Current	0.22 A	Start/end voltage	2.25 V/2.31 V
Parameter	Value														
Temperature	7 C														
Water	ESBJ														
Anode	DSA														
Current	0.22 A														
Start/end voltage	2.25 V/2.31 V														
		<table border="1"> <thead> <tr> <th>Weight bf. [g]</th> <th>Weight af. [g]</th> <th>Weight gain [g]</th> </tr> </thead> <tbody> <tr> <td><u>97.9152</u></td> <td><u>99.8678</u></td> <td><u>1.9526</u></td> </tr> </tbody> </table>	Weight bf. [g]	Weight af. [g]	Weight gain [g]	<u>97.9152</u>	<u>99.8678</u>	<u>1.9526</u>							
Weight bf. [g]	Weight af. [g]	Weight gain [g]													
<u>97.9152</u>	<u>99.8678</u>	<u>1.9526</u>													
		<table border="1"> <thead> <tr> <th></th> <th>% Aragonite</th> <th>% Brucite</th> <th>% Calcite</th> </tr> </thead> <tbody> <tr> <td>Avg</td> <td>36.0</td> <td>64.0</td> <td>0.1</td> </tr> <tr> <td>SD</td> <td>7.8</td> <td>7.9</td> <td>0.1</td> </tr> </tbody> </table>			% Aragonite	% Brucite	% Calcite	Avg	36.0	64.0	0.1	SD	7.8	7.9	0.1
	% Aragonite	% Brucite	% Calcite												
Avg	36.0	64.0	0.1												
SD	7.8	7.9	0.1												

Looks like some of the material has felt off at both sides of the cathode. The material consists of an inner and an outer layer where it seems like parts of the outer layer has fallen off. What is left of the outer layer is light yellow-orange in color. Under parts of the outer layer there is no inner material. Material from inner and outer layer was removed for XRD-analysis.

5. Analysis

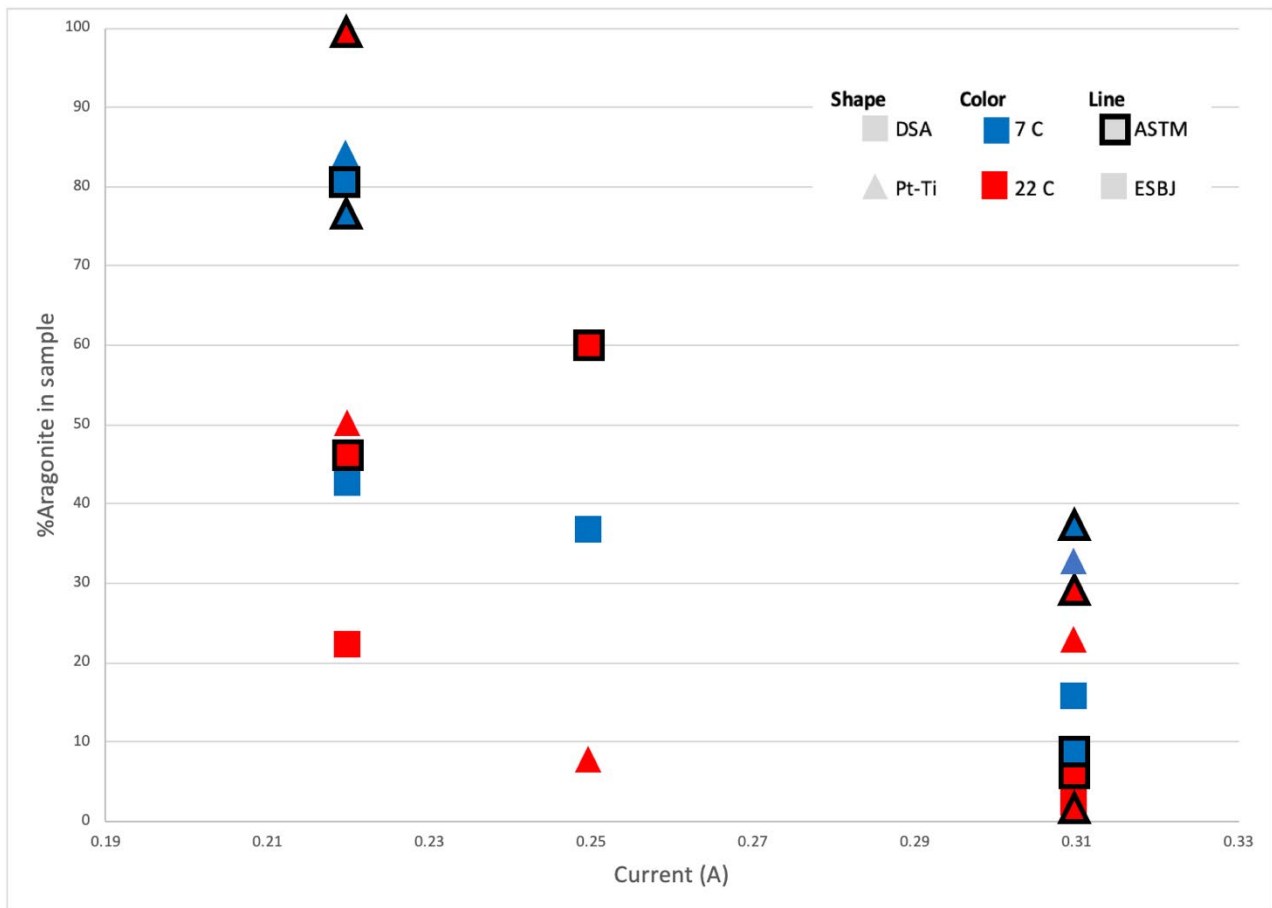

Figure 9 Applied current vs %Aragonite

Figure 9 is a graphical presentation of the results, where the current is plotted versus % aragonite in the deposited sample. The illustration indicates that there is a correlation between applied current and the deposited material. The samples produced at 0.22 is higher in aragonite than the samples produced at either a constant current of 0.25 A or 0.31 A. The lowest percentage of aragonite is found in the samples produced at 0.31 A.

The highest percentage of aragonite for both the samples produced at 0.22 A and 0.31 A are found among the samples where the Pt-Ti anode was used. This tendency is especially pronounced for the samples prepared at 0.31 A. This phenomenon could be explained by the difference in activation potential for the two anodes.

The temperature or the seawater composition does not seem to have a great effect on the deposited material.



Figure 10 Average material composition at given temperatures and applied currents

The circle diagrams in Figure 10 show the average composition of the mineral material, an average of the composition produced at a given temperature and a given applied current. This means that the seawater composition parameters and the anode material parameters are combined and the percentage given in the diagrams are averaged values. The figures indicate that lower the applied current results in a higher percentage of aragonite, and the percentage is decreasing with increased applied current. In contrary to what was expected from the literature, these results indicate that lower temperature results in a higher percentage of aragonite compared to when the material is produced at a higher temperature.

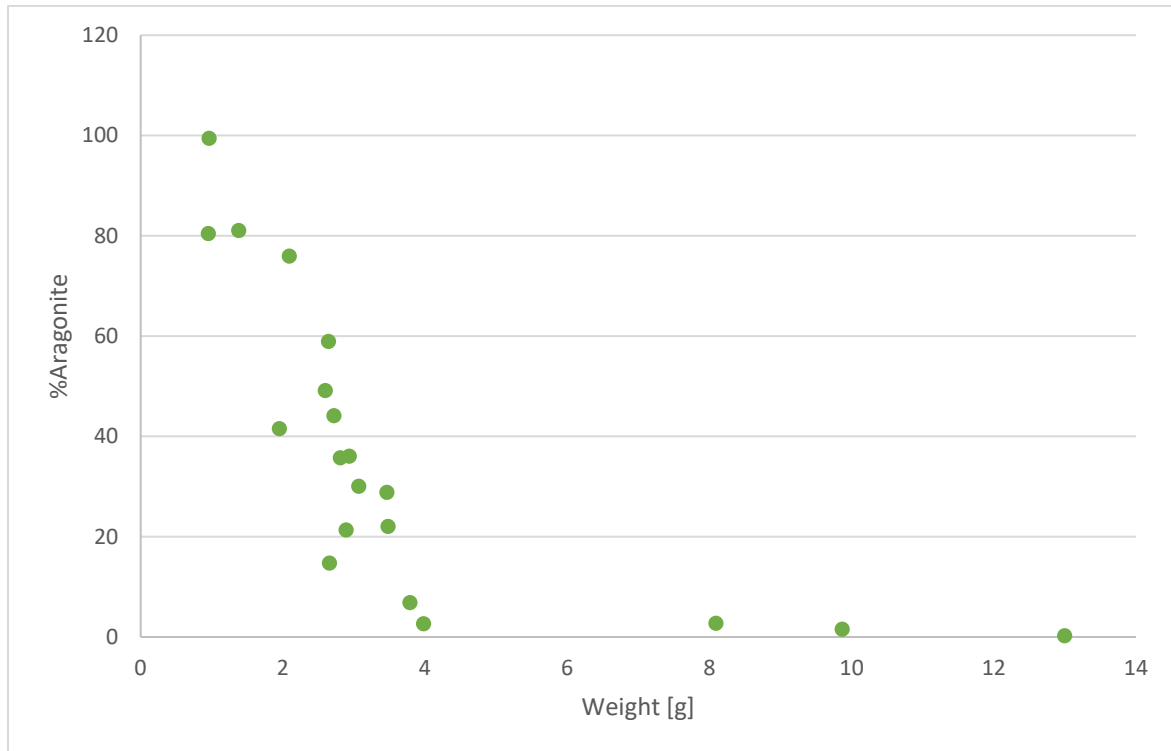

Figure 11 Weight of deposited material vs %aragonite

Figure 11 shows the correlation between weight and the percentage of aragonite in the deposited sample. The figure indicates a trend, the samples with the highest percentage of aragonite are the samples with the lowest weight. The samples with the smallest amount of aragonite is highest in weight. This highlights the fact that it is easier to produce large amounts of brucite compared to aragonite.

6. Conclusions

From the laboratory experiment presented in this report the following conclusions can be made.

- 1) A laboratory setup was prepared for investigation of mineral deposition in a controlled environment. For some reason the replicability of the experiments made using the setup seems to be lower than expected.
- 2) Effect of parameters:
 - a. Temperature:

The circle diagrams in Figure 10 indicates that more aragonite is deposited at lower temperatures (7 °C) than in room tempered water (22 °C). This can be explained by the kinetics of the reaction at the two temperatures, the electrolysis reaction is simply more effective (more OH⁻ is produced) at higher temperature compared to when the same constant current is applied at lower temperature.

- b. Anode material

Application of DSA anode generally results in higher amount of brucite produced and more material compared to the experiments where the Pt-Ti anode is used. Use of Pt-Ti anode indicates

generally higher amount of aragonite and less material produced compared to the experiments where the DSA anode is used. The two electrode materials have different activation potential, meaning the minimum potential that is required for the electrolysis reaction to start. The results indicate that the DSA anode has a higher activation potential than the Pt-Ti anode.

c. Seawater composition

ASTM indicates a slightly higher deposition of aragonite compared to when ESBJ water is used. In many cases the percentage of aragonite is the more or less the same for both waters. The difference in ion concentrations between the two synthetic water solutions are probably so small that it is insignificant for the mineral deposition.

d. Applied electrical current

The applied constant electrical current seems to have the effect that increased amount of applied current makes brucite form, while a lower amount of applied current makes it more likely for aragonite to be deposited at the cathode surface. This is indicated in Figure 9. This result was expected as the concentration of hydroxide ions (OH^-) is increasing with increased applied current. As a result, brucite forms in a competing reaction to deposition of aragonite.

- 3) XRD is the preferred analysis method for identifying electrodeposited material from synthetic seawater. The method has been used for the material produced for this report.
- 4) All material produced during the experiment time was weighted dry.
- 5) The reproducibility of the results seems to be poor. One of the experiments were repeated (5 and 5 NY) to evaluate how reproduceable this method for electrodeposition of material from synthetic seawater was and the result was a difference in aragonite deposition from 28.8 % in the first run to 0.2 % in the second run.
- 6) From this study, the governing conditions for the production of Aragonite is low current (0.22 A) and low temperature (7 °C). The tested synthetic seawater water compositions seem to have only a small or no effect on the deposited material. Of the two tested anode materials the results indicate that the Pt-Ti anode produce material with a slightly higher percentage of aragonite compared to the DSA anode.

7. References

- Barchiche, C. et al., 2004. Characterisation of calcareous deposits by electrochemical methods : role of sulphates , calcium concentration and temperature. , 49, pp.2833–2839.
- Goreau, T., 2012. Marine electrolysis for building materials and environmental restoration. *Electrolysis, InTech Publishing, Rijeka, Croatia*, pp.273–290.
- Karoui, H. et al., 2013. Electrochemical scaling of stainless steel in artificial seawater: Role of experimental conditions on CaCO_3 and $\text{Mg}(\text{OH})_2$ formation. *Desalination*, 311, pp.234–240. Available at: <http://dx.doi.org/10.1016/j.desal.2012.07.011>.