



Operation of a novel two-pipe active beam system in an office building

a thermal comfort study

Maccarini, Alessandro; Hultmark, Göran; Bergsøe, Niels Christian; Afshari, Alireza

Published in:

Proceedings of the The 15th Conference of the International Society of Indoor Air Quality & Climate (ISIAQ)

Publication date:

2018

Document Version

Accepted author manuscript, peer reviewed version

[Link to publication from Aalborg University](#)

Citation for published version (APA):

Maccarini, A., Hultmark, G., Bergsøe, N. C., & Afshari, A. (2018). Operation of a novel two-pipe active beam system in an office building: a thermal comfort study. In *Proceedings of the The 15th Conference of the International Society of Indoor Air Quality & Climate (ISIAQ): Indoor Air 2018* Article 607 International Society of Indoor Air Quality and Climate.

General rights

Copyright and moral rights for the publications made accessible in the public portal are retained by the authors and/or other copyright owners and it is a condition of accessing publications that users recognise and abide by the legal requirements associated with these rights.

- Users may download and print one copy of any publication from the public portal for the purpose of private study or research.
- You may not further distribute the material or use it for any profit-making activity or commercial gain
- You may freely distribute the URL identifying the publication in the public portal -

Take down policy

If you believe that this document breaches copyright please contact us at vbn@aub.aau.dk providing details, and we will remove access to the work immediately and investigate your claim.

See discussions, stats, and author profiles for this publication at: <https://www.researchgate.net/publication/325976620>

Operation of a novel two-pipe active beam system in an office building: a thermal comfort study

Conference Paper · July 2018

CITATIONS

0

READS

36

4 authors, including:



[Alessandro Maccarini](#)

Aalborg University

14 PUBLICATIONS 34 CITATIONS

[SEE PROFILE](#)



[Alireza Afshari](#)

Aalborg University

68 PUBLICATIONS 1,156 CITATIONS

[SEE PROFILE](#)

Some of the authors of this publication are also working on these related projects:



Infection Control in Operating Room Environments [View project](#)



Evaluation of air cleaning technologies [View project](#)

Operation of a novel two-pipe active beam system in an office building: a thermal comfort study

Alessandro Maccarini^{1,*}, Göran Hultmark², Niels C. Bergsøe¹, Alireza Afshari¹

¹Danish Building Research Institute, Aalborg University, Copenhagen, Denmark

²Lindab ICS (Indoor Climate Solutions), Farum, Denmark

*Corresponding email: alm@sbi.aau.dk

SUMMARY

This paper presents an investigation regarding a thermal comfort study carried out in an office building located in Jönköping, Sweden. The particularity is that, in authors' knowledge, this is the first building equipped with a novel active beam system that operates a water loop with temperatures close to room temperature all year round.

Indoor climate parameters such as air temperature and air velocity were measured at four heights in two locations within the occupied zone of a room in the building. Two measuring campaigns were performed: one in winter and one in summer. Both experiments lasted for a continuous period of 24 hours.

The daily monitoring of the thermal environment showed that the room air temperature was between approximately 21 °C and 23 °C all year round. No significant vertical air temperature difference was noticed, and the draught rate was below 10% for most of the cases.

KEYWORDS

HVAC systems, active beams, thermal comfort measurements, low-exergy systems

1 INTRODUCTION

With the consolidation of the demand for thermal comfort, HVAC systems have become an unavoidable asset in buildings. The operation of these systems is, however, responsible for the largest energy end use both in the residential and commercial buildings, accounting for almost half the energy consumed in buildings (Pérez-Lombard et al, 2008). Therefore, the challenge facing engineers and researchers is to design innovative HVAC systems able to provide acceptable levels of thermal comfort while reducing energy use.

Low-exergy building energy systems are defined as systems that provide heating and cooling at temperatures close to room temperature (Hepbasli, 2012). This allows the employment of low valued energy, which can be delivered by sustainable energy sources such as waste heat, river/lake water, solar energy, geothermal applications and heat pumps with a high coefficient of performance (COP). Therefore, the use of low-exergy systems can reduce the environmental impact of buildings. In the context of low-exergy systems, several works have studied the potential of active beam systems.

Active beam systems have been used for more than 20 years in Europe, mainly for cooling purposes, and interest in these systems has increased in North America and Asia during the last decade (REHVA, 2004). These systems incorporate active beams as terminal units.

Active beams are devices able to provide outdoor air, sensible heating and sensible cooling to a space. Figure 1 shows the schematic diagram of a typical active beam. To fully understand the performance of active beam systems, several research studies have been conducted in the past years. These studies mainly focused on the description of fundamentals performance, energy use, thermal comfort and air distribution.

In particular, when it comes to thermal comfort and air distribution, Melikov et al. (2007) studied the importance of heat load and airflow pattern control for occupants' thermal comfort in a test room ventilated with chilled beams.

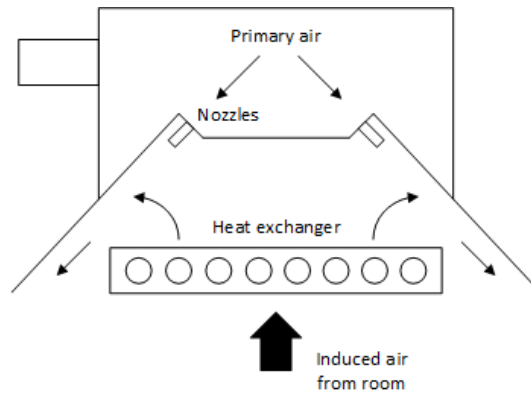

Figure 1 Schematic diagram of an active beam unit

It was found that the percent of subjects dissatisfied due to thermal conditions and draught increased with the increase of the heat load.

Rhee et al. (2015) investigated the thermal uniformity when an active chilled beam system is applied to an open-plan office. Experiments in a test bed showed that chilled beams can provide an acceptable thermal uniformity, with less air flow rate than conventional air distribution systems. Koskela et al. (2010) analyzed the air flow patterns in an open-plan room in Finland. The experiments were conducted with different internal heat loads assuming summer, winter, and spring/autumn conditions. It was shown that the internal heat loads had a significant influence on flow patterns and draught risks.

Generally, it is noted that previous studies focused on the performance of conventional active beam systems, operating only in cooling mode with conventional water temperatures of about 14 °C.

This paper presents a study on thermal comfort in a building equipped with a novel active beam system capable of providing simultaneous heating and cooling of buildings by operating a water loop with temperatures of about 22 °C all year round. Previous studies conducted by the authors (Maccarini et al, 2016) (Maccarini et al, 2017) focused on investigating the energy performance of such a system, but no study was carried out regarding thermal comfort conditions.

Active beam system configurations

According to Figure 2, an active beam system consists of two main parts: a dedicated outdoor air system (DOAS) to satisfy latent loads and ventilation requirements, and a water circuit to meet sensible heating and cooling loads.

The water circuit is typically available in a four-pipe configuration, which includes two supply pipes and two return pipes. As a consequence, some zones can receive cold water while other zones receive hot water, meaning that heating and cooling can be provided simultaneously.

The characteristic of the novel system is its ability to provide simultaneous heating and cooling by using only two pipes. Supply water temperature of about 22 °C is delivered to all the thermal zones in the building, no matter whether a single zone needs heating or cooling. Outlet water from the zones is mixed together, and as a result the system only has to cool or heat the water to stabilize the supply temperature. The overall effect is that the system is able to distribute the excess heat from warm to cold zones when simultaneous heating and cooling demand occurs in the building.

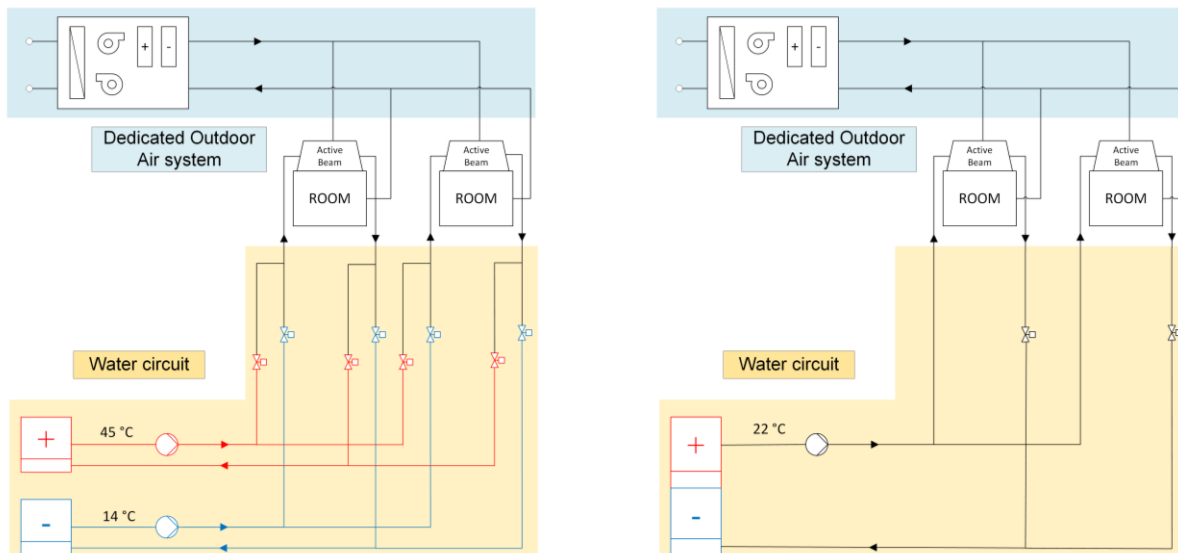

Figure 2 conventional four-pipe system (left) vs. novel two-pipe system (right)

2 METHODS

The Munksjötornet (Figure 3) is a sixteen-storey office building located in Jönköping, Sweden. It was constructed in 2015 and it has a total floor area of approximately 8500 m². In authors' knowledge, this is the first building equipped with the novel two-pipe active beam system illustrated in this work.



Figure 3 Munksjötornet building in Jönköping (Sweden)

Design and sizing the system

The novel system was designed in order to maintain a room air temperature of 21 °C in winter and 23 °C in summer.

As previously mentioned, the system consists of two parts: a DOAS and a hydronic circuit. The DOAS comprises supply and return fans, heating and cooling coils, and a heat recovery unit. Primary air is delivered from the DOAS to each beam with a constant mass flow rate of 0.03 kg/s and a constant temperature of 21 °C. As a consequence, no sensible heating energy is provided by the primary air to the spaces in winter, and only a little amount of sensible cooling energy is provided in summer. Therefore, sensible heating and cooling loads are almost entirely met by the water circuit.

The water circuit was designed to operate with a constant water mass flow rate (0.04 kg/s per each beam), and a variable supply water temperature according to outdoor air temperature. In particular, at extreme cold temperatures, a maximum supply water temperature of 23 °C was set. At extreme warm conditions, a minimum supply water temperature of 20 °C was set. A linear correlation is used between the two extreme points.

In terms of sizing, a total amount of approximately 550 active beam units named SOLUS (Lindab A/S 2016) was installed in the building. Each unit has a capacity of approximately 400 W and 700 W respectively in heating and cooling mode, according to the design values of temperatures and mass flow rates previously mentioned. Note that, due to the low temperature difference between room air and water, the two-pipe system required approximately four-times more active beam units than a four-pipe system operating with conventional water temperatures. On the other hand, the two-pipe system needed only one water pump and fewer pipes.

An added benefit of operating the water circuit at temperatures close to room temperature is that the rate of heat transfer is very sensitive to changes in room temperature. This is known as a self-regulation effect (Maccarini et al, 2017). Thanks to this effect, control complexity can be reduced, and therefore no individual room temperature feedback controls were required in the building.

Experiments

The measurements were carried out on the 10th floor of the building, which was still unoccupied at the time the experiment was performed. The winter experiment was performed during a typical cold day in February 2017 in a north-oriented room. The summer experiment was performed during a typical warm day in August 2017 in a south-oriented room. Both rooms present the same floor area of 20 m².

Air temperature and air velocity were measured using two vertical poles located in two positions in each office room. Along the length of these poles, probes were disposed as shown in Figure 4. Measurements were carried out for a continuous period of 24 hours using 5 min time-averaged values. Local thermal discomfort due to draught and vertical temperature difference was assessed.

The rooms were intended to be a double office room. Therefore, a desk with two computers was placed in the rooms to simulate the heat loads from office equipment. Heat loads from people were simulated by using dummies. Total heat loads were 50 W/m² and they were turned on between 8:00-12:00 and 13:00-17:00. Two active beam units were mounted in the room.

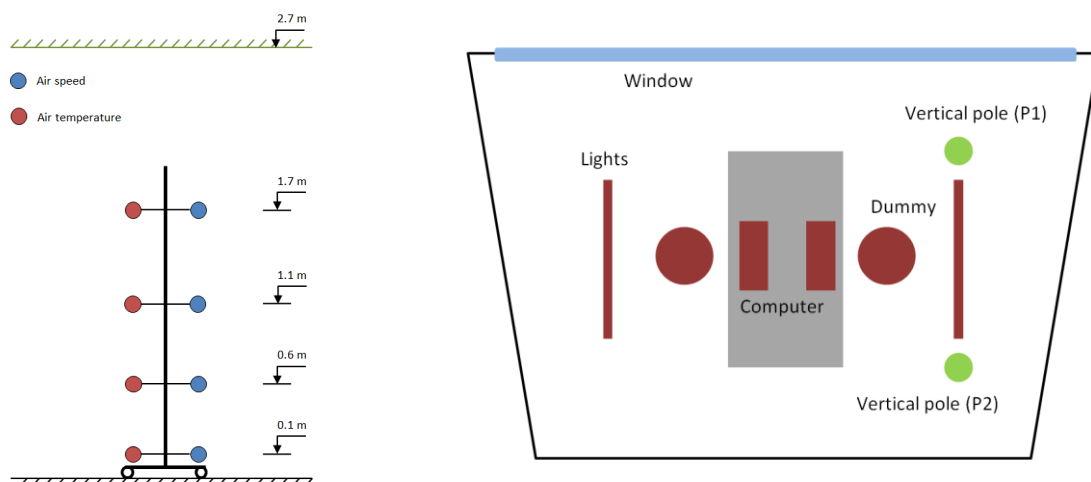

Figure 4 Distribution of probes along the vertical poles (left) and location of poles and heat sources (right)

Air temperature was measured using Indoor Climate Meter (operative range $-40\text{ }^{\circ}\text{C}$ to $125\text{ }^{\circ}\text{C}$, accuracy $\pm 0.3\text{ }^{\circ}\text{C}$), and air velocity was measured using Dantec 54R103 probes (operative range 0.05 m/s to 5 m/s , accuracy $\pm 0.02\text{ m/s} \pm 2\%$ of reading). The technical properties of the measurement equipment are compliant with ISO standard 7726 (ISO 7726:1998).

As the measurements were conducted during actual operation of the system, test conditions varied dynamically throughout the experiments. This was mainly due to the fluctuation of supply water temperature (regulated as described above), internal heat gains (turned on-off) and outdoor climate conditions.

3 RESULTS AND DISCUSSION

Daily monitoring of air temperature

Figure 5 illustrates the air temperature values recorded during the winter day for both vertical poles. The minimum air temperature was $20.9\text{ }^{\circ}\text{C}$ and was obtained for P1 in the early morning at 0.1 m above the floor. The maximum air temperature was $22.8\text{ }^{\circ}\text{C}$ and was obtained for P1 in the late afternoon at 1.1 m above the floor.

Figure 6 shows the air temperature values recorded during the summer day for both vertical poles. The minimum air temperature was $21\text{ }^{\circ}\text{C}$ and was obtained for P1 in the early morning at 1.7 m above the floor. The maximum air temperature was $23\text{ }^{\circ}\text{C}$ and was obtained for P1 in the late afternoon at 0.6 m above the floor.

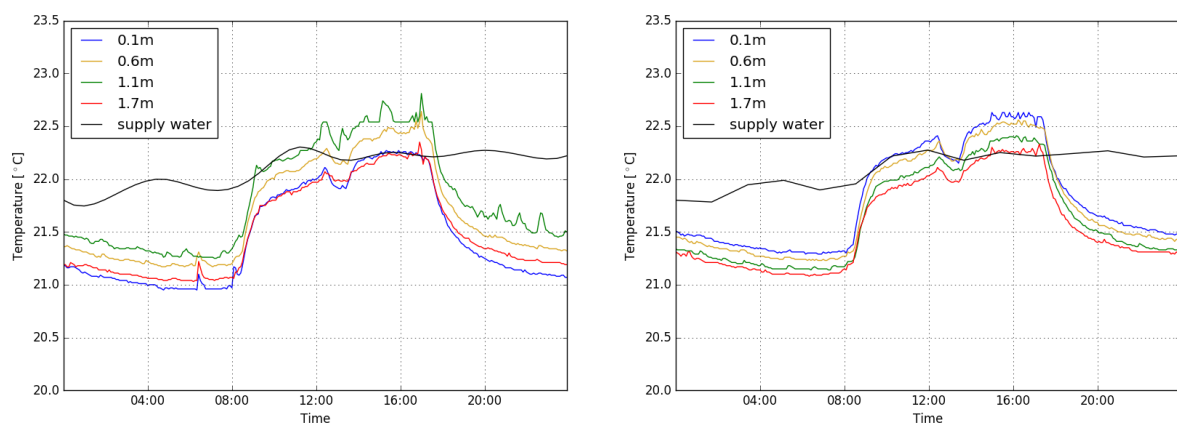

Figure 5 Air temperature profiles for the winter day – 28th of February: P1 (left) and P2 (right)

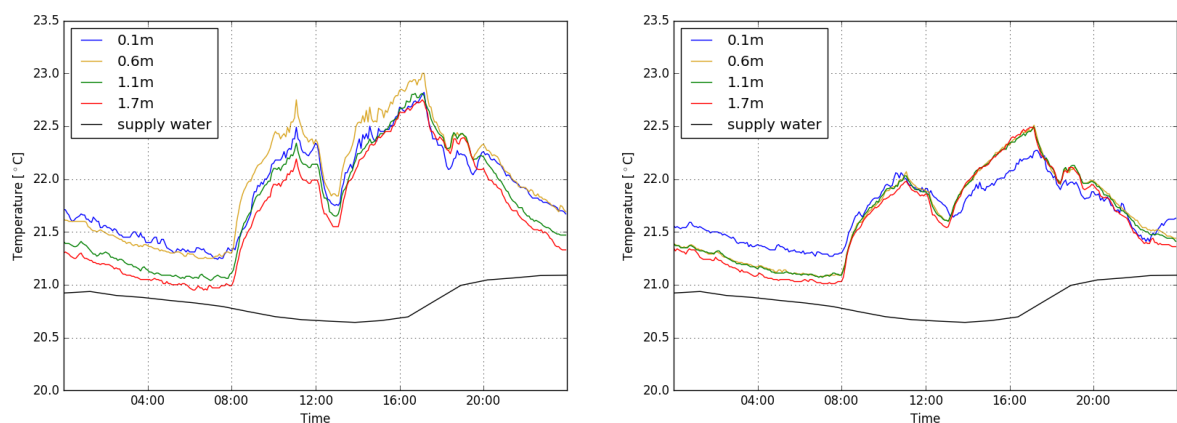

Figure 6 Air temperature profiles for the summer day – 22th of August: P1 (left) and P2 (right)

Generally, the room air temperature is confined between $21\text{ }^{\circ}\text{C}$ and $23\text{ }^{\circ}\text{C}$ all year round. Therefore, it can be concluded that the actual operation of the system matches the predicted operation, as calculated during the sizing of the system. Note that the low air temperatures

observed in summer during non-working hours are due to the continuous operation of the system. At night, water at about 20 °C circulates in the system, providing cooling energy to the building. As a consequence, as shown in Figure 6 for P2, early mornings might be slightly too cold, with room air temperatures below 22 °C.

Vertical air temperature difference

Thermal stratification that results in the air temperature at the head level being warmer than at the ankle level may cause thermal discomfort. The vertical air temperature difference is shown in Figure 7 for two representative values of air temperature at each height. These two representative values are the average temperatures occurring during the periods 10:00-11:00 and 15:00-16:00, which are treated as a steady-state periods (temperature cycles <1 K and temperature ramps <2 K/h).

Considering the difference between head level (1.1 m, seated) and ankle level (0.1 m), it is noted that, with regards to the morning period, the temperature increases upward only for P1 in winter. The vertical temperature difference is 0.31 °C. With regards to the afternoon period, the temperature increases upward for P1 in winter and for both P1 and P2 in summer. The vertical temperature difference is 0.37 °C, 0.01 °C and 0.25 °C for P1 in winter, P1 in summer and P2 in summer, respectively.

Therefore, according to ISO standard 7730 (ISO 7730:2005), all the four cases fall within the thermal environment defined as category A - vertical air temperature difference less than 2 °C. The other cases present a thermal stratification that occurs in the opposite direction. This situation is usually perceived more favorable from occupants, and, therefore, it is not addressed. Generally, it can be concluded that the room is well-mixed, and there is no significant thermal stratification in the space.

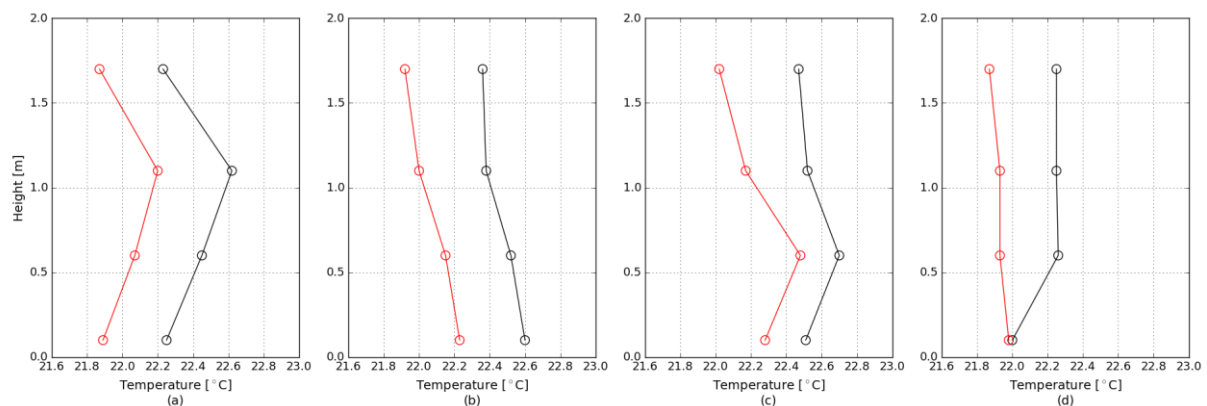

Figure 7 Vertical air temperature differences for the morning period (red) and the afternoon period (black): P1 winter (a), P2 winter (b), P1 summer (c), P2 summer (d).

Daily monitoring of air velocity and draught rate

Figure 8 shows the air velocity values recorded during the winter day for both vertical poles. The minimum air velocity was 0.045 m/s and was obtained for P2 in the early morning at 0.6 m above the floor. The maximum air velocity was 0.15 m/s and was obtained for P1 in the late afternoon at 0.6 m above the floor.

Figure 9 illustrates the air velocity values recorded during the summer day for both vertical poles. The minimum air velocity was approximately 0.025 m/s and was obtained for P1 in the early morning at 1.1 m above the floor. The maximum air velocity was approximately 0.19 m/s and was obtained for P2 in the afternoon at 0.1 m above the floor. It is noted that the values recorded during the summer day present high fluctuation. This might be due to high turbulence intensity.

Recommendations for air velocity and draught rate (DR) in spaces are given in several international and national documents. ISO standard 7730 (Table A.5) provides following design criteria for office environment:

- Category A (DR 10%): summer 0.12 m/s, winter 0.10 m/s
- Category B (DR 20%): summer 0.19 m/s, winter 0.16 m/s
- Category C (DR 30%): summer 0.24 m/s, winter 0.21 m/s

Therefore, in terms of maximum air velocity, the thermal environment provided by the novel two-pipe system would fall in Category B.

With regard to draught, this is defined as unwanted local cooling of the body caused by air movement. Draught rate is calculated from Equation 1:

$$DR = (34 - T)(\bar{u} - 0.05)^{0.62}(0.37 \cdot \bar{u} \cdot Tu + 3.14) \quad (1)$$

where T is the air temperature, \bar{u} is the main air velocity and Tu is the turbulence intensity.

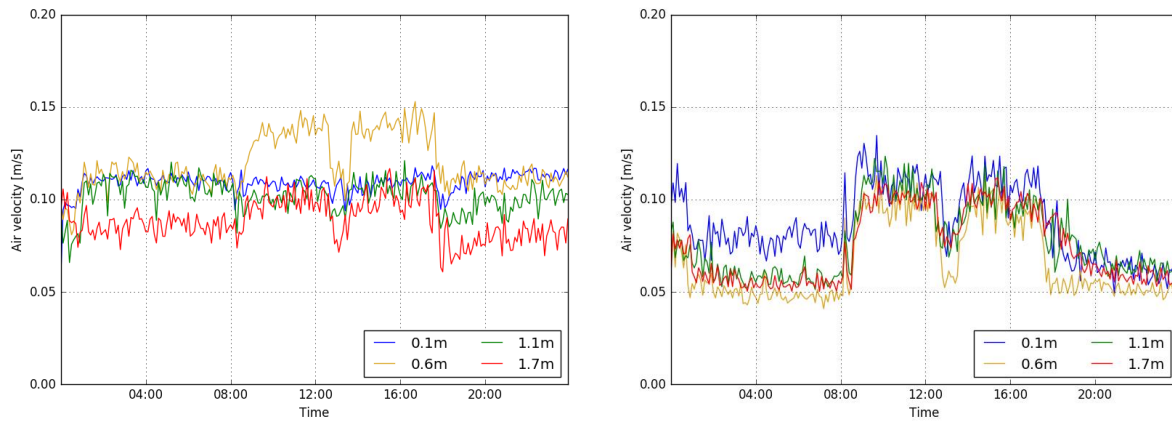

Figure 8 Air velocity profiles for the winter day: P1 (left) and P2 (right)

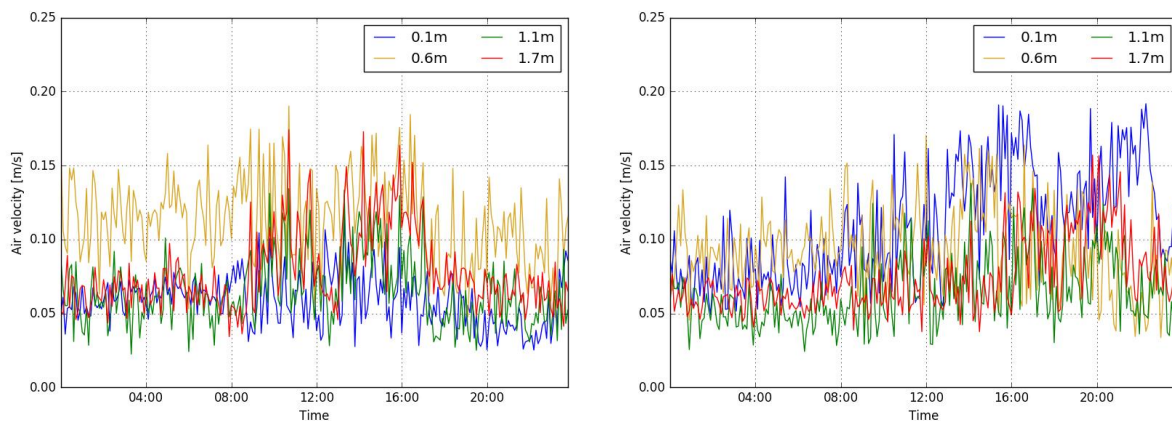

Figure 9 Air velocity profiles for the summer day: P1 (left) and P2 (right)

Table 1 shows the DR for the two vertical poles for both winter and summer days. The results were averaged during the period 15:00-16:00.

It is noted that most of the draught rates fall into category A (<10%). In few cases, the draught rate falls into category B. In particular, these are P1 at 0.6 m above the floor in winter and summer, P1 at 1.7 m above the floor in summer and P2 at 0.1 m above the floor in summer.

Table 1 Draught rates

	P1 winter (%)	P2 winter (%)	P1 summer (%)	P2 summer (%)
0.1 m	8.7	8.4	3	14.3
0.6 m	11.6	8.2	11.1	9.8
1.1 m	8	8	5.8	4.7
1.7 m	8	7.9	10.3	4.4

4 CONCLUSIONS

This paper presents a thermal comfort study of a novel HVAC system that operates a hydronic circuit with water temperatures near room temperature. The measurements were carried out in two office rooms of an existing building. Two vertical poles were used for the experiments. Along the length of these poles, air temperature and air velocity probes were disposed. Two measurement sessions were performed: one in winter and one in summer. Both sessions lasted for a continuous period of 24 hours. Two local discomfort parameters were assessed: discomfort due to draught and vertical air temperature difference.

The daily monitoring of air temperature showed that the room air temperature in the space was between approximately 21 °C and 23 °C all year round, which is in accordance with the assumed sizing of the system. No significant vertical air temperature difference was noticed, and the draught rate was below 10% for most of the cases.

Generally, the system maintains a quite constant room air temperature throughout the year (22 °C ±1 °C), without the use of any feedback controller. This behaviour is known as self-regulation effect, and it is due to the continuous operation of the system with water temperatures close to room temperature.

Further studies will investigate the overall perceived thermal comfort in occupied spaces of the building. In addition, the energy performance of the system is currently under monitoring.

5 ACKNOWLEDGEMENT

This study was financially supported by ELFORSK, a research and development program administrated by the Danish Energy Association.

6 REFERENCES

- International Standard ISO 7726:1998.
 International Standard ISO 7730:2005.
 Hepbasli A. 2012. *Renewable and Sustainable Energy Reviews*. Volume 16(1).
 Koskela H, Hägglblom H, Kosonen R, Ruponen M. 2010. *Building and Environment*. Volume 45(9).
 Lindab A/S, 2016. Solus Supply air beam.
 Maccarini A, Wetter M, Afshari A, Hultmark G, Bergsøe NC, Vorre A. 2017. *Energy and Buildings*. Volume 134.
 Maccarini A, Afshari A, Hultmark G, Bergsøe NC, Vorre A. 2016. *In Proceedings of 12th REHVA World Congress*. 23–26 May, Aalborg, Denmark.
 Melikov A, Yordanova B, Bozhkov L, Zboril V, Kosonen R. 2007. *In Proceedings of CLIMA conference*, 10-14 June, Helsinki, Finland.
 Pérez-Lombard L, Ortiz J, Pout C. 2008. *Energy and Buildings*. Volume 40(3).
 Rhee KN, Shin MS, Choi SH. 2015. *Energy and Buildings*. Volume 93.
 REHVA. 2004. Chilled Beam Application Guidebook.