



Aalborg Universitet

AALBORG UNIVERSITY  
DENMARK

## Efficient tongue-computer interfacing for people with upper-limb impairments

Caltenco Arciniega, Hector Alejandro

*Publication date:*  
2011

*Document Version*  
Publisher's PDF, also known as Version of record

[Link to publication from Aalborg University](#)

*Citation for published version (APA):*

Caltenco Arciniega, H. A. (2011). *Efficient tongue-computer interfacing for people with upper-limb impairments*. Center for Sensory-Motor Interaction (SMI), Department of Health Science and Technology, Aalborg University.

### General rights

Copyright and moral rights for the publications made accessible in the public portal are retained by the authors and/or other copyright owners and it is a condition of accessing publications that users recognise and abide by the legal requirements associated with these rights.

- Users may download and print one copy of any publication from the public portal for the purpose of private study or research.
- You may not further distribute the material or use it for any profit-making activity or commercial gain
- You may freely distribute the URL identifying the publication in the public portal -

### Take down policy

If you believe that this document breaches copyright please contact us at [vbn@aub.aau.dk](mailto:vbn@aub.aau.dk) providing details, and we will remove access to the work immediately and investigate your claim.

# Efficient Tongue-Computer Interfacing for People with Upper-Limb Impairments

---

*By*

*Héctor A. Caltenco A.*



*Dissertation Submitted for the degree of Doctor of Philosophy*

*Center for Sensory-Motor Interaction*

*Dept. of Health Science and Technology*

*Aalborg University*

*Aalborg 2011*

ISBN (print edition): 978-87-7094-115-0

ISBN (electronic edition): 978-87-7094-116-7

# Preface

THE present Ph.D. dissertation, entitled “Efficient tongue-computer interfacing for people with upper-limb impairments” is based on the work done at the Center for Sensory-Motor Interaction (SMI) at Aalborg University, Denmark and at Certec, Department of Design Sciences at Lund Institute of Technology, Lund University, Sweden during the period of March 2007 to January 2011. The work was made possible by grants from the Danish Ministry of Science and Innovation and support provided by TKS A/S.

The objectives of this Ph.D. Studies were to research methods for designing an accurate and efficient tongue-computer interface, which would ensure sufficient degree of control and correct interpretation of the user’s wishes. Result from these studies showed that tongue-computer interfacing is a feasible way for people with severe upper-limb impairments to control a personal computer. Tongue-computer interfacing methods that allow the user to effectuate fast and accurate commands were obtained using visual and auditory feedback techniques. These methods show promising results as an alternative text-input and mouse-pointer control method for individuals with severe physical disabilities. Motor learning evidence supports the notion that the tongue can rapidly learn the necessary motor to control personal computers using a tongue-computer interface.

This thesis is addressed to all researchers who are interested in tongue-computer interfacing methods and the possibility of designing intra-oral assistive devices and is divided into 3 chapters. **Chapter 1** comprises the introductory section, which provides background information on human-computer interaction and computer interfaces for people with upper-limb mobility impairments. It also presents state of the art methods on tongue-computer interfacing and the tongue control system used for these studies. **Chapters 2** summarizes the specific aims, methodology and main results of the five studies performed during the Ph.D. research. **Chapter 3** presents the closing statements, including general discussion, future work and conclusion. The report contains two appendices in which technical information of design aspects that complements this work but has not been published is presented. References are presented according to the Journal of Physics B., from Harvard citation style.

The thesis is based on the following peer-reviewed articles:

- Study 1. **Héctor A. Caltenco**, Björn Breidegard, Bodil Jönsson, Lotte N.S. Andreasen Struijk. *Understanding computer users with tetraplegia: Survey of assistive technology users*. In: International Journal of Human-Computer Interaction. Online: May 2011. DOI: 10.1080/10447318.2011.586305
- Study 2. **Héctor A. Caltenco**, Eugen R. Lontis, Shellie A. Boudreau, Bo Bentsen, Johannes J. Struijk, Lotte N. S. Andreasen Struijk. *Tip of the tongue selectivity and motor learning in the palatal area*. In: IEEE Transactions on Biomedical Engineering. Online: Aug 2011. DOI: 10.1109 / TBME.2011.2169672
- Study 3. **Héctor A. Caltenco**, Eugen R. Lontis, Bo Bentsen, Lotte N. S. Andreasen Struijk. *Computer Input with the tip of the tongue*. Submitted to: International Journal of Human-Computer Interaction. (Submitted July 2011).
- Study 4. **Héctor A. Caltenco**, Eugen R. Lontis, Bo Bentsen, Lotte N. S. Andreasen Struijk. *Effects of sensory feedback in intra-oral target selection tasks with the tongue*. Submitted to: Disability and Rehabilitation: Assistive technology. (Submitted July 2011).
- Study 5. **Héctor A. Caltenco**, Björn Breidegard, Lotte N.S. Andreasen Struijk. *On the tip of the tongue: Learning typing and pointing with an intra-oral interface*. Submitted to: Human Factors. (Submitted July 2011).

All rights reserved. This work may not be reproduced in whole or in part by photocopy or other means, without permission of the author.

# Acknowledgements

THE work presented in the following chapters was made possible by the support from many people. First, I would like to thank my supervisors: Dr. Lotte N.S. Andreasen Struijk for her experience, advices and support during the whole realization of the Ph.D. project; Dr. Johannes Struijk for his valuable discussions about certain aspects of the project; and Dr. Björn Breidegard, who was not only my supervisor, but a very supportive friend during my stance at Certec, Lund University and who was critical and constructive towards my work. Many thanks to Professor Bodil Jönsson, for sharing her immense knowledge at the startup phase of the project.

Special thanks to all my experiment participants and survey respondents, without whom these studies wouldn't have been possible. I thank them for their patience and for withstanding the boredom of my sometimes too long experiments and even longer survey. Special thanks to Dr. Romulus Lontis, whom not only helped me with the realization of some experiments, but also with the fabrication of equipment used. Many thanks Dr. Henrik Vie Christensen for all the technical support provided during the project and his eagerness to always “put out the fire”. Thanks to Morten E. Lund, for taking over some of the work I started and making it work on the embedded system. Thanks to Jette Bjerrum for the economic support for demonstrations of the prototype.

Many thanks to Dr. Bo Bentsen and Dr. Leif Alenmyr for their help with the production of dental models for the experiment participants. Thanks to Dimitrios Kechagias and Howard Gutowitz, from Eaton Ergonomics, for providing the disambiguation algorithm to accelerate typing. Special thanks to Dr. Shellie Boudreau for improving the quality of the papers and to Malgorzata Caltenco and Eileen Deaner for proofreading some papers. Warm thanks to the research personal at Certec for being very supportive and helpful during my stance in Sweden. My gratitude to all the technicians and secretaries and to my colleagues at SMI, especially to my office mate Daniel and my “lunch mates”.

Thank you to my parents for their continuing support. And finally, my most profound acknowledgement to my wife, Gosia, for her unconditional love and support. I thank her for moving back and forth between countries and making this whole journey with me.

---

Héctor A. Caltenco A.  
February 2011

# Abbreviations

|                        |                                                 |
|------------------------|-------------------------------------------------|
| <b>ANFIS</b>           | Adaptive Neuro-Fuzzy Inference System           |
| <b>AT</b>              | target Activation Time                          |
| <b>AU</b>              | Activation Unit                                 |
| <b>CI</b>              | Confidence Interval                             |
| <b>CM</b>              | Confusability Map                               |
| <b>capm</b>            | compensated activations per minute              |
| <b>CT</b>              | Time to Correct errors                          |
| <b>CU</b>              | Central Unit                                    |
| <b>cwpm</b>            | compensated words per minute                    |
| <b>DT</b>              | character Disambiguation Time                   |
| <b>ER</b>              | Error Rate                                      |
| <b>FIS</b>             | Fuzzy Inference System                          |
| <b>GUI</b>             | Graphical User Interface                        |
| <b>HCI</b>             | Human-Computer Interaction                      |
| <b>iapm</b>            | involuntary activations per minute              |
| <b>ID</b>              | Index of Difficulty                             |
| <b>ITCI</b>            | Inductive Tongue Computer Interface             |
| <b>ITCS</b>            | Inductive Tongue Control System                 |
| <b>ITR</b>             | Information Transfer Rate                       |
| <b>MPU</b>             | Mouthpiece Unit                                 |
| <b>MSD</b>             | Minimum String Distance                         |
| <b>MSE</b>             | Mean Squared Error                              |
| <b>MT</b>              | Movement Time                                   |
| <b>OSK</b>             | On-Screen Keyboard                              |
| <b>PCB</b>             | Printed Circuit Board                           |
| <b>QUIS</b>            | Questionnaire for User Interaction Satisfaction |
| <b>SCI</b>             | Spinal Cord Injury/Injuries                     |
| <b>SD</b>              | Standard Deviation                              |
| <b>SR</b>              | target Selection Rate                           |
| <b>TCP</b>             | Tongue Clickpad                                 |
| <b>TDS</b>             | Tongue Drive System                             |
| <b>TFP</b>             | Tongue Functionpad                              |
| <b>TKP<sub>M</sub></b> | Tongue Keypad with Matrix                       |
| <b>TKP</b>             | Tongue Keypad                                   |
| <b>TMP</b>             | Tongue Mousepad                                 |
| <b>TP<sub>F</sub></b>  | Path Following Throughput                       |
| <b>TP<sub>P</sub></b>  | Pointing Throughput                             |
| <b>TP<sub>T</sub></b>  | Typing Throughput                               |
| <b>TTK<sup>®</sup></b> | Tongue-Touch-Keypad                             |
| <b>TT<sub>T</sub></b>  | relative Time on Target                         |
| <b>USB</b>             | Universal Serial Bus                            |
| <b>wpm</b>             | words per minute                                |

# English Summary

**A**N efficient interface between the user and the computer system that ensures the correct degree of control and the correct interpretation of the user's wishes is vital for human computer interaction. Individuals with upper-limb impairments may not have the ability to efficiently control standard input devices, such as a keyboard or mouse. They may need a computer interface requiring a minimum number of physical operations or movements. However, a fair number of operations can still be allowed in computer interfaces for some people that still have complete mobility and control of complex manipulators, such as tongue and eyes in the case of individuals with spinal cord injury.

Researchers have studied several interfaces that provide people with severe upper-limb impairments the possibility to control a computer, such as: head trackers, gaze trackers, voice recognition software, chin or mouth joysticks, single switch or switch arrays, tongue-operated interfaces and even brain-controlled interfaces. But only a few systems became commercially available and even fewer seemed to last in the market. Partly because they are either specialized to specific types of users, or because they are very general, leading to inefficient interaction. Another problem is the way computer interfaces deal with ambiguity. Because the available motor capabilities of people with tetraplegia are scarce, these people may not have the ability to efficiently use standard input devices. Therefore computer interface designers often minimize the number of keys or functions available for use. In many cases assistive interface designers over-restrict the number of functions, leading to single switch interfaces where the user can only press one button, resulting in slow and tedious interaction.

It is a challenge to build computer interfaces that are simple and as little specialized as possible, but still are able to perform efficiently and with sufficient number of functions. These computer interfaces may enable individuals with upper-limb impairments to control a computer as efficiently as an able-bodied user can control it with a standard mouse and keyboard.

To be functionally and commercially successful, assistive computer interfaces must provide quick and efficient control commands, and must ensure a sufficient degree of control and correct interpretation of the user's wishes. This may imply that the interface is easy to use and does not easily induce fatigue. Also, the system must be able to control different equipment apart from a desktop computer and it must also be potentially useful for a broader group of users (with several types of disabilities and preferably also for able bodied people). The more versatile and flexible the control system is, the more applications the user would be able to control with a single interface, and the more it would be useful for a larger part of the population.

The objectives of this Ph.D. research are to investigate methods for designing an accurate and efficient inductive tongue-computer interface (ITCI), which ensures a sufficient degree of control and a correct interpretation of the user's wishes. In order to design efficient tongue-computer interfacing methods for people with movement disabilities, several studies were performed. In the first study, a web survey was performed, which collected potential users' opinions of their current computer interfaces. Also their desirable applications for future independent control of assistive devices were assessed. The study provided valuable insight on what should be done and what should be avoided when designing assistive computer interfaces, it also helped to prioritize alternative applications to be interfaced by the ITCI.

In the second study, tongue-selectivity experiments were used to evaluate intra-oral target selection performance. The results showed that intra-oral target selection speed and accuracy are highly dependent on the location and distance between targets. Performance was faster and more accurate for targets located farther away from the base of the tongue in comparison to posterior and medial targets. A regression model was built, which predicts intra-oral target selection time based on target location and movement amplitude more accurately than standard models of human movement in human-computer interaction. The results helped to determine the appropriate number of intra-oral targets and their optimal location.

The third study evaluated functionality of the ITCI as a text-input and pointing device. Character selection and target pointing and tracking exercises were performed on able-bodied participants to evaluate the typing and pointing performance over three consecutive training sessions. From this study, it was clear that it was necessary to improve the accuracy of sensor selection for text-input with the ITCI. Therefore a fourth study evaluated three

different feedback types that improve the accuracy of text-input. Visual feedback improved text-input performance the most. Tactile feedback did not improve accuracy of sensor selection and slowed sensor selection speed. Even though mouse-pointer feedback improved text-input accuracy using an on-screen keyboard, it slowed text-input speed the most. Therefore visual feedback was selected as the default typing feedback method for further studies and further development of the ITCI.

Previous studies have assessed motor learning during three consecutive day sessions and drawn conclusions based on that short-term training period. Moreover, character typing tasks have been performed assigning only one character to each sensor. The fifth and final study evaluated typing and pointing performance of the ITCI over an 18-session training regime dispersed over a period of two months. This study was also used as an iterative design process of tongue-computer interface software that extends the functionality of the ITCI. The software provides visual and auditory feedback for sensor selection and command acknowledgement and provides the text prediction capabilities that improve text-input.

In summary, results from the studies showed that the ITCI is a feasible way to control a personal computer. Tongue-computer interfacing shows promising results as an alternative text-input and mouse-pointer control method for individuals with severe physical disabilities. Motor learning evidence supports the notion that users can rapidly learn novel motor tongue-tasks, and the viability of using the tongue to control personal computers.



# Danish Summary

ET effektivt interface mellem brugeren og computersystemet, der sikrer en korrekt grad af kontrol og korrekt forståelse af brugerens ønsker, er vitalt for menneskets computerinteraktion. Individuer med skader i overekstremiteterne har ofte ikke evnen til effektivt at kontrollere standard-apparater som f.eks. mus eller tastatur. Disse personer har brug for et computerinterface, som kræver et minimum af fysiske handlinger og bevægelser. Personer, som har skader på rygmarven, men som stadig har fuld mobilitet i og kontrol over komplekse manipulatorer som tunge og øjne, kan dog udføre en del handlinger via computerinterfaces.

Forskere har undersøgt adskillige interfaces, som giver personer med svære skader i overekstremiteten mulighed for at kontrollere en computer, f.eks. ved hjælp af hovedstyring, øjenstyring, stemmegenkendelsessystemer, joysticks på kind eller mund, single switch eller switch array interfaces, tungestyrede interfaces og endda hjerne-kontrollerede interfaces. Men kun få af disse systemer er blevet kommercialiseret og endnu færre er forblevet på markedet. Dette er fordi de enten er for specialiserede og udviklet til specifikke brugergrupper, eller fordi de er meget generelt konstrueret, og derved bliver ineffektive. Et andet problem er den måde, hvorpå computerinterfaces håndterer dobbeltydighed. Da personer med tetraplegi har yderst begrænset motorik, har disse personer ikke mulighed for at anvende standard input-systemer effektivt. Derfor minimerer designere af computerinterfaces ofte antallet af taster eller funktioner i disse interfaces. I mange tilfælde fører dette til single switch interfaces, hvor brugeren kun kan trykke på én knap, hvilket betyder langsommelig interaktion.

Det er derfor en udfordring at konstruere computerinterfaces, der er simple og så lidt specialiserede som muligt, men som stadig er i stand til at fungere effektivt og med et tilstrækkeligt antal funktioner. Disse computerinterfaces bør søge at gøre personer med skader i overekstremiteterne i stand til at kontrollere en computer lige så effektivt, som en person med fuld førlighed kan håndtere en almindelig mus og et tastatur.

For både at blive en funktionel og en kommerciel succes skal et sådant system give hurtige og effektive kontrolkommandoer samt sikre en tilstrækkelig grad af kontrol og korrekt fortolkning af brugerens ønsker. Dette betyder, at interfacet skal være let at anvende og ikke gør brugeren træt. Systemet skal endvidere kunne kontrollere forskelligt udstyr ud over computeren, og det skal også være potentielt anvendelig for en bred gruppe af brugere (både personer med forskellige typer handicaps og raske personer). Jo mere alsidigt og fleksibelt systemet er, jo flere applikationer vil brugeren kunne kontrollere med et enkelt kontrolsystem, og jo mere anvendeligt bliver systemet for en større del af befolkningen.

Formålet med denne Ph.d.-afhandling har været at undersøge metoder til design af et præcist og effektivt induktivt tunge-computer interface (ITCI), som sikrer en tilstrækkelig grad af kontrol og en korrekt fortolkning af brugerens ønsker. Der er udført fem studier for at kunne designe effektive tunge-computer interface-metoder for personer med bevægelsehandicap. Det første studie omfattede en spørgeundersøgelse, som undersøgte potentielle brugeres mening om deres nuværende computerinterface. Endvidere blev deres ønsker til fremtidig uafhængig kontrol af hjælpemidler vurderet. Studiet gav værdifuld indsigt i, hvad der kunne gøres, og hvad man skulle undgå i forbindelse med design af computerinterfaces. Endvidere hjalp studiet til en prioritering af alternative anvendelsesmuligheder af ITCI.

I det andet studie udførtes tunge-selektivtetsforsøg til at vurdere evnen til at foretage intra-oral selektion af sensorer/mål med tungen. Resultatet viste, at hastigheden og nøjagtigheden af intra-oral selektion var stærkt afhængig af placeringen og afstanden mellem målene. Præstationerne var hurtigere og mere præcise for mål placeret længere væk fra den bagerste del af tungen i sammenligning med posteriore og mediale mål. Der blev opstillet en regressionsmodel, som mere præcist end standard-modeller af menneskelig bevægelse i human-computer-interaktion forudsiger tiden for intra-oral målvælgelse baseret på mållokation og bevægelsesamplitude. Resultaterne gav værdifuld information til fastlæggelse af et passende antal intra-orale mål/sensorer og deres optimale placering.

Det tredje studie vurderede funktionaliteten af ITCI som en tekstininput- og pegeanordning. Studiet bestod af øvelser med selektion af karakterer (tastefunktion) samt målvælging og sporing (muse-funktion) udført af raske personer med deraffølgende vurdering af skrive- og udpegningshastigheden over tre på hinanden følgende

sessioner. I dette studie blev det klart, at det var nødvendigt at forbedre præcisionen af sensorudvælgelsen for tekstinput med ITCI. Derfor skulle et fjerde studie vurdere tre forskellige feedback-typer, som forbedrer præcisionen af tekstinputtet. Visuel feedback gav den bedste forbedring af tekstinput-udførelsen. Taktile feedback forbedrede ikke præcisionen af sensorudvælgelsen og nedsatte hastigheden for sensorudvælgelsen. Selv om muse-markør feedbacken forbedrede tekstinput-præcisionen ved brug af et keyboard på skærmen, gav dette den laveste hastighed for tekstinput. Derfor blev visuel feedback valgt som standard skrive-feedbackmetode for de videre studier og udvikling af ITCI.

Tidligere studier har vurderet den motoriske indlæring ved sessioner på tre på hinanden følgende dage og har anført konklusioner på baggrund af den korte træningsperiode. Endvidere blev skrivning af karakterer udført, hvor der kun var tilladt én karakter til hver sensor. Det femte og endelige studie vurderede skrivnings- og udpegningsudførelsen i ITCI over en periode på to måneder med i alt 18 træningssessioner. Der blev knyttet flere karakterer til hver sensor. Dette studie udgjorde også en iterativ designproces for tunge-computer interface software, som udbygger funktionaliteten af ITCI. Softwaren giver visuel og auditiv feedback for sensorudvælgelse og kommandobekræftelse og har tekstforudsigelsesfacilitet, som forbedrer tekstinputtet.

Kort sagt viste studierne, at ITCI er en mulig måde at kontrollere en computer for personer med alvorlige skader i overekstremiteten. Tungecomputerinterfacet viser lovende resultater som en alternativ tekstinput- og musemarkør-kontrolmetode for personer med alvorlige fysiske funktionsnedsættelser. Den motoriske indlæringsevidens fra dette studie understøtter ideen om, at tungen hurtigt kan lære nye motoriske opgaver, og dermed er der mulighed for at anvende tungen til kontrol af computere.

# Table of Contents

|                                                                                          |           |
|------------------------------------------------------------------------------------------|-----------|
| <b>CHAPTER 1: INTRODUCTION:</b> .....                                                    | <b>1</b>  |
| 1.1 BACKGROUND.....                                                                      | 1         |
| 1.1.1 Motivation .....                                                                   | 1         |
| 1.1.2 Human-Computer Interaction .....                                                   | 1         |
| 1.1.3 Computer Interfaces for Individuals with Tetraplegia .....                         | 2         |
| 1.1.4 Common Problems of Computer-Interface Design for Individuals with Tetraplegia..... | 2         |
| 1.1.5 The Challenge of Computer-Interface Design for Individuals with Tetraplegia .....  | 4         |
| 1.1.6 Control Life – Not Only Computers .....                                            | 4         |
| 1.2 TONGUE-COMPUTER INTERFACING .....                                                    | 5         |
| 1.2.1 The Tongue as an Input Method .....                                                | 5         |
| 1.2.2 State of the Art in Tongue-Computer Interfacing .....                              | 6         |
| 1.2.3 The Tongue’s Input Vocabulary .....                                                | 7         |
| 1.3 THE TONGUE-CONTROL SYSTEM .....                                                      | 8         |
| 1.3.1 Parts of the System .....                                                          | 8         |
| 1.3.2 Evolution .....                                                                    | 9         |
| 1.4 PROJECT DESCRIPTION .....                                                            | 9         |
| 1.4.1 Aims of the Ph.D. Project .....                                                    | 9         |
| 1.4.2 Project Structure .....                                                            | 10        |
| REFERENCES .....                                                                         | 12        |
| <b>CHAPTER 2: AIMS, METHODOLOGY AND RESULTS FOR STUDIES 1 - 5:</b> .....                 | <b>15</b> |
| 2.1 STUDY 1 - SURVEY OF ASSISTIVE TECHNOLOGY USERS .....                                 | 15        |
| 2.1.1 Aims .....                                                                         | 16        |
| 2.1.2 Overview of Methodology .....                                                      | 16        |
| 2.1.3 General Results .....                                                              | 16        |
| 2.1.4 Important Considerations .....                                                     | 17        |
| 2.2 STUDY 2: TIP OF THE TONGUE SELECTIVITY IN THE PALATAL AREA .....                     | 18        |
| 2.2.1 Aims and Research Questions .....                                                  | 19        |
| 2.2.2 Overview of Methodology .....                                                      | 19        |
| 2.2.3 Summary of Results .....                                                           | 20        |
| 2.3 STUDY 3: COMPUTER INPUT WITH THE TIP OF THE TONGUE .....                             | 21        |
| 2.3.1 Aims and Research Questions .....                                                  | 22        |
| 2.3.2 Overview of Methodology .....                                                      | 22        |
| 2.3.3 Summary of Results .....                                                           | 23        |
| 2.4 STUDY 4: EFFECTS OF SENSORY FEEDBACK IN INTRA-ORAL TARGET SELECTION .....            | 24        |
| 2.4.1 Background .....                                                                   | 25        |
| 2.4.2 Aims and Research Questions .....                                                  | 25        |
| 2.4.3 Overview of Methodology .....                                                      | 25        |
| 2.4.4 Summary of Results .....                                                           | 26        |
| 2.5 STUDY 5: TYPING AND POINTING WITH AN INTRA-ORAL COMPUTER INTERFACE .....             | 27        |
| 2.5.1 Background .....                                                                   | 27        |
| 2.5.2 Aims .....                                                                         | 28        |
| 2.5.3 Overview of Methodology .....                                                      | 28        |
| 2.5.4 Typing performance .....                                                           | 28        |
| 2.5.5 Pointing performance .....                                                         | 29        |
| 2.5.6 Summary of Results .....                                                           | 29        |

|                                                                                     |           |
|-------------------------------------------------------------------------------------|-----------|
| REFERENCES .....                                                                    | 30        |
| <b>CHAPTER 3: DISCUSSION AND CONCLUSION: .....</b>                                  | <b>33</b> |
| 3.1 SUMMARY AND DISCUSSION .....                                                    | 33        |
| 3.2 FUTURE WORK .....                                                               | 35        |
| 3.2.1 Optimal Character Arrangement.....                                            | 35        |
| 3.2.2 General Usability .....                                                       | 35        |
| 3.2.3 Iterative Design of a Tongue-Computer Interface .....                         | 36        |
| 3.2.4 Explore Tongue’s Input Vocabulary.....                                        | 36        |
| 3.3 CONCLUSION .....                                                                | 36        |
| REFERENCES .....                                                                    | 37        |
| <b>APPENDIX A: .....</b>                                                            | <b>39</b> |
| INDUCTIVE SENSORS AND ACTIVATION SIGNALS OF THE INDUCTIVE TONGUE-COMPUTER INTERFACE |           |
| 1 INDUCTIVE SENSORS .....                                                           | 39        |
| 2 SIGNAL PROCESSING .....                                                           | 39        |
| 3 SENSOR GEOMETRY AND SIGNALS .....                                                 | 40        |
| REFERENCES .....                                                                    | 40        |
| <b>APPENDIX B: .....</b>                                                            | <b>41</b> |
| AUTOMATIC CALIBRATION OF THE INDUCTIVE TONGUE-COMPUTER INTERFACE                    |           |
| 1 INTRODUCTION .....                                                                | 41        |
| 2 AUTOMATIC CALIBRATION .....                                                       | 41        |



# Chapter 1: Introduction

## 1.1 BACKGROUND

### 1.1.1 Motivation

**S**PINAL cord injuries (SCI) or brain injuries due to accidents or diseases such as multiple sclerosis, muscular dystrophy or transverse myelitis may lead to tetraplegia. This is a condition that results in the partial or total loss of the sensory and motor functions of all limbs and torso. A physically disabled individual may not have the ability to efficiently control standard computer input devices, such as Qwerty keyboard or mouse. Correspondence between the user's cognitive and physical gestures (effectors) might be corrupted, which means that even though the user may want to perform an action, physical impairments do not allow him/her to do so.

Researching human-computer interaction methods and designing interfaces that allow individuals with tetraplegia to control computers and other technologies is of vital importance. In an era where computers and other electronic equipment have become a very important part of everyday life, the ability to control this equipment can be the difference between a good and bad quality of life. The use of computers and information technologies can increase the communication possibilities of citizens, efficiency of industry and productivity of employees. These aspects are potentially invaluable for severely disabled individuals, such as those with tetraplegia, for whom the access to different technologies may be a possibility to become more independent. Increased use of computers and other technologies by these individuals may also reduce the need for healthcare and therefore reduce welfare expenses.

### 1.1.2 Human-Computer Interaction

Human-Computer interaction (HCI) is concerned with the design, implementation, and evaluation of interactive computer-based systems, as well as with the study of factors affecting this interaction, such as safety, efficiency, accessibility, usability and even likeability of such systems. The proliferation of com-

puter-based systems and applications has introduced new dimensions to the issue of HCI. Human activities are increasingly becoming dependent on computers, which are no longer conceived as mere business or industry tools, but as integrated environments, accessible by *anyone, anytime, and anywhere* (Stephanidis 2001).

There are a number of ways in which the user can communicate with the computer. The normal interactive approach is that the user provides instructions to the system and receives feedback. This interaction can be divided into four main components: the user, the system, the input and the output (Dix et al. 1997). The user receives information output by the computer, and responds by providing input to the computer – the user's output becomes the computer's input and vice versa. Each component has its own language. The system's language describes computational attributes of the domain relevant to the system's state, whereas the user's language describes psychological attributes of the domain relevant to the user's state. The communication channel that translates input and output between the user and the system is the interface. Input in the human occurs through the senses (mainly vision and hearing) and output through the motor control of the effectors. Input from the user is translated to the system's language as operations to be performed by the system, and output from the system is translated and presented to the user in an "observable" form (Figure 1-1).

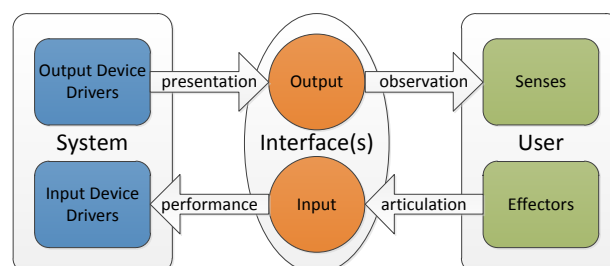

Figure 1-1. Translation between components of the human-computer interaction framework.

## 1.1 Background

---

Articulation signals are traditionally given by movement of legs, arms, fingers or by applying pressure on keys or touch-panels. Some other, more sophisticated human articulation signals could be eye-motions, speech, limb/body motions (Breidegard 2006), breath and electrical body voltages. Performance and presentation signals are sets of electric pulses (digital or analog) sampled by the computer through a number of ports and drivers that communicate with the input/output interfaces. Immediate feedback (observation signals) to the user is mandatory, and is ensured by the output interface. This feedback could be, e.g., a displayed image, sounds produced by the computer, etc. However feedback can also be produced from the input interface, e.g., feeling of the button at the tip of the finger, sound produced when a key is hit, image and feeling of mouse's movement on the mousepad, etc.

The design of an accurate interface between the user and the system to ensure the correct degree of control and the correct interpretation of the user's wishes is extremely important. The interface plays an important role for determining the quantity and quality of tasks that a user can perform with the system. Both input and output devices should maximize the functionality, accessibility and usability of computer systems. Therefore it is important to develop high-quality computer interfaces, which make computer environments accessible and usable by a diverse user population with different abilities, skills, requirements and preferences, in a variety of contexts of use, and through a variety of technologies.

### 1.1.3 Computer Interfaces for Individuals with Tetraplegia

Unfortunately, the majority of computer programs are designed to receive input from a keyboard and mouse through hand and finger movement. Individuals with tetraplegia may need a computer interface with a minimum number of physical operations or movements (Allen 1996), since they are usually not able to provide any kind of input to ordinary computer systems. However, if the user has complete mobility and control of other effectors such as the mouth or eyes, then operations can be allowed for those effectors.

There have been several efforts to design and evaluate interfaces that provide individuals with tetraplegia the possibility to control personal computers. Some examples are head trackers (Fitzgerald et al. 2009), gaze trackers (Hansen et al. 2004), speech recognition systems (Moore 2004), chin or mouth joysticks (Bolton, Wytych 1992), single switch or switch arrays (Kim, Tyler & Beebe 2005), tongue-operated interfaces (Huo, Wang & Ghovanloo 2007, Andreasen Struijk 2006a), brain-controlled interfaces (Cabrera, Dremstrup 2008) and even body-electricity sensors (Doherty et al. 2002). But only few of these systems are commercially available and even fewer seem to last on the market. It is partly because they are either too specialized, or because they are too simple and general and the interaction is inefficient. For the purpose of this study the trade-off between specialization and simplicity is called "the complexity problem".

### 1.1.4 Common Problems of Computer-Interfaces for Individuals with Tetraplegia

#### *The complexity problem*

The Qwerty keyboard and standard mouse are complex interfaces that can receive fast and accurate high bandwidth input. However they are limited for able-bodied individuals. The more sophisticated and complex a system is the more specialized its target group gets (Steriadis, Constantinou 2003). For example speech recognition systems, head and gaze trackers and some tongue-controlled interfaces are complex systems that can output several channels of data. However these interfaces are limited to individuals that have fine motor control of different body parts and can voice clear commands.

On the other hand simpler devices that can receive user input that leads to single-bit signals are less specialized and can be used for a larger part of the population. However, if the device is too simple and general, computer interaction becomes slow and tedious (Steriadis, Constantinou 2003). Many interfaces, e.g., single switch interfaces and mouth joysticks, translate user output to single commands regardless of the output complexity and take binary decisions. In these systems, an output of 0 could

# Chapter 1: Introduction

stand for no-motion and 1 for positive motion to a specified direction, regardless of the speed and amplitude of movement.

## Accidental invocation

Gaze trackers and speech recognition systems can accidentally activate commands by a reflex or distraction and could lead to erroneous input. A problem occurs when the articulation organ is the same as the observation one, e.g., eyes; this could lead to accidental invocation of commands by inspection of the system's output. Gaze trackers use dwell time techniques to avoid this problem, which has been proven useful for severely disabled users. However these types of systems are normally avoided by individuals that still have some mobility of other effectors available (wrist or head) because the interaction time can sometimes be too long and inefficient (Drewes, Schmidt 2009).

## The ambiguity problem

Another common problem with computer-interfaces is the way they deal with ambiguity. Although the standard PC Qwerty keyboard has 101 or more keys, a user can produce closer to 800 individual key-strokes by using keys in combination with Shift, Ctrl and Alt (MacKenzie, Soukoreff 2002). The keys in the standard PC keyboard are, therefore, ambiguous. Other keyboards, like the telephone keypad, are more ambiguous since they fit the alphabet, numbers and symbols in only 12 keys (Figure 1-2). Even a standard mouse presents ambiguity since its movement alters the position of the cursor on the screen, but when the middle mouse button (scroll-wheel) is pressed, moving the mouse results in scrolling the focused document or page view.

Because the available motor functions of people with tetraplegia are scarce, most of these people may not have the ability to efficiently use standard input devices (Steriadis, Constantinou 2003). Therefore computer interface designers often minimize the number of keys or functions available for use. In many cases this leads to single switch interfaces where the user can only press one button. However, users desire a large number of functions including alphabetic, numeric and symbolic characters, edition keys and even pointing, clicking and scrolling functions.

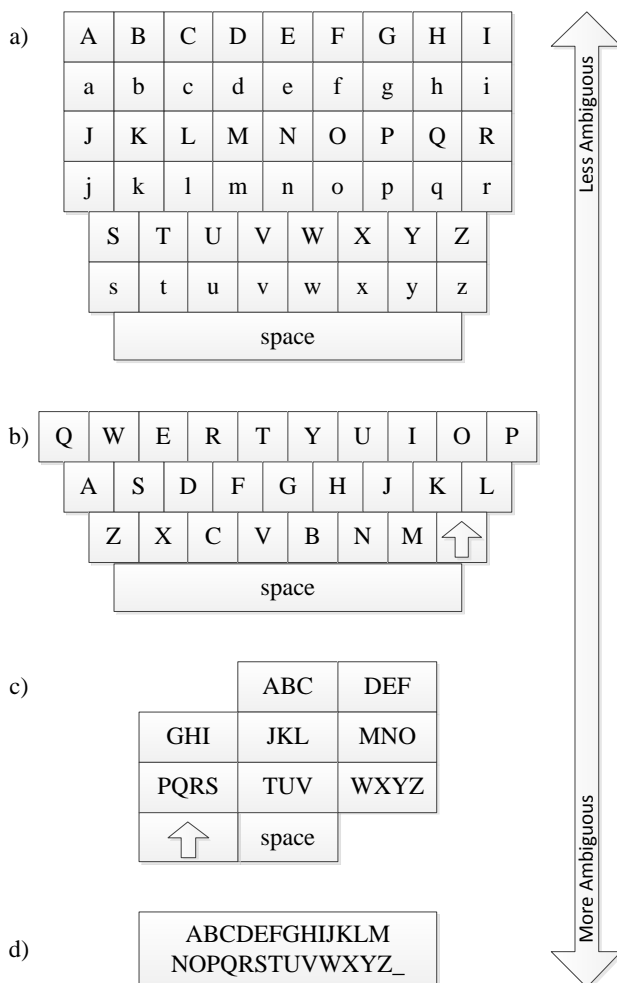

Figure 1-2. The key-ambiguity continuum a) less ambiguous alphabetic keyboard, b) Qwerty keyboard, c) standard telephone keypad, d) hypothetical single-key keyboard. From (MacKenzie, Soukoreff 2002) © Taylor & Francis.

## Acceptability

Finally, input devices must sense the human signals with minimum effort and without causing any kind of discomfort to the user. For example, sip-puff interface users may have trouble with respiration due to constant air blowing, holding breath or arrhythmic respiratory pacing. With switch array interfaces, a hard button could cause fatigue (Steriadis, Constantinou 2003). Some other interfaces that require head movements, controlled respiration or sustained bites present high rates of exertion (Lau, O'Leary 1993). Brain-controlled interfaces and gaze trackers might require complex and lengthy setup and calibration procedures before use. Aesthetics and discretion of wireless or non-visible systems are crucial and often overlooked factors for the acceptance of assistive devices and computer-



## 1.1 Background

---

interfaces for individuals with tetraplegia. Assistive computer interfaces must not interfere with common tasks such as speech. Interfaces that require sustained bites are consistently rated with low acceptability (Lau, O'Leary 1993).

### 1.1.5 The Challenge of Computer-Interface Design for Individuals with Tetraplegia

It is a challenge to build computer interfaces that are simple and as little specialized as possible (complexity problem), but still are able to perform efficiently and with sufficient available functions (ambiguity problem). These interfaces may enable users with tetraplegia to control a computer as efficiently as an able-bodied user can control it with a standard mouse and keyboard. However, even if a device is efficient, accurate and fast, it is not likely to be accepted by users if it causes physical or aesthetic discomfort. All interaction, usability, and acceptability aspects of an interface should be taken into account when designing new computer-interfaces for users with tetraplegia.

### 1.1.6 Control Life – Not Only Computers

Besides being able to control a personal computer, a person with tetraplegia may have special needs that would require several individual devices to assist them at the same time. For example a person with high level spinal cord injury (SCI) may need assistive systems for mobility, environmental control, vocational/educational activities and leisure. If each of these individual needs were treated by a different assistive system, switching between each system could become technically and practically complicated. Therefore the users' needs should be examined in order to integrate them into a single system. The more versatile and flexible the control system is, the more applications the user would be able to control with a single control system.

#### *Environmental control*

There are several standards emerging to allow home appliances to communicate with each other. These standards specify the electrical levels and the language that the appliances will speak. The most common standards are *X-10*, *Smart House*, the *Consumer Electronics Bus* and *LonWorks*. These control

and automation standards use different communication channels. *X-10* is a standard for allowing various *X-10* modules to communicate through the AC power lines within a household. *Smart House* was developed by the National Association of Home Builders as a home automation standard. It uses a central controller to communicate with each appliance. The *Consumer Electronics Bus* standard (by the Electronic Industries Association) and *Lonworks* (by Echelon) do not use a central controller. Instead, the standard specifies compatible wiring in a household and allows any manufacturer to build devices that can communicate with other devices on a Bus. Other similar networking standards for consumer electronics are: the *European Installation Bus*, *INSTEON*, *BACnet*. Some standards can use radio frequency signals (commonly ZigBee) to communicate with the central controller or can be connected via universal serial bus (USB), WiFi or Bluetooth to a central control program in a personal computer.

Unfortunately, it is difficult to find a common protocol for interfacing a control system due to all the different existing electronic devices. It is not clear whether these standards and products will co-exist as competitors or whether a dominant format will emerge. Therefore it is important to match the hardware and software to the most relevant standard depending on the application to be interfaced.

#### *Environmental control framework*

Interfacing different applications (e.g., computers, wheelchairs or electric appliances) by a control system should be done according to the control environments in which the user might work. Allen (1996) defines three different control environments:

- Direct environment: A control environment for devices mounted directly on the user's wheelchair or in immediate vicinity, e.g., interpersonal communicators, computers, manipulators, the wheelchair itself or other mobility systems.
- Fixed environment: A control environment for devices within the normal living or working area, e.g., light switches, kitchen appliances, telephones, door and window opening, etc.

# Chapter 1: Introduction

- Distant environment: A control environment for devices outside the fixed environment, e.g., access to cash machines at banks, traffic control systems and public information systems.

There is a need for creating gateways between environments and adaptable user interfaces to cover as many applications as possible. On a direct environment the control system must have a very safe connection, therefore it should be directly connected by a cable or it should have a very reliable remote link (e.g., point-to-point radio link). On a fixed environment a standard remote link such as Bluetooth, ZigBee, infrared, radiofrequency, etc. is recommended (Allen 1996). Many fixed environment devices already have standard remote links available to connect to a control device (e.g., television, phones, computers, video game consoles, etc.). A big problem arises when trying to interface distant environment devices, which cannot be modified to allow a remote or direct connection (e.g., cash machines at banks, pedestrian traffic light buttons, etc.) and the straightforward interface still, is the human hand. Building computer interfaces that serve as general control systems and can link between the possible control options of each environment (at least direct and fixed), would dramatically increase the quality of life for individuals with tetraplegia.

## 1.2 TONGUE-COMPUTER INTERFACING

### 1.2.1 The Tongue as an Input Method

Spinal cord injury (SCI) is the most common cause of tetraplegia (Smith 2010).. It is estimated that the annual incidence of SCI in the USA is approximately 12,000, and the prevalence up to 2008 is approximately 259,000 (NSCISC 2008). Injuries at the cervical level usually result in full or partial tetraplegia. Injuries at or below the thoracic spinal levels result in paraplegia, therefore function of the hands, arms, neck and breathing are usually not affected. Only 20% of SCI incidents result in complete tetraplegia and 30% in incomplete tetraplegia. The rest are classified as paraplegia or other neurologic categories (NSCISC 2008). Depending on the location of the injury at the cervical level, limited function of limbs below the neck might be retained.

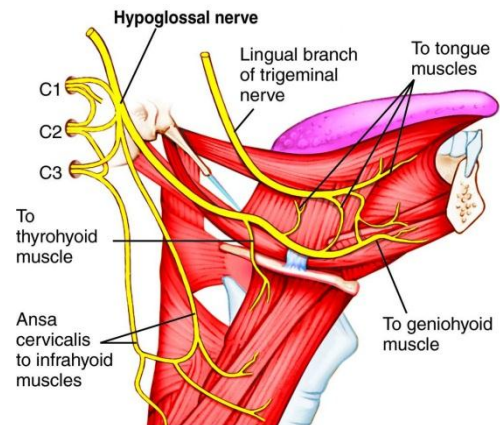

Figure 1-3. Motor innervation of tongue by cranial nerves. From (Mosby 2009) © Elsevier, with permission

Motor innervation of the tongue involves cranial nerves (Figure 1-3) and therefore even people with a high level SCI usually still have good sensory and motor control of the tongue. Although not naturally use for pointing or writing, the tongue can perform sophisticated motor control, e.g., for vocalization, which makes the tongue potentially suitable for computer input.

Another indication for using tongue for computer input is that the somatosensory and motor cortex homunculi (Figure 1-4) shows that the tongue occupies an area in the motor cortex as big as the one of fingers. Therefore the tongue is a good candidate for precise and complex movements. Moreover the tongue, unlike the eyes, has evolved for manipulation and articulation, while the eyes for observation. As discussed in the previous section, using the same organ for computer input and feedback could lead to accidental invocation of commands by inspection, a risk which may be reduced using the tongue.

The tongue muscle has a low rate of perceived exertion and does not fatigue easily. Moreover tongue interfaces might be intra-oral and invisible to other people, which is highly prioritized by assistive device users. In a study comparing three input interfaces (Lau, O'Leary 1993): the *Tongue-Touch-Keypad* (TTK®), the *HeadMaster*® and the Mouthstick, the TTK®, from New Abilities (Fortune, Ortiz & Tran 1993), was preferred by users due to its discretion and low exertion rate, even though it was not the most efficient interface.

## 1.2 Tongue-Computer Interfacing

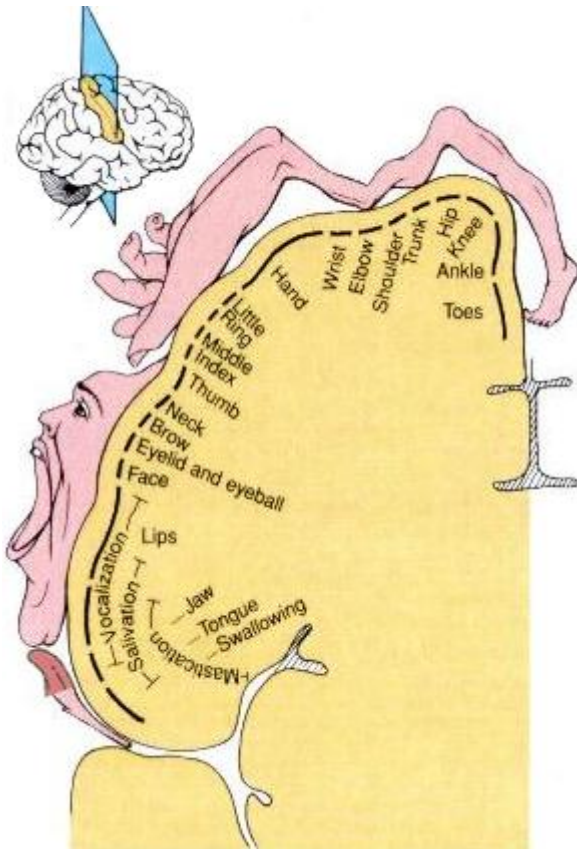

Figure 1-4. Primary motor cortex in right cerebral hemisphere: motor homunculus (Penfield 1950) © Macmillan, NY.

### 1.2.2 State of the Art in Tongue-Computer Interfacing

The aforementioned tongue capabilities have resulted in the development of a few tongue-computer interface devices. Some of these interfaces, like the *Jouse2*<sup>®</sup> (Compusult Limited 2011) and the *IntegraMouse*<sup>®</sup> (Lifetool 2010), are mouth controlled joysticks combined with sip-and-puff devices. These are non-tongue controlled and not intra-oral devices, that if used for long periods of time can cause neck pain and problems with respiration. They are also desk-based interfaces with little mobility and portability.

The TTK<sup>®</sup> (Fortune, Ortiz & Tran 1993), the palatal tongue controller (Clayton et al. 1992) and the tongue-operated switch array (Kim, Tyler & Beebe 2005) are intra-oral interfaces that can be fixed in the roof of the mouth and have buttons or switches that are pressed by the tongue. These intra-oral interfaces are invisible to other persons and often preferred by users during controlled tests (Fortune, Ortiz & Tran 1993). However these devices do not take advantage of the fine motor control of the

tongue, as they only use four to nine sensors, while the tongue can easily pick out all of our 32 teeth. In addition, the use of pressure sensors located on the palatal plate may fatigue the user and reduce the speed of sensor activation.

Other two intra-oral interfaces simulate a standard joystick and touchpads found in laptop computers but are operated by the tongue: The *tongue-mouse* (Nutt et al. 1998) and the *tongue-point* (Salem, Zhai 1997). The *tongue-mouse* uses a 16x16 matrix of piezo-ceramic sensors that detect the strength and position of the touch of the tongue, similar as a touchpad detects the strength and position of fingers. The *tongue-point* is an isometric tongue pointing device that can be fixed in a mouth-piece similar to a dental retainer, the isometric joystick (pointing stick) is located near the roots of the incisive teeth and can be operated by the tongue, similar as an IBM-trackpoint is operated by fingers in laptop-computers.

Saponas et al. (2009) developed a dental retainer with optical sensors that could identify 4 different tongue gestures with over 90% accuracy. *Think-A-Move*<sup>®</sup> (Vaidyanathan et al. 2007) is based on a microphone in the ear that responds to the changes in the ear canal pressure due to tongue movements. The device is not intra-oral but is also partially invisible to other persons. Detecting movements and gestures is beneficial, since there is no need to apply pressure to any part of the mouth or retainer. However these devices were able to classify or recognize only two to four different commands.

The *Tongue drive system* (TDS) (Huo, Wang & Ghovanloo 2007) is a wearable wireless headset that detects the position of a magnetic tracer attached to the tip of the tongue. With which tongue movements can be translated into user-defined commands with high information transfer rate.

Other alternative computer interfaces are designed to substitute or enable the use of keyboard devices (typing sticks, reduced keyboards, switches, etc). Speech recognition software allows the dictation of text or other commands but does not emu-

late pointing. No tongue-computer interfaces to date, with the exception of the Inductive Tongue Control System (Andreasen Struijk 2006a), directly emulate standard keyboard functionality. Most of the aforementioned tongue-computer interfaces are designed to emulate pointing device functionality; they allow keyboard functions only by the use of on-screen keyboards or other typing software. Then, typing simple sentences can become slow and tedious when the pointer has to travel large distances on the screen or the pointer speed is somewhat slow. Directly emulating keyboard devices could improve typing rates if the articulation signal (i.e. tongue movement) is fast and accurate enough to support enough information channels (keys, or sensors), and if the keyboard-emulation ambiguity can be optimized to increase speed without affecting accuracy.

### 1.2.3 The Tongue's Input Vocabulary

From these interfaces we can identify different types of tongue-device interaction, which we'll call the "tongue's input vocabulary". The tongue has multiple degrees of freedom and can freely move in a 3D space within the oral cavity. It has complex movement and manipulation capabilities that can be transformed to a rich input vocabulary. The tongue can manipulate objects (e.g., intra-oral joysticks) by pushing and tilting them. The tongue is able to press against the palate's surface with varying pressure, or tap and slide over it. The tongue can even "communicate" just by moving inside the oral cavity without the need of touching any object.

Depending on the type of tongue-computer interface, the input vocabulary is different. For example, the *Jouse* and the *IntegraMouse* use the lips or tongue to **manipulate** an analog joystick to different directions and control the mouse pointer. Similarly isometric joysticks can be activated by the tongue applying pressure towards different directions. Tongue-operated switch arrays (e.g., TTK) need to be **pressed** against the palate surface. The tongue has only a few possible interactions there: to press-lift and to press-hold each switch or button.

Touchpad-like input devices (palatal interfaces) bring many more possibilities for tongue's input

vocabulary (Figure 1-5). This could efficiently help to discriminate between tracking, activating/dragging, and "menuing" of mouse-pointer options. For instance, the tongue could **tap** (touch-lift) a specific area to activate commands, it can also **hold** to disambiguate or extend commands associated with the selected area. Similar to standard touchpads for controlling mouse-pointer movement, clicks could be emulated by **lift-tap** gestures, tracking with **slide** gestures and dragging with **lift-touch-slide** gestures. Predictive text systems could deduce words automatically by recognizing tongue **sliding** movements across different areas of the palate.

Standard touchpads perform scrolling and zooming functionalities using two fingers. Unlike fingers in touchpads, the tip of the tongue cannot touch two distant areas of the palatal interface at the same time (humans only have one tip of the tongue). Instead, some scrolling, zooming and disambiguation functionalities could be performed by using complex movements of the tongue, like **swiping**, **rolling** or **rubbing** the tongue against the palatal interfaces. Pressure sensitive palatal interfaces have the advantage of allowing a pressure level to disambiguate between, e.g., tracking and dragging, gestures by applying varying amount of **pressure**, instead of having to **tap** or **lift**.

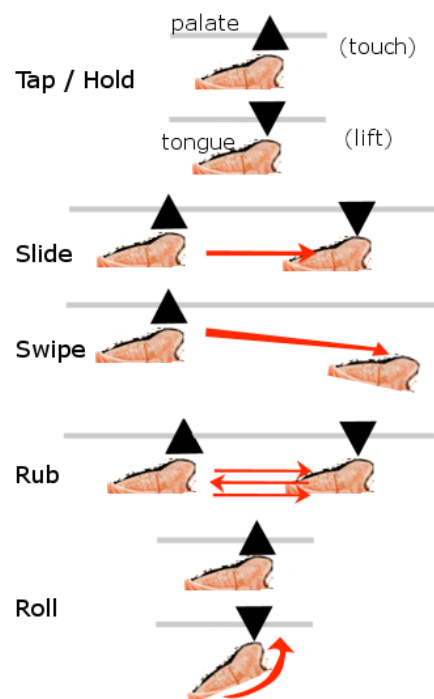

Figure 1-5. Tongue's input vocabulary for palatal interfaces.

## 1.3 Inductive Tongue Control System

Position or movement detection based interfaces (e.g., *Think-A-Move* and TDS) have the advantage of not needing to apply pressure or touch to intra-oral devices; instead just tongue movements can produce many possible movement based tongue-gestures. A disadvantage is that these gestures might be misinterpreted during talking and can interfere with normal use of the tongue.

### 1.3 INDUCTIVE TONGUE CONTROL SYSTEM

The Inductive Tongue Control System (ITCS) (Andreasen Struijk 2006b), which is being developed at Aalborg University and commercialized by TKS A/S, is partly implantable and can incorporate a larger number of sensors than aforementioned tongue-computer interfaces. It is meant to be a palatal interface and therefore can use the input vocabulary described in Figure 1-5. The ITCS seeks to operate within the *direct* and the *fixed* control environments and link to controllable systems using the different communication channels of each environment. During the realization of this project, the ITCS will be used to develop efficient tongue-computer interfacing methods for intra-oral palatal interfaces.

#### 1.3.1 Parts of the System

The ITCS was designed as a modular interface that consists of three different units and other specific interface modules (Figure 1-6):

#### *The activation unit*

The activation unit (AU), is a 4 mm (diameter) by 2 mm (height) cylinder made of biocompatible stainless steel (type SUS 447J1 or Dyna steel), which is fixed (e.g., pierced or glued) 7 to 10 mm posterior to the users' tongue tip. Its function is to alter the inductance of the sensor coils.

#### *The mouthpiece unit*

The mouthpiece unit (MPU) consists of a palatal plate, resembling a dental retainer, with inductive sensors (coils) that change their inductance, according to Faraday's law, if a ferromagnetic material (i.e. the AU) is placed nearby. Sensors can be activated by appropriate positioning of the tongue, instead of pushing buttons or switches, which is expected to reduce fatigue and increase sensor selection speed.

Co-polyester or acrylic plates are used to encapsulate the sensors and are molded to individually fit the user's upper plate and teeth like a dental retainer. A battery-driven 50 kHz sine wave current with an amplitude of 30  $\mu$ A provides power to the coils (Lontis, Andreasen Struijk 2008). The induced voltage ( $\epsilon$ ) is rectified and amplified by hardware and the result is the activation signal, which is sampled with a resolution of 1 byte per sensor. From Faraday's law the induced voltage is described in (1.1), where  $L$  is the inductance,  $\mu_0$  is the vacuum permea-

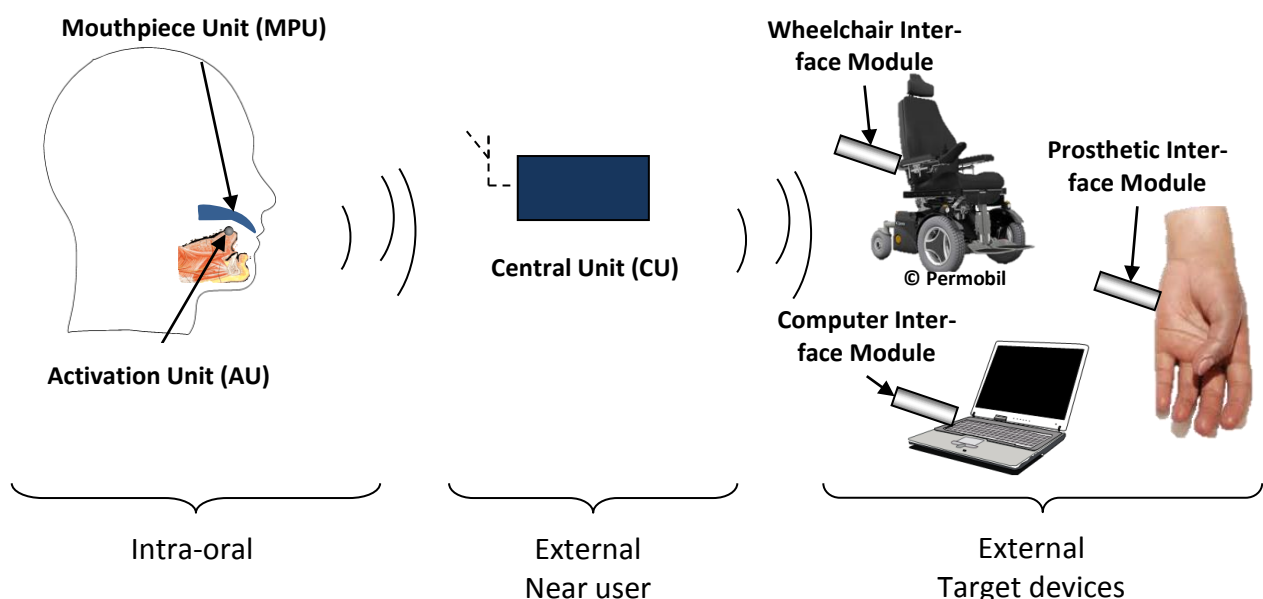

Figure 1-6. Modular interface framework of the Tongue Control System. The framework includes four main parts: an activation unit (AU), a mouth piece unit (MPU), a central unit (CU), and specific interface modules that connect to target devices.

bility,  $\mu_r$  is the relative magnetic permeability of the core material,  $N$  is the number of turns,  $A$  is cross section area, and  $l$  is the length of the coil.

$$\varepsilon = -L \frac{di}{dt} = -\mu_0 \mu_r N^2 \frac{A}{l} \frac{di}{dt} \quad (1.1)$$

### The central unit

The sampled raw signal from the MPU is transmitted wirelessly by a point-to-point radio link to the central unit (CU), placed on the user's wheelchair or in nearby vicinity to the user (direct environment). The CU processes the signals from the MPU and in turn sends functional commands to other devices, either directly through standard communication protocols or through specific interface modules.

Most of the "intelligence" and control logic of the ITCS is located in the CU. This unit monitors signals from the MPU, normalizes sensor signals, and calibrates a baseline when necessary. It also monitors the user's input to decide which external device is currently being controlled and in which modality the signal is treated. The CU may treat signals from each sensor independently or combine signals from several coils to create a direction vector that emulates an analog joystick to control, e.g., mouse pointer or wheelchair. It also serves as the bridge between the MPU and the devices to be controlled, through standard connections, like USB or CAN-bus.

### Specific interface modules

The CU can directly connect with other devices that can receive signals from standard control protocols. However, some devices might need an extra step to convert signals from the central unit to specific protocols. Specific interface modules receive wireless point-to-point radio signals from the CU and convert them to the protocol of the device to be interfaced, for example:

- A computer interface module emulates standard keyboard and mouse signals (Lund et al. 2009).
- A wheelchair interface module performs level conversion and adds safety mechanisms to control signals from the CU (Lund et al. 2010).
- A prosthetic interface module connects the CU with a, e.g., hand prosthesis controller, to select

the desired hand grasp or pinch, while other, e.g., myoelectric, signals control the degree of wrist rotation or finger aperture of the prosthesis (Johansen et al. 2011).

- An environmental control module could connect to a Smart House controller and allow connected devices to be controlled with the tongue.

### 1.3.2 Evolution

During the realization of this project, the ITCS evolved from 9 manually-embedded coils (Figure 1-7a) – through a set of 24 inductive sensor boards (coilpads) embedded in a palatal plate similar to a dental retainer (Figure 1-7b) – to a fully integrated wireless system (Figure 1-7c) (Andreasen Struijk et al. 2009). In the first two prototypes an insulated copper cable running from the external electronics to the sensors or coilpads carries a battery-driven current to the palatal plate with the intra-oral sensors (Lontis, Andreasen Struijk 2008). In the last prototype, the battery, radio and detection system electronics were located inside the palatal plate. The radio wirelessly transmits signals to the Central Unit from inside the mouth.

## 1.4 PROJECT DESCRIPTION

### 1.4.1 Aims of the Ph.D. Project

For the ITCS to be able to improve the quality of life of individuals with tetraplegia it has to be easy to

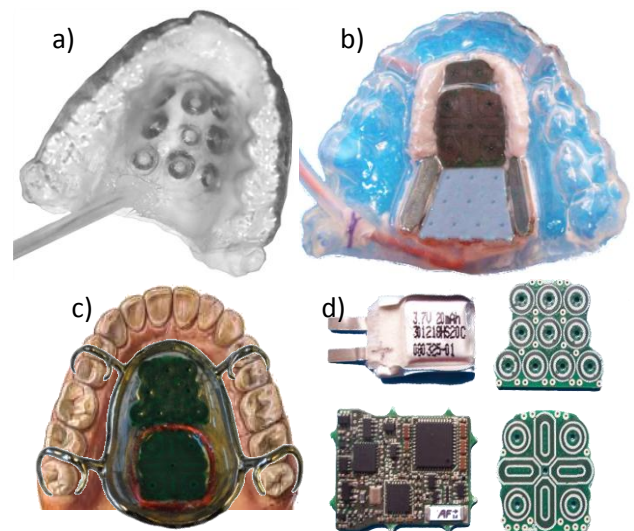

Figure 1-7. Inferior view of: a) Wired palatal plate with 9 independent inductive coils; b) Wired palatal plate with flat PCB coilpads; c) Fully integrated wireless palatal plate; d) Intra-oral electronics and coilpads of the integrated system.

## 1.4 Project Description

---

use and does not easily induce fatigue. The system must provide quick and efficient control commands and be able to control several devices apart from a personal computer. The system must also be potentially useful for a broader group of users (with several types of disabilities and preferably also for able bodied people).

There are two steps towards achieving a functional interfacing system:

- 1) Establish a sensor method/system to the tongue, which can fulfill the above-mentioned requirements. The inductive sensor method (ITCS Coilpad) was developed at Aalborg University (Andreasen Struijk 2006b).
- 2) Design of an accurate and efficient interface between the user and the computer to ensure a sufficient degree of control and correct interpretation of the user's wishes.

The objectives of this Ph.D. project fall within the second step. In order to design efficient tongue-computer interfacing methods for people with movement disabilities, the following aspects must be studied:

- 1) Potential users' opinions on their current computer-interfaces and what are they looking for in a computer interface (needs and wishes).
- 2) Tip of the tongue selectivity in the palatal area, including accessibility to different areas of the palate and tongue movement time between areas of the palate.
- 3) Functionality as a text-input and pointing device for computer control.
- 4) Feedback methods for more efficient intra-oral sensor selection.
- 5) Long term motor learning for typing and pointing with the ITCS.
- 6) Optimal keyboard/joystick functions arrangement, for an efficient human input device system with sufficient degree of control.
- 7) General Usability of a tongue-computer interface for full computer control.

### 1.4.2 Project Structure

The research described in the first five points was performed in two different university research centers. The first part lasted two years and took place at the Center for Sensory Motor Interaction, Department for Health Science and Technology at Aalborg University, Denmark. The second part lasted one year and was performed at Certec, Department of Design Sciences at Lund Institute of Technology, Lund University, Sweden.

At the end of the project an efficient design of an inductive tongue-computer interface (ITCI) that allows the user to effectuate fast commands and benefit from the current advances within the area of computer systems without the need of any special software was obtained. The AU, MPU, CU and the computer-interface module will be referred in the following chapters as the inductive tongue-computer interface (ITCI). Other specific interface modules will be mentioned in the appendices, but not in the body of the thesis.

The project was divided into five different studies. Each of the studies was submitted or accepted for publication as a separate paper in highly-ranked journals. A summary of each study, including specific aims, methodology and results is presented in **Chapter 2**, and is based on the following papers:

- S1. Héctor A. Caltenco, Björn Breidegard, Bodil Jönsson, Lotte N.S. Andreasen Struijk. *Understanding computer users with tetraplegia: Survey of assistive technology users*. In: International Journal of Human-Computer Interaction. Online: May 2011. DOI: 10.1080/10447318.2011.586305
- S2. Héctor A. Caltenco, Eugen R. Lontis, Shellie A. Boudreau, Bo Bentsen, Johannes J. Struijk, Lotte N. S. Andreasen Struijk. *Tip of the tongue selectivity and motor learning in the palatal area*. In: IEEE Transactions on Biomedical Engineering. Online: Aug 2011. DOI: 10.1109/TBME.2011.2169672
- S3. Héctor A. Caltenco, Eugen R. Lontis, Bo Bentsen, Lotte N. S. Andreasen Struijk. *Computer Input with the tip of the tongue*. Submitted to: International Journal of Human-Computer Interaction. (Submitted July 2011).

# Chapter 1: Introduction

---

- S4. Héctor A. Caltenco, Eugen R. Lontis, Bo Bentsen, Lotte N. S. Andreasen Struijk. *Effects of sensory feedback in intra-oral target selection tasks with the tongue*. Submitted to: Disability and Rehabilitation: Assistive technology. (Submitted July 2011).
- S5. Héctor A. Caltenco, Björn Breidegard, Lotte N.S. Andreasen Struijk. *On the tip of the tongue: Learning typing and pointing with an intra-oral interface*. Submitted to: Human Factors. (Submitted July 2011).

**Chapter 3** is intended to provide a general summary and a deep discussion about the work done in this Ph.D. project. Ideas that were not implemented due to time restrictions are presented for the continuation of this research. The general idea is described and some solutions are discussed for future implementation. The general conclusions that were obtained along this project are presented to close the report.

Moreover the report contains two appendices in which technical information of design aspects that complements this work but has not yet been published is presented. It is recommended to read the appendix sections to understand technical aspects of inductive sensor signals and signal:

- **Appendix A** describes the inductive sensor signals depending on geometry of coils used in the ITCI. It also describes the basic signal processing and the coil activation principle.
- **Appendix B** describes the design of an automatic baseline and activation threshold adjustment system for more robust and effective sensor activation on the ITCI.

Design parts and pilot tests of studies 2, 3 and 5 were published as conference papers and are listed here:

- 1) (Andreasen Struijk et al. 2009) describes the development of the novel and wireless fully integrated ITCI. A pilot experiment was performed to demonstrate the system's functionality.
- 2) (Caltenco Arciniega et al. 2009) presents advances in optimal character arrangement of the ITCI for Study 2. The character activation-time

prediction model based on an adaptation of Fitts's Law serve as a basis for optimally arranging characters in the ambiguous ITCI, and therefore maximize typing rates.

- 3) (Lontis et al. 2009) presents complementary information for Study 3. It describes the development of the ITCI as an inductive-pointing device.
- 4) (Lund et al. 2009) presents complementary information for Study 3. It describes the functionality of the ITCI as a standard mouse and keyboard without the need of any extra software or drivers on the host computer. The ITCI can be recognized as both a keyboard and mouse and a user can operate any computer just by plugging in the computer interface module in a free USB port.
- 5) (Caltenco Arciniega, Andreasen Struijk & Breidegard 2010) presents advances towards efficient tongue-computer interface software used in Study 5. It describes the software developed for the ITCI, which provide extended control of any *Microsoft Windows*<sup>®</sup> application and covers most of the standard keyboard and mouse commands. It also uses linguistic character disambiguation to accelerate typing rates.
- 6) (Lontis et al. 2010) presents the evaluation of general usability of the ITCI by individuals with tetraplegia. It compares the performance of typing using text-input functionality and pointing-device functionality of the ITCI, using alphabetic and linguistic disambiguation.
- 7) (Lund et al. 2010) presents the evaluation of the ITCI for wheelchair control. A preliminary test shows the navigation abilities of the device, which are highly competitive when compared to other tongue control systems.
- 8) (Caltenco, Lontis & Andreasen Struijk 2011) presents the design of a mouse-pointer control method that allows continuous and proportional pointer control with respect to the tongue position over the palatal plate.



## 0 References

### REFERENCES

- Allen, B. 1996, "An integrated approach to Smart House technology for people with disabilities", *Medical Engineering and Physics*, vol. 18, no. 3, pp. 203-206.
- Andreasen Struijk, L.N.S. 2006a, "An inductive tongue computer interface for control of computers and assistive devices", *IEEE Transactions on Biomedical Engineering*, vol. 53, no. 12, pp. 2594-2597.
- Andreasen Struijk, L.N.S. 2006b, *Tongue Based Control Method and System for Performing the Method*, DK: WO 2006/105797.
- Andreasen Struijk, L.N.S., Lontis, E.R., Bentsen, B., Christensen, H.V., Caltenco Arciniega, H.A. & Lund, M.E. 2009, "Fully integrated wireless inductive tongue computer interface for disabled people", *Proceedings of the 31st Annual International Conference of the IEEE Engineering in Medicine and Biology Society*, 2-6 September 2009, pp. 547.
- Bolton, M.P. & Wytch, R. 1992, "Mouse emulator for tetraplegics", *Medical and Biological Engineering and Computing*, vol. 30, no. 6, pp. 665-668.
- Breidegard, B. 2006, "Att göra för att förstå - konstruktion för rehabilitering", *Doktorsavhandling Certec, LTH*, vol. 2, pp. 1-122.
- Cabrera, A.F. & Dremstrup, K. 2008, "Auditory and spatial navigation imagery in Brain-Computer Interface using optimized wavelets", *Journal of neuroscience methods*, vol. 174, no. 1, pp. 135-146.
- Caltenco Arciniega, H.A., Andreasen Struijk, L.N.S. & Breidegard, B. 2010, "TongueWise: tongue-computer interface software for people with tetraplegia", *Proceedings of the 32nd Annual International Conference of the IEEE Engineering in Medicine and Biology Society*, pp. 4534.
- Caltenco Arciniega, H.A., Lontis, E.R., Struijk, J.J., Lund, M.E. & Andreasen Struijk, L.N.S. 2009, "Character Activation Time Prediction Model for Tongue-Typing: Adaptation of Fitts's Law", *Proceedings of the Annual International Conference of the IEEE Engineering in Medicine and Biology Society*, pp. 551.
- Caltenco, H.A., Lontis, E.R. & Andreasen Struijk, L.N.S. 2011, "Fuzzy inference system for analog joystick emulation with an inductive tongue-computer interface", *15 Nordic Baltic Conference on Biomedical Engineering and Medical Physics*. IFMBE, Aalborg, Denmark, pp. 191.
- Clayton, C., Platts, R.G.S., Steinberg, M. & Hennequin, J.R. 1992, "Palatal tongue controller", *J. of Microcomputer Applications*, vol. 15, pp. 9-12.
- Compusult Limited 2011, , *Jouse2* [Homepage of Compusult Limited], [Online]. Available: [www.jouse.com](http://www.jouse.com) [2011, 20/01].
- Dix, A., Finlay, J., Abowd, G.D. & Beale, R. 1997, *Human-computer interaction*, 2nd edn, Prentice Hall, London.
- Doherty, E.P., Cockton, G., Bloor, C., Rizzo, J., Blondina, B. & Davis, B. 2002, "Yes/No or Maybe—further evaluation of an interface for brain-injured individuals", *Interacting with Computers*, vol. 14, no. 4, pp. 341-358.
- Drewes, H. & Schmidt, A. 2009, *The MAGIC touch: Combining MAGIC-pointing with a touch-sensitive mouse*.
- Fitzgerald, M.M., Sposato, B., Politano, P., Hetling, J. & O'Neill, W. 2009, "Comparison of three head-controlled mouse emulators in three light conditions", *AAC: Augmentative and Alternative Communication*, vol. 25, no. 1, pp. 32-41.
- Fortune, D., Ortiz, J.E. & Tran, J.N. 1993, *Tongue Activated Communications Controller*.
- Hansen, J.P., Tørning, K., Johansen, A.S., Itoh, K. & Aoki, H. 2004, "Gaze typing compared with input by head and hand", *Proceedings ETRA 2004 - Eye Tracking Research and Applications Symposium*, ed. Spencer S.N., , 22 March 2004 through 24 March 2004, pp. 131.
- Huo, X., Wang, J. & Ghovanloo, M. 2007, "A magnetic wireless tongue-computer interface", *3rd International IEEE EMBS Conference on Neural*

## Chapter 1: Introduction

---

- Engineering*, 2 May 2007 through 5 May 2007, pp. 322.
- Johansen, D., Popović, D.B., Andreasen Struijk, L.N.S., Sebelius, F. & Jensen, S. 2011, "A Novel Hand Prosthesis Control Scheme Implementing a Tongue Control System", *EI Compendex*, , April 2011.
- Kim, D., Tyler, M.E. & Beebe, D.J. 2005, "Development of a tongue-operated switch array as an alternative input device", *International Journal of Human-Computer Interaction*, vol. 18, no. 1, pp. 19-38.
- Lau, C. & O'Leary, S. 1993, "Comparison of computer interface devices for persons with severe physical disabilities", *The American journal of occupational therapy*, vol. 47, no. 11, pp. 1022-1030.
- Lifetool 2010, , *IntegraMouse* [Homepage of Lifetool], [Online]. Available: [www.lifetool.at](http://www.lifetool.at) [2011, 01/20].
- Lontis, E.R. & Andreasen Struijk, L.N.S. 2008, "Design of inductive sensors for tongue control system for computers and assistive devices", *International Convention on Rehabilitation Engineering & Assistive Technology*, 13-15 May, pp. 83.
- Lontis, E.R., Caltenco Arciniega, H.A., Bentsen, B., Christensen, H.V., Lund, M.E. & Andreasen Struijk, L.N.S. 2009, "Inductive pointing device for tongue control system for computers and assistive devices", *Proceedings of the 31st Annual International Conference of the IEEE Engineering in Medicine and Biology Society*, pp. 2380.
- Lontis, E.R., Lund, M.E., Christensen, H.V., Bentsen, B., Gaihede, M., Caltenco Arciniega, H.A. & Andreasen Struijk, L.N.S. 2010, "Clinical evaluation of wireless inductive tongue computer interface for control of computers and assistive devices", *Proceedings of the 32nd Annual International Conference of the IEEE Engineering in Medicine and Biology Society*, pp. 3365.
- Lund, M.E., Caltenco Arciniega, H.A., Lontis, E.R., Christensen, H.V., Bentsen, B. & Andreasen Struijk, L.N.S. 2009, "A framework for mouse and keyboard emulation in a tongue control system", *Proceedings of the 31st Annual International Conference of the IEEE Engineering in Medicine and Biology Society*, pp. 815.
- Lund, M.E., Christensen, H.V., Caltenco Arciniega, H.A., Lontis, E.R., Bentsen, B. & Andreasen Struijk, L.N.S. 2010, "Inductive tongue control of powered wheelchairs", *Proceedings of the 32nd Annual International Conference of the IEEE Engineering in Medicine and Biology Society*, Aug. 31 2010-Sept. 4 2010, pp. 3361.
- MacKenzie, I.S. & Soukoreff, R.W. 2002, "Text entry for mobile computing: Models and methods, theory and practice", *Human-Computer Interaction*, vol. 17, no. 2-3, pp. 147-198.
- Moore, R.K. 2004, "Modelling Data Entry Rates for ASR and Alternative Input Methods", *Proc. Eighth Int'l Conf. Spoken Language Processing (INTERSPEECH 2004-ICSLP)*, .
- Mosby, I. 2009, *Mosby's medical dictionary*, 8th edn, Mosby, Edinburgh.
- NSCISC 2008, "Spinal cord injury Facts and figures at a glance.", *The journal of spinal cord medicine*, vol. 31, no. 3, pp. 357-358.
- Nutt, W., Arlanch, C., Nigg, S. & Gtaufert, G. 1998, *Tongue-mouse for quadriplegics*.
- Penfield, W. 1950, *The Cerebral Cortex of Man. A clinical study of localization of function*, New York, pp. xv. 248. Macmillan Co.
- Salem, C. & Zhai, S. 1997, "Isometric tongue pointing device", *Proceedings of the SIGCHI conference on Human factors in computing systems*ACM, New York, NY, pp. 538.
- Saponas, T.S., Kelly, D., Parviz, B.A. & Tan, D.S. 2009, "Optically sensing tongue gestures for computer input", *Proceedings of the 22nd Annual ACM Symposium on User Interface Software and Technology*ACM, New York, NY, pp. 177.
- Smith, N. 2010, "Quadriplegia and Paraplegia", *NYU Langone Medical Center, Department of Pediatrics*, [Online], .

## 0 References

---

Stephanidis, C. 2001, *User interfaces for all concepts, methods, and tools*, Lawrence Erlbaum Associates Inc, Mahwah, NJ.

Steriadis, C.E. & Constantinou, P. 2003, "Designing human-computer interfaces for quadriplegic people", *ACM Transactions on Computer-Human Interaction*, vol. 10, no. 2, pp. 87-118.

Vaidyanathan, R., Chung, B., Gupta, L., Kook, H., Kota, S. & West, J.D. 2007, "Tongue-movement communication and control concept for hands-free human-machine interfaces", *IEEE Transactions on Systems, Man, and Cybernetics Part A:Systems and Humans*, vol. 37, no. 4, pp. 533-546.

# Chapter 2: Specific Aims, Methodology and Results of Studies 1 – 5

## 2.1 STUDY 1 – SURVEY OF ASSISTIVE TECHNOLOGY USERS



Héctor A. Caltenco, Björn Breidegard, Bodil Jönsson, Lotte N.S. Andreasen Struijk. *Understanding computer users with tetraplegia: Survey of assistive technology users*. In: International Journal of Human-Computer Interaction. Online: May 2011. DOI: 10.1080/10447318.2011.586305.

# Study 1 – Survey of Assistive Technology Users

---

## 2.1.1 Aims:

An online survey was conducted to obtain design parameters for computer interfaces, specifically the inductive tongue-computer interface (ITCI) by:

- 1) Obtaining the opinion of computer users with tetraplegia on their current computer interfaces.
- 2) Assess desirable applications for future independent control using assistive devices.

The information collected in this study covers a wide range of computer interfaces and assistive devices, and evaluates several factors of the interfaces, such as screen display, usability, learnability, helpfulness, setup and installation.

## 2.1.2 Overview of Methodology

A letter explaining the purpose of the study and containing a link to the web survey was distributed to the target population via Spinal cord injury and tetraplegia associations, magazines and Internet forums mainly in Denmark and Sweden, but also through other European and American associations. Survey responses were anonymous, though most respondents provided their e-mail address and gave permission to be contacted.

The questionnaire was based on the standardized Questionnaire for User Interaction Satisfaction [QUIS] (Chin, Diehl & Norman 1988). It contained a demographic survey, a measure of overall system satisfaction, and hierarchically organized measures of specific interface factors (screen display, usability, help information, learnability, system setup). The questionnaire could be completed in about 30 minutes depending on the interface the respondent was using and the degree of disability. The respondent could advance or go back to previous sections using the navigation arrows at the top or bottom of each page.

## 2.1.3 Summary of Results

### *Respondents background*

A total of 39 respondents answered the survey, from which a total of 31 completed questionnaires were included; the other 8 did not meet inclusion/completion criteria. The average age of the

respondents was 42 years. Three of the respondents were disabled since birth; the rest had an average disability time of 19 years. The main cause of disability was due to spinal cord injury (complete transaction) at a high cervical level. Thus, more than 90% of respondents had complete or partial immobility of elbows, wrists, and fingers. Less than 20% respondents had partial immobility of the tongue and jaw, and none had complete immobility of tongue or jaw.

All 31 respondents control the computer by themselves. Of which 25 use one or more assistive computer interfaces, and the other 6 cope with standard keyboard and mouse. The majority of the reported assistive interfaces were based on non-hand based input methods. However users that still had some control of their arms and hands reported using hand typing sticks for standard keyboards and hand joysticks with switch buttons.

### *Opinion about current interfaces:*

The main focus of this study was the evaluation of alternative interfaces for controlling personal computers. Self-reported metrics were reported by respondents using 5-point Likert scales based on the Questionnaire for User Interaction Satisfaction [QUIS]. There was no clear overall distinction of which interfaces were evaluated better than others. Hand joysticks and gaze trackers received very good scores in both system satisfaction and stimulation, while mouthsticks had the lowest scores. Most interfaces were considered easy or very easy to use, but not very flexible. Screen display was evaluated good or very good in general for most interfaces, except for hand joysticks, for which the ease of reading characters was considered neutral.

System speed was rated as satisfactory for gaze trackers, mouth joysticks and typing sticks, but unsatisfactory for mouthsticks. Gaze trackers were rated as a very discrete interface, while speech recognition systems and chin joysticks were rated as indiscrete. Correcting mistakes was rated as easy for most interfaces, but difficult for gaze trackers. Which were rated the best for using shortcuts. Learnability of the system in general is considered good or very good for most interfaces, except for speech recogni-

tion systems. Exploring the functions was considered the lowest for mouthsticks and straightforwardness of performing tasks was rated the lowest for gaze trackers. Setting up the system was considered fast and easy for most interfaces, but gaze trackers were considered slow and difficult.

### *Desirable applications to control*

The second objective of the study was to research potential uses of the inductive tongue control system. Desirable applications to be controlled with a tongue-computer interface, in the opinion of the respondents, were mainly for devices that the user already controls with assistive technologies, such as wheelchair, television, doors and windows. In other words, more than 50% of the respondents that already control these devices would prefer to do it with the tongue, instead of their current device. This may lead to the conclusion that respondents are still looking for better control systems than their current ones, and also that the devices that are currently not controlled without assistance have a lower priority for them (Figure 2-1).

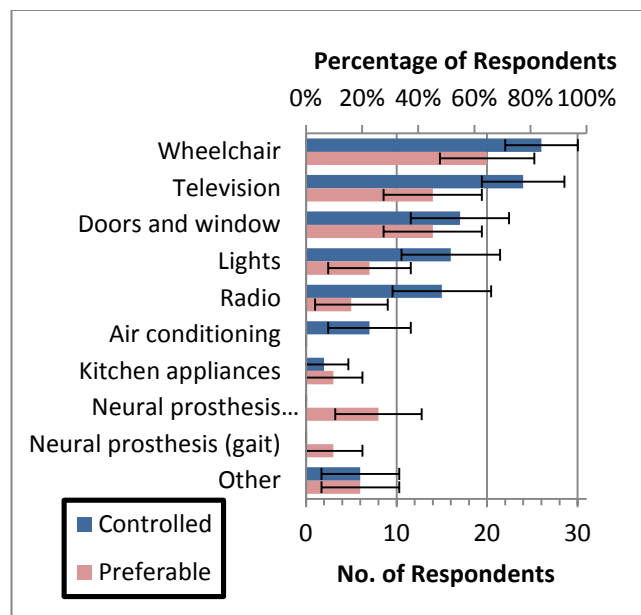

Figure 2-1 Percentage and number of respondents (horizontal axis) who control devices (vertical axis) using assistive technologies, and who would prefer to do so (vertical axis) using a tongue-computer interface. (Caltenco Arciniega et al. 2011)

### 2.1.4 Important Considerations

It is difficult, if not impossible, to design one product to address the needs of the entire population, not even for a limited population such as individuals with tetraplegia. Assistive device designers rely more and more on inclusive design to bring products or services as accessible and usable by as many people as possible (Stephanidis 2001). Moreover, the interface should be able to control alternative electronic devices, in addition to a personal computer, or at least, it should be able to interface with other assistive devices that can control alternative electronic equipment and smart house controllers.

There have been several studies that evaluate user satisfaction of computer interfaces and assistive devices after controlled usability tests using established questionnaires, such as QUIS. However, very few studies up to date address the users' needs and opinions after they have used the interface for longer time, i.e. more than a year. This assessment is important since only then the interface has become an important part of the users' everyday life. This is, up to the authors' knowledge, the first study that compares a wide range of current commercial computer interfaces that have been used as part of the users' daily lives.

The majority of respondents used more than one computer interface in their daily lives, which gives room for improvement in versatility of current computer interfaces. The comparison of these interfaces in terms of overall satisfaction, screen display, usability, helpfulness, learnability and system setup that was performed in this study might help computer interface designers to understand better the users' needs and opinions of several devices already on the market. It might also help computer-interface users to identify a computer-interface fitting more to his/her necessities.

### 2.2 STUDY 2 – TIP OF THE TONGUE SELECTIVITY IN THE PALATAL AREA

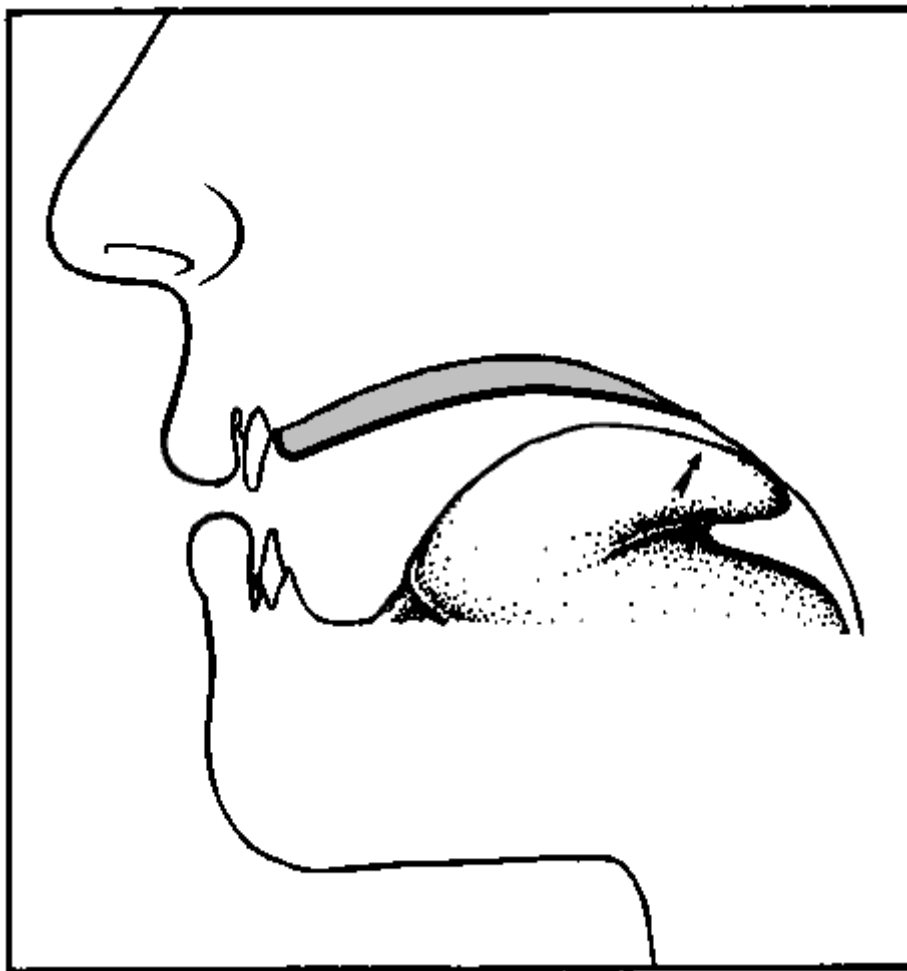

Héctor A. Caltenco, Eugen R. Lontis, Shellie A. Boudreau, Bo Bentsen, Johannes J. Struijk, Lotte N. S. Andreassen Struijk. *Tip of the tongue selectivity and motor learning in the palatal area*. In: IEEE Transactions on Biomedical Engineering. Online: Aug 2011. DOI: 10.1109 / TBME.2011.2169672

## 2.2.1 Aims and Research Questions

The speed and accuracy of intra-oral target selection was assessed to determine the tongue’s accessibility to different areas of the palate and tongue movement time between areas of the palate. This study address the following questions:

- 1) Which areas of the palate are easily accessible by the tongue and which should be avoided?
- 2) How fast can the tongue learn to select targets in the palatal area during three training sessions?
- 3) Will a regression model that includes target location (accessibility) more accurately determine intra-oral target selection time, compared to standard models of human movement in human-computer interaction?

## 2.2.2 Overview of Methodology:

Three different interface layouts ( $L_0$ ,  $L_1$ , and  $L_2$ ) differing by version or arrangement of sensors were tested (Figure 2-2a-c). Twenty able bodied participants (10 males and 10 females), mean age 25.52 years ( $SD = 4.16$ ) participated in one tongue selectivity training regime which consisted of three sessions divided over three consecutive days. Ten participants trained tongue selectivity tasks with  $L_0$ , five with  $L_1$  and five with  $L_2$ .

All participants performed a 30 min/session of intra-oral target selection exercises, using the “key” sensors (all sensors in  $L_0$ , TKP and TFP sensors of  $L_1$

and  $L_2$ ) of the interface. The target sequences were either **repetitive**, **ordered** by rows or columns, **alphabetic**, or **unordered**. Each sequence was displayed for 30 seconds and interspersed with a 5 second rest period. Participants were instructed to “type” as fast and as accurate as possible, and strictly not to “slide” the activation unit over the palatal interface, in order to avoid involuntary activations.

Subjects that used  $L_1$  and  $L_2$ , also performed additional 30 min/session of virtual target pointing and tracking tasks using the mouse sensors (TMP) of the interface. Virtual target pointing and tracking tasks are not analyzed in this study, but in Study 3.

Speed and accuracy in these study were combined into a modification of Fitts’s throughput (2.1), using activation unit lift of  $h = 2$  mm and the distance between targets ( $D$ ) to calculate the arc of movement ( $S$ ), and using effective target width ( $W_e$ ) to compute the index of difficulty ( $ID$ ).

$$TP = \frac{ID}{MT} = \frac{\log_2\left(\frac{S}{W_e} + 1\right)}{MT} \quad (2.1)$$

Where:

$$S \cong 2\sqrt{\left(\frac{D}{2}\right)^2 + h^2} \quad (2.2)$$

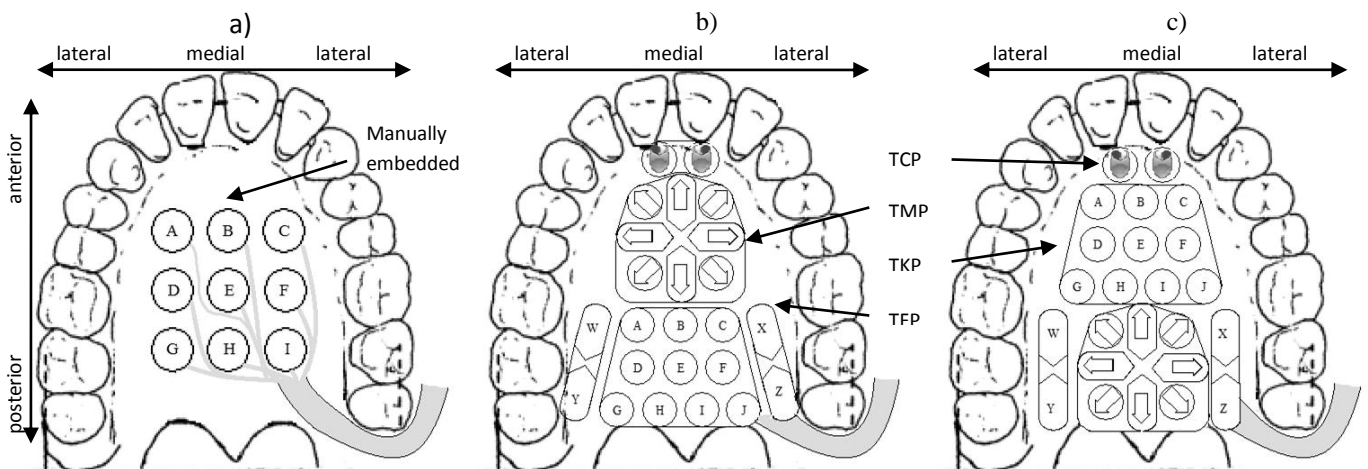

Figure 2-2. Superior view of keyboard/joystick layout options; a)  $L_0$  – Palatal plate with 9 inductive coils. b)  $L_1$  – PCB palatal plate where the Tongue Mousepad (TMP) is located in the anterior part of the hard palate and the Tongue Keypad (TKP) in the posterior part. c)  $L_2$  – PCB palatal plate where the TKP is located in the anterior part of the hard palate and the TMP in the posterior part.  $L_0$  has only 9 key-sensors, while  $L_1$  and  $L_2$  have a TMP with 8 mouse-sensors, a TKP with 10 key-sensors, 2 left/right click sensors, and 4 extra key-sensors (oval). (Caltenco Arciniega et al. 2011)



## Study 2 – Tip of the Tongue Selectivity In the Palatal Area

Four performance measures were obtained. Three of which are based on the Fitts's throughput averaged by transition or end target.

### 2.2.3 Summary of Results

#### Target accessibility

Tongue selectivity performance decreases in the **posterior** direction. **Medial targets** in the anterior part of the palate have better accessibility than **lateral targets** in the same row. However, **medial targets** in the posterior part of the palate have lower accessibility than **most lateral targets** (Figure 2-3). This suggests that there is in fact a dependency of performance to the position of the intra-oral sensors, and that an interaction between medio-lateral and antero-posterior directions exists.

#### Motor learning

Overall performance per training session for all transition groups was 1.29 bits/s for the first, 1.46 bits/s for the second and 1.63 bits/s for the third session. There was a significant 13% improvement of transition performance in each training session.  $L_0$  presented the most learning over all sessions (41%) from 0.97 to 1.37 bits/s, whilst layouts  $L_1$  improved from 1.29 to 1.57 bits/s (22%) and  $L_2$  from 1.39 to 1.73 bits/s (25%). Learning was more noticeable for anterior (49%) and medial (28%) targets than for most-posterior (22%) and most-lateral (10%) targets. After three training sessions,  $L_2$  was the best performing layout with a throughput of 1.73 bits/s.

#### Regression model

The location of sensors had a high impact in intra-oral target selection tasks. Therefore a tip-of-the-tongue movement time prediction model, based on a modification of Fitts's Law that includes target location and movement amplitude was performed.

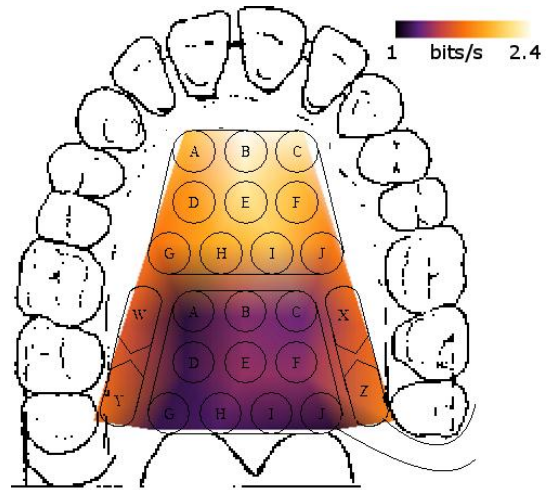

Figure 2-3. Tongue selectivity maps based on throughput of target sensors for Layouts  $L_1$  and  $L_2$  combined. (Caltenco Arciniega et al. 2011)

Where the predictors ( $S$ ,  $A$ ,  $SA$ ) are multiplied by a constant weight. The predictor weights ( $w_S$ ,  $w_A$ ,  $w_{SA}$ ) might differ for different experimental conditions, limb configuration or physical limitations.

$$ID_A = \log_2 \left( w_S \frac{S}{W_e} + w_A \frac{A}{W_e} + w_{SA} \frac{S A}{W_e^2} + 1 \right) \quad (2.3)$$

The inclusion of predictors ( $S$ ,  $A$  and  $S*A$ ) reduced mean squared error (MSE) by 13 to 20% in comparison with only using  $D$ . The results of this study can help in developing intra-oral keyboards that fit characters and other functions into an optimized layout, taking into account number, size and location of targets. The results might also help to optimally arrange functions within the intra-oral keyboard. More specifically, the most accessible areas should be used for commonly used characters and functions.

### 2.3 STUDY 3 – COMPUTER INPUT WITH THE TIP OF THE TONGUE



Héctor A. Caltenco, Eugen R. Lontis, Bo Bentsen, Lotte N. S. Andreasen Struijk. *Computer Input with the tip of the tongue*. Submitted to: International Journal of Human-Computer Interaction. (Submitted July 2011).

### 2.3.1 Aims and Research Questions

The functionality of the ITCI to select intra-oral targets and virtual targets in a computer screen is evaluated for two different ITCI layouts. The study aims to answer the following questions:

- 1) Is intra-oral or virtual target selection different between the anterior and posterior palatal areas?
- 2) How can undesired activations, e.g., by speaking, affect target selection tasks and how can they be reduced?
- 3) How is the ITCI affected by temperature during normal ingestion of hot or cold substances?

### 2.3.2 Overview of Methodology

Two different sensor layouts from the previous study, containing 22 sensors, were tested in this study:  $L_1$  and  $L_2$  (Figure 2-2b-c). Data from the same ten able bodied participants, mean age 28 years (SD = 6.18), of Study 2 was used.

From study 2, the training regime consisted of three consecutive-day sessions of intra-oral target selection tasks. In this study, the virtual target pointing /tracking tasks were included in the analysis. Each task lasted approximately 30 minutes/session. At the end of the last session, reading and temperature test tasks were performed, which lasted between 5 and 10 minutes each.

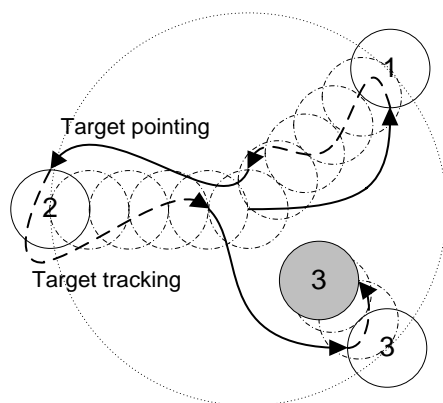

Figure 2-4. Example of 3 consecutive positions of the virtual target (circle) at random during the virtual target pointing and tracking tasks: Shaded circle represents the current circle position, continuous circle represents the initial circle position and dash-dotted circles represent the circle trajectory when the mouse pointer is within the circle. Continuous arrow represents the mouse pointer trajectory during the virtual target pointing task and dashed arrow represents the mouse trajectory during the virtual target tracking task. (Caltenco Arciniega et al. Submitted for publication 2011a)

In this study the target selection tasks were analyzed at the “sequence level” instead of the “transition level” of Study 2. The target selection rate ( $SR$ ) is calculated as the relation between the accuracy rate and the target activation time ( $AT$ ). Target selection rate was measured as compensated activations per minute (capm) since it was compensated by the accuracy.

$$SR = \frac{1 - ER}{AT} \quad (2.4)$$

For the virtual target pointing and tracking tasks, a fuzzy inference system (FIS) was designed to give a proportional relation between the position of the activation unit over the tongue mousepad (TMP) and the “joystick position” output. Signals from the TMP were treated as an input vector to the FIS, which emulates the position of a joystick and move the pointer (Caltenco Arciniega, Lontis & Andreasen Struijk 2011).

For the virtual target pointing and tracking tasks, circles of 50, 70 and 100 pixels in diameter were displayed randomly in each of the 16 positions uniformly distributed along an imaginary “layout circle” of 250 pixels radius (dotted circle in Figure 2-4) with center at the center of the screen.

On the **pointing** part, the participant had to position the mouse pointer as fast and accurately as possible inside the displayed circle (continuous line in Figure 2-4). Once the pointer was inside the circle, the task would become a **tracking** task (dashed arrow in Figure 2-4), where the currently selected target circle (shaded circle in Figure 2-4) would start moving in a straight line towards the center of the screen at a velocity of 100 pixels per second (dashed circles in Figure 2-4). The user was then supposed to keep the pointer inside the circle while it moves towards the center of the screen. If the pointer lost track of the circle, the circle would stop moving until the pointer was inside it again. When the target circle reached the center of the screen, it would disappear and a new circle would be displayed in a new position 250 pixels away, and the task would again become a **pointing** task.

Pointing tasks were evaluated under the ISO 9241-9 standard. Performance measures were obtained for each PCB layout option based on the accuracy and speed of pointing and tracking. For the **pointing** tasks the performance metric used was the pointing throughput (2.5), quantified in bits/s.

$$TP_P = \frac{ID}{MT} = \frac{\log_2\left(\frac{D}{W} + 1\right)}{MT} \quad (2.5)$$

**Tracking** tasks of moving virtual targets were also performed to assess pointer control precision. The performance of **tracking** tasks was assessed by relative time on target, defined as the relation between the time when the pointer was inside the virtual target ( $t_{in}$ ) and the total time required by the virtual target to move to its ending position ( $t_{in}+t_{out}$ ).

$$TT_T = \frac{t_{in}}{t_{in} + t_{out}} \quad (2.6)$$

### 2.3.3 Summary of Results

#### *Performance difference between layouts*

Intra-oral target selection tasks had significantly higher performance (*SR*) when the tongue keypad (TKP) was located in the anterior part of the palate. The rate for L<sub>2</sub> was 37 31 capm, which was 50% higher than the rate of 25 capm observed for L<sub>1</sub> ( $F_{1,8} = 5.319$ ,  $p < 0.05$ ). **Repetitive** sequences present (as expected) the highest target selection rate. *SR* for L<sub>2</sub> was 80 capm, which was 63% higher for than 49 capm for L<sub>1</sub>. *SR* of **ordered** sequences for L<sub>2</sub> was 36 capm, and for L<sub>1</sub> was 26 capm. Sequences S<sub>27</sub> and S<sub>28</sub> present the lowest *SR* (12 to 18 capm), see Figure 2-5.

On the other hand, there was no significant differences in target selection performance ( $TP_P = 0.60$  bits/s,  $F_{1,7} = 0.118$ , *ns*) or target tracking performance ( $TT_T = 37\%$ ,  $F_{1,7} = 4.480$ , *ns*) regarding the location of the tongue mousepad (TMP). This may suggest that, in order to take advantage of the superior target selection performance in the anterior palatal area, the optimal layout for the ITCI is L<sub>2</sub>.

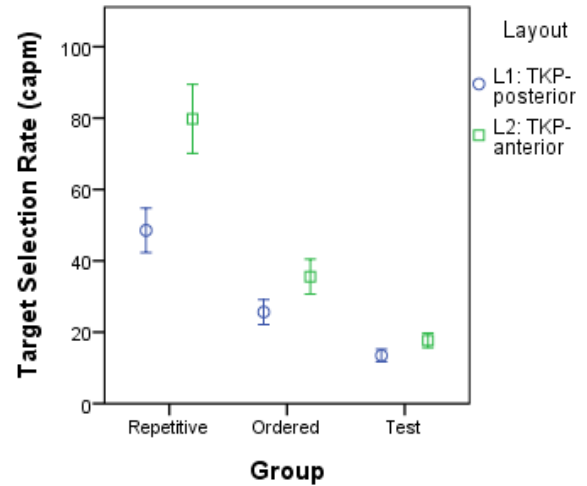

**Figure 2-5.** Target selection rate (*SR*) grouped by repetitive, ordered and test sequence for each layout. Error bars represent 95% confidence interval. (Caltenco Arciniega et al. Submitted for publication 2011a)

However there was a significant difference between pointing throughput of different target sizes ( $F_{2,14} = 30.863$ ,  $p < 0.001$ ). Smaller target sizes had pointing throughput of 0.72 bits/s, which was 22% higher than 0.59 bits/s for larger target sizes. Similarly, there was a significant difference between tracking performance of different virtual target sizes ( $F_{2,14} = 5.529$ ,  $p < 0.001$ ). On the last training session, in contrast to pointing tasks, larger target sizes had longer relative time on target (45%) than small target sizes (26%). The difference might be because  $TP_P$  for smaller targets had higher *ID*, but similar *MT*. On the other hand, **tracking** tasks require more precise pointer control with decreasing target sizes, due that the error tolerance is lower.

#### *Reducing involuntary activations*

One of the main problems was that target selection tasks presented large error rates. Moreover, speaking with the intra-oral interface caused an average of 10 to 31 involuntary activations per minute in the anterior part of the palate. Providing feedback (e.g., tactile or visual) to the user to locate the position of the activation unit, relative to the sensor arrays could be a way to reduce involuntary activations and increase intra-oral target selection performance. Also using dwell time or thresholding techniques for sensor activation might help to reduce involuntary activations while speaking.

## Study 4 – Effects of Sensory Feedback on Intra-Oral Target Selection

### 2.4 STUDY 4 – EFFECTS OF SENSORY FEEDBACK ON INTRA-ORAL TARGET SELECTION

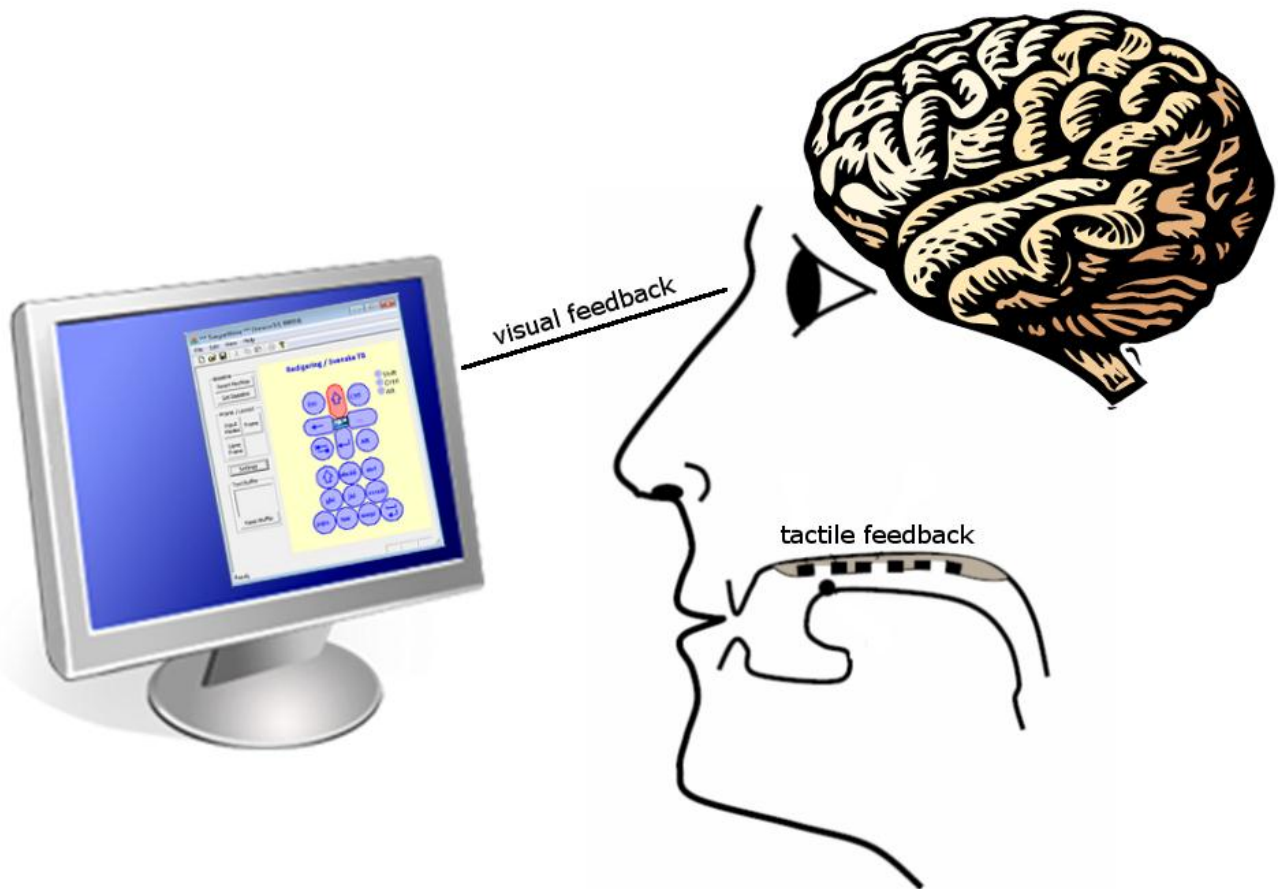

Héctor A. Caltenco, Eugen R. Lontis, Bo Bentsen, Lotte N. S. Andreasen Struijk. *Effects of sensory feedback in intra-oral target selection tasks with the tongue*. Submitted to: Disability and Rehabilitation: Assistive technology. (Submitted July 2011).

### 2.4.1 Background

From Study 3, it was observed that Layout L<sub>2</sub> is the most efficient for typing and pointing. And that a tongue-computer interface is a viable alternative for computer input. However, it was necessary to improve the accuracy of intra-oral target selection and reduce erroneous activations. This can be performed by providing feedback of the current position of the tongue prior to sensor selection acknowledgement.

### 2.4.2 Aims and Research Questions

In this study, the effects of visual and tactile intra-oral sensor-position feedback for typing with the ITCI were investigated using the recommended layout found on Study 3. The possibility of typing using an on-screen keyboard by controlling the mouse pointer with the ITCI's was also evaluated. This study aims to answer the following questions:

- 1) Does visual, tactile or mouse-pointer feedback improve intra-oral target selection accuracy without affecting target selection speed?
- 2) Can undesired activations while talking or drinking be reduced with reasonable dwell time (for visual feedback) or by adding a sensor-border matrix (for tactile feedback)?

### 2.4.3 Overview of Methodology

From the previous study, L<sub>2</sub> was the best performing layout for intra-oral and virtual target selection tasks. Ten new able-bodied participants, mean age 27.6 years ( $SD = 2.9$ ), participated in a three consecutive-days training regime. The new participants were divided into two groups: **visual**, **tactile**. Data from the five participants of Study 3 that used L<sub>2</sub> was used as the **control** group.

The **visual** and **control** groups performed the same intra-oral target selection and virtual target pointing and tracking tasks described in Study 3, using only the interface layout L<sub>2</sub> (Figure 2-2c). However, participants in the visual group were provided with sensor-position **visual feedback** prior to activation acknowledgement for the intra-oral target selection tasks. Participants had to “hold” the active sensor for a certain dwell time to acknowledge sensor activation.

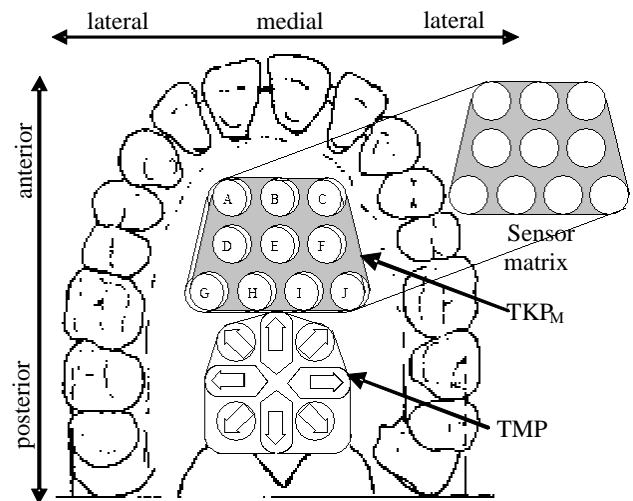

Figure 2-6. Inner view of the upper palate for the associated characters and mouse directions to each sensor for the tongue mousepad (TMP) in the posterior part of the palate, and the tongue keypad (TKP) in the anterior part. (Caltenco Arciniega et al. Submitted for publication 2011b)

The **tactile** group performed intra-oral target selection tasks using an acrylic laminate that acted as a sensor-boarder matrix over the coils (TKP<sub>M</sub>) (Figure 2-6). The laminate provided sensor-position tactile feedback to the user. The activation threshold was adjusted to allow sensors to be activated only if the activation unit was positioned within the matrix borders. Instead of the virtual target pointing and tracking tasks, the **tactile** group performed additional typing tasks using an on-screen keyboard by controlling the mouse pointer with the tongue mousepad (TMP). This gave the participants visual feedback generated by the movement of the mouse pointer on the screen. Therefore data was collected of four types of feedback: **visual feedback** (visual group), tactile feedback (tactile group), **pointer feedback** (tactile group), and **none** (control group).

As in previous studies, the training regime consisted of three consecutive-day sessions of intra-oral target selection exercises (all groups) and pointing/tracking (visual and control groups) or on-screen keyboard typing exercises (tactile group). Each task lasted approximately 30 minutes/session. At the end of the last session, additional speaking and drinking tasks were performed, which lasted 5 minutes each. The same performance measure as in Study 3 was used: target selection rate (SR), see equation (2.4).

## Study 4 – Effects of Sensory Feedback on Intra-Oral Target Selection

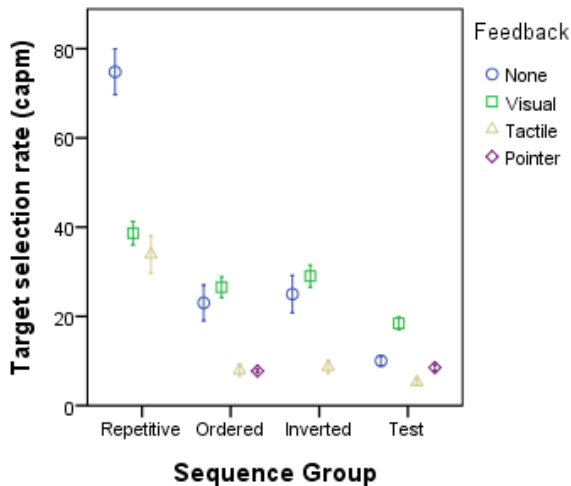

Figure 2-7. Target selection rate (SR) for each sequence group. Error bars represent 95% confidence intervals. (Caltenco Arciniega et al. Submitted for publication 2011b)

### 2.4.4 Summary of Results

#### Sensory feedback effects on performance

For the test sequence, SR for **visual feedback** (18 capm) was 85% higher than for **none feedback**. SR for **tactile feedback** (5 capm) was 50% lower than for **none feedback**. There was no significant difference between SR of **pointer feedback** (9 capm) and **none feedback** ( $F_{3,14} = 6.078, p < 0.01$ ) (Figure 2-7).

Target activation time (AT) decreased with dwell time reduction ( $F_{7,47} = 48.863, p < 0.001$ ), while error rate (ER) increased with dwell time reduction ( $F_{7,47} = 7.571, p < 0.001$ ), however not as much as AT decreased. These effects in speed and accuracy made SR for **visual feedback** to increase exponentially with dwell time decrease ( $F_{7,47} = 22.689, p < 0.001$ ) (Figure 2-8). This indicates that dwell time was necessary at the beginning of training. But trained subjects can use dwell times of 100 ms.

For participants that used **pointer feedback**, mouse pointer maximum speed of 30 pix/s incremented by 10 pix/s as the test sequence's SR improved after each training block. There was a clear increase in SR up to a maximum pointer speed of 60 pix/s, after which performance decreased with increase in speed ( $F_{5,29} = 3.97, p < 0.01$ ) (Figure 2-9). This indicates that mouse pointer control using speeds above 60 pix/sec are too high to be controlled and decrement performance.

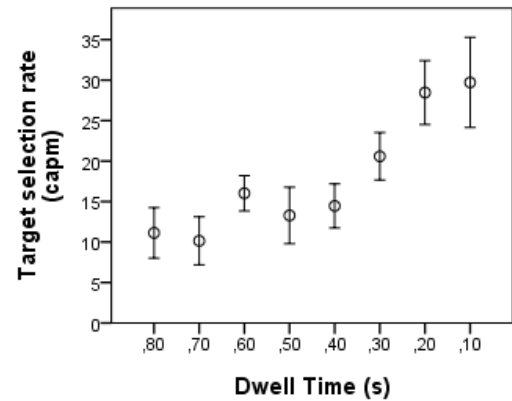

Figure 2-8. Target selection rate (SR) of the test sequence for participants that used visual feedback with decreasing dwell times. Error bars represent 95% confidence intervals. (Caltenco Arciniega et al. Submitted for publication 2011b)

#### Reducing involuntary activations

Involuntary activations due to speaking are reduced using dwell times of 200 ms. or longer and of 600 ms. or longer for drinking. The sensor-matrix also helped to significantly reduce involuntary activations while speaking or drinking; however it also reduced target selection performance. Thresholding to 40% or more also reduced involuntary activations while speaking and drinking. But thresholds above 60% may also reduce voluntary activations.

**Visual feedback** had the best performance. If it is to be used as the target selection technique, then thresholding to 40-60% with dwell times higher than 400 ms will help to reduce the rate of involuntary activations practically to zero, without the need of a sensor-matrix. It is important to choose the highest threshold value that does not introduce areas without active sensors in the TKP.

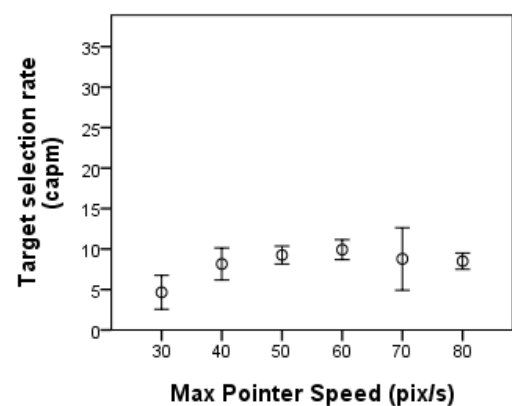
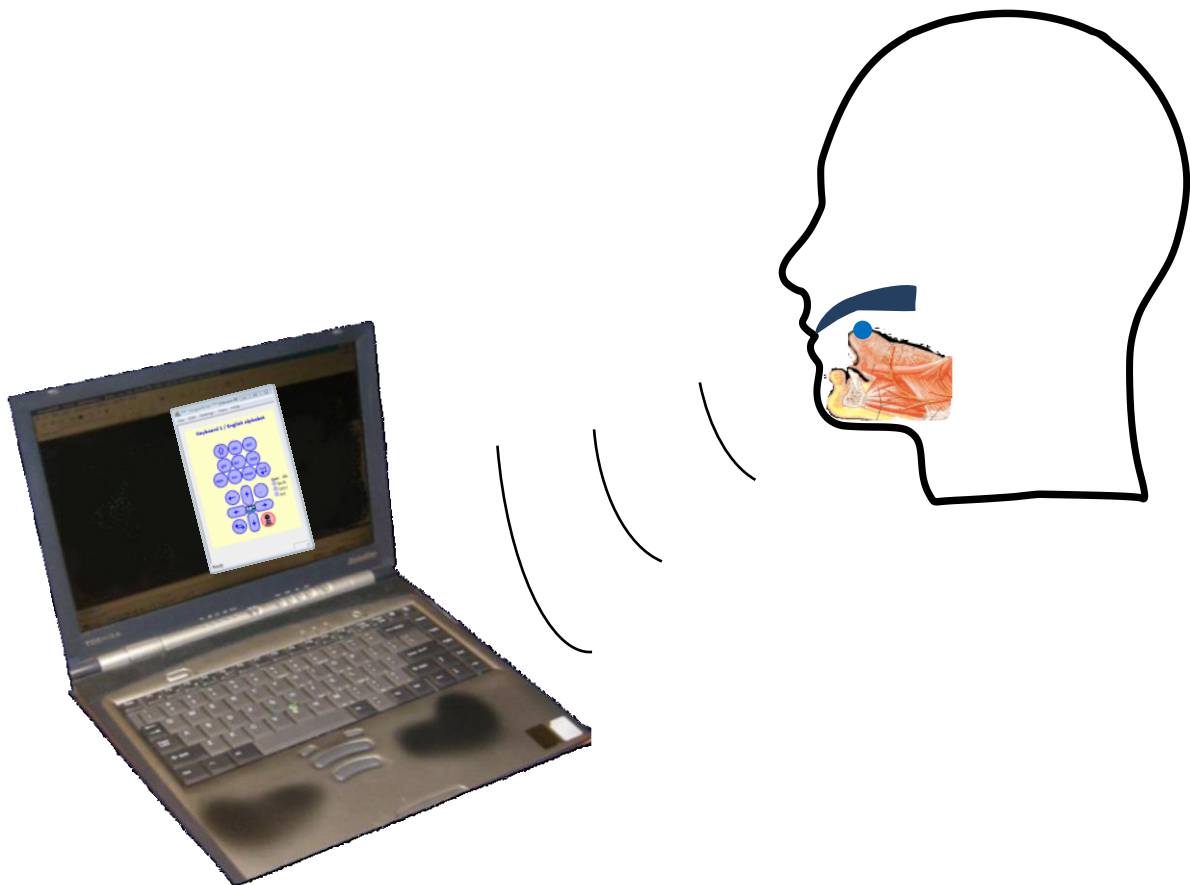

Figure 2-9. Target selection rate (SR) of the test sequence for participants that used pointer feedback with increasing pointer speed. Error bars represent 95% confidence intervals. (Caltenco Arciniega et al. Submitted for publication 2011b)

### 2.5 STUDY 5 – TYPING AND POINTING WITH AN INTRA-ORAL COMPUTER INTERFACE



Héctor A. Caltenco, Björn Breidegard, Lotte N.S. Andreasen Struijk. *On the tip of the tongue: Learning typing and pointing with an intra-oral interface*. Submitted to: Human Factors. (Submitted July 2011).



# Study 5 – Typing and Pointing with an Intra-Oral Computer Interface

## 2.5.1 Background

Previous studies have assessed motor learning during three consecutive day sessions and draw conclusions based on that short-term training period. Moreover, character typing tasks have been performed assigning only one character to each sensor and pointing tasks using only one mouse-pointer control method. These tasks are good for preliminary evaluation of a new interface, but not enough to correctly evaluate typing and pointing capabilities of the interface. From Study 4, visual feedback was the best intra-oral sensor position feedback to the user. Decreasing dwell times over the training sessions was found a useful training method. However, in previous studies the training sessions were evaluated as boring and tedious.

## 2.5.2 Aims

This study evaluates typing and pointing performance of the ITCI over an 18-session training regime spread over a period of two months is described in this chapter. The training was based on games that keep up the motivation of the participants and typing and pointing exercises that evaluate performance using full English and Swedish alphabets and different mouse-pointer control methods. The objectives of this study are:

- 1) To re-evaluate layout-based performance over a longer training period and by typing complete sentences.
- 2) To validate the chosen typing functionality (visual feedback) with decreasing dwell times and typing full sentences using predictive character disambiguation.
- 3) To evaluate different mouse-pointer control modes (discrete and continuous response with 4 to 8 directions)
- 4) To quantify motor learning based on learning curves of each task
- 5) To enhance interaction experience by providing extensive visual and auditory feedback.

## 2.5.3 Overview of Methodology

Four able bodied participants of ages 26, 28, 59 and 64, participated in an 18 session training regime during a period of two months. All participants were

regular computer users. There were approximately two sessions per week, which lasted approximately one hour with between 2 and 3 days of rest between each session. The same interface layouts as in Study 3 were used for this study ( $L_1$  and  $L_2$ ).

Specific software for the ITCI, *TongueWise*, was designed with Microsoft Visual C++ (Caltenco Arciniega, Andreasen Struijk & Breidegard 2010). The *TongueWise* software takes and process signals from the ITCI wireless receiver and generates standard keyboard/mouse event messages in the operative system's message queue.

The participants were asked to play two different games during a session, which were chosen to train the different modalities of the tongue-interface: key selection and mouse-pointer control. Games training lasted 15 to 20 min. In order to keep motivation and engagement, the degree of difficulty of the games incremented according to the performance of the participant. After the training games, participants performed typing and pointing exercises with the same settings (dwell time, mouse speed, etc.) used in the games for that session. Typing and pointing exercises lasted approximately 10 minutes each.

## 2.5.4 Typing performance

For the typing part, participants were asked to type two six standard phrases each session using the *TongueWise* program. Real-time sensor position visual feedback and typing functionality was provided by *TongueWise*, which generated the keyboard events corresponding to the delayed activations. Visual feedback was provided with variable dwell time, starting at 1 second and diminishing by 0.1 seconds as the participant skill increases.

Typing rates were measured similarly to intra-oral target selection rates, see (2.4). However, instead of activations per second, typing rates ( $TP_T$ ) were measured in words per minute (wpm). Subjects were asked to correct the errors immediately after an error has been made. For errors left in text, error rates were computed using a character-level error analysis technique based on the errors left in text (MacKenzie, Soukoreff 2002). This technique uses

the minimum string distance ( $MSD$ ) between the reference ( $SR$ ) and transcribed text string ( $ST$ ). Where, there is often more than one minimum set of transformations or “alignments” for a computed  $MSD$ .  $ER$  is calculated by dividing  $MSD$  by the mean length of the alignment ( $AL$ ).

$$ER = \frac{MSD(S_R, S_T)}{AL} \quad (2.7)$$

### 2.5.5 Pointing Performance

For the pointing part, two different pointing tasks were performed: 1) the pointing and tracking task, as it was performed in Study 3, and 2) a maze completion task, which was used to evaluate pointer control more precisely without having to maintain a constant speed. Pointing and tracking a virtual target was performed in odd sessions, while maze completion exercises in even sessions. There were a total of 3 trials per session regardless of the task, but pointer control settings differed over the sessions.

Pointing and tracking tasks used the same performance measures as in Study 3, see (2.5) and (2.6). Similar performance measures were used for the maze completion task. The percentage of completed path ( $P_{in}$ ) was multiplied by the accuracy of path following, given by the percentage of out-of-bounds path traveled ( $P_{out}$ ). The path following performance (2.8) was then calculated taking into account the index of difficulty of the path ( $ID_F$ ) and the maze completion time ( $t_{follow}$ ).  $ID_F$  (in bits) is calculated from the length ( $D_F$ ) and the path’s width ( $W_F$ ) (2.9).

$$TP_F = \frac{ID_F P_{in} (1 - P_{out})}{t_{follow}} \quad (2.8)$$

$$ID_F = \log_2 \left( \frac{D_F}{W_F} + 1 \right) \quad (2.9)$$

### 2.5.6 Summary of Results

#### Layout-based performance

Participants that used the TKP in the anterior part of the palate obtained higher typing throughput ( $TP_T$ ), while participants that used the TMP in the anterior part of the palate presented higher relative time on target ( $TT_T$ ). This can be expected since Study 2 showed that anterior and medially-located palatal areas are easier to access with the tongue’s tip than posterior and laterally-located ones. This might suggest that, based on  $TP_T$  and  $TT_T$ , the optimal layout would depend on if the ITCI will be used more for typing or pointing functionality.

#### Full-sentence typing with disambiguation

To fit all characters in the 10 keyboard sensors, ambiguous layouts similar to the one of mobile phones was used. Due to our ambiguous layouts, a character disambiguation algorithm such as Multi-tap, *LetterWise*® or *T9*® was necessary. Letterwise was chosen for its simplicity of interaction directly with any windows application. Typing throughput reached an average of 5.70 wpm with a dwell time of 0.5s during 17 training sessions (Figure 2-8).

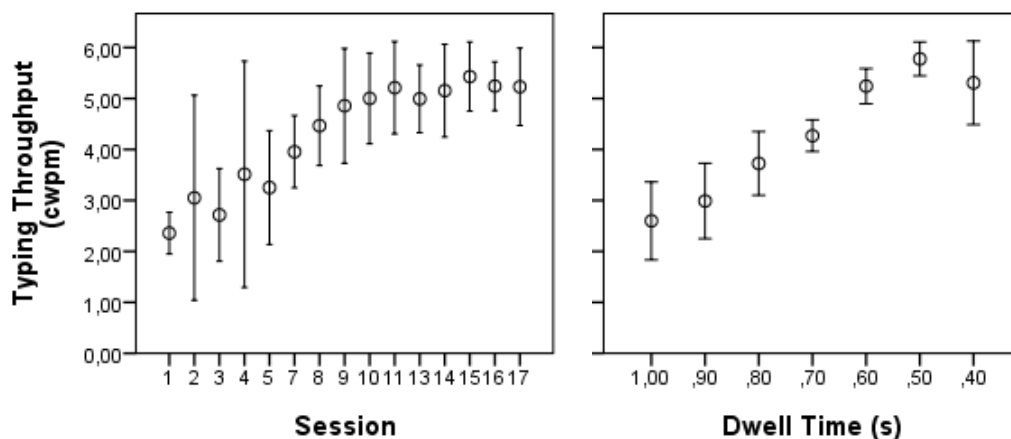

Figure 2-8. Typing throughput ( $TP_T$ ): A) across all typing task training sessions, and B) for the different dwell times. Error bars represent 95% confidence interval. (Caltenco Arciniega, Breidegard & Andreasen Struijk Submitted for publication 2011)

## Mouse pointer control

Virtual target pointing and tracking performance were higher for continuous mouse-pointer control modes ( $F_{1,470} = 74.92$ ,  $p < 0.001$ ). However post-session questionnaires revealed that 3 of 4 subjects preferred discrete 8-directional mouse-pointer control with accelerated speed control due that it was more predictable and intuitive. The effect of target size revealed that there was a clear pointing throughput increment ( $F_{2,470} = 28.312$ ,  $p < 0.001$ ), (Figure 2-10) but a relative time on target decrement ( $F_{2,470} = 33.119$ ,  $p < 0.001$ ) (Figure 2-11) with the decrease of target size. This is expected since target tracking tasks require more precise pointer control with decreasing target sizes. Similarly larger mazes had lower path following performance than smaller ones.

## Motor Learning

If we extend the learning curves for typing throughput until expert performance rates (1000 trials) we obtain typing performances of  $TP_T = 9.15$  wpm using dwell time of 0.5 seconds. Similarly pointing and tracking performances of  $TP_p = 1.32$  bits/s and  $TT_T = 61\%$  are obtained using average target sizes. These performances are much lower than the ones for regular interfaces. However, they are similar to expert performances of alternative assistive devices, such as head and gaze trackers.

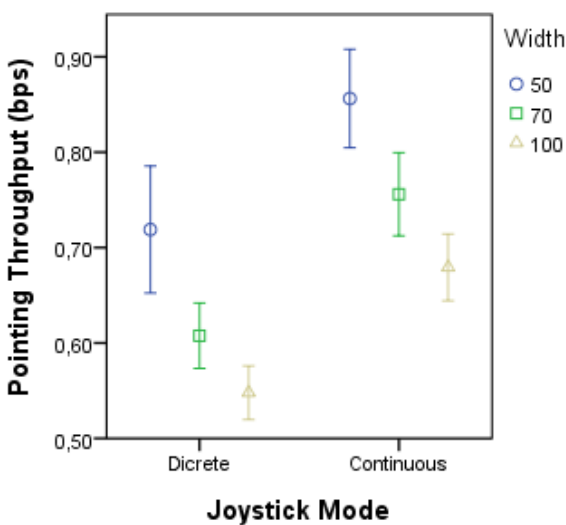

Figure 2-10. Pointing throughput ( $TP_p$ ) for both joystick modalities and for each target width. Error bars represent 95% confidence interval. (Caltenco Arciniega, Breidegard & Andreasen Struijk Submitted for publication 2011)

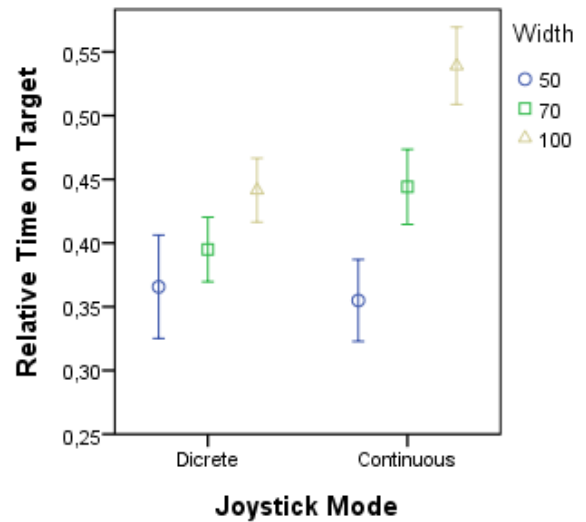

Figure 2-11. Relative time on target ( $TT_T$ ) for both joystick modalities and for each target width. Error bars represent 95% confidence interval. (Caltenco Arciniega, Breidegard & Andreasen Struijk Submitted for publication 2011)

## Enhancing interaction experience

Real-time visual and auditory feedbacks are very relevant for maximizing typing and pointing functionality of intra-oral interfaces. Typing tasks using real-time sensor-position visual feedback with dwell times of 0.5 seconds show promising results as an alternative text input method for individuals with severe physical disabilities. Pointing tasks using either continuous mouse-pointer control or discrete 8-directional mouse pointer control with accelerated speed control also show promising results as an alternative pointing device.

## REFERENCES

- Caltenco Arciniega, H.A., Andreasen Struijk, L.N.S. & Breidegard, B. 2010, "TongueWise: tongue-computer interface software for people with tetraplegia", *Proceedings of the 32nd Annual International Conference of the IEEE Engineering in Medicine and Biology Society*, pp. 4534.
- Caltenco Arciniega, H.A., Breidegard, B. & Andreasen Struijk, L.N.S. Submitted for publication 2011, "On the tip of the tongue: Learning typing and pointing with an intra-oral interface.", *Human factors*, .
- Caltenco Arciniega, H.A., Breidegard, B., Jonsson, B. & Andreasen Struijk, L.N.S. 2011, "Understanding Computer Users with Tetraplegia: Survey of

## Chapter 2: Specific Aims, Methodology and Results of Studies 1 – 5

---

Assistive Technology Users", *International Journal of Human-Computer Interaction*, vol. Online.

- Caltenco Arciniega, H.A., Lontis, E.R. & Andreasen Struijk, L.N.S. 2011, "Fuzzy inference system for analog joystick emulation with an inductive tongue-computer interface", *15 Nordic Baltic Conference on Biomedical Engineering and Medical Physics*. IFMBE, Aalborg, Denmark, pp. 191.
- Caltenco Arciniega, H.A., Lontis, E.R., Bentsen, B. & Andreasen Struijk, L.N.S. Submitted for publication 2011a, "Computer Input with the Tip of the Tongue", *International Journal of Human-Computer Interaction*, .
- Caltenco Arciniega, H.A., Lontis, E.R., Bentsen, B. & Andreasen Struijk, L.N.S. Submitted for publication 2011b, "Effects of Sensory Feedback in Intra-Oral Target Selection Tasks with the Tongue", *Disability and Rehabilitation: Assistive Technology*, .
- Caltenco Arciniega, H.A., Lontis, E.R., Boudreau, S.A., Bentsen, B., Struijk, J.J. & Andreasen Struijk, L.N.S. 2011, "Tip of the Tongue Selectivity and Motor Learning in the Palatal Area", *IEEE Transactions on Biomedical Engineering*, vol. Online.
- Chin, J.P., Diehl, V.A. & Norman, K.L. 1988, "Development of an instrument measuring user satisfaction of the human-computer interface", *Proceedings of the SIGCHI conference on Human factors in computing systems* ACM, New York, NY, USA, pp. 213.
- MacKenzie, I.S. & Soukoreff, R.W. 2002, "A character-level error analysis technique for evaluating text entry methods", *NordCHI'01*, , pp. 243-246.
- Stephanidis, C. 2001, *User interfaces for all concepts, methods, and tools*, Lawrence Erlbaum Associates Inc, Mahwah, NJ.



# Chapter 3: Discussion and Conclusion

## 3.1 SUMMARY AND DISCUSSION

THE objectives of these Ph.D. Studies were to investigate, explore, and develop methods for designing an accurate and efficient inductive tongue-computer interface (ITCI) for people with upper-limb impairments which would ensure sufficient degree of control and correct interpretation of the user's wishes.

In order to design efficient tongue-computer interfacing methods for people with movement disabilities, the following aspects were studied:

- 1) Potential users' opinions on their current computer-interfaces and what features they need and wish for in a well-designed computer interface. (**Study 1**)
- 2) Tip of the tongue selectivity in the palatal area, including accessibility to different areas of the palate and tongue movement time between areas of the palate. (**Study 2**)
- 3) Functionality as a text-input and pointing device for computer control. (**Study 3**)
- 4) Feedback methods for more efficient intra-oral sensor selection. (**Study 4**)
- 5) Long term motor learning for typing and pointing with the ITCI. (**Study 5**)

From Study 1, the potential users' opinion on their current computer interfaces was obtained. Furthermore their desirable applications for future independent control using assistive devices were assessed. The study provided valuable insight on what should be done and what should be avoided when designing computer interfaces, as well as helped to prioritize alternative applications to interface with the ITCI. The information might also be useful for computer interface or assistive device designers for individuals with tetraplegia.

In Study 2, tip of the tongue selectivity in the palatal area was studied. It was observed that intra-oral target selection speed and accuracy was highly dependent on the location and distance between tar-

gets. Repetitive transitions had higher performance than adjacent transitions, which had higher performance than distant transitions. Moreover, targets located in the anterior part of the palate were more accessible than targets in the posterior part. Selecting 14 different targets was less accurate than selecting only 9 targets; however frontal-targets selection speed was faster at a degree that increased overall performance of target selection.

A tip-of-the-tongue movement time prediction model, based on a modification of Fitts's Law (Fitts 1954) that includes target location and movement amplitude describes intra-oral target selection better than the standard Fitts's Law. Moreover these improvements in speed and accuracy over three training days support the notion that the tongue can rapidly learn novel motor tasks (Boudreau et al. 2007), and lends support to the continuation of efforts aimed to further increase the efficiency of intra-oral interfaces and assistive devices.

In Study 3, the functionality of the ITCI to select intra-oral targets and virtual targets in a computer screen is evaluated. A fuzzy inference system was designed to allow mouse-pointer control proportional to the tongue position over the palatal plate (Caltenco Arciniega, Lontis & Andreasen Struijk 2011). It was observed that intra-oral target selection functionality of the ITCI was significantly better for the anterior part of the palate, compared to the posterior part. However pointing-device functionality was not significantly different between anterior and posterior part of the palate. For future studies and future development of the ITCI, a sensor layout containing the keyboard in the anterior area of the palate and mouse functionality in the posterior area of the palate was chosen. Sensors in the most postero-lateral areas of the palate were eliminated.

It was observed that intra-oral target selection accuracy was relatively low; therefore it is necessary to provide feedback (e.g., tactile, visual and/or audi-

## 3.1 Summary and Discussion

---

tory) to locate the position of the activation unit relative to the sensor arrays prior to acknowledging a selection. This might reduce involuntary activations and increase typing performance. It was also observed that undesired activations due to talking are mainly produced in the anterior part of the ITCI. It is necessary to reduce involuntary activations, e.g., using thresholding and dwell time adjustment techniques. These aspects were investigated in Study 4.

Temperature variations can affect the activation signals of the ITCI. This could be a problem if the baseline or the minimum or maximum signal values saturate, as the saturation of the signal reduces the activation range. These factors were considered for designing an automatic baseline and activation threshold adjustment (**Appendix B**).

In Study 4, based on results from Study 3, it was necessary to improve the accuracy of intra-oral target selection and to test different methods of involuntary activation reduction while speaking and drinking. Visual, tactile, and mouse-pointer based pre-acknowledgment feedback types that improve the accuracy of intra-oral target selection were investigated. Visual feedback improved performance the most. Tactile feedback did not improve accuracy and slowed down target selection speed. Even though mouse-pointer feedback improved accuracy, it slowed down text-input speed the most. Therefore visual feedback was selected as the default pre-acknowledgment feedback method for further studies and further development of the ITCI.

Involuntary activations due to talking are drastically reduced using dwell times of 200ms or longer and of 600ms or longer for drinking. The sensor-matrix used for tactile feedback also helped to significantly reduce involuntary activations while talking or drinking; unfortunately it also reduced typing performance. Therefore visual feedback with threshold values of 40-60% and with dwell times higher than 400 ms are recommended for further studies and development of the ITCI.

Previous studies have assessed motor learning during three consecutive day sessions and draw con-

clusions based on that short-term training period. Moreover, character typing tasks have been performed assigning only one character to each sensor. An interactive software application (*TongueWise*) designed to easily switch between different modalities (alphabetic or numeric typing, pointing, navigation, edition, shortcut functions, etc.) was developed (Caltenco Arciniega, Andreasen Struijk & Breidegard 2010). The software extends the functionality of the ITCI, provides visual and auditory feedback for sensor selection and command acknowledgement and provides the text prediction capabilities of *LetterWise*<sup>®</sup> (MacKenzie et al. 2001) for a more efficient computer interaction.

In Study 5, a longitudinal experiment was performed that evaluated typing and pointing performance of the ITCI over an 18-session training regime spread over a period of two months. The study used *TongueWise* to provide text-input and mouse-pointer control with visual and auditory feedback to the participants. Results of the study suggest that the optimal layout would depend on whether the ITCI will be used more for typing or pointing functionality. For typing keyboard sensors in the anterior part of the palate are recommended, while for pointing mouse sensors in the anterior part are recommended. However the number of participants was low to make this comparison, a study with more participants might be needed to have enough statistical power to make any statement about sensor layout differences.

In general, the ITCI is a feasible way for people with severe upper-limb impairments to perform typing and pointing tasks in a computer system. Typing tasks using real-time sensor-position visual feedback with dwell times of 0.5s show promising results as an alternative text input method for individuals with severe physical disabilities. Pointing tasks using either continuous mouse-pointer control or discrete 8-directional mouse pointer control with accelerated speed control also show promising results as an alternative pointing device. Learning curves support the notion that the tongue can rapidly learn novel motor tasks, and the viability of using the tongue to

control personal computers. Further general usability tests performed during these experiments are to be reported in future publications (see future work section).

### 3.2 FUTURE WORK

During the realization of this project, the basic functionality for typing and pointing was evaluated and discussed. However, several necessary aspects for the development of an efficient tongue-computer interfacing methods for individuals with tetraplegia are still to be studied. Moreover, tongue-computer interfacing methods could be useful for other able-bodied individuals and not only for tetraplegic users.

#### 3.2.1 Optimal Character Arrangement

Results from Study 2 can help to develop ambiguous intra-oral keyboards that fit all alphabetic characters into a limited number of targets, such as the one in the ITCI. Study 5, used an alphabetic character arrangement similar to a mobile phone, which is cognitively friendly. But results of Study 2 might help to optimally arrange functions within the intra-oral keyboard based on intra-oral target accessibility. More specifically, the most accessible areas should be used for commonly used characters and functions in a specific language, e.g., English.

In Study 2, a tip-of-tongue movement time prediction model was obtained based on distance between sensors and sensor location, including zero amplitude movements (repeatedly selecting the same sensor).

$$MT = a + b \left( w_s \frac{S}{W_e} + w_A \frac{A}{W_e} + w_{SA} \frac{S A}{W_e^2} + 1 \right) \quad (3.1)$$

However the model presented in (3.1) does not realistically describe the character activation time (*CAT*) when entering a full sentence. If more than 1 character is grouped into a sensor, character disambiguation time (*DT*), time to correct errors (*CT*), and reaction and other mental computation times (*RT*) should be included in the model:

$$CAT = MT + DT + CT + RT \quad (3.2)$$

Details of how to obtain the character activation time prediction model are reported in (Caltenco Arciniega et al. 2009). One method for optimizing an arbitrary set of  $N=26$  characters over a collection of  $M=9$  keys to optimize keystroke efficiency was proposed by Leshner et al. (1998). An optimal character-to-sensor arrangement could be performed based on Leshner's method, using statistical disambiguation algorithms, e.g., *Letterwise*<sup>®</sup> (MacKenzie et al. 2001) or *T9*<sup>®</sup> (Silfverberg, MacKenzie & Korhonen 2000), to automatically interpret each sensor activation (keystroke). However, optimization should be performed for *CAT* instead of keystroke efficiency.

#### 3.2.2 General Usability

Basic functionality of the ITCI is capable of performing text-input and pointing device functions on a personal computer without the need of any software or drivers other than the standard USB keyboard/mouse drivers (Lund et al. 2009). This "plug and play" functionality has a big advantage in mobility and universal accessibility over many other computer interfaces, especially text input interfaces for gaze and head trackers, etc. It also has the advantage work in any operating system that supports standard keyboard and mouse drivers. However, this basic functionality brings certain disadvantages for a normal (every-day) use. The embedded software is only capable of providing the most common standard mouse and keyboard commands for typing and pointing efficiently. It does not provide less frequent commands such as function keys, navigation keys, edition keys and other mode changing keys.

Controlling a computer requires more than basic typing and pointing commands, especially it requires immediate visual and auditory feedback to the user. An extended functionality with more advanced functions, customizable parameters and word prediction was provided with software that integrates directly with the computer's operating system, i.e. *Microsoft Windows*<sup>®</sup>. This software was called *TongueWise* (Caltenco Arciniega, Andreasen Struijk & Breidegard 2010) and brought improved user interaction features, like automatic mode change depending on the application in focus, easy parameter customization



## 3.3 Conclusion

---

for non-skilled to skilled users, and most importantly, improved visual and auditory feedback.

Clinical evaluation with two tetraplegic participants was performed using both the ITCI's basic functionality (plug and play) and extended functionality (*TongueWise*). The extended functionality improved typing throughput and both participants preferred the use of *TongueWise* over the basic functionality (Lontis et al. 2010).

In Study 5, four able bodied participants followed an 18-session training regime using the extended functionality of the ITCI for typing and pointing exercises as well as playing games. Moreover, in sessions 6, 12 and 18, usability evaluations were performed, during which the participants tested several aspects of computer use, such as opening programs and interacting with them, saving and opening files, instant message conversation, internet browsing, text editing, etc. A report of the results of these usability evaluations is yet to be published. Additionally, further usability tests with tetraplegic participants should be performed.

### 3.2.3 Iterative Design of a Tongue-Computer Interface

The longitudinal experiment performed in Study 5 also served as an iterative design process for *TongueWise*. The importance of usability over functionality was evident during the usability experiments with able bodied participants. Simplicity in both interface usage and performed tasks was important for good usability. There are psychological factors, like frustration and motivation, which may affect user performance even more than the actual system usability. Training with games helped to keep the motivation up. Ergonomics and comfort are also very important to improve user performance during the experiments.

During the iterative design process, the signal processing algorithms were designed as simple as possible to keep down the system complexity in order to facilitate the designers' understanding of the system, but also to reduce the risks of introducing "hard to find" programming bugs. However, as

signal processing and sensor-activation functionality was constantly changing to improve the design, maintaining the software simple and clean was not easy. It was necessary to reduce dead areas (areas with no activation signal) within the sensor plates by adjusting threshold values. Therefore, a better and more robust data acquisition and signal processing method is still needed. Moreover a report of the iterative design process methodology is yet to be published.

### 3.2.4 Explore Tongue's Input Vocabulary

The tongue's "language", with specific detail on the input vocabulary for palatal interfaces, has been described in Chapter 1. During the realization of the project only few types of gestures were used (tap, hold and slide), but there are many other types of gestures that will benefit the ITCI interaction. Due to the use of an activation unit not all existing gestures are possible for the ITCI, but there are many gestures that should be explored.

Moreover, for these studies we have used an intra-oral interface with inductive sensors embedded in a palatal plate. Other possibilities for using intra-oral interfaces are possible. For example, sensors could be embedded on a mouthguard and be located in the backside of the teeth. These type of interface could have a better "selectivity", but might have other disadvantages, such as less space for the intra-oral electronics and covering the teeth may cause discomfort.

## 3.3 CONCLUSION

Methods for the design of the interface were explored and researched, including a survey of potential users, tongue selectivity in the palatal area, feasibility of tongue-computer interfacing for text-input and mouse-pointer control, feedback methods for pre-acknowledgement of sensor selection and motor learning of intra-oral typing and pointing functions. At the end of the project the design of an inductive tongue-computer interface that allows the user to effectuate fast commands and benefit from the current advances within the area of computer systems without the need of any special software was obtained. Furthermore, a design of software

## Chapter 3: Discussion and Conclusion

that allows more efficient tongue-computer interfacing was performed.

The prototype used for the studies was based on the Inductive Tongue Control System (ITCS) (Andreasen Struijk 2006) developed at Aalborg University and planned to be commercialized by TKS A/S. The ITCS has evolved during the realization of this project to become a fully integrated wireless system (Andreasen Struijk et al. 2009) capable of performing text-input and pointing device functions on a personal computer regardless of the operating system and without the need of any software or drivers other than the standard USB keyboard/mouse drivers (Lund et al. 2009). The system can also control wheelchairs by emulating an analog joystick (Lund et al. 2010) and even control a prosthetic hand (Johansen et al. 2011). Moreover, the system was complemented with an interactive software application that provides extended control of any *Microsoft Windows*® application and covers most of the standard keyboard and mouse commands and shortcuts. It also uses linguistic character disambiguation to accelerate typing rates (Caltenco Arciniega, Andreasen Struijk & Breidegard 2010) and provides immediate visual and auditory feedback to the user.

In general, it is concluded that an inductive tongue-computer interface is a feasible way for people with severe upper-limb impairments to perform typing and pointing tasks in a computer system. Typing tasks using real-time sensor-position visual feedback with dwell times of 0.5 seconds show promising results as an alternative text input method for individuals with severe physical disabilities. Pointing tasks using either continuous mouse-pointer control or discrete 8-directional mouse pointer control with accelerated speed control also show promising results as an alternative pointing device. Motor learning curves support the notion that the tongue can rapidly learn novel motor tasks, and the viability of using the tongue to control personal computers and other electronic equipment.

## REFERENCES

- Andreasen Struijk, L.N.S. 2006, *Tongue Based Control Method and System for Performing the Method*, DK: WO 2006/105797.
- Andreasen Struijk, L.N.S., Lontis, E.R., Bentsen, B., Christensen, H.V., Caltenco Arciniega, H.A. & Lund, M.E. 2009, "Fully integrated wireless inductive tongue computer interface for disabled people", *Proceedings of the 31st Annual International Conference of the IEEE Engineering in Medicine and Biology Society*, 2-6 September 2009, pp. 547.
- Boudreau, S.A., Romaniello, A., Wang, K., Svensson, P., Sessle, B.J. & Arendt-Nielsen, L. 2007, "The effects of intra-oral pain on motor cortex neuroplasticity associated with short-term novel tongue-protrusion training in humans", *Pain*, vol. 132, no. 1-2, pp. 169-178.
- Caltenco Arciniega, H.A., Andreasen Struijk, L.N.S. & Breidegard, B. 2010, "TongueWise: tongue-computer interface software for people with tetraplegia", *Proceedings of the 32nd Annual International Conference of the IEEE Engineering in Medicine and Biology Society*, pp. 4534.
- Caltenco Arciniega, H.A., Lontis, E.R. & Andreasen Struijk, L.N.S. 2011, "Fuzzy inference system for analog joystick emulation with an inductive tongue-computer interface", *15 Nordic Baltic Conference on Biomedical Engineering and Medical Physics*. IFMBE, Aalborg, Denmark, pp. 191.
- Caltenco Arciniega, H.A., Lontis, E.R., Struijk, J.J., Lund, M.E. & Andreasen Struijk, L.N.S. 2009, "Character Activation Time Prediction Model for Tongue-Typing: Adaptation of Fitts's Law", *Proceedings of the Annual International Conference of the IEEE Engineering in Medicine and Biology Society*, pp. 551.
- Fitts, P.M. 1954, "The information capacity of the human motor system in controlling the amplitude of movement.", *Journal of Experimental Psychology: General*, vol. 121, no. 3, pp. 262-269.

## 0 References

---

- Johansen, D., Popović, D.B., Andreasen Struijk, L.N.S., Sebelius, F. & Jensen, S. 2011, "A Novel Hand Prosthesis Control Scheme Implementing a Tongue Control System", *El Compendex*, April 2011.
- Leshner, G.W., Moulton, B.J. & Higginbotham, D.J. 1998, "Optimal character arrangements for ambiguous keyboards", *IEEE Transactions on Rehabilitation Engineering*, vol. 6, no. 4, pp. 415-423.
- Lontis, E.R., Lund, M.E., Christensen, H.V., Bentsen, B., Gaihede, M., Caltenco Arciniega, H.A. & Andreasen Struijk, L.N.S. 2010, "Clinical evaluation of wireless inductive tongue computer interface for control of computers and assistive devices", *Proceedings of the 32nd Annual International Conference of the IEEE Engineering in Medicine and Biology Society*, pp. 3365.
- Lund, M.E., Caltenco Arciniega, H.A., Lontis, E.R., Christensen, H.V., Bentsen, B. & Andreasen Struijk, L.N.S. 2009, "A framework for mouse and keyboard emulation in a tongue control system", *Proceedings of the 31st Annual International Conference of the IEEE Engineering in Medicine and Biology Society*, pp. 815.
- Lund, M.E., Christensen, H.V., Caltenco Arciniega, H.A., Lontis, E.R., Bentsen, B. & Andreasen Struijk, L.N.S. 2010, "Inductive tongue control of powered wheelchairs", *Proceedings of the 32nd Annual International Conference of the IEEE Engineering in Medicine and Biology Society*, Aug. 31 2010-Sept. 4 2010, pp. 3361.
- MacKenzie, I.S., Kober, H., Smith, D., Jones, T. & Skepner, E. 2001, "LetterWise: Prefix-based disambiguation for mobile text input", *Proceedings of the 14th Annual ACM Symposium on User Interface Software and Technology (UIST'01)*, 11 November 2001 through 14 November 2001, pp. 111.
- Silverberg, M., MacKenzie, I.S. & Korhonen, P. 2000, "Predicting text entry speed on mobile phones", *CHI 2000 - Conference on Human Factors in Computing Systems 'The Future is Here'* ACM, New York, NY, United States, 1 April 2000 through 5 April 2000, pp. 9.

# Appendix A: Inductive Sensors and Activation Signals of the ITCI

## A.1 INDUCTIVE SENSORS

THE inductive tongue computer interface (ITCI) contains a palatal plate, resembling a dental retainer, with inductive sensors (coils) that change their inductance, according to Faraday's Law, if a ferromagnetic material is placed nearby. Inductive sensors are grouped in two different printed circuit boards (Figure A-1), one with 8 sensors as a tongue mousepad area (TMP), and another with 10 sensors as a tongue keypad area (TKP).

The ferromagnetic activation unit (Figure A-2), is a 4 mm (diameter) by 2 mm (height) cylinder made of biocompatible stainless steel (type SUS 447J1), which is fixed (e.g. pierced or glued) 7 to 10 mm posterior to the users' tongue tip. Sensors can be activated by appropriate positioning of the activation unit over the palatal plate surface.

A battery-driven 50 kHz sine wave current with an amplitude of 30  $\mu$ A provides power to the coils (Lontis, Struijk 2010). The induced voltage ( $\epsilon$ ) is rectified and amplified by hardware, giving in result an activation signal, which is sampled with a resolution of 1 byte per sensor. From Faradays law the induced voltage is:

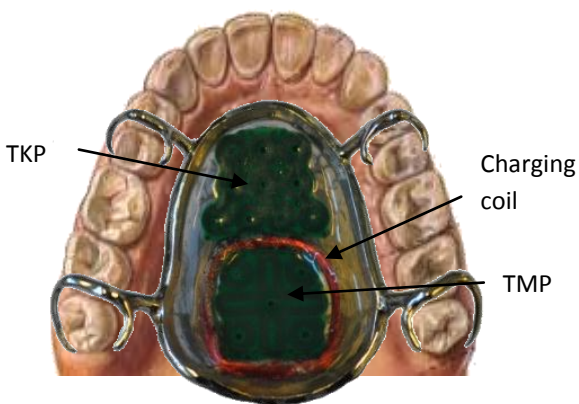

Figure A-1. Palatal interface with inductive sensor boards; The Tongue mousepad (TMP) area contains 8 sensors and the tongue keypad area (TKP) contains 10 round sensors. The TMP is fenced by a charging coil.

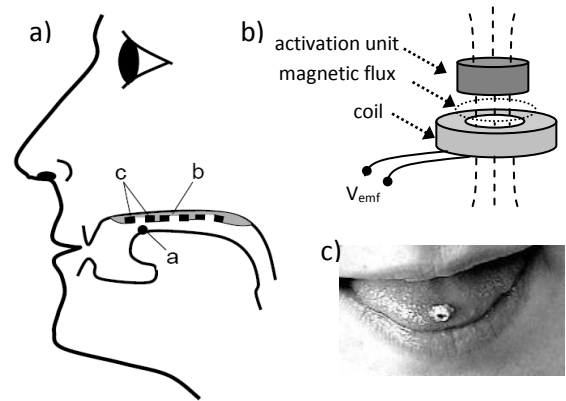

Figure A-2. The activation unit: a) placement of sensors [c] in the palate [b] and activation unit [a], b) principle of activation, c) activation unit. Modified from [Andreasen Struijk, 2006], © 2006 IEEE.

$$\epsilon = -L \frac{di}{dt} = -\mu_0 \mu_r N^2 \frac{A}{l} \frac{di}{dt} \quad (1.1)$$

Where  $L$  is the inductance,  $\mu_0$  is the vacuum permeability,  $\mu_r$  is the relative magnetic permeability of the core material,  $N$  is the number of turns,  $A$  is cross section area, and  $l$  is the length of the coil.

## A.2 SIGNAL PROCESSING

Sampled activation signal is transmitted wirelessly to the computer or other hardware designed to process this signal (i.e. the central unit of the ITCI). Signal processing software monitors signals coming from the ITCI, normalizes sensor signals, and calibrates signal baseline. For the controlled experiments performed for these Ph.D. studies sensor-signal range calibration was performed (outside the mouth) by sliding the activation unit through the center of each sensor before the first use of each participant's device. As the baseline is affected by temperature, baseline calibration is performed during normal use of the ITCI, every time the average baseline deviated more than 10%. However, for the normal more extended use of the ITCI, baseline calibration and sensor range is performed automatically by the central unit (Appendix C).

A sensor is considered active when the difference exceeds a 15% (TMP sensors) and 25-50% (TKP sensors) threshold, relative to the maximum activation signal for that specific sensor. In case two or more TKP sensor signals exceed the threshold, the sensor with the greatest signal amplitude is chosen. However, signals from TMP sensors are treated as an input vector to a fuzzy inference system (Appendix B) to emulate the position of a joystick and move the pointer.

### A.3 SENSOR GEOMETRY AND SIGNALS

There are two types of sensors in the TMP: round and oval. Each type of coil has different activation properties depending on where the center of the activation unit is positioned over the coil. The geometry of the coil determines the strength of maximal activation, i.e. the maximal influence of the activation unit (blue circle in Figure A-3) on the magnetic flux generated by the coil. Placing the center of the activation unit outside the maximal activation point (blue star in Figure A-3) determines a decreased activation. The round coil is the most efficient in concentrating a generated magnetic field and provides the greatest strength of maximal activation. The oval coil generates a more dispersed magnetic field (i.e. less concentrated) with lower maximal activation, but the transit area (red lines in Figure A-3) increases accordingly with the coil dimensions.

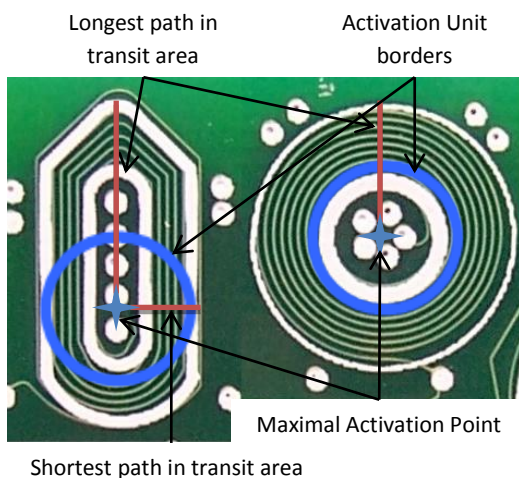

Figure A-3. Examples of coil geometry that provides different maximal activation strength and transit areas relative to the maximal activation point for each coil.

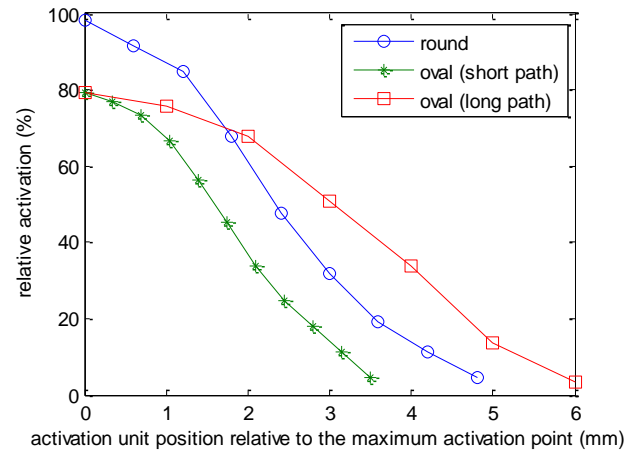

Figure A-4. Activation signal of round coils and oval coils relative to the maximum activation signal of both coils. The signal is dependent on the activation unit position relative to the maximal activation point of each coil.

Figure A-4 shows the activation signal dependent on the activation unit position, using a stainless steel activation unit 4 mm (diameter) x 2 mm (height) placed 0.3 mm above the surface of the coil. The center of the activation unit, relative to the maximal activation point of each coil defines its placement. The activation signal then can be interpreted by the signal processing software that takes signals from individual sensors or the interpolation of sensor signals to perform actions, e.g. mouse movement of character typing.

### REFERENCES

Lontis, E.R. & Struijk, L.N.S.A. 2010, "Design of inductive sensors for tongue control system for computers and assistive devices", *Disability and Rehabilitation: Assistive Technology*, vol. 5, no. 4, pp. 266-271.

# Appendix B: Automatic Calibration for the Inductive Tongue-Computer Interface

## B.1 INTRODUCTION

APPENDIX A explained the inductive sensor signals of the inductive tongue-computer interface (ITCI) and how activations are produced by placing the activation unit near the inductive sensors. The sampled activation signal is transmitted wirelessly to the computer or other hardware designed to process this signal (i.e. the central unit of the ITCI). Sensor signals are affected by temperature and humidity of the intra-oral environment and surrounding tissue. Since not all sensors are equally affected by changes in the environment constant calibration is required, for each sensor independently. One example can be seen in the results of the temperature tests on Chapter 4. Figure B-1.a shows a signal increase over time for each sensor during the cold-test. During the hot-test (Figure B-1b) the baseline decreases, and even reaches a saturation point for some sensors.

Moreover, as explained in Appendix A, sensor signals vary with the geometry of sensors (round or oval), but also due to variability introduced by the manufacturing process and the insulation of the sensor boards. Therefore even sensors of the same shape have different signal activation properties. As the signal processing software in the computer receives normalized activation signals, normalization should be performed for each sensor independently.

For the controlled experiments performed for the purpose of these Ph.D. studies, signal processing software monitored signals coming from the ITCI,

normalized sensor signals, and calibrated signal baseline. Sensor-signal range calibration was performed (outside the mouth) before the first use of each participant's device. Baseline calibration was performed during normal use of the ITCI approximately every 15 minutes or when some false positives were noticed. However, this manual calibration cannot be performed during normal use of the device. An automatic calibration that runs transparently in hardware as part of the signal processing is necessary.

## B.2 AUTOMATIC CALIBRATION

Sensor signals are sampled with a resolution of 1 byte per sensor. Raw sampled signals delivered by the ITCI mouthpiece unit are in the order of 180 to 200 (out of 255). This explains the signal saturation during the hot-test in Figure B-1b, where the signal reaches values over 255. When the activation unit nears a sensor, the induced voltage (voltage drop) produces maximal activation values ranging between 50 and 100, depending on the activated sensor (Figure B-2).

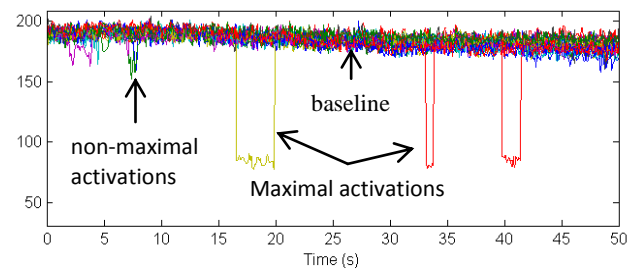

Figure B-2. Raw sampled signals from the ITCI.

An automatic calibration system was designed to process raw signals ( $x_i$ ) and output normalized positive signals ( $y_i$ ) ready to be interpreted by other systems. The calibration process takes the raw data from sensors, removes the baseline, negates the output (to have positive activations) and normalizes sensor signals. Baseline removal is done via a high-pass second-order digital filter, which filters base-

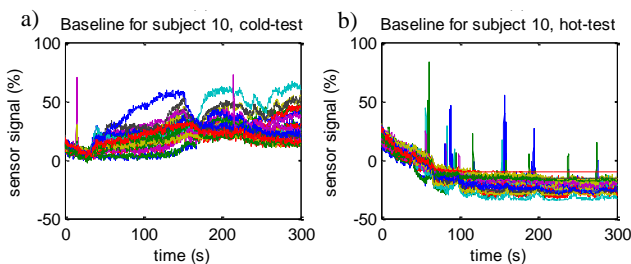
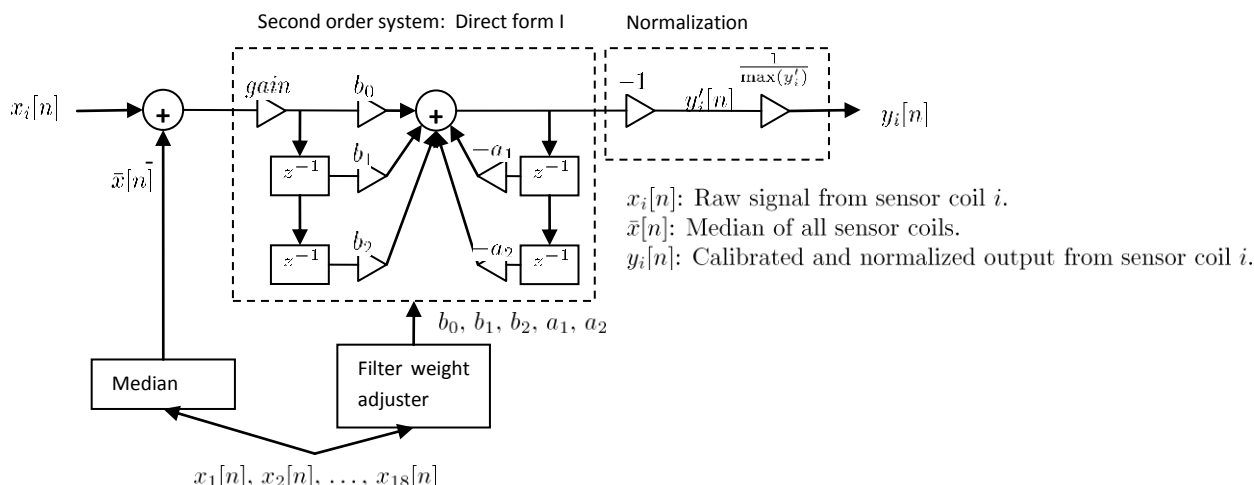

Figure B-1. Baseline changes over time during a) hot and b) cold temperature tests performed on Chapter 4.



**Figure B-3. Automatic calibration system for baseline removal and normalization of sensor signals. Filter weights for each sensor are adjusted depending on whether the sensor or a neighbor sensor is active.**

line, but allows detection of abrupt changes (activation) in the signals.

The problem with the high-pass filter is that it may remove not only baseline, but also prolonged sensor activations. Therefore, if activation is detected, the effect of this filter should be removed for the active sensor. This is done by using different filter weights for active and inactive sensors. As neighboring sensors of an active sensor can potentially also be active, they are treated as active sensors. The result is two different filters, Filter I for active sensors and Filter II for inactive sensors (Figure B-5).

The filtered signal is then inverted ( $y'_i$ ) and nor-

malized using the maximum recorded (inverted) signal from that sensor ( $\max(y'_i)$ ). If the signal is higher than the maximum recorded signal, the new value is stored in memory and used in future comparisons. The result is the calibrated and normalized signal from that sensor ( $y_i$ ).

The high-pass filter has no effect when there are no sensor activations, therefore an offset may still be present while the system is idle. Figure B-5 shows the example of sensor signals after high-pass filtering and normalization. An offset can be observed at the beginning before any activation has been made, and neighboring sensors continue to have offset after activation has been released. This problem has

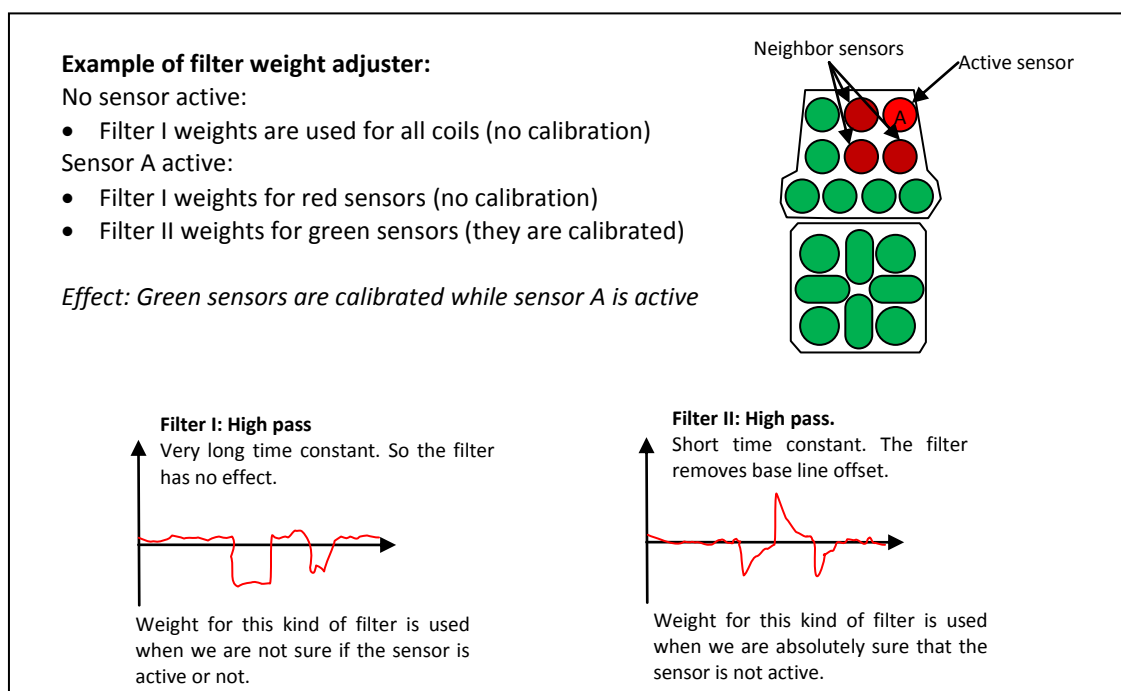

**Figure B-4. Example of filter weight adjuster. Two filters are used depending if a sensor (or neighboring sensor) is active or not.**

# Automatic Calibration for the Inductive Tongue-Computer Interface

been resolved by subtracting the median of all sensor signals from each sensor signal.

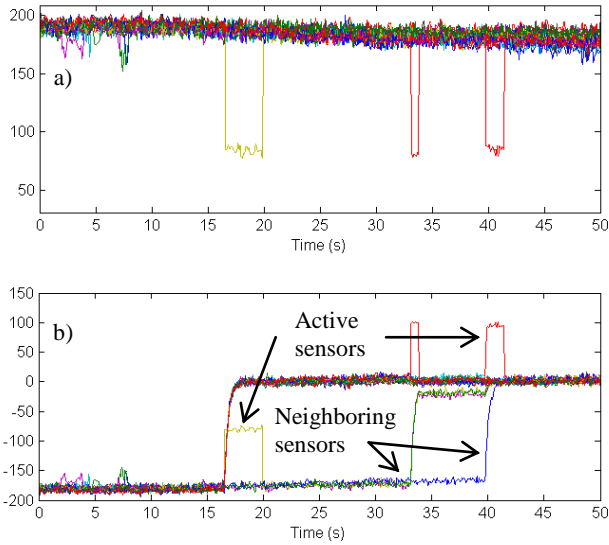

Figure B-5. a) raw sensor signals and b) signals after high-pass filter and normalization

An example of a fully automatic calibration system can be observed in Figure B-6, the data has been altered deliberately at 200 seconds to test the generalization capabilities of the filter. It can be observed that the system can handle both slow and abrupt baseline changes, and effectively normalize sensor signals.

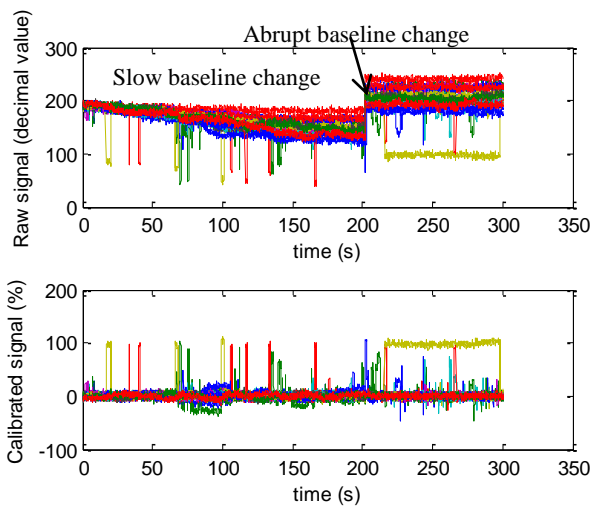

Figure B-6. a) raw sensor signals and b) automatic calibration system signals over time.