



AALBORG UNIVERSITY
DENMARK

Aalborg Universitet

Energy Efficient Evolution of Mobile Broadband Networks

Micallef, Gilbert

Publication date:
2013

Document Version
Accepted author manuscript, peer reviewed version

[Link to publication from Aalborg University](#)

Citation for published version (APA):

Micallef, G. (2013). *Energy Efficient Evolution of Mobile Broadband Networks*. Department of Electronic Systems, Aalborg University.

General rights

Copyright and moral rights for the publications made accessible in the public portal are retained by the authors and/or other copyright owners and it is a condition of accessing publications that users recognise and abide by the legal requirements associated with these rights.

- Users may download and print one copy of any publication from the public portal for the purpose of private study or research.
- You may not further distribute the material or use it for any profit-making activity or commercial gain
- You may freely distribute the URL identifying the publication in the public portal -

Take down policy

If you believe that this document breaches copyright please contact us at vbn@aub.aau.dk providing details, and we will remove access to the work immediately and investigate your claim.

Energy Efficient Evolution of Mobile Broadband Networks

PhD Thesis

by

Gilbert Micallef



A dissertation submitted to
Department of Electronic Systems,
The Faculty of Engineering and Science, Aalborg University, in
partial fulfillment for the degree of
Doctor of Philosophy,
Aalborg, Denmark.
April 2013

Supervisors:

Preben E. Mogensen, PhD,
Professor, Aalborg University, Denmark.

Hans-Otto Scheck,
Senior Specialist, Nokia Siemens Networks, Sweden.

Opponents:

Holger Claussen, PhD,
Head of the Autonomous Networks and Systems Research Department,
Alcatel-Lucent Bell Labs, Ireland.

Tim O'Farrell, PhD,
Professor, Sheffield University, United Kingdom.

Jens Myrup Pedersen, PhD,
Associate Professor, Aalborg University, Denmark.

*Hey. Don't ever let somebody tell you...
You can't do something. Not even me. All
right? You got a dream... You gotta protect
it. People can't do somethin' themselves,
they wanna tell you you can't do it. If you
want somethin', go get it. Period.*

Will Smith in Pursuit of Happiness

Abstract

Over the last decade, the mobile communications industry has broken through some remarkable barriers, pushing further and transforming the way people communicate and access information. As the volume of traffic carried by mobile networks maintains an insatiable growth, mobile network operators are required to ensure that networks can scale accordingly. In addition to upgrading existing networks, a number of operators have already started to rollout a further radio access technology layer, Long Term Evolution, or LTE.

In addition to enhancing network capacity, operators are also required to adhere to public commitments for reducing their energy and carbon footprint. In 2008 Vodafone stated that by the year 2020, efforts for reducing emissions are expected to halve emissions registered in the year 2006/7. In addition to presenting a more environmentally conscious brand, this is also hoped to reduce costs, which, based on increasing energy prices and necessary network upgrades are likely to increase. Since base station sites make up for about 75% of the power consumption in mobile networks, studies are focused on this specific network element. A number of factors believed to play a role in the power consumption of mobile networks are separately investigated and later combined, providing a realistic indication of how the consumption is expected to evolve. This is also used as an indication to determine how likely it is for operators to achieve power consumption and emission targets.

In order for mobile network operators to upgrade existing infrastructure different options are available. Irrespective of the selected option, capacity upgrades are bound to increase the power consumption of the network. Carried through case studies, a first analysis compares a number of network evolution strategies, determining which provides the necessary performance while limiting the increase in power consumption. Overall, it is noted that a hybrid solution involving the upgrade of existing macro base station sites together with the deployment of outdoor or indoor small cells (heterogeneous network) provide the best compromise between performance and power consumption.

Focusing on one of the case studies, it is noted that the upgrade of both HSPA and LTE network layers results in the power consumption of the network increasing by a factor of 4. When coupled with the growth in capacity introduced by the various upgrades (x50), the efficiency of the network is still greatly improved. Over the evolution period, the stated increase in power consumption does not consider improvement in base station equipment. By considering a number of different equipment versions, the evolution study is further extended to also include the

impact of replacing old equipment. Results show that an aggressive replacement strategy and the upgrade of sites to remote radio head can restrain the increase in power consumption of the network to just 17%.

In addition to upgrading equipment, mobile network operators can further reduce power consumption by enabling a number of power saving features. These features often exploit redundancies within the network and/or the variation in traffic over a daily period. An example of such feature is sleep mode, which allows for base station sites to be systematically powered down during hours with low network traffic. While dependent on the traffic profile, within an urban area sleep mode can reduce the daily energy consumption of the network by around 20%. In addition to the different variances of sleep mode, the potential savings of other features are also described.

Selecting a power efficient network capacity evolution path, replacing old and less efficient equipment, and enabling power saving features, can all considerably reduce the power consumption of future mobile broadband networks. Studies and recommendations presented within this thesis demonstrate that it is realistic for mobile network operators to boost network capacity by a factor of x50, while consuming the same amount of power. While also theoretically possible to meet some of the more ambitious targets set by some operators, real financial and practical restrictions provide a considerably more challenging environment for achieving these targets.

Dansk Resume

I det seneste årti har mobilkommunikationsindustrien brudt nogle bemærkelsesværdige barrierer, ved at skubbe mere til og ændre den måde, man kommunikerer på og får adgang til oplysninger. Efterhånden som mængden af trafik i mobile netværk vokser uendeligt, skal mobilnet-operatørerne sikre, at netværkene vokser tilsvarende. Udover at opgradere eksisterende netværk, er en række operatører begyndt at udrulle endnu et radio access teknologi lag, kaldet Long Term Evolution, eller LTE.

Udover at forbedre netværkets kapacitet, er operatørerne også forpligtet til at overholde de offentlige krav om at reducere deres energi og CO₂. I 2008 meddelte Vodafone, at inden år 2020 forventes indsatsen for at reducere udledningerne at halvere de udledninger, der blev registreret i år 2006/7. Udover at præsentere et mere miljøbevidst brand, håber man også at kunne reducere omkostningerne, som på grund af stigende priser og nødvendige netværks- opgraderinger helt sikkert vil stige. Da base stationerne udgør 75% af elforbruget i mobile netværk, er undersøgelserne fokuseret på dette specifikke netværkselement. En række faktorer, som menes at spille en rolle i de mobile netværks strømforbrug, er undersøgt separat og kombineret senere, hvilket giver en realistisk indikation af, hvordan tendensen forventes at udvikle sig. Dette bruges også som en indikation til at finde ud af, hvor sandsynligt det er for operatørerne at nå strømforbrugs- og udledningsmålene.

Der findes forskellige måder, hvorpå mobilnet-operatører kan opgradere den eksisterende infrastruktur. Uanset hvilken måde, der vælges, er det nødvendigt, at opgraderingerne af kapaciteten øger netværkets strømforbrug. Gennem case studier sammenligner en første analyse en række netværksudviklings-strategier og afgør, hvilken en af dem der giver den nødvendige ydeevne og samtidig begrænser stigningen i energiforbruget. Overordnet set bemærkes det, at en hybrid løsning, som omfatter opgradering af eksisterende makro base stationer sammen med anvendelse af udendørs eller indendørs små celler (heterogent netværk) giver det bedste kompromis mellem ydelse og strømforbrug.

Ved at fokusere på et af case studierne skal det bemærkes, at opgraderingen af både HSPA og LTE-netværks lagene resulterer i en stigning i netværks-strømforbruget på en faktor 4. Når det bliver kombineret med den øgede kapacitet på grund af de forskellige opgraderinger (x50), bliver effektiviteten af netværket stadig forbedret meget. Over evolutionsperioden tager den angivne stigning i strømforbruget ikke forbedring af basestation udstyr i betragtning. Ved at overveje en række forskellige udstyrsversioner, udvides evolutions-studiet yderligere til også at omfatte virkningen af udskiftning af gammelt udstyr. Resultaterne viser, at en aggressiv udskiftningsstrategi og opgradering af sites for at begrænse transmissionstab kan begrænse stigningen i netværkets strømforbrug til kun 17%.

Udover at opgradere udstyr, kan mobilnet-operatører reducere strømforbruget endnu mere ved at igangsætte en række strømbesparende funktioner. Disse funktioner udnytter ofte overskud i netværket og /eller variationen i trafikken over en daglig periode. Et eksempel på en sådan funktion er dvaletilstand, som giver mulighed for, at base stationer kan systematisk nedlukkes i timer med lav netværkstrafik. Alt afhængig af trafik-profilen, kan dvaletilstanden inden for et byområde reducere det daglige energiforbrug i netværket med omkring 20%. Ud over de forskellige varianter af dvaletilstand er de potentielle besparelser af andre funktioner også beskrevet.

Valg af en strømbesparende netværkskapacitet evolution, der erstatter gammelt og mindre effektivt udstyr, og igangsætning af strømbesparende funktioner, kan reducere strømforbruget i fremtidens mobile bredbåndsnet betydeligt. Undersøgelser og anbefalinger, der præsenteres i denne afhandling viser, at det er realistisk for mobilnet-operatører at øge netværkskapaciteten med en faktor på x50, samtidig med der bruges samme mængde strøm. Mens det også er teoretisk muligt at nå nogle af de mere ambitiøse mål, som nogle udbydere har opstillet, gør reelle økonomiske og praktiske begrænsninger det betydeligt vanskeligere at nå disse mål.

Preface and Acknowledgement

This dissertation is a result of a three years research project carried out at the Radio Access Technology Section (RATE), Department of Electronic Systems, Aalborg University, Denmark, under the supervision and guidance of Professor Preben E. Mogensen (Aalborg University) and Hans-Otto Scheck (Nokia Siemens Networks). This research project has been sponsored by Aalborg University and Nokia Siemens Networks R&D, Aalborg, Denmark.

The research carried out over this period was also in part a contribution towards OPERANet, a European consortium with the aim of investigating possible methods for improving the end-to-end power efficiency of mobile networks. To note that the sequence in which the different studies are presented does not follow the actual chronological order of how the research has been carried out. This is done in order to present a more coherent and structured overview on the topic, work done, results, and an overall outcome.

On a more personal note, I would like to express my sincere gratitude to both of my supervisors. In addition to providing invaluable knowledge and guidance on the topic, they have both provided the right environment to trigger and stimulate thought processes that have helped me to further develop my qualities and personality. In addition, I would also like to thank Benny Vejlggaard (Nokia Siemens Networks), who through an internal NSN project, related to the power consumption of mobile networks, entrusted me with the responsibility to propose and align key objectives and overall structure. Staying on a technical level, I would like extend my appreciation to Associate Professor Troels B. Sørensen (Aalborg University), who has always provided timely and high quality feedback prior to submission of the various conference and journal papers. Of great value were also the number of technical and sometimes casual discussions with various colleagues throughout the RATE section and Nokia Siemens Networks.

I would like to also thank the two secretaries, Lisbeth Schiønning Larsen and Jytte Larsen who have both always ensured a smooth and efficient running of all administrative issues, maintaining a productive research oriented workforce. Even though this PhD can be summarized by a bunch of singular achievements and statistics, I like to look at this period of time as a lifetime experience. In addition to the constant exposure and absorption of technical knowledge, the PhD process has

put me in situations that have pushed and extended my comfort zone boundaries, making me more confident and structured to adapt and deliver beyond what is requested.

Contents

Abstract	iv
Dansk Resume	vi
Preface and Acknowledgement	viii
Contents	x
1. Introduction	1
1.1 <i>Evolution of Mobile Communications</i>	1
1.2 <i>Challenges that Require Action – Curbing Carbon Emissions and Costs</i>	3
1.2.1 <i>Ongoing Initiatives</i>	5
1.3 <i>Thesis Objectives</i>	6
1.3.1 <i>Extended Description</i>	7
1.4 <i>Scientific Methodology</i>	10
1.4.1 <i>Result Generation Practices</i>	12
1.4.2 <i>Accuracy and Reproducibility of Results</i>	13
1.5 <i>Novelty and Contributions</i>	13
1.6 <i>Thesis Outline</i>	16
2. Unleashing Mobile Broadband	18
2.1 <i>Traffic Growth</i>	18
2.1.1 <i>Traffic Characteristics</i>	18
2.2 <i>Developments in Network Access Technologies</i>	20
2.2.1 <i>Evolution of Mobile Networks</i>	22
2.2.2 <i>Heterogeneous Networks</i>	23
2.3 <i>Cost and Business Considerations</i>	26
2.3.1 <i>Trends in the Cost of Energy</i>	27
3. Base Station Site Modeling	29
3.1 <i>Mobile Network Overview</i>	29

3.2	<i>Base Station Site Architecture</i>	30
3.2.1	RF Module	31
3.2.2	System Module	32
3.2.3	Feeder Cables and Antenna	32
3.2.4	Site Cooling	34
3.2.5	Backhaul	35
3.2.6	Battery Backup	35
3.3	<i>Macro Site Power Model</i>	36
3.3.1	Fixed vs. Load Dependent Power	36
3.3.2	Power Consumption Model	37
3.3.3	Feeder Cable and Site Cooling	39
3.3.4	Power Consumption with Load	41
3.3.5	Site Upgrades with MIMO	42
3.3.6	Network Capacity Upgrades with LTE	43
3.4	<i>Small Cell Power Model</i>	44
3.4.1	Outdoor Small Cells	44
3.4.2	Indoor Small Cells	46
3.5	<i>Network Power and Efficiency</i>	47
3.6	<i>Improvements in Base Station Equipment</i>	48
3.7	<i>Limiting Power Consumption Growth</i>	52
3.7.1	Power Efficient Capacity Evolution	52
3.7.2	Equipment Replacement	52
3.7.3	Dedicated Features	53
3.7.4	Network Sharing	53
3.8	<i>Conclusions</i>	53
4.	Macro vs. Small Cell Layout for Power Consumption	55
4.1	<i>Introduction</i>	55
4.2	<i>Network Scenario Setup</i>	57
4.2.1	Network Simulation Environment	57
4.2.2	Network Key Performance Indicator	62
4.2.3	Site Configuration and Power Consumption	64
4.3	<i>Results for Regular Deployment</i>	64
4.3.1	Network Performance	64

4.3.2	Power Consumption.....	67
4.3.3	Financial and Practical Aspects	69
4.4	<i>Conclusions</i>	70
4.4.1	Take-Away Points	71
5.	Power Consumption Trend – A Sub-Urban Case Study	72
5.1	<i>Introduction</i>	72
5.2	<i>Network Data Extraction</i>	73
5.1	<i>Sub-Urban Network Scenario</i>	73
5.1.1	Digital Maps	74
5.1.2	Path Loss Model	75
5.1.1	Picocell Deployment.....	76
5.2	<i>Traffic Growth Forecast Model</i>	77
5.2.1	User Distribution and Network Performance	79
5.2.2	Receiver Types and Considerations	80
5.3	<i>Evolution Strategies</i>	80
5.4	<i>Power Consumption Assumptions</i>	84
5.5	<i>Network Evolution Results</i>	85
5.5.1	Power Consumption.....	86
5.5.2	Network Evolution Trade-Offs	88
5.6	<i>Impact of Different Equipment Versions</i>	89
5.6.1	Assumptions for Equipment Replacement	90
5.6.2	Network Power Consumption Trend	91
5.6.1	Further Site Upgrades to Remote Radio Head	92
5.6.2	Network Energy Efficiency	93
5.7	<i>Conclusions</i>	95
5.7.1	Take-Away Points	95
6.	Power Consumption Trend - A Dense Urban Case Study	97
6.1	<i>Introduction</i>	97
6.2	<i>Scenario and Model Description</i>	97
6.2.1	Path Loss Models	99
6.2.2	Distribution of Outdoor and Indoor Users	100
6.2.3	Small Cell Deployment	100

6.3	<i>Evolution Strategies</i>	101
6.4	<i>Power Consumption Assumptions</i>	102
6.5	<i>Network Evolution Results</i>	103
6.5.1	Power Consumption.....	106
6.5.2	Network Evolution Trade-Offs	107
6.6	<i>Conclusions</i>	108
6.6.1	Take-Away Points	108
7.	Power Saving Features	110
7.1	<i>Introduction</i>	110
7.2	<i>Base Station Sleep Mode</i>	111
7.2.1	Different Flavors of Sleep Mode	111
7.2.2	Sleep Mode for Macro Base Station Sites	114
7.2.3	Sleep Mode for Heterogeneous Networks.....	125
7.2.4	Other Considerations for Sleep Mode	131
7.3	<i>Upgrades to Macro Base Station Sites</i>	132
7.3.1	Introduction	132
7.3.2	Re-Allocation and Bundling of Spectrum	133
7.3.3	Reduction in Transmission Power	135
7.4	<i>Other Power Saving Methods</i>	137
7.4.1	Overall Site Clean Up.....	138
7.4.1	Traffic Filtering	138
7.5	<i>Conclusions</i>	140
7.5.1	Take-Away Points	141
8.	Thesis Outcome	142
8.1	<i>Prospects of MNOs to Reach Targets</i>	142
8.2	<i>Conclusion</i>	143
8.2.1	Expected Energy Trend	145
8.3	<i>Future Work</i>	146
	Appendix A	147
	Base Station Measurement Campaign	147

A.1	<i>Scope</i>	147
A.2	<i>Scenario</i>	147
A.3	<i>Results</i>	149
A.4	<i>Conclusions</i>	154
A.4.1	<i>Take-Away Points</i>	154
Bibliography		155
Abbreviations		170

1. Introduction

1.1 Evolution of Mobile Communications

Over the last decade, the mobile communications industry has broken through some remarkable barriers, pushing further and transforming the way people communicate and access information. Up until the late 1990s, mobile phones merely provided a wireless extension to the legacy wired system, connecting individual devices with one another, primarily for voice services (Figure 1.1). Along the years, the popularity and convenience of mobile phones, together with advances in technology, have allowed for cheaper, smaller, and more versatile phones to hit the market. Following the launch of Universal Mobile Telecommunications System (UMTS), this allowed for mobile network operators (MNOs) to also support and provide data connections at faster rates, serving as a gateway to the internet and various internet-based services. In the first years, it became clear that the uptake of such services was weak, with voice remaining the dominant revenue generating service. At the time, reasons hindering the uptake of mobile data services included, unattractive pricing, lack of dedicated content, low data rates (comparable with fixed broadband connections), and an overall poor user experience.

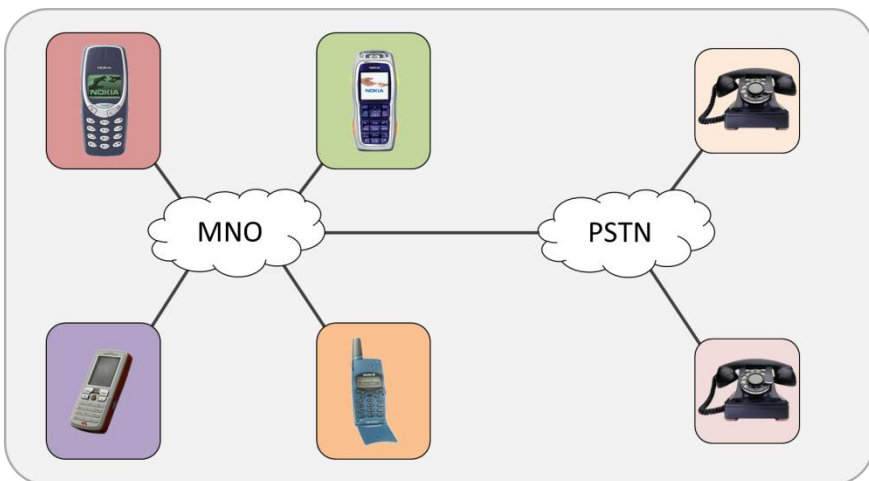

Figure 1.1 – Originally, mobile networks provided an extension, and connection, to the legacy wired PSTN system. This illustration does not depict further connection to other networks.

In addition to supporting added services, the overall structure of cellular networks has undergone considerable changes, moving from a legacy circuit switched system towards a more flexible and dynamic IP Multimedia Subsystem¹ (IMS) network [1]. On the handset side, improvements in hardware, processing speeds, and manufacturing capabilities, have allowed for devices to improve performance, enabling multitasking and a convincing multimedia user experience. In order to differentiate from legacy mobile devices, these data-centric devices are now widely referred to as smart phones [2]. With the consumption of data still in ‘low-gear’, a revolution hit the market in 2007 when Apple Inc. announced the launch of its first generation iPhone. In addition to introducing a radical interface, the iPhone introduced a platform² for third-party developers to build and distribute applications (or apps) and/or content [3]. This in conjunction with flat-rate pricing, and further upgrades to support higher data rates, provided the right environment for data services, now termed mobile broadband, to take off.

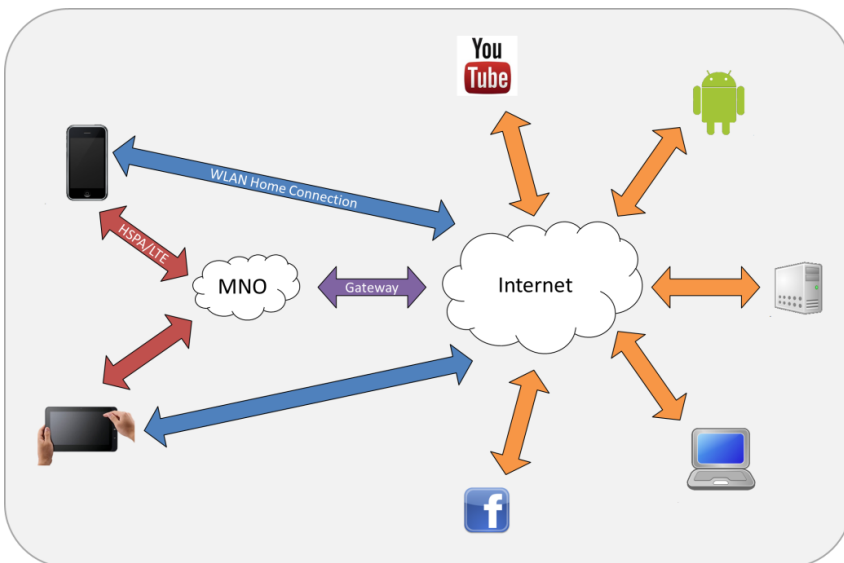

Figure 1.2 – In addition to traditional services, the ability to connect to the Internet provides access to wider array of cloud-based³ services, offered either by the MNO or by external third-parties.

¹IMS is a standardized IP architecture that allows the convergence of fixed and mobile communication devices, multiple networks types, and multimedia applications [1].

² Other systems (Android, etc.) make use of similar platforms extending the concept to all smartphones.

³ The cloud refers to the use of remote resources to host and execute an array of services, which are then delivered to the end user over a network, typically the internet.

As illustrated above in Figure 1.2, in addition to supporting core telecommunication services, the role of MNOs now also includes the need to provide reliable access to the internet, and cloud-based services offered over it. While empowering the subscriber, this adds further competition to the same MNO, who now has to also compete with outside providers offering the same type of telecom services, primarily voice and text [4]. In addition to this, in recent years MNOs are also being faced with a further challenge. Driven by various fronts, this entails MNOs to reduce carbon emissions and related energy costs.

1.2 Challenges that Require Action – Curbing Carbon Emissions and Costs

Over the last decade, the challenges imposed by climate change have taken a pivotal role, increasing political and public awareness worldwide. Scientific studies [5] suggest that an increase in Green House Gases (GHG), more specifically carbon dioxide (CO₂), is among the main drivers for climate change. In order to alleviate some of their carbon footprint, a number of industries are exploiting advances and opportunities within the Information and Communication Technologies (ICT) sector, a move which is expected to reduce [6] global emissions by 20-30% [7]. Currently responsible for 2-3% of the overall CO₂ emissions, the expansion of ICT infrastructure necessary to support the expected growth is expected to increase emissions further (Figure 1.3). In some cases [8], it is estimated that the rate at which emissions increase will double over a five year period.

In order to demonstrate its commitment in tackling and acting upon climate challenge, the European Commission (EC) officially set three bold targets for all of its member states. Summed up, these included, a 20% reduction in the emission of GHG, a 20% reduction in the total energy consumption, and a 20% share of the energy requirements to originate from renewable sources, all to be achieved by the year 2020 [9]. Energy consumption and GHG emissions are closely related, with a reduction of the former automatically reducing the latter. This practice is visible within the telecommunications sector, with mobile operators and equipment vendors alike promoting more energy efficient practices and equipment. A number of operators have gone a step further, publicly committing into reducing the carbon emissions and/or energy consumption of their networks within a specific timeframe. In 2008, Vodafone attracted media attention by stating an ambitious reduction in

carbon emissions by 50% by 2020 [10]. Similarly, other operators have also followed suit, promoting similar initiatives, targets and initiatives [11].

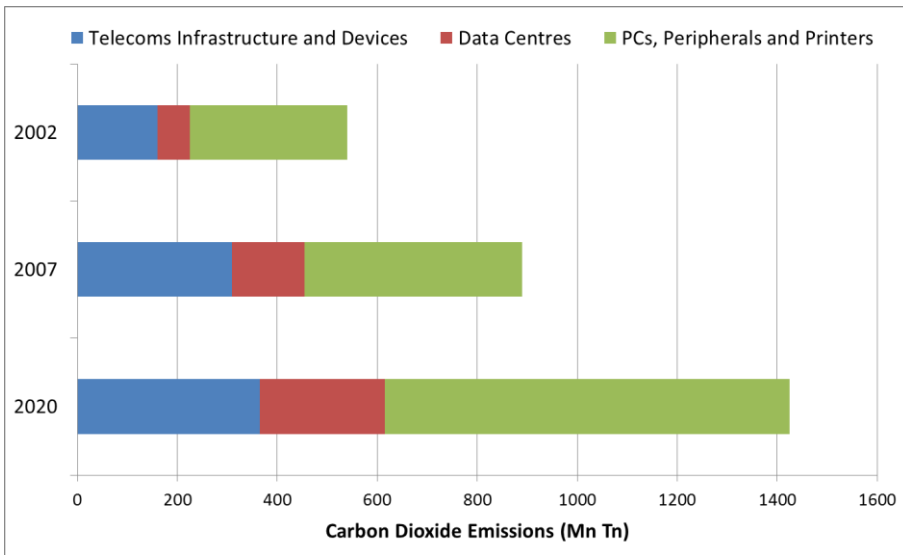

Figure 1.3 – Evolution of the carbon dioxide emissions as a result of the expanding ICT sector. The figure is based on numbers extracted from [7].

While a reduction in energy consumption can be related to a reduction in carbon dioxide emissions, operators are also interested in limiting their long-term energy costs [12]. Vodafone reports that over a three year period between 2009 and 2011, the combined impact of entering new markets and upgrading existing networks, resulted in doubling the number of owned base station sites [10]. This is reported to have increased energy consumption by around 35% [10]. In addition to this, energy related costs are worsened further with increasing energy prices [13]. From an operations perspective MNOs are also being faced with additional financial restrictions and challenges. An example is the recent (forced) reductions in EU roaming charges [14], or the growing popularity of third-party services that bypass similarly billed services offered by the operator [15] [4]. The latter starts to push the role of MNOs towards ultimately becoming a wireless ‘bit pipe’ [16].

Nonetheless, in order to sustain the current growth in mobile data and retain existing subscribers, mobile operators are required to forecast future traffic demands and ensure that the capacity of their networks can be scaled accordingly, and in a timely fashion. This requires considerable planning and has for many years been driven by two main criteria, capacity (performance), and cost. The importance

of also controlling energy and its related costs has in recent years added this to the list of requirements and criteria on which decisions are based.

1.2.1 Ongoing Initiatives

Commercial organizations, environmental and government groups, as well as the broader research community [17] have all invested resources in understanding the impact, and improving or proposing alternatives for reducing the energy consumption of mobile networks. As of 2008, a number of dedicated research projects sprung into life, with some of the more prominent projects being: OPERANet (Optimizing Power Efficiency in Mobile Radio Networks) [18] [19], Green Radio Core 5 Research Program in Mobile VCE [20], and more recently, EARTH (Energy Aware Radio and Network Technologies) [21] an integrated project under the European Framework Program 7. Other more generic studies quickly hopped onto the green radio bandwagon, highlighting the energy related benefits of other, mainly performance-centric features. An example is Self-Optimizing or Organizing-Networks (SON), in which the dynamic adjustment of network parameters improves performance, and with it energy efficiency [22].

Sifting through publications, it becomes clear that the topics and type of results presented by the academia and industry are of a different nature. Often based on standardized scenarios, academic research focuses on proposing improved or revolutionary architectures [23], standards [24], and algorithms [25] [26]. While important for long-term advances, this is of limited value for MNOs seeking short to medium-term solutions for the existing networks. On the other hand, industry driven publications [27] [28] frequently take a more practical approach, exploiting real world network statistics, and scenarios. In addition, these often also include results from trials and actual implementation of proposed improvements.

The work presented in this thesis is mainly focused around a number of separate investigations, most of which are based on real network scenarios and traffic data. This, and the fact that most of the studies are targeted towards realistically addressing the short to medium term challenges of MNOs, pushes the overall objectives of the thesis towards a more industrial-oriented audience. In some sections, this thesis also considers and proposes a number of alternate, yet promising and possible, upgrades within base station sites and related configurations. While all proposed cases are also described from a practicality point

of view, the ones that require a more considerable shift from existing telecommunications practice⁴ are appropriately highlighted and described.

1.3 Thesis Objectives

The main objective of this thesis can be summarized as being that of:

- Providing a set of concrete recommendations for MNOs on how to evolve an existing radio access network infrastructure, necessary to support the expected growth in mobile data traffic, in an energy efficient manner.

While the evolution of any network is very case-specific, this thesis provides a detailed overview categorizing between three distinct network upgrade paths, primarily macro only upgrades, small cell only upgrades, and a hybrid between the two. The evolution studies included are primarily targeted at providing an understanding towards the impact and trends of the different paths, for specific network area types, and not that of providing a tailored and optimized solution.

In addition to the energy consumption aspects of an evolving radio access network, this thesis also includes two further aspects, believed crucial for defining the overall energy consumption trend for mobile networks.

- As the network is evolved, some of the existing base station equipment is replaced with modern, more energy efficient hardware. Inherently, this replacement offsets some of the increase in energy consumption due to capacity upgrades. A section within this thesis is dedicated towards providing a realistic estimate to the reductions in energy consumption that MNOs can expect from different strategies of replacing aging base station equipment.
- In addition to being more energy efficient, modern hardware provides the added flexibility of implementing a number of energy saving features. A chapter within this thesis is entirely dedicated towards investigating the potential impact, in terms of energy and performance, such features can introduce.

⁴ This primarily refers to cases in which the existing allocation and use of spectrum is altered to maximize base station equipment utilization and energy efficiency.

Piecing together all of the above provides a more comprehensive understanding towards the expected energy consumption trend for MNOs. This trend is then put into perspective with the commitments set by MNOs (stated earlier) of reducing the energy consumption and carbon emissions over the coming years, providing an indication to the likelihood of meeting such targets.

1.3.1 Extended Description

MNOs can increase network capacity through a variety of site deployment and upgrades strategies. With a steady transition towards heterogeneous networks, the deployment of outdoor and/or indoor small cells is expected to offload existing macro sites while also providing improved indoor coverage and capacity. Figure 1.4 describes the three main network upgrade paths considered within this thesis for upgrading an existing macro based network.

Different upgrade strategies can be tailored to provide similar improvements in network capacity and performance. However, based on the scenario and existing infrastructure, these are likely to result in a different impact on the energy consumption trend of the network. Through detailed case studies, a number of options (for the three main upgrade paths) are assumed and compared for performance, energy, and to a limited extent, cost, providing a complete picture of how these criteria are associated (Figure 1.5). With energy consumption being the main objective of this thesis, the provided recommendations are accompanied by a description of the potential impact that recommended evolution paths and features can have on all of these aspects.

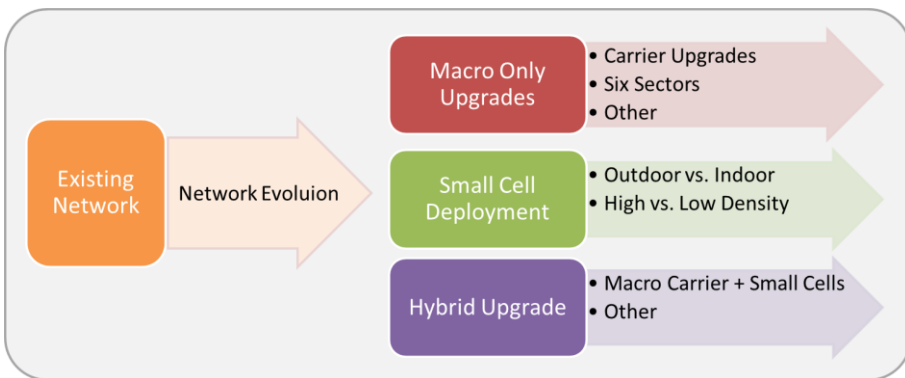

Figure 1.4 – Three main network upgrade paths considered for the evolution of existing macro networks. For each of the options, a number of possible options are also described.

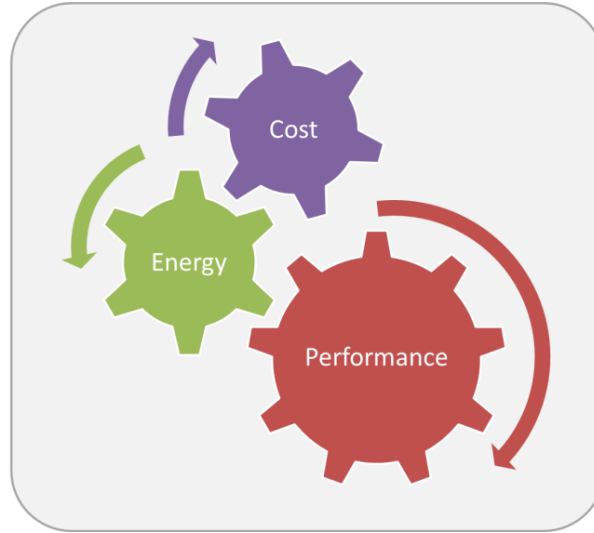

Figure 1.5 – In order to ensure performance, MNOs are required to upgrade mobile networks in an energy and cost effective manner. Unfortunately these criteria often oppose each other, with some form of compromise necessary to balance all three.

By not considering the impact of different base station equipment, the addition of capacity and new sites automatically increases the energy consumption of the overall network. Base station equipment has in the last decade undergone considerable improvements in performance, capabilities, flexibility, and energy efficiency. Even though the rate at which improvements occur may fluctuate, the energy efficiency of future versions can only be expected keep on improving.

The addition of different equipment versions to the resulting evolution strategy presents a novel and realistic insight into how the energy consumption is expected to evolve. Being dependent on a number of external, and operator specific criteria, it is impractical to define any detailed network replacement strategy. Nonetheless, by considering a number sensible assumptions and strategy, an estimate on the impact that equipment replacement can have on the energy consumption can be determined. Added to the energy consumption as a result for of the necessary upgrades, this establishes whether base station site replacement is sufficient to arrest or reverse the otherwise upwards trend. These two opposing trends, that is, the energy consumption of base station equipment, and the amount of necessary capacity upgrades, ultimately determine the overall energy consumption growth or regress of the network. This concept is illustrated within Figure 1.6.

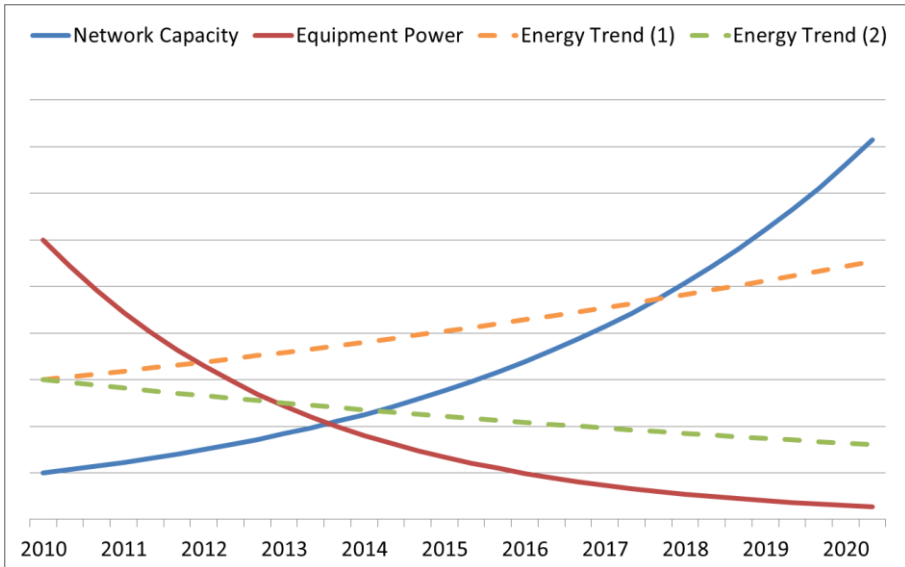

Figure 1.6 – Generic (predictive) trend for capacity, equipment power, and network energy. With the intention of the figure being that of depicting evolving trends, quantitative details are omitted. Based on the number of necessary upgrades and the rate with which base station equipment improves, the overall energy trend could either tilt upwards or possibly even downwards.

In addition to energy efficient capacity upgrades and equipment replacement, operators can also exploit variations in traffic and network specific redundancies to deploy one or more energy saving features. The combination of all three factors provides a comprehensive overview on how the energy consumption trend of mobile networks can be expected to evolve. Given that these factors can be considered as being the main factors affecting the short to medium-term energy consumption trend, this provides more tangible information on determining whether mobile network operators can in fact abide, and what would be necessary, to earlier described commitments.

In addition to providing a holistic overview on the topic of energy saving, the work described within this thesis provides a detailed insight into the different aspects affecting the evolution of energy consumption within mobile networks. Primarily based on case studies within real networks, results and recommendations are mainly targeted towards MNOs, providing concrete information on the impact/potential that specific upgrade paths, equipment replacement, and energy saving features can have on the overall energy consumption of mobile networks. This directly targets existing short to medium-term challenges.

1.4 Scientific Methodology

This section provides an insight in the process guiding the project, ensuring along the way the achievement of sought results. Common to any research project, a firm understanding of the state-of-the-art for the specific topic is necessary for defining a clear picture and provide knowledgeable insight into,

- What the problem is
- The root cause of the problem
- And the options / challenges available to overcome these problems

As a first step, an extensive literature review was carried out. In the early days of the project, it was noted that the number of publications tackling the topic of energy saving from a system (high) level⁵ were still few in numbers. The first wave of published material primarily consisted of market research articles [29] [30] that acknowledged and described the growing problem in further detail. These highlighted potential methods to mitigate the issue, promoting further research [31].

Later publications [32] [33], provided further detail into the key areas (power amplifiers, feeder cable loss, etc.) responsible for the overall low energy efficiency of base station sites, proposing possible remedies and upgrades. These also provided a vague estimate to the potential energy gain of such remedies, generally given on a per site basis [33], with no or little detail on the overall impact (energy and performance), as seen by the operator. In addition to this, due to the lack of a standardized measure for energy consumption and efficiency, each study selected its own yardstick and published results in accordance to that. With regard to the considered scenario, many of the studies are based on regular networks, making it difficult to determine the impact on performance of specific features within a real irregular network.

With the intention of introducing a realistic viewpoint to the topic of energy saving, results presented in this thesis exploit an ongoing collaboration between Nokia Siemens Networks (NSN), a number of mobile network operators, and Aalborg University. Network performance results are generated and based on static Monte-

⁵ Within this thesis, system level studies refer to providing a broader more complete picture, allowing for MNOs to realistically understand the implications of carrying out different type of upgrade paths, equipment replacement strategies and energy saving features.

Carlo system level simulations. While at times within this thesis, reference is made to the possible impact of specific energy saving features on the uplink, all of the simulations carried out only consider downlink. While the accuracy of such simulations is dependent on the details of the implemented models and assumptions, most of the network data fed into the simulator is directly imported and/or modeled around actual networks and traffic data⁶. Even though three distinct network evolution paths are investigated, the specific variances adopted for each path are determined through discussions with the collaborating operator providing the relevant network data. This ensures that the proposed strategies fit closely with the existing strategy of the operator, exploiting already owned resources in terms of infrastructure and spectrum. By considering, in collaboration with the operator, and focusing on the short to medium-term evolution of mobile networks, this limits any further uncertainties that may arise within such a dynamic environment.

On the energy front, the proposed models are achieved through equipment measurements, discussions with NSN hardware experts [34] [35] [36] [37], and a number of published third-party references⁷. In order to provide a higher degree of flexibility (sensitivity analysis), as the complexity and dependencies of these models evolved, a dynamic spreadsheet-based energy tool was developed. By considering the resulting network layout and configuration of each site as an input, this estimates the energy consumption for the network area. While these models provide a good estimate to the energy consumption values that a network operator could observe, the objective of this thesis is primarily that of providing a comparative analysis of the different evolution paths, energy saving features, and overall energy trends.

The overall study presented within this thesis was carried out based on a number of incremental steps, each time adopting the new learning, and extending it further to include another factor. For each step, major results and recommendations have been disseminated through numerous journal and/or conference papers. At the end of the study period, the combination of various analyses have allowed for this thesis to provide a detailed insight on the topic of energy consumption within mobile broadband networks, highlighting how this can be expected to evolve over the next decade.

⁶ The thesis is based on studies carried out on network areas within major European cities.

⁷ Third-party references are obtained from both the industrial and academic world.

1.4.1 Result Generation Practices

Although the focus of this project is energy consumption, a common level of performance is required for all considered evolution scenarios. Network performance is determined and ensured through detailed Monte-Carlo system level simulations, providing a common measure against which different topologies and evolution strategies can be fairly compared. The main network performance criterion, common throughout the thesis, is referred to as outage. This represents the percentage of users within a network area that fail to achieve a predefined requested data rate. In addition to outage, other network performance statistics, such as average network throughput, are also extracted and compared. Together with the consumption, this provides a measure for the energy efficiency of the network (Figure 1.7), a further parameter exploited to better compare the different network topologies considered. To note that while energy consumption is the main term used throughout these first two chapters, most of the analyses refer to and compare the power consumption of the resulting network layouts⁸. Energy consumption is then again introduced when considering energy saving features, which are investigated and presented over a 24 hour period.

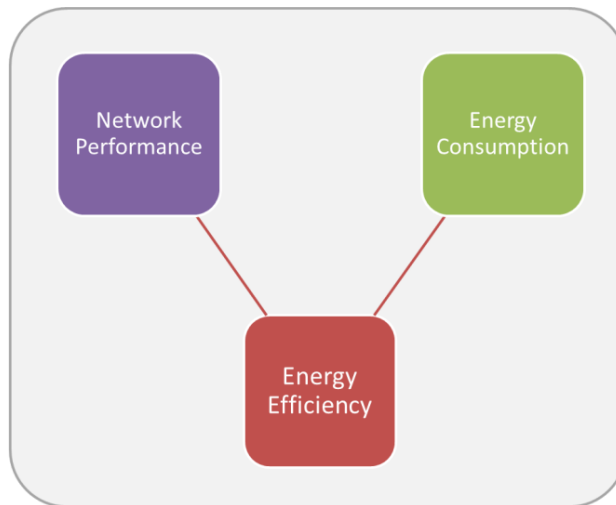

Figure 1.7 - The combination of performance and energy consumption provide further information on the energy efficiency of the network.

⁸ This is primarily due to the fact that simulations are static (no concept of time) with no dynamic variations in power consumption.

After a specific scenario meets the predefined minimum performance requirement, the resulting network topology, and site configuration, is extracted from the simulator and imported within the dedicated spreadsheet-based tool. In addition to calculating the power consumption, this also provides the flexibility of performing sensitivity analyses on a range of potentially variable parameters. This allows for a better understanding on the impact that any future changes would have on the results presented.

1.4.2 Accuracy and Reproducibility of Results

The accuracy of results is largely dependent on the accuracy and complexity of the various models and algorithms. The assumptions upon which these are based are presented within the forthcoming sections. Network and traffic related data and models are in most cases based on data provided by the operator, making each irregular scenario to some extent unique. While the models and assumptions presented are targeted to deliver realistic performance results (from a quantitative perspective), these also allow for similar outcomes and trends being generalized for other scenarios that are similar to the ones investigated.

On the other hand, energy consumption models and associated assumptions allow for an exact reproduction of all related results. In addition to this, these models can also be applied to estimate the consumption of other configurations, both real and fictitious. In real networks, a vast array of different base station site configurations and equipment exist. While difficult to accurately reproduce the energy consumption for all possible permutations, considerable effort is put into having a fair and realistic value for most of the common configurations and equipment. For this purpose, references from equipment vendors, dedicated studies, and further discussions with NSN equipment experts [38] [34] [37] are exploited as a base for the various models and assumptions. This provides a high level of confidence that presented results provide a pragmatic indication on the energy consumption of base station sites and hence mobile broadband networks.

1.5 Novelty and Contributions

A number of existing studies propose novel algorithms and architectures for improving the energy efficiency of mobile networks. While useful for proving and

pushing concepts towards future systems, the contribution towards practical⁹ short to medium-term challenges is limited. This thesis is broken down into a number of sections, each presenting and discussing the state-of-the-art for a specific topic/area, followed by the details of the study itself. These are towards the end put together to provide a more detailed and complete picture, a picture that can be directly applied and interpreted by any MNO.

While some of these sections have been mentioned and to some extent studied in other publications, none has yet been noted to provide the extent of results and network energy trends presented in this thesis. In addition to being based on realistic network scenarios, results are used to provide indications and recommendations for the path that MNOs should take for upgrading existing networks. While energy consumption remains the main objective, proposed recommendations also highlight the potential impact on network performance, together with a range of practical and financial real world limitations.

Dissecting the study into individual sections provides a structure to systematically track progress and re-evaluate the details for future studies. This also provides a natural interval for disseminating results through the publication of conference and journal papers. Some of the work and results presented in this thesis has been generated and/or presented through the OPERANet project, a Celtic Initiative consortium [18]. Of interest during this collaboration is a base station site measurement campaign, the details of which are presented in Appendix A.

With regard to the number of contributions, different studies carried throughout the timeline of this project have resulted in a total of six conference papers and four journal articles. By dividing these contributions into four distinct categories, a list of all contributions is hereby summarized.

The first set of conference papers look at the potential of energy saving through the deployment of energy specific features, more specifically sleep mode, proposed and applied in different variances. These and other results are grouped together in a subsequent journal article.

G. Micallef, P. Mogensen, H.O. Scheck, "Cell Size Breathing and Possibilities to Introduce Cell Sleep Mode", European Wireless, Lucca, Italy, April 2010.

⁹ The emphasis on practical refers to studies that propose a range of new architectures which are either impractical to implement, or require a drastic shift in user habits and the telecommunications industry.

G. Micallef, P. Mogensen, H.O. Scheck, "Dual-Cell HSDPA for Network Energy Saving", 71st IEEE Vehicular Technology Conference, Taipei, Taiwan, May 2010.

G. Micallef, "Methods for Reducing the Energy Consumption of Mobile Broadband Networks" Teletronikk, Telenor, 2010.

In a second phase, investigations focus on the impact of different network evolution strategies, necessary for ensuring capacity expansion. At a later stage, the potential of replacing old base station equipment is also included.

G. Micallef, P. Mogensen, H.O. Scheck, E. Lang, "Energy Efficient Evolution of Mobile Networks – Macro-Only vs. Joint-Pico Deployment", 73rd IEEE Vehicular Technology Conference, Budapest, Hungary, May 2011.

G. Micallef, P. Mogensen, H.O. Scheck, J. Louhi, "Reversing the Energy Trend in Mobile Networks – Equipment Replacement for Increased Capacity at a Fraction of the Energy", 74th IEEE Vehicular Technology Conference, San Francisco, USA, September 2011.

G. Micallef, P. Mogensen, H.O. Scheck, "Energy Savings through Site Renewal in an HSPA/LTE Network Evolution Scenario", Wireless Innovation Forum, Software Defined Radio 2011, Workshop on Green Radio, Brussels, Belgium, June 2011.

L. Saker, G. Micallef, S.E. Elayoubi, H.O. Scheck, "Impact of Picocells on the Capacity and Energy Efficiency of Mobile Networks" Annals of Telecommunications, Volume 62(3-4), April 2012.

G. Micallef, P. Mogensen, H.O. Scheck, "Spectrum Reorganization and Bundling for Power Efficient Mobile Networks", 76th IEEE Vehicular Technology Conference, Quebec, Canada, September 2012.

The remaining journal articles group together some of the work and presents a more descriptive overview on the challenges, issues, and potential options of MNOs to reduce the energy consumption of mobile networks.

G. Micallef, P. Mogensen, H.O. Scheck, "Mobile Operators have Set Ambitious Targets – Is it Possible to Boost Network Capacity While Reducing its Energy Consumption?" EURASIP Journal on Wireless Communications and Networking, Special Issue on Green Radio, Volume 2012 (34), February 2012.

G. Micallef, L. Saker, H.O. Scheck, S.E. Elayoubi, "Realistic Energy Saving Potential of Sleep Mode for Existing and Future Mobile Networks" Journal of Communications, Special Issue on Improving the Energy Efficiency of Cellular Communications, Volume 7 (10), October 2012.

1.6 Thesis Outline

Having introduced a broad overview on the methodology, novelty and contributions, the remaining of this thesis is organized in the following chapters.

Chapter 2 provides a more detailed look at the evolution of mobile networks, highlighting traffic growth drivers, characteristics, and the available methods for upgrading network capacity. With heterogeneous networks set to play a crucial role in the evolution of existing networks, further insight into a number of practical and/or cost implications are also lightly described within this chapter.

Chapter 3 is the key chapter introducing the topic of energy consumption in mobile networks. An overview on the energy consumption in mobile networks justifies why the focus of this thesis is based around base station sites. At this point the structure of base station sites is presented in further detail, leading to a detailed presentation of the various energy models used for the different base station site configurations. Based on the described base station site characteristics, the last section provides a short descriptive list of possible options for reducing the energy consumption of mobile networks, most of which are investigated further in subsequent chapters.

Chapter 4 introduces a first deployment study based on an entirely regular and homogeneous network. Assuming a greenfield scenario, the objective of this section is to determine which homogeneous deployment, macro vs. small cells, is most energy efficient. This is done in an attempt to answer whether a few high power base station sites are more efficient than a larger number of small, low powered, cells. This chapter is also used to introduce most of the main functionalities and models encompassed within the simulation tool used throughout this thesis.

Chapter 5 introduces an investigation to determine the expected power consumption trend for mobile networks. Focusing on a sub-urban case study, a common performance measure is selected to fairly compare the power consumption of different capacity evolution paths. In addition to this, the final section of this chapter also considers the impact of replacing and upgrading old base station equipment.

Similar to the previous, Chapter 6 considers the evolution of a mobile network within a dense urban scenario. Carried through a similar case study, focus is

dedicated towards a traffic hotspot area, evaluating also the impact of deploying indoor small cell solutions on the power consumption of the network. This chapter also compares the impact of outdoor versus indoor small cell deployment strategies from an energy and performance perspective.

Chapter 7 looks at an array of additional energy saving features, applicable to existing and future mobile networks. The first section looks at the potential impact of sleep mode, extending the study to also determine savings for different areas and over a variety of sleep mode cycles. A number of other energy saving features and methods that exploit some form of network redundancy during hours of low network traffic are subsequently investigated.

Chapter 8 puts all of the above investigations together, providing a single common outcome, putting into perspective the targets set by mobile network operators. This leads to a more general concluding statement, which is summarized in two concrete points. After briefly describing and supporting these conclusions, a short discussion presents the targets that mobile network operators could realistically achieve, and are encouraged to aim for. Based on the material covered within this thesis, the chapter is finished off with a brief overview on a number of potential future studies that could provide an even richer and more complete picture than the one presented.

Appendix A presents a detailed overview of a site measurement campaign carried out as part of the OPERANet project. This presents a range of interesting trends that reinforce a number of assumptions on which the various energy models are based. In addition to supporting some energy related assumptions, some of the results observed in this measurement campaign can also be used to motivate research in other areas, primarily that of network optimization and traffic steering.

2. Unleashing Mobile Broadband

This chapter introduces some of the main trends and technologies shaping the evolution of mobile networks. Some key factors increasing the concern for energy consumption in mobile networks are also discussed in further detail. This chapter points out some of the footholds which the subsequent analyses exploit, presenting also an overview on the state-of-the-art within the various sections.

2.1 Traffic Growth

Over the past years, one of the main drivers shifting attention towards the energy consumption of mobile broadband networks is the consistent growth in experienced mobile traffic. The widely referred report shedding light on the use of data and expected trends is the Cisco Visual Networking Index (VNI). In the most recent version of the report, Cisco has once again announced that the global volume of data traffic has more than doubled in 2011, surpassing previous expectations [39]. In addition to the natural transition of users heading towards mobile broadband, the constant flood of connected and interactive devices (smartphones, tablets, laptops, cars, appliances, etc.) is increasing the subscriber group at an even faster rate. Exploiting the ability to access and share content across multiple devices and services, together with an improved user experience is increasing the amount of content being generated, and consumed by each user¹. In fact, the formerly mentioned report states that the volume of traffic consumed per smartphone has in 2011 almost tripled [39]. As described in Figure 2.1, it is this combined increase in mobile broadband subscribers, devices per subscriber, and consumed traffic per device, the main cause for the exponential growth in mobile data traffic.

2.1.1 Traffic Characteristics

Common for most communication networks, traffic over a single node oscillates widely if observed over a short period of time². Measurements averaged over an

¹ In 2011, mobile video traffic exceeded the 50% mark [31], making it the main culprit for the overall data consumption growth in mobile networks.

² When measuring traffic a short period of time often refers to the second scale.

extended (hourly) period can present additional insight into the characteristics of a specific area and/or network. Over a common period of time traffic can vary based on the day, location, and other external events. For instance, on a regular weekday most subscribers are likely to travel to city centers and/or industrial areas from their homes where they return in the evening. This creates different traffic profiles for different areas within the network, requiring for MNOs to plan and provide sufficient capacity to serve busy hour traffic for each area.

Predicted Device and Traffic Growth			
	2011 MBs per Month	2016 MBs per Month	2011-2016 Device No. CAGR
M2M Module	71	266	42%
Smartphone	150	2,576	24%
Portable Gaming Device	317	1,056	56%
Tablet	517	4,223	50%
Laptop	2,131	6,942	17%

Figure 2.1 – Increase in the number of devices and traffic per device as predicted by Cisco [39].

Statistics show that a major portion of the traffic is attributed to stationary or slow moving users [40], often located indoors, which tends to reinforce why the busy hour for residential areas often occur at about nine/ten in the evening [41] [42]. A similar trend can be noted in Figure 2.2, illustrating traffic statistics from a real network. In this case, the busy hour, noted to carry about 7% of the daily traffic, occurs at nine in the evening [43].

With mobile networks designed to cope with busy hour traffic, a reduction in demand leads to sites running at low load over extended periods of time. This has inspired extensive research for optimizing the use of resources, and hence the overall efficiency of mobile networks. In addition to other techniques, Nokia Siemens Networks and other equipment vendors have tackled this problem by proposing baseband pooling, a flexible method that centralizes processing capacity within a specific region, distributing it as needed to surrounding base station sites [44]. With regard to reducing the energy consumption of mobile networks, variations in traffic are often considered as an opportunity [45] to enable energy

saving features such as sleep mode. These and other similar features that exploit variations in network traffic are presented in further detail in Chapter 7.

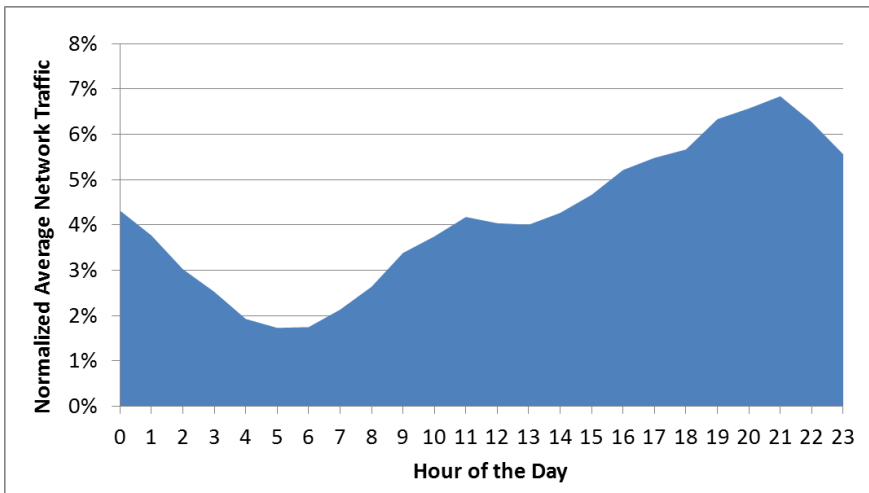

Figure 2.2 –Traffic data from a European residential area. Averaged over one week, the traffic is normalized against the total traffic, highlighting the percentage of traffic carried by each hour [43].

2.2 Developments in Network Access Technologies

As new services emerge, mobile network operators are expected to upgrade and evolve their networks to adequately support these services while at the same time ensuring support for legacy services. Figure 2.3 provides a graphical overview of the different radio access technologies that have (and still are) shaping the evolution of mobile communication. For the first voice and text based services, Global System for Mobile Communications (GSM) was in the early 1990s the network layer to provide such services. Within a few years, in addition to the 900 MHz (Megahertz) band, GSM was quickly extended to the 1800 MHz band and other frequency bands worldwide, providing additional carriers for operators to support additional simultaneous voice traffic. GSM networks were later on equipped with a hook to send and receive information from the internet, through General Packet Radio Service (GPRS), later on enhanced to Enhanced Data Rates for GSM Evolution (EDGE), a pre-3G technology, supporting higher data rates through higher order modulation and coding schemes.

Universal Mobile Telecommunications System (UMTS), or 3G, standards were first released by 3GPP in 1999. Different from upgrades to an existing network, operators installed new equipment and in some areas new sites altogether. Coinciding with the peak of the technology bubble and surrounding hype, the first auctions in Europe resulted in operators paying dearly, especially in the United Kingdom and Germany, for a share of the spectrum in the 2100 MHz band. As the bubble burst, network operators ended up with new networks that were not exploited for what they were intended, that of connecting subscribers to the internet and other data-based services. With the eventual release of devices providing a better experience, the availability of more dedicated content, network upgrades enhancing data rates, and more accessible pricing, mobile broadband quickly grew to what it is today.

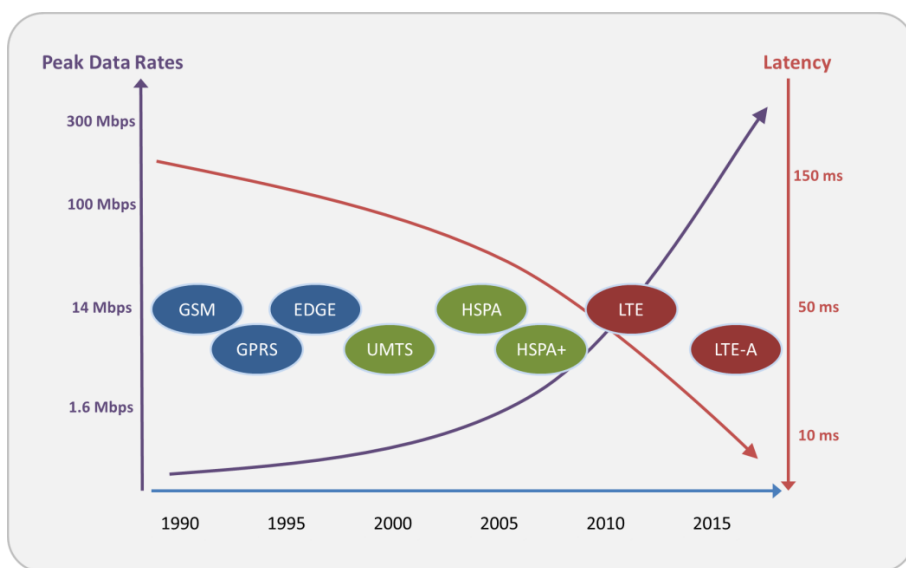

Figure 2.3 – Overview of how different radio access technologies have evolved. In addition to a timeline (highlights the periodicity of 10 years between the different generations), changes in peak data rates and latency are also highlighted. Figure adapted based on [46].

With High Speed Packet Access (HSPA) and HSPA+, mobile networks can provide real broadband services, with data rates comparable, if not exceeding, those provided by the traditional fixed Internet Service Providers (ISP). If employed with dual cell HSPA+ (DC-HSPA+) the downlink (DL) data rate of 21 Mbps is

effectively doubled to 42 Mbps [47]. In order to provide faster speeds and capacity, networks are being augmented further by Long Term Evolution (LTE)³, completed in 2009 as part of 3GPP Release-8 (Rel-8). LTE makes use of Orthogonal Frequency Division Multiple Access (OFDMA) in the downlink and Single-Carrier Frequency Division Multiple Access (SC-FDMA) in the uplink as multiple access schemes [48]. LTE provides the ability to select specific bandwidths options, ranging from 1.4 MHz to 20 MHz, to be (in Europe) allocated at 800, 1800, and 2600 MHz bands.

2.2.1 Evolution of Mobile Networks

In addition to managing multiple network layers, the availability of multiple site types, configurations, and technologies has presented MNOs with a variety of potential evolution paths. While essential to ensure user satisfaction and expectations, MNOs are required to select options that are within some cost boundaries, are energy efficient, and scalable enough for supporting and facilitating future upgrades and changes in strategy. For the rollout of 3G networks, the reuse of existing macro sites (2G) provided a first natural step for creating a coverage footprint. Since 3G operates at higher frequencies (greater path loss), more sites are required to provide the same level of coverage that 2G provides. In addition to this, further sites can also be deployed to boost capacity within specific traffic hotspots⁴. In scarcely populated regions, where little or no revenue is expected, the area is often weakly covered, providing intermittent, or no access to 3G. In the UK, 2G networks cover 97% of the territory, whereas 3G only covers 73% [49].

Coverage holes are areas within a network in which a reliable communication link between the mobile device and network cannot be established. One of the limiting parameters for this is the received signal strength, which, if below a specific threshold (based on particular receiver sensitivity), puts the specific device in an apparent coverage hole. In such areas, signal attenuation due to outdoor-to-indoor penetration worsens coverage further. Since deploying macro sites for connecting a few subscribers makes little business sense, MNOs are connecting remote subscribers through small sites (femtocells). These are small, low power devices,

³ Even though marketed as 4G, technically, LTE does not meet the International Telecommunications Union – Radio Communications Sector (ITU-R) requirements, regressing it to the sometimes referred term 3.9G [38].

⁴ New traffic hotspots can be generated with the construction of stadiums, shopping malls, and, industrial complex among others.

similar to a WLAN modem or wireless router that transmits and receives 3G signals, providing indoor coverage. These devices connect to the core network through a broadband connection, which acts as a backhaul towards the core network. Vodafone UK has in the past years deployed more than 100K of such femtocells [50].

In addition to deploying sites, MNOs have other options for staying ahead of the growing traffic demand. If spectrum is available, a simpler way to upgrade capacity for existing UMTS/HSPA sites is to deploy additional 5 MHz carriers. Based on the version of the installed equipment, and frequency band, the same hardware can be used to support additional carriers. Existing equipment can support bandwidths of up to 20 MHz, supporting up to 4 carriers [51]. Alternative methods include the deployment of additional sectors, or enhancing existing sectors with MIMO (Multiple Input Multiple Output). In the latter, a second transmission chain (transceiver) is added (spatial diversity), boosting channel capacity at higher SNR (signal-to-noise ratio) [52]. A growing technology expected to complement existing macro networks is Active Antenna Systems (AAS). AAS integrates a number of RF power amplifiers directly with the antenna dipoles, enabling signal phase and amplitude manipulation. This gives the flexibility of directing individual beams, improving the coverage and capacity of the site further [53].

In addition to deploying additional sites to extend coverage and upgrading existing sites to boost capacity, MNOs often have policies for periodically replacing site equipment [36]. In addition to upgrading the available feature set and capabilities, this also improves the energy efficiency of the site. If equipment is not replaced, capacity upgrades and the installation of additional equipment can only push the energy consumption of the network one way, upwards. Modern equipment is also more compact, thus providing the added advantage of saving site (rental) space.

2.2.2 Heterogeneous Networks

The term Heterogeneous Network (HetNet) refers to a network layout that consists of two or more cellular layers [54]. In recent years, this has been investigated as a potential alternative for upgrading existing and future cellular networks. Rather than deploying macro sites, heterogeneous networks enhance existing capabilities through the deployment of small overlapping cells. Since small cells provide and boost capacity within a relatively small area, these are suited for deployment in traffic hotspots, which are often small and concentrated in nature. Serving a portion

of the traffic through small cells automatically releases some of the resources from the overlaying macro site. These resources can be used to accommodate additional users, or redirected towards existing users that require further resources to achieve the sought experience.

The fact that small cells operate and transmit at low power reduces the amount of interference that these cause to neighboring sites and the macro layer. Alternatively, this can be avoided if different layers are assigned different frequencies. This depends on the availability of additional spectrum since its acquisition is often very expensive. In addition to different cell types on the traditional mobile communication access layers, HetNets may also include other wireless access technologies, mainly Wi-Fi, similarly exploited by MNOs to offload traffic from macro sites in traffic hotspot areas [55].

Small sites can either be deployed indoor or outdoor, with the selection being very specific to the area and infrastructure available for the operator. Outdoor sites have a higher transmission power and generally cover areas of up to a few 100 meters in diameter. As macro sites, small cells also require a backhaul connection to the core of the network (Figure 2.4), which can be provided via an xDSL connection or wirelessly. From a practical and financial aspect, providing these backhaul links could prove to be an Achilles heel. This is especially true for MNOs that do not own already own a fixed network infrastructure. This and similar aspects are discussed in further detail when described in the presented case studies.

For a specific case, statistics show that static/indoor users are responsible for 80% of the generated traffic [56] [57]. When traversing through walls, transmitted RF signals are weakened considerably (15dB-50dB) [58] [59]. A weaker received signal leads to selection of a lower modulation scheme, resulting in lower data rates and/or the utilization of additional network resources. The combination of poor signal strength and high traffic densities make indoor environments within mobile networks extremely challenging. MNOs attempt to mitigate this by ramping up macro base station transmission power to the maximum level possible.

The deployment of low power femtocells (indoor small sites) allows for a strong and reliable indoor radio link, improving the performance while also conserving battery power for the mobile device. The impact of indoor femtocells on the transmission and received power is illustrated in Figure 2.5. On the downside, whereas a single macro site can cover and serve users within several buildings, in

the case of femtocells, individual cells are required on a per room / floor basis, dramatically increasing the number of required network elements.

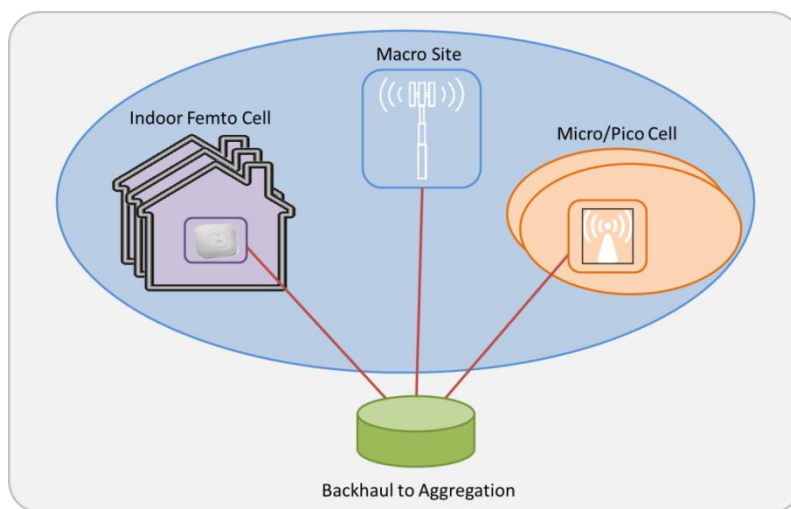

Figure 2.4 – Heterogeneous networks consist of an overlaying macro site, complemented with small cells (micro/pico/femto). All require a backhaul connection to an aggregation point.

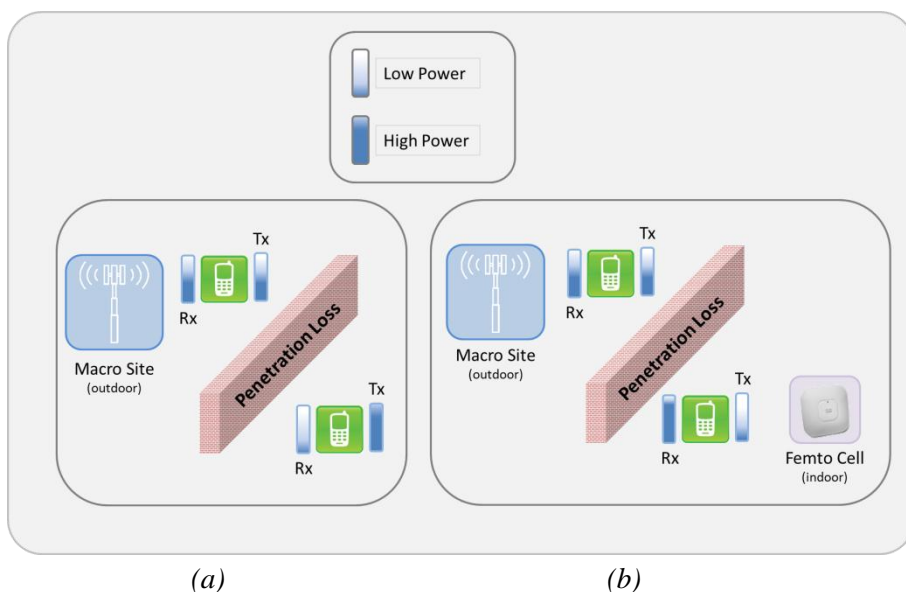

Figure 2.5 – As noted in the two sections of the figure, the installation of an indoor femtocell (b), allows for an improvement in received power and a reduction in terminal transmit power.

The use of femtocells for enterprise solutions, targeted at serving a relatively larger number of users, would still allow for network operators to plan and optimally deploy these cells. However, once the deployment moves towards the domestic domain, the random deployment of small cells makes the overall deployment more complex⁵. A similar situation can already be noted with Wi-Fi. Over the last years the uncoordinated deployment of Wi-Fi access points has, in some areas, created some very challenging wireless scenarios, with many access points competing for resources over the same channels. The advantages of femtocells over Wi-Fi include the ability to provide the same voice and data services, better device battery life, and more robust security [60].

When considering indoor based small cells, two main categories exist, Open and Closed Subscriber Group (OSG and CSG). The former refers to a small cell which anyone within its range can connect to and use as a gateway to access the core network of the operator. On the other hand, in a CSG configuration, only a restricted set of registered devices are allowed access through the small cell. In the already deployed coverage enhancing femtocells, this mode of operation has been the one most frequently adopted.

2.3 Cost and Business Considerations

In addition to providing what now is considered a crucial service, MNOs represent a business, with a priority of keeping shareholders and investors satisfied, by generating profits. The core business of MNOs has in the past mainly been centered on voice and text services, both flowing through internal billing systems and generating revenue. The mobile ecosystem has evolved with operators providing a gateway to the internet, and hence access to other services offered by third-parties. While required to support the network infrastructure for their subscribers, MNOs have slowly shifted to becoming more of a wireless bit-pipe [61], providing access to external non-billed services [62]. While MNOs also focus on providing tailored services for corporate entities, the ongoing trend of growing data traffic, and a reduction in cost per unit of consumed data, certainly presents a number of

⁵ Interference management becomes very important requiring for each small cell to monitor its surrounding and minimize interference to its surrounding.

challenges for MNOs, especially when required to heavily invest in network upgrades.

The ability to foresee how the industry will develop in the coming five to ten years could allow MNOs to better plan their network. With the availability of MIMO, LTE, Active Antenna Systems (AAS), Wi-Fi, and HetNets, MNOs are presented with different possible upgrade paths. In addition to providing the necessary added capacity to carry the expected traffic, MNOs are required to choose a path and strategy that is financially sound, and energy efficient. While a reduction in energy consumption automatically reduces energy related costs, the process of upgrading a network to minimize consumption and carbon emissions might outweigh the gains from energy cost savings.

The three distinct network upgrade strategies described earlier, set to provide comparable performance, are primarily investigated and compared from an energy consumption perspective. In addition to this, the possible cost and/or practical implications of different strategies are also in various areas briefly highlighted. Rather than presenting detailed cost figures, the analyses presented in this thesis point out some of the key issues that could limit the short or long term financial viability of a specific network upgrade strategy. When considering costs, the three cost factors that determine the Total Cost of Ownership (TCO) are:

- CAPEX - Capital Expenditure – Cost incurred for purchasing new/additional site equipment. This includes: antennas, masts, RF units, power supplies, feeder cables, etc.
- IMPEX – Implementation Expenditure – A one-time expense required for carrying out the specific upgrades. These costs cover: civil works, site acquisition, structural modifications, site/equipment installation, etc.
- OPEX – Operational Expenditure – Includes a variety of running expenses for each site, including: site rental, backhaul, energy, site maintenance, etc.
- TCO – Is a financial estimate that helps determine the economic value of an investment. $TCO = CAPEX + IMPEX + OPEX$.

2.3.1 Trends in the Cost of Energy

While the topic of energy saving and green radio is often publicized as a good deed towards the environment, the most important driver is likely to still remain a purely business one. The price of energy has been increasing regularly, thus increasing the

yearly expenditure for MNOs. Within the 27 EU member states, the average industrial electricity cost has in the last three years increased, year-on-year (YoY), by almost 8.5% [13], with some countries such as Latvia registering an increase of more than 26% [13]. Given the finite nature of non-renewable resources, growing demands from developing countries, and the instability in oil producing regions, the price of energy can only be expected to keep on increasing.

3. Base Station Site Modeling

3.1 Mobile Network Overview

Mobile networks can be split into two major logical entities. The first, core network, is responsible for functionalities that include authentication, billing, Intelligent Network (IN) logic, routing, and data aggregation. Gateways at the core network are responsible for providing and monitoring a number of interfaces with other networks, both internal and external, and the open internet. The second entity is the radio access network (RAN). This provides a subscriber, or device, the ability to access services offered by the network. In mobile networks, this is provided through mobile base station sites, which are connected to the core via an underlying transport network.

Away from the core, the number of network devices increases exponentially. In order to provide coverage, Vodafone UK currently has more than 13,600 base station sites dotted across the nation [63]. Figure 3.1 provides a rough estimate on the global scale and power consumption of the different network elements.

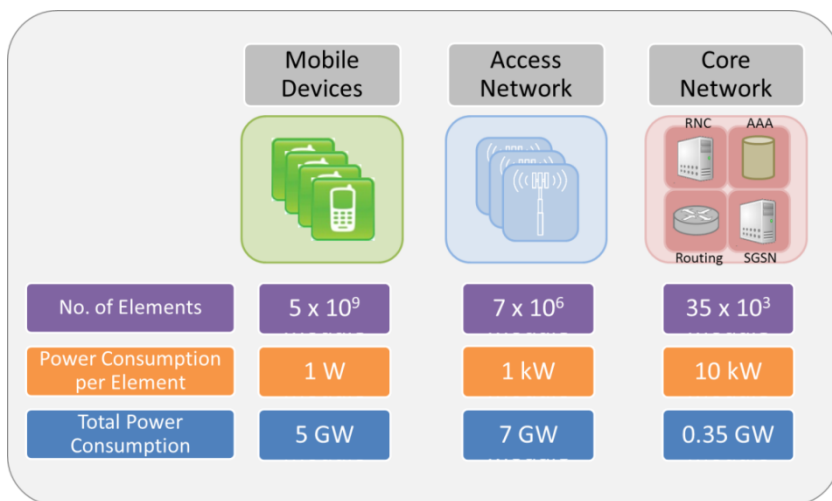

Figure 3.1 –Indicative values that point out the scale by which different network elements are globally deployed, highlighting also the power consumption on a per element basis [64].

Even though a single core element can consume 10kW of power [65], base station sites are responsible for 60-80% [66] [67] [68] of the overall power consumption. In addition to being deployed in large numbers, base station sites also consume considerable amount of power, making them the prime focus of many studies aimed at reducing the power consumption of mobile networks.

3.2 Base Station Site Architecture

Mobile base station sites provide mobile devices access to the network. In an urban setting the location of such sites is often identified by antennas protruding from rooftops. The actual communications and support equipment is often located a short distance away from the antenna, either indoors, or outdoors, enclosed within a cabinet. Depending on the equipment vendor, configuration, and age of the equipment, base station sites can vary in shape, size, and composition. Nonetheless, each base station site has a number of common key components that include, antennas to transmit and receive radio signals, radio base station (RBS) equipment to interfaces with mobile devices and other network elements, and a power supply unit to convert AC power lines and distribute the necessary supplies to the site equipment [69]. Figure 3.2 presents a generic base station site model.

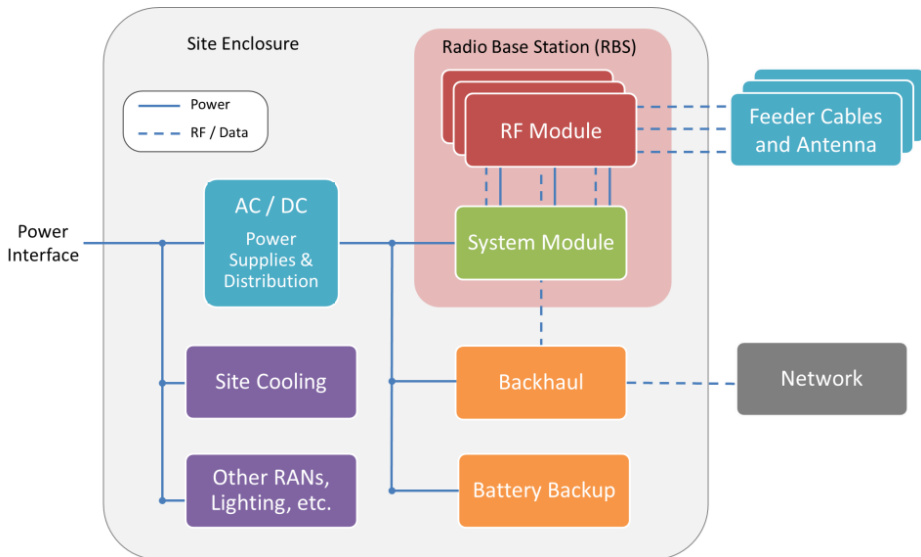

Figure 3.2 – Based on the reference model presented by ETSI [69], this base station site model highlights some of the key components, with the power models primarily focusing on the RBS.

Additional equipment may be located within base station sites to provide supplementary functionalities such as climate control, monitoring, security, and backup. Even if not critical to the main function, all components contribute to the overall power consumption of the site. Each equipment vendor attributes a specific name to the different components making up a radio base station. Since the power models are mainly based around these components, it is important to note that the naming terminology used throughout this thesis is based on that presented by Nokia Siemens Networks (NSN) in its Flexi Base Station family of products¹.

3.2.1 RF Module

RF modules handle the RF functionalities at the site. Depending on the type, a single module can support from one up to three sectors, with a dedicated transceiver chain assigned for each sector. The power consumption of the radio equipment and linear power amplifiers can make up for about 60% of the power consumption of a base station site [33]. The efficiency of power amplifiers (PAs), the evolution of which is presented in Figure 3.3, is based and affected by various criteria, including, frequency, bandwidth, modulation scheme, and operational environment [65].

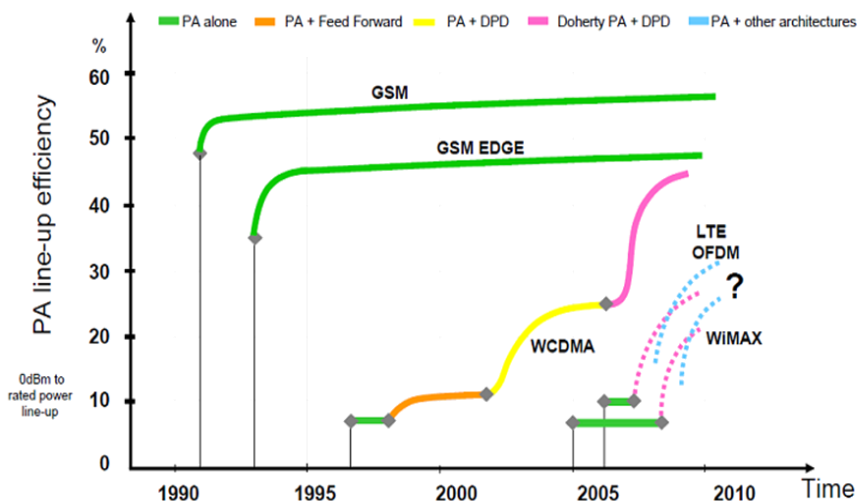

Figure 3.3 – Evolution for the efficiency of power amplifiers for different mobile radio access technologies. Figure extracted from [64].

¹ The RF Module and System Module follow the terminology used by NSN. Similar units are by other equipment vendors referred to as Radio Unit, and Digital/Baseband Unit respectively.

In order to meet linearity² requirements [70], PAs are operated away from the saturation region, where maximum efficiency can be achieved [71]. This means that linearization methods can help improve the performance of non-linear yet more efficient power amplifiers. Linearization methods include, Cartesian feedback, feed-forward, and digital pre-distortion (DPD) [65] [64]. As a result, current PAs operate at efficiency values that are around 40% to 50%.

3.2.2 System Module

In addition to providing the main baseband processing and control functionalities of the site, the system module provides the necessary interface to the RF module, and if necessary additional system modules that can be used to extend capacity. In addition to providing an interface to trigger and control external equipment, the system module also generates a system reference clock, which can be used as a source to synchronize base station site equipment. Given the assumed equipment, the system module is also responsible for distributing power to the RF and other system modules. The physical Iub interface to the Radio Network Controller (RNC), and subsequently the core of the network, is provided via a dedicated transmission sub-module.

The capacity of a system module can be described by the data rate that it supports. While a variety of system modules have different capabilities and capacities, the default module used for all assumed macro sites is one that can handle a downlink data rate of 504 Mbps and 450 Mbps for HSPA and LTE respectively. When it comes to the power consumption, advances in CMOS technology (Moore's Law) and the continuous integration of components within a single chip (SoC - System on Chip) have brought considerable reductions in the power consumption. These reductions are however limited by an increase in the processing requirements for supporting more complex features and site optimization and coordination techniques.

3.2.3 Feeder Cables and Antenna

Feeder cables connect the transmitter and receiver of the RF module with the respective ports at the antenna. As the RF signal travels from one end of the cable to

² The need for linearity increases with bandwidth and modulation scheme making it a more stringent requirement for HSPA and LTE.

the other, it weakens, the extent of which depends on the transmission frequency and cable length. This attenuation in signal strength is attributed to dielectric losses and skin-effect [72]. While the length of required feeder cable is specific to the site structure and location, a loss of 3 dB (50%) is often assumed [66] [73]. For such an assumption, only half of the output power at the RF module actually reaches and is transmitted by the antenna. Depending on the configuration and antenna, this and possibly further losses can be attributed to the different connections between the RF module and antenna, including antenna filters, combiners and splitters.

3.2.3.1 Remote Radio Head (RRH)

Losses attributed to long feeder cables can be mitigated by deploying Remote Radio Head (RRH). Performing the same functionalities, RRH can be considered as a variant of the already described RF modules. While different configurations exist, these are often noted as single sector modules deployed on the same pole beneath the antenna. This allows for the distance between the RF interface of the base station and that of the antenna to be reduced to a minimum (Figure 3.4).

In addition to extending the necessary power lines, an optical connection to the system module ensures that data can be transferred between the two components. While RRH reduces the need for long feeder cables [27], losses can still be expected due to imperfections in the connectors, and the use of jumper cables. While the use of RRH is already relatively popular, it is an increase in transmitted power at the antenna the main motive pushing it forward, and not a reduction in power consumption.

3.2.3.2 Distributed Base Station Sites

Similar in concept but extended further, is the idea of distributed base station sites. In this case, a centralized stack of system modules provide a common pool of capacity that can be shared among a number of neighboring sites [44]. Optical links provide a digital connection between the system modules and the RF module or RRH at the site. By exploiting the fact that neighboring sites can experience traffic over different periods of time, this reduces the overall installed capacity while improving its utilization. Having centralized information from multiple sites also provides further opportunity for network optimization features [44].

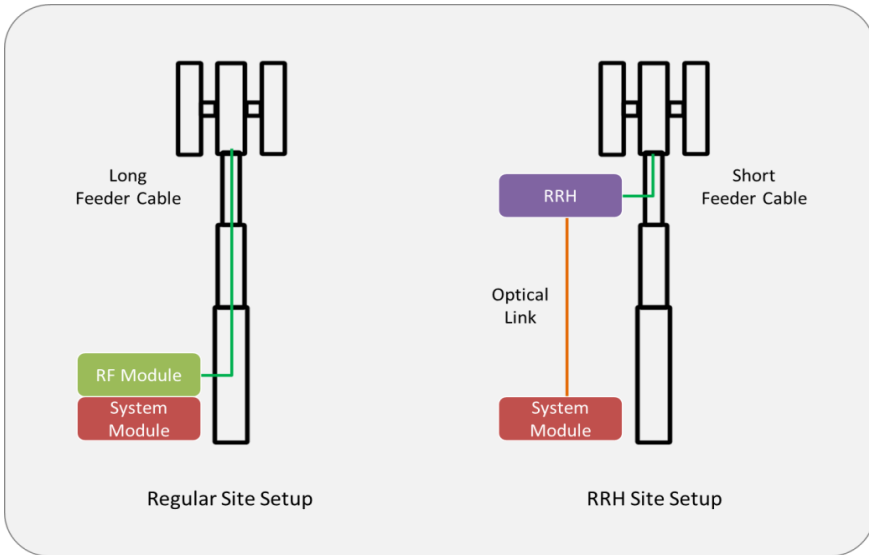

Figure 3.4 – Remote Radio Head (RRH) reduces the need for lengthy feeder cables, limiting the losses attributed to this. To note a regular three sector site, requires three single sector RRHs are.

3.2.4 Site Cooling

A portion of the power at base station sites is transformed and released as heat. Depending on the location and season, this may result in the temperature within the cabinet to increase beyond the specified operational parameters of the equipment. For this reason base station sites are often equipped with site cooling, which controls and maintains the cabinet temperature, or a compartmentalized section (like batteries), within a specific temperature range. Site cooling is still often stated as being responsible for 25-30% of the overall power consumption in base station sites [33] [27]. High power consumption values for cooling imply the use of active cooling³ (air conditioning), which in addition to the power also requires considerable site space. Since modern equipment can operate over a wider range of temperatures (-35°C to +55°C) [51] [74], the use of active cooling should only be considered in cases of legacy equipment and/or the extreme case of a site located within a harsh environment. In cases with modern site equipment, temperature can be maintained and controlled through passive means, such as convection cooling (e.g. heat sinks), or low powered means with the use of internal fans.

³ Depending on the location and season, some parts of the equipment might in some cases also require heating.

3.2.5 Backhaul

Each base station site requires a stable high capacity connection, to the network. This connection is often referred to as backhaul, and the means by which it is established, and hence required equipment, depends greatly on the location of the site, and infrastructure owned by the operator. The three main categories and options for providing backhaul are, copper, point-to-point microwave, and fiber optics, with Figure 3.5 showing how these are divided on a global basis. As more access technologies are added to the site, the capacity on the backhaul link needs to also be increased, with the latter two options providing the best solution in terms of capacity and reduced delay [75].

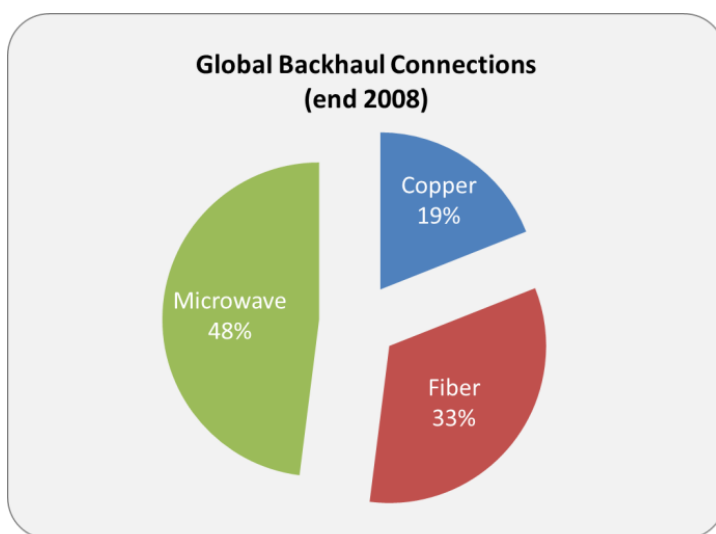

Figure 3.5 – Ratio of how backhaul connections are divided (2008), showing microwave as the major option, with fiber becoming increasingly popular over shorter distances [76].

3.2.6 Battery Backup

A disruption in service for a few minutes is enough to create a shockwave of complaints over all forms of media. In order to protect against unforeseen power cuts, mobile network operators (MNOs) equip base station sites with a battery backup. In the case of a fault in the main power supply, this backup automatically kicks in, maintaining the full operation of the site for a few hours. In service sensitive areas or in regions where the national grid is unreliable, diesel generators and a supply of fuel might also put on standby.

3.3 Macro Site Power Model

In order to limit the impact of different site types and layouts, power models are primarily focused on the RBS part of the base station site, and also include parameters that have a considerable impact when assuming the replacement of old equipment. More specifically, the power model is based on:

- RF Module
- System Module
- Feeder Cable Loss and RRH
- Site Cooling

At this point, it is important to set the terminology that is used within the thesis. In many of the cases, analyses are based on a fully loaded network at busy hour. For these cases consumption of the network is measured and referred to in terms of power. When considering energy saving features, most are carried out over a 24 hour period of time, and are hence described in terms of energy consumption.

3.3.1 Fixed vs. Load Dependent Power

When considering the individual components within the RF and system module, the power consumption of each component is likely to have a fixed and load dependent factor. The former represents the power consumption that is required by the equipment to power itself and maintain an idle state (no load condition). As mobile devices start to populate the site, the added transceiver and processing functionalities, increases the power consumption in proportion with the load. As highlighted in Figure 3.6, in an ideal case, an inactive site that is not transmitting, not even on the broadcast channels, should not consume any power. Since this is not the case, the higher the ratio between fixed power and load dependent power, the less efficient the site is, especially for low load values.

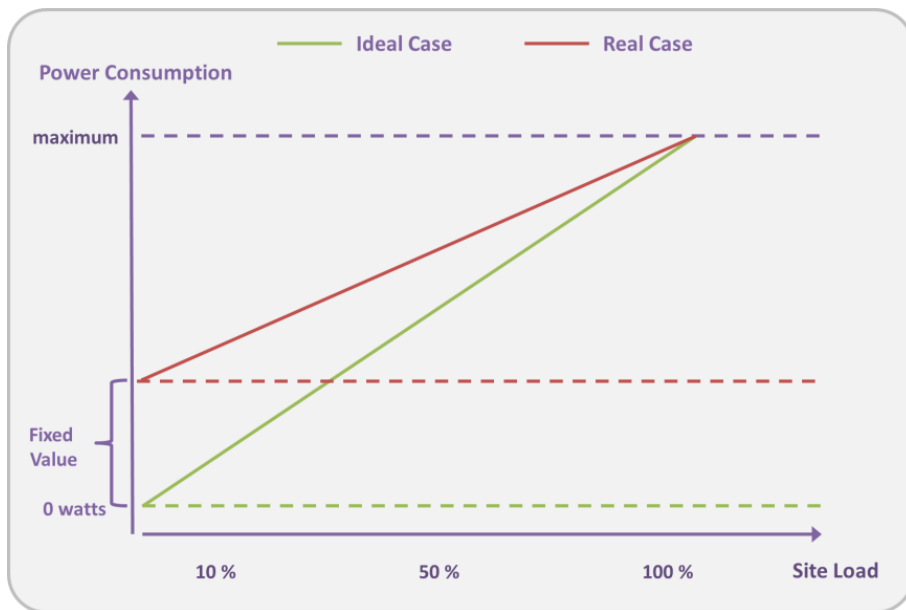

Figure 3.6 – Comparison between an ideal case, in which consumption ramps up with the load, and a more realistic case with power consumption at no load.

3.3.2 Power Consumption Model

In order to estimate the power consumption of different base station sites, a base station site power model (3.1), based on 2008 (WCDMA/HSPA) equipment, is developed and tuned in collaboration with NSN hardware and equipment experts [37] [34]. A similar model, tuned differently, is adopted in related studies, mainly in [77] and [67].

$$P_{BTS} = [n * P_p] + [m * (P_{TRX} + k * P_{RF}/C)] \quad (3.1)$$

The first part of the equation represents the power consumption attributed to the system module. Since the power consumption of the system module is only lightly associated with the configuration and load of the site, its power consumption is modeled, on a per site basis, as a fixed value. Supporting a modular structure with additional system modules, the term n indicates the number of installed modules while P_p represents the power consumption assumed for each module. While in all cases involving macro sites a common system module is assumed, a different

module is adopted for outdoor small cells. For the former, the system module, capable of handling 504 Mbps and 450 Mbps of HSPA and LTE downlink traffic respectively, is assumed to 110 watts⁴.

In the second section of (3.1), the term m represents the number of active transceivers. The term P_{TRX} stands for the fixed power consumption associated to each transceiver. Coupled with the term m , this allows for the power of different RF modules that support fewer or more transceivers (up to three transceivers [51]) to also be calculated. For each transceiver, a fixed power consumption (P_{TRX}) value of 100 watts is assigned [37]. The term k represents the average load of the entire site. This can be assumed to range from 10% to 100%, with the lower end of the scale defined by the need to support the broadcast channel [78] [79]. On the other hand, a load of 100% represents all of the site transceivers continuously transmitting at maximum power. The set transmission power is included in the model through the term P_{RF} , with HSDPA sites assuming a typical transmission power of 20 watts (43 dBm) [80].

The final term c , adds the impact of equipment inefficiencies and losses from converting signals to the RF domain. While the low efficiency of the PAs play a role, this is not a direct measure of PA efficiency and takes a more generic (tuning) role. Through discussions [37] a value of 0.35 is selected. This is based on the fact that this provides power consumption values that compare fairly well with those previously achieved through direct equipment measurements. Based on these assumptions, a three sector site operating on a single 5 MHz carrier, at full load, and a transmission power of 20 watts per sector, the power model yields the following consumption:

$$P_{BTS} = 1*110 + 3*(100 + 1*20/0.35) = 581W \quad (3.2)$$

Assuming that all of the 20 watts reaches the antennas, the above power model shows that the efficiency of the assumed site rates at just over 10%. In reality, if other elements such as, passive/active cooling, battery backup and feeder cables are considered, the power efficiency of the site drops further. This inefficiency together

⁴ To note that throughout this thesis the dimensioning of the system module is not tackled. While necessary to get a more accurate picture, the relatively difference in power consumption are believed to have a minor impact on the overall investigated trends.

with the fact that a large number of base station sites are required makes them the primary target for reducing the power consumption of mobile networks.

For the case of upgrading to multiple 5 MHz carriers, this can be carried out in different ways. While one option is that of adding a second RF module, the fact that existing modules can support up to four carriers [51], it is assumed that these upgrades are carried out within the existing module. To note however that the total transmit power over the four carriers cannot exceed the maximum supported by the transceiver, currently at 60 watts [51]. Since modern power amplifiers allow for a variable bias, operating more efficiently over different transmission powers, the model is adjusted to include the number of carriers within the transmission power term P_{RF} . By taking this assumption, a two carrier site requires 2x20 watts of output power, giving a site power consumption⁵ of 753 watts.

3.3.3 Feeder Cable and Site Cooling

Since some studies also include the impact of RRH and losses due to feeder cables, the previous model is extended (3.3) to also include, when necessary, this factor.

$$P_{BTS} = f_{Cool} * ([n * P_P] + [m * (P_{TRX} + k * P_{TX}/C)]) \quad (3.3)$$

where,

$$P_{TX} = P_{Ant} + L_{Feed} \quad (3.4)$$

The term P_{RF} previously used in (3.1) is replaced by P_{TX} . Transceivers can be biased to operate efficiently at different power levels, going anywhere from a minimum up to 60 watts. While this is the power at the output port of the RF module, signal attenuation due to feeder cables and connections reduces the power that is actually transmitted at the antenna. In order to achieve a specific transmit power at the antenna, the output power has to be increased (3.4) to counteract for these losses (L_{Feed}). When considering feeder cable loss, an attenuation of 3 dB is assumed [66] [73]. For cases that consider RRH, this loss is assumed to being reduced to 1 dB. Since it is assumed that a fixed transmission power at the antenna is required, a

⁵ For this case, the same system module is assumed.

reduction in the losses prior to transmission allows for a lower output power⁶. Figure 3.7 shows how a reduction in feeder cable losses (L_{Feed}) reduces the output power required at the RF module, and hence, the resulting power consumption of the base station site.

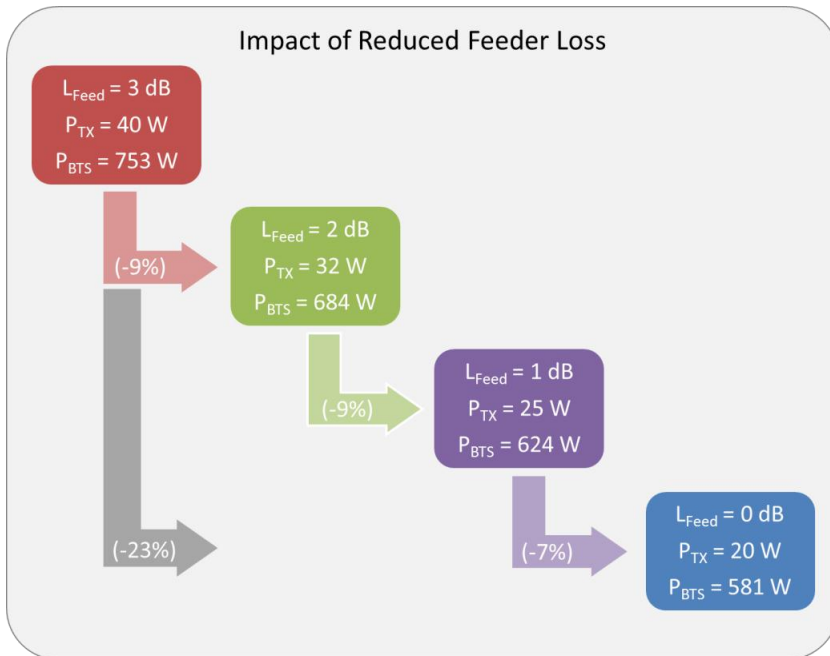

Figure 3.7 - Impact on the power consumption for reduced feeder loss. The same power at the antenna is required, each time adjusting the output power to overcome the assumed feeder losses.

The extended model in (3.3) also includes a factor for site cooling, f_{Cool} . Since assumed applicable for old equipment versions, site cooling is only added when dealing with the replacement of base station equipment (Section 5.6), and is modeled by adding 30% to the power consumption of the site. A lower or higher value can be argued for based on the location, season, and configuration of the site. In order to gauge the impact of a combined feeder cable loss of 3 dB and a site cooling factor of 30%, the power consumption of the site presented in (3.2) increases by 68.5% to 979 watts (3.6). This brings the power efficiency of the site further down to a tad above 6%.

⁶ In some cases, MNOs look at a reduction in losses as an opportunity to achieve a higher transmission power from the antenna.

Considering the two extreme cases presented in Figure 3.7 it can be noted that a reduction in transmission power by a factor of 50%, reduces the power consumption by no more than 23%. This is due to the fact that this reduction is not having any impact on the remaining components of the site, which are independent from the transmission power at the RF module.

$$P_{TX} = 43 \text{ dBm} + 3 \text{ dB} = 46 \text{ dBm} (40 \text{ W}) \quad (3.5)$$

$$P_{BTS} = 1.3*(1*110 + 3*(100 + 1*40/0.35)) = 979 \text{ W} \quad (3.6)$$

3.3.4 Power Consumption with Load

When assuming a varying load, the power model portrays an unfortunate, yet typical characteristic of base station sites. More specifically, this is the low correlation between power consumption and load [79]. Even when running at full load, Figure 3.8 shows that about 70% of the power consumption comes from load independent sources. Put in another way, even when the load of the site is zero, the power consumption of the site drops by no more than 30%. With a power efficiency of about 10% at full load, running base station sites at lower loads reduces their energy efficiency even further.

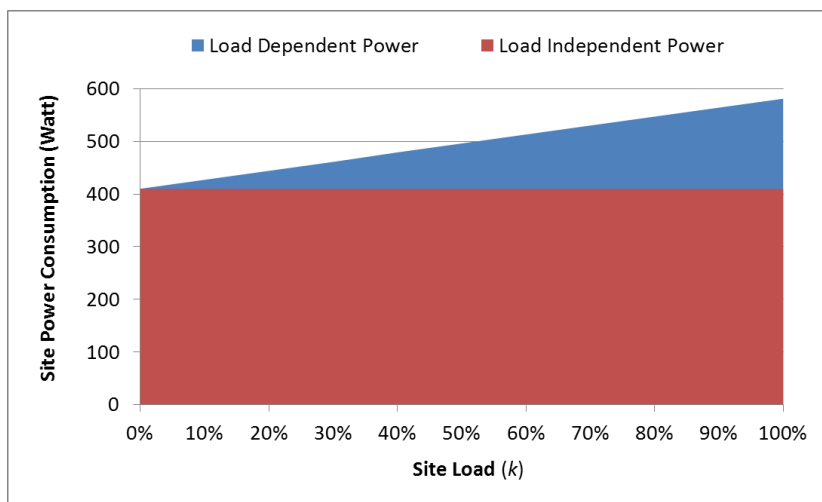

Figure 3.8 – Variation in power consumption of a base station site with load. At its most efficient case ($k = 100\%$) the fixed portion makes up 70% of the total power consumption.

This relation between power consumption and load highlights the need to focus on power saving features that actually tackle the load independent power. Since results presented in this thesis are used to provide recommendations to MNOs, it is the power consumption of the site, as seen by the operators, which is considered, and not the power transmitted at the antenna.

3.3.5 Site Upgrades with MIMO

For one network evolution instances, the capacity of an existing HSDPA network is expanded further by upgrading existing sites to MIMO. Through the addition of a second transmitting antenna (spatial multiplexing), MIMO increases the spectral efficiency and hence capacity of the network (without the use of any additional spectrum). Commercial deployments of MIMO have shown that on average, cell throughput can be improved by around 20%, when compared to a regular single transmission antenna solution [52].

As demonstrated in Figure 3.9, the implementation of MIMO requires a second RF module. In addition to using no further spectrum, it is assumed that the overall transmission power of the site also remains constant. This can be noted in the figure with a single 20 watts transmission, for the single transmission antenna case, being divided into two 10 watts transmission chains.

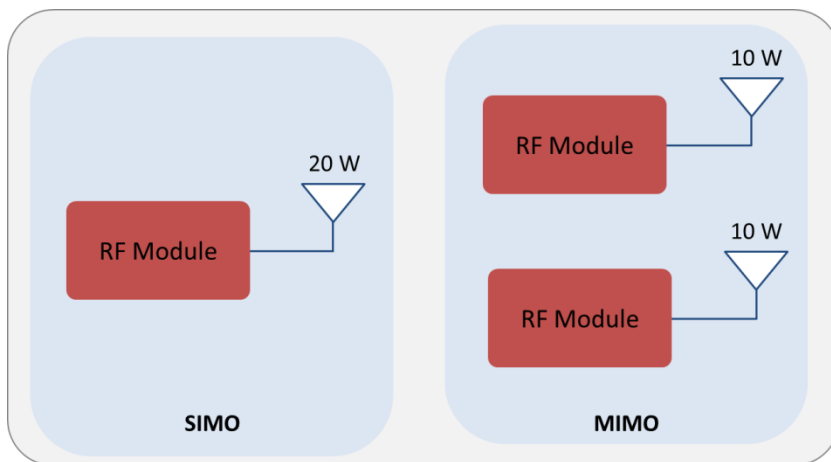

Figure 3.9 – Even though the upgrade to MIMO requires a second transceiver chain (RF Module), it can be noted that the overall transmission power per site remains the same, with the power being equally divided among the two transmission branches.

When considering the power consumption of such a site configuration, the presented model (3.1) is appropriately regulated by reducing the assumed transmission power to the half while. For the default three sector sites with a transmission power of 20 watts per sector, the implementation of MIMO increases the power consumption of the site from 581 watts to 882 watts, an increase of almost 52% (Figure 3.10).

3.3.6 Network Capacity Upgrades with LTE

In addition to also adopting a 2x2 MIMO antenna configuration, LTE is also implemented over a wider (variable) bandwidth providing considerable gains in network capacity and peak data rates. Network evolution studies that consider the upgrade of existing networks to an LTE infrastructure, assume that equipment for the latter are co-located within existing sites. Even though modern equipment provides the added flexibility of supporting multiple standards [51], the impact of this is not considered within this thesis. Given the operating frequencies of RF modules, this can be expected to play a more meaningful role when refarming of existing frequency bands, mainly 900 MHz and 1800 MHz, start taking place [81].

For all cases considering LTE, all macro sites are assumed transmitting with a total power of 40 watts (46 dBm) per sector. This holds for LTE sites supporting operation on both considered bands (800 MHz and 2600 MHz) and bandwidths (with 10 MHz and 20 MHz the two main cases considered). With the implementation of 2x2 MIMO, this power is equally split between the two branches. Assuming the same power model presented for MIMO would give an overall increase in power consumption, compared to a regular 43dBm site, of about 80%. However, based on equipment measurements and discussions with NSN hardware experts [38], an increase in power consumption of 70% is adopted for sites with LTE⁷. This means that a regular three sector LTE site with a transmission power of 40 watts (46 dBm) consumes a total power of 988 watts. An overview of how this compares with other configurations is illustrated in Figure 3.10. The increase in equipment and power consumption puts into perspective the repercussions of going to even higher order (4x4 and 8x8) MIMO schemes. While co-located sites are assumed to have a dedicated system module for both HSPA and

⁷ While having an impact on the overall power consumption, the effect of different bandwidths for LTE is not included considered.

LTE, cases supporting LTE onto multiple bands (800/2600 MHz) two system modules are considered for providing the added capacity.

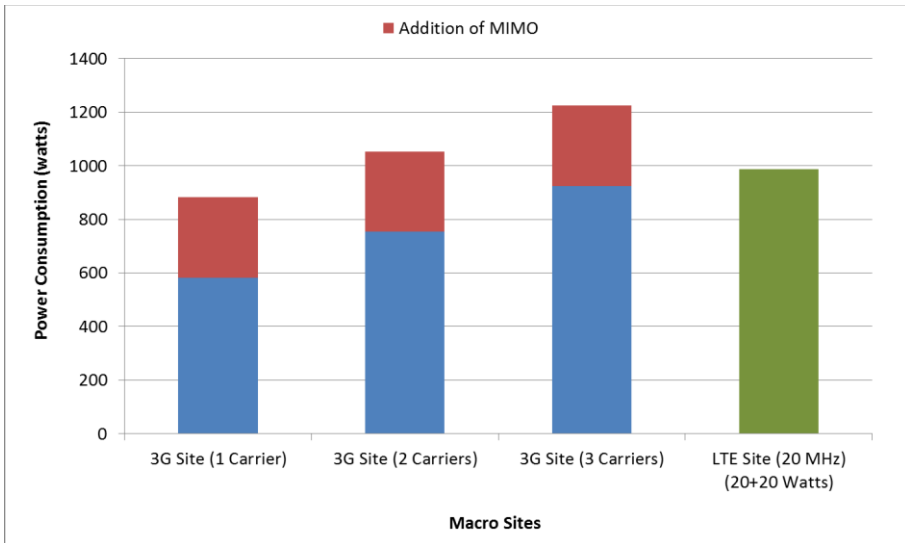

Figure 3.10 – Comparison for the power consumption of different macro site configurations, each assuming a maximum transmission power of 20 watts per carrier. To note how for the 3G sites, the upgrade to an additional carrier consumes less power than the upgrade to MIMO.

3.4 Small Cell Power Model

Since network evolution analyses consider the deployment of outdoor and/or indoor small cells, a power model is required. While often labeled as consuming low power [82], small cells are envisioned as being deployed in considerably large numbers, potentially covering and providing the necessary capacity for specific network areas. Based on the individual power consumption of each small cell, this can make a specific network evolution path more or less desirable from a power consumption perspective.

3.4.1 Outdoor Small Cells

Base station sites are categorized based on the output power. While literature may distinguish between microcells and picocells, outdoor small cells are within this

work referred to as picocells⁸, or small cells. With macro sites set to an output power ranging from 20 to 60 watts, small cells are often assumed with single digit transmit power values (watts). A low transmission power allows for small cells to focus available capacity over a smaller spatial area, offloading traffic from the overlying macro site while minimizing interference.

When it comes to the necessary equipment to setup a picocell, this is very similar that that of a regular macro site, more specifically a single sector macro site. Since the deployment of picocells is foreseen at lower heights, exploiting among others existing infrastructure such as lampposts, the configuration and location of equipment may be very case specific. Through the assumed case studies, picocells are required to transmit, from the antenna, a power of 1 watt (30 dBm), with an antenna (omnidirectional) that is located at a height of 5 meters.

The power model for macro sites (3.1) is utilized and adapted to also model the power consumption of picocells. This is based on the assumption that the same components are used, but are scaled down in power and limited to a single radio transceiver. With regard to the system module outdoor small cells are assumed equipped with a smaller version, capable of handling 252 Mbps and 221 Mbps of HSPA and LTE downlink traffic respectively. This is assumed to consume 73 watts of power, 27% less than the module assumed for the macro sites. This results in picocells consuming 176 watts of power (3.7), resulting in a relatively poor overall power efficiency. Following this assumption, the power consumption assumed for the system module takes a more dominant role, representing around 41% of the overall power consumption of the site (as opposed to the 19% of the macro case). The increase in dominance of baseband processing⁹, especially for small cells, is also pointed out and briefly discussed by Luis M. Correia et al. in [83].

$$P_{BTS} = 1*73 + 1*(100 + 1*1/0.35) = 176 W \quad (3.7)$$

At a glance, a power consumption of 176 watts for picocells can be considered as rather pessimistic, however within literature, power consumption values for similar

⁸ The term picocell is used when considering a heterogeneous scenario that may include other (indoor) small cells.

⁹ Transmission techniques for improving the spectral efficiency require more complex computational requirements, hence pushing up processing requirements [72].

cells are noted to vary across the board. For instance, [84] models an HSPA picocell transmitting at 2 watts (33 dBm) to consume 376 watts. With picocells envisioned to play an increasingly important role within heterogeneous networks, power consumption is bound to fall. For this reason, in many of the case studies carried out, a sensitivity analysis is added. This includes the potential impact that an improvement in picocell power consumption can have on the presented results.

3.4.2 Indoor Small Cells

The attenuation of signals transitioning from an outdoor to an indoor environment makes the coverage of indoor regions problematic. Weak signal strengths increase the load on the serving macro site, and may in some extreme cases bar access to the network. Rather than increasing the transmission power of macro site, indoor small cells concentrate capacity and provide a strong and stable signal at a fraction of the power.

When considering indoor small cells, more specifically femtocells to extend current RATs (3G/LTE), and Wi-Fi Access Points (APs), a fixed power consumption model is adopted. Since in comparison to the power consumption of macro sites, the consumption of such small cells is low, variations with load have a minimal impact on the consumption of the network. Based on datasheets from a Wi-Fi equipment vendor [85], Wi-Fi APs are assumed to consume 13 watts of power. Through similar datasheets, a 3G enterprise femtocell with a transmission power of 0.25 watts (24 dBm) is stated to consume 7 watts [86]. Since in the case studies femtocells are assumed with a transmission power of 0.1 watts (20 dBm) applying the same power efficiency results in a power consumption of 4 watts. For an equivalent LTE femtocell, the same factor (3G to LTE) of 1.7 is applied. This low power in relation to other site types is likely to also reflect having simpler equipment with limited functionalities, and further integration of the various components. Figure 3.11 gives a graphical representation of how the power consumption for outdoor and indoor small cells varies.

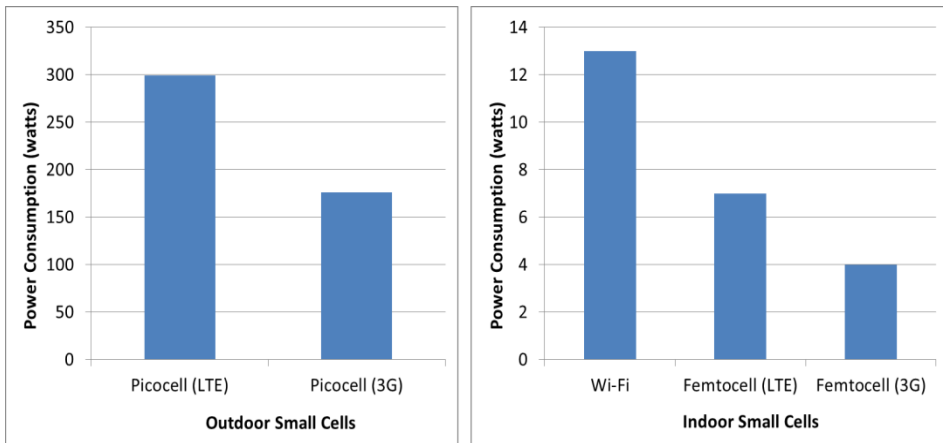

Figure 3.11 – Overview for the power consumption of small cells. The assumed fixed values are based on datasheets [85] [86], and where necessary adapted to match assumed values of transmission power.

3.5 Network Power and Efficiency

The main objective of this thesis is to determine the power/energy consumption trend of mobile broadband networks. Based on case studies, considered network areas are composed of a number of macro base station sites, each individually configured and supporting one, or more, RATs. Power analyses add the consumption of each site, taking into account the different site types and configurations. Carried out during the busy hour, with the assumption of all sites running at full load and comparable performance levels, this provides a common playing field over which different topologies and evolution strategies can be compared. While possible to investigate on the impact of varying load, this would heavily increase simulation complexity (NP-hard problem), since the variable load of a single site would have an impact on its neighboring sites. Since the main objective of this thesis is to determine trends and distinguish between specific upgrade strategies, this aspect has not been included.

Different studies have defined different ways of expressing the power or energy consumption of a network. For instance in [67], additional indicators, mainly area spectral efficiency and area power consumption, are introduced for measuring energy efficiency. Others, [77] [87], have included network capacity to derive a unit for measuring and comparing the efficiency of different architectures. These and

others measurement variances have been collected and described within a white paper [24] that summarizes the current state-of-the-art in measuring and making sense of power and energy consumption/efficiency for base station equipment. This document [24] justifies the selected method of measuring and comparing different evolution paths based on cumulative power consumption of the network area. Since the main network performance indicator, common to all studies, is percentage of users in outage¹⁰, additional information such as average network data rate is used to differentiate between cases that compare similarly for outage and power consumption. In these cases, combining network data rate and power consumption leads to a new term presented in (3.8). Rearranging the terms, this gives the energy efficiency of the network, or rather the amount of energy, in joules, that is required to transmit a unit volume of data. Lower values indicate an improvement in efficiency.

$$\text{Power / Data Rate} = [\text{Watt} / (\text{bit} / \text{sec})] \quad (3.8)$$

$$[\text{Watt} * \text{sec} / \text{bit}] = [\text{Joule} / \text{bit}] = \text{Energy per bit} \quad (3.9)$$

3.6 Improvements in Base Station Equipment

Various developments in technology (processing power, hardware design, and manufacturing) have allowed for equipment vendors to considerably improve base station site equipment. In addition to enhancing basic functionalities, and providing a wider array of features and flexibility, various advancements (and requirements) have also allowed for the power consumption of base station equipment to drop¹¹. The advantage of hardware based improvements in power consumption is that the savings (which can be more easily estimated) can be achieved throughout the lifetime of the equipment with no necessary modifications or impact to the network. On the downside, this requires for the equipment to be physically replaced, a costly process which can often take a long period of time to implement.

¹⁰ Requiring a predefined target data rate, a user is said to be in outage if the serving site is unable to provide a data rate that is equal or greater than the set target.

¹¹ A drop in consumption also means that the equipment is more efficient, requiring less power to deliver the same overall transmitted power and throughput.

Since the launch of UMTS, network equipment has undergone through a number of iterations (Figure 3.12), each time including new and improved features. Every couple of years a new major release of base station equipment occurs, with improvements in power consumption often headlined among key features [51]. Within the study it is assumed that up until 2013, four major equipment versions have been released¹². When considering the impact of these improvements, an equipment version factor (Table 3.1) is added to the power model presented earlier. Where available, these factors are determined through equipment measurements for specific configurations. Once again, given the large number of possible configurations, these factors provide some degree of comparison between different equipment versions. For the case of the first equipment version considered (released in the year 2000), a power factor of 200% is assumed based on internal discussions [34]. This is due to the fact that these sites have a very different architecture making available measurements tricky to directly compare with those of more modern sites.

Table 3.1 – Factors assumed when considering different versions of base station equipment. Based on the assumed release year, these factors are added to the power models presented earlier within the chapter, models which are based around the 2008 version of the equipment.

	Reference Model						
Equipment Release Year	2000	2006	2008	2013	2016	2020	2025
Factor Added to Power Model	200%	155%	100%	80%	58%	38%	23%

Based on the assumed values, the improvements in power consumption from the first equipment version in 2000 up until the most recent release in 2013, amounts to around 60%, giving an average annual improvement of about 7%. In addition to these four ‘known’ versions (solid bars in Figure 3.12) a number of improvements already in the pipeline are expected to further reduce the power consumption of future equipment versions. Among these, further improvements in power amplifier architecture and integration of more processing power, are two of the areas expected to provide most of these improvements.

With regard to the power amplifier, the adoption of Doherty power amplifiers (PAs) has already introduced considerable improvements in efficiency (Figure 3.3). This

¹² While intermediate releases exist, these represent and follow the main releases of NSN equipment (Flexi BTS family).

is achieved by implementing a two stage amplifier, with a main amplifier always active and a second (auxiliary) amplifier in standby mode, activated only to deal with peaks [88]. Power amplifier efficiency is expected to be improved further by the adoption of more ‘finer’ stages, going from the current 3-way to n-way Doherty architecture with an effective dynamic adaptation of operation point (envelope tracking) [35]. Other improvements expected to add to the overall improvements in power amplifier efficiency are also expected with the maturity and adoption of High Electron Mobility Transistors (HEMT) and the use/availability of Gallium Nitride (GaN) [35] [89].

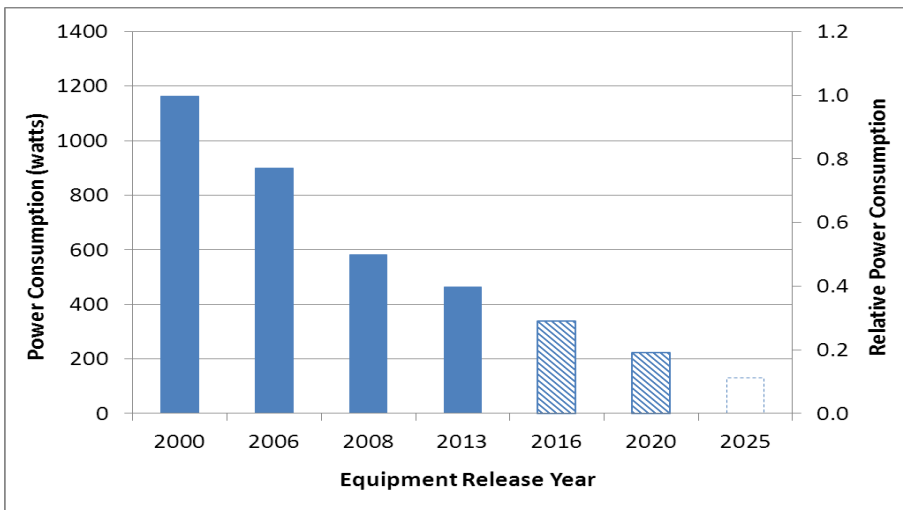

Figure 3.12 – Power consumption comparison for different equipment versions. All releases assume a common macro configuration with a transmission power of 20 watts per carrier per sector. With the 2008 flexi base station used as reference different versions are estimated using the factors in Table 3.1.

When it comes to the baseband unit, the integration of semiconductor technology is expected to continue, with a transition towards having fewer components (System on Chip – SoC), embedding CPU, memory, and FPGA among others. With a scalable architecture, a number of ‘sub-modules’ can be dynamically activated or deactivated based on the processing needs, making the overall design more efficient [35]. In addition to this, the constant increase in processing capacity, predicted by Moore’s law, also allows for the same processes being executed within a shorter amount of time, thus consuming less power.

Within this thesis it is assumed that two further equipment releases occur before the end of the decade (2020). Based on necessity of reducing the power consumption

of a growing regiment of base station sites together with the described expected technological improvements, a yearly reduction in power consumption of 10% is assumed, with the two equipment versions assumed release in the years 2016 and 2020 (Figure 3.12). Speculation for how the power consumption can be expected to evolve beyond this point is much harder to justify. Presented differently, the improvement in power efficiency for all of the assumed equipment releases is illustrated in Figure 3.13. This shows how during a 20 year period the improvement in base station equipment has increased the power efficiency of base station sites from 5% to 27%.

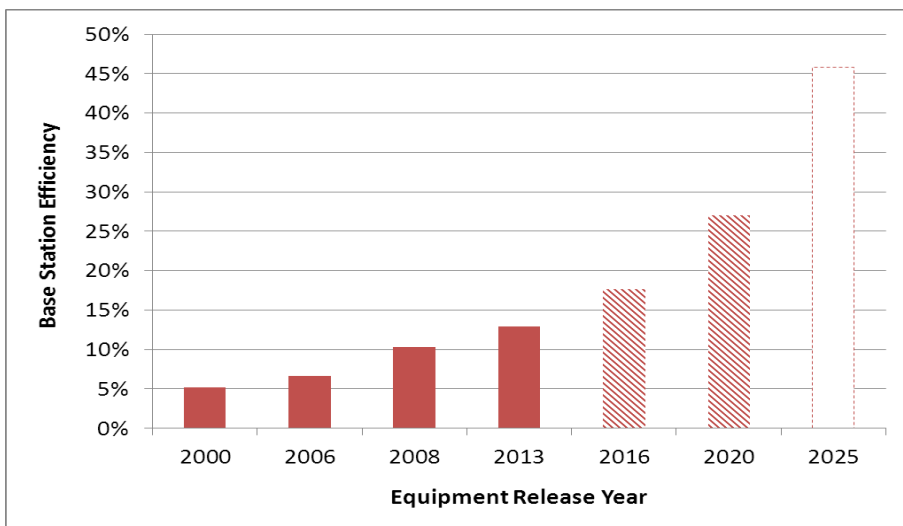

Figure 3.13 – Based on the same data provided in Figure 3.12, this provides a different view to illustrate the improvements in power efficiency with different versions of base station equipment.

Based on the supported network layers and age of the site, different sites are often equipped with different versions of base station equipment. The replacement and upgrade of base station equipment can be triggered by a need, a sought gain/improvement, or a specific business case¹³ [36]. With a reduction in power consumption and related costs being a possible candidate, the network evolution study presented in Chapter 5 is extended further to also investigate the impact of replacing base station equipment. The investigation attempts to quantify, whether

¹³ The lifetime of base station equipment, especially for rural areas has over the years been reducing, with operators replacing equipment every 3-5 years. On the other hand in rural areas these might skip a generation and stay for up to 10 years [81].

the replacement of equipment is sufficient to balance out the increase in power consumption experienced as a result of the necessary capacity upgrades.

3.7 Limiting Power Consumption Growth

The continuous growth in traffic and the need to deploy additional sites is likely to sustain the growth in power consumption. With base station sites often highlighted as being the main culprit, a number of options are available to reduce, or at least limit, this growth. While each of these options on its own is unlikely to entirely solve the issue, it is possible that a combination of different options results in a more noticeable impact. Below is a short descriptive overview on some of the main options for MNOs to reduce power consumption in mobile networks. Most are described and investigated in greater detail within the following chapters.

3.7.1 Power Efficient Capacity Evolution

While every case is specific, MNOs can choose among a number of options for upgrading the capacity of existing mobile networks. Even though site and network upgrades are linked to an increase in power consumption, different options are likely to have a different impact on the extent of this growth. Considering the various upgrade options for macro base station sites and different extents of heterogeneous networks, to provide a common level of performance, this can provide a comparative overview of how these options compare from a power consumption perspective. Presented in Chapters 5 and 6, two case studies show the impact of different evolution strategies within different areas of the network. Based on this, recommendations on which network evolution path consumes least power can be carried out.

3.7.2 Equipment Replacement

While this can be triggered based by other factors, MNOs often have predefined strategies on how often to replace base station equipment. Understandably, more frequent replacement is costly, meaning that this has to be justified either by new/essential operational functionalities or major improvements (including power consumption). No matter the case, replacing older equipment reduces the overall power consumption of the network. It is hoped these that savings are enough to offset the increase in power consumption that occurs as a result of upgrading

capacity in existing sites and deploying additional sites/cells. The potential gains of equipment replacement are presented in more detail through a case study, the details of which are presented in Chapter 5.

3.7.3 Dedicated Features

Equipment vendors frequently release a number of software features that further expand the capabilities of existing base station sites. In addition to improving performance, some of these upgrades can include a number of power saving features. Such features often attempt to exploit network or equipment redundancies, during periods when traffic is low. A number of such features are described and investigated in further details throughout Chapter 7.

3.7.4 Network Sharing

In an attempt to reduce expenses and lessen the risks involved with rolling out a new network, a further option is that of sharing a common network between multiple operators [90]. Referred to as network sharing, each of the MNOs would own half of the otherwise owned sites (in the case of two operators). Each site is equipped¹⁴ with added capacity, ensuring that it can handle traffic for both operators. Recently, Vodafone and Telefónica in the UK [91], and similarly Telenor and Telia in Denmark [92], have publically announced such an agreement. In addition to the cost savings and ability to increase coverage, this is also believed to considerably reduce the overall power consumption of each MNO.

3.8 Conclusions

This chapter introduces the basic architecture of macro base stations, highlighting and describing a number of the main components. Based on this, the chapter introduces the power model that is used to calculate the power consumption for different site configurations. Power models for small cells, which can be deployed both indoors and outdoors, are also described. Based on the network layouts investigated, an excel tool embedded with these models allows for the power consumption and efficiency of a given area to be estimated. This is then used to

¹⁴ Each of the MNOs would still own and operate over the already licensed spectrum.

compare, from a power perspective, how different deployment scenarios or features compare. The chapter also briefly introduces a number of options for limiting the growth in power consumption, most of which are investigated in further detail in the following chapters.

4. Macro vs. Small Cell Layout for Power Consumption

4.1 Introduction

Heterogeneous networks bring together multiple Radio Access Technologies (RATs) and the concept of overlaying small cells within the coverage of an existing macro network [93]. With the expected increase in mobile broadband traffic, small cells are mainly considered as an option for boosting capacity [82] in traffic hotspot areas, concentrating capacity over a smaller geographical area. Within literature these are often described as low-cost, low-powered [82] network elements. While in comparison with a regular macro site, this may be the case, the overall cost of deploying and maintaining a larger number of small cells is very case specific, and is dependent on the existing infrastructure available to the mobile operator. In addition to the cost of the hardware itself, different scenarios have specific requirements with regard to site infrastructure, aggregation, and transport to the core network. While power consumption remains the main focus, some of these practical and cost related issues are described in further detail within Section 4.3.3, providing a wider insight into the potential challenges attributed to small cells.

Currently, mobile networks consist primarily of macro base station sites, often complemented by small cells positioned within or around large venues¹ (airports, stadiums, etc.). Alternatively small cells (predominantly indoor versions) have also been extensively used to extend or improve network coverage² in hard to reach areas, providing a private hotspot for the affected subscribers. Given an already well-established network infrastructure, additional capacity oriented small cells are expected to further enhance existing predominantly macro based networks. Nonetheless, it is of interest to ponder on whether a homogenous deployment of

¹ In addition to small cells, listed venues sometimes also make use of distributed antenna systems (DAS) whereby a shared infrastructure is used among a number of distributed antennas.

² Small cells can also be used to extend network coverage in areas where macro coverage is weak or in some cases inexistent [71].

small cells would consume more or less power than deploying fewer, high power, macro base station sites. A graphical representation of these two options is presented in Figure 4.1.

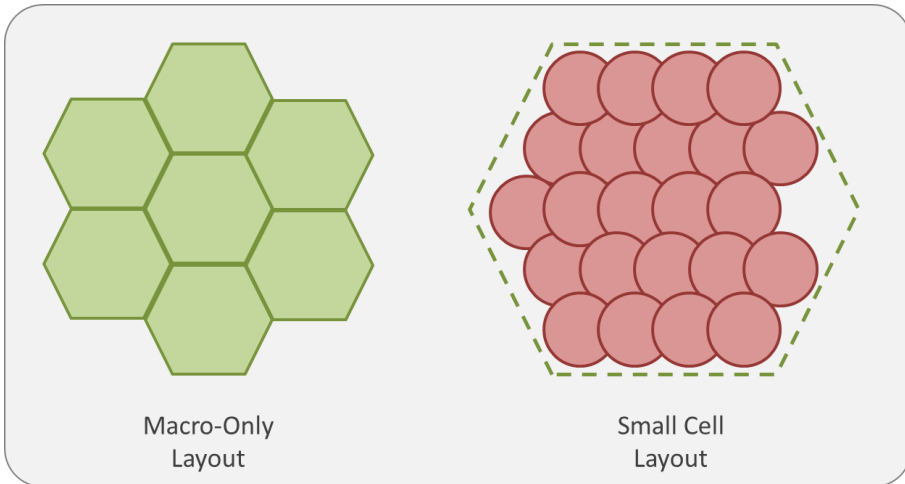

Figure 4.1 – Macro-only layout vs. a small cell layout comparison for mobile networks. This chapter aims at identifying which of the two options consumes least power.

A number of studies have already tackled the topic of small cells, generally assumed to complement an existing array of macro base station sites. These have covered various types of analyses including performance [94], power consumption [67], and cost [95] [96]. Starting from the assumption of an existing macro base station layout, most of these studies do not consider a homogeneous small cell network. While briefly discussed in [94], this and other studies that investigate the power consumption of small cells [67] often base results on the transmitted power and not consumed power, with some studies claiming power savings in the range of 85% [97]. Different from such studies this chapter presents an investigation that compares a homogeneous small cell network layout with the more typical macro base station layout. After ensuring that the different network layouts provide similar levels of performance, a power consumption analysis, based on the power models presented in Chapter 3, provides a generic overview on how these different layouts compare from a power consumption point of view (as seen by the operator).

It can be expected that for remote and rural areas, the coverage capabilities of macro sites, which can extend over a few kilometers, would still consume less power than a vast array of small cells. Assuming the transition from rural to a dense

urban scenario, there can be a point beyond which a small cell solution becomes the option that consumes least power. If small cells are proven to consume less power than a macro configuration, at least for certain areas of the network, then heterogeneous networks could in fact be a transition towards an eventual small cell based network, with macro sites providing a wider coverage footprint handling fast moving users.

4.2 Network Scenario Setup

Assuming a greenfield scenario allows for a number of practical issues to be disregarded. With the aim being that of comparing different topologies from a power perspective, Monte-Carlo simulations are used to determine the number of base station sites and small cells that are required to provide comparable performance levels for a given number assumed users. The study is carried out on an area measuring 14.7 km^2 ($3.5 \times 4.2 \text{ km}$), 20% of which is masked out around the edges. Due to the absence of wraparound, sites within this masked area generate interference to edge sites, limiting edge-effect. Edge-effect is an irregular improvement in apparent signal-to-interference (SIR) ratio caused by the lack of interfering sites from beyond the network area considered.

4.2.1 Network Simulation Environment

The investigation is carried out over a High Speed Packet Access³ (HSPA) only RAT, with downlink being the main focus. A static Monte-Carlo system level network planning simulator (Figure 4.2) developed in Matlab breaks up the investigation area into a discrete set of pixels. Each measuring 25 by 25 meters, these are used by the simulator to deploy macro sites, small cells, and mobile broadband users. Assuming no practical and/or realistic deployment restrictions, a regular pattern with equally distant sites is adopted. The distance between sites, inter-site distance (ISD), is inversely proportional to the traffic, and is increased or decreased accordingly to achieve the required level of performance. For macro sites, a minimum ISD of 300 meters is set. Beyond this, the added interference from neighboring sites would considerably limit further gains in capacity (unless heavily

³ The selection of HSPA is based on the fact that practically all of the network evolution studies and feature investigations are carried out on existing HSPA networks.

optimized). While the overall simulation procedure is hereby presented in more detail, the same simulation tool is also used for the cases presented in the following chapters. While the same simulation methodology is used, differences in the assumed models and overall assumptions are, where applicable, individually presented.

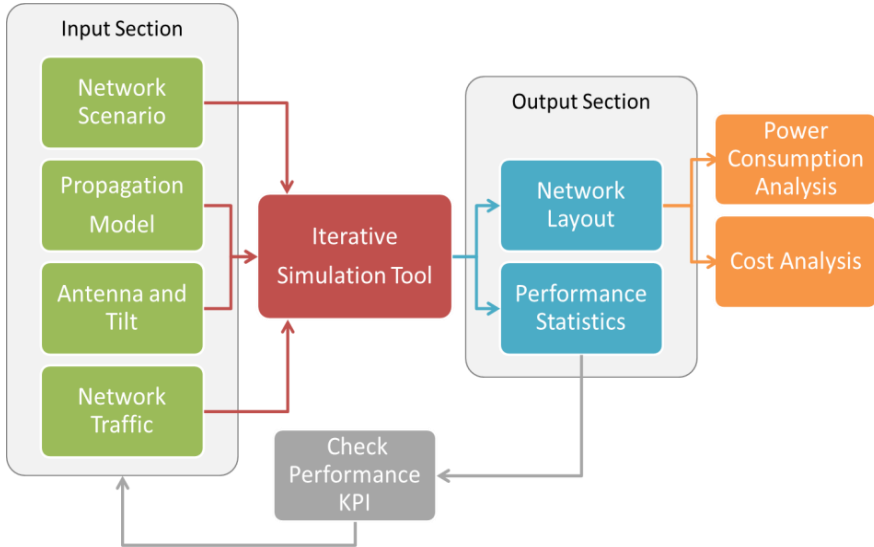

Figure 4.2 – Block diagram highlighting the main input and outputs of the simulation tool. The power consumption analysis is based on the network layout output of the simulation tool.

4.2.1.1 Propagation Model

With the assumption of outdoor site deployment over a regular network, path loss for macro sites is estimated through the Cost-231 Hata model⁴ (4.1). With the investigation carried out on an HSPA system, an operating frequency band (f) of 2100 MHz is selected. Antennas are assumed at a height of 25 and 1.5 meters for the macro sites (h_B) and user equipment (h_R) respectively.

$$\begin{aligned}
 Pathloss_{Macro}(dB) = & 46.3 + 33.9 \cdot \log(f) - 13.82 \cdot \log(h_B) - a(h_R) \\
 & + [44.9 - 6.55 \cdot \log(h_B)] \cdot \log(d) + c
 \end{aligned} \quad (4.1)$$

⁴ The impact of shadow fading, generally modelled through a spatially correlated log normal stochastic variable [138] is not included. This reduces simulation complexities, and hence time.

where, $c = 0$; $a(h_R) = [1.1 * \log(f) - 0.7] * h_R - [1.56 * \log(f) - 0.8]$ (4.2)

When considering the deployment of small cells, an outdoor-to-indoor propagation model (4.3) is implemented. The attenuation in signal between the transmitting and receiving antennas is given as a function of the distance (d). Similar to macro sites, small cells (single sector) are deployed outdoors, with omnidirectional antennas assumed at a height of 5 meters.

$$Pathloss_{Small_cell}(dB) = 7 + 56 * \log(d) \quad (4.3)$$

4.2.1.2 Antenna Pattern and Tilt

Since simulations consider both horizontal and vertical antenna patterns, both based on 3GPP recommendations [98], down tilting becomes an important factor for reducing interference and optimizing the performance of the network [99] [100]. While dependent on the antenna height and width of its vertical beam, the tilt angle is inversely proportional to the ISD. Since the ISD is varied for deploying more or fewer, default tilt settings for three ISD ranges are proposed, with selected values based on [101].

$$\begin{aligned} (ISD \geq 1000 \text{ meters}) \text{ antenna tilt} &= 6^\circ \\ (1000 \text{ meters} > ISD \geq 500 \text{ meters}) \text{ antenna tilt} &= 8^\circ \\ (ISD < 500 \text{ meters}) \text{ antenna tilt} &= 12^\circ \end{aligned} \quad (4.4)$$

4.2.1.3 Traffic Modeling

Assuming a uniform traffic density, traffic is modeled by randomly placing a predetermined number of users within the network area. While assuming the same minimum requested data rate for each user, traffic within the network is increased by increasing the number of assumed concurrent users. The range of users is increased from an initial value of 100 up to 3000, representing a user density of 17 and 510 users per km^2 respectively, and an overall network traffic growth of x30. Individually, traffic for each user is based on a full buffer model. This assumes that

each user requests an infinite amount of data to download from the serving base station or small cell.

Since mobile broadband traffic is predominantly generated and consumed indoors, all generated users are assumed located indoors. Based on the type of building, materials, and location within the building, signals traversing from an outdoor to an indoor environment are considerable attenuated. The extent of this attenuation varies from building to building, and can range anywhere from 15 dB to 50 dB, or more [59]. For this case, an indoor penetration of 25 dB and 5 dB is assumed for macro site and small cells respectively. Added to the respective propagation loss, the difference in penetration loss comes from the fact that the small cell propagation model (4.3) already includes a 20 dB indoor penetration loss.

4.2.1.4 Link Budget and SINR Calculation

After distributing users within the network area, the received signal power from every cell to every user is calculated. For each user (i) and cell (j), the distance and orientation is calculated. This is used to determine the distance dependent path loss and both horizontal and vertical antenna gains. Depicted in equation (4.5), these together with the assumed penetration loss are used to determine the received power. This gives a matrix of received power for every user from every cell in the network area (P_{RXij}). To note that P_{TXj} represents the transmission power of the cell, and G_{ij} includes the assumed antenna gain and cable loss. While possible to optimize the transmission power based on the site density (ISD), this is not included within this thesis. This is based on the fact that for all of the cases considered (urban scenarios), the areas are predominantly interference limited.

$$P_{RXij} = P_{TXj} + (G_{ij} - Pathloss_{ij} - PenLoss_i)[dB] \quad (4.5)$$

Based on the received power, the signal-to-interference-plus-noise-ratio (SINR) is calculated (4.6). For the calculation of the SINR, the transmission power assumed is a portion (10%) of the maximum transmission power. This represents the transmission power of the pilot channel. The term $\sum P_{I_k}$ represents the summation of received signal from other sites operating within the same frequency channel, thus causing interference. The term N represents the receiver noise power, which is calculated based on the product of the noise power density (174 dBm/Hz), the transmission bandwidth and noise figure. At this point, each user is associated with the cell providing the highest SINR, thus becoming its serving cell.

$$SINR_{ij} = \frac{P_{RX_{ij}}}{\sum P_{RX_k} I_k + N} \quad (4.6)$$

The estimation of possible user throughput is determined by mapping the SINR, estimated on the transmission channel power, of every user against an SINR to throughput mapping curve. Illustrated in Figure 4.3, this is achieved through detailed link level simulations [102] [103]. Based on this mapping curve, the radio resource allocation algorithm, presented in the following section, distributes available resources among all of the active users.

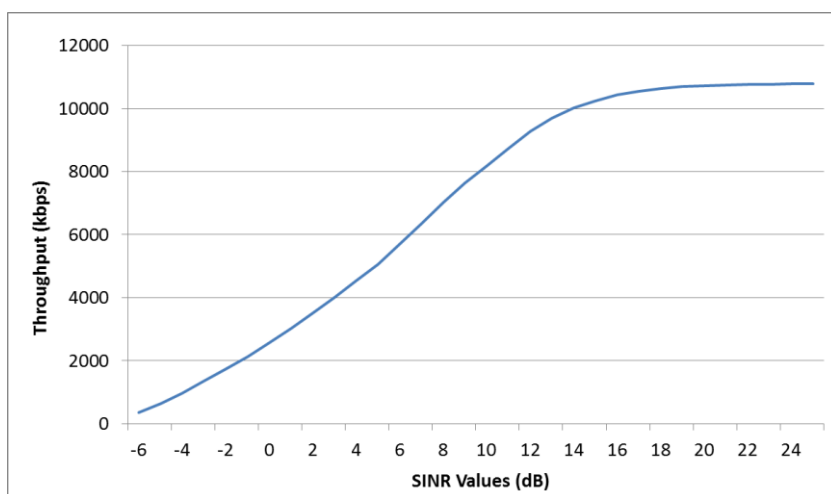

Figure 4.3 – SINR-to-throughput mapping curve which determines the achievable throughput for a specific SINR value (hard limit at 11.4 Mbps - HSDPA).

4.2.1.5 Radio Resource Allocation

For each base station cell, the first step of the radio resource allocation algorithm is that of sorting all users by decreasing value of SINR. The actual process of distributing resources is implemented and carried out over two phases (Figure 4.4). In the first phase, starting from users with the highest SINR, sufficient resources to ensure the minimum data rate are first assigned⁵. In the case that many users are connected to the site, and insufficient resources are available, then this will result in

⁵ Users experiencing a higher SINR require fewer resources to achieve the minimum data rate, which in turn minimizes the number of users in outage.

some of the worse users to be in outage. In the case that all users achieve the minimum required data rate, the assumption of full load requires for all of the remaining resources at the site to also be shared. This also represents a scenario in which users experience full interference.

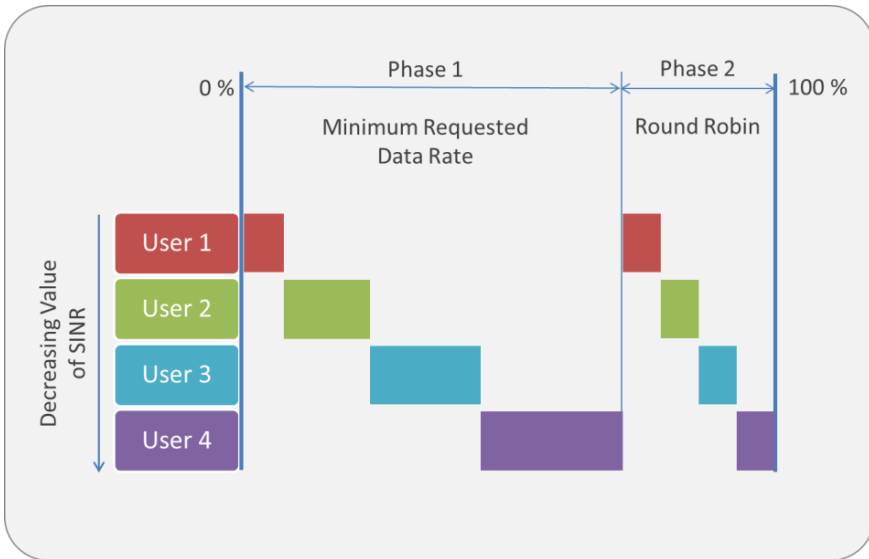

Figure 4.4- Graphical representation for how radio resources (x-axis) are divided among connected users in a full load scenario. Given the assumption of a full load scenario, after all users are ensure the minimum required data rate, remaining resources are equally shared among all users.

In phase two, remaining resources are distributed among all users in a round robin fashion. This increase the data rate of each user further, but users with a higher SINR will of course achieve higher data rates than those with a lower SINR. For cases assuming the use of multiple adjacent carriers, the data rate for each user is increased in proportion to the number of carriers, reducing the amount of resources required. For instance, the addition of a second carrier halves the amount of resources that are required for a user with a specific SINR⁶ to achieve the minimum requested data rate.

4.2.2 Network Key Performance Indicator

Since the power consumption of different network topologies is investigated, it is required that all cases provide similar performance levels, making for a fairer

⁶ For adjacent carriers, the same SINR is assumed for both carriers.

comparison. The key performance indicator (KPI) for the performance of the network is measured through percentage of users in outage. This is the percentage of all users within the area that fail to achieve a predetermined minimum data rate, necessary for providing an adequate mobile broadband experience⁷. For this specific investigation, these parameters are set such that the network delivers an outage that is no more than 5%, while providing all users with a minimum data rate of 512 kbps. In order to provide some degree of flexibility and room for simulation variances⁸, a tolerance of $\pm 2\%$ is allowed, putting the range of required outage level anywhere between 3% and 7%. This and other main parameters used for this investigation are presented in Table 4.1.

Table 4.1 – A selection of main simulation parameters assumed for the investigation.

Technology	HSDPA (Downlink)	
Frequency Band / Carrier Bandwidth	2100 / 5 MHz	
Investigated Area	5.88 km ²	
Resolution of Network Area	25 meters	
No. of Simulation Snapshots	100	
Traffic Distribution	Uniform	
Indoor Deployment	100 %	
Target Network Outage	5 \pm 2 %	
Minimum Requested Data Rate	512 kbps	
Antenna Tilt	Variable based on ISD (4.1)	
	<i>Macro</i>	<i>Outdoor Micro</i>
Antenna Height	25 meters	5 meters
Outdoor-to-Indoor Loss	25 dB	5 dB (+20 dB with propagation model)
Path Loss Model	COST-231 Hata	3GPP Micro (Outdoor-Indoor)
Transmission Power (per carrier)	20 Watts	3.2 Watts
Antenna Gain (with 1dB cable loss)	14 dBi	5 dBi

⁷ As online services mature and become even more centred on multimedia, the assumed minimum data rate required by each user for the same adequate experience needs to increase.

⁸ Since a regular deployment is considered, a change in ISD can result in cases having more sites than required to meet the performance requirement.

4.2.3 Site Configuration and Power Consumption

All macro base station sites are assumed configured with three equally spaced regular sectors. The orientation of each sector is identical for all of the deployed sites, creating a homogeneous (regular) coverage pattern. Three macro options are considered, going from a single 5 MHz carrier, up to a maximum of three adjacent carriers. In addition to comparing different macro configurations with small cells, this also allows for a comparison of the impact for different macro configurations. Each macro carrier is assigned a transmission power of 20 watts (43 dBm), at the antenna. The impact of feeder cable loss and RRH is also included with a 3 dB loss assumed for macro base station sites.

Deployed in the same pattern as macro base station sites, small cells are assumed as single carrier sites⁹ with an omnidirectional sector antenna and a transmission power of 3.2 watts (35 dBm). For small cells, a feeder cable loss of 1 dB is attributed. Based on the power model, this gives a power consumption of 184 watts for each small cell deployed. The power consumption and ratio between different macro configurations and small cells are presented below in Table 4.2.

Table 4.2 – Overview of the power consumption for the different site configurations with and without RRH. A factor comparing the number of small cells to macro site is also added.

Configuration	Power Consumption (watts)		Power Ratio of Small Cells to Macro Configuration ($P_{\text{SMALL_CELL}} = 184 \text{ Watts}$)	
	with RRH	without RRH	with RRH	without RRH
1 Carrier Macro	624	752	3.4	4.1
2 Carrier Macro	839	1096	4.6	6.0
3 Carrier Macro	1061	1439	5.7	7.8

4.3 Results for Regular Deployment

4.3.1 Network Performance

For cases with a different number of users, a comparable network performance is achieved by adjusting the ISD, changing the number of deployed sites within the

⁹ If a MNO actually owns multiple carriers, the performance of small cells can be improved further by deploying additional carriers to small cells or if interference is a problem introduce some form of frequency reuse scheme.

area. Simulation based statistics show that for all cases, an average outage rate of 4.6% with a standard deviation of 1.4% is achieved. Over the entire range of simulated users, it is noted that all cases result in comparable average network throughput, highlighted below in Figure 4.5.

A summary of results showing the comparison between ISD, number of sites and outage for all simulated cases is presented in Table 4.3. Even though planned to perform equally, discrepancies between the different network layouts arise from having fewer or more sites than necessary, pushing the percentage of users in outage away from the 5% target value.

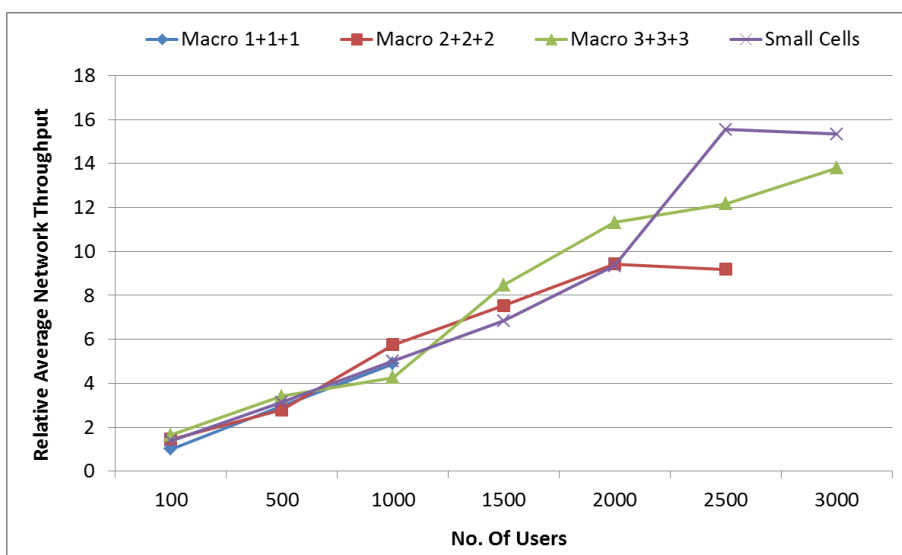

Figure 4.5 – Increase in average network throughput with number of users. Even if driven to deliver the same performance, a lack of fine tuning results in the noted variations for the average throughput, especially noticeable for a high number of considered users.

While not as noticeable at the lower end of the scale, this becomes more obvious for higher number of users. This occurs since beyond a certain point, a small adjustment in ISD results in many more sites being deployed. For instance, for the case with small cells, as the number of users is increased to 2500, a small decrease in ISD by five meters brings about the deployment of an additional 154 small cells within the area (Table 4.3). This pushes the outage down to 1.3%, way below the target of 5%. As a result, this boosts the average network data rate, noted to peak in Figure 4.5. For the following simulation case with 3000 users, this surplus in capacity is sufficient to sustain the added users, increasing the outage to 2.4%. This

causes the apparent plateau noted for the average network throughput for small cells. While differences in network performance, away from the target, have an impact on the power consumption of the resulting network, the overall results, trends, and conclusions presented in the remaining sections are likely to remain valid.

To note that macro cases with one and two carriers are unable to meet the minimum required performance beyond specific user densities. Even though more sites could be deployed, reducing the ISD further than the 300 meter set limit, the added interference, as a result of the full buffer traffic model, limits further improvements in performance. This can be defined as the system limit for a given amount of allocated spectrum.

Table 4.3 – An overview of results for the regular deployment of small cells and macro base station sites. Table puts into perspective the number of sites required, ISD, and resulting outage.

No. of Users	1 Carrier Macro			2 Carrier Macro		
	ISD (m)	No. of Sites	Outage (%)	ISD (m)	No. of Sites	Outage (%)
100	600	21	4.5	700	15	2.6
500	400	44	5.4	520	24	4.4
1000	300	77	7	400	44	3.8
1500	-	-	-	350	60	5.5
2000	-	-	-	300	77	5.7
2500	-	-	-	300	77	5.2
3000	-	-	-	-	-	-

No. of Users	3 Carrier macro			Small Cells		
	ISD (m)	No. of Sites	Outage (%)	ISD (m)	No. of Sites	Outage (%)
100	750	12	4.9	320	65	4.4
500	600	21	4.5	250	111	4.9
1000	500	27	6.9	200	168	5
1500	400	44	3	170	216	3.7
2000	350	60	3.2	130	308	5.2
2500	320	65	4.1	125	462	1.3
3000	300	77	5	125	462	2.4

4.3.2 Power Consumption

Based on the set of assumptions, the first noticeable outcome is that if all deployed macro sites are assumed to incur feeder cable losses, then a small cell solution is the most power efficient option (Figure 4.6). Even at the lower end of the scale with 100 active users, small cells, deployed at an ISD of 320 meters, remain the most efficient option. For the same amount of users (traffic), three carrier macro sites can be deployed at an ISD of 750 meters, but still consume more overall power. Comparing the three carrier case with small cells, across the entire range (users), power comparison results show that the latter, on average, consumes 28% less power.

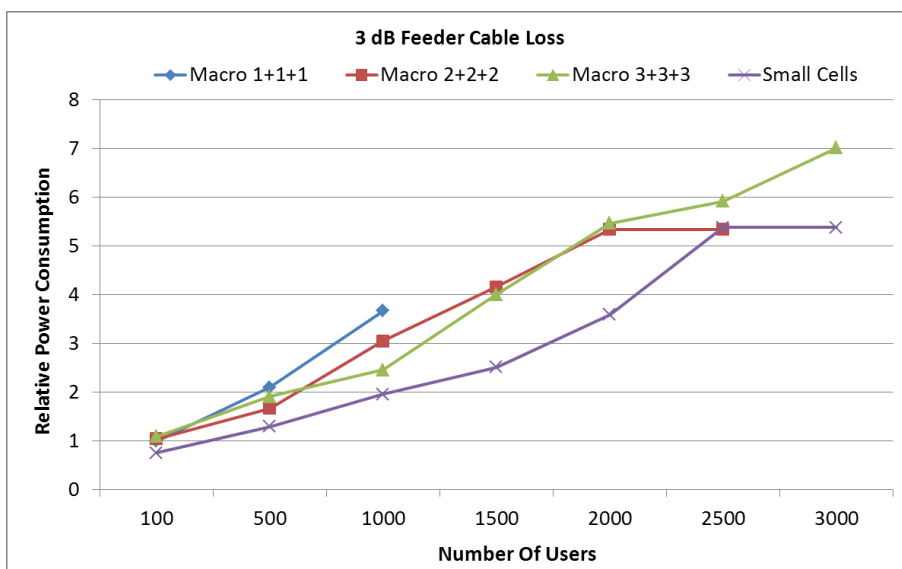

Figure 4.6 – Overview of how the power consumption for different deployment strategies varies with respect to the single carrier macro case. All macro sites are assumed to incur a cable loss of 3 dB.

For the case assuming macro sites equipped with RRH (Figure 4.7), gained power savings bridge this gap, making it relatively difficult to select a better option. Similarly, comparing the three carrier case with small cells, on average the small cells solution consumes a mere 2% less power than the macro case. Even if power consumption is the priority, such a small gain would make the final selection fall upon other criteria, likely to be practical and financial ones.

In order to obtain a better understanding of how the various configurations compare, a deployment factor giving the number of small cells required for each

macro configuration is averaged over the range of simulated users¹⁰. Presented in Table 4.4, this together with the power consumption factors in Table 4.2 allow for a more generalized overview on the power saving potential (if any) of a homogeneous small cell network layout. If the ratio for the number of deployed sites is less than that of the power consumption, then a small cell solution consumes less power than the macro counterpart. From a deployment factor point of view it is noted that as the number of macro carriers is increased, the number of small cells required to provide comparable levels of performance increases at a slower rate. This occurs due to the fact that small cells provide capacity over a restricted area, thus sharing resources among fewer users.

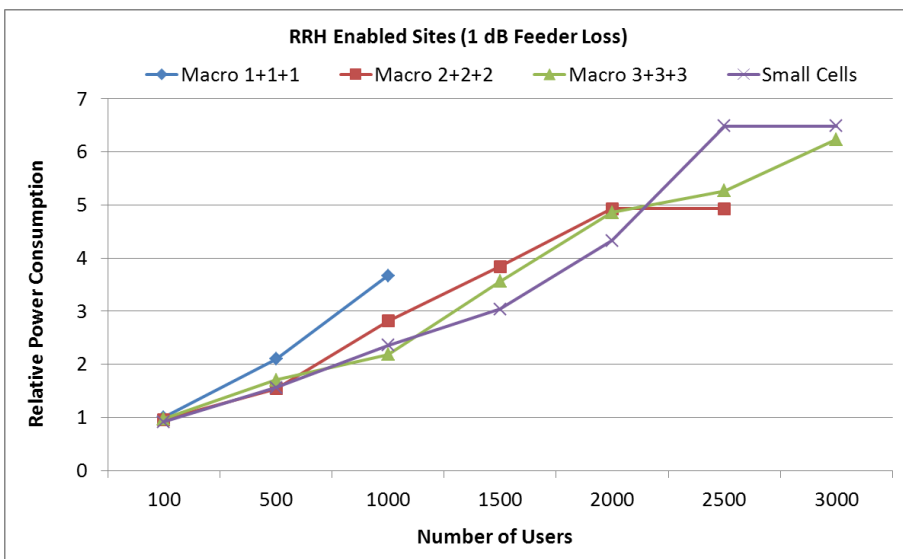

Figure 4.7 – The impact of RRH is added to the investigation to gauge the potential impact that this can have on the previously presented results.

Table 4.4 also lists the potential savings of small cells against the different macro options considered, with or without RRH. The table, based on statistics extracted from the study, again highlights how a multi carrier macro solution with RRH bridges the gap to a homogeneous small cell layout (around 3%). This means that for the case with RRH, fewer high capacity macro sites, with two or three carriers,

¹⁰ Since the macro cases with one and two carriers do not meet the performance requirement across the entire range of simulated users, the deployment factor is extracted by averaging the number of sites up until the specific configuration reaches its capacity limit.

can perform almost on par (performance and power consumption) with a larger quantity of low power small cells, making the former a more attractive solution from a deployment and logistical perspective. Table 4.4 also shows how the introduction of RRH has a greater impact on sites with a larger number of carriers. This can be noted since the two carrier option consumes less power than the three carrier option for the case without RRH, which inverts for the case with RRH.

Table 4.4 – Average number of small cells required to provide the same performance for each macro case. The last columns show the power savings of choosing a small cell solution.

Configuration	No. of Small Cells Required For Each Macro Site	Power Savings of Small Cells over macro configurations	
		with RRH	without RRH
1 Carrier Macro	2.6	23 %	36 %
2 Carrier Macro	4.4	3.5 %	26 %
3 Carrier Macro	5.6	3 %	28 %

Since different macro configurations are considered, results also provide the opportunity to compare these options among each other. By only considering the range of users for which all three macro cases meet the required KPI, with outage varying by a maximum of 0.6%, it is noted that the cases with two and three carriers consume comparable levels of power. On the other hand, for the case with a single carrier, the extent of having sites increases the average power consumption of the network by 21%. This means that for the given set of assumptions, fewer macro sites with multiple (two or three) carriers consume less power than having a greater number of single carrier macro sites.

4.3.3 Financial and Practical Aspects

When deploying a new, or upgrading an existing network, performance and power consumption are only a part of the equation. A third, crucial, dimension is related to the cost of the proposed option. A key cost factor is backhaul. Current macro base station sites currently exploit a mixture of two main backhaul options. In one case, line-of-sight (LOS) microwave (MW) links can be quickly and easily deployed, providing great range irrespective of the terrain and location. Alternatively, fiber¹¹

¹¹ While a third option, copper, is previously mentioned in Section 3.2.5, this is omitted from the current discussion which focuses on the two key backhaul solutions.

can provide added reliability, requires no spectrum, is cheap to run, last longer, and provides close to unlimited capacity [76] [104].

Another factor impacting the CAPEX of different deployment strategies is the cost of the equipment. Small cells are often quoted as being low cost, but the ratio to the macro equivalent must be defined to understand the benefits of choosing one deployment strategy over another. Based on the deployment factors presented in Table 4.4, the cost of deploying a single small cell (CAPEX + IMPEX) needs to be at least one sixth that of a 3 carrier macro site.

The OPEX part of the costs for a base station site is mainly governed by site rental, maintenance and energy. In addition to having a large and growing number of sites, the cost of electricity has over the last years also been increasing. Statistics from 12-EU countries show that the cost of electricity has risen by a rate of 12% on a year to year basis [13]. Over a period of ten years, this sustained growth would triple the cost of electricity, highlighting the effort carried out by MNOs to try and minimize the overall power consumption of mobile networks.

4.4 Conclusions

Assuming a greenfield scenario, this chapter compares the potential and feasibility of a homogeneous small cell network layout versus the more traditional macro cellular layout. Expected to play a role in future high capacity networks, the performance, and power consumption of a small cells is compared with that of three different macro configurations.

For the case of single carrier macro sites, incurring a feeder cable loss of 3 dB, a small cell only solution consumes 36% less power. Since fewer macro sites with more carriers are more power efficient, the case with two and three carriers reduces the power gains of a small cell option to 26% and 28% respectively. For the case with RRH, the power savings of small cells are to a greater extent canceled out. This is especially true for macro sites with multiple carriers, with a small cell solution consuming around 3% less power. To note, these analyses do not consider the power consumption of backhaul, which could define which of the strategies consumes least power.

Based on these assumptions, a small cell only network consumes less power than a macro based network. While an improvement in the power consumption of small cells¹² could further enhance the case for a small cell network, a macro layout with multiple carriers configured to minimize losses can deliver comparable results in terms of power and performance, likely to make it a more suitable option from a financial and logistic perspective. This tear between a solution consuming less power and one that is more practical and financially viable, pushes towards an optimum that is likely to exploit the benefits of both, a hybrid between macro base station sites and small cells, a heterogeneous network environment.

4.4.1 Take-Away Points

The take-away points section is intended to present the main outcome of the chapter in a few straight to the point statements. For this chapter the take-away points are:

- In urban / sub-urban areas small cells consumes less power than a macro only solution.
- RRH equipped macro sites with multiple carriers can ‘match’ the power consumption of a homogeneous small cell network layout.
- Fewer macro sites with more carriers consume less power than a single carrier option.
- From a financial perspective, the power savings of small cells could be outweighed by the added cost of deploying and maintaining many more sites.

¹² In addition to improvement in power consumption, when considering the entire site macro cells are likely to have more overheads and redundant equipment.

5. Power Consumption Trend – A Sub-Urban Case Study

5.1 Introduction

In addition to providing an overview of the impact of different evolution strategies, studies based on regular homogeneous scenarios are easier to reproduce and compare with similar third party analyses. While more challenging to model, verify, and simulate, an irregular network topology coupled with real world assumptions¹ provide a clearer perspective on the extent (quantity) of necessary upgrades required to meet a predefined traffic growth. The objective of this and the following chapter is to investigate and compare a number of network evolution strategies from a performance and power consumption perspective. Carried over a period of eight years (2011 until 2019), the outcome is used as basis for providing a set of recommendations for upgrading existing networks while minimizing the increase in power consumption. These are presented in a way and format that attempts to address some of the current challenges faced by mobile network operators. These two chapters consider two distinct regions (sub-urban and urban) of the same network, covering an area around a major European capital.

In addition to evolving the network for increased capacity, the sub-urban analysis is taken a step further to also consider the impact of replacing and upgrading old base station equipment. Within available literature, no study has yet been noted to include the upgrade of network capacity with the replacement of base station equipment. This novel investigation is carried out in an attempt to provide, and quantify, a realistic estimate to how much of the increase in power consumption (as a result of capacity upgrades) mobile network operators can offset through equipment replacement.

¹ While some strategies might on paper appear as being a better solution, the inclusion of real world assumptions could highlight some practical and/or financial limitations.

It is important to note that the objectives of these two chapters are not aimed at providing a tailored and optimized (quantitative) solution. On the other hand, these chapters are targeted at determining the impact that different network upgrade and equipment replacement strategies have on the energy trend in mobile broadband networks. While detailed network optimization would have significantly increased the complexity of the simulator and simulation time, it is believed that this would have had minor impact on the resulting trends achieved from the study.

5.2 Network Data Extraction

Ongoing research collaboration with a multinational mobile network operator allows for real network data and traffic statistics to be extracted from a specific network. Representing a sub-urban and urban area, these separate scenarios provide two case studies to investigate and compare a number of capacity evolution strategies, emphasizing on the impact that each has on the power consumption of the resulting network. While all network evolution scenarios are driven towards a common performance measure, differences in other criteria, mainly average network throughput, are still highlighted. This puts into better contrast the impact that a network consuming higher or lower levels of consumption has on the overall performance. The association between power consumption and network performance is better encompassed through the network energy efficiency term, a further measure that compares the different evolution strategies.

In order to accurately model and recreate both areas within the static system level simulation tool, introduced earlier in Chapter 4, information about the current state and layout of the network is required. Made available by the collaborating mobile network operator, and summarized in Table 5.1, this information provides the necessary data to position and configure each individual base station site within both network areas.

5.1 Sub-Urban Network Scenario

The sub-urban scenario is based on an area of the network situated on the outskirts of the capital city. The area, measuring around 30 km², is currently composed of 14

macro base station sites, with an average intersite distance (ISD) of 970 meters. While half of the sites are configured with a single 5 MHz HSPA carrier, the rest have already been upgraded with a second carrier. Base station data extracted from the network also includes information on sites situated outside (around) of this area. By also including these additional sites to the simulations, the generated interference avoids boarder effect, resulting in a more consistent performance evaluation, especially for users located towards the borders of the network area².

Table 5.1 – Base station site related parameters provided by the mobile network operator for modeling the network within the simulation tool.

Site Reference	Unique reference to distinguish different sites
Site Position	Coordinates in Universal Transverse Mercator (UTM)
Antenna Type	Reference for the type of antenna at the site ³
Antenna Height	Antenna height as measured from the ground
Antenna Bearing and Tilt	Direction each antenna points for both horizontal (azimuth) and vertical directions

5.1.1 Digital Maps

In addition to the location and configuration of base station sites, the simulation environment is further enriched with information about the area. Since antenna height is measured with respect to the ground, a Digital Elevation Map (DEM) provides further information about the elevation of the ground, with respect to sea level. Presented through a map with spatial resolution of 10 by 10 meters, this allows for the relative height of each base station antenna to be adjusted accordingly. A second similar map, referred to as Digital Land Use (DLU), or clutter map (Figure 5.1), categorizes the investigated area based on the type of terrain. By identifying a number of different terrain categories, this information is used to improve path loss predictions.

While the DLU and DEM provide information about the characteristics of the network area, a further map with traffic related information provides information on how traffic is spatially spread across the area. Referred to as Geo-Location Traffic Data Map, this is generated based on network measurements, providing information about the volume of HSDPA traffic carried over a given area on an hourly basis.

² Different than in chapter 4, an irregular mask is used to distinguish between sites in the area and those on the outside.

³ Reference to the antenna type allows for each base station antenna to being modeled with the actual horizontal and vertical pattern, and gain, associated to the real antenna product.

Considering the busy hour, the map is converted into a traffic density map, which is then used to spatially distribute active users over the network area.

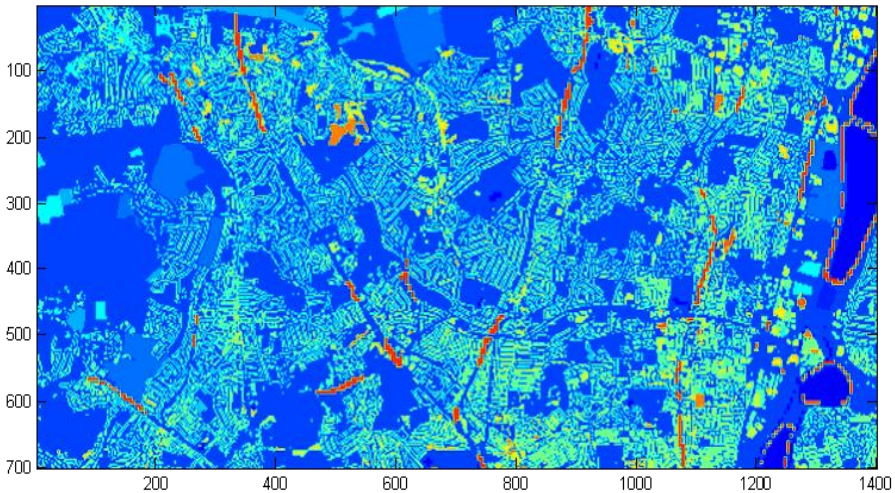

Figure 5.1 – DLU map for the sub-urban case study. With values on the axis representing an index for the pixels (10mx10m) different color shades represent different terrain categories.

5.1.2 Path Loss Model

For this sub-urban case, path loss (signal attenuation) for macro base station sites is predicted through the COST-231 Hata model (4.1) [105], which is further enhanced with the use of the above described DEM and DLU maps. Statistics from the DLU map, illustrated in Figure 5.1, show that 22% and 7% of the network area are categorized as sub-urban and urban respectively⁴. Users positioned within these regions are assumed as being located indoors, and are for this reason attributed an outdoor to indoor penetration loss, 20 dB for the urban cases and 10 dB for the sub-urban cases⁵. The remaining network area, predominantly outdoor, is composed of open spaces (44%), vegetation (26%), and roads (1%), with no penetration loss attributed to users located within these regions of the network area. Based on the transmission power, path loss, and received signal, the SINR for each user from

⁴ Categorization is based on a mixture of building types and density.

⁵ Agreed with the network operator, the difference in values for the penetration loss is a result of different overall structure types, with suburban cases composed of smaller buildings benefiting from additional rooftop penetration.

each base station site is calculated (as described in Section 4.2.1.4). Based this, the site resulting with the highest SINR is assigned as serving site. Figure 5.2 provides an overview of the link loss, and interference-to-noise ratio observed within the investigated area, with the latter highlighting a predominantly interference limited scenario, with only a small area being noise limited⁶.

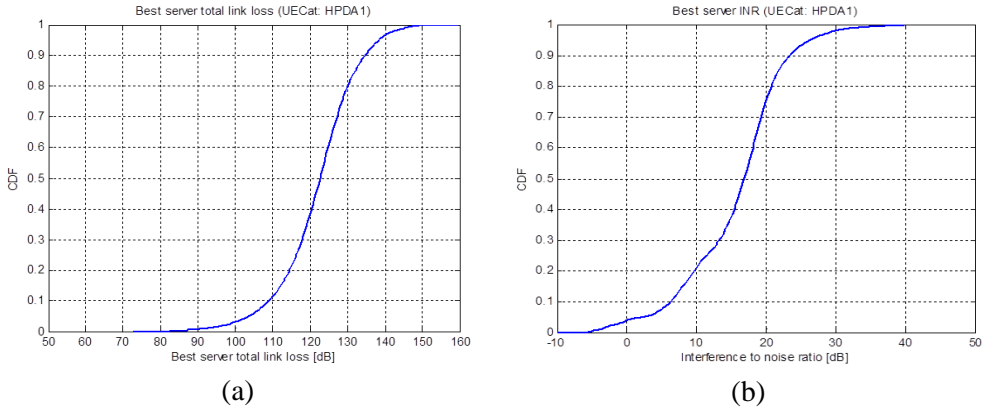

Figure 5.2 – CDFs providing an overview of the best server link loss (a) and interference-to-noise (INR) ratio (b) for the sub-urban case study.

5.1.1 Picocell Deployment

Some of the evolution strategies assumed for the sub-urban case study also consider the deployment of small cells, hereby referred to as picocells. For these cases, the simulation tool requires, as an input, a predefined value for the number of outdoor small cells. The locations of these picocells are determined through a meta-heuristic algorithm, referred to as SMART [106], which attempts to deploy picocells for minimizing the number of users in outage. After having simulated the network based on the macro layer, a number of locations are first selected based on network outage statistics and traffic/user density. Remaining picocells are deployed based on an iterative algorithm that shifts picocells through various locations, each time checking the impact that the new locations have on the performance of the network. Picocells are then deployed in the set of locations that provide the best performance [107]. The algorithm also includes limitations that consider the distance between the proposed location and neighboring macro sites and other picocells.

⁶ For areas in which the INR is greater than 3 dB, noise can be assumed to have negligible impact.

Since users are attributed to a serving base station site based on the SINR, it is noted that the deployment of picocells within a heterogeneous environment results in a small percentage of users being served by picocells. Even though the SINR for macro base station sites might be higher, available resources need to be shared among a larger number of users, limiting the achievable data rate further than if connected to a picocell with a lower SINR. For this reason, a bias, or ‘*range extension*’ [108], is introduced with the intension of pushing more users to the picocell layer, in the process also offloading some traffic from overlaying macro base station sites. For all cases with picocells, a bias of 3 dB is added, in favor of the picocells, to the calculated SINR.

5.2 Traffic Growth Forecast Model

The evolution of mobile networks is driven by the relentless growth in mobile broadband traffic. In order to investigate different evolution strategies, existing networks needs to be exposed to a forecast, or predicted, traffic growth, which is predominantly caused by two main factors. The first is an increase in number of mobile broadband subscribers/devices, often described by the term penetration rate. The second factor is the increase in traffic volume generated and consumed by each subscriber/device. With two overlapping radio access technologies (UMTS via HSPA and LTE) providing the experience of mobile broadband, in addition to predicting the overall traffic growth, this needs to be appropriately split over the two layers. Based on the existing traffic growth and operator-based expectations, a framework similar to the one presented in [109] is utilized for predicting traffic growth between 2011 and 2019. A similar traffic forecast model is also presented and described in [110].

With all traffic carried by the HSPA layer in 2011, it can be expected that following the rollout of LTE, a growing share of the traffic gets shifted onto this network layer. As this continues to increase, assumptions forecast that network traffic will be equally shared among the two network layers somewhere around the end of 2017. Two years later, the share of traffic carried by LTE is assumed to reach 40%. With regard to the overall penetration rate of mobile broadband, Figure 5.3 shows how this is assumed / expected to evolve, highlighting a 60% penetration rate for mobile broadband before the end of the decade. This is similar to some of the European predictions detailed within [111]. The figure also highlights how this is

split between the two network layers. Even though the penetration rate of HSPA is noted, after 2015, to decrease, the traffic increase on a per subscriber/device basis is assumed to keep traffic on this network layer at an overall stable growth. The average yearly increase in traffic per subscriber/device over the investigated time frame is that of 40% and 45% for the HSDPA and LTE network layer respectively.

Taking the various assumptions into consideration, the overall network traffic, over the investigated period, increases by a factor of 50. While it can be argued that this is either an aggressive or mild prediction, the assumptions leading to this growth have been agreed with the collaborating network operator. If compared over a shorter time frame, it is noted that up until 2015, the predicted traffic growth follows closely that predicted by Cisco's for the period 2011 and 2016. If the year-on-year traffic growth proposed by CISCO maintains itself, the traffic growth by the year 2019 would result in twice that predicted by the assumed model. This extension to the predictions made by CISCO is also included in Figure 5.4 [39].

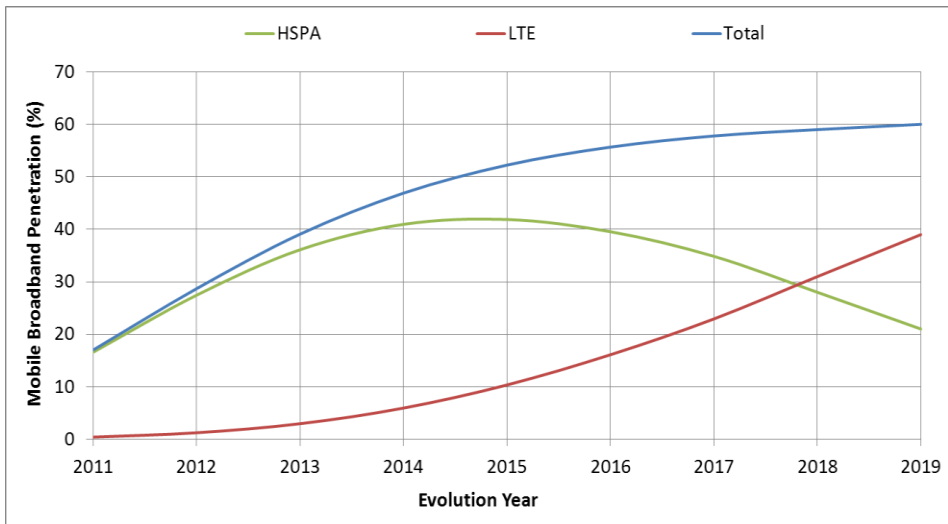

Figure 5.3 – Prediction for the evolution of mobile broadband penetration rate throughout the investigated period. This traffic forecast is based on an adaptation of [109].

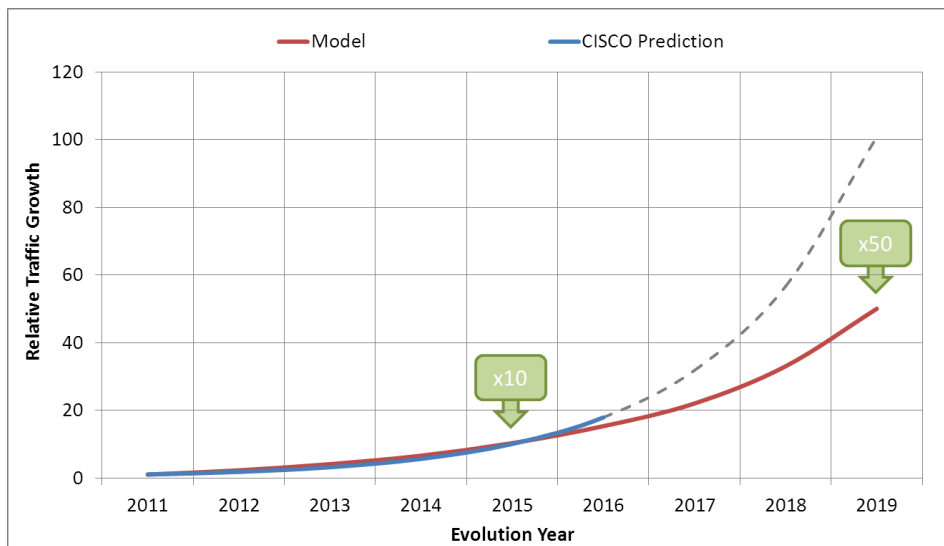

Figure 5.4 – Overall modeled traffic growth put into comparison with an extension of the current yearly traffic growth rate (78%) predicted by Cisco [39].

5.2.1 User Distribution and Network Performance

For each evolution year, simulations are carried out by placing a number of simultaneously active users within the network area. The distribution of traffic is based on a traffic density map, extracted from the geo-location traffic map during busy hour [107]. Based on traffic measurements this provides a good indication to the amount of traffic generated over the network areas considered. For the first year of the network evolution, the number of users to add to the network is extracted based on network (3G) traffic information. Based on the assumed traffic growth, traffic split between HSPA and LTE⁷, and increase in data rate per user, the number of active network users for each layer and evolution year is determined.

Similar to the investigation carried out in Chapter 4, all users deployed within the network are required to achieve a minimum data rate, with the performance of the network measured through the numbers of users that fail to achieve this minimum data rate (users in outage). For all network users, on both layers, this minimum data rate is set to 1 Mbps. With regard to the outage, this is increased from the previous

⁷ Simulations for the different layers (HSPA vs. LTE) are carried out separately.

5% to 10%, a value agreed with the operator, also in line within a recent document published by Ofcom [112].

5.2.2 Receiver Types and Considerations

The receiver performance and capability for different mobile device can vary. Based on type and quality of the employed transceiver, this impacts the overall link budget, with the device ultimately requiring more or less resources from the network to achieve a specific data rate. In some extreme cases, this can also result in a device being unable to connect to the network. Based on this, it is in the best interest of MNOs to populate networks with devices having high quality transceivers, more specifically receive diversity for HSDPA⁸, and 2x2 MIMO for LTE enabled devices. An overview of the assumptions for different receiver types, agreed together with the collaborating network operator, is presented and compared in Table 5.2. Through the evolution period receiver categories are selected in a way such that 61% of all 3G devices are assumed to employ receiver diversity. For the case of LTE, all devices employ receive diversity.

Table 5.2 – An expanded overview at how some of the parameters assumed for the different receiver types compare. The addition of these parameters improves or penalizes the potential data rate that a user can achieve. Seen from the network side, a better received results in fewer resources required.

Receiver Type	HSPA (2-Rx)	HSPA (1-Rx)	LTE (2-Rx)
Multi-User Gain	1 dB	1 dB	3 dB
SINR Loss	0 dB	2 dB	0 dB
Body Loss	2 dB	2 dB	2 dB
Effective Antenna Gain	0 dBi	-3 dBi	0 dBi

5.3 Evolution Strategies

Network evolution simulations for HSPA and LTE are carried out separately. With regard to the existing HSPA layer, the investigated upgrade strategies are required to support an assumed ten-fold traffic growth, predicted for the year 2015 (Figure 5.4). Assuming that LTE is deployed in 2012/2013, the objective for this network

⁸ While increasingly common, the *Motorola Droid Pro* is one of first few smartphones to employ receiver diversity.

layer is to support the traffic predicted for 2019, representing an overall traffic growth of x50. In this section the different evolution strategies considered for both HSPA and LTE layers and network areas are presented and described in further detail. While all are strategies are targeted to provide the same level of network performance, differences in power consumption and overall performance are later described in further detail.

For the HSPA network layer two main strategies are considered (Figure 5.5). These involve the upgrade of existing macro sites (reference) with additional carriers, and/or the further deployment of outdoor based picocells. From a spectrum point of view, the operator has available three adjacent carriers within the 2100 MHz band. The first assumed strategy (HSPA Case 1) is the upgrade of practically all but one macro sites to three carriers. However, early simulations show that with the predicted traffic growth assumed for 2015, the number of users in outage remains well above the minimum requirement of 10%. It is noted that due to the relatively high data rate per active user assumed, this outage is mainly caused by cell-edge capacity outage. For this reason, this evolution path is augmented further with the deployment of picocells. In order to determine the number of required picocells, this is gradually increased at regular increments of 20 picocells, with 60 picocells providing the sought network performance⁹. For this first case, picocells and macro sites are set to share one of the three carriers. In a second evolution case (HSPA Case 2), the lowest of the three carriers is dedicated to the picocells, forcing surrounding macros down to two carriers. Both of these cases are illustrated in Figure 5.5.

⁹ Even though the number of picocells is increased in relatively big steps, the network is still required to adhere to the predefined level of network outage. While the number of picocells could have been fine-tuned, the added complexity and simulation time would have resulted in little impact on the overall results.

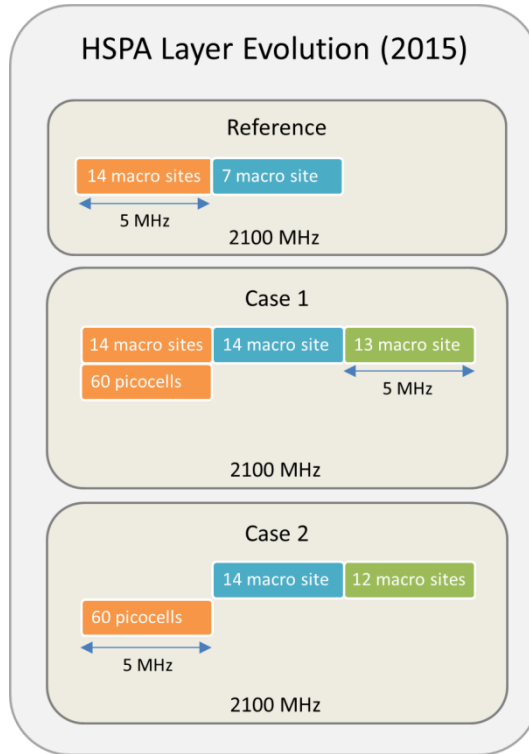

Figure 5.5 – Illustration of the two evolution strategies considered for the HSPA layer. Different colors represent frequencies, while different alignment indicates the difference layers.

In a first phase, the deployment of LTE is carried out by co-locating sites at existing HSPA macro base station sites. In order to maximize the initial coverage, and since the operator owns 10 MHz of the spectrum within the 800 MHz band¹⁰, this is the assumed initial (reference) setup. While LTE traffic remains relatively low for the first few years, this picks up rapidly from around 2015, following which, a number of capacity upgrades are necessary to ensure that the outage level remains within the required 10% mark. For LTE, network capacity upgrades are carried out for the expected traffic in 2019. Additional capacity is added to the LTE layer by exploiting the 20 MHz of spectrum available in the 2600 MHz band. The assumed cases for LTE are illustrated in Figure 5.6.

¹⁰ Assumed LTE bands are typical for European based operators.

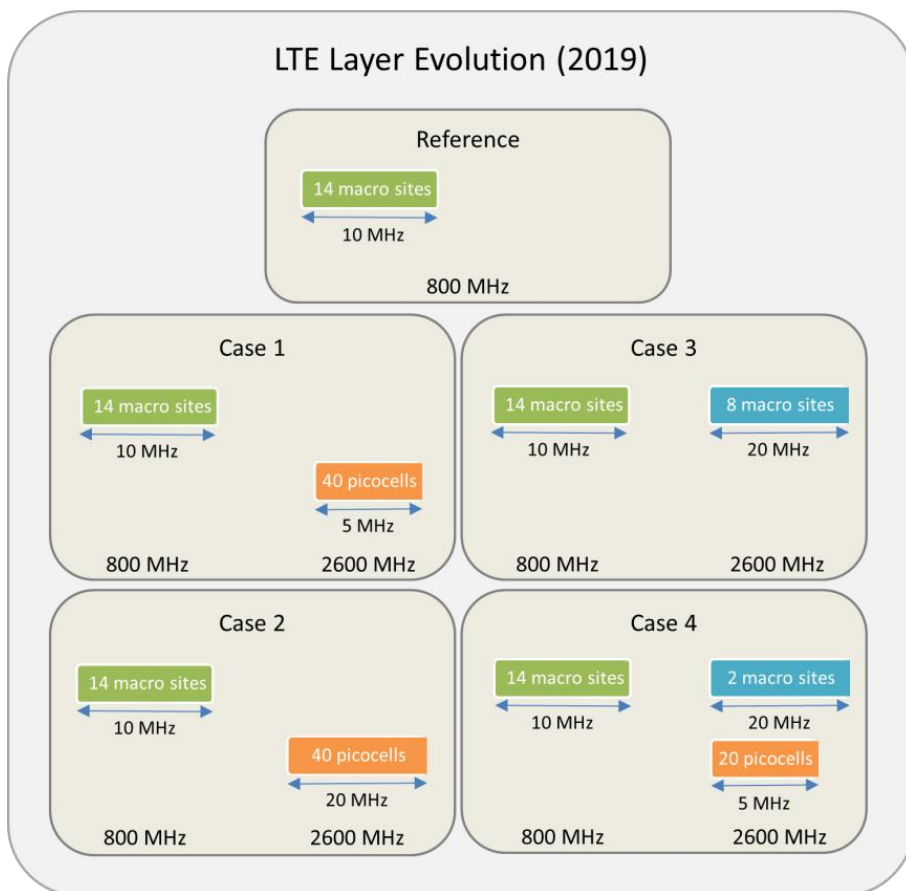

Figure 5.6 – Assumed network upgrade strategies for the LTE layer of the network. The network is upgraded to ensure that in 2019 it can handle a total traffic growth of x50.

The first case assumes the deployment of picocells in the ‘undisturbed’ 2600 MHz band. Since these can be deployed over a variable bandwidth, the impact of both 5 MHz and 20 MHz cases are considered¹¹. The third case considers a macro-only upgrade approach, upgrading a majority of the sites, around 60%, with an additional 20 MHz of spectrum. The last case (LTE Case 4) is a hybrid solution, assuming the upgrade of two macro sites, together with the deployment of picocells, both in the 2600 MHz band.

¹¹ This mainly impacts the performance since as noted earlier, the power models do not cater for differences in LTE bandwidths.

For LTE cases considering both 800 MHz and 2600 MHz band, the implemented user access control attempts to maximize the number of users that achieve the minimum data rate. Based on the estimated SINR and the bandwidth assumed for both frequency bands, users are allocated in a way that attempts to balances the load between the two frequency bands.

5.4 Power Consumption Assumptions

As described in Section 3.3, the assumed transmission power for HSPA enabled sites is that of 20 watts (43 dBm) per 5 MHz carrier. Since LTE sites are assumed to operate over double or four times the bandwidth (10 MHz or 20 MHz), the total transmission power assumed is doubled to 40 watts (46 dBm). Since 2x2 MIMO is the default assumption for LTE, this power is equally split among the two transmission chains (Figure 3.9). For cases considering the deployment of picocells, a transmission power of 1 watt (30 dBm) per picocell (single carrier) is assumed. Similar to previous studies, a full load scenario is assumed, implementing the same radio resource allocation presented in Section 4.2.1.5.

After confirming that an evolution strategy meets the predefined performance requirements, site specific configurations and network statistics are extracted from the simulation tool and imported to the dedicated network power consumption excel-based tool¹². At this stage, in order to isolate variations in power consumption as a result of the different evolution strategies, the impact of site equipment and upgrades is neglected. This is achieved by assuming that all sites are equipped with the same version (2008) equipment. In addition, all macro sites are assumed to incur a 3 dB feeder cable loss. For picocells a similar loss of 1 dB is applied. The impact of replacing equipment and the upgrade to RRH is presented in Section 5.6. Taking the same assumption as that set for the simulations, all sites are assumed to run a full load.

¹² A tool that incorporates the different energy models described earlier in a centralized place, allows for a greater flexibility in changing equipment related parameters.

5.5 Network Evolution Results

A summary of results for the HSPA and LTE network layer are presented in Table 5.3 and Table 5.4 respectively. For both of the reference cases¹³, it is noted that the assumed increase in traffic pushes the percentage of users in outage way past the minimum requirement of 10%. With the percentage of users in outage being the main network performance measure, it is noted that all of the assumed evolution cases are able of restoring the outage to within the desired levels. For the two HSPA cases it is noted that both perform similarly in terms of average network and user throughput. For the former, it is noted that for HSPA Case 1 an improved network outage (8%) also results in an average network throughput that is 12% higher¹⁴.

Table 5.3 – Results for the HSPA evolution cases for the sub-urban scenario. For the case of energy efficiency, measure in joules/Mbit, a lower number indicates an improved efficient.

HSPA Evolution Cases	Outage	Av. Network TP (Mbps)	Av. UE TP (Mbps)	Relative Power Consumption	Relative Energy Efficiency
Reference	33%	187	2.7	1.00	1.00
HSPA Case 1	8%	462	4.7	2.35	0.95
HSPA Case 2	10%	411	4.8	1.95	0.89

For the case of LTE, the assumption of having different evolution paths exploiting a variable amount of the bandwidth on the 2600 MHz band results in a wider variation of throughput values. This is especially noted for the two cases considering the deployment of the same number of picocells but over different bandwidths, 5 MHz for LTE Case 1 and 20 MHz for LTE Case 2. Even though both result in the same percentage of users in outage, under the assumed full load conditions, the added 15 MHz of bandwidth result in an average network throughput that is 167% higher.

¹³ Reference cases assume the existing (default) network with no upgrades under the same expected (future) traffic conditions.

¹⁴ Even though all cases are aimed at providing the same performance, capacity quantization results in the deployment of more capacity than actually required.

Table 5.4 – Summary of results showing how the four LTE upgrade cases compare with the reference case. The most energy efficient case is noted to be the one that consumes most energy.

LTE Evolution Cases	Outage	Av. Network TP (Mbps)	Av. UE TP (Mbps)	Relative Power Consumption	Relative Energy Efficiency
Reference	27%	497	1.7	1.00	1.00
LTE Case 1	9%	1256	4.0	1.66	0.66
LTE Case 2	9%	3350	10.0	1.66	0.25
LTE Case 3	10%	1026	2.9	1.57	0.76
LTE Case 4	9%	899	2.5	1.47	0.81

5.5.1 Power Consumption

With regard to the power consumption, it is noted that while the more aggressive strategy for HSPA (HSPA Case 1), results in an improved performance, in terms of outage, this also impacts the resulting power consumption of the network. In comparison to the reference, this evolution case increases the power consumption of the network by 135%. In comparison, the second network evolution case for HSPA achieves similar performance results with an increase in power consumption of ‘just’ 95%. A comparison for the increase in power consumption (HSPA) and how this is split between the different site configurations is presented in Figure 5.7.

The above figure clearly highlights the impact of three carrier upgrades on the power consumption of the network area. Had a three carrier upgrade been sufficient to meet the performance requirement, this would have resulted in the option that draws least power. This would also result in the most practical solution, requiring for no further site (small cell) deployment.

In comparison with the evolution cases considered for the LTE network layer it is noted that the overall increase in power consumption for the HSPA layer is relatively higher. This is mainly due to the fact that for the HSPA layer, the two upgrade cases considered involve far more extensive upgrades. In addition to this, the LTE layer remains underutilized for a good portion of the considered evolution period, up until traffic picks up and upgrades are necessary. This can also be noted by the observed outage of the reference cases, with the LTE layer (with no upgrades) observing 27% of users in outage, as opposed to the 33% for the HSPA case.

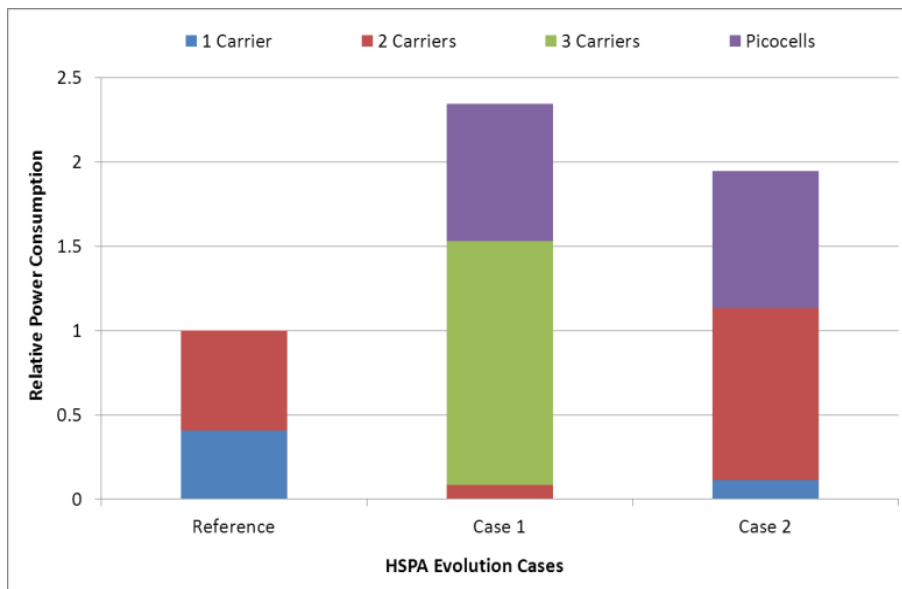

Figure 5.7 – Relative power consumption values for the two HSPA network evolution cases, relative to the reference (existing) network. Values are split between the different site types.

For the LTE layer it is noted that the network evolution strategy that consumes least power is the hybrid case (LTE Case 4), with the power consumption increasing by 47%. By considering the energy efficiency for the different LTE cases results show that the case consuming least power is also the least energy efficient. Even though the same power model is assumed for the LTE sites with different bandwidths¹⁵, of interest is the impact that a wider bandwidth assumed in LTE Case 2 has on the overall energy efficiency of the network. While this case is noted to improve the energy efficiency of the network by 75%, the case consuming least power (LTE Case 4) improves the energy efficiency of the network by almost 20%. This can be noted in Table 5.4. Similar to the previous figure, a split of the power consumption between the different site configurations for the LTE network layer is presented in Figure 5.8.

¹⁵ A change in bandwidth is only expected to have a limited impact on the power consumption of the site. Nonetheless, this provides room for future improvement to the power models.

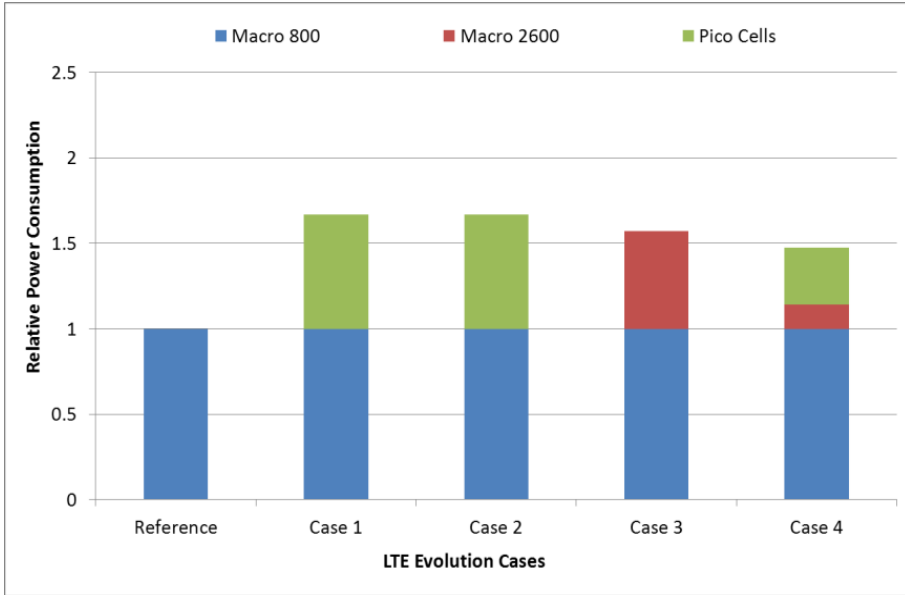

Figure 5.8 - Power consumption values for the LTE network evolution cases, relative to the reference network. The comparable values are presented as a split between the different site types.

5.5.2 Network Evolution Trade-Offs

In addition to the potential of reducing power consumption, mobile network operators are also required to consider the practical and financial implication of the different network evolution paths. When considering such aspects, even more challenging is estimating the costs of deploying picocells, or any other small cell variant, with many more practical issues playing a role in the overall cost structure. A factor often mentioned within the topic of heterogeneous networks and small cells is backhaul [113] [75], which depends heavily on the existing infrastructure owned by the operator. In addition to this, if the operator decides to heavily deploy small cells, it is automatically required to deal with, setup and maintain many more individual sites. This means that even though the studies clearly demonstrate that a hybrid solution consumes less energy, in reality, the extent to how many small cells can be effectively deployed could (in some cases) require for a compromise between solutions that are more practical and fit better with the existing network infrastructure. Once again it is important to stress that this is very specific for each operator and area being considered.

5.6 Impact of Different Equipment Versions

Up until this point, the chapter has looked at a number of network evolution strategies for increasing the capacity of an existing network layout by a factor of x50. In order to fairly compare the power consumption of the assumed strategies, the impact of sites running different equipment versions is not included. Instead, all sites are assumed equipped with the same version (2008) of base station equipment. In addition to this, all macro sites are assumed to incur a 3 dB feeder cable loss.

In reality, as a network evolves, mobile network operators (MNOs) continuously upgrade and replace equipment, introducing in the process, added capacity and possibly introducing further functionalities [36]. At the same time, the replacement and phase-out of equipment also reduces the range of base station equipment that needs to remain supported by the operator¹⁶. If not forced by any necessary upgrades, equipment within base station sites is also assigned a predetermined lifetime¹⁷, the duration of which depends on a variety of criteria [36]. The gradual upgrade and replacement of equipment ultimately results in mobile networks running a range of different equipment versions.

In order to get an overview of how the mixture of different equipment versions impacts the power consumption trend of mobile networks, this investigation is added to the sub-urban case study. Based on nationwide statistics for the considered network, it is noted that the sub-urban category makes up for more than 60% of the overall power consumption, making it a good candidate for the analysis of equipment replacement [114].

Focusing on the presented sub-urban case study, the network evolution strategies that result in the lowest increase in power consumption (HSPA Case 2 and LTE Case 4) are selected for sustaining the x50 predicted traffic growth. In comparison to the original HSPA reference network, the rollout of LTE in 2012/3, together with all of the necessary upgrades are noted to increase the power consumption of the network by a factor of four, or 300%. Three instances from the evolution period are

¹⁶ In order to maintain a growing range of equipment versions, MNOs are also required to retain the necessary expertise and vendor support to service the equipment.

¹⁷ Through discussions with a representative of a major European operator, it is suggested that the lifetime of base station equipment often oscillates anywhere from eight to ten years.

presented in Figure 5.9, highlighting this increase in power consumption and how this is split between the two assumed network layers.

5.6.1 Assumptions for Equipment Replacement

Within the evolution period, a total of five different equipment versions are considered. These are the first five (left-to-right) versions presented earlier in Figure 3.12. In the reference HSPA network layout, half of the sites are only equipped with a single carrier. These sites are assumed to have remained ‘intact’ from the original rollout of the network. The rest of the sites, equipped with two carriers, are assumed to have come at a later stage, either through new site deployment or the upgrade of existing sites to further boost capacity. With the availability of 2006 and 2008 equipment, it is assumed that these sites share these equipment versions at 60% and 40% respectively (Figure 5.10).

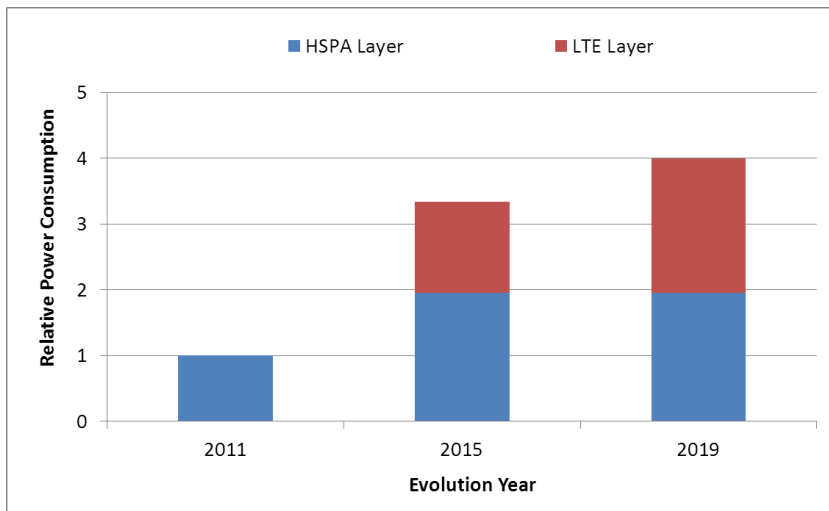

Figure 5.9 – Overview of how the power consumption of both HSPA and LTE network layers (sub-urban case) increases with the assumed upgrades.

With the rollout of LTE expected for 2012/3, it is assumed that these sites are equipped with the 2008 version of the equipment. In the year 2015, all first and second generation equipment (2000 and 2006) is removed from the network. When upgrading existing macro sites and/or deploying picocells (for both network layers), these are always carried out using the most recent equipment version available. A graphical representation of this replacement strategy is presented in Figure 5.10.

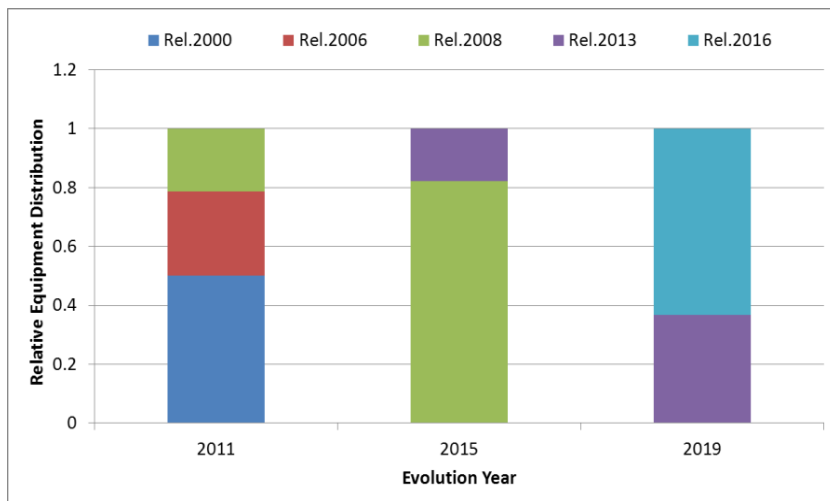

Figure 5.10 – Overview of how network equipment is assumed to be distributed between the different versions over the assumed evolution period.

5.6.2 Network Power Consumption Trend

By considering the equipment replacement strategy described above, and the power factors described earlier in Table 3.1, the overall power consumption of the network area is still noted to increase. In comparison to the previous stated 300% increase, this replacement strategy limits the increase in power consumption to around 70%. As depicted in Figure 5.11, the reduction from 300% down to 70% is impacted by both old equipment versions, which consume more power, and new (more efficient) equipment versions.

Up until this point, the impact of cooling on the power consumption of base station sites has not been considered. Since cooling can make up a considerable portion of the power consumption [27], the investigation is extended further by also considering that the older equipment version (2000) is also affected by an extra 30% of power consumption attributed for maintaining the site cool. This increases the power consumption of the original network further, limiting the overall increase in power consumption to 57%. An overview of the impact that different assumptions have on the power consumption of the network area is summarized in Table 5.5. In order to also gauge the extent to which power consumption can be reduced, a best case scenario is included. While still including a cooling factor of

30%, this scenario assumes that all of the sites are replaced to the latest available base station equipment version.

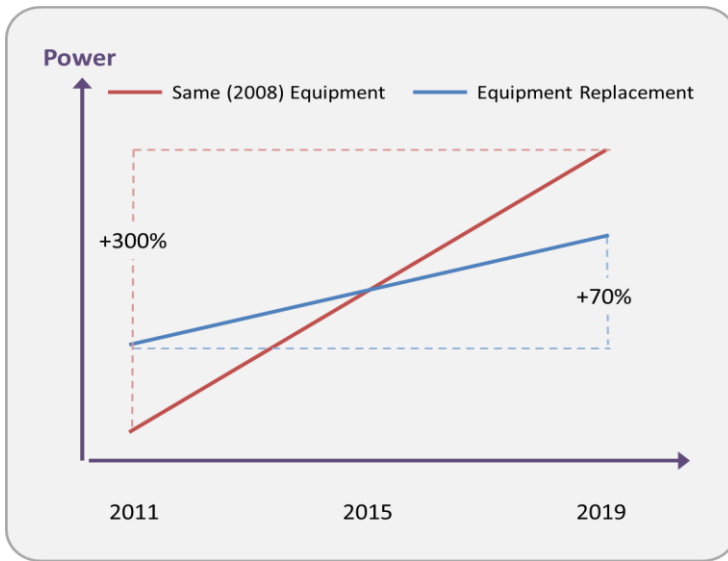

Figure 5.11 – Representative illustration on the impact that including older and newer equipment has on the overall power consumption growth within the network.

Table 5.5 – Summary of the extent to which the power consumption for different equipment replacement strategies increases over the assumed period.

Equipment Replacement Scenario	Increase in Power Consumption (2011 to 2019)
No replacement (2008 version only)	300%
Assumed replacement scenario	70%
Including 30% cooling for 2000 version	57%
Full equipment replacement in 2019	35%

5.6.1 Further Site Upgrades to Remote Radio Head

Throughout this chapter it is assumed that all macro sites incur a 3 dB feeder cable loss. By relocating the RF module in close proximity to the antenna, the upgrade of sites to RRH limits this loss. For such sites, a resulting loss of 1 dB is assumed. While some network operators have already started the transition to upgrade sites with RRH, this is primarily being done to increase the effective transmission power from the antenna, improving in the process indoor coverage of the area. Alternatively, as described earlier, reduced losses can be exploited to reduce the transmission power of the RF module, maintaining the same effective transmit

power at the antenna. The latter option is assumed and added to the previous equipment replacement strategies to quantify the impact that upgrading sites to RRH has on the power consumption trend of mobile networks.

When it comes to upgrading sites to RRH, it can be argued that from a practicality point of view, the upgrade of some sites might be hindered. This can either be due to the site layout, regulations, existing agreements with site owners, and/or some other external factors. For this reason two cases of RRH upgrades are assumed, considering a full network (100%) or 75% of all sites. Table 5.6 shows how the assumed sub-urban case study is affected by the upgrade of macro sites to RRH.

While carrying x50 more traffic, results show that under the assumed conditions of a full equipment replacement strategy and upgrade to RRH, the power consumption of the network is still noted to increase by 17%. Within a previous chapter it is argued that the expected penetration and importance of small cells could result in the technology and power consumption of such sites to evolve at a faster rate than for macro sites. The investigation is taken a step further to determine the improvement necessary, in power consumption of picocells, to offset the remaining increase in power consumption. The power consumption assumed for picocells, on both network layers, is reduced until the overall consumption of the network in the final year is equal to that in the first year of the evolution. This is noted to occur when the power consumption of picocells improves by around 40%. At this point, an existing network is upgraded to support substantially (x50) more traffic while at the same time consuming the same amount of power.

Table 5.6 – Impact of RRH on the power consumption. Two different RRH deployment factors are assumed, also considering a realistic limitation to the extent of the upgrade.

Equipment Replacement Scenario	Increase in Power Consumption (2011 to 2019)		
	No RRH	RRH at 75% Sites	RRH at All Sites
Assumed Replacement Scenario	70%	53%	47%
Including 30% cooling for 2000 version	57%	42%	37%
Full replacement in 2019	35%	22%	17%

5.6.2 Network Energy Efficiency

Prior to assuming a reduction in the power consumption of picocells, all cases are noted to still result in an overall increase in power consumption. While desirable to

have a net reduction in the power consumption of mobile networks, of interest is the overall evolution of the network from an energy efficiency perspective. Figure 5.12 shows how the relative energy efficiency of the network (measured in Joules per Megabit), evolves over the investigated time period. Important to highlight that lower values represent less energy necessary to transmit the same volume of data, hence denoting an improvement in energy efficiency.

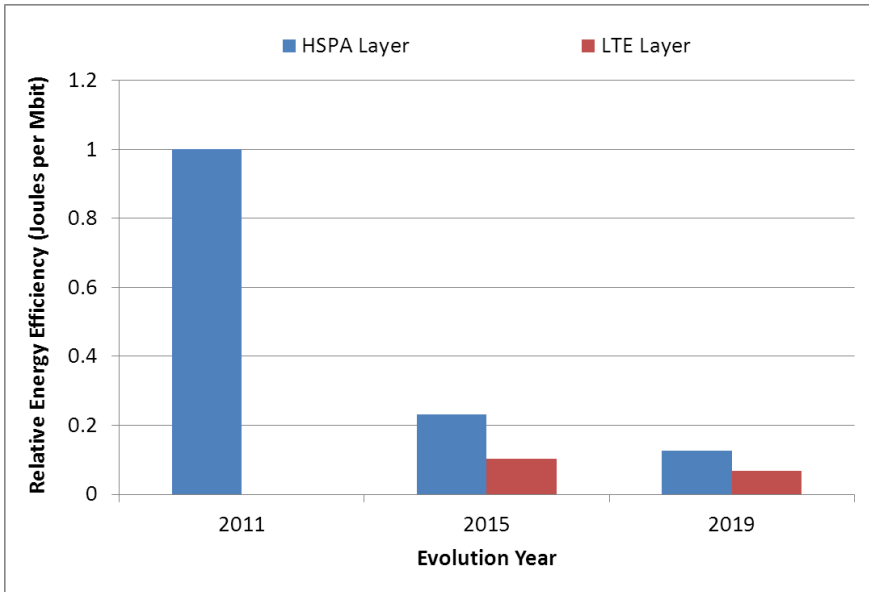

Figure 5.12 – Relative energy efficiency (energy per Mbit) for both layers against the reference HSPA layer. These energy efficiency figures are extracted from the final network assuming a reduction in power consumption for picocells (balancing out power consumption).

Put in comparison with the power consumption and network throughput of the reference HSPA network, assuming the same equipment replacement and upgrades considered up until this point¹⁸, the figure clearly highlights the considerable improvement in energy efficiency. Focusing on the HSPA layer, it is noted that over the eight year period considered, the network is capable of transmitting a unit volume of data while consuming almost 90% less energy. In comparison with HSPA, it is also noted that the improvement in energy efficiency for the LTE layer, the two instances considered, is relatively less. In addition to LTE being more

¹⁸ This refers to having a full equipment replacement, full upgrade to RRH, and the improvement in picocell power consumption to bring about a status-quo in the power consumption of the network over the considered evolution period.

efficient, the difference is mainly due to the old equipment assumed for HSPA in the first year of the evolution period. This makes even for a stronger argument on the importance of phasing out and replacing old base station equipment.

5.7 Conclusions

This chapter has presented a detailed look of how the power consumption for a suburban area is expected to evolve over an eight year period. By considering different upgrade strategies for HSPA and LTE, the performance and power consumption of a number of strategies are compared. In addition to this, the chapter also considers one evolution strategy for each network layer and extends the study to also include the impact of replacing old base station equipment and upgrading macro sites with RRH.

In the first section, both network layers are upgraded to ensure that the network can sustain an overall traffic growth of x50. Based on this a number of different evolution strategies are assumed. Results show that for the HSPA network layer a hybrid solution that involves the upgrade of additional macro sites to two carriers together with the deployment of picocells (out-band) is the option, from the ones considered, that meets the required performance criteria while consuming less power. A similar trend is noted for LTE, with the hybrid macro upgrade and picocell deployment solution performing best.

Since mobile network operators own and manage networks with different equipment versions, the impact of replacing old base station equipment is also considered. An assumed replacement strategy is noted to limit the increase in power consumption for the evolution of the network from 300% down to 70%, which is further reduced to 35% in a best case scenario. By also adding the potential savings of upgrading existing sites to RRH, this is reduced to 17%, highlighting the substantial gains possible by replacing and upgrading base station equipment.

5.7.1 Take-Away Points

The take-away points section is intended to present the main outcome of the chapter in a few straight to the point statements. For this chapter the take-away points are:

- For both HSPA and LTE network layers a hybrid upgrade solution is more suitable for limiting the increase in power consumption.
- Replacement of old equipment and upgrade of sites to RRH can provide substantial reductions in power consumption.
- Even though the power consumption trend is still likely to point upwards, the overall noted gains in energy efficiency are significant.

6. Power Consumption Trend - A Dense Urban Case Study

6.1 Introduction

In addition to the sub-urban evolution case study, presented extensively in Chapter 5, network data available allows for a further study. Originally intended to provide an alternative perspective for different network evolution strategies, a dense urban case study is also considered from a power consumption perspective. Focused on a hotspot area, the details and outcome of this study are hereby presented in further detail. While the method of extracting network related information, traffic growth forecast, and the overall simulation process is identical to that carried out for the sub-urban case, details and differences in the scenarios, models, and evolution strategies, are hereby presented. Rather than providing an optimized (quantitative solution), the objective of this chapter is to determine the most energy efficient upgrade strategy within a hotspot area, highlighting also the impact that small indoor cells can have on the rest of the network.

6.2 Scenario and Model Description

The dense urban case is based on an area of the network within the city center of a major European capital. After disregarding surrounding sites, for mitigating border effect, the resulting area measures approximately 13 km². A higher user density within this area is accompanied by a higher density of macro base station sites. Situated at an average ISD of around 340 meters, the area is covered by a total of 39 macro sites, the majority of which are equipped with two 5 MHz HSPA carriers [114]. Even more than the previous case (Figure 5.2), this is a heavily interference limited scenario with the interference-to-noise ratio greater than 4 dB for all of the network area.

Based on traffic statistics, it is noted that approximately 40% of all traffic within this area is consumed within two relatively small hotspot areas [114], clearly identified in Figure 6.1. In order to evolve the capacity of the network within such high capacity areas, a more localized solution is required. For this reason, network upgrades for the dense urban case also consider the deployment of indoor small cells, mainly femtocells. In addition to this, the deployment of Wi-Fi Access Points (APs) is also considered as an option to boost network capacity indoors¹. In order to differentiate further from the sub-urban case, this section focuses on one of the two traffic hotspots, restricting the investigation area to about 1.3 km², covered by a total of four dual carrier macro base station sites. This also allows for the simulations to consider building related information within the area, further improving the assumptions and models. A more detailed view of the hotspot area can be noted in Figure 6.2.

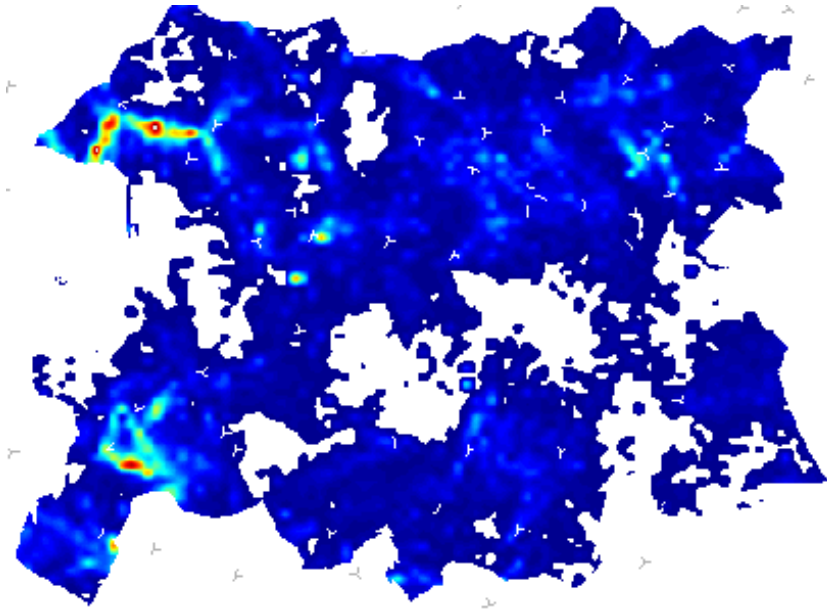

Figure 6.1 – Spatial traffic density map extracted from the geo-location traffic data for the dense urban area. The two traffic hotspots are clearly visible, with the top left selected for the study.

¹ In addition to serving users with high data rates, small cells can also offload parts of the traffic from overlaying macro sites, increasing the amount of resources available for other users.

6.2.1 Path Loss Models

The availability of 3D building models and DEM allow for path loss predictions to be estimated through ray-tracing, carried out for the different frequency bands assumed. This provides for a more reliable value than the empirical model assumed for the sub-urban case, with the ray-tracing tool calibrated against network measurements. Within the investigated hotspot, around a third of the area is covered by buildings, with a total of 915 buildings. Varying in height, with some buildings having up to 26 floors, the average number of floors is four [107] [114]. While signals from macro base station sites are assigned an outdoor-to-indoor penetration loss of 20 dB, a floor gain of 3.4 dB per floor is added. This means that a user located at a higher floor experiences a higher received signal than another located on lower floors. This trend is also confirmed through a recent measurement campaign, detailed in [115].

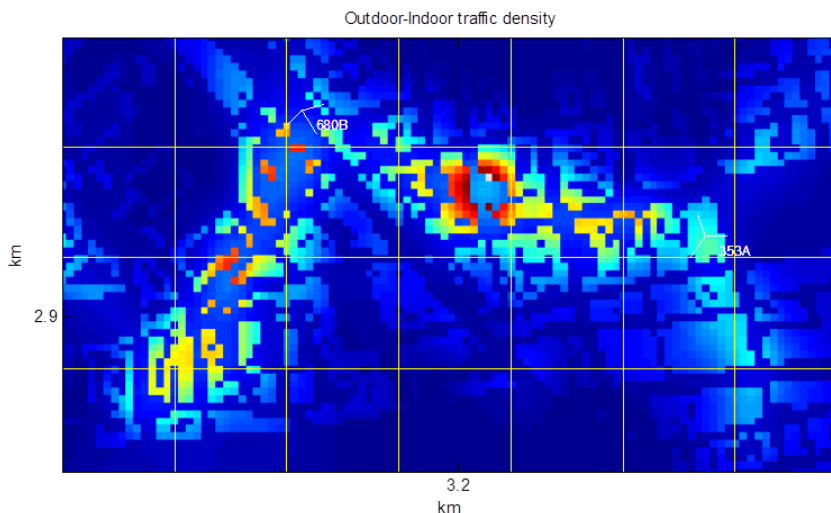

Figure 6.2 – Closer view on the hotspot area selected for the investigation. To note also that in this case, a building map is superimposed on the traffic density map highlighting further the contours of the various buildings and streets within the area.

While ray-tracing provides the path loss predictions for the outdoor environment, a dedicated empirical indoor propagation model is assumed for indoor areas (6.1). After considering the 20 dB penetration loss of the outdoor signal ($L_{Penetration_Loss}$) and a floor height gain (G_{Floor_Gain}), the model attenuates the signal further by applying an attenuation factor (α) of 0.6 dB per meter of indoor distance travelled

by the signal [98]. An illustration of the path loss models for the dense urban hotspot case is presented in Figure 6.3.

$$Path_LOSS_{Indoor} = L_{Penetration_Loss} - G_{Floor_Gain} + [\alpha * distance] \quad (6.1)$$

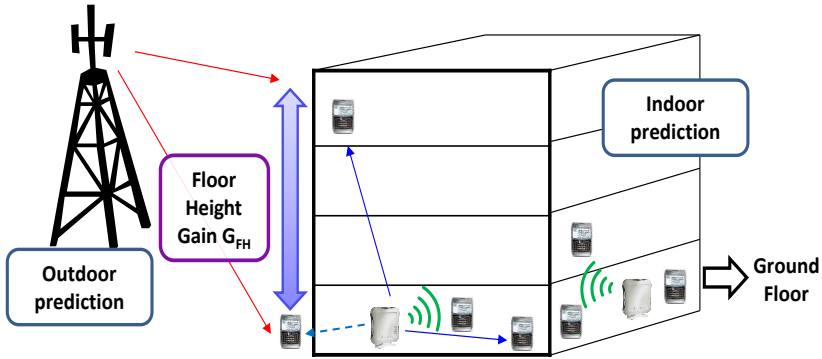

Figure 6.3 – Illustration for the path loss models for both an outdoor and indoor (multi floor) environment. Figure extracted from [107].

6.2.2 Distribution of Outdoor and Indoor Users

When distributing users within the network, a specific parameter defines whether the user is located outdoor or indoor. Statistics [57] suggest that a majority of mobile data traffic is generated indoor. Based on this 70% of all users deployed in the dense urban hotspot area are assigned as indoor users. Furthermore, since the modeling of indoor regions provides a third dimension for the height of the building, users are also distributed along all of the available floors. It is assumed that half of the indoor users are deployed at the ground level, a factor also highlighted in Figure 6.3. This is based on the assumption that since the area is predominantly commercial (based on the area of the city and traffic profile), most businesses such as shops, hotels, and other establishments are likely to concentrate users at the ground level. The rest of the users are equally distributed along all of the remaining floors.

6.2.3 Small Cell Deployment

Network evolution cases that involve the deployment of outdoor picocells, these following the same SMART deployment algorithm described earlier in Section 5.1.

On the other hand, the deployment of femtocells is purely traffic drive deploying femtocells in accordance to the generated traffic density map. In addition to this, femtocells are assigned a 3 dB range extension bias and are assumed to operate in an Open Subscriber Group (OSG) scheme. This means that access to the cell is based on the perceived SINR and is not limited to a registered subset of users. Based on the previous assumption that half of the users are assumed located on the ground floor, the deployment of femtocells is only limited to this ground level (Figure 6.3).

Also assumed as OSG, the deployment of Wi-Fi Aps is carried out following the same traffic driven approach. The latter is based on the 802.11g standard (2.4 GHz – ISM band), with radio resources modeled through the Bianchi's model [116]. A policy for steering traffic between Wi-Fi and the cellular network is also included. This states that if a user detects a Wi-Fi AP, a connection is established to the AP only if an SINR value of least 6 dB [117] can be achieved². The overall modeling and assumptions are presented in further detail in [117].

6.3 Evolution Strategies

Traffic growth for this area is assumed to follow the same trend presented earlier, with a relative growth of x10 and x50 for the years 2015 and 2019 respectively. With an already very dense macro network, the further deployment of macro sites is highly impractical, from a performance (high interference), and practical point of view. For both network layers, upgrade strategies involve various combinations of outdoor and indoor solutions. All upgrade strategies assumed for the HSPA network layer are illustrated in Figure 6.4. The reason for considering more evolution strategies is based on the fact that more layers and upgrade options are available, resulting in a higher number of potential options.

Even though three carriers are available, small cells are in all cases assigned a dedicated carrier, thus reducing interference and improving performance in terms of outage. When deploying picocells it is noted that on average around 10 picocells

² In reality, Wi-Fi APs would be deployed together with other user deployed APs and systems that operate on within this frequency band. While not modeled, exterior interference on the ISM band is more difficult to estimate and account for, with this issue recently tackled in [103].

per macro site are required. In the case of deploying picocells and femtocells (HSPA Case 2), these are assigned to share the same 5 MHz band of dedicated spectrum.

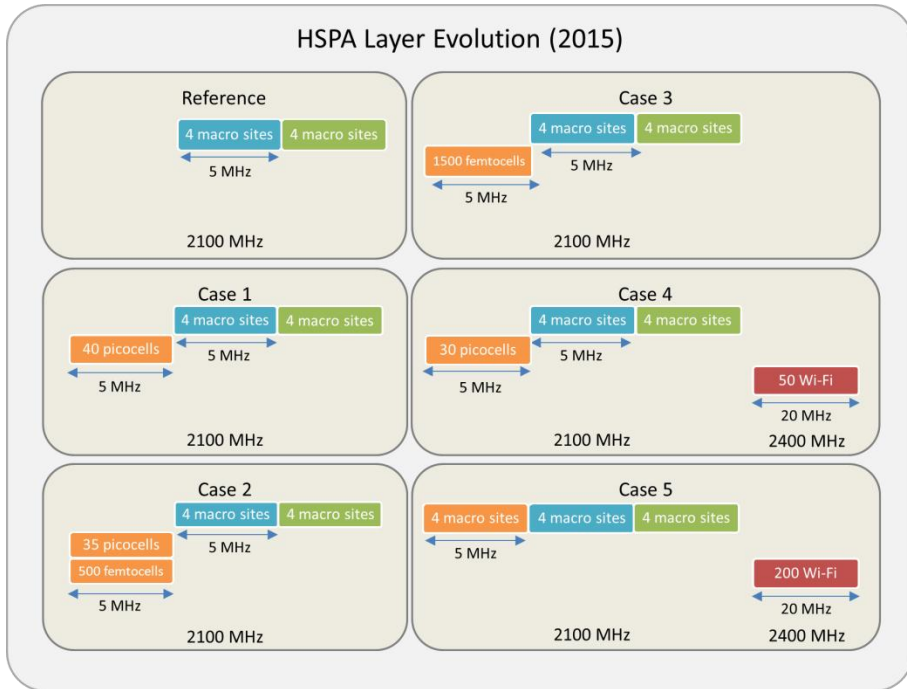

Figure 6.4 – Evolution cases investigated for the HSPA layer within the selected hotspot area. These are required to support a ten-fold traffic growth up until 2015.

After assuming for the rollout of LTE in 2013, the evolution of this network, described in Figure 6.5, is carried out on the 2600 MHz band. For the cases considering multiple upgrades within this band, previous studies [107] show that if the available band is split orthogonally (10+10 MHz), fewer upgrades are required to meet the same outage level. This split in spectrum is assumed for all cases involving macro upgrades and the deployment of small cells.

6.4 Power Consumption Assumptions

For the macro network layer, the same models and assumptions presented in the sub-urban case hold. When considering the deployment of indoor small cells, this

scenario creates two possible options. If deployed within the premises of the user, power consumption and related costs are automatically shifted from the MNO to the user. While this can be the case, the work presented in this thesis is focused on the power consumption of the network, irrespective of the type and location of sites. Nonetheless, since the thesis is mainly targeted towards MNOs, a small side note on the potential impact of this is also included.

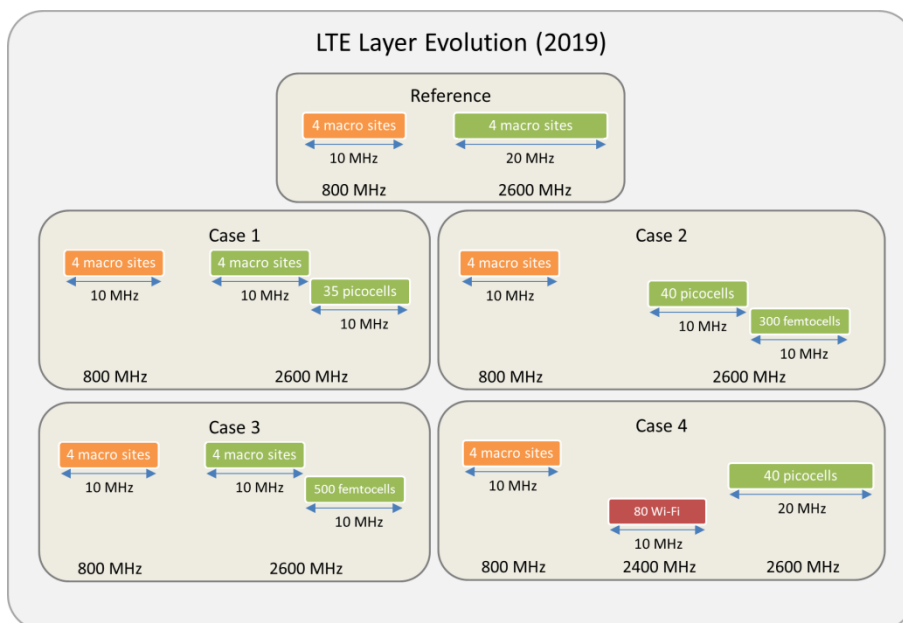

Figure 6.5 – Four evolution cases investigated for the LTE layer within the hotspot area.

6.5 Network Evolution Results

The outage for the reference cases of both layers are noted at 61% and 42%, for HSPA and LTE respectively. In contrast to the sub-urban case, it is noted that two of the upgrade cases, one from either network layers, did not meet the minimum performance requirement. With outage levels at 15% and 12%, for HSPA Case 1 and LTE Case 2 respectively, it is assumed that some form of network optimization and/or traffic steering techniques can assist in reaching the required 10% level. For this reason these cases are still included and compared with the remaining cases, all of which deliver a performance that is within $\pm 1\%$ of the target value. All results for

both cases are summarized in Table 6.1 and Table 6.2 for the HSPA and LTE cases respectively.

Table 6.1 - Results for the HSPA evolution cases for the dense urban (hotspot) scenario. For the energy efficiency, measure in joules/Mbit, a lower number indicates an improved efficient.

HSPA Evolution Cases	Outage	Av. Network TP (Mbps)	Av. UE TP (Mbps)	Relative Power Consumption	Relative Energy Efficiency
Reference	61%	77	0.5	1.00	1.00
HSPA Case 1	15%	354.2	2.3	2.60	0.57
HSPA Case 2	11%	631.4	4.1	2.86	0.35
HSPA Case 3	11%	831.6	5.4	2.37	0.22
HSPA Case 4	10%	446.6	2.9	2.35	0.41
HSPA Case 5	10%	785.4	5.1	1.91	0.19

Table 6.2 - Summary of results showing how the four LTE upgrade cases compare with the reference case.

LTE Evolution Cases	Outage	Av. Network TP (Mbps)	Av. UE TP (Mbps)	Relative Power Consumption	Relative Energy Efficiency
Reference	42%	334.8	0.6	1.00	1.00
LTE Case 1	10%	1171.8	2.1	2.02	0.58
LTE Case 2	10%	4966.2	8.9	1.87	0.13
LTE Case 3	12%	5635.8	10.1	1.33	0.08
LTE Case 4	10%	1953	3.5	1.77	0.30

On a first glance, it can be noted that for all cases involving the deployment of femtocells, the average network throughput is noted to be considerably higher than the other cases. For LTE, the two cases with femtocells result in an average network throughput that is more than three times that of the remaining cases. While to a lesser extent, a similar higher average network throughput is also noted for all of the three cases involving the deployment of Wi-Fi APs.

An overview to how users in outage are split between the different site types, it is noted that prior to applying the 3 dB range extension bias, practically all of the outage can be attributed to macro base station sites (Figure 6.6). Even though the user experiences a higher SINR, resources have to be shared among many more users, increasing the level of user outage further, than if allocated to a neighboring

small cell. For the LTE Case 1, it is noted that the impact of having picocells deployed on a dedicated carrier, and applying range extension, results in 63% of all users served by picocells. Similar trends and values are noted in all cases with small cells. While the shift of users from macro sites to small cells reduces the outage of macro sites, the increase in outage on the small cell layer still remains below 3%.

Statistics from the results also highlight how outage users are distributed between indoor and outdoor locations. It is noted that anywhere between 60% and 80% of all users in outage are located indoor. This, together with the fact that most outage is associated to macro sites, highlights how the deployment of small cells does not completely resolve indoor related issues. Figure 6.6 provides a simplified graphical interpretation of how, even after deploying small cells, with range extension, most of the outage remains allocated to macro sites and indoor users. This occurs since the low transmission power of small cells limits access to a relatively small area. In addition, the random placement of users can result in users being placed out of the reach of deployed small cells, requesting more resources from an already loaded macro site. In order to test what balances the outage between outdoors and indoors, thousands of femtocells are required, ‘filling-up’ a large portion of possible user locations.

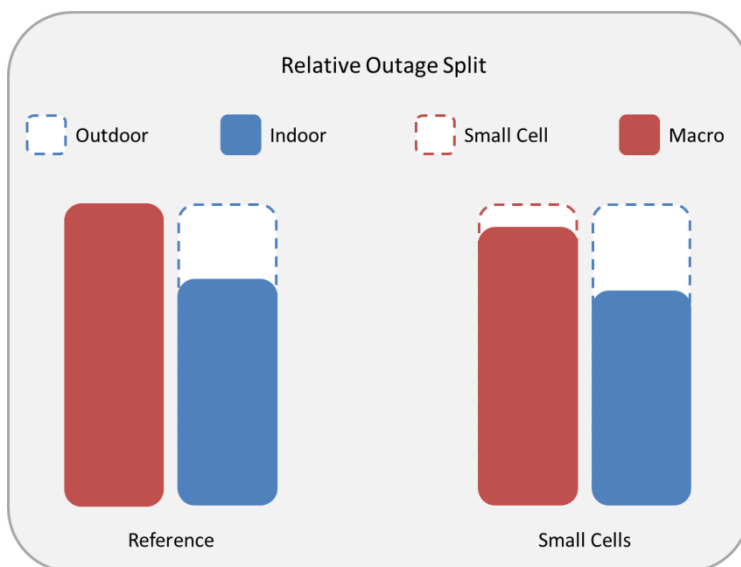

Figure 6.6 – A simplified graphical overview of how the outage is split between macro sites and small cells, and indoors and outdoors.

6.5.1 Power Consumption

With regard to the power consumption it is noted that for the evolution of the HSPA layer, the hybrid case with macro upgrades to three carriers coupled with Wi-Fi is the case that consumes least power. With respect to the reference case, this increases the power consumption of the network by 91% (Figure 6.7).

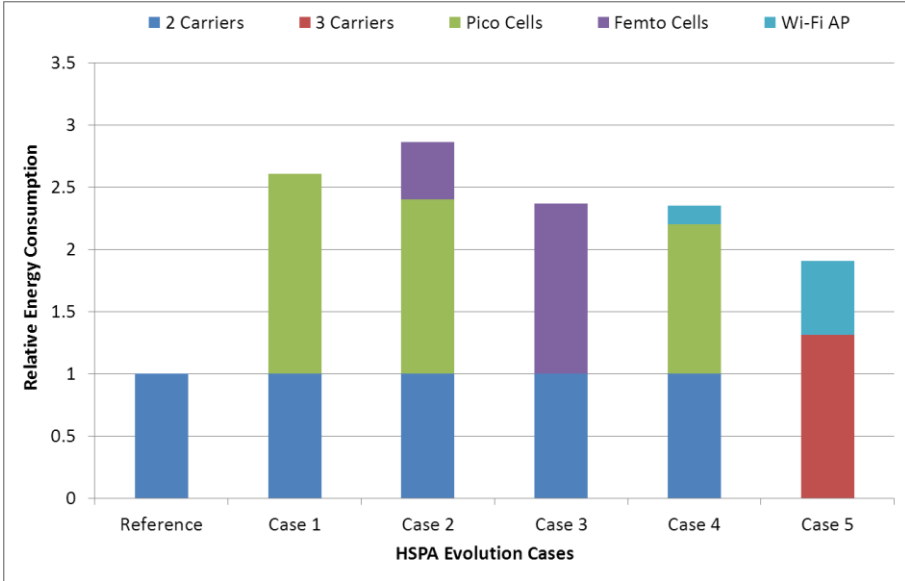

Figure 6.7 – Breakdown of the energy consumption for the HSPA evolution scenario.

Following the two cases with femtocells, it is the HSPA Case 3 that consumes least power, involving the massive deployment of 1500 femtocells. This case is even more attractive if the power consumption of femtocells, deployed indoors, can be disregarded, resulting in a massive capacity boost at no extra power (assuming that the power consumption of femtocells is shifted onto the subscribers). For all cases with picocells, it is noted that the overall power consumption attributed to these small sites makes a hefty portion (~50%) of the overall power consumption. The power consumption of all of the HSPA cases is broken down into the different site types and presented in Figure 6.7.

For the power consumption of the LTE network layer, the breakdown of which is illustrated in Figure 6.8, the hybrid solution with macro upgrade and femtocells (LTE Case 3) is noted to be the one consuming least power. With respect to the reference case, the proposed upgrade results in a 33% increase in power

consumption. The figure also highlights that wherever picocells are deployed, these (again) make up a considerable portion of the overall power consumption. This certainly highlights the potential savings if the power consumption of small cells, more specifically picocells, improves considerably over the coming period. A reduction in power consumption per picocell of at least 46% would allow for LTE Case 2 to result in the same power consumption as that for LTE Case 3.

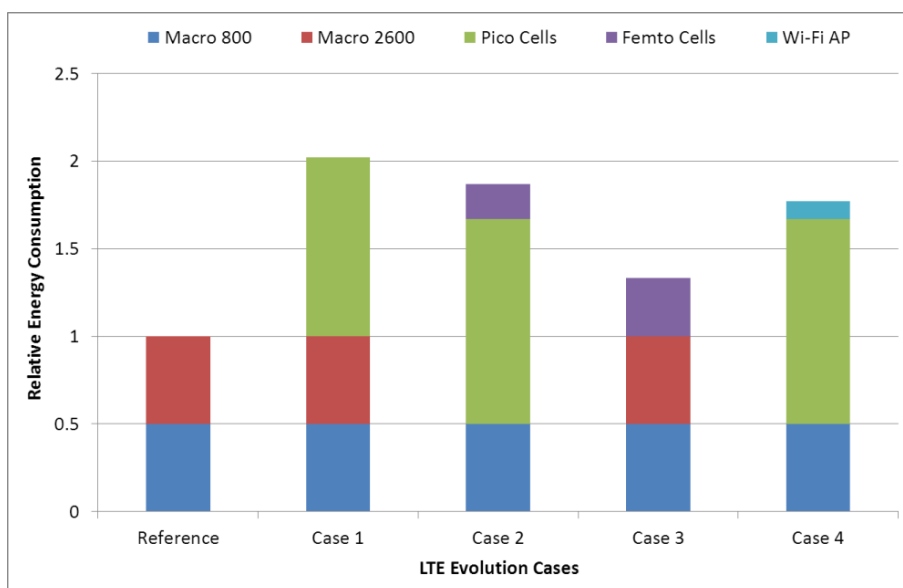

Figure 6.8 – Overview of how the energy consumption for the different LTE evolution strategies.

When considering the energy efficiency, it is noted that in addition to being the case that consumes least power, LTE Case 3 is also the case that is most energy efficient. In order to transmit a unit of data, the resulting LTE network is noted to consume 92% less energy (Table 6.2). Similarly, the evolution strategy that consumes least energy for the HSPA network layer reduces the energy required per unit volume of data (Table 6.1) by 81%.

6.5.2 Network Evolution Trade-Offs

While some of the practical and financial concerns expressed in the previous chapter also apply for indoor based small cells, the vast deployment of such cells still poses a serious challenge in managing and coordinating their deployment and operation. This becomes more of an issue when considering the deployment of

domestic-based femtocells, whereby subscribers themselves are ‘deploying’ and locating these small cells. If uncoordinated this could lead to further interference related challenges. In addition to this, if an OSG scheme is adopted, the operator has to determine and organize how backhaul (assumed through an xDSL or cable) can be adequately shared, and whether any related costs (energy included) for having surrounding users using a domestic based femtocell can be shared. Furthermore, this chapter also highlights how most of the users in outage are often allocated to macro base station sites and located indoors, highlighting the need for including smarter access schemes that push more users onto small cell.

6.6 Conclusions

By steering the evolution analysis towards a hotspot area within a dense urban section of the network, this chapter investigates a wider range of possible evolution strategies. By also considering the deployment of indoor small cells, this allows for a comparison of both options for scenarios with high traffic densities.

For both network layers, solutions involving the deployment of indoor small cells are noted to consume less power than alternative strategies that also consider the outdoor variant of such cells. For the HSPA case, this is achieved through the deployment of 200 Wi-Fi APs, or 50 per macro base station site, together with the upgrade of all sites to three macro carriers. Assuming that Wi-Fi is not a viable option, then from a power perspective, the solution with femtocells is still noted to consume less power than that with picocells. For the case of LTE, a hybrid upgrade strategy involving the deployment of four macro sites in the 2600 MHz band and 500 femtocells is noted to consume least power.

6.6.1 Take-Away Points

The take-away points section is intended to present the main outcome of the chapter in a few straight to the point statements. For this chapter the take-away points are:

- Outage is caused by indoor users connected to outdoor base station sites with many users. Smarter access scheme, or bias, is required.
- The hybrid upgrade of macro sites together with the deployment of indoor small cells is recommended for areas with high traffic densities.

- Indoor small cells provide high data rates, offload surrounding macro sites, and reduces the amount of upgrades necessary on the macro layer.

7. Power Saving Features

7.1 Introduction

While a power efficient network evolution and equipment replacement provides a more predictable and long-term saving, there exist other features/methods for further reducing the consumption of mobile networks. These, the implementation of which is predominantly software-based, often exploit variations in network traffic (Figure 7.1) and/or redundancies within the network, resulting in power savings that fluctuate over a given period of time. While such features can be enabled in networking elements throughout, this chapter maintains focus on base station sites, highlighting a number of potential methods for reducing the power consumption, and improving the overall energy efficiency, of mobile broadband networks.

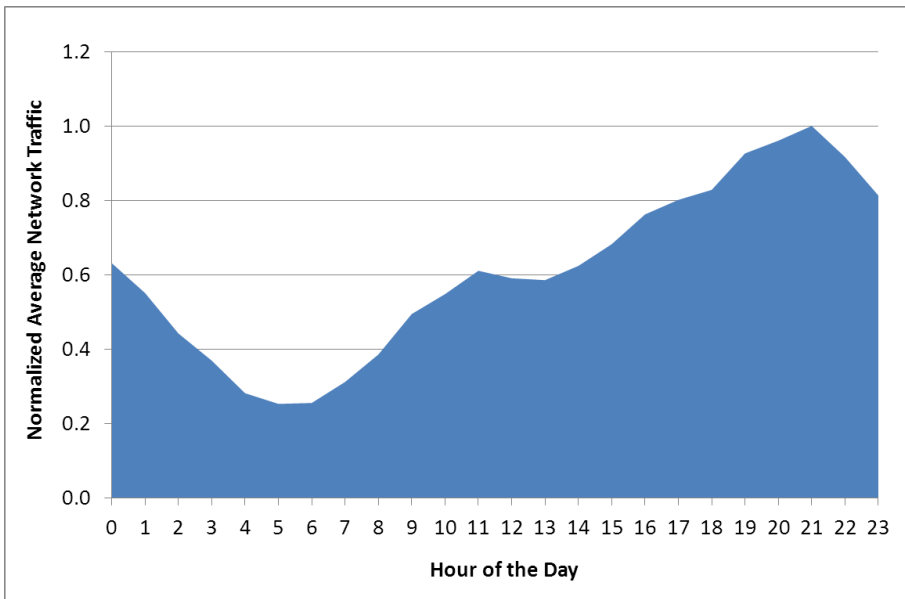

Figure 7.1 – Traffic statistics from a live network (Telenor) [43] showing typical daily variations within an urban area [118]. Of major interest is the considerable decrease in traffic during night time, which can be exploited for some of the recommended power saving features.

7.2 Base Station Sleep Mode

References to green radio, power savings, and energy efficiency, within a mobile networking environment, are often accompanied by a number of potential solutions. Among these, a frequently mentioned feature is site sleep mode (sometimes also referred to as site switch off). The attractiveness of sleep mode is based on the fact that the power consumption of base station sites is only weakly correlated to the load (also noted in measurements in Appendix A). The premise is that during hours with low traffic, the feature can trigger base station equipment into sleep mode, eliminating also the load independent portion of the power consumption [32] [119]. Based on the type of site, equipment configuration, and capabilities, different variations of sleep mode can be adopted. Depending on how the feature is implemented, together with its set aggressiveness, often provides some form of a trade-off between power savings and network performance, the later which may directly impact the perceived user experience.

After introducing and describing different variations of sleep mode, a set of early studies¹ are presented and described in further detail. Rather than optimizing each of the proposed features, the intention of these studies and this section is to provide an indication towards the potential of each variation. While most of the cases are applied and assumed within a homogeneous macro environment, a second section (Section 7.2.3) also considers and investigates the impact of sleep mode within a heterogeneous network. All of the simulations are based on the same network planning tool described in the previous chapters. Given the ongoing collaboration at the time of each individual study, different sleep mode variations are investigated onto different networks. While difficult to directly compare quantitative results, the relative savings for the different scenarios is enough to provide an indication to the applicability of each variant.

7.2.1 Different Flavors of Sleep Mode

This section presents a quick run-down of the different variations of sleep mode that can be exploited to further reduce the power consumption of mobile broadband networks, identifying benefits, limitations, and a best use practice for each. For all

¹ Even though presented at this point within the thesis, most of the studies have been carried out over the first years of the study.

of the presented cases, sleep mode is assumed to require a centralized overview and controlled transition (possibly at the RNC or Radio Network Controller, for 3G networks) between the active and sleep state². This allows for any connected users to be gradually handed over to neighboring sites and/or other Radio Access Technology (RAT) layers. An option for achieving this transition is through a reduction in the transmit power [120], gradually forcing users to handover to neighboring sites. The trigger to put a site into sleep mode can be based on the load of a specific site, or group of sites, within a common location area (LA). The load of each site can then be compared to a predetermined threshold, the selection of which determines the aggressiveness of the feature. Sensing for, and triggering, a wakeup mechanism is deemed more complex [121], requiring for the network to instantly react to a possible unpredicted surge in traffic.

- Site Sleep Mode

Probably the most basic and effective form of sleep mode is to implement it to the entire site (Figure 7.2). Affecting all sectors, this allows for most of the site equipment to be put into sleep mode. In the case of co-located sites, in which the same location is used to host multiple RATs, if the site architecture³ allows for it, sleep mode can be applied to one or multiple network layers. In order to avoid impact on the coverage footprint of the network, site sleep mode is mainly recommended for capacity enhancing sites [122], generally applicable for areas with a high density of base station sites (dense urban areas).

- Sector Sleep Mode

Since the load of base station sites is often unbalanced between the different sectors, sector sleep mode can provide some added flexibility, enabling for individual sectors to be put into sleep mode. The unbalanced nature of traffic between different sectors is also identified through a site measurement campaign, described in further detail in Appendix A. While some restrictions may result from the configuration and capability of the installed site equipment, sectors may be put into sleep mode by disengaging one or more transceivers. Since some equipment may be shared among all sectors, this may limit the overall savings of this mode.

² Similar functionalities can exist for LTE, with functionalities hosted within other central elements.

³ Since modern equipment can support multiple standards, the use of such equipment may in some cases limit the flexibility and potential savings sleep mode.

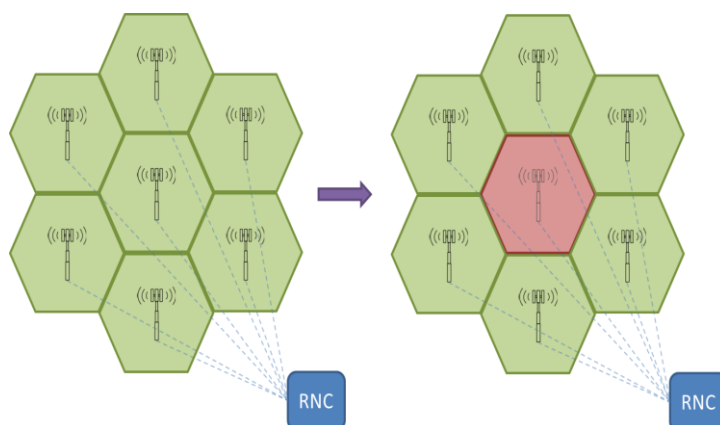

Figure 7.2 – Graphical representation for site sleep mode. A centralized RNC monitors the load of various sites and based on preset conditions gradually execute sleep mode for selected sites.

- Sleep Mode of Capacity Enhancing Features

During hours in which added site capacity and features are no longer required, these can also be put into sleep mode. For macro base station sites, these include the installation of additional carriers and/or MIMO. The potential savings of implementing a feature like sleep mode depends on the site equipment, configuration, and the flexibility it provides. In the case of MIMO, disabling the feature would half (in the case of a 2x2 configuration) the number of transceiver chains. Even if the transmission power on the remaining transceiver chain is doubled, this would still provide a power saving of almost 35% per site.

Base station sites operating multiple carriers also provide the possibility of reducing the number of active carriers, primarily during hours with low network traffic. Base station measurements (Appendix A) demonstrate that traffic is often concentrated onto one of multiple carriers, providing an opportunity for enabling sleep mode on one (or more) the remaining carriers (Figure 7.3). The extent of savings can vary depending on the equipment installed, and whether multiple carriers are within the same frequency bands, making this feature very case specific and more difficult to generalize.

The advantage of putting capacity enhancing features into sleep mode, as opposed to the entire site, is that this still ensures that the site maintains its original/intended footprint, requiring less or no network optimization during the transition towards and out of sleep mode.

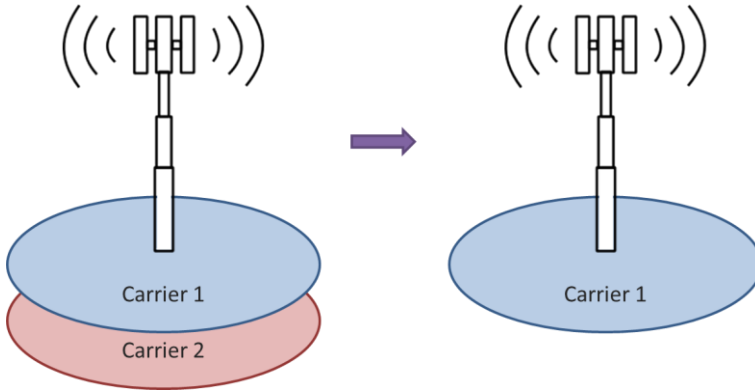

Figure 7.3 – Enabling sleep mode for one or more carriers allows for the site to maintain its existing coverage footprint.

7.2.2 Sleep Mode for Macro Base Station Sites

Up until recently [123] a number of studies highlighting the potential of site sleep mode [124] keep appearing in conference and journal contributions. In the first years of this research project, the availability of a real network topology and the ability to apply power models that consider the consumption as seen by the operator provided an opportunity to investigate and quantify the impact of site and sector sleep mode. While referring to the original contributions, the detail to which each study is described is, within this section, limited. Nonetheless, sufficient information is provided to understand the type of scenario, sleep mode algorithm, and conclusions extracted from the presented results.

For the first case, an existing macro-only HSPA network is used to investigate the impact of site and sector sleep mode. Since the study is carried out at an earlier stage of the research, results [125] have been updated to consider the latest versions of the power model, described earlier throughout Chapter 3.

7.2.2.1 Network Scenario

The network layout considered for this investigation consists of an irregular single carrier HSPA network for a specific European mobile network operator. Based on an area of about 8 km², the network section is composed of 30 three sector sites, with an average intersite distance (ISD) of 430 meters. Downlink based static

system level simulations are carried out through the same network planning tool, assuming a pure⁴ COST-231 Hata (4.1) propagation model described earlier.

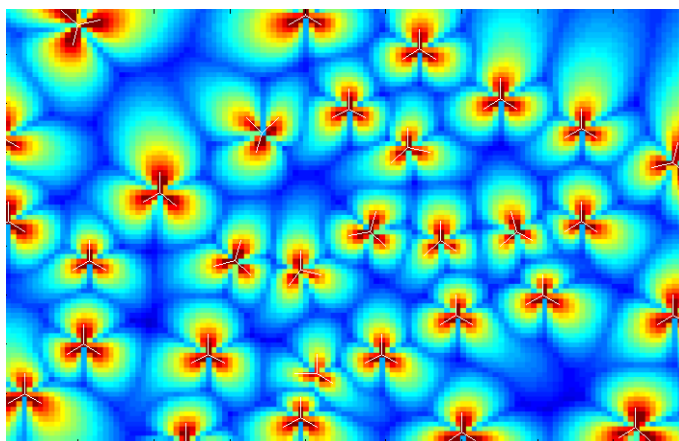

Figure 7.4 – Base station site layout for the site and sector sleep mode. Given the irregularity of the network, and the impact that enabling sleep mode can have, this highlights the importance of considering such cases for the study.

Similarly to other cases, network performance is measured through percentage of users in outage, with this case assuming a required minimum data rate of 256 kbps and an outage of no more than 5%⁵. Not having a predetermined number of concurrently active users to add to the network, an increasing number of users are added, until a point when the outage reaches the 5% mark. This represented the maximum number of users, or full load, that the network could support, for the assumed performance criteria. To note that users are distributed in accordance to a traffic density map based on sector specific traffic statistics. Within each sector traffic is uniformly distributed.

The traffic profile for the existing network, based on sector level traffic statistics, is used to split traffic into two categories, high and low traffic. Assuming a normalized network traffic profile, the average traffic load for the network over a 12 hour (high) period is 90%. For the remaining hours, an average traffic load (low) of 51% is noted and assumed. These traffic load factors are used to scale the number of concurrently simulated users added to the network. Assuming a full buffer traffic

⁴ No clutter maps are considered for tuning the propagation of transmitted signals.

⁵ Even though the sleep mode algorithm is designed to avoid any major impact on the outage, this is still used as a measure to determine its effectiveness.

model, network resources are shared following the same two-step radio resource allocation algorithm presented in Section 4.2.1.5.

The feature of sleep mode, carried out on both sector and site level, is only assumed enabled for the duration of the low traffic period, 12 hours. For this analysis, the ‘bare’ power consumption model is considered, omitting the impact of feeder cable loss and cooling from the equation. For the case with sector sleep mode, the power consumption model is simplified by dividing the power consumption of the site for each of the sectors, scaling down the power based on the number of active sectors. In the original analysis [125], sleep mode is assumed to consume no power (ideal). While these results are still presented, a further sensitivity analysis is added to include the impact of residual power consumption. This refers to the power consumption of the site when sleep mode is enabled.

7.2.2.2 Site and Sector Sleep Mode Algorithm

The diagram in Figure 7.5 provides a high-level overview of the implemented sleep mode algorithm. After adding the selected number of users, the first part of the radio resource allocation is carried out. During this part, sufficient resources are distributed to each of the users to achieve the minimum requested data rate. Prior to the second phase of the resource allocation algorithm, which distributes remaining resources in a round robin fashion, the load for each sector is noted. This is estimated based on the percentage of resources that have already been distributed (Figure 7.6). To note that when considering site sleep mode, the load is estimated as an average of all available sectors.

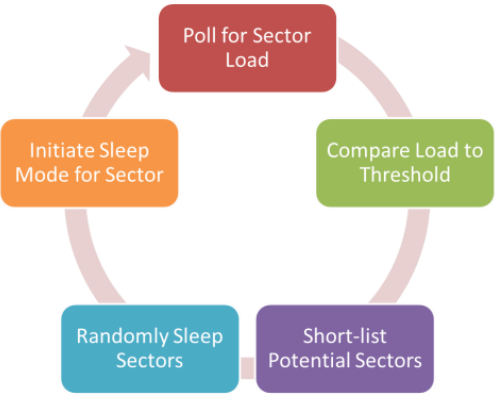

Figure 7.5 – Sector sleep mode algorithm. The transition of individual site/sectors into sleep mode reduces impact on coverage and ensures that network performance is maintained.

A threshold, the selection of which determines the aggressiveness of the feature, is selected⁶. As depicted in Figure 7.6, if the load of a sector or site is below this predetermined threshold, then this gets shortlisted for sleep mode. Since sleep mode of a single sector impacts the load of neighboring sites, the transition into sleep mode is carried out in a controlled and gradual fashion. For this reason, the algorithm randomly selects a single site or sector and puts it into sleep mode. As neighboring sites pick up the slack, the load for each sector is polled again, generating a new sleep mode shortlist. This is repeated until no sites or sectors are shortlisted. After identifying the sites or sectors to put into sleep mode, these are deactivated and the remaining sites simulated in the regular (full load) manner.

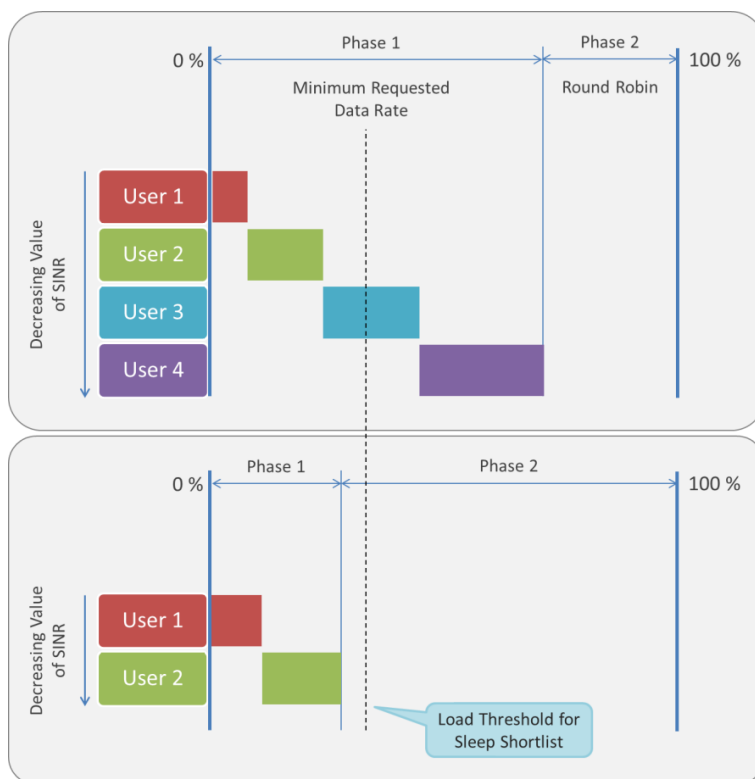

Figure 7.6 – After the first phase of allocating resources, the resulting load is compared with an assigned load threshold, determining (if phase 1 is terminated before the threshold) whether a site or sector can be shortlisted for sleep mode (lower case).

⁶ Selection of this threshold value is based on a number of iterations, identifying a point that still enables sleep mode while at the same time maintaining performance.

Within itself the algorithm limits its impact on the number of users in outage. Depicted also in the results below, this is achieved by only selecting low loaded sites (through threshold selection), ensuring that neighboring sites can adequately pick up the generated slack. If greater savings are required, the threshold could be moved further to the right increasing the number of sites or sectors put into sleep mode, increasing however the likelihood of neighboring sites being unable to deliver the required data rate to all of the now served users.

7.2.2.3 Results

Prior to enabling the feature of sleep mode, simulations are carried out to determine the performance of the original (reference) network for the two assumed traffic categories. The results, summarized in Table 7.1, clearly highlight how during hours with less traffic (fewer users), the implemented radio resource allocation provides an improvement in the average user throughput and outage.

Table 7.1 – Summary of results for the reference case, assuming the original network layout with all sectors active for the two assumed traffic categories.

		All Sectors Active (reference)		
Traffic Category	Number Traffic Hours	Sectors in Sleep Mode (%)	Average User Data Rate (kbps)	Outage (%)
High	12	0%	400	4%
Low	12	0%	534	3%

For the cases implementing the feature of sector and site sleep mode, it is noted that 45% and 23% of the sectors respectively are put into sleep mode (for low traffic). The results for both of these cases are presented in Table 7.2. When considering the performance of the network in terms of outage, both site and sector sleep modes are noted to maintain the same level of outage, at 3%. Even though the feature of sleep mode is implemented, the improvement from the original 4%, obtained with the assumed high traffic, is a result of having fewer users within the network requesting the predefined data rate. On the other hand, when considering the performance in terms of average user data rate, sleep mode is noted to have a negative impact. With respect to the reference case (all active) during low traffic conditions, the average user data rate is noted to reduce by 25% and 12% for the sector and site sleep mode cases respectively.

Table 7.2 – Summary of the results for both of the investigated cases of sleep mode, highlighting the impact of the feature on the performance and overall daily energy saving.

		Sector Sleep Mode		
Traffic Category	Number Traffic Hours	Sectors in Sleep Mode (%)	Average User Data Rate (kbps)	Outage (%)
High	12	0%	400	4%
Low	12	45%	400 (-25%)	3%
Daily Energy Saving		22%		

		Site Sleep Mode		
Traffic Category	Number Traffic Hours	Sectors in Sleep Mode (%)	Average User Data Rate (kbps)	Outage (%)
High	12	0%	400	4%
Low	12	23%	472 (-12%)	3%
Daily Energy Saving		12%		

In order to determine the savings introduced by the feature, this is measured by comparing the energy consumption of the network area over a 24 hour period. For the reference case, the network is assumed to be running at full load for the entire 24 hour period. When comparing this to the cases with sleep mode, enabled over a 12 hour period, it is noted that latter deliver a daily energy saving of 22% and 12% for the sector and site cases respectively. Results are noted to be in line with those in a similar study carried out and presented by Oliver Blume et al. in [121].

Since the duration of low traffic depends on the area⁷, results are extended to show the impact of a varying period of sleep mode (Figure 7.7). For this case it is assumed that the same percentages of sectors are put into sleep mode for the duration of assumed low traffic period. For areas experiencing longer hours of low traffic, it is noted that for the sector sleep mode the daily energy savings can reach 30% with about 17 hours of activated sleep mode.

⁷ Different areas of the network have a specific traffic profile. In addition to this, statistics show that few sites carry most traffic [108] [34], allowing low loaded sites to extend sleep mode over longer periods.

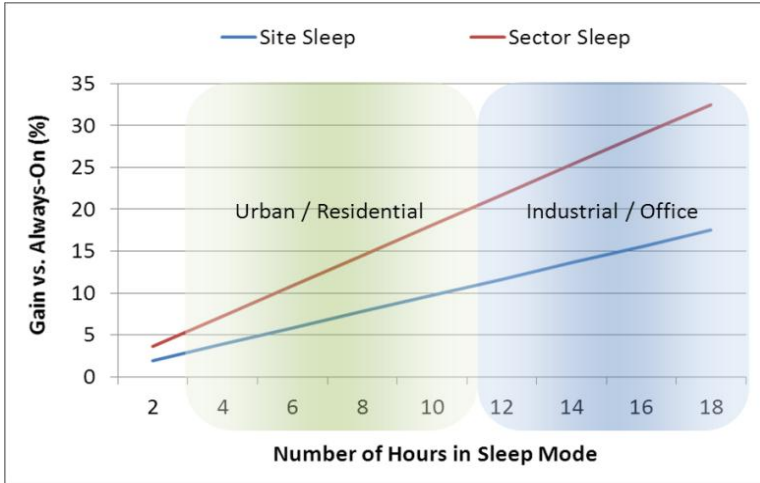

Figure 7.7 – Since different areas within the network can support sleep mode for different periods of time, this figure shows how the energy saving varies with the duration of sleep cycle.

In order to get a more realistic overview on the daily savings of sleep mode, a further sensitivity analysis is carried out to determine the impact of residual power. With results presented in Figure 7.8, the residual power is increase from 0%, representing the original assumption (presented above) of no residual power, up to a value of 30% of the full power consumption of a single carrier macro base station site. Considering the maximum assumed residual power, at 30%, the daily energy saving is noted to fall from 22% to 15% and from 12% to 8% for the sector and site cases respectively. In addition to highlighting the need for extended hours of sleep mode, this also demonstrates the importance of having base station equipment that is efficient when in sleep mode. As base station equipment improves further, this residual power consumption can be expected to shrink. Based on a figure presented in [83] the residual power consumption for sleep mode is given at about 25% of the maximum power.

As highlighted earlier, one of the disadvantages of sleep mode is the potential impact on coverage. While this can be limited within areas with a high density of sites, in more sparse areas, the applicability of the feature should be limited. Even though extracted from an urban area, Figure 7.9 provides a graphical overview of the impact that putting sites and sectors in sleep mode has on the ISD and resulting path loss. It can be argued that some form of network optimization, such as tilt and orientation can mitigate the potential creation of coverage holes. Carried out in the

same study [125], the optimization of tilt is noted to only deliver minor improvements in terms of the lost average user data rate.

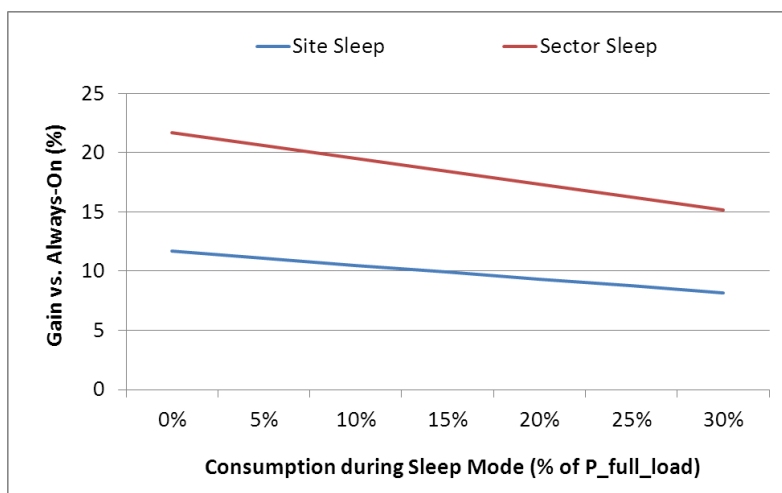

Figure 7.8 – For the assumed case of 12 hours sleep mode, the figure shows how the daily energy saving varies as the residual power consumption of sleep mode increases.

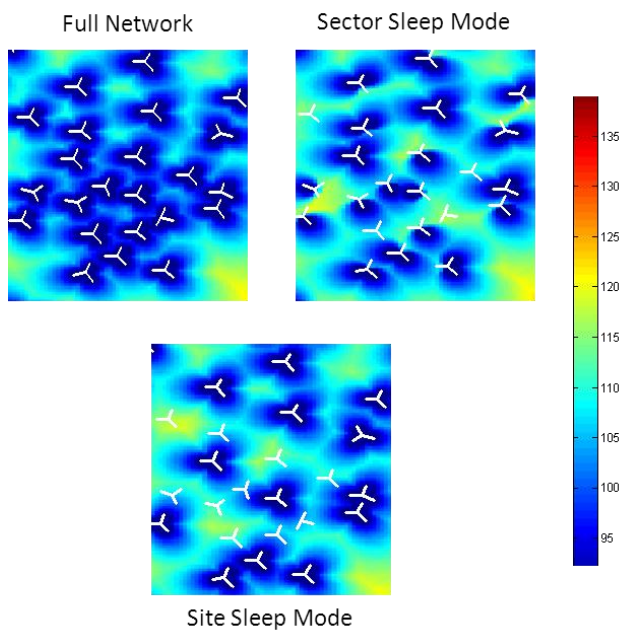

Figure 7.9 – Signal loss (dB) from serving base station sites, for a subsection of the network. This provides a graphical interpretation for how coverage can change with sleep mode.

7.2.2.4 Carrier Sleep Mode

A similar investigation [126] is carried out on a regular network layout. The same outage performance requirement of 5% and a minimum requested data rate of 256 kbps are assumed. All 20 sites, deployed at an intersite distance of 500 meters, are assumed with two HSPA carriers. For this case of sleep mode, this is only enabled for one of the two carriers. This allows for the network to maintain its planned coverage footprint, reducing the need for further optimization, and the risk of negatively affecting subscribers who end up at a greater distance from neighboring active sites.

An algorithm similar to the one described in Section 7.2.2.2 is implemented. For a given number of simulated users, the algorithm, illustrated in Figure 7.10, polls each individual sector to determine whether connected users can achieve the minimum data rate over a single carrier. If this is the case, then the second carrier of these sectors is put into sleep mode. This means that putting the second carrier into sleep mode has no impact on the percentage of users in outage. Once again, a possible trade-off with performance could make space for a more aggressive algorithm that could result in further energy savings.

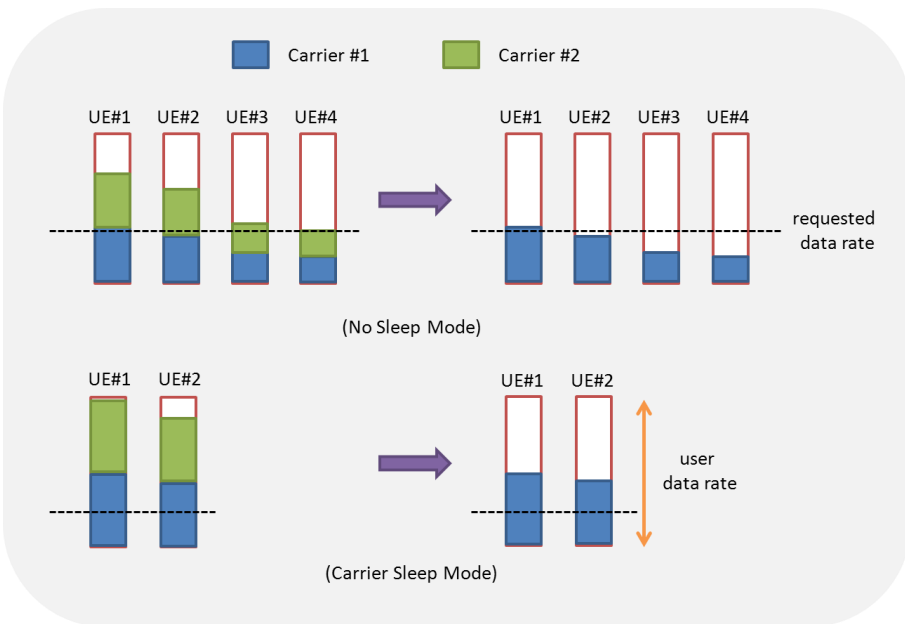

Figure 7.10 – Two cases illustrating the concept of carrier sleep mode. All users must meet the minimum requirement over one carrier prior to putting the second one in sleep mode.

With regard to the power consumption, the original investigation assumes that for a macro base station site this is equally divided among the two carriers. This means that putting the second carrier into sleep mode reduces the power consumption of the site by half. While the original simulation and performance results remain valid, the power models are updated to those presented within this thesis (Chapter 3). More specifically, this means that a power consumption of 581 watts and 753 watts are assumed for the cases with a single and dual carrier respectively.

Based on the traffic profile used in the previous site and sector sleep mode analyses, traffic is modeled in the same way. The only difference is that the daily traffic is divided into three categories (finer), low, medium, and high. Over a 24 hour period, the network is assumed to experience high traffic for 10 hours, with the remaining 14 hours equally divided by the two remaining categories. The implementation of carrier sleep mode is only assumed for the low and medium traffic categories.

In addition to presenting the different traffic categories, Table 7.3 also provides an overview on the impact of carrier sleep mode on the average user data rate. Since full load is assumed, a reduction in traffic results in the remaining users achieving higher average data rates. Even though putting the second carrier into sleep mode⁸ reduces the overall capacity of the network, during low traffic hours, users are still noted to achieve (to a lesser extent) an improvement in average data rate. The percentage of users in outage is not added to the table of results since the algorithm is implemented to ensure that all users achieve the minimum requested data rate, prior to putting the second carrier into sleep mode.

Table 7.3 – Impact that carrier sleep mode has on the number of sectors with two carriers. Results also show that during low traffic, the average user data rate still increases.

		Without Carrier Sleep Mode		With Carrier Sleep Mode	
Traffic Category	Number Traffic Hours	Sectors with 2 Carriers (%)	Average User Data Rate (Mbps)	Sectors with 2 Carriers (%)	Average User Data Rate (Mbps)
High	10	100%	1.13	100%	1.13
Medium	7	100%	1.65	83%	1.57
Low	7	100%	2.81	28%	1.95
Daily Energy Saving (%)				6%	

⁸ For all of the sites, sleep mode is applied to the same carrier. A further enhancement can be for neighbouring sites to alternate the carrier that is put into sleep mode, further reducing interference.

It is noted that under the set of assumption, carrier sleep mode results in a daily energy saving of 6%. While difficult to directly compare with the savings of site and sector sleep mode, this feature is overall still less effective. While assuming the same percentage of sectors having the second carrier put into sleep mode, results are extended to include a similar sensitivity analysis for varying hours of high and low traffic. The results of this on the daily energy saving are presented in Figure 7.11. Only valid for RF modules supporting multiple carriers, it is noted that even if the feature is enabled over a period of 22 hours, savings are noted to barely reach the 12% mark.

7.2.2.5 Sleep Mode for MIMO

During hours with low traffic, the upgrade of base station sites to MIMO provides an additional possibility of putting this feature into sleep mode. In order to achieve an indication at its possible impact, the resulting network configuration (same amount of sites having the feature put into sleep mode) from the previous investigation is adapted to determine the potential of disabling MIMO. While detailed performance analyses are not carried out, this section is only intended to provide a high-level overview to how this feature would compare with the other variances of sleep mode.

The default configuration for macro sites is assumed with two HSPA carriers and the further addition of 2x2 MIMO. By applying the energy model described in Chapter 3, the implementation of MIMO, with the addition of a second transceiver chain, both transmitting at half the power, increases consumption of the site by about 40%. When putting MIMO into sleep mode it is assumed that the transmission power of the remaining transceiver is doubled, maintaining the same overall transmitted power.

In comparison to the previous case of carrier sleep mode, disabling the second transceiver chain of MIMO is noted to provide a daily energy saving that is around 24% more. How the two compare for different traffic categories is presented in Figure 7.11. While this provides an indication to its potential, it is also important to quantify the implications of such a feature on the performance (outage and user data rates) of the network. Based on the fact that the addition of MIMO provides a lesser boost in capacity (~20% to 30%) [52] [127] [128], in comparison to additional

carriers (more spectrum), it can be argued that this feature can be applied over longer periods of time⁹.

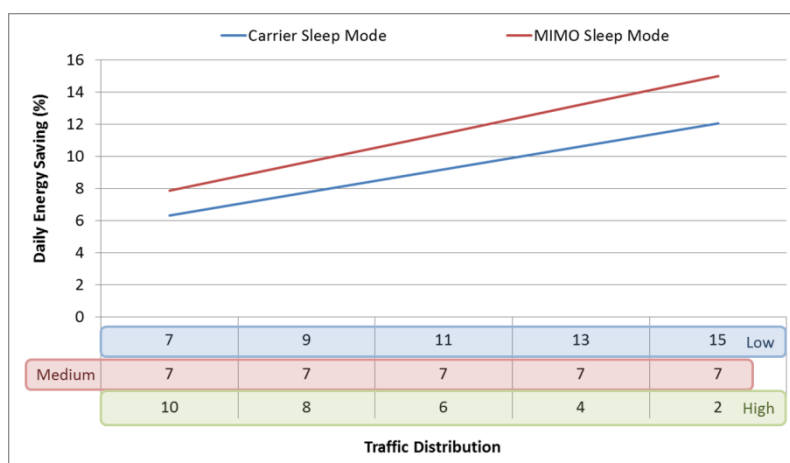

Figure 7.11 – Variations in the daily energy saving for carrier and MIMO sleep mode for increasing hours of sleep mode (different traffic profiles).

7.2.3 Sleep Mode for Heterogeneous Networks

As described in Chapters 5 & 6, the deployment of small cells is expected to boost the capacity of existing mobile networks. While the degree and density of deployed small cells can vary, based on the adopted upgrade strategy, these are envisioned to make up a growing portion of mobile networks. The resulting heterogeneous network environment offers the opportunity of applying the feature of sleep mode specifically for such cells. Since these are mainly deployed to boost capacity, this automatically makes them an ideal candidate, causing negligible impact to the coverage. This section presents a study that determines the potential savings of adopting sleep mode specifically for small cells. Based on a realistic network scenario, a network evolution with varying densities of small cells is first carried out to determine the impact that these have on the resulting macro network layout. Carried out through an ongoing collaboration, with a European mobile network operator, a more detailed overview of the evolution study and agreed assumptions is presented in [129].

⁹ The main compromise of putting MIMO into sleep mode is the reduction in peak data rate that users can achieve, possibly impacting (limiting) the perceived user experience. This leaves MIMO sleep mode having strong attributes on both for and against sides.

7.2.3.1 Network Evolution Scenario

The network evolution study is carried out on an irregular macro layout, based on an existing network within a dense urban European city. Composed of 82 macro sites (single carrier), with an average intersite distance of 280 meters, the same network planning and simulation tool described earlier is used to carry out the evolution and performance analyses. Signal attenuation from macro base station sites is estimated based on the COST-231 Hata propagation model, which is tuned further with a clutter map for the investigated area.

While based on slightly different assumptions, the same traffic growth modeling framework presented in the earlier chapters is adopted. Based on statistics from population density, mobile penetration rate, and network operator market share, these are used to determine the number of mobile subscribers within the area. Focusing further on mobile broadband users, a penetration rate of 15% is assumed for the first year (2010). This provides the total number of mobile broadband users within the area. In order to determine how many simultaneous active users to consider for the simulations, an activity factor of 5% is assumed¹⁰. Over an eight year period, the mobile broadband penetration rate is assumed to increase from 15% to 60%, following an S-shaped curve [109]. A spatial traffic density map, based on traffic statistics from the real network, is used to distribute simulated users between the different cells of the network. Within each cell, users are uniformly distributed.

The purpose of the evolution study is to determine the impact of deploying small cells on the power consumption of an evolving mobile broadband network. Results from three cases with small cells are compared with a macro-only case, in which no small cells are deployed. After overlaying a grid over the network area, the deployment algorithm of small cells is carried out based on a metric measured for each cell of the grid. This metric assumes two factors, perceived network coverage (through SINR), and traffic density [130]. For this investigation, the metric is biased to prioritize traffic density, deploying and concentrating small cells within traffic hotspot areas. On the other hand, the upgrade of existing macro sites, which is always carried out after the deployment of a specific number of small cells (if any), is based on the level of outage experienced within its cells. These upgrades are carried out, if necessary, to further reduce the level of users in outage to the required 5% target.

¹⁰ Agreed with the MNO, this activity factor is an assumption/estimate to how many concurrent active subscribers exist within the network at a given time.

Deployed to operate within the same band but over a dedicated carrier, and with an assumed transmission power of 1 watt (30 dBm), the three cases involving the deployment of small cells consider different quantities (densities) of such cells. By deploying small cells at a rate of 4, 8, and 12 for each of the evolution years, this provides an indication to the impact that having more or fewer small cells have on the power consumption. Referred to as low, medium, and high small cell densities, this provides an insight into the extent to which small cells can reduce the need for further upgrades to the macro layer. In turn, the macro layer is upgraded from a single 5 MHz HSDPA carrier up to a maximum of three adjacent carriers, on top of which, if necessary, a further upgrade to 2x2 MIMO is carried out. In the case of MIMO, simulations and power models assume, as described in Section 3.3.5, that the same overall transmission power is split between the two transmission chains. Within the simulation tool, the gains in capacity introduced by MIMO are implemented by adopting a different mapping curve that translates SINR into throughput (Figure 7.12).

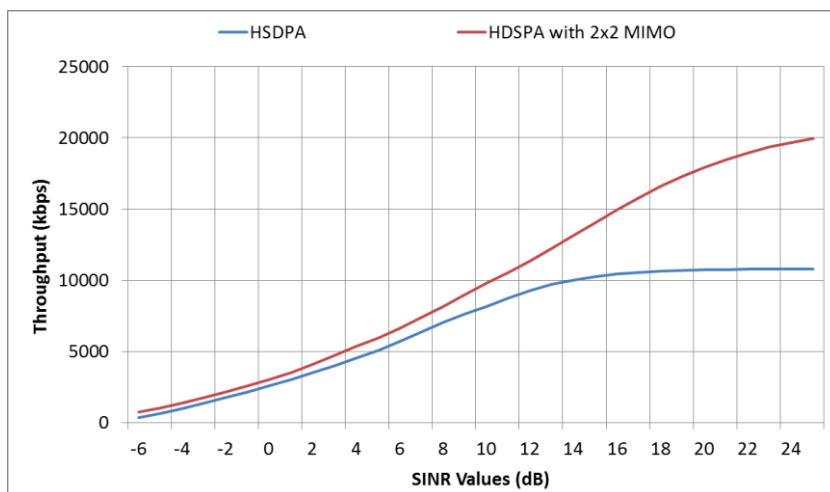

Figure 7.12 – Mapping curve showing how the SINR-to-throughput mapping is carried out for cases with and without MIMO.

A transmission power of 20 watts per carrier for macro base station sites and 1 watt for small cells is assumed. As done in previous sections, the power models adopted for this investigation have been updated from those assumed in the original study [129]. This is done in order to match the assumptions presented earlier in Chapter 3 and used throughout within this thesis. The power consumption values for the different configurations are summarized in Figure 7.13. This shows the extent to

how the power consumption of a single omnidirectional small cell (176 watts) compares with that of fully upgraded macro site (three sectors) with the addition of MIMO (1224 watts). This highlights the impact of MIMO on the power consumption, resulting in a power consumption that is almost seven times that of a single small cell.

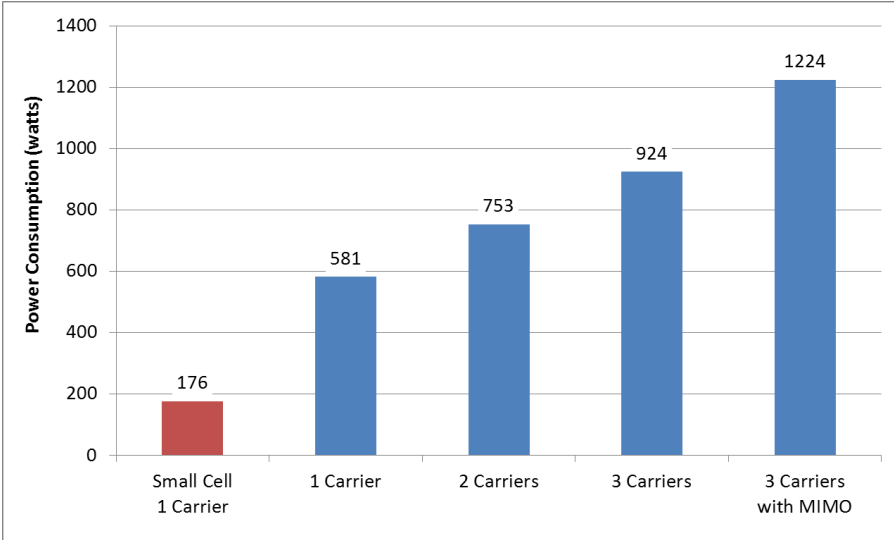

Figure 7.13 – Assumed power consumption values for the different configurations considered within this investigation. This is based on the assumptions detailed in Section 3.3.5.

The feature of sleep mode for small cells is assumed over a 12 hour period with low network traffic. Through the available traffic statistics, the load of the network area over this period of time is averaged, allowing for a relative adjustment in the number of simulated users. During this period, sleep mode is applied to all of the deployed small cells. This means that for cases with a higher deployment density of small cells, the implemented feature of sleep mode results in more savings but also a greater impact on network capacity and performance. In order to understand the impact of putting small cells into sleep mode, the resulting network configuration is simulated again, ensuring that the remaining macro sites can provide the required level of investigated performance.

7.2.3.2 Results

With regard to the evolution of the network over an eight year period, it is noted that even for a low density deployment of small cells, this results in fewer upgrades

required for macro base sites. Especially for the two higher deployment densities, it is noted that none of the macro sites are upgraded to three carriers. On the contrary, for the case with no small cells, almost a quarter of all sites are upgraded to three carriers with 2x2 MIMO. An overview of the site configuration for the final year of the considered evolution period is presented in Figure 7.14.

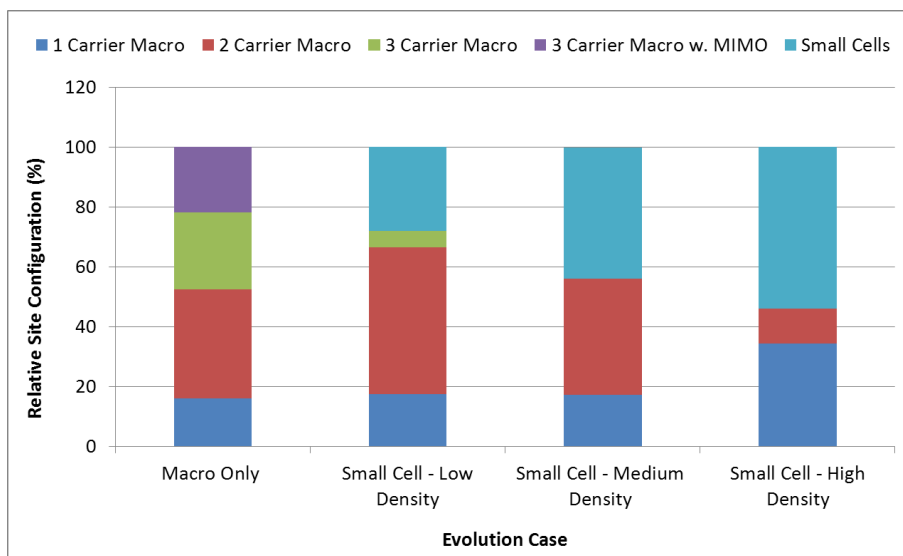

Figure 7.14 – Relative distribution for the different site configurations (final year of the evolution period). As the number of small cells increases, this reduces the number of required macro upgrades.

When it comes to how the power consumption of the network, for the different cases, evolves over the investigated eight year period, it is noted that the case with a low density of deployed small cells consumes least amount of power (9% less power than the macro-only upgrade case). The two cases with a higher deployment density of small cells are noted to deliver comparable results, consuming about 4% and 5% less power than the macro-only case for the medium and high density cases of small cells respectively.

Expecting possible improvements in power consumption for small cells, a sensitivity analysis is added to determine its potential impact. In Figure 7.15 the power consumption of small cells is extended on both sides of the assumed (marked) value. Based on the assumed power models, it is noted that until the consumption of small cells is higher than 125 watts, then a low density solution of small cells remains the one that consumes least power. For even lower power

consumption values of small cells, a higher density of small cells starts to become the more attractive option.

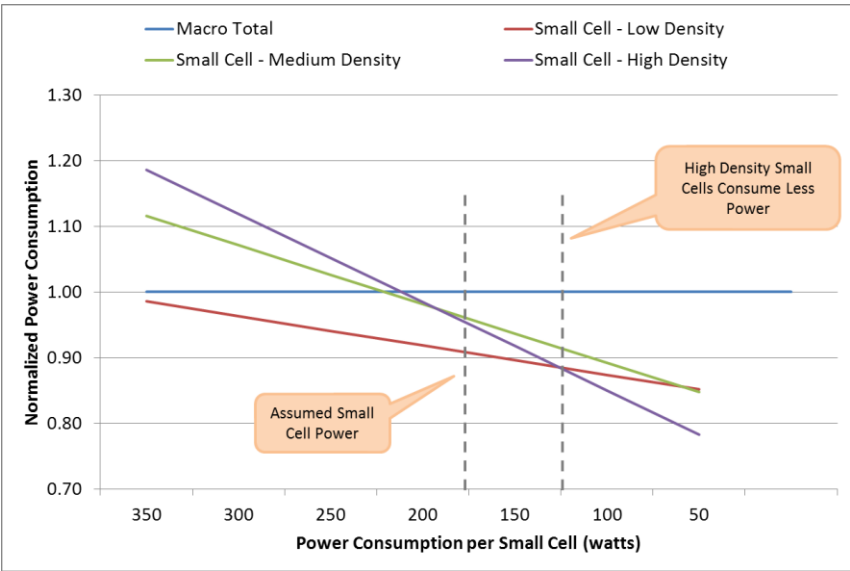

Figure 7.15 – Impact of varying small cell power on the network consumption. The figure marks the current assumed power value (176 watts) and the point when a high density deployment consumes less than all other options (125 watts).

When enabling the feature of sleep mode for (all) small cells, performance results show that during low traffic conditions, the case assuming a high density of small cell is unable to meet the necessary network performance level (outage)¹¹. When considering the potential daily energy saving, the higher the density of small cells the higher the savings. For the medium and low density small cell deployment cases, it is noted that over a 12 hour period the daily energy savings amount to around 8% and 4% respectively. In comparison to site and sector sleep mode, this variation of sleep mode is noted to provide relatively lower energy saving potential. Figure 7.16 provides an overview of how the daily energy consumption savings varies for different sleep mode periods. While a possible reduction in power consumption for small cells improves the overall consumption of the network, this also limits the potential savings from the proposed feature. In such a case, sleep

¹¹ Having deployed more small cells reduces the number of upgrades carried out on the macro layer, limiting performance when small cells are put into sleep mode.

mode for macro base station sites is likely to deliver more meaningful results in terms of reduced power consumption and related costs.

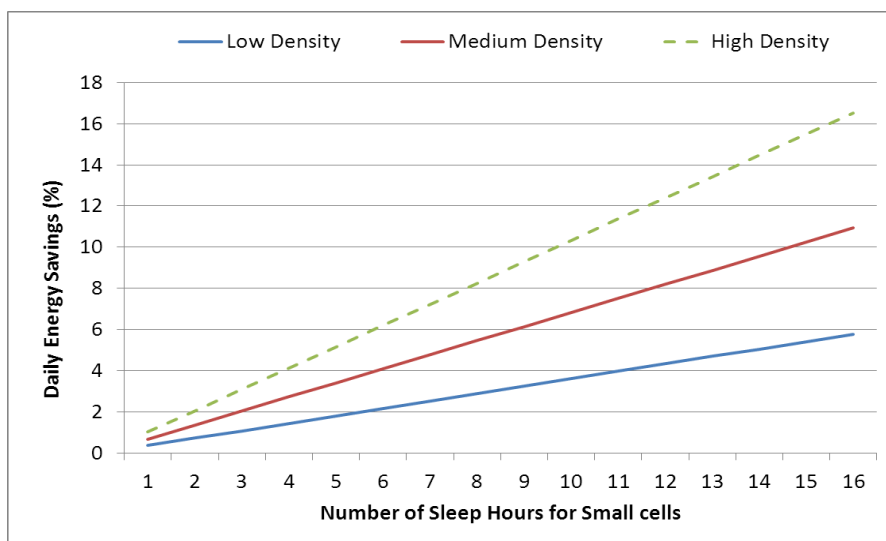

Figure 7.16 – Daily energy saving for small cell sleep mode. The case with high density of small cells results in high levels of outage, requiring for fewer cells to be put into sleep mode.

7.2.4 Other Considerations for Sleep Mode

While sleep mode is a very attractive method for reducing the power consumption of mobile networks, its practical applicability on a wider scope remains dubious. Mobile users are somewhat adapted to expect a level of performance that is somewhat related to the place and time of day. If the implementation of sleep mode and the reduction in network capacity can be sensed by the users this can in some cases hurt the operators' reputation. On the other hand, if the feature is enabled with stringent requirements, the savings can be 'worthless'.

Another issue to consider is the impact of equipment delay in transitioning from one state to another. While this depends on how sleep mode is implemented, this can have the impact causing a delay that is sensed by the users. This is a further feature that is expected to improve, possibly by allowing for a 'hibernation' state which allows for more rapid activation. While some challenges are already being tackled through standardization, other technical challenges include: centralized versus distributed control, overheads required for monitoring and management the feature, sleep mode triggering mechanism, and sensing mechanism for wakeup. These

challenges emphasize the importance of network operators to consider network upgrade options that are in the first place more energy efficient when fully operational.

7.3 Upgrades to Macro Base Station Sites

7.3.1 Introduction

An RF module can represent anywhere from 65% to 80% of the power consumption in a base station site. While throughout this thesis many assumptions are based on the ability to deploy three sector based RF modules, base station sites are likely to require multiple RF modules for each active RAT (Figure 7.17). A further limitation that could ‘force’ the addition of a second, or more, RF modules per RAT, is the operating frequency and/or maximum transmission power.

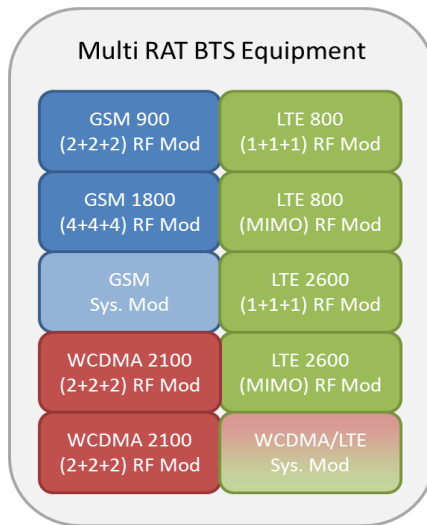

Figure 7.17 – Overview of the equipment required within a base station site for supporting three RATs. In addition, other site support equipment is required.

For the first case, power amplifiers are designed to ‘efficiently’ operate over a limited bandwidth around a specific frequency. Since some RATs operate on multiple bands, such as in the case of GSM (900 vs. 1800 MHz), and LTE (800 vs. 2600 vs. 3600 MHz), these require multiple RF modules. Some operators, like Vodafone in the UK, also make use of multiple bands for WCDMA, using both 900 and 2100 MHz bands [131]. In the case of bands that are in close proximity, for

instance WCDMA 900 and LTE 800, multi-standard equipment can be used to simultaneously support multiple access technologies, referred to as RF sharing, which reduces the power consumption as well as the physical footprint of the site.

7.3.2 Re-Allocation and Bundling of Spectrum

Transmissions over different frequency bands result in different propagation properties. Lower bands are less susceptible to attenuation over distance and penetration, meaning that fewer sites are required to provide the same coverage. Because of this and fact that other applications compete for this region of the spectrum, is the reason why this is often referred to as “beach-front property”, often pushing for a higher costs at auctions [132].

In order to reduce the number of RF modules, it is proposed that within each site MNOs select a single frequency band for each RAT. While it can be assumed that spectrum is auctioned in the same way that it is today, the different bands can be made available for specific regions based on the expected traffic. A crude demarcation is that lower frequency bands are deployed in rural areas, while higher frequencies are used in sub-urban and dense urban areas. For such areas, with a relatively small ISD, the impact of propagation as a result of higher frequency bands becomes less of an issue.

7.3.2.1 Multi-RAT Macro Base Station Site

An evolved high capacity macro base station site supporting all three RATs is assumed within a dense urban environment. The site is assumed configured to support four WCDMA carriers on the 2100 MHz band, six TRXs for GSM, and two LTE ‘carriers’¹², for both cases split on the separate available bands. This is the configuration that is illustrated in Figure 7.17. By applying the assumed power models¹³, this site configuration consumes a total power consumption of 7582 watts.

¹² Since the term carriers is misleading for and LTE case, this refers to operating on both the 800 MHz and 2600 MHz bands.

¹³ The power model is only applied for the WCDMA and LTE equipment. Power consumption values for the GSM equipment are based on [135] and further discussion with NSN experts.

Table 7.4 – List of the power consumption values used for the spectrum bundling analysis.

Technology	Configuration			
	1+1+1	2+2+2	4+4+4	6+6+6
GSM		1800 W	2300 W	2700 W
WCDMA		753 W	1096 W	
LTE	988 W	1280 W		

While specific for different equipment vendors, new RF architectures can be expected to support wider bandwidths. Based on this, it can be assumed that the transceivers and carriers for GSM and WCDMA can be shifted onto a single module. By combining the spectrum over a single band, two RF modules can be reduced from the site, reducing the power consumption by 24% to 5772 watts. In reality, the number of TRXs (capacity) for GSM could in the future be reduced, making way for reframing of spectrum on the 900 MHz band.

In the case of LTE, current RF modules are limited to an operational bandwidth of 20 MHz, restraining the use of single unit for two LTE carriers. However, with the potential of multiple LTE carriers and features such as carrier aggregation, RF modules supporting up to 40 or 60 MHz can be expected within the next few equipment generations. Based on this assumption, further bundling of the LTE equipment on a single band, illustrated in Figure 7.18, can be reduced the power consumption further to 5076 watts, a total reduction of 33% from the original configuration.

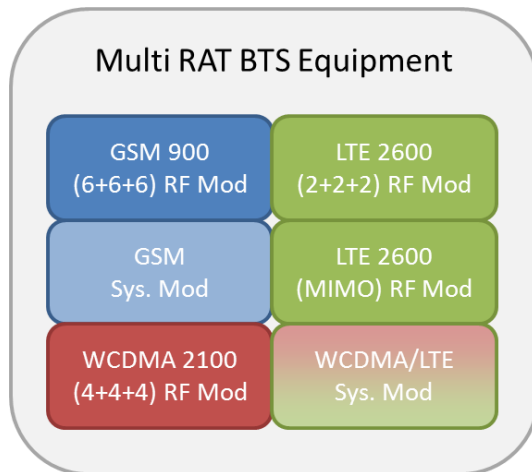

Figure 7.18 – By grouping frequency bands and exploiting the capabilities of current equipment (within a specific area), the number of modules can be reduced without impact on site capacity.

In addition to the noticeable power savings, the proposed spectrum bundling has the side benefit of reducing the volume of space required at each base station site. In comparison to older equipment, newer versions are more compact. Current base station modules require a volume of about 25 liters [133]. When it comes to space saved, the suggested modifications result in the indirect reduction of four units, saving around 100 liters, or 40% of space. Depending on the type of equipment setup (cabinet, wall mount, etc.) this can also lead to a reduction in site related rental costs.

7.3.3 Reduction in Transmission Power

Irrespective of the area MNOs often set macro base station sites to transmit at maximum possible (allowed) power. Since the amount of resources required by each user is related to the strength of the received signal, transmitting with a higher power [134] offsets a part of the losses attributed to feeder cables [135], and indoor penetration. Based on existing equipment information, each transceiver within an RF module can support an output power of 60 watts [51]. In the case of sites with multiple carriers, this power is split among the different carriers. If a higher transmission power, on a per carrier basis, is required, additional RF modules are required at the base station site.

Since the evolution of mobile networks is heading towards a heterogeneous layout, a larger portion of indoor traffic can be shifted to indoor or outdoor deployed small cells. With macro base station sites expected to serve outdoor traffic, a reduction in transmission power for macro sites can provide power savings while minimizing the impact¹⁴ on the performance. If a reduction in RF power is accompanied by an upgrade to RRH, the reduction in power at the antenna can to a greater extent be compensated for.

In order to illustrate the potential savings, Figure 7.19 shows the impact of reducing the RF transmission (at RF module) power of a three sector macro site from 60 watts to 30 watts (50%) and down to 20 watts (67%). A 3 dB feeder loss is assumed for each case, reducing by half the effective transmission power that is radiated by the antenna. Figure 7.19 provides an overview for how the power consumption of the site reduces with reduced set RF transmission power, resulting in a power

¹⁴ Especially true for very dense macro deployment scenarios.

saving of 42% and 64% respectively for the two cases, following closely the relative reduction in transmit power.

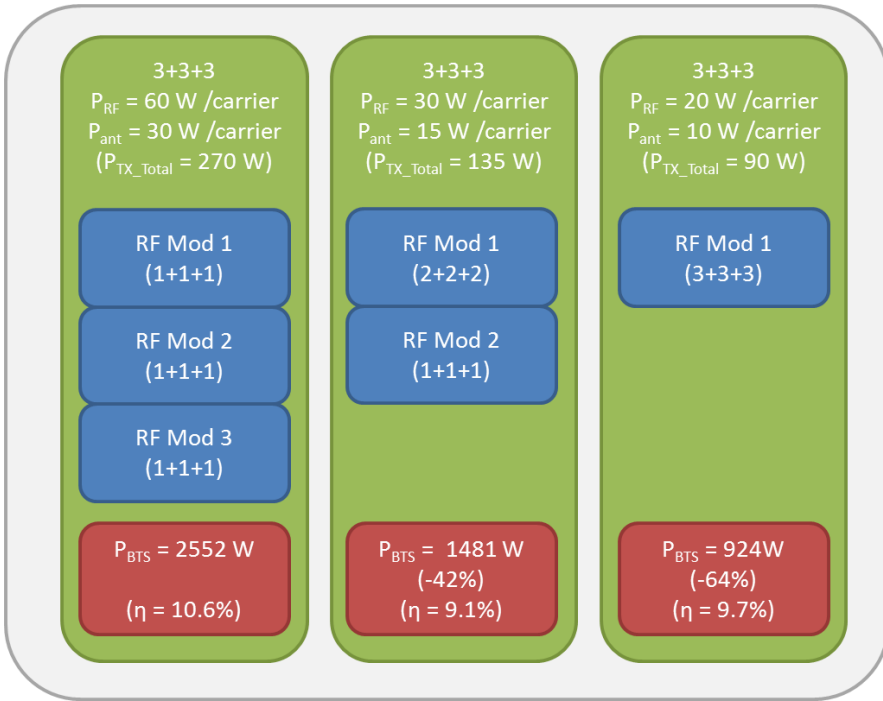

Figure 7.19 – While not directly proportional, a reduction in transmission power on a per carrier basis can result in considerable power savings and possibly even fewer RF modules.

In order to consider a more realistic scenario, it is assumed that the same three carrier site is upgrade to RRH. Rather than exploiting the gain for increasing the power, the transmit power of the RF module is reduced to maintain the same power at the antenna. For the case with RRH, assuming a residual loss of 1 dB, the transmit power of the RF module can be reduced from 60 watts to 38 watts (a reduction of 37%). While still requiring three separate RF modules, the power consumption of the site (Figure 7.20) is noted to improve by 22%, a power saving that can be achieved throughout operations and without any impact on performance. In comparison to the previous generic cases (Figure 7.19), the power saving in this example is noted to not follow, as closely, the reduction in transmit power. This is due to the fact that for each of the steps, in the previous cases, one of the RF modules is reduced from the site, reducing further consumption.

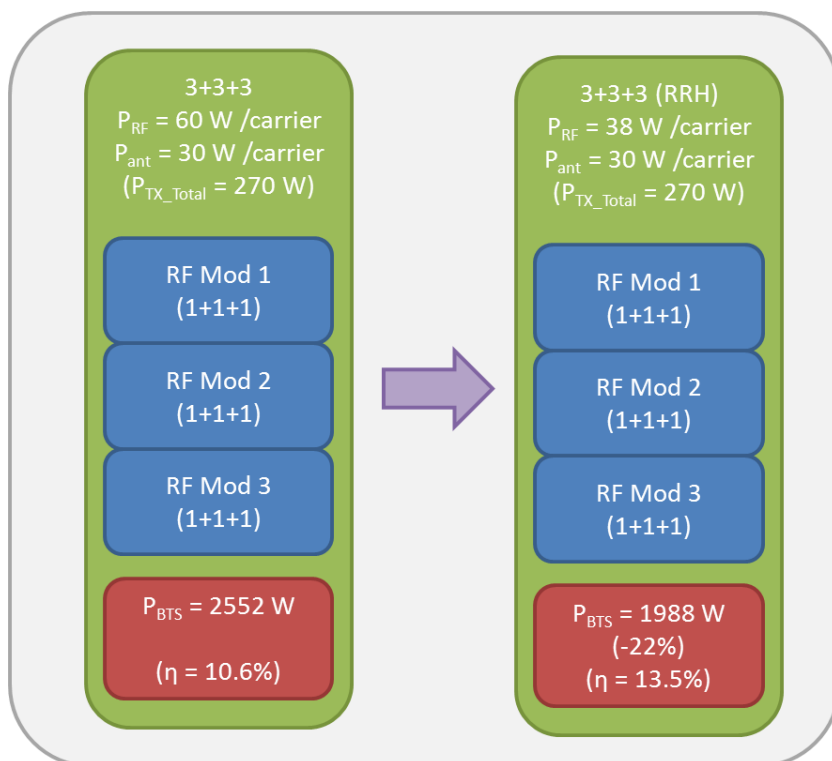

Figure 7.20 – Overview of a realistic case for reducing the transmit power of base station site. In this case the transmit power is reduced by the same amount that is gained by upgrading the site to RRH, resulting in the network transmitting, from the antenna, at the same exact power.

7.4 Other Power Saving Methods

The last two sections have mainly featured the importance and potential power savings of upgrading base station site equipment. On a similar note, this section briefly highlights two further options for further reducing the power consumption of base station sites. In the first option, the potential improvements of cleaning up and upgrading the overall site are briefly described. Following this, a somewhat uncommon yet already available feature of shifting traffic away from the busy hour is also described.

7.4.1 Overall Site Clean Up

The power model and studies investigated in this thesis are mainly focused around the RF and system modules. If the power consumption of the entire site is considered, then mobile network operators can achieve further gains by upgrading and replacing this auxiliary equipment, referred to here as cleaning up the site. For instance, if within a site the new equipment can support higher temperatures, gains in power from less cooling can only come into place if the operator updates the temperature control unit. In addition to this, if a specific unit is suitable for outdoor deployment, doing this reduces the amount of heat generated within the equipment cabinet/room, reducing the need of cooling further (also for other components).

A further improvement can be in the selection of battery backup. The idea of hydrogen cells¹⁵ to replace regular batteries has for a long time been considered as a possible option, being more efficient and generating less heat [136]. Over the last couple of years, this technology has matured further, making its introduction even more likely. Other small upgrades that can improve the power efficiency include: upgrade of lighting in an indoor locations, and the replace of aging (more loss) components such as connectors, combiners, and feeder cables.

7.4.1 Traffic Filtering

The scaling of installed capacity for each base station site (macro or small cell) is based on the expected traffic during the busy hour. While necessary, this results in a very inefficient use of this capacity. This is due to the fact that peak traffic only occurs over a short period of time, resulting in much of the installed capacity remaining unutilized. This is also noted in the measurement campaign, presented in further detail in Appendix A. Equipment vendors have started to provide solutions to tackle this issue by centralizing capacity through a bank of system modules [44]. Often referred to as baseband pooling, in addition to maximizing the use of installed capacity, this also provides a centralized node for hosting further features, such as interference cancellation, that can exploit information from different neighboring sites.

Another option for mobile network operators it to (try and) alter the traffic profile. Hereby termed as traffic filtering, the idea is to promote use of network resources

¹⁵ To note however that if considered over the entire cycle the generation and transport of hydrogen is more power consuming than a battery solution.

away from the busy hour. The concept is similar to that adopted for electricity [137], where the cost per unit is less during night time, when the demand is also less. By promoting or providing an incentive to shift traffic away from the busy hour, the network can ultimately carry more traffic without the need of any further upgrades. Over a period of time, the reduced need of network upgrades, and the ability to carry more traffic would result in a more energy efficient network. The traffic profile presented in Figure 7.21 (dark shade) is extracted from an urban area within a European network.

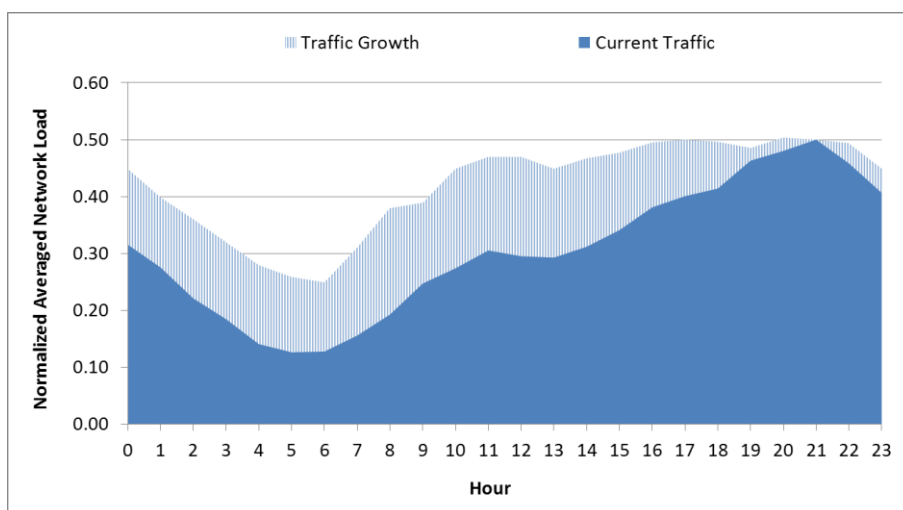

Figure 7.21 – Traffic profile (dark shade) based on traffic statistics extracted from a real network. The traffic is normalized against an assumed maximum of 50% traffic load. The striped area depicts the potential of accommodating traffic growth during different hours. Traffic profile based on [43].

The load of individual sites peaks over short periods of time, resulting in a relatively low average network load. If optimistically it is assumed that the average load during busy hour is 50%, the presented traffic profile gives a utilization factor of around 30%. By adopting a dynamic pricing strategy, like the ones proposed in [138] and [139], additional traffic can be accommodated away from the busy hour. Users can be motivated to use, or schedule, data intensive applications or transfers during these more affordable hours. The overlaying striped area in Figure 7.21 represents an example of how such incentives could result in a modified traffic profile, ultimately carrying more traffic without the need for additional upgrades.

7.5 Conclusions

This section has presented a number of additional features that MNOs can exploit for further reducing the power consumption of mobile networks. The first section has looked at various options of sleep mode, taking advantage of periods during which the traffic of the network is relatively low. More detailed analyses show the potential daily energy savings of adopting such features, with some sleep mode adaptations more efficient than others. Other options attempt to make better use of the capabilities of base station equipment, reducing the number of RF modules by grouping spectrum or reducing transmission power. An overall overview of the potential savings and applicability is summarized in Table 7.5.

Table 7.5 - Summary of the different options considered for further reducing the power consumption of mobile networks. Potential savings in brackets refer to predicted savings that have not been tested.

Feature	Potential Saving	Applicability / Adoptions
Site Sleep Mode	12%	Medium
Sector Sleep Mode	22%	Medium
Carrier Sleep Mode	6%	High
MIMO Sleep Mode	12%	High
Small Cell Sleep Mode	4-8%	High
Bundling Spectrum	33%	Low
Reducing Transmit Power	22%	Medium
Site Clean Up	(5%)	High
Traffic Filtering	(10%)	Medium

The above table shows that while some features are more applicable and realistic than others, the potential savings can vary considerable. Ultimately, even though some of the features provide relatively small savings, the possibility of combining a number of features together with a power efficient network evolution strategy are likely to be central to an overall reduction in power consumption for mobile networks. Of note is that a reduction in transmit power provides some of the better power savings. Especially if applied within a dense urban area, and to sites which are upgraded further to reduce losses between the RF module and base station antenna, this can have a considerable impact on the power consumption.

7.5.1 Take-Away Points

- Sleep mode allows for the shut-down of load independent power consumption during hours of low traffic.
- Enabled over a 12 hour period, site and sector sleep mode can provide daily energy savings in the range of 12% to 22% respectively.
- Minimizing impact on coverage, carrier and MIMO sleep mode result in 6% and 12% daily energy savings respectively.
- To minimize impact to coverage and performance, sleep mode is only recommended in dense urban area and capacity enhancing sites.
- The upgrade of macro sites to RRH can reduce the power consumption by 22%, while maintaining the same transmit power at the antenna.

8. Thesis Outcome

After having investigated the evolution of mobile networks, replacement of old base station equipment, and potential of a number of power saving features, this final chapter puts it all together, revealing a realistic overview and outcome on the topic of energy saving for mobile networks. The first section combines all of the different elements identified and described throughout the thesis, presenting a simple analysis on the likelihood of operators to meet set commitments and goals. Based on this, two major concluding remarks are presented and briefly discussed. The chapter and thesis are subsequently closed with a short overview of what further work could be carried out on the topic of energy efficient evolution of mobile broadband networks.

8.1 Prospects of MNOs to Reach Targets

Within the first chapter, the question on whether MNOs can meet their carbon and energy obligations was posed. Chapter 5 provides a clear and complete trend for how the power consumption of mobile networks is expected to evolve over the next years. Results show that in a best case scenario, the power consumption of the network from 2011 to 2019 is still expected to increase by around 17%. By taking the year 2006/7 as a reference, Vodafone's pledge states that they aim to reduce their carbon emissions by 50% by the end of 2020.

Assuming that a carbon emission is directly related to power consumption and that the network assumed for 2019 can be extended to 2020 and that the network is backtracked to the reference year (2006/7), this provides a better position for comparing the achieved results with the statement. By considering that in the year 2006/7 all considered macro sites are equipped with one carrier¹ and with old equipment, the difference in power consumption between this reference year and 2020 reduced further to an increase of just 7%.

¹ It is assumed that the first upgrades to two carriers are carried out after the initial increase in data traffic, triggered around 2007 and 2008.

In order to further reduce the power consumption of the network, MNOs can of course exploit a number of power saving features, described in Chapter 7. By only assuming the adoption of reducing power after upgrading sites with RRH, this already has the potential of reversing the power consumption trend to a negative one. Based on the assumption that the MNO enables a few of the power saving features, reducing the power/energy consumption of a mobile network by half can be categorized as plausible.

While plausible, this remains an ambitious target, with the impact to network performance and costs among the top factors limiting this from becoming true. In line with this, a recent report by Vodafone [140] states “*despite our efforts, current projections show that we will not meet the 50% target by 2020 through energy efficiency alone. We continue to explore other options in 2011/12 including energy and carbon offsetting*”.

8.2 Conclusion

Based on the analyses and results presented throughout this thesis, two major concluding statements are sufficient to summarize the salient points of this research, providing an alternate, yet realistic, target.

- In order for mobile network operators to minimize the increase in energy consumption, while supporting the predicted increase in traffic (x50), a hybrid solution involving the joint upgrade of existing macro base station sites and deployment of small cells in traffic hotspots is recommended.
- While the replacement of aging base station equipment and implementation of energy saving features can offset, or even reduce the overall energy consumption of mobile networks, a number of practical, financial, and possibly performance related issues, are likely to limit operators from achieving any overly ambitious carbon and energy related targets.

With mobile networks required to constantly evolve, this thesis has first and foremost highlighted the importance of mobile network operators to compromise on an evolution strategy that also considers and minimizes impact on the energy consumption. In doing so, this would considerably limit the rate by which the energy consumption, together with the related costs, of the network increases.

While some of the more energy efficient options might not always be financially or practically feasible, simulation results carried out through two case studies demonstrate that the hybrid upgrade of macro base station sites together with the deployment of small cells in high traffic areas are the solutions that consume least energy. Based on this it is encouraged that MNOs consider and plan the rollout of small cells, especially within areas with a high concentration of traffic. While the deployment of such sites over undisturbed frequencies (out of band), is noted to provide considerable improvements in capacity, especially for a dense urban environment, it is still recommended that existing macro base station sites are still upgraded further with additional carriers². When it comes to the deployment of small cells, both outdoor and indoor, the type and density of cells is very case specific and depends on the existing infrastructure and state of the network.

A further significant outcome of this thesis is the importance of mobile network operators to replace older versions of base station equipment. While unfeasible to constantly replace equipment, it is recommended that mobile network operators maintain a maximum of two to three equipment versions, requiring for more frequent replacement strategies. The energy savings introduced from the replacement of equipment is noted to offset a good portion of the increase in energy consumption as a result of necessary network upgrades. The main advantage of equipment replacement is that the gains are by default exploited throughout the lifetime of the equipment.

While the above two practices can considerably limit the increase in energy consumption, mobile network operators can further reduce consumption by enabling a number of dedicated features. With the investigated features averaging savings of around 12% (Table 7.5), the ability of enabling a number of non-interfering features provides considerable potential for further reducing the power consumption of mobile networks. An example of this could be: the enabling of MIMO and/or carrier sleep mode, a reduction in transmission power to sites already upgraded to RRH, and traffic filtering. These recommended options can be implemented in a manner that limits any major impact to the performance of the network, promoting for a more efficient and dynamic use of existing resources.

² This assumes that additional already owned spectrum within the operating bands, especially for 3G are still not being utilized.

8.2.1 Expected Energy Trend

The drive for higher data rates and consumption of larger volumes of data will require a considerable number of network upgrades, all of which are expected to increase the overall energy consumption of the network. While this thesis has highlighted three main areas which address this issue, no single option or feature is expected to solve the issue and reverse this trend. After putting the different power saving options together (Figure 8.1), this thesis demonstrates that an overall reduction in power consumption, while supporting the predicted growth in traffic, is technically possible. While achieving this would require for costly continuous replacement of base station equipment and an aggressive implementation of features (Figure 8.1), the options described and recommended within this thesis still allow for operators to drastically slow down and control the growth in energy consumption. While reductions in power consumption can be translate into OPEX savings, it is believed that maintaining a power consumption status-quo throughout the evolution is in the long term the target that mobile network operators should aim for. This would result in a network that can continuously evolve to carry increasing volumes of traffic while consuming comparable amounts of energy. Determining the overall energy consumption trend for mobile broadband networks is case specific, with the outcome heavily influenced by the current infrastructure, resources, and strategy of mobile network operators.

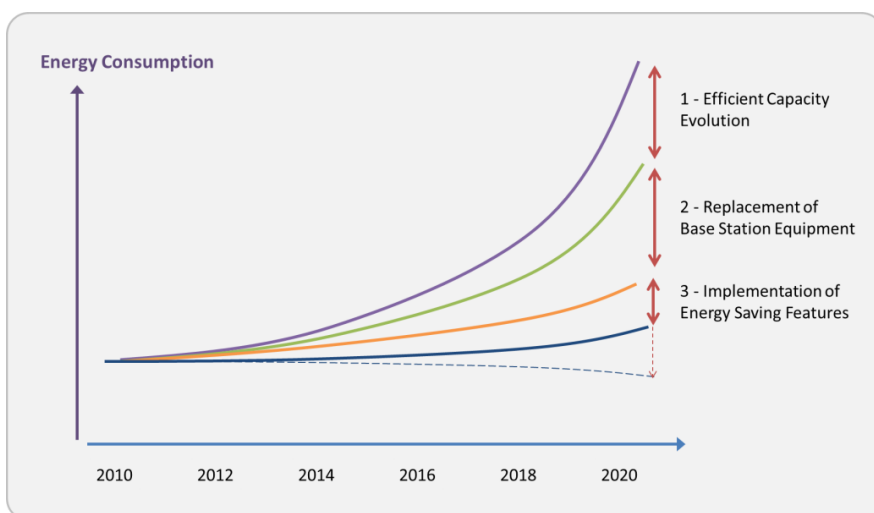

Figure 8.1 – This illustration portrays how the three main areas investigated within this thesis are together necessary for controlling the growth in energy consumption of mobile broadband networks, as these evolve to cater for the expected growth in data traffic.

8.3 Future Work

This final section provides some insight into possible future studies that could extend to this and other contributions on the topic of power consumption in mobile networks. While the power models presented within this thesis are not extensively complex, further refinement and upgrades³ are still expected to provide the same overall results, conclusions, and recommendations. Following the lines of this thesis, a minor upgrade could be that of considering a wider range of power saving features, providing a richer comparison between the potential saving and applicability of different features.

By presenting similar type of results, the study can be further extended to consider more novel power saving methods for managing dense heterogeneous networks, optimizing sleep mode and traffic steering for reducing the power efficiency. This can also include the impact of different energy sources within the network, continuously including more elements to the overall picture presented. Since most of the studies often focus on optimizing a specific feature and/or network component, it is important to provide a reliable estimate of the bigger picture. It is recommended that future work expands this study, which only considers the radio access network, to also include other network elements and processes, providing a wider picture for the power consumption trend. This also allows for various improvements to also play a role in the end-to-end power savings of mobile networks.

³ Power models can be improved to: scale capacity module with site configuration, and include the impact of varying bandwidth (LTE).

Appendix A

Base Station Measurement Campaign

A.1 Scope

Facilitated by an ongoing collaboration with a European MNO, a site measurement campaign is carried out. The purpose is to get an understanding of how the power consumption of base station sites varies against a number of parameters, including load/traffic, and temperature. While involved throughout, the main contribution in this campaign is limited to parts of the documentation. The reason for dedicating an entire appendix for this campaign is to reinforce some of the statements and assumptions included within various chapters.

A.2 Scenario

The campaign is carried out in a medium sized European city, with measurements taken from three separate (live) sites, with Table A.1 providing a more detailed overview and comparison. These represent different regions of the city, corresponding to an urban, sub-urban, and rural area.

Table A.1 – Summary highlighting key features of the measured base station sites

Scenario	Urban	Sub-Urban	Rural
UMTS Configuration	2+2+2	2+2+2	1+1+1
UMTS RF Modules	3	3	2
GSM Co-location	Yes	Yes	Yes
Location	Indoor Cabinet	Outdoor Cabinet	Indoor Shelter
Cooling	Air-Conditioning	No Cooling	Fan Cooling
Feeder Cable Run	18 meters	40 meters	38 meters

The main focus of the campaign is the WCDMA equipment installed at each site. In the cases of urban and sub-urban sites, both are configured with two carriers. For the rural site, a single carrier configuration provides the necessary capacity and coverage. Since all sites are co-located with GSM 900 and GSM 1800, a measure for the power consumption of the entire site is also included. As pointed out in section 7.3, it becomes clear that MNOs make use of multiple RF modules to support existing configurations.

Each site is equipped with a number of sensors (Figure A.1) and probes for measuring power consumption. Thermistors are utilized to measure the temperature outside and inside the cabinet, as well as at the center of the RF modules. The power consumption of each UMTS site is calculated through the DC voltage and current measured at the system module. In addition, measurements of the current drawn by each RF module allows for the power consumption to be split even further on a per RF module basis.

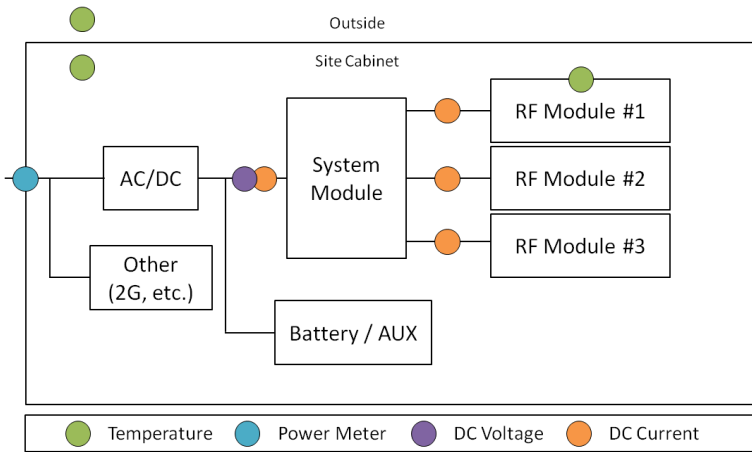

Figure A.1 – Detailed overview of the sub-urban site, highlighting the setup and location of where the measurements are taken from.

A power meter is also placed on the AC line to measure the power consumption of the entire site. This allows for the power consumption of the UMTS portion to be put in comparison with that of a co-located site. For the case of the urban site, further site equipment is not included in this measurement. Readings are polled from each site at an interval rate of one minute over a period of an entire week. The

data¹ is transmitted via a UMTS module to a central server, where it is collected, processed, and later analyzed. In addition to these measurements, downlink traffic statistics for each site, on an hourly basis, are made available by the MNO.

A.3 Results

Prior to overlapping traffic statistics with power, the former is noted to provide an interesting insight. While all sites demonstrate similar trends, these are presented by focusing on the data collected from the urban site, presented in Figure A.2 and Figure A.3. By looking at how traffic is distributed over multiple carriers, it is noted that most of the traffic gets concentrated on one of the carriers. This highlights the potential of an energy saving mechanism that can efficiently disable additional carriers, and/or RF modules. When looking at how traffic varies on a sector level, it is noted that over time, peaks often occur at different instances. This is what the concept of liquid radio [44] tackles. By deploying less capacity but in a centralized location, this can be efficiently distributed to the sites and sectors that need it.

With regard to the temperature and power consumption, collected data is averaged on a per hour basis, reducing the number of data points and short term fluctuations. This facilitates mapping with traffic. The variations in power consumption for the urban and sub-urban sites are presented in Figure A.4 and Figure A.5. While all values are normalized against a maximum value, it is noted that variations in power consumption, over the investigated period, is minimal ($< \pm 10\%$). This confirms the core assumption that the power consumption of base station sites is weakly related to the load, highlighting the need of features that shut down underutilized, or redundant, base station equipment.

¹ Details on the type of GSM equipment, cooling, battery backup, lighting, and other site support equipment is not included.

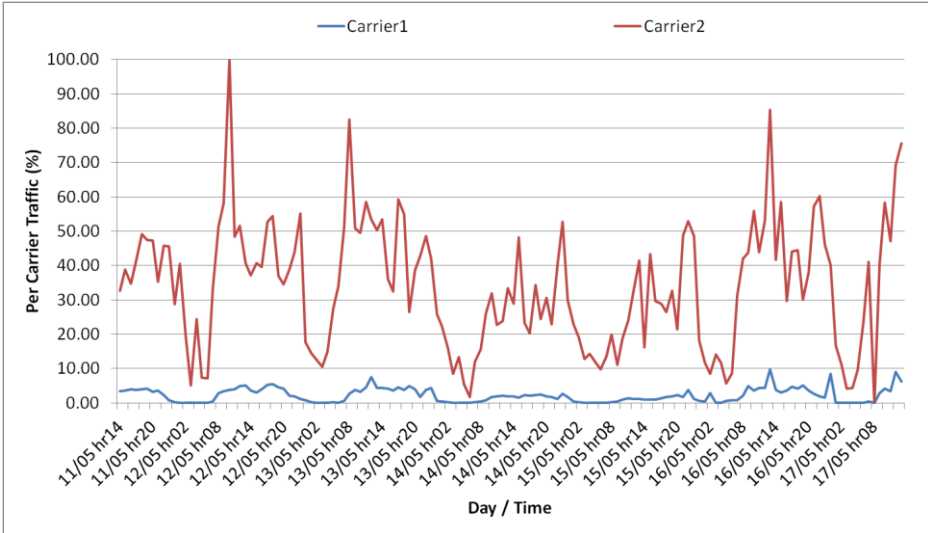

Figure A.2 –Downlink statistics for the distribution of traffic on a per carrier basis, highlighting the imbalance between traffic over the two carriers.

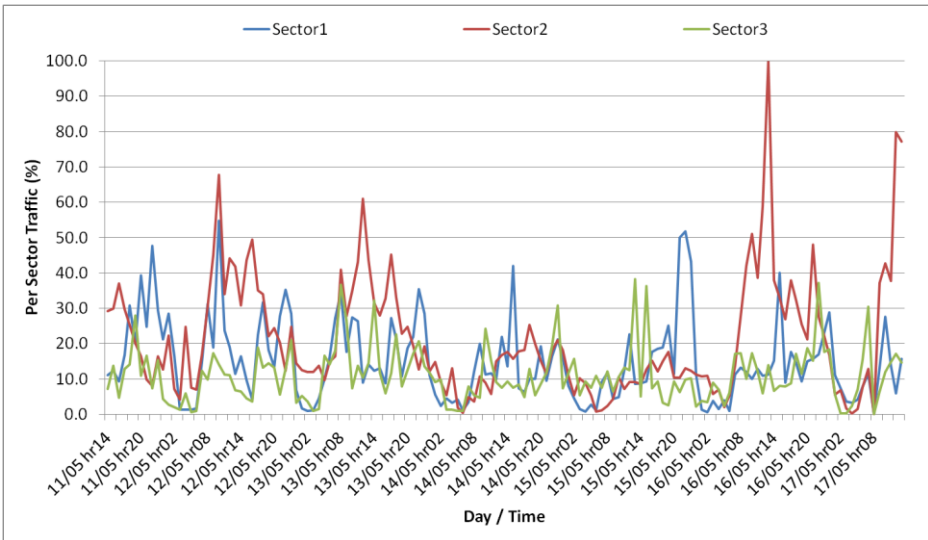

Figure A.3 – Downlink statistics for the distribution of traffic over the three sectors of the urban base station site.

Measurements for the overall site consumption of the sub-urban and rural sites show that in these cases, the UMTS equipment is responsible for about a third of the power, with the rest coming from GSM and site support equipment. In the urban

case, UMTS is noted to make a larger portion due to the inclusion of less equipment, increasing the influence of UMTS to about two thirds.

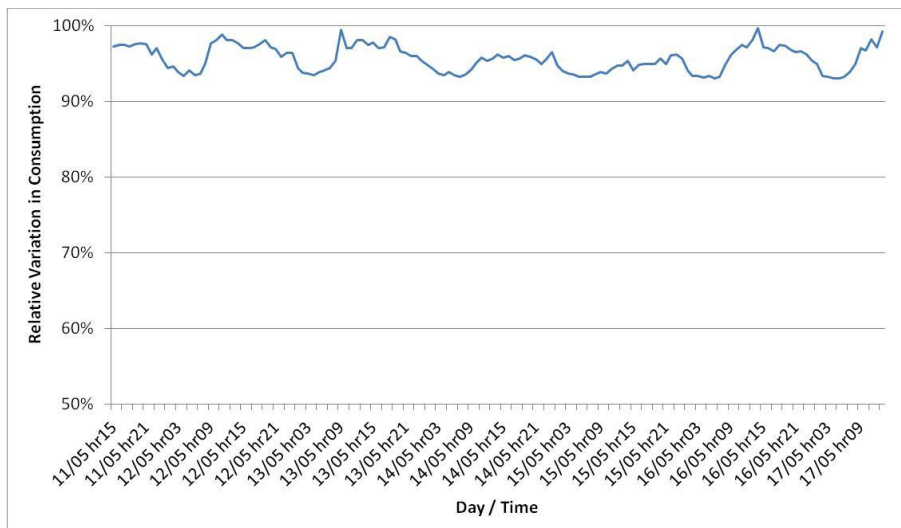

Figure A.4 – Relative variation in power consumption for the urban site. Values are normalized again a maximum value based on the rated power of the equipment.

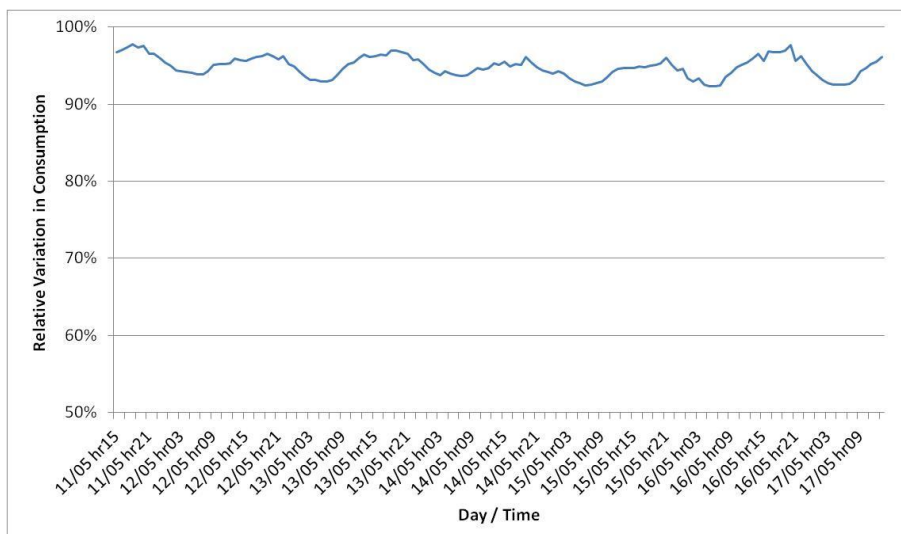

Figure A.5 – Similar to the power consumption of the urban site, the variation in power consumption is limited within 10%.

With regard to the temperature, it is noted that the location and type of site enclosure plays a major role in the expected temperature variations. In the urban case (Figure A.6), where the equipment is kept within a climate controlled room, temperature variations oscillating by no more than 1°C. The system module runs (stable) at around 12 to 13°C warmer than the ambient temperature, with the RF module running warmest at about 46°C (+20°C from ambient). The latter is also noted to be the case for both the remaining sites.

For the sub-urban case, illustrated in Figure A.7, the lack of any climate control can be noted by the temperature within the cabinet following that on the outside. In the rural case, some form of temperature control can be noted by the fact that the temperature never falls below 20°C, even if the outside temperature approaches 5°C. On closer inspection, it is noted that the oscillations in power consumption are related to variations in temperature, highlighting the relation between cooling and the power consumption.

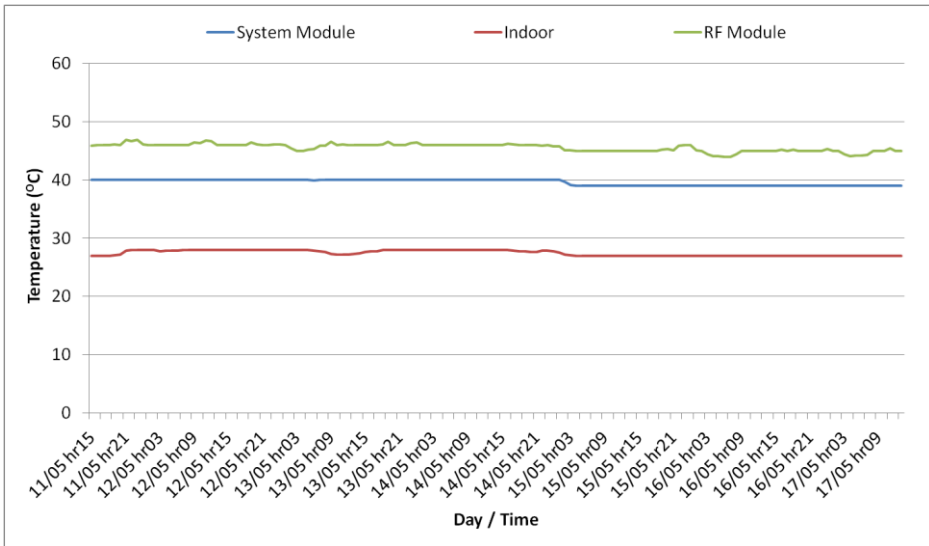

Figure A.6 – Temperature variations as measured at the urban site.

In order to improve this, it is recommended that MNOs do not place outdoor capable equipment indoor. This would generate additional heat and trigger cooling over longer periods of time. Since modern equipment can support higher temperatures, it is also important that MNOs adjust climate control settings. This reduces the time over which cooling is enabled, reducing further the energy consumption of the site.

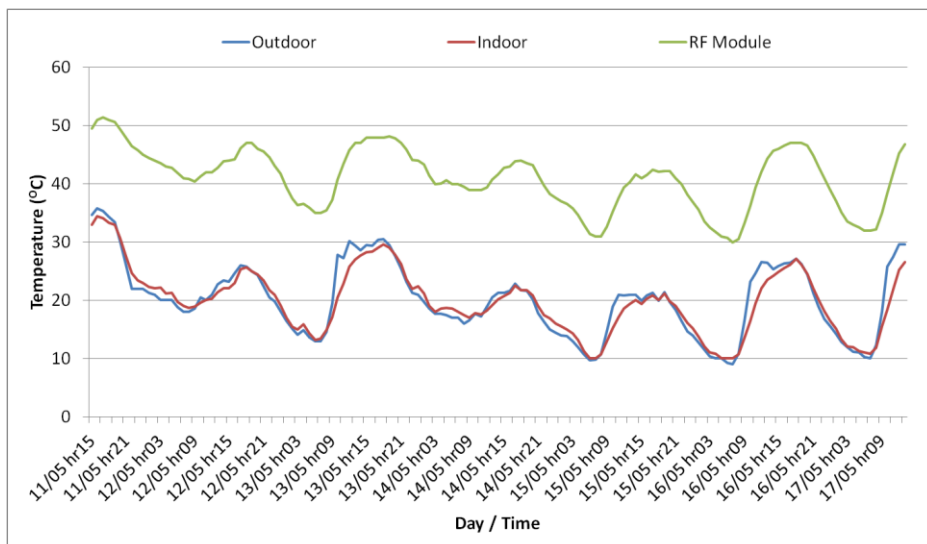

Figure A.7 - Temperature variations as measured at the outdoor sub-urban site.

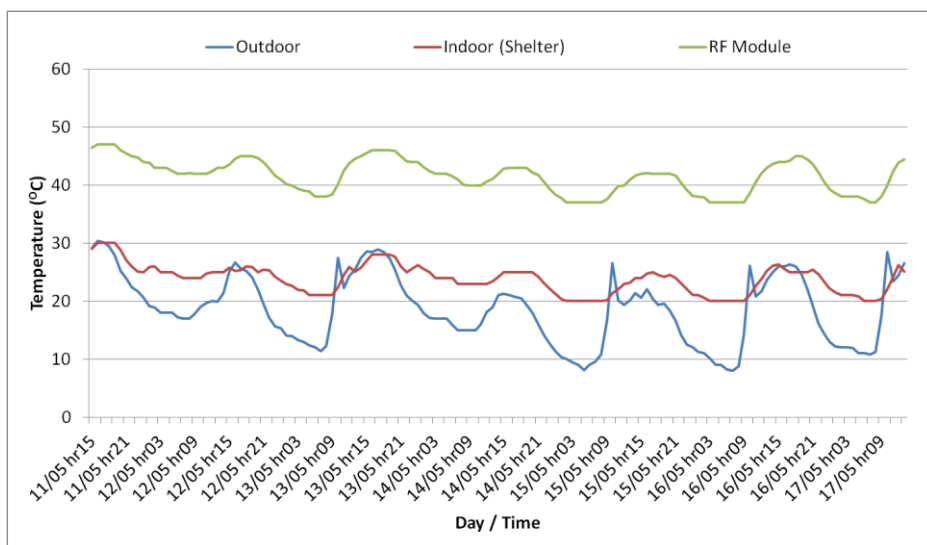

Figure A.8 – Temperature variations as measured at the rural site.

A.4 Conclusions

The measurement campaign provides relevant data on how the power consumption of base station sites varies by traffic/load and temperature. In addition to reinforcing some aforementioned statements, this campaign highlights crucial trends that can be exploited for considerable power savings at a site level. A key finding and confirmation to the assumed base station power model is that power consumption is weakly related to traffic/load. In addition to this, variations in traffic show how inefficiently site capacity is often utilized, stressing the benefits of centralized baseband capacity. The investigated sites also highlight the power saving potential of improving site configuration, reducing feeder losses with RRH, and possibly replacing RF modules with fewer, more efficient modules. With regard to temperature, it is noted that variations do have an impact on the power consumption. While, dependent on the site/equipment location, and available climate control system, it is recommended that MNOs adjust the temperature control systems to respect the actual operational temperature of equipment and possibly to install outdoor equipment outdoors.

A.4.1 Take-Away Points

The take-away points section is intended to present the main outcome of the chapter in a few straight to the point statements. For this chapter the take-away points are:

- Relatively low load over most of the investigated period (15-20%).
- Different traffic distribution on carrier and sector level - peaks occur at different instances.
- Traffic is heavily concentrated on one of the two carriers.
- Variation in power consumption is relatively low.
- In the case of a co-located site, measurements for these specific sites show UMTS equipment responsible for about a third of the power.
- Site location and climate control have a direct impact on the power consumption.

Bibliography

- [1] Dialogic, "The Architecture and Benefits of IMS," White Paper, Montreal, 2009.
- [2] "Phone Scoop," [Online]. Available: <http://www.phonescoop.com/glossary/term.php?gid=131>. [Accessed 1 April 2012].
- [3] G. Gerard, "Adapting the mobile phone: The iPhone and its consumption," *Continuum*, vol. 23, no. 2, pp. 231-244, 2009.
- [4] S. Musil, "WhatsApp reports 18 billion messages on New Year's Eve," CBS Interactive, January 2013. [Online]. Available: <http://www.cbsnews.com>. [Accessed February 2013].
- [5] S. Solomon, G.-K. Plattner, R. Knutti and P. Friedlingstein, "Irreversible Climate Change due to Carbon Dioxide Emissions," *Proceedings of the National Academy of Sciences*, vol. 106, no. 6, pp. 1704-1709, 2009.
- [6] E. Flydal, "ICT for Development and Climate Preservation? On the Need for more Realism and more Courageous Business Models," *Teletronikk*, vol. 2, pp. 84-99, 2008.
- [7] T. C. Group, "SMART 2020: Enabling the low carbon economy in the information age," Global eSustainability Initiative (GeSI), London, 2008.
- [8] M. Riaz, J. Gutierrez and J. Pedersen, "Strategies for the next generation green ICT infrastructure," in *ISABEL International Symposium on Applied Sciences in Biomedical and Communication Technologies*, Bratislava, 2009.
- [9] EC, "Impacts of information and communication technologies on energy efficiency," Bio Intelligence Service, 2008.

- [10] Vodafone, "Sustainability Report - For the year ending 31 March 2011," Vodafone Group Plc, 2011.
- [11] "Operational Efficiency," Telenor Group, 2010. [Online]. Available: <http://telenor.com/corporate-responsibility/environment-and-climate/operational-efficiency/>. [Accessed 2 April 2012].
- [12] A. Fehske, G. Fettweis, J. Malmudin and G. Biczok, "The Global Footprint of Mobile Communications: The Ecological and Economic Perspective," *IEEE Communications Magazine*, vol. 49, no. 8, pp. 55-62, 2011.
- [13] Statistische Bundesamt, "Data on Energy Price Trends," DeStatis, 2012.
- [14] E. Sutherland, "Regulating Mobile Roaming Charges," in *Conference Report on Forum Europe*, Brussels, 2011.
- [15] W.-H. Tsai, H.-W. Lo and W.-C. Chou, "Evaluation Of Mobile Services for the Future of 3G Operators," *IJMC*, vol. 7, no. 4, pp. 470-493, 2009.
- [16] R. Martignoni and K. Stanoevska-Slabeva, "Mobile Web 2.0," in *eMergence - Merging and Emerging Technologies, Processes, and Institutions*, Bled, 2007.
- [17] Ofcom, Efecet, Plextek, "Understanding the Environmental Impact of Communication Systems," Ofcom, 2009.
- [18] "OPERA-Net (Optimising Power Efficiency in mobile RAdio Networks)," [Online]. Available: <http://opera-net.org/>. [Accessed 22 March 2012].
- [19] "OPERA-Net2 (Optimising Power Efficiency in Mobile Radio Networks 2)," [Online]. Available: <http://www.celtic-initiative.org/Projects/Celtic-Plus-Projects/2011/OPERA-NET2/operanet2-default.asp>. [Accessed 22 March 2012].
- [20] "Mobile VCE," [Online]. Available: <http://www.mobilevce.com/>. [Accessed 22 March 2012].

-
- [21] "EARTH (Energy Aware Radio and Network Technology)," [Online]. Available: <https://www.ict-earth.eu/>. [Accessed 22 March 2012].
- [22] NEC, "Self Organizing Network," NEC Corporation, 2009.
- [23] J. He, P. Loskot, T. O'Farrell, S. Armour, V. Friderikos and J. Thompson, "Energy Efficient Architectures and Techniques for Green Radio Access Networks," in *Communications and Networking in China (CHINACOM)*, 2010.
- [24] C. Niephaus, N. Bayer, O. Blume, M. Siekkinen, J. Zidbeck, C. Mannweiler, L. Nuaymi and A. Nungu, "State-of-the-Art on Benchmarking Energy-aware Infrastructure," 2011.
- [25] E. Oh, "Energy Savings through Dynamic Base Station Switching in Cellular Wireless Access Networks," in *IEEE Global Telecommunications Conference*, Miami, 2010.
- [26] T. U. R. Ahsin, "Energy Efficient Resource Allocation and Deployment Strategies for Wireless Networks," in *New Technologies, Mobility and Security*, Istanbul, 2012.
- [27] T. Edler and S. Lundberg, "Energy efficiency enhancements in radio access networks," *Ericsson Review*, vol. 1, no. 1, pp. 42-51, 2004.
- [28] H. Claussen, L. T. W. Ho and F. Pivit, "Leveraging advances in mobile broadband technology to improve environmental sustainability," *Telecommunications Journal of Australia*, vol. 59, no. 1, pp. 1-18, 2009.
- [29] S. Carlaw and C. Wheelock, "Mobile Networks Go Green - Minimizing Power Consumption and Leveraging Renewable Energy," ABIresearch, 2008.
- [30] S. Banks, "Green Telecoms: Strategies and Implications for Operators," Ovum, 2008.
- [31] Unstrung_Insider, "Mobile Networks Go Green," 2008.

- [32] S. Vadgama, "Trends in Green Wireless Access," *Fujitsu Sci. Tech. J.*, vol. 45, no. 4, pp. 404-408, 2009.
- [33] S. Roy, "Energy Logic for Telecommunications," Emerson, 2008.
- [34] J. Louhi, Interviewee, *Environmental Affairs Manager, Email Discussions on the Evolution of Base Station Equipment and Comparison of Old Equipment with Current Equipment*. [Interview]. February 2011.
- [35] R. Hofmann, Interviewee, *Equipment Technology Expert (NSN), Internal Discussion on the Expected Improvements in Base Station Equipment*. [Interview]. May 2011.
- [36] B. Christiansen, Interviewee, *Business Advisor (NSN), Email Discussion on the Likelihood of Mobile Network Operators Replacing Base Station Equipment to Save Energy*. [Interview]. January 2013.
- [37] H.-O. Scheck, Interviewee, *System Specialist (NSN), Discussions on the derivation of a suitable power model that compares with measurements of real base station equipment*. [Interview]. January 2009.
- [38] R. Hofmann, Interviewee, *Equipment Technology Expert (NSN), Discussion about the impact of LTE on the power consumption of base station sites*. [Interview]. March 2011.
- [39] Cisco, "Cisco Visual Networking Index: Global Mobile," Cisco, 2012.
- [40] K. Gerwig, "Tablet devices could change user behavior and network capacity planning," SearchTelecom.com, March 2011. [Online]. Available: <http://searchtelecom.techtarget.com/feature/Tablet-devices-could-change-user-behavior-and-network-capacity-planning>. [Accessed 11 April 2012].
- [41] O. Holland, O. Cabral, F. Velez, A. Aijaz, P. Pangalos and A. H. Aghvami, "Opportunistic load and spectrum management for mobile communications energy efficiency," in *IEEE 22nd International Symposium on Personal, Indoor and Mobile Radio Communications*, Toronto, 2011.

-
- [42] J. Elling, M. Sørensen, P. Mogensen and E. Lang, "Mobile Broadband Network Evolution Towards 2015 - A Copenhagen Area Case Study," *Teletronikk*, vol. 106, no. 1, pp. 138-148, 2010.
- [43] Collaborating Partner (Telenor), *Traffic Data Measurements from Telenor Network*, Copenhagen, 2010.
- [44] Nokia Siemens Networks, "Liquid Radio - Let traffic waves flow most efficiently," White Paper, Espoo, 2011.
- [45] O. Holland, A. Attar, O. Cabral, F. J. Velez and A. H. Aghvami, "Intra-operator spectrum sharing concepts for energy efficiency and throughput enhancement," in *3rd International Symposium on Applied Sciences in Biomedical and Communication Technologies (ISABEL)*, Rome, 2010.
- [46] Ceragon Networks, "LTE Ready Mobile Backhaul," White Paper, 2009.
- [47] I. d. n. know, Showing the upgrades form HSPA to HSPA+ with some data rate figures.
- [48] H. Holma and A. Toskala, *LTE for UMTS: Evolution to LTE-Advanced*, John Wiley & Sons, 2011.
- [49] B. Woods, "ZDNet UK - Ofcom maps UK mobile coverage," 1 November 2011. [Online]. Available: <http://www.zdnet.co.uk/news/infrastructure/2011/11/01/ofcom-maps-uk-mobile-coverage-40094336/>. [Accessed 14 May 2012].
- [50] B. Nowroozi, "sonlte - Femto Forum Decides to be Small Cell Forum," 16 February 2012. [Online]. Available: <http://www.sonlte.com/2012/02/16/femto-forum-decides-to-be-small-cell-forum/>. [Accessed 14 May 2012].
- [51] Nokia Siemens Networks, "Flexi Multiradio BTS - All-purpose Flexi BTS featuring 3 technologies in 1," Espoo, 2009.
- [52] GSMA, "MIMO in HSPA: the Real-World Impact," GSMA, 2011.

- [53] Nokia Siemens Networks, "Active Antenna Systems - A step-change in base station site performance," White Paper, Espoo, 2012.
- [54] A. Khandekar, N. Bhushan, J. Tingfang and V. Vanghi, "LTE-Advanced: Heterogeneous networks," in *Wireless Conference (EW), 2010 European*, Lucca, 2010.
- [55] S. Scherzer, "Femtocell vs. Wi-Fi for Data Offloading & Indoor Coverage," *Wireless Week*, 24 February 2010. [Online]. Available: <http://www.wirelessweek.com/>. [Accessed January 2013].
- [56] M. Zhang, "Cellular Network Indoor Coverage in China: 3G Drives the Market," In-Stat, 2009.
- [57] Real Wireless, "Strategies for Mobile Network Capacity Expansion," White Paper, West Sussex, 2010.
- [58] J. Holis and P. Pechac, "Penetration Loss Measurement and Modeling for HAP Mobile Systems in Urban Environment," *EURASIP Journal on Wireless Communications and Networking*, vol. 2008, no. 1, 2008.
- [59] M. Tolstrup, *Indoor Radio Planning: A Practical Guide for GSM, DCS, UMTS, HSPA and LTE*, John Wiley & Sons, 2011.
- [60] A. Kumar, Divya and T. Singh, "Femtocell - A Review," *International Journal of Computer Science and Telecommunications*, vol. 2, no. 3, pp. 16-18, 2011.
- [61] N. Dobberstein and S. G. Chua, "Mobile Network Operators as "Smart Enablers"," A.T. Kearney, 2012.
- [62] Ovum, "The Casualties of Social Messaging," Ovum, 2012.
- [63] Vodafone, "Vodafone UK - Facts and Figures," 2011. [Online]. Available: http://www.vodafone.com/content/dam/vodafone/uk_cr/downloads/online_facts_and_figures.pdf. [Accessed 16 May 2012].

-
- [64] Digital Communications Knowledge Transfer Network, "Energy Efficient Wireless Communications (Green Radio Access Networks)," in *Wireless Technology & Spectrum Working Group*, London, 2011.
- [65] J. Louhi, "Energy efficiency of modern cellular base stations," in *29th International Telecommunications Energy Conference*, Rome, 2007.
- [66] C. Han, T. Harrold, S. Armour, I. Krikidis, S. Videv, P. M. Grant, H. Haas, J. S. Thompson, I. Ku, C.-X. Wang, T. A. Le, J. Zhang and L. Hanzo, "Green Radio: Radio Techniques to Enable Energy-Efficient Wireless Networks," *IEEE Communications Magazine*, vol. 49, no. 6, pp. 46-54, 2011.
- [67] F. Richter, A. J. Fehske and G. P. Fettweis, "Energy Efficiency Aspects of Base Station Deployment Strategies for Cellular Networks," in *IEEE 70th Vehicular Technology Conference (VTC 2009-Fall)*, 2009.
- [68] Nokia Siemens Networks, "Good Green Business Sense - Environmentally Sustainable Business is an Opportunity for Communication Service Providers," Espoo, 2008.
- [69] ETSI, "Energy Efficiency of Wireless Access Network Equipment," Technical Specification, 2009.
- [70] ABI Research, "Equipment and RF Power Device Analysis for Cellular and Mobile Wireless Infrastructure Markets," ABI Research, 2010.
- [71] W. Chen, H. Zhang, M. Cardullo, A. Forbes, T. Xiong and R. Pavio, "Linear Power Amplifiers and Transmitter Modules for Mobile Applications," in *IEEE International Conference on Solid-State and Integrated Circuit Technology*, Shanghai, 2010.
- [72] N. Idir, Y. Weens and J. Franchaud, "Skin Effect and Dielectric Loss Models of Power Cables," *Transactions on Dielectrics and Electrical Insulation*, vol. 16, no. 1, 2009.
- [73] S. Bhaumik, G. Narlikar and S. Chattopadhyay, "Breathe to Stay Cool: Adjusting Cell Sizes to Reduce Energy Consumption," in *Green Networking*,

- New Delhi, 2010.
- [74] GSMA, "Green Power for Mobile: Top Ten Findings," White Paper, London, 2009.
- [75] Ericsson, "It All Comes Back To Backhaul," White Paper, Kista, 2012.
- [76] Ceragon Networks, "Mobile Backhaul: Fiber vs. Microwave," White Paper, 2009.
- [77] W. Guo, C. Turyagyenda, H. Hamdoun, S. Wang, P. Loskot and T. O'Farrell, "Towards a Low Energy LTE Cellular Network: Architectures," in *European Signal Processing Conference 2011*, Barcelona, 2011.
- [78] K. Holger, "An Overview of Energy-Efficiency Techniques for Mobile Communication Systems," TKN Technical Reports Series, Berlin, 2003.
- [79] P. Frenger, P. Moberg, J. Malmudin, Y. Jading and I. Gódor, "Reducing Energy Consumption in LTE with Cell DTX," in *IEEE Vehicular Technology Conference*, Budapest, 2011.
- [80] A. Saadani and J.-B. Landre, "Realistic Performance of HSDPA Evolution 64-QAM in Macro-Cell Environment," in *IEEE Vehicular Technology Spring 2009*, Barcelona, 2009.
- [81] Arthur D. Little, "LTE Spectrum and Network Strategies - Strategic Options for Mobile Operators in Dynamic 4G Mobile Markets," Arthur D. Little, 2012.
- [82] Small Cell Forum, "Small Cells - What is the Big Idea?," White Paper, United Kingdom, 2012.
- [83] L. M. Correia, D. Zeller, O. Blume, D. Ferling, Y. Jading and I. Gódor, "Challenges and Enabling Technologies for Energy Aware Mobile Radio Networks," *IEEE Communications Magazine*, vol. 48, no. 11, pp. 66-72, 2010.

-
- [84] M. Deruyck, E. Tanghe, W. Joseph and L. Martens, "Modelling the Energy Efficiency of Microcell Base Stations," in *The First International Conference on Smart Grids, Green Communications and IT Energy-Aware Technologies*, Venice, 2011.
- [85] Aruba Networks, "Aruba 130 Series Access Points - Data Sheet," Aruba Networks, Sunnyvale, 2012.
- [86] NEC, "Small Cell Solutions - Small Cells for Enterprises," NEC, Leaflet, 2012.
- [87] C. Lange, K. Dirk, R. Weidmann and A. Gladisch, "Energy Consumption of Telecommunication Networks and Related Improvement Options," *IEEE Journal of Selected Topics in Quantum Electronics*, vol. 17, no. 2, pp. 285-295, 2010.
- [88] V. Viswanathan, "Efficiency Enhancement of Base Station Power Amplifiers Using Doherty Technique," Virginia Polytechnic Institute and State University, Blacksburg, 2004.
- [89] NXP, "Application and Design Manual for High Performance RF Products," NXP, Netherlands, 2011.
- [90] European Communications, "UK network share could save Telefónica and Vodafone over €1 billion," 07 June 2012. [Online]. Available: <http://www.eurocomms.com>. [Accessed 30 January 2013].
- [91] Light Reading Mobile, "Telefonica, Vodafone to Share UK Network," 7 June 2012. [Online]. Available: <http://www.lightreading.com/>. [Accessed 8 June 2012].
- [92] Telenor, "Telenor obtains new 4G licence," Press Release, 2012.
- [93] Nokia Siemens Networks, "Designing, Operating and Optimizing - Unified Heterogeneous Networks," Espoo, 2011.
- [94] F. Richter, G. Fettweis, G. Markus and B. Oliver, "Micro Base Stations in Load Constrained Cellular Mobile Radio Networks," in *IEEE 21st*

- International Symposium on Personal, Indoor and Mobile Radio Communications Workshops*, Istanbul, 2010.
- [95] H. Claussen, L. T. W. Ho and L. G. Samuel, "Financial Analysis of a Pico-Cellular Home Network Deployment," in *IEEE International Conference on Communications*, Glasgow, 2007.
- [96] K. Johansson, "Cost Effective Deployment Strategies for Heterogeneous Wireless Networks," Doctoral Dissertation in Telecommunications - KTH, Stockholm, 2007.
- [97] A. Mukherjee, S. Bhattacharjee, S. Pal and D. De, "Femtocell Based Green Power Consumption Methods for Mobile Networks," *The International Journal of Computer and Telecommunications Networking*, p. 17, 2012.
- [98] 3GPP, "Evolved Universal Terrestrial Radio Access (E-UTRA) - Further Advancements for E-UTRA Physical Layer Aspects (Release 9)," UMTS 30.03 version 3.2.0, 2010.
- [99] H. Al Hakim, S. Valentin and H. Eckhardt, "Decoupling Antenna Height and Tilt Adaptation in Large Cellular Networks," in *International Symposium on Wireless Communication Systems*, Aachen, 2011.
- [100] J.-S. Wu, C.-C. Wen and J.-K. Chung, "Hot-Spot Traffic Relief with a Tilted Antenna in CDMA Cellular Networks," *IEEE TRANSACTIONS ON VEHICULAR TECHNOLOGY*, vol. 40, no. 1, pp. 1-9, 1998.
- [101] N. Zheng, "Multi-Cell Uplink Radio Resource Management," Ph.D. Thesis, Aalborg, 2010.
- [102] N. Wie, A. Pokhariyal, C. Rom, B. Priyanto, F. Frederiksen, C. Rosa, T. Sorensen, T. Kolding and P. Mogensen, "Baseline E-Utra Downlink Spectral Efficiency Evaluation," in *IEEE Vehicular Technology Conference*, 2006.
- [103] G. Berardinelli, "Air Interface for Next Generation Mobile Communication Networks: Physical Layer Design," Aalborg University, 2010.

-
- [104] S. Chia, M. Gasparroni and P. Brick, "The Next Challenge for Cellular Networks: Backhaul," *IEEE Microwave Magazine*, vol. 10, no. 5, pp. 54-66, 2009.
- [105] COST-231 Final Report, "Digital Mobile Radio Towards Future Generation Systems Cost 231," http://www.lx.it.pt/cost231/final_report.htm.
- [106] L. Hu, I. Kovacs, P. Mogensen, O. Klein and W. Stromer, "Optimal New Site Deployment Algorithm for Heterogeneous Cellular Networks," in *IEEE Vehicular Technology Conference*, San Francisco, 2011.
- [107] C. Coletti, L. Hu, N. Huan, I. Kovacs, B. Vejlggaard, R. Irmer and N. Scully, "Heterogeneous Deployment to Meet Traffic Demand in a Realistic LTE Urban Scenario," in *IEEE Vehicular Technology Conference Fall 2012*, Quebec, 2012.
- [108] NoMor Research, "Heterogeneous LTE Networks and Inter-Cell Interference Coordination," White Paper, Munich, 2010.
- [109] I. Kovacs, P. Mogensen, C. Birger and J. Rauli, "Mobile Broadband Traffic Forecase Modeling for Network Evolution Studies," in *IEEE Vehicular Technology Conference 2011*, San Francisco, 2011.
- [110] Tellabs, "Forecasting the Take-up of Mobile Broadband Services," White Paper, 2010.
- [111] UMTS Forum, "Mobile Traffic Forecasts 2010-2020 Report," London, 2001.
- [112] Ofcom, "Consultation on assessment of future mobile competition and proposals for the award of 800 MHz and 2.6 GHz spectrum and related issues," Ofcom, 2011.
- [113] Y. Chen, S. Zhang and S. Xu, "Fundamental Trade-Offs on Green Wireless Networks," *IEEE Communications Magazine*, vol. 49, no. 6, pp. 30-37, 2011.
- [114] Collaborating Partner (European Operator), *Overview of site types within a national bases*, 2011.

- [115] P. Okvist and A. Simonsson, "LTE HetNet Trial - Range Expansion including Macro/Pico Indoor Coverage Survey," in *IEEE Vehicular Technology Conference*, Quebec, 2012.
- [116] G. Bianchi, "Performance Analysis of the IEEE 802.11 Distributed Coordination Function," *IEEE Journal On Selected Areas In Communications*, vol. 18, no. 3, pp. 535-547, 2000.
- [117] L. Hu, C. Coletti, N. Huan, I. Kovacs, B. Vejlgaard, R. Irmer and N. Scully, "Realistic Indoor Wi-Fi and Femto Deployment Study as the Offloading Solutions to LTE Macro Network," in *IEEE Vehicular Technology Conference Fall*, Quebec, 2012.
- [118] G. Micallef, "Methods for Reducing the Energy Consumption of Mobile Broadband Networks," *Teletronikk*, vol. 106, no. 1, pp. 121-128, 2010.
- [119] S. McLaughlin, P. M. Grant, J. S. Thompson, H. Haas, D. I. Laurenson, C. Khirallah, Y. Hou and R. Wang, "Techniques for Improving Cellular Radio Base Station Energy Efficiency," *IEEE Wireless Communications*, vol. 18, no. 5, pp. 10-17, 2011.
- [120] 3GPP TSG RAN WG3, "Energy Saving Function in WCDMA," Ericsson, Jeju, South Korea, 2009.
- [121] O. Blume, H. Eckhardt, S. Klein, E. Kuehn and W. M. Wajda, "Energy Saving in Mobile Networks Based on Adaptation to Traffic Statistics," *Bell Labs Technical Journal*, vol. 15, no. 2, pp. 77-94, 2010.
- [122] 3GPP TSG RAN WG3, "LTE Energy Saving Solution Proposal Following Discussions at RAN3#65 bis," Ericsson, Jeju, Korea, 2009.
- [123] M. Deruyck, E. Tanghe, W. Joseph and L. Martens, "Characterisation and Optimisation of the Power consumption in Wireless Access Networks by Taking Daily Traffic Variations Into Account," *EURASIP Journal on Wireless Communications and Networking*, vol. 2012, no. 248, 2012.
- [124] L. Saker and S. E. Elayoubi, "Sleep Mode Implementation Issues in Green Base Stations," in *IEEE Personal, Indoor and Mobile Radio*

Communications, Istanbul, 2010.

- [125] G. Micallef, P. Mogensen and H.-O. Scheck, "Cell Size Breathing and Possibilities to Introduce Cell Sleep Mode," in *IEEE European Wireless Conference*, Lucca, 2010.
- [126] G. Micallef, P. Mogensen and H.-O. Scheck, "Dual-Cell HSDPA for Network Energy Saving," in *IEEE Vehicular Technology Conference*, Taipei, 2010.
- [127] T. Nihtil and V. Haikola, "HSDPA MIMO System Performance in Macro Cell Network," in *IEEE Sarnoff Symposium*, Princeton, 2008.
- [128] 4. Americas, "MIMO and Smart Antennas for Mobile Broadband Systems," 4G Americas, 2012.
- [129] G. Micallef, P. Mogensen, H.-O. Scheck and E. Lang, "Energy Efficient Evolution of Mobile Networks - Macro Only Upgrades vs. a Joint-Pico Deployment Strategy," in *IEEE Vehicular Technology Conference 2011*, Budapest, 2011.
- [130] C. Coletti, P. Mogensen and R. Irmer, "Performance Analysis of Relays in LTE for a Realistic Suburban Deployment Scenario," in *IEEE Vehicular Technology Conference*, Budapest, 2011.
- [131] Ofcom, "Variation of 900 MHz, 1800 MHz and 2100 MHz Mobile Licences," Ofcom, 2013.
- [132] P. Rysavy, "High Tech Forum," 5 March 2012. [Online]. Available: www.hightechforum.org. [Accessed 24 February 2013].
- [133] Nokia Siemens Networks, "Flexi Compact Base Station - Macro Base Station in Micro Size," Data Sheet, Espoo, 2012.
- [134] W. Karner, A. Paier and M. Rupp, "Indoor Coverage Prediction and Optimization for UMTS Macro Cells," in *International Symposium on Wireless Communication Systems*, 2006.

-
- [135] H. Beijner, "The Importance of In-Building Solutions in Third-Generation Networks," *Ericsson Review*, no. 2, pp. 90-97, 2004.
- [136] P. Rinaldi, "The Hydrogen for Base Radio Stations," in *International Telecommunications Energy Conference*, Rome, 2007.
- [137] A. Ulbig and G. Andersson, "Towards Variable End-Consumer Electricity Tariffs Reflecting Marginal Costs: A Benchmark Tariff," in *Conference on the European Energy Market*, 2010.
- [138] Tango Telecom, "Dynamic Pricing Service," Leaflet, Limerick, 2011.
- [139] Ericsson, "Control Traffic Cut Costs - Dynamic Discount Solution," Ericsson AB, Stockholm, 2010.
- [140] Vodafone, "Sustainability 2012 Summary Report," Vodafone Group, Newbury, 2012.
- [141] mvce_desc, "description of mvce project".
- [142] new_architectures, "study that shows academics looking at new architectures".
- [143] new_standards, "publications that describes new standards for saving energy".
- [144] new_algorithms, "publications that describes an improved algorithm".
- [145] C. Despins, F. Labeau, T. L. Ngoc, R. Labelle, M. Cheriet, C. Thibeault, F. Gagnon, A. Leon-Garcia, O. Cherkaoui, B. St. Arnaud, J. Mcneill, Y. Lemieux and M. Lemay, "Leveraging green communications for carbon emission reductions: Techniques, testbeds, and emerging carbon footprint standards," *IEEE Communications Magazine*, vol. 49, no. 8, pp. 101-109, 2011.
- [146] ADC Krone, "Fibre Delivery in Next Generation Wireless Networks," White Paper, 2010.

-
- [147] B. Ayvazian, "Business Case for Small Cell Deployment," 7 December 2011. [Online]. Available: [http://www.ateshow.com/agile_assets/373/0935_Day_1_HetNet_Americas_2011_Berge_Ayvazian_Heavy_Reading_-_Copy_\(2\).pdf](http://www.ateshow.com/agile_assets/373/0935_Day_1_HetNet_Americas_2011_Berge_Ayvazian_Heavy_Reading_-_Copy_(2).pdf). [Accessed 25 June 2012].
- [148] J. Pigg, "Squeezing Cost Out of Mobile Backhaul," Yankee Group, London, 2010.
- [149] Motorola, "Alternative Power for Mobile Telephony Base Stations," White Paper, 2007.
- [150] Z. Hasan, H. Boostanimehr and V. Bhargava, "Green Cellular Networks: A Survey, Some Research Issues and Challenges," *IEEE Communications Surveys & Tutorials*, vol. 13, no. 4, pp. 524-540, 2011.
- [151] T. S. Rappaport, *Wireless communications principles and practice*, second, Prentice Hall, 2001.
- [152] L. Jyrki and H.-O. Scheck, Interviewees, *Discussion on the adaptation of power models for LTE*. [Interview]. February 2011.

Abbreviations

AAS	Active Antenna System
AP	Access Point
CO ₂	Carbon Dioxide
DEM	Digital Elevation Map
DLU	Digital Land Use
EC	European Commission
EU	European Union
GHG	Green House Gases
GSM	Global System for Mobile Communications
HSPA	High Speed Packet Access
ICT	Information and Communications Technology
ISD	Intersite Distance
ISM	Industrial, Scientific, and Medical
Kbps	Kilobits per second
LOS	Line-of-Sight
M2M	Machine-to-Machine
Mbps	Megabits per second
MHz	Megahertz
MIMO	Multiple Input Multiple Output
MNO	Mobile Network Operator

MW	Microwave
RAT	Radio Access Technology
RF	Radio Frequency
RNC	Radio Network Controller
RRH	Remote Radio Head
RRU	Remote Radio Unit
SINR	Signal to Interference Plus Noise Ratio
SNR	Signal-to-Noise Ratio
SoC	System on Chip
UMTS	Universal Mobile Telecommunications System
xDSL	x Digital Subscriber Line
YoY	Year-on-Year