



Aalborg Universitet

AALBORG UNIVERSITY  
DENMARK

## Novel Control Strategies for Parallel-Connected Inverters in AC Microgrids

Guan, Yajuan

DOI (link to publication from Publisher):  
[10.5278/vbn.phd.engsci.00135](https://doi.org/10.5278/vbn.phd.engsci.00135)

Publication date:  
2016

Document Version  
Publisher's PDF, also known as Version of record

[Link to publication from Aalborg University](#)

Citation for published version (APA):  
Guan, Y. (2016). *Novel Control Strategies for Parallel-Connected Inverters in AC Microgrids*. Aalborg Universitetsforlag. <https://doi.org/10.5278/vbn.phd.engsci.00135>

### General rights

Copyright and moral rights for the publications made accessible in the public portal are retained by the authors and/or other copyright owners and it is a condition of accessing publications that users recognise and abide by the legal requirements associated with these rights.

- Users may download and print one copy of any publication from the public portal for the purpose of private study or research.
- You may not further distribute the material or use it for any profit-making activity or commercial gain
- You may freely distribute the URL identifying the publication in the public portal -

### Take down policy

If you believe that this document breaches copyright please contact us at [vbn@aub.aau.dk](mailto:vbn@aub.aau.dk) providing details, and we will remove access to the work immediately and investigate your claim.



**NOVEL CONTROL STRATEGIES FOR  
PARALLEL-CONNECTED INVERTERS IN  
AC MICROGRIDS**

**BY  
YAJUAN GUAN**

DISSERTATION SUBMITTED 2016



**AALBORG UNIVERSITY**  
DENMARK



# **NOVEL CONTROL STRATEGIES FOR PARALLEL-CONNECTED INVERTERS IN AC MICROGRIDS**

by

Yajuan Guan



**AALBORG UNIVERSITY**  
DENMARK

Dissertation submitted to  
the Faculty of Engineering and Science at Aalborg University

for the degree of  
Doctor of Philosophy in Electrical Engineering

Thesis submitted: 16. August, 2016  
PhD supervisor: Prof. Josep M. Guerrero,  
Aalborg University  
Assistant PhD supervisor: Associate Prof. Juan C. Vasquez,  
Aalborg University  
PhD committee: Prof. Francesco Iannuzzo, Aalborg University  
Prof. Ricardo Quadros Machado, Universidade de São Paulo  
Associate Prof. Helena Martín, Universitat Politècnica de Catalunya. BarcelonaTech.  
PhD Series: Faculty of Engineering and Science, Aalborg University

ISSN (online) – 2246-1248  
ISBN (online) - 978-87-7112-775-1

Published by:  
Aalborg University Press  
Skjernvej 4A, 2nd floor  
DK – 9220 Aalborg Ø  
Phone: +45 99407140  
aauf@forlag.aau.dk  
forlag.aau.dk

© Copyright by author

Printed in Denmark by Rosendahls, 2016

## **Mandatory page in PhD theses:**

### **1. Thesis title.**

Novel Control Strategies for Parallel-connected Inverters in AC Microgrids

### **2. Name of PhD student.**

Yajuan Guan

### **3. Name and title of supervisor and any other supervisors.**

Supervisor: Josep M. Guerrero, Professor;

Co-supervisor: Juan C. Vásquez, Associate Professor.

### **4. List of published papers.**

#### **1st Authored Journal Publications:**

- Guan, Y., Guerrero, J.M., Zhao, X., Vasquez, J.C., Guo, X. “A New Way of Controlling Parallel-Connected Inverters by Using Synchronous-Reference-Frame Virtual Impedance Loop—Part I: Control Principle,” *Power Electronics, IEEE Transactions on*, vol. 31, no. 6, pp: 4576 - 4593, June. 2016.
- Yajuan Guan, Juan C. Vasquez, Josep M. Guerrero, Yibo Wang, Wei Feng. “Frequency Stability of Hierarchically Controlled Hybrid Photovoltaic-Battery-Hydropower Microgrids,” *IEEE Transactions on Industry Applications*, vol. 51, no. 6, pp: 4729 - 4742, June. 2015.
- Yajuan Guan, Juan C. Vasquez, Josep M. Guerrero. “Coordinated Secondary Control for Balanced Discharge Rate of Energy Storage System in Islanded AC Microgrids,” *IEEE Transactions on Industry Applications*, vol., no. 99, pp: 1 - 1, 2016.
- Yajuan Guan, Lexuan Meng, Chendan Li, Juan C. Vasquez, Josep M. Guerrero. “A Dynamic Consensus Algorithm to Adjust Virtual Impedance Loops for Discharge Rate Balancing of AC Microgrid Energy Storage Units,” *IEEE Transactions on Smart Grid*, 2016, under second review.

#### **1st Authored Conference Publications:**

- Yajuan Guan, Vasquez, J.C., Guerrero, J.M., “A simple autonomous current-sharing control strategy for fast dynamic response of parallel inverters in

- islanded microgrids,” *Energy Conference (ENERGYCON), 2014 IEEE International*, pp. 182-188, 13-16 May 2014, Cavtat.
- Yajuan Guan, Vasquez, J.C., Guerrero, J.M., Dan Wu, Yibo Wang, Wei Feng, “Frequency stability of hierarchically controlled hybrid photovoltaic-battery-hydropower microgrids,” *Energy Conversion Congress and Exposition (ECCE)*, pp. 1573 – 1580, 14-18 Sept. 2014, Pittsburgh, PA, USA.
  - Yajuan Guan, Vasquez, J.C., Guerrero, J.M., Alves Coelho, E.A. “Small-signal modeling, analysis and testing of parallel three-phase-inverters with a novel autonomous current sharing controller,” *Applied Power Electr. Conf. and Expo. (APEC), 2015 IEEE*, pp. 571 – 578, Charlotte, NC, 15-19 Mar. 2015.
  - Yajuan Guan, Josep M. Guerrero, and Juan C. Vasquez, “Coordinated Secondary Control for Balanced Discharge Rate of Energy Storage System in Islanded Microgrids,” *9th International Conference on Power Electronics - ECCE Asia*, 1-5 June, 2015, Seoul, Korea.
  - Yajuan Guan, Juan C. Vasquez and Josep M. Guerrero, “Hierarchical Controlled Grid-Connected Microgrid based on a Novel Autonomous Current Sharing Controller,” *Energy Conversion Congress and Exposition (ECCE), 2015 IEEE*, 20-24 Sept. 2015, Montreal, Canada.
  - Yajuan Guan, Juan C. Vasquez and Josep M. Guerrero, “Comparison of a Synchronous Reference Frame Virtual Impedance-Based Autonomous Current Sharing Control with Conventional Droop Control for Parallel-Connected Inverters,” *8th International Power Electronics and Motion Control Conference - ECCE Asia (IPEMC 2016-ECCE Asia)*, 22-25 May, 2016, Hefei, China.
  - Yajuan Guan, Lexuan Meng, Chendan Li, Vasquez, J.C., Guerrero, J.M., “Discharge Rate Balancing Control Strategy Based on Dynamic Consensus Algorithm for Energy Storage Units in AC Microgrids,” *Applied Power Electr. Conf. and Expo. (APEC), 2016 IEEE*, submitted.
  - Yajuan Guan, Wei Feng, Vasquez, J.C., Guerrero, J.M., “A New Harmonic Current Sharing Control Strategy for Parallel-Connected Inverters,” *Applied Power Electr. Conf. and Expo. (APEC), 2016 IEEE*, submitted.

#### **Selected co-authored Publications:**

- Wei Feng, Kai Sun, Yajuan Guan, Josep M. Guerrero, Xi Xiao “Active Power Quality Improvement Strategy for Grid-connected Microgrid Based on Hierarchical Control,” *IEEE Transactions on Smart Grid*, 2016, under second review.
- Emilio J. Palacios-García, Yajuan Guan, Mehdi Savaghebi, Juan C. Vásquez, Josep M. Guerrero, Antonio Moreno-Munoz, Brian S. Ipsen. "Smart metering system for microgrids," *Industrial Electronics Society, IECON 2015 - 41st Annual Conference of the IEEE*, pp: 003289-003294, 9-12 Nov. 2015, Yokohama, Japan.
- Firoozabadi Mehdi Savaghebi, Guan, Yajuan, Quintero Juan Carlos Vasquez, Guerrero Josep M., Nielsen, Carsten. "Voltage Harmonics Monitoring in a Microgrid Based on Advanced Metering Infrastructure (AMI)," *Proceedings of*



*the Seminario Anual de Automática, Electrónica Industrial e Instrumentación 2015 (SAAEI'15). 2015.*

- Wei Feng, Kai Sun, Yajuan Guan, Josep M. Guerrero, Xi Xiao. "A harmonic current suppression control strategy for droop-controlled inverter connected to the distorted grid," *Energy Conversion Congress and Exposition (ECCE), 2015 IEEE*, 20-24 Sept. 2015, Montreal, Canada.
- Wei Feng, Kai Sun, Yajuan Guan, Josep M. Guerrero, Xi Xiao. "The frequency fluctuation impact analysis for droop controlled grid-connecting inverter in microgrid," *International Power Electronics and Motion Control Conference (IPEMC-ECCE Asia), 2016 IEEE*, 22-26 May, Hefei, China.
- Feng Wei, Sun Kai, Yajuan Guan, Yibo Wang. "A novel frequency restoring strategy of hydro-PV hybrid microgrid," *International Power Electronics and Application Conference and Exposition (PEAC), 2014 IEEE*, 5-8 Nov. 2014, Shanghai, China.





## CV

Yajuan Guan (S'14) received the B.S. degree and M.S. degree in Electrical Engineering from the Yanshan University, China, in 2007 and 2010 respectively. From 2010 to 2012, she was an Assistant Professor in Institute of Electrical Engineering (IEE), Chinese Academy of Sciences (CAS). Since 2013, she has been a Lecturer in IEE, CAS. She is currently working toward her Ph.D. degree at the Department of Energy Technology, Aalborg University, Denmark, as part of the Denmark Microgrids Research Programme ([www.microgrids.et.aau.dk](http://www.microgrids.et.aau.dk)).

Her research interests include microgrids, distributed generation systems, power converters for renewable energy generation systems, and ancillary services for microgrids.



# ENGLISH SUMMARY

Concerns regarding power supply security, environmental issues, and the liberalization of electricity markets have led to a new trend of generating power locally at the distribution voltage level instead of the conventional centralized power generation system. Microgrid (MG) has become one of the most promising active distribution networks. They are typically equipped with power electronic interfaces (PEIs) and controlled to provide the required flexible operation and to maintain the specified power quality and energy output. With regard to multi-PEIs in parallel, the power droop control method has been commonly adopted in the last decade as the decentralized control in MGs. However, this approach has several inherent drawbacks, such as slow dynamic response, active/reactive power coupling, and sensitivity to line impedance.

This project proposes a novel autonomous current sharing control strategy for paralleled voltage-controlled inverters (VCIs) in AC MGs to provide faster transient response, better active/reactive power decoupling sharing, and wider application ranges for different line impedances than the conventional power droop controller. And then, develop a complete small-signal state-space model for the proposed controller in order to analyze the stability and parameter sensitivity. Furthermore, a hierarchical control is developed, including primary, secondary, and tertiary control levels that are differentiated based on the proposed novel primary current sharing control strategy in various applications. These applications include grid-connected mode and discharge rates balancing control for energy storage units. In addition, control strategy design and frequency/voltage stability analysis of multi-source hybrid MGs in remote areas are other research issues addressed in this project.

This thesis starts by investigation of a simpler and faster autonomous current-sharing controller, which consists of a synchronous-reference-frame (SRF) virtual resistance (VR) loop, an SFR phase-locked loop (PLL), and a proportional-resonant (PR) controller in a voltage control loop. The proposed control strategy provides instantaneous and independent direct and quadrature currents sharing for paralleled VCIs. In contrast with the conventional droop control, there is no need to calculate active/reactive power. An integrated small-signal state-space model for the two parallel VCIs with the proposed controller is developed. Root locus shows lower sensitivity of the parameters over system dynamics and larger stability margin compared with those of droop control. For a seamless transition between islanded mode and grid-connected mode, an appropriate hierarchical control is proposed for the SRF-VR-based novel primary control strategy.

Considering the slow transient response and high parameter sensitivity provided by the droop-based state-of-charge (SoC) coordinated control, as well as the absence of a balanced discharge rate control methods for AC MGs, a coordinated secondary

control strategy is proposed based on the presented autonomous current-sharing controller to balance the discharge rates of ESSs in islanded AC MGs. The coordinated secondary controller can prevent overcurrent incidents and unintentional outages in distributed generation (DG) units by regulating the power outputs of the DG units according to their SoC values and ESS capacities. A dynamic consensus algorithm (DCA)-based distributed secondary control scheme is also proposed in this project to decrease the risk of single point of failures (SPOF) caused by a centralized controller. This scheme achieves not only distributed balanced discharge rate control, but also high reliability, expandability, and flexibility because of its distributed control architecture. A detailed discrete state-space model with the proposed SoC coordinated controller is developed by considering the discrete nature of the DCA.

The complementary technical features of a multi-source hybrid MG make it suitable for supplying power in remote areas. To achieve a stable parallel operation of a hydropower station and a photovoltaic (PV)-battery system with different nominal power capacities, inertia, and control mechanisms, a hierarchical control scheme for an islanded PV-battery-hydropower hybrid MG is proposed. The proposed control strategy provides stable and complete decoupling power control between the hydropower station and the PV-battery system. The interaction behavior between these two units during disturbances can be effectively mitigated. An integrated small-signal state-space model for both the hydroelectric power and the PV-battery system is developed to analyze the frequency and voltage stability of the hybrid MG.

Consequently, in order to verify the effectiveness and performance of the proposed control strategies and modeling methods, hardware-in-the-loop (HIL) simulation studies and experiments on a multi-three-phase inverter-based platform are conducted in an intelligent MG laboratory. The proposed controller is expected to be implemented in real applications to provide superior performances. The generalized modeling methods, with verified correctness and accuracy, can give insight view of the distributed control scheme and the impact of high level control on system dynamics.

**Keywords:** Microgrids, parallel inverters, virtual resistance, droop control, modeling, hierarchical control, DCA, balanced discharge rate, PV-battery-hydropower hybrid microgrid, frequency stability.

# DANSK RESUME

Bekymringer vedrørende strømforsyning sikkerhed, miljøspørgsmål, og liberaliseringen af elmarkederne har ført til en ny tendens til at generere strøm lokalt på fordelingen spændingsniveau i stedet for den konventionelle centraliseret elproduktion system. Microgrid (MG) er blevet en af de mest lovende aktive distributionsnet. De er typisk udstyret med power elektroniske grænseflader (PEIS) og kontrolleres for at give den nødvendige fleksibel drift og opretholde den angivne strømkvalitet og energi output. Med hensyn til multi-PEI'er parallelt, har magt hængende kontrolmetode den været almindeligt vedtaget i det sidste årti, da den decentrale styring i MG fabrikken. Men denne fremgangsmåde har adskillige iboende ulemper, såsom langsom dynamisk respons, aktiv / reaktiv effekt kobling, og følsomhed over for impedansen.

Dette projekt foreslår en roman autonom nuværende strategi kontrol deling for parallel spænding-kontrollerede invertere (VCis) i AC MG fabrikken at give hurtigere transient respons, bedre aktiv / reaktiv effekt afkobling deling og bredere anvendelse intervaller for forskellige line impedanser end den konventionelle magt hængende controller . Og så, udvikle en komplet små-signal state-space model for den foreslåede controller for at analysere stabiliteten og parameteren følsomhed. Endvidere er en hierarkisk styring udviklet, herunder primære, sekundære og tertiære kontrol niveauer, der er differentieret på grundlag af den foreslåede nye primære løbende kontrol deling strategi i forskellige applikationer. Disse applikationer omfatter nettilsluttede tilstand og udledning satser balancering kontrol for energi lagerenheder. Desuden kontrolstrategi design og frekvens / spænding stabilitet analyse af multi-source hybrid maskingeværers i fjerntliggende områder er andre forskningsspørgsmål behandles i dette projekt.

Denne afhandling begynder ved undersøgelse af en enklere og hurtigere autonome strøm-deling controller, som består af en synkron-henvisning-frame (SRF) virtuelle modstand (VR) loop, en SFR faselåst sløjfe (PLL), og en proportional-resonant (PR) controller i en spænding styresløjfe. Den foreslåede kontrolstrategi giver øjeblikkelige og uafhængige direkte og kvadratur strømninger deling for parallel VCis. I modsætning til den konventionelle statik kontrol, er der ikke behov for at beregne aktiv / reaktiv effekt. En integreret små-signal state-space model for de to parallelle VCis med den foreslåede controlleren er udviklet. Root locus viser lavere følsomhed af parametre over systemets dynamik og større stabilitet margin sammenlignet med de statik kontrol. For en problemfri overgang mellem islanded mode og grid-tilsluttet tilstand, foreslås en passende hierarkisk kontrol for SRF-VR-baserede roman primære kontrolstrategi.

I betragtning af den langsomme forbigående reaktion og høj parameter følsomhed leveres af hængende-baserede state-of-charge (SoC) koordineret kontrol, samt fraværet

af en afbalanceret metoder til AC MG fabrikkens udledning sats kontrol, er en samordnet strategi fornyet kontrol foreslås baseret på den præsenterede autonome nuværende deling controller til at afbalancere udledning satser ESSs i islanded AC MG fabrikkens. Den koordinerede sekundære controller kan forhindre overstrøm hændelser og utilsigtede udfald i decentral produktion (GD) enheder ved at regulere magt udgange GD-enheder i henhold til deres SoC værdier og ESS kapacitet. En dynamisk konsensus algoritme (DCA) -baserede fordelt fornyet kontrol er også foreslåede ordning i dette projekt for at mindske risikoen for enkelt fejl (SPOF) forårsaget af en centraliseret controller. Denne ordning opnår ikke blot fordelt afbalanceret udledning hastighedsstyring, men også høj pålidelighed, udvidelsesmuligheder og fleksibilitet på grund af dens distribueret styring arkitektur. En detaljeret diskret state-space model med den foreslåede SoC koordineret controlleren er udviklet ved at betragte den diskrete karakter af DCA.

De komplementære tekniske funktioner i en multi-source hybrid MG gør den velegnet til at levere strøm i fjerntliggende områder. For at opnå en stabil parallel drift af et vandkraft station og en solcelle (PV) -Batteri-system med forskellige nominelle effekt kapacitet, inert, og kontrolmekanismer, en hierarkisk ordning for en islanded PV-batteri-vandkraft hybrid foreslås MG kontrol. Den foreslåede kontrolstrategi giver stabil og fuldstændig afkobling effektstyring mellem vandkraftværket og PV-batterisystem. Interaktionen adfærd mellem disse to enheder under forstyrrelser effektivt kan afbødes. En integreret små-signal state-space model for både vandkraft og PV-batteri er udviklet til at analysere hyppigheden og spænding stabilitet af den hybride MG.

Derfor for at kontrollere effektiviteten og ydeevnen af de foreslåede kontrol strategier og modellering metoder, hardware-in-the-loop (HIL) simulering undersøgelser og eksperimenter på en multi-trefaset inverter-baseret platform foregår på en intelligent MG laboratorium. forventes foreslåede controller, der skal gennemføres i reelle applikationer til at give overlegne præstationer. De generaliserede modellering metoder, med verificeret korrekthed og nøjagtighed, kan give indsigt visning af distribueret kontrolsystem og virkningen af højt niveau kontrol af systemets dynamik.

Nøgleord: Microgrids, parallelle invertere, virtuel modstand, hænge kontrol, modellering, hierarkisk kontrol, dynamisk konsensus algoritme, afbalanceret udledning sats, PV-batteri-vandkraft hybrid elsystemet, frekvens stabilitet.







# ACKNOWLEDGEMENTS

The Ph.D. study, entitled ‘Novel Control Strategies for Parallel-connected Inverters in AC Microgrids’, is carried out from September 2013 till August 2016, under the supervision of Prof. Josep M. Guerrero, from the Department of Energy Technology, Aalborg University (AAU), Denmark. I would like to thank the department for the financial support during the period of my study.

First and foremost, I would like to express my special appreciation and thanks to my advisor Prof. Josep M. Guerrero who have been a tremendous mentor for me. I appreciate all his contributions of professional guidance, time, ideas, encouragements and funding to make my research works and Ph.D. experience smoothly and stimulating. The joy and enthusiasm he has for his research were contagious and motivational for me. His advices on both researches as well as on my career have been priceless.

My sincerely acknowledgement is also given to my co-supervisor, Associate Prof. Juan C. Vasquez, for his constructive guidance, penitent explanations, technical suggestions, valuable experimental experiences and continuous encouragements.

I would also like to sincerely thank my committee members, Prof. Francesco Iannuzzo, Associate Prof. Helena Martín, and Prof. Ricardo Quadros Machado for serving as my committee members. I also want to thank you for letting my defense be an enjoyable moment, and for all your comments and suggestions, thanks to you.

I would like to give my sincere appreciation to Prof. Ernane Coelho, Associate Prof. Tomislav Dragicevic and Dr. Mehdi Savaghebi Firoozabadi for their scientific advices and knowledges, insightful discussions and suggestions.

My gratefulness is also specially given to Associate Prof. José Matas Alcalá, at Polytechnic University of Catalonia (UPC), Barcelona, Spain, for his valuable suggestions, extension of my knowledge, and making me a pleasant stay at UPC. I would also like to thank Associate Prof. Helena Martín, Associate Prof. Jorge de la Hoz Casas, Associate Prof. Moisès Graells from UPC, Spain, for the great cooperation and supports. I am very grateful to Dr. Jordi El Mariache and Dr. Sajad Abdalinejad for their friendship and happy memories they gave me in Spain.

The members of the microgrid research group have contributed immensely to my personal and professional time at AAU. The group has been a source of friendships as well as good advices and collaborations. I would like to acknowledge all the group members, Qobad Shafiee, Lexuan Meng, Dan Wu, Chendan Li, Chi Zhang, Xin Zhao, Bo Sun, Hengwei Lin, Adriana Luna, Nelson Diaz, Baoze Wei, Amjad

Anvari-Moghaddam, Wenzhao Liu, Jinghang Lv, Saeed Golestan, Renke Han, Zheming Jin, Siavash Beheshtaein, and all, and the numerous guest students who have come through the lab, and Weili Kao for their support and friendship, which creates me an enthusiastic and pleasant search and life environment. I am so grateful for the time spent with them and for so many beautiful memories.

I am always grateful to have my colleagues in other search groups of AAU and friends, Jie Tian, Xiongfei Wang, Waruna Wijesekara, Qian Wu, Min Huang, Yanjun Tian, Qian Wang, Yanbo Wang, Ke Ma, Ting Ting Liu, Lena Elsborg, Min Chen, Wenmin Zhao, Zhilei Yao, Jing Xu, and all, for the useful suggestions, important support and the happy time they gave me.

My gratitude is also sent to all the staffs and friends at Department of Energy Technology for their kind assistance during my study.

My time at AAU was quiet enjoyable due to the many colleagues, friends and groups that became a part of my life.

My especially acknowledgement is also expressed to all my colleagues in Institute of Electrical Engineering (IEE), Chinese Academy of Sciences (CAS), especially Prof. Honghua Xu, Prof. Yibo Wang, Dr. Huan Wang, Dr. Zilong Yang and Rui Cao, for their continuous supports, encouragements, and kindness understanding during my Ph.D. study.

Last but not least, I would like to give my deepest appreciation to my grandparents, Mr. Xueshang Liu, Mrs. Lanju Hao, my parents, Mr. Quanwen Guan, Mrs. GuoHua Liu, my husband, Dr. Wei Feng, my parents-in-law, and all my families, for their endless love, constant encouragements and unconditional supports.

Yajuan Guan

关雅娟

Aalborg University

Aalborg, Denmark

19-05-2016

# TABLE OF CONTENTS

<b>Chapter 1. Introduction.....</b>	<b>1</b>
1.1. Microgrid concept and challenges.....	1
1.1.1. Microgrid concept.....	1
1.1.2. Challenges for microgrids.....	2
1.2. Hierarchical control theory.....	3
1.3. Primary control—general introduction and motivation.....	4
1.3.1. Conventional power droop control.....	4
1.3.2. Voltage-current droop control—motivation.....	6
1.4. Secondary control—general introduction and motivation.....	8
1.4.1. Centralized control.....	8
1.4.2. Decentralized control and the consensus algorithm.....	8
1.4.3. Coordinated control for balancing discharge rate—motivation.....	10
1.5. Grid-connected microgrids with tertiary control—general introduction and motivation.....	12
1.6. Hybrid microgrids.....	12
1.6.1. Hybrid AC/DC microgrid.....	12
1.6.2. VCI- and CCI-based hybrid microgrid.....	13
1.6.3. VCI- and synchronous generator-based hybrid microgrid—motivation.....	14
1.7. Thesis contribution.....	16
1.8. Thesis objectives.....	18
1.9. Thesis outline.....	19
<b>Chapter 2. Paper 1.....</b>	<b>22</b>
<b>Chapter 3. Paper 2.....</b>	<b>23</b>
<b>Chapter 4. Paper 3.....</b>	<b>24</b>
<b>Chapter 5. Paper 4.....</b>	<b>25</b>
<b>Chapter 6. Paper 5.....</b>	<b>26</b>
<b>Chapter 7. Paper 6.....</b>	<b>27</b>
<b>Chapter 8. Concluding remarks.....</b>	<b>28</b>
8.1. Summary.....	28

8.2. Future works ..... 30

**Literature list.....31**

# TABLE OF FIGURES

<i>Figure 1-1 A typical configuration of a MG .....</i>	<i>2</i>
<i>Figure 1-2 Hierarchical control structure. ....</i>	<i>4</i>
<i>Figure 1-3 Equivalent circuit of a parallel-inverter system with virtual impedance .....</i>	<i>5</i>
<i>Figure 1-4 Centralized and decentralized control structure. (a) Centralized control, (b) Decentralized control.....</i>	<i>9</i>
<i>Figure 1-5 MG classification .....</i>	<i>13</i>
<i>Figure 1-6 A general structure of an AC/DC hybrid MG .....</i>	<i>14</i>
<i>Figure 1-7 PV-battery-hydropower-based hybrid MG.....</i>	<i>15</i>





# CHAPTER 1. INTRODUCTION

## 1.1. MICROGRID CONCEPT AND CHALLENGES

### 1.1.1. MICROGRID CONCEPT

The continuous depletion and price uncertainty of fossil fuel resources, environmental issues, poor energy efficiency, concerns regarding power supply security, and the liberalization of electricity markets, have resulted in a new trend of generating power locally at the distribution voltage level instead of the conventional centralized power generation system. This new power generation method is characterized as distributed generation (DG) which typically includes non-conventional energy resources such as solar photovoltaic (PV) energy, wind energy, fuel cells, hydropower, combined heat and power (CHP) systems, biogas, and natural gas, as well as their integration into the utility distribution network [1]-[3]. DG transforms distributed systems from passive distribution networks with unidirectional electricity transmission to active distribution networks, thereby leading to bidirectional power flow transmission, distributed control, and bidirectional decision-making [4], [5].

Microgrid (MG), as an active distribution network, has elicited considerable research interest [6]-[8]. It integrates dispersed DG units, energy storage systems (ESSs), demand side management, and various loads, along with organized control capabilities over MG operation, thereby establishing distribution networks that are mostly connected to the upstream power system. In addition, these networks can be disconnected from the utility grid as isolated networks in case of grid faults or other external disturbances, which increases the power supply reliability and sustainability. MGs are typically equipped with power electronic interfaces (PEIs) and appropriate controls to provide the required flexible operation, to ensure the specified power quality and power output [9]-[11]. A typical configuration of an MG is shown in Fig. 1-1, which integrates power transmission lines, various energy sources, DG facilities and communication links.

MGs reduce environmental pollution because of the use of renewable energy sources (RESs). Furthermore, both the main grid and the customers can obtain benefits from the implementation of MGs [12], [13]. An MG can be regarded either as a controlled entity within the power system or as a single integrated load from the main grid side. The controllability and flexibility of MGs make them easily conform to grid regulations without affecting utility grid stability and security, which further, improves power supply reliability. In addition, MGs can supply uninterruptible power to consumers to satisfy their electrical and heat demands. They can also

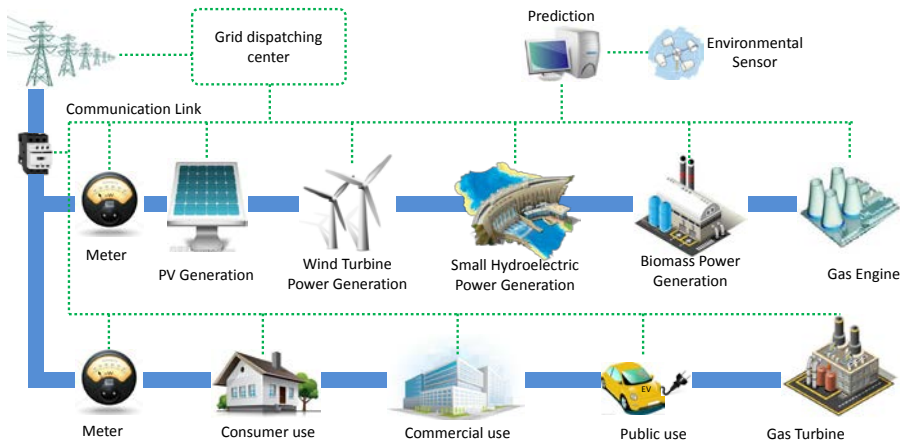

Figure 1-1 A typical configuration of a MG.

provide local voltage support, improve local electrical reliability, and reduce feeder losses.

### 1.1.2. CHALLENGES FOR MICROGRIDS

Despite its potential benefits, the development of MGs has been fraught with challenges to achieve a stable and secure operation. A number of technical and regulatory issues must be settled [14]-[17].

- Operation control and stability issues with multi-resource MGs. Various energy sources, which have different inertia, nominal capacities, and transient responses, are typically included in MGs. For example, the existence of a rotating device in hydropower results in a large rotational inertia, whereas the power electronics interfaced with converter-based PV generation systems present extremely low physical inertia. Full consideration is required for the operation control strategies to overcome interactive influences among multi-resource MGs.
- Seamless transition between different operation modes. MGs should be able to operate both in grid-connected and islanded modes. Therefore, automatic and seamless transitions between these two operation modes are necessary to intentionally/unintentionally island the MG from a disturbance without affecting the integrity of the utility grid and the power quality of the local power supply.
- Voltage and current control. MGs maintain a sustainable power supply and fulfill power quality requirements when they operate in islanded mode. Appropriate voltage and current control strategies are required for each DG unit to stabilize voltage and frequency of isolated networks, meanwhile, to provide the desired current to local loads.

- Power sharing control. Power sharing control methods among DG units in an MG should take different nominal capacities, transient characteristics, distances between loads and generations, into account to prevent operation failure caused by overcurrent incidents, unintentional outages of DG units, and reductions in power transmission losses.
- Power quality issues. Power quality issues, e.g., harmonics and unbalances, will raise when nonlinear or unbalanced loads are included in an MG. PEIs are expected to achieve multiple functions, such as harmonic attenuation, unbalanced voltage compensation, and momentary interruptions rejection, in order to improve power supply quality.
- Protection for active networks. The increasing penetration of DG units results in several issues that should be considered for MG protection. These issues include bidirectional power flow, various fault currents, and the climate dependent and intermittent nature of RESs, which cause variable infeed currents. In addition, interactive influences caused by the intensive joints in high penetration distributed networks should also be taken in to account.
- Optimum sizing and placement of multiple sources. The optimum sizing and location of RESs, ESSs and CHP in the distribution network near the load can reduce power and energy losses, improve voltage profile, and decrease redundant capacities, thereby lessening the economic cost.
- Regulations for operating grid-connected MGs. An appropriate control strategy should be implemented in grid-connected MGs to guarantee synchronism with the main grid, to fulfill grid code, and precise compliance with regulations.
- Communication integration. Specific communication infrastructure and protocols must be developed for MGs. IEC 61850 has been published in communication for MGs and active distribution networks. However, the lack of proper communication infrastructure in rural areas remains to be addressed.

## 1.2. HIERARCHICAL CONTROL THEORY

In a typical MG setting, the control and management system is expected to produce a variety of potential benefits at all time scales and full considerations. To address these requirements, a hierarchical control structure, which has been defined for power systems, is adopted and implemented in MGs [18]-[21].

The MG hierarchical control system comprises three levels, as shown in Fig. 1-2. The primary control deals with the inner control of DG units. It aims to maintain voltage and frequency stability, as well as to achieve independent active/reactive power output sharing among paralleled DG units. The secondary control is used to

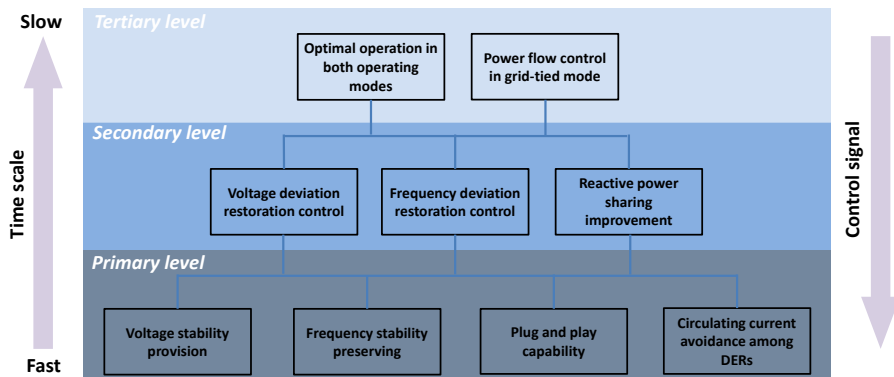

Figure 1-2 Hierarchical control structure.

restore voltage and frequency deviations caused by the operation of the primary control. The tertiary control is responsible for power flow management between the MG and the utility grid. Furthermore, economical and efficient optimization is also considered.

### 1.3. PRIMARY CONTROL—GENERAL INTRODUCTION AND MOTIVATION

#### 1.3.1. CONVENTIONAL POWER DROOP CONTROL

Interfaced DC/AC power converter for DG units can operate as a current-controlled-inverter (CCI). It comprises an inner current loop and a phase-locked-loop (PLL) to guarantee continuous synchronism with the grid. Alternately, converter can operate as a voltage-controlled-inverter (VCI), and includes an inner current loop and an external voltage loop. In grid-connected mode, interface inverters typically operate as CCIs to inject the required current into the main grid, whereas in islanded mode, VCIs are commonly used to stabilize voltage and frequency. However, to achieve seamless transition between grid-connected and islanded modes, VCIs can be used in both these two modes to export or import power to the main grid following the reference points set by the upper control levels in grid-connected mode and to regulate output voltage and frequency in autonomous mode.

With regard to multi-VCIs in parallel, the power droop control method has been widely used in parallel converters to provide decentralized control in many applications, such as parallel redundant uninterruptible power supplies (UPS), distributed power systems, and MGs, as an independent, autonomous, and wireless control because of the elimination of intercommunication links [10], [11], [12], [22]-[31]. The objective of this well-known control technique is to proportionally share active and reactive power by locally adjusting the frequency and output voltage

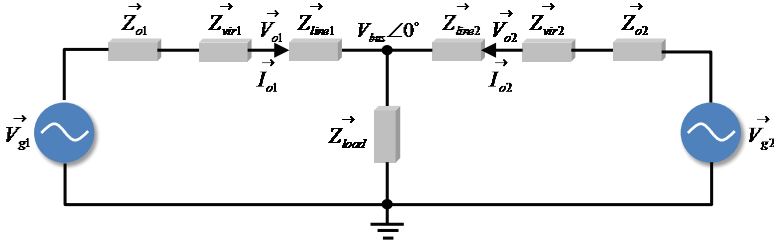

Figure 1-3 Equivalent circuit of a parallel-inverter system with virtual impedance.

amplitude of each DG to emulate the behavior of a synchronous generator.

The control principles of the conventional droop control method can be explained by considering an equivalent circuit, which can be used to emulate a subset of distributed power networks that operate in autonomous mode, as shown in Fig. 1-3. The equivalent circuit represents a two-paralleled inverter system that includes the generated voltages ( $V_{g1}$  and  $V_{g2}$ ), output voltages ( $V_{o1}$  and  $V_{o2}$ ), common bus voltage ( $V_{bus}$ ), output impedances ( $Z_{o1}$  and  $Z_{o2}$ ), virtual impedances ( $Z_{vir1}$  and  $Z_{vir2}$ ), line impedances ( $Z_{line1}$  and  $Z_{line2}$ ), and output currents ( $I_{o1}$  and  $I_{o2}$ ).

In a traditional power system, the equivalent impedance ( $Z_n \angle \varphi_n$ ), which consists of inverter output impedance ( $Z_{on} \angle \varphi_{on}$ ), virtual impedance ( $Z_{virn} \angle \varphi_{virn}$ ), and line impedance ( $Z_{linen} \angle \varphi_{inen}$ ), between paralleled inverters presents high  $X/R$  ratio. The active power output ( $P_n$ ) can be regulated by changing the voltage angle ( $\varphi_{gn}$ ), whereas the reactive power output ( $Q_n$ ) can be adjusted with voltage amplitude ( $V_{gn}$ ). On the basis of this concept, the power droop control method can be expressed as follows:

$$\omega_n = \omega_n^* + k_{p\omega} (P_n^* - P_n) \quad (1)$$

$$V_n = V_n^* + k_{qV} (Q_n^* - Q_n) \quad (2)$$

where  $\omega_n^*$  and  $V_n^*$  are the normal angular frequency and output voltage amplitude, respectively; and  $k_{p\omega}$  and  $k_{qV}$  are the droop coefficients.

However, the load sharing performance of the conventional droop control is affected by the short lines and small impedances in low-voltage networks. In such situation, power outputs ( $P_n$  and  $Q_n$ ), output voltage amplitude, and frequency are coupled, because  $[\sin(\varphi_{on} - \varphi_{bus})] / Z_n \approx (\varphi_{on} - \varphi_{bus}) / Z_n$  cannot be ignored when  $\varphi_n - \varphi_{bus} \neq 0$  or with an extremely small  $Z_n$ , that will cause imprecise power control. Furthermore, with a small equivalent line impedance  $Z_n$ , stability problems will arise in

conventional droop controlled systems, because small frequency or voltage amplitude deviations can result in large power oscillations.

### 1.3.2. VOLTAGE-CURRENT DROOP CONTROL—MOTIVATION

Although power droop control only requires local information, certain stability issues have been presented and solved in the literature.

One important issue is that the droop coefficients for regulating voltage amplitude and frequency are typically proportional terms. Therefore, derivative terms are included to increase the value ranges of coefficients for improving system dynamics [32]-[35]. With the addition of derivative terms, the improved droop controllers yield 2-dimension of freedom (DOF) tunable control. By contrast, conventional droop methods can provide only 1-DOF tunable control. Therefore, the dynamic performance of the system can be improved by damping the oscillatory behavior of the power sharing controllers while maintaining the same static droop gains.

Another problem concerns conventional droop is that power sharing performance is influenced by the output impedance of DG units and line impedances [36]-[38]. When the output impedance of the generator is mainly inductive, e.g., induction generators, voltage magnitude and frequency are related to active and reactive power, respectively. The output impedance of an inverter can be regulated by a fast control loop called virtual impedance. In this regard, output impedance can be considered as a new control loop that compels the inverter to operate based on the inductance-to-resistance ratio ( $X/R$ ) of line impedance.

In case of resistive line impedances, e.g., low-voltage networks, the active power is dominated by voltage amplitude, whereas the reactive power is regulated by frequency [39]-[43]. Thus, the active power-voltage magnitude ( $P-V$ ) and reactive power-frequency ( $Q-f$ ) droop control can be used instead of the conventional droop control. Such use is contrary to those in high-voltage electrical transmission systems or induction generation dominated systems.

To solve the aforementioned issues, a control architecture based on virtual resistance (VR),  $P-V$  and  $Q-f$  droops is used to deal with the autonomous operation of parallel connected inverters in low-voltage networks [41], [44]. However, this approach exhibits an inherent drawback, that is, it needs to calculate instantaneous active and reactive power and then average them through low-pass filters (LPFs) whose bandwidth limits the system transient response [32]. Even in three-phase systems in which the active and reactive powers can be calculated using instantaneous power theory, an LPF is necessary to remove the distorted power components completely, and then obtain the average power [45]. Moreover, in real applications, when short lines with small impedance are used, e.g., low-voltage networks, the load sharing performance of the conventional droop control presents degradation, because a small

deviation in frequency and voltage amplitude may cause large power oscillation and even instabilities [46].

The disadvantages of droop control can be summarized as follows: 1) slow transient response caused by LPFs; 2) active/reactive power coupling; 3) power sharing performance is seriously influenced by the line impedance  $X/R$  ratio; 4) slow response and a small stability margin when active/reactive power sharing ratios are suddenly changed; 5) complex design; 6) power sharing performance is affected if output impedance and line impedance are unbalanced among parallel inverters.

Several control methodologies with different implementations for conventional droop controller have been also proposed [47]-[50]. A  $Q$ - $V$  dot droop control method is mostly used to improve reactive power sharing [51].

Another possible approach is to combine power droop strategies with current-sharing control. A voltage amplitude-active power droop/frequency-reactive power boost (VPD/FQB) control method is presented in [52], [53]. This scheme allows the paralleled VCIs to share a common load power in proportion to a scheduled ratio. An additional VR loop is used in [52] because inverter output impedance is not zero given the PI controller in the voltage control loop. A novel piecewise linear  $V$ - $I$  droop controller is introduced in [54] to exploit the flexibility and fast dynamics of the inverter-based distributed energy resources. However, Global Positioning System (GPS) signals are necessary as communication links to synchronize DG units. A decentralized control for redundant parallel connection of multiple UPS using only current sensors is proposed in [55], [56]. Through this method, the direct and quadrature components of output current are drooped instead of active and reactive power, however, LPFs remain necessary.

Furthermore, stability is a critical issue for islanded MGs in terms of the low-inertia nature of inverter-dominated systems, particularly for droop-based MGs, because both adaptive droop coefficients and variable voltage references seriously affect system stability. Small-signal state-space models are typically conducted to study the stability of an autonomous MG system and ensure safe operation during disturbances [57]-[61].

In view of the aforementioned consideration, this project is dedicated to develop a novel simpler, faster, and more accurate control strategy compared with the power droop controller to independently share direct and quadrature current outputs among the paralleled inverters. In addition, the strategy should be capable of being implemented in low-voltage MGs with high  $R/X$  line impedance, medium-voltage MGs, and even high-voltage networks with high  $X/R$  line impedance. The main challenges of this study include an in-depth analysis on the inherent control principle of the novel controller based on a steady-state mathematical model, a small-signal state-space model, as well as precise dynamic performance and stability margin determination for the novel controller-based AC MG.

## **1.4. SECONDARY CONTROL—GENERAL INTRODUCTION AND MOTIVATION**

Secondary control can be implemented in centralized [62]-[64] or decentralized [65]-[71] structures according to the actual applications, as shown in Fig. 1-4.

### **1.4.1. CENTRALIZED CONTROL**

Centralized controller relies on centralized communication infrastructure. The measured variables from each essential part of MGs are collected and transferred to centralized controller by means of low bandwidth communication links [62]-[64], as shown in Fig. 1-4(a). Based on the collected data, control and energy management algorithms at upper levels can be executed. The obtained compensation signals will be relayed to primary control of each DG to achieve appropriate and efficient operation. The centralized control can provide real-time supervision over the system. However, as the point-to-point communication is necessary for centralized control, a single point of failure (SPOF) issue, which will cause the invalidation of whole high level control functions, is inevitable. Therefore, the reliability and expandability of MG controllers are degraded. Given this, centralized control scheme is more suitable to be implemented in localized or small space MGs.

### **1.4.2. DECENTRALIZED CONTROL AND THE CONSENSUS ALGORITHM**

In order to avoid SPOF and therefore improve MG's reliability and flexibility, distributed control has been naturally brought round the corner [65]-[71]. In a decentralized control system, essential information will be exchanged among DG units directly by utilizing the promising wire/wireless communication technologies [67], as well as by using distributed information exchange algorithms, such as gossip, consensus[68]-[71], instead of all communicating with MG central controller. A general scheme is presented in Fig. 1-4(b). Decentralized control reduces communication complexity and computation loads, therefore, provides more robust and expandable operation.

Consensus algorithms have been recently applied in MGs because of the effective means of sharing information among DGs and facilitating the distributed coordination control [71]-[76]. When consensus algorithms are used, communication links are only required between neighboring DG units, which can achieve plug 'n' play performance and reduce communication cost. In this technique, each DG unit only communicates its state to adjacent DGs. Every DG in the network updates its state by providing a linear equation of its own state and those of its neighbors. Finally, the states of all the DGs are able to reach convergence of the desired average value. With regard to MGs, a consensus algorithm can be used to



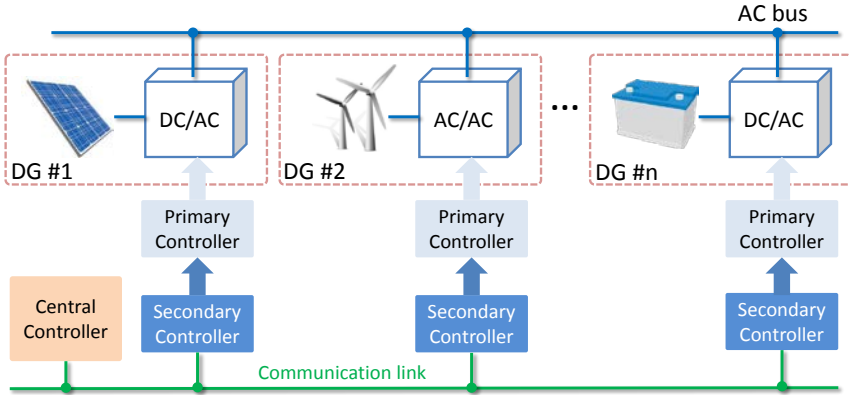

(a)

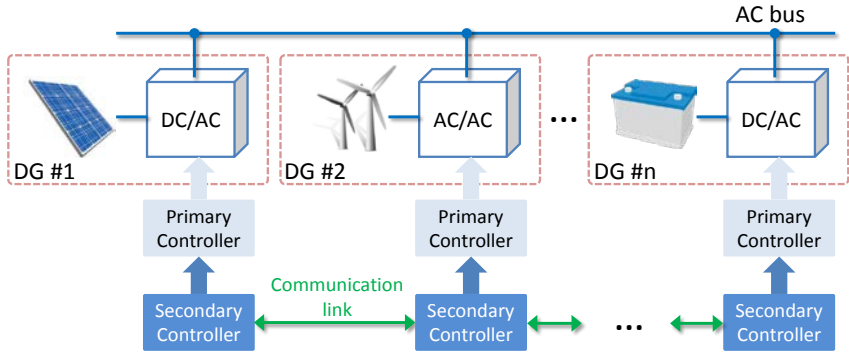

(b)

Figure 1-4 Centralized and decentralized control structure. (a) Centralized control, (b) Decentralized control.

eliminate the dependence on a single DG, and to achieve the information sharing and coordination among DG units.

A connected MG system can be presented by a graph,  $G_{MG} = (N_n, E)$ , which is composed of a set of nodes,  $N_n$ , and a set of edges,  $E$ . In this case, a node represents a DG unit. If  $i$  and  $j$  denote two different nodes, then the edge,  $\{i, j\} \in E$ , presents a bidirectional communication link. To maintain accurate convergence in dynamically changing networks, while simultaneously handling discrete communication data exchange, a DCA is applied as follows [73], [74]:

$$x_i(k+1) = z_i + \varepsilon \sum_{j \in N_i} \delta_{ij}(k+1) \quad (3a)$$

$$\delta_{ij}(k+1) = \delta_{ij}(k) + \alpha_{ij} (x_j(k) - x_i(k)) \quad (3b)$$

where  $x_i$  and  $x_j$  are the states stored in nodes  $i$  and  $j$ , respectively,  $i, j = 1, 2, \dots, N$ ;  $\{i, j\} \in E$ ;  $\alpha_{ij}$  represents the connection status between nodes  $i$  and  $j$ ;  $\varepsilon$  is the constant edge weight;  $\bar{x}$  fulfills the equation  $\bar{x} = \frac{1}{N} \sum_{i=1}^N z_i$ ; and  $\delta_{ij}(0)$  is equal to zero. In this

manner, each node updates its state based on the stored value, connection scheme, scalar tuning parameters, and stored values of all the neighboring nodes. In addition, with (3a), the final convergence value is related to the initial state,  $z_i$ , which indicates that regardless of the degree of change that occurs in  $z_i$ , the algorithm can converge to the desired average value.

#### 1.4.3. COORDINATED CONTROL FOR BALANCING DISCHARGE RATE—MOTIVATION

Certain functions can be expected for secondary control [64], [77], [78]. For example, the restoration of voltage and frequency deviations, synchronization of voltage magnitude, frequency, and phase angle before DG units connected to distribution networks, voltage unbalance and harmonic compensation, and coordinated control among multiple DG units.

An MG should be able to supply power to critical loads without the support of a utility grid and to overcome the intermittent nature of RESs. Therefore, ESSs are required in the case of grid-fault, energy-shortage, and load fluctuations. In this manner, equipping more than one set of distributed ESSs to provide redundancy is advisable to enhance system stability and reliability [79], [80]. Hence, coordinated control is required to guarantee stored energy balance among ESSs to avoid deep-discharge and overcharge.

The control capability of an ESS is limited to its energy capacity. Meanwhile, the available electrical energy from ESSs is affected by various factors, such as charging conditions, ambient temperature, charging and discharging current, and aging [81]. Assume that the valve-regulated lead acid (VRLA) battery is used as a power source for ESS given its large number of charge–discharge cycles, deep discharge capability, and low price. For one aspect, the depth of discharge (DOD) of a VRLA battery decreases exponentially with an increase in its life cycle [82]. Hence, state-of-charge (SoC) typically has a limitation to prevent deep-discharge. Another aspect is that the capacity of a VRLA battery declines exponentially with an increase in discharge current [81], [83]. The total available electrical energy in VRLA batteries is variable in terms of discharge condition although the batteries have the same initial SoC values. Conventional coordinated control strategies mainly focus on equal power sharing among DG units [22]–[31]. However, ESSs in different DG units can have varying discharge rates according to their SoC and capacities. The

powerless DG will be shut down when its SoC is below the threshold, and the remaining DGs have to supply more power to the total load. This situation may result in overcurrent and unintentional outages. Furthermore, it can degrade the stability and reliability of the MG.

To avoid such operation failure, all aspects of coordinated output power control strategy should be considered, such as SoC and ESS capacities. That is, the unit with the highest SoC should supply more power to the common load to ensure a balanced discharge rate [84]. This type of coordinated control strategy can be integrated into a hierarchical structure [18]-[21], [85], [86]. Several coordinated control strategies for SoC balancing in an MG have been proposed [87]-[98] for centralized or distributed topologies by combining communication technology with hierarchical control. In [89], an adaptive VR based droop controller is proposed to achieve stored energy balance. However, a centralized supervisory control is used which may result in a SPOF.

A distributed control offers a robust system and guarantees uninterruptible operation when either the network structure or electrical parameters are changed. By contrast, consensus algorithms have been recently applied in MGs because of their effective means of sharing information among DGs and facilitating distributed coordination control [72]-[74]. A distributed multi-agent-based algorithm is proposed in [96] to achieve SoC balance via voltage scheduling. A decentralized strategy based on fuzzy logic that ensures stored energy balance for a DC MG by modifying the VRs of droop controllers is proposed in [97]. However, these control strategies are all developed in DC MG and based on droop control, which has a relatively slow transient response caused by LPFs [32]. In addition, both adaptive droop coefficients and variable voltage references seriously affect system stability in droop-controlled systems [99].

Moreover, stability analyses on dynamic consensus-based MGs, which include both an electrical part in the continuous-time domain and a consensus algorithm in the discrete-time domain, remain insufficient. Modeling in the discrete-time domain is necessary to consider the discrete nature of communication. A generalized modeling method in the  $z$ -domain is proposed in [100], but the details are not provided.

Given the aforementioned consideration, a droop-free decentralized SoC coordinated secondary control for balancing discharge rate of ESSs in islanded AC MGs is expected to prevent over current and unintentional outage of DG units, and to provide fast response and large stability margin. Furthermore, a detailed discrete state-space model in the  $z$ -domain, which includes an electrical part, the primary control, and DCA-based secondary control, is also expected to analyze the system stability and parameter sensitivity.

## **1.5. GRID-CONNECTED MICROGRIDS WITH TERTIARY CONTROL—GENERAL INTRODUCTION AND MOTIVATION**

Tertiary control is the highest and slowest control level that is responsible for controlling power flow between MGs and the utility grid, while providing optimal operation by considering costs, benefits, and efficiency, among others [19] , [20], [101], [102].

In grid-connected mode, the power flow between MGs and the utility grid can be managed by regulating voltage amplitude and frequency of point of common coupling (PCC). First, the active and reactive power outputs of MGs are measured and then compared with the desired values. The differences between the measured active and reactive power outputs and the power references are sent to two independent PI controllers, whose outputs are considered as increments in frequency and magnitude references in primary control, to adjust output voltage, current, and consequently, power outputs. Active and reactive power flows can be exported or imported independently from MGs depending on the sign of power references.

The corresponding tertiary control should be developed based on the aforementioned novel synchronous-reference-frame (SRF) VR-based primary control to achieve not only power sharing performance among VCIs, but also power flow management between MGs and the main grid, e.g., injecting the required dispatched power into the utility grid.

## **1.6. HYBRID MICROGRIDS**

To consider of combining at least two types of power generator or two types of common bus voltage in one MG, hybrid MGs have emerged as a result of mixing different technologies with various energy sources to provide competitive advantages over using a single technology. The combination of a variety of RESs is the least-cost solution because the advantages and benefits of each technology complement one another. Moreover, these hybrid MGs can provide improved power supply quality, high efficiency, and reliable electricity for residential consumers, particularly in remote areas. A hybrid power system with an appropriate coordinated control operating as an autonomous entity can provide nearly the same quality and services as a utility grid. Furthermore, with proper management and arrangements, connecting a hybrid MG to the main grid is technologically possible. Hybrid MGs can be classified according to either common bus voltage types or different renewable energy technologies, as shown in Fig. 1-5.

### **1.6.1. HYBRID AC/DC MICROGRID**

Most RESs e.g., solar energy and fuel cell, generate DC power or require a DC bus

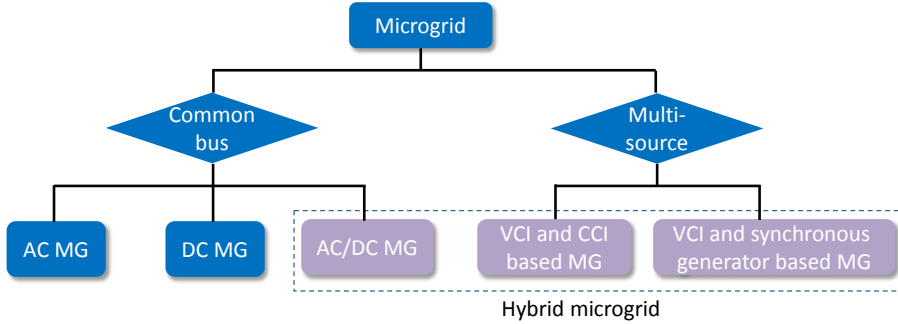

Figure 1-5 MG classification.

for grid connection. Moreover, increasing DC loads should also be considered. Accordingly, DC MGs have recently emerged given their benefits in terms of economy, efficiency, and simple system configuration. A bidirectional AC/DC converter can be used instead of the conventional DC/AC or AC/DC power converters, to connected both AC and DC MGs, and thus, achieve appropriate power flow control between these two combined MGs [103]-[108]. Considering that a hybrid AC/DC MG typically includes both AC/DC energy sources and AC/DC consumers, hybrid AC/DC MGs can be categorized according to load connection and MG structure. A general structure is shown in Fig. 1-6. If various RESs, ESSs are connected to the common AC bus by the interfacing converters (IFCs), it can be regarded as an AC-coupled hybrid MG. On the contrary, if various RESs, ESSs are connected to the common DC bus, and an IFC is equipped to link the DC and AC buses, it can be defined as a DC-coupled hybrid MG. In the case of AC/DC-coupled hybrid MGs, RESs and ESSs are connected to DC and AC buses, in which these DC and AC buses are connected through interlinking converters (ILCs). In order to achieve the proportional power sharing among DG units in AC/DC-coupled hybrid MGs, appropriate control strategies and management algorithms are required for the ILCs.

### 1.6.2. VCI- AND CCI-BASED HYBRID MICROGRID

Another type of hybrid MG is categorized by considering different functions, control strategies, and distributed unit types. For example, a hybrid MG includes both RES units and distributed ESSs. Distributed ESSs are frequently equipped with VCIs to fix the frequency and voltage inside the MG [109], [110]. DG units, such as PV or small wind turbines (WTs), are commonly connected to CCIs and operate under maximum power point tracking control [111], [112]. In this manner, distributed ESSs that are integrated with VCIs can work as grid forming units, whereas, RESs that are connected to CCIs can operate in grid following mode to generate active and reactive power. Coordinated control strategies among multiple distributed units in

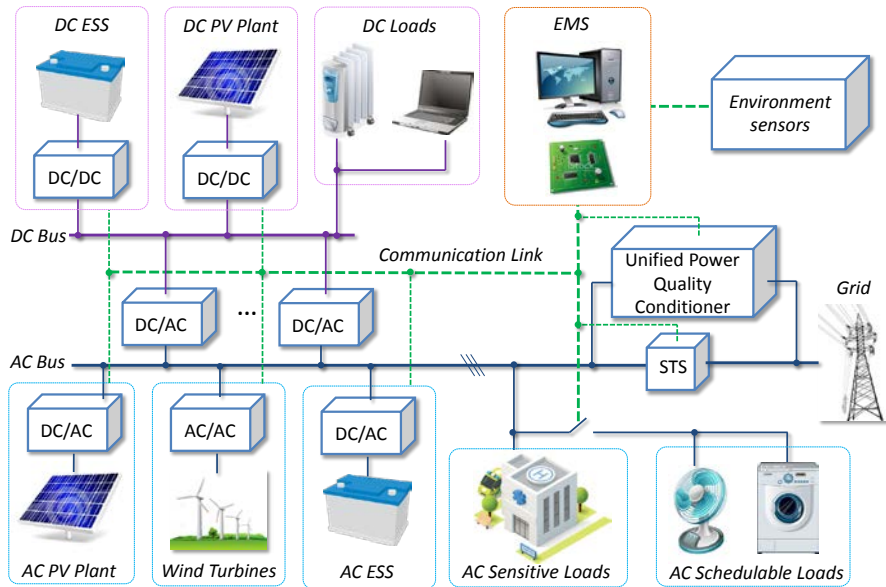

Figure 1-6 A general structure of an AC/DC hybrid MG.

terms of different power conditions and various storage capacities are necessary in these VCI- and CCI-based hybrid MGs to achieve flexible and reliable performance [113]-[115]. VCIs and CCIs are power electronic devices, which have similar dynamic performances, zero inertia, and comparable control structures. Therefore, stability and interactive influence analyses are, to some degree, easier than those for multi-resource hybrid MGs.

### 1.6.3. VCI- AND SYNCHRONOUS GENERATOR-BASED HYBRID MICROGRID—MOTIVATION

In remote areas and some countries where is either provided with discontinuous electricity a day by the utility grid or even difficult to be covered, but have abundant solar irradiation, wind energy and small scale hydroelectric power plants, multi-source hybrid MGs is a reasonable solution by offering a considerable improvement and reliable power supply. Additionally, seasonal power fluctuations can be compensated by combining various RESs. For example, the output power of wind farm can be used to complement solar energy shortage during the night. On the other hand, solar energy can complement hydropower generation declines during the dry season. If daily energy variations are also taken into account, ESSs should be installed to improve stability by energy storage and discharge for peak consumption when power imbalance occurs between RESs and loads.

Islanded PV-battery-hydropower hybrid MGs have been proposed as a practical

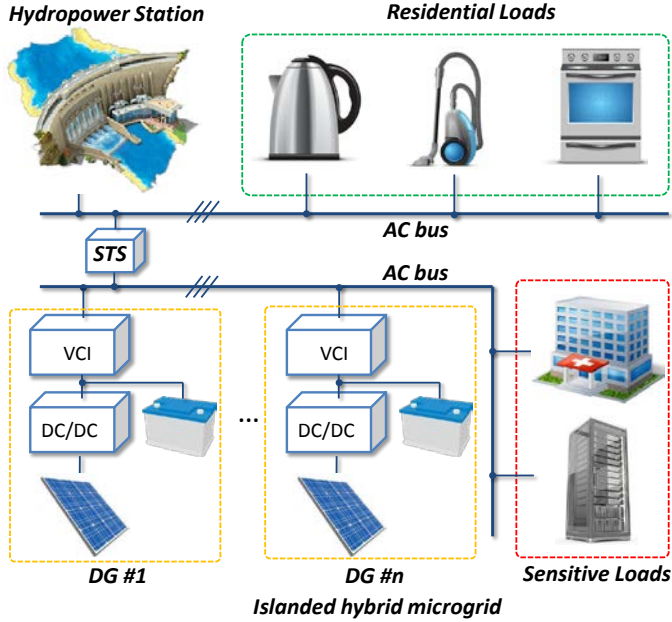

Figure 1-7 PV-battery-hydropower-based hybrid MG.

solution to deal with local electricity outages, power fluctuation elimination, and power supply reliability and availability enhancements, by means of control and regulations to make complementary use of different energy sources [116]-[122]. In order to achieve the required power flow control among the different DG units and to maintain stable operation of the islanded PV-battery-hydropower hybrid MGs, a global consideration and proper design are expected.

Firstly, with the unavailability of hydropower plant reservoirs, such as run-of-the-river (ROR) projects [123], in which minimal or no water storage is equipped, the seamless transition between grid-connected and islanded modes is necessary for PV-battery system.

Secondly, ESSs are necessary for islanded hybrid MGs in which the power exchange among the RES, ESS, and loads, should be balanced. However, the control capability of ESS is limited by its energy capacity. Operation failure or power outage may occur when only ESS is responsible for MG stabilization. Operating the PV-battery system as a  $PQ$  bus to inject desired active and reactive power to a local hydropower-based grid, whereas controlling the hydropower station as a slack bus to establish voltage magnitude and frequency, is a reasonable solution to ensure the stable operation and power balance for a hybrid MG.

Presence of rotating devices is another main problem in islanded PV-battery-hydropower hybrid MG, as it complicates the control scheme and analysis. The

inertia of generators and hydraulic turbines is decided by physical dimensions and rotor weight. Although the damping performance of the system can be increased by the inherent property of the rotating devices, instability may occur as a result of the non-minimum phase system of the hydro turbine [124]-[131]. On the contrary, the absence of physical inertia makes power-electronics-based MGs sensitive to network disturbances. Moreover, different transient response speeds of the VCIs and hydropower generators may also cause instabilities. Therefore, a plenty of parameters of the MG's hierarchical controller as presented in [18]-[21], should be properly designed and optimized by considering the trade-offs between the transient response performance and MG stability.

With regard to the stability analysis for the PV-battery-hydropower hybrid MGs, a number of previous studies have been presented to solve the problems. In [132], the transient stability is analyzed in terms of the relationship of the rotor angles of different energy sources. A small-signal model of a MG which consists of rotating machines and electronically interfaced distributed resource units has been described in [133]. However, no quantitative conclusion has been derived in these papers. System stability analyses through detailed small-signal models for droop-based MGs are presented in [57]-[60]. But beyond the inverters, the dynamic response of a hydroelectric power station should also be considered, since the prime mover and the governor will affect the performance of the local electrical network as well. Transient response and stability analysis of a hydropower station were studied in [134], [135].

In view of these problems, an appropriate hierarchical control strategy for an islanded PV-battery-hydropower hybrid MG is required to achieve stable parallel operation of a hydropower station and a PV-battery system with different normal power capacities. For the frequency and voltage stability analyses of such a hybrid MG, integrated small-signal state-space models should be developed for both the hydroelectric power station and the PV-battery system. In view of varying inertia and control mechanisms, the interaction behavior between the hydropower station and the PV-battery system with various disturbances and under different scenarios need to be tested and evaluated to ensure the stable operation.

## 1.7. THESIS CONTRIBUTION

To address all the aforementioned issues regarding the inherent disadvantages of droop control, a SRF-VR-based simple and fast controller is proposed in this project. The proposed control strategy, which is derived from current-sharing control schemes in DC-paralleled converters, includes an SRF-VR loop, an SRF-PLL, and a proportional-resonant (PR) controller in the voltage control loop. A  $d$ -axis loop and a  $q$ -axis VR loop are used to achieve independent direct and quadrature load current sharing among paralleled inverters. The proposed control strategy provides both instantaneous current-sharing and fast dynamic response for paralleled VCIs.



Compared with the conventional droop control, active/reactive power calculation loops can be eliminated. An additional SRF-PLL is necessary to provide the natural frequency droop characteristic, and to ensure synchronization among paralleled VCIs. The proposed control strategy is suitable to be implemented in low-voltage networks which have resistive line impedance to provide the fast and smooth transient response, hot-swap operation, large stability margin, online sharing ratio change capability and decoupling control. Beyond that, it also works well with inductive-resistive line impedance and even small purely inductive line impedance by means of VR. The droop control strategy should be adopted in highly inductive situations. In other cases, superior performances can be obtained by the proposed controller.

An integrated small-signal state-space model is developed to analyze the stability and parameter sensitivity of the proposed SRF-VR-based current sharing controller. To precisely analyze the dynamic performance of the PR controller in  $dq$  reference frame, a small-signal model for equivalent SRF-PR controller is derived. In addition, a simplified SRF-PLL model is used. Inverter, network, and load dynamics, are individually modeled as sub-modules, and then combined together by a common reference frame to obtain the complete MG model. Through the small-signal state-space model and stability analysis, MGs can be designed to achieve the stability margin required for reliable power systems.

In view of the aforementioned issues regarding the slow transient response and parameter sensitivity provided by the droop-based coordinated SoC controller, and the lack of a balanced discharge rate control strategy for AC MG, a novel coordinated secondary control strategy for balancing discharge rates of ESSs in islanded AC MGs is also proposed in this project. The proposed coordinated controller can regulate the VRs of VCIs to adjust the current output of each DG at the secondary level in terms of SoC and ESS capacities. Accordingly, this strategy can effectively prevent overcurrent incidents and unintentional outages in DG units caused by unbalanced power outputs. The novel autonomous current-sharing controller is used at the primary level instead of the conventional droop to achieve fast and accurate load sharing. Besides, this controller can also provide a large stability margin.

Considering the requirements of distributed discharge rate balancing control for energy storage units in AC MGs, this project proposes a DCA-based secondary control scheme to achieve not only distributed balanced discharge rate control that can effectively prevent operation failure caused by overcurrent and unintentional outage of DGs, but also high reliability, expandability, and flexibility because of its distributed control architecture. A detailed discrete state-space model with the proposed SoC coordinated controller is developed by considering the discrete nature of DCA. The root locus in the  $z$ -domain demonstrates the low sensitivity of the parameters of the proposed controller over system dynamics.

An hierarchical control method is proposed in this project for the SRF-VR-based novel primary control strategy to realize the seamless transition between islanded mode and grid-connected mode. The primary and secondary controllers will ensure power sharing among the paralleled VCIs and power quality in standalone operation. The tertiary control level is used to control power flow between the MG and the utility grid.

A PV-battery-hydropower hybrid MG is selected as a case study scenario to generate a hierarchical control strategy to deal with the interaction caused by various inertia and multiple control mechanisms. The project addresses the aforementioned frequency and voltage stability issues regarding multi-source-based hybrid MGs. A hierarchical controller for this islanded PV-battery-hydropower hybrid MG is proposed to achieve parallel operation of a hydropower station and a PV-battery system with different nominal power capacities. The proposed controller achieves complete decoupling power control between the hydropower station and the PV-battery system. In order to analyze the frequency and voltage stability of this hybrid MG, an integrated small-signal state-space model for the hydroelectric power and the PV-battery system is built. Root locus plots are presented to help identify the origin of each mode, and consequently, improve system stability.

## **1.8. THESIS OBJECTIVES**

The research objectives of this project are listed as follows.

- To review previous studies on control strategies for parallel connected inverters in AC MGs and to determine their achievements and challenges
- To propose a novel primary control strategy for parallel connected inverters in AC MGs that can address the issues of previous research and provide superior control performance
- To study and compare the control performance of the proposed novel primary control strategy for single-phase parallel connected inverters
- To model and analyze MG stability and parameter sensitivity with the proposed novel primary control strategy in terms of a small-signal state-space model
- To propose a discharge rate-balancing control strategy with the presented current-sharing controller for energy storage units in AC MGs
- To propose a DCA-based distributed secondary control method to achieve balanced discharge rates considering for AC MGs

- To model and analyze an AC MG with the DCA-based distributed secondary controller while considering the discrete nature of communications
- To investigate an appropriate hierarchical control strategy for grid-connected AC MGs with the proposed autonomous current sharing controller
- To propose a hierarchical control strategy for an islanded PV-battery-hydropower hybrid MG to achieve parallel operation of a hydropower station and a PV-battery system with different nominal power capacities
- To model and analyze the frequency and voltage stability of an PV-battery-hydropower hybrid MG considering different disturbances and scenarios
- To verify the proposed control strategies based on the experimental setups in an intelligent MG laboratory

## 1.9. THESIS OUTLINE

This thesis is organized as follows.

**Chapter 2** presents the first paper, published in *IEEE Transactions on Power Electronics*, which introduces a novel autonomous current-sharing controller for paralleled VCIs. The proposed control strategy includes an SRF-VR loop, an SRF-PLL, and a PR controller in the inner loop.  $D$ -axis and  $q$ -axis VR loops are used to achieve separate direct and quadrature load current sharing among paralleled inverters. In contrast to the conventional droop control, the proposed controller can provide faster response and better current-sharing accuracy because the LPF is removed. Stationary analysis in terms of the closed-loop transfer function is presented to identify the inherent voltage magnitude-direct current output and the frequency-quadrature current output droop mechanisms with different line impedances. Comparative experiments from a setup with three parallel 2.2 kW inverters are presented to compare the control performances of the conventional droop control and the proposed control with different line impedances under varying scenarios.

**Chapter 3** introduces the second paper, presented in *Applied Power Electronics Exposition (APEC) 2015*, in which an integrated small-signal state-space model for the proposed novel autonomous current-sharing controller is built to analyze stability and parameter sensitivity. The PR controller is one of the key control loops. Hence, a small-signal model for equivalent SRF-PR controller is proposed to accurately represent the dynamic performance of the PR controller in the  $dq$  reference frame. A simplified SRF-PLL model is also used. Consequently, inverter, network, and load dynamics are modeled individually and then combined on a common reference frame to obtain a complete MG model. Stability and parameter

sensitivity analysis can be conducted to help design a stable and reliable paralleled network based on the complete model.

**Chapter 4** presents the third paper, accepted by *IEEE Transactions on Industry Applications*, which introduces a novel coordinated secondary control strategy for balancing the discharge rates of ESSs in islanded AC MGs. The coordinated secondary controller can prevent overcurrent incidents and unintentional outages in DG units by regulating the power outputs of DG units according to their SoC values. This control strategy aims to adjust the VRs of VCIs at the secondary level in terms of SoC and ESS capacities. The proposed autonomous current-sharing controller is adopted at the primary level to ensure the fast and accurate load sharing performance of paralleled VCIs. The proposed coordinated secondary controller can also provide a larger stability margin than that provided by the conventional droop controller. Root locus analysis is presented to analyze stability and parameter sensitivity. The experimental results obtained by using the conventional power-sharing controller are compared with those obtained by using the proposed coordinated secondary control to verify the effectiveness of the proposed control approach.

**Chapter 5** presents the fourth paper, submitted to *IEEE Transactions on Smart Grid*, which introduces a DCA-based distributed balanced discharge rate control scheme to not only effectively prevent operation failure caused by unbalanced power sharing, but also provide flexible, reliable, and expandable control given the distributed control architecture. A DCA is implemented in each DG to share information for coordinately regulating the output power of DG units according to their SoC and ESS capacities by adjusting the VRs of paralleled VCIs. A detailed linearized discrete state-space model in the  $z$ -domain, which includes an electrical part, a primary control, and a consensus algorithm, is proposed. The experimental results obtained using the conventional power-sharing control, using the centralized control method, and those obtained from the DCA -based SoC coordinated control using a setup with three 2.2 kW DG units are compared.

**Chapter 6** introduces the fifth paper, presented in *IEEE Energy Conversion Congress and Exposition (ECCE)*, which reports on a developed appropriate hierarchical control scheme based on the proposed SRF-VR-based current-sharing strategy that functions as the primary controller in this case. The primary control level is responsible for achieving precise current-sharing among paralleled DG units. The secondary control is used to compensate for the voltage magnitude and frequency deviations caused by the VR loop at the primary level. A frequency and magnitude synchronization loop is also included in the secondary control to synchronize MG output voltage with common bus voltage before connecting to the main grid. The tertiary control level is therefore used to realize power flow control between the MG and the main grid. The control signals from the secondary and tertiary controllers will change the resonant frequency of the PR controller at the

primary level to ensure a stable operation and to guarantee the desired control performance.

**Chapter 7** presents the sixth paper, published in *IEEE Transactions on Industry Applications*, in which a hierarchical control strategy for an islanded PV-battery-hydropower hybrid MG is proposed to achieve stable parallel operation. Considering that multi-energy sources typically present various inertia, dynamic performances, and multiple control principles, the coexistence of differences may affect system stability. The proposed hierarchical controller can ensure proportional power sharing among PV-battery system, while injecting the required power into a hydropower-based local grid. The hydropower station operates as a slack bus to maintain bus voltage amplitude and frequency. An integrated small-signal state-space model is derived to analyze the system stability of the hybrid MG. The simulation results based on a real hybrid MG demonstration that includes 2 MW<sub>p</sub> PV installations, a 15.2 MWh battery system, and a 12.8 MVA hydropower plant, as well as the experimental results on a small-scale laboratory prototype that includes two 2.2 kW inverters, validate the effectiveness of the proposed control strategy.

**Chapter 8** concludes this thesis and introduces future works.

## CHAPTER 2. PAPER 1

### A New Way of Controlling Parallel-Connected Inverters by Using Synchronous-Reference-Frame Virtual Impedance Loop

— Part I: Control Principle

Guan, Y., Guerrero, J.M., Zhao, X., Vasquez, J.C., Guo, X.

The paper has been published in

*IEEE Transactions on Power Electronics*, 2016

vol. 31, no. 6, pp: 4576 - 4593, June. 2016.

## CHAPTER 3. PAPER 2

Small-Signal Modeling, Analysis and Testing of Parallel Three-Phase-Inverters with A Novel Autonomous Current Sharing Controller

Yajuan Guan, Juan C. Vasquez, Josep M. Guerrero, Ernane Antônio Alves Coelho

The paper has been published in

*Proceeding of 2015 IEEE Applied Power Electronics Conference and Exposition*

(APEC 2015), pp: 571 – 578, 2015.

## CHAPTER 4. PAPER 3

### Coordinated Secondary Control for Balanced Discharge Rate of Energy Storage System in Islanded AC Microgrids

Guan, Y., Vasquez, J.C., Guerrero, J.M.,

The paper has been accepted by

*IEEE Transactions on Industry Applications*, 2016

vol., no. 99, pp: 1 - 1, 2016



## CHAPTER 5. PAPER 4

A Dynamic Consensus Algorithm to Adjust Virtual Impedance Loops  
for Discharge Rate Balancing of AC Microgrid Energy Storage Units

Yajuan Guan, Lexuan Meng, Chendan Li, Juan C. Vasquez, Josep M. Guerrero

The paper has been submitted to

*IEEE Transactions on Smart Grid, 2016*

## CHAPTER 6. PAPER 5

Hierarchical Controlled Grid-Connected Microgrid based on a Novel  
Autonomous Current Sharing Controller

Yajuan Guan, Juan C. Vasquez, Josep M. Guerrero

The paper has been published in

*Proceeding of 2015 IEEE Energy Conversion Congress and Exposition*

(ECCE 2015), pp: 2333 – 2340, 2015

## CHAPTER 7. PAPER 6

### Frequency Stability of Hierarchically Controlled Hybrid Photovoltaic-Battery-Hydropower Microgrids

Yajuan Guan, Juan C. Vasquez, Josep M. Guerrero, Yibo Wang, Wei Feng

The paper has been published in

*IEEE Transactions on Industry Applications*, 2015

vol. 51, no. 6, pp: 4729 - 4742, June. 2015.

# CHAPTER 8. CONCLUDING REMARKS

## 8.1. SUMMARY

This thesis focuses on developing a novel simpler and more effective autonomous current-sharing controller for parallel three-phase inverters in AC MGs to replace the conventional droop control strategy. Different implementations of the proposed novel current-sharing controller, which functions as a primary controller, with proper hierarchical control, are also set as objectives of the thesis. Distributed control methods are applied and integrated into the hierarchical control scheme to improve the flexibility and expandability of MG operation. Multi-energy-source hybrid MG is another research topic in this thesis. A hierarchical controller for an islanded PV-battery-hydropower hybrid MG is proposed to achieve parallel operation and decoupling power control of a hydropower station and a PV-battery system with different nominal power capacities. Detailed conclusions in different aspects are provided as follows.

- Proposed novel autonomous current-sharing controller—control principle

A simple and fast controller that comprises an SRF-PLL, a VR loop, and a PR controller in the inner voltage loop for independently controlling direct and quadrature current outputs among parallel three-phase VCIs is developed. With regard to steady-state characteristic analysis, the direct current output-sharing ratio can be adjusted by regulating the  $d$ -axis VR ratio of the parallel inverters. Similarly, the quadrature current-sharing ratio can be modified accordingly by regulating the  $q$ -axis VR ratio. In contrast to the conventional droop control, the new approach removes the LPFs for average active and reactive power calculation and power droop loops. Thus, the new approach can provide faster transient response, decoupling control, better plug 'n' play performance, more robust and more accurate load-sharing control. The proposed autonomous current-sharing controller can be applied to low-voltage networks with resistive line impedance. Furthermore, this controller works well with inductive-resistive line impedance and even with small purely inductive line impedance through the utilization of VRs.

- Novel autonomous current-sharing controller—modeling and stability analysis

A complete small-signal state-space model is built to analyze the stability and parameter sensitivity of the proposed autonomous current-sharing controller. An accurate small-signal model for the PR controller in the  $dq$  reference frame is developed. The complete MG model is obtained on a common reference frame by considering the features of different parts of the control loops and power circuit. The developed model exhibits a larger stability margin and faster transient response than the conventional droop control.

- Implementation of centralized balanced discharge rate control

A novel coordinated secondary control for balancing the discharge rates of ESSs in islanded AC MGs is proposed. The coordinated secondary control can effectively prevent overcurrent incidents in DG units by regulating their power outputs according to their SoC values. The autonomous currents-sharing control strategy, which is used at the primary control level, provides faster transient response, more accurate output-current-sharing performance, and a larger stability region than the earlier power droop control-based coordinated SoC control methods.

- Implementation of decentralized balanced discharge rate control

A DCA-based decentralized coordinated secondary control with the novel primary controller for the balanced discharge rate of ESSs in islanded AC MGs is proposed to improve the flexibility of MG operation. Compared with previously proposed methods, this approach can not only ensure a balanced discharge rate among DGs, but also provide higher reliability, expandability, and flexibility. Root locus in the  $z$ -domain from a discrete state-space model with the proposed SoC coordinated controller is established, which indicates the low sensitivity of the parameters of the proposed controller over system dynamics.

- Implementation of hierarchical control based-grid connected mode

An appropriate hierarchical control scheme is proposed to achieve the grid-connected operation of the paralleled three-phase VCIs with the proposed current-sharing controller. The three-level hierarchical controller can ensure power sharing among the paralleled VCIs and power quality, meanwhile injecting the desired active and reactive power/current outputs into the main grid.

- Hierarchical control strategy for PV-battery-hydropower hybrid MG

A hierarchical controller is proposed to provide a stable and decoupled parallel operation of a hydropower station and a PV-battery system with different nominal power capacities, and thus, achieve stable frequency and voltage operation of a PV-battery-hydropower hybrid MG, which consists of different RESs with various inertia and control strategies. An integrated small-signal state-space model for both the hydropower station and the PV-battery system is built to analyze the frequency and voltage stability, as well as the parameter sensitivity, of the hybrid MG.

All the proposed control strategies and modeling methods are verified on Matlab/Simulink, dSPACE 1006, 2.2 kW Danfoss three-phase converter, and  $LC$  or  $LCL$  filter-based experimental platform. The simulation and experimental results are presented in each work.

## 8.2. FUTURE WORKS

- Power quality enhancement with the proposed current-sharing controller: Autonomous current-sharing controller-based distributed control strategies that can realize unbalance/harmonic voltage compensation and unbalance/harmonic load current sharing in case of unbalanced/nonlinear loads will be investigated to improve power supply quality and to realize multi-functional converters.
- Application of the proposed current-sharing controller for a multi-source hybrid MG: An autonomous current-sharing controller-based hierarchical control strategy for a hybrid MG with multiple energy sources will be developed to achieve a stable and decoupled operation.
- Hierarchical control of multiple hybrid MG clusters: Distributed hierarchical control for multiple hybrid MG clusters will be explored to achieve stable operation and proper power flow regulation.
- Ancillary services for the proposed autonomous current sharing controller-based MGs: Based on the proposed current-sharing controller, explore its potential for ancillary service market participation, with functionalities such as network stabilization, power system stabilizer, virtual inertia, voltage stability, etc.

# LITERATURE LIST

- [1] I. S. Bae, J. O. Kim, J. C. Kim, and C. Singh, "Optimal Operating Strategy for Distributed Generation Considering Hourly Reliability Worth," *IEEE Trans. Power Syst.*, vol. 19, no. 1, pp. 287–292, Feb. 2004.
- [2] A. Yadav and L. Srivastava, "Optimal placement of distributed generation: An overview and key issues," in *2014 International Conference on Power Signals Control and Computations (EPSCICON)*, 2014, pp. 1–6.
- [3] R. Lawrence and S. Middlekauff, "Distributed generation: the new guy on the block," in *IEEE Industry Applications Society 50th Annual Petroleum and Chemical Industry Conference*, 2003. Record of Conference Papers, 2003, pp. 223–228.
- [4] Hristiyan Kanchev, Di Lu, Frederic Colas, Vladimir Lazarov. "Bruno Francois Energy Management and Operational Planning of a Microgrid With a PV-Based Active Generator for Smart Grid Applications," *IEEE Transactions on Industrial Electronics*, vol.58, no.10, pp. 4583 - 4592, Feb. 2011.
- [5] Chowdhury S.P., Chowdhury S. and Crossley P.A., "UK Scenario of Islanded Operation of Active Distribution Networks—A Survey," *Proc. of IEEE Power Engineering Society General Meeting 2008*, Pittsburgh, PA, July 20–24, 2008.
- [6] R. H. Lasseter and P. Paigi, "Microgrid: A conceptual solution," in *Proc. IEEE PESC*, Aachen, Germany, 2004, pp. 4285–4290.
- [7] R. H. Lasseter, "Smart Distribution: Coupled Microgrids," *Proc. IEEE*, vol. 99, no. 6, pp. 1074–1082, Jun. 2011.
- [8] N. Hatziaargyriou, H. Asano, R. Irvani, and C. Marnay, "Microgrids," *IEEE Power Energy Mag.*, vol. 5, no. 4, pp. 78–94, Jul. 2007.
- [9] Paigi, P., Lasseter, R.H., "Autonomous control of microgrids," *Power Engineering Society General Meeting*, 2006. IEEE, vol., no., pp., 2006.
- [10] Yunwei Li, Vilathgamuwa, D.M., Poh Chiang Loh, "Design, Analysis, and Real-Time Testing of a Controller for Multibus Microgrid System," *IEEE Transactions on Power Electronics*, vol. 19, no. 5, pp. 1195–1204, Sept. 2004.
- [11] Guerrero, J.M., Garcia De Vicuna, L., Matas, J., Castilla, M., Miret, J., "Output Impedance Design of Parallel-Connected UPS Inverters with Wireless Load-Sharing Control," *IEEE Transactions on Industrial Electronics*, vol. 52, no. 4, 1126–1135, Aug. 2005.
- [12] S. Barsali, M. Ceraolo, P. Pelacchi, and D. Poli, "Control techniques of Dispersed Generators to improve the continuity of electricity supply," in *2002 IEEE Power Engineering Society Winter Meeting. Conference Proceedings* (Cat. No.02CH37309), 2002, vol. 2, pp. 789–794.
- [13] P. Asmus, "Why Microgrids Are Moving into the Mainstream: Improving the efficiency of the larger power grid," *IEEE Electr. Mag.*, vol. 2, no. 1, pp. 12–19, Mar. 2014.
- [14] N. Hadsaid, J.-F. Canard, and F. Dumas, "Dispersed generation impact on distribution networks," *IEEE Comput. Appl. Power*, vol. 12, no. 2, pp. 22–28, Apr. 1999.
- [15] S. Chowdhury, S.P. Chowdhury and P. Crossley, "Microgrids and Active Distribution Networks," *Published by The Institution of Engineering and Technology*, London, United Kingdom, 2009.
- [16] Nikos Hatziaargyriou, "Microgrids-Architectures and Control," *John Wiley and Sons Ltd*, 2014.
- [17] Nicolae-Cristian Sintamarean, Frede Blaabjerg, Huai Wang, Francesco Iannuzzo, Peter de Place Rimmén, "Reliability Oriented Design Tool For the New Generation of Grid Connected PV-Inverters," *IEEE Transactions on Power Electronics*, vol. 30, no. 5, pp. 2635 - 2644, May 2015.
- [18] J. M. Guerrero, J. C. Vasquez, J. Matas, L. G. De Vicuna, and M. Castilla, "Hierarchical Control of Droop-Controlled AC and DC Microgrids — A General Approach Toward Standardization," *IEEE Trans. Ind. Electron.*, vol. 58, pp. 158–172, 2011.
- [19] A. Bidram and A. Davoudi, "Hierarchical Structure of Microgrids Control System," *IEEE Trans. Smart Grid*, vol. 3, pp. 1963–1976, 2012.
- [20] J. M. Guerrero, M. Chandorkar, T.-L. Lee, and P. C. Loh, "Advanced Control Architectures for Intelligent Microgrids—Part I: Decentralized and Hierarchical Control," *IEEE Trans. Ind. Electron.*, vol. 60, no. 4, pp. 1254–1262, Apr. 2013.

- [21] M. Guerrero Josep, Juan C. Vásquez, Mehdi Savaghebi, Jordi de la Hoz, Helena Martín, "Hierarchical control of power plants with microgrid operation," *IECON 2010 - 36th Annual Conference on IEEE Industrial Electronics Society*, pp. 3006 – 3011, Nov. 2010, Glendale, AZ.
- [22] Chandorkar, M.C., Divan, D.M., Adapa, R., "Control of parallel connected inverters in standalone AC supply systems," *Industry Applications, IEEE Transactions on*, vol.29, no.1, pp.136,-143, Jan/Feb 1993
- [23] J. Guerrero, L. de Vicuna, J. Matas, M. Castilla, and J. Miret, "A wireless controller to enhance dynamic performance of parallel inverters in distributed generation system," *IEEE Trans. Power Electron.*, vol. 19, no. 5, pp. 1205–1213, Sep. 2004.
- [24] J. C. Vasquez, J. M. Guerrero, J. Miret, M. Castilla, L. G. de Vicuña, "Hierarchical Control of Intelligent Microgrids," *IEEE Industrial Electronics Magazine*, vol.4, no.4, pp.23-29, Dec. 2010.
- [25] J. A. Peas Lopes, C. L. Moreira, and A. G. Madureira, "Defining control strategies for microgrids islanded operation," *IEEE Trans. Power Syst.*, vol. 21, pp. 916-924, May 2006.
- [26] M. Marwali, J.-W. Jung, and A. Keyhani, "Control of distributed generation systems—Part II: Load sharing control," *IEEE Trans. Power Electron.*, vol. 19, no. 6, pp. 1551–1561, Nov. 2004.
- [27] Vasquez, J.C., Guerrero, J.M., Luna, A., Rodriguez, P., "Adaptive Droop Control Applied to Voltage-Source Inverters Operating in Grid-Connected and Islanded Modes," *Industrial Electronics, IEEE Transactions on*, vol. 56, no. 10, 4088-4096, Oct. 2009.
- [28] F. Katiraei, M. R. Irvani, and P. W. Lehn, "Micro-grid autonomous operation during and subsequent to islanding process," *IEEE Trans. Power Del.*, vol. 20, pp. 248-257, Jan 2005.
- [29] Jaehong Kim, Guerrero, J.M., Rodriguez, P., Teodorescu, R., Kwanghee Nam, "Mode Adaptive Droop Control With Virtual Output Impedances for an Inverter-Based Flexible AC Microgrid," *Power Electronics, IEEE Transactions on*, vol. 26, no. 3, pp. 689-701, March. 2011.
- [30] F. Katiraei and M. R. Irvani, "Power management strategies for a microgrid with multiple distributed generation units," *IEEE Trans. Power Syst.*, vol. 21, no. 4, pp. 1821–1831, Nov. 2006.
- [31] F. Blaabjerg, R. Teodorescu, M. Liserre, and A. V. Timbus, "Overview of control and grid synchronization for distributed power generation systems," *IEEE Trans. Industrial Electron.*, vol. 53, pp. 1398-1409, Oct 2006.
- [32] Yasser Abdel-Rady Ibrahim Mohamed, Ehab F. El-Saadany. "Adaptive Decentralized Droop Controller to Preserve Power Sharing Stability of Paralleled Inverters in Distributed Generation Microgrids," *IEEE Transactions on Power Electronics*, vol. 23, no. 6, pp.2806-2816, Nov. 2008
- [33] C. Sao, P. Lehn, "Autonomous load sharing of voltage source converters," *IEEE Trans. Power Del.*, vol. 20, no. 2, pp. 1009–1016, Apr. 2005.
- [34] Ashabani, S.M.; Mohamed, Y.A.-R.I. "New Family of Microgrid Control and Management Strategies in Smart Distribution Grids—Analysis, Comparison and Testing", *Power Systems, IEEE Transactions on*, On page(s): 2257-2269 Volume: 29, Issue: 5, Sept. 2014
- [35] Yajuan Guan, Weiyang Wu, Xiaoqiang Guo, Herong Gu. "An Improved Droop Controller for Grid-Connected Voltage Source Inverter in Microgrid." *2nd International Symposium on Power Electronics for Distributed Generation Systems, PEDG 2010*, 2010: 823-828
- [36] Y. W. Li, C. N. Kao, "An accurate power control strategy for powerelectronics- interfaced distributed generation units operating in a low voltage multibus microgrid," *IEEE Trans. Power Electron*, vol. 24, no. 12, pp. 2977–2988, Dec. 2009.
- [37] Engler, A., Soutlanis, N., "Droop control in LV-grids," *Future Power Systems, 2005 International Conference on*, vol., no., pp.6 pp.,6, 18-18 Nov. 2005
- [38] S. J. Chiang, C. Y. Yen, and K. T. Chang, "A multimodule parallelable series-connected PWM voltage regulator," *IEEE Trans. Ind. Electron.*, vol. 48, no. 3, pp. 506–516, Jun. 2001.
- [39] Vandoor, T.L.; Meersman, B.; De Kooning, J.D.M.; Vandeveld, L. "Directly-Coupled Synchronous Generators With Converter Behavior in Islanded Microgrids", *Power Systems, IEEE Transactions on*, On page(s): 1395-1406 Volume: 27, Issue: 3, Aug. 2012.
- [40] Karel De Brabandere, Bruno Bolsens, Jeroen Van den Keybus, et al, "A Voltage and Frequency Droop Control Method for Parallel Inverters," *IEEE Trans. Power Electronics*, vol. 22, no. 4, pp. 1107-1115, July. 2007.



- [41] Guerrero, J.M., Matas, J., Luis Garcia de Vicuna, Castilla, M., Miret, J., "Decentralized Control for Parallel Operation of Distributed Generation Inverters Using Resistive Output Impedance," *Industrial Electronics, IEEE Transactions on*, vol.54, no.2, pp.994-1004, April Apr. 2007.
- [42] W. Yao, M. Chen, J. M. Guerrero, and Z.-M. Qian, "Design and analysis of the droop control method for parallel inverters considering the impact of the complex impedance on the power sharing," *IEEE Trans. Ind. Electron.*, vol. 58, no. 2, pp. 576–588, Feb. 2011.
- [43] H. Laaksonen, P. Saari, and R. Komulainen, "Voltage and frequency control of inverter based weak LV network microgrid," in *Proc. 2005 Int. Conf. Future Power Systems*, Amsterdam, The Netherlands, Nov. 18, 2005.
- [44] Vandoorn, T.L., Meersman, B.; Degroote, L., Renders, B., Vandeveldel, L., "A Control Strategy for Islanded Microgrids With DC-Link Voltage Control," *Power Delivery, IEEE Transactions on*, vol.26, no.2, pp.703-713, April Apr. 2011.
- [45] Jiefeng Hu, Jianguo Zhu, David G. Dorrell, Josep M. Guerrero, "Virtual Flux Droop Method—A New Control Strategy of Inverters in Microgrids," *IEEE Transactions on Power Electronics*, vol.29, no.9, pp. 4704 - 4711, Sept. 2014.
- [46] Vasquez, J.C., Guerrero, J.M., Savaghebi, M., Eloy-Garcia, J., Teodorescu, R., "Modeling, Analysis, and Design of Stationary-Reference-Frame Droop-Controlled Parallel Three-Phase Voltage Source Inverters," *Industrial Electronics, IEEE Transactions on*, vol.60, no.4, pp.1271-1280, Apr. 2013
- [47] G. Diaz, C. Gonzalez-Moran, J. Gomez-Aleixandre, and A. Diez, "Scheduling of droop coefficients for frequency and voltage regulation in isolated microgrids," *IEEE Trans. Power Syst.*, vol. 25, pp. 489–496, Feb. 2010
- [48] E. Rokrok and M. E. H. Golshan, "Adaptive voltage droop method for voltage source converters in an islanded multibus microgrid," *IET Gen., Trans., Dist.*, vol. 4, no. 5, pp. 562–578, 2010.
- [49] Giovanni Guarienti Pozzebon, Amilcar Flamarion Querubini Goncalves, Guido Gómez Pena, Nilton Eufrázio Martinho Mocambique, Ricardo Quadros, "Operation of a Three-Phase Power Converter Connected to a Distribution System," *IEEE Transactions on Industrial Electronics*, vol. 60, no. 5, pp. 1810 - 1818, May 2013.
- [50] Majumder, R., Chaudhuri, B., Ghosh, A., Majumder, R., Ledwich, G., Zare, F., "Improvement of Stability and Load Sharing in an Autonomous Microgrid Using Supplementary Droop Control Loop," *Power Systems, IEEE Transactions on*, vol. 25, no. 2, 796-808, May. 2010.
- [51] Lee, C.-T., Chu, C.-C., Cheng, P.-T., "A New Droop Control Method for the Autonomous Operation of Distributed Energy Resource Interface Converters," *Power Electronics, IEEE Transactions on*, vol. 28, no. 4, 1980-1993, April. 2013.
- [52] C. Sao and P. Lehn, "Control and power management of converter fed microgrids," *IEEE Trans. Power Syst.*, vol. 23, no. 3, pp. 1088–1098, Aug. 2008.
- [53] Sao, C., Lehn, P.W., "Autonomous load sharing between converters and generators in microgrids," *Power and Energy Society General Meeting*, 2011 IEEE, San Diego, CA, pp, 1-8 , 24-29, July, 2011.
- [54] Mohammad S. Golsorkhi, Dylan D. C. Lu, "A Control Method for Inverter-Based Islanded Microgrids Based on V-I Droop Characteristics," *Power Delivery IEEE Transactions on*, vol.30, no.3, pp.1196-1204, June. 2015.
- [55] Sato, E.K., Kawamura, A., Fujii, R., "Theoretical and experimental verification of independent control for parallel-connected multi-UPS's," *Telecommunications Energy Conference*, 2003. INTELEC '03. The 25th International, Yokohama, Japan, pp, 485 – 492, 23-23, Oct. 2003.
- [56] Sato, E.K., Kawamura, A., "Decentralized Control for Redundant Parallelism of Uninterruptible Power Supplies with Different Ratings Using Only Current Sensors," *Power Electronics Specialists Conference*, 2005. PESC '05. IEEE 36th, Recife, pp, 2823 – 2829, 16-16, June, 2005.
- [57] N. Pogaku, M. Prodanovic, and T. C. Green, "Modeling, analysis and testing of autonomous operation of an inverter-based microgrid," *IEEE Trans. Power Electron.*, vol. 22, no. 2, pp. 613–625, Mar. 2007.
- [58] Kroutikova, N.; Hernandez-Aramburo, C.A.; Green, T.C, "State-space model of grid-connected inverters under current control mode," *Electric Power Applications, IET*, vol. 1, no. 3, pp. 329–338, May. 2007.

- [59] Alireza Kahrobaeian, Yasser Abdel-Rady I. Mohamed, "Analysis and Mitigation of Low-Frequency Instabilities in Autonomous Medium-Voltage Converter-Based Microgrids With Dynamic Loads," *IEEE Trans. Industrial Electronics*, vol. 61, no. 4, pp.1643-1658, April 2014
- [60] Coelho, E.A.A.; Cortizo, P.C.; Garcia, P.F.D., "Small-signal stability for parallel-connected inverters in stand-alone AC supply systems," *Industry Applications, IEEE Transactions on*, vol.38, no.2, pp.533,-542, Mar/Apr. 2002.
- [61] Dong, D.; Boroyevich, D.; Mattavelli, P.; Xue, Y. "Analysis of Phase-Locked Loop Low Frequency Stability in Three-Phase Grid-Connected Power Converters Considering Impedance Interactions," *Industrial Electronics, IEEE Transactions on*, vol.62, no.1, pp. 310 - 321, Jan. 2015.
- [62] J. Vasquez, J. Guerrero, J. Miret, M. Castilla, and L. de Vicuña, "Hierarchical control of intelligent microgrids," *IEEE Ind. Electron. Mag.*, vol. 4, pp. 23-29, Dec 2010.
- [63] A. Micallef, M. Apap, C. Spiteri-Staines, and J. M. Guerrero, "Secondary control for reactive power sharing in droop-controlled islanded microgrids," in *IEEE Intern. Symp. Ind. Electron. (ISIE)*, pp. 1627-1633, May 2012.
- [64] A. Mehrizi-Sani and R. Iravani, "Potential-function based control of a microgrid in islanded and grid-connected modes," *IEEE Trans. Power Syst.*, vol. 25, pp. 1883-1891, Nov 2010.
- [65] Qobad Shafiee, Cedomir Stefanović, Tomislav Dragičević, Petar Popovski, Juan C. Vasquez, Josep M. Guerrero, "Robust Networked Control Scheme for Distributed Secondary Control of Islanded Microgrids," *IEEE Transactions on Industrial Electronics*, vol.61, no.10, pp. 5363 - 5374, Oct. 2014.
- [66] H. Liang, B. J. Choi, W. Zhuang, X. Shen, A. S. A. Awad, and A. Abdr, "Multiagent coordination in microgrids via wireless networks," *IEEE Wireless Commun.*, vol. 19, pp. 14-22, June 2012.
- [67] D. Niyato, L. Xiao, and P. Wang, "Machine-to-machine communications for home energy management system in smart grid," *IEEE Commun. Mag.*, vol. 49, 2011.
- [68] V. C. Gungor, D. Sahin, T. Kocak, S. Ergut, C. Buccella, C. Cecati, and G. P. Hancke, "Smart Grid Technologies: Communication Technologies and Standards," *IEEE Trans. Ind. Informatics*, vol. 7, pp. 529-539, 2011.
- [69] S. D. J. McArthur, E. M. Davidson, V. M. Catterson, A. L. Dimeas, N. D. Hatziargyriou, F. Ponci, and T. Funabashi, "Multi-Agent Systems for Power Engineering Applications—Part II: Technologies, Standards, and Tools for Building Multi-agent Systems," *IEEE Trans. Power Syst.*, vol. 22, no. 4, pp. 1753-1759, Nov. 2007.
- [70] R. C. Qiu, Z. Hu, Z. Chen, N. Guo, R. Ranganathan, S. Hou, and G. Zheng, "Cognitive Radio Network for the Smart Grid: Experimental System Architecture, Control Algorithms, Security, and Microgrid Testbed," *IEEE Trans. Smart Grid*, vol. 2, pp. 724-740, 2011.
- [71] R. Olfati-Saber and R. M. Murray, "Consensus problems in networks of agents with switching topology and time-delays," *IEEE Trans. Autom. Control*, vol. 49, pp. 1520-1533, Sept 2004.
- [72] R. Olfati-Saber, J. A. Fax, and R. M. Murray, "Consensus and cooperation in networked multi-agent systems," *Proceedings of the IEEE*, vol. 95, no. 1, pp. 215-233, Jan. 2007.
- [73] Kriegleder, M., Oung, R., D'Andrea, R., "Asynchronous implementation of a distributed average consensus algorithm," *Intelligent Robots and Systems (IROS), 2013 IEEE/RSJ International Conference on*, vol., no., pp.1836-1841, 3-7 Nov. 2013
- [74] D. Spanos, R. Olfati-Saber, and R. Murray, "Dynamic consensus for mobile networks," in *IFAC World Congress*, 2005.
- [75] L. Xiao and S. Boyd, "Fast linear iterations for distributed averaging," in *Proc. 42nd IEEE Int. Conf. Decis. Control*, vol. 5. Maui, HI, USA, 2003, pp. 4997-5002.
- [76] A. Kaveh. *Optimal Analysis of Structures by Concepts of Symmetry and Regularity*, Springer-Verlag Wien, 2013.
- [77] M. Savaghebi, A. Jalilian, J. C. Vasquez, and J. M. Guerrero, "Secondary control scheme for voltage unbalance compensation in an islanded droop controlled microgrid," *IEEE Trans. Smart Grid*, vol. 3, pp. 797-807, June 2012.
- [78] M. Savaghebi, A. Jalilian, J. C. Vasquez, and J. M. Guerrero, "Secondary control for voltage quality enhancement in microgrids," *IEEE Trans. Smart Grid*, vol. 3, pp. 1893-1902, Dec 2012.
- [79] K. Jong-Yul, J. Jin-Hong, K. Seul-Ki, C. Changhee, P. June-Ho, K. Hak-Man, and N. Kee-Young, "Cooperative control strategy of energy storage system and microsourses for

- stabilizing the microgrid during islanded operation,” *IEEE Trans. Power Electron.*, vol. 25, no. 12, pp. 3037–3048, Dec. 2010.
- [80] S. Adhikari and F. Li, “Coordinated V-f and P-Q control of solar photovoltaic generators with MPPT and battery storage in microgrids,” *IEEE Trans. Smart Grid*, vol. 5, no. 3, pp. 1270–1281, May 2014.
- [81] H. Bode, *Lead Acid Batteries*. New York: Wiley, 1977.
- [82] G. L. Soloveichik, “Battery technologies for large-scale stationary energy storage,” *Annu. Rev. Chem. Biomol. Eng.*, vol. 2, no. 1, pp. 503–527, 2011.
- [83] M. A. Casacca and Z. M. Salameh, “Determination of lead-acid battery capacity via mathematical modeling techniques,” *IEEE Trans. Energy Convers.*, vol. 7, no. 3, pp. 442–446, 1992.
- [84] Y.-K. Chen, Y.-C. Wu, C.-C. Song, and Y.-S. Chen, “Design and implementation of energy management system with fuzzy control for DC microgrid systems,” *IEEE Trans. Power Electron.*, vol. 28, no. 4, pp. 1563–1570, Apr. 2013.
- [85] Xiong Liu, Peng Wang, and Poh Chiang Loh, “A Hybrid AC/DC Microgrid and Its Coordination Control,” *IEEE Trans. Smart Grid*, vol. 2, no. 2, pp. 278–286, Jun. 2011.
- [86] J. Han, S. K. Solanki, and J. Solanki, “Coordinated Predictive Control of a Wind/Battery Microgrid System,” *IEEE J. Emerg. Sel. Top. Power Electron.*, vol. 1, no. 4, pp. 296–305, Dec. 2013.
- [87] Y. Guan, J. M. Guerrero, J. C. Vasquez. “Coordinated secondary control for balanced discharge rate of energy storage system in islanded microgrids,” *Power Electronics and ECCE Asia (ICPE-ECCE Asia), 2015 International Conference on*, 1-5 June 2015, Seoul, PP: 475 – 481.
- [88] Xiaonan Lu, Kai Sun, Guerrero, J.M.; Vasquez, J.C.; Lipei Huang, “State-of-Charge Balance Using Adaptive Droop Control for Distributed Energy Storage Systems in DC Microgrid Applications,” *Industrial Electronics, IEEE Transactions on*, vol.61, no.6, pp.2804,2815, June 2014
- [89] T. Dragicevic, J. Guerrero, J. Vasquez, and D. Skrlec, “Supervisory control of an adaptive-droop regulated DC microgrid with battery management capability,” *IEEE Trans. Power Electron.*, vol. 29, no. 2, pp. 695–706, Feb. 2013.
- [90] Kakigano, H.; Miura, Y.; Ise, T., “Distribution Voltage Control for DC Microgrids Using Fuzzy Control and Gain-Scheduling Technique,” *Power Electronics, IEEE Transactions on*, vol.28, no.5, pp.2246-2258, May 2013.
- [91] Chendan Li, Dragicevic, T., Diaz, N.L., Vasquez, J.C., Guerrero, J.M., “Voltage scheduling droop control for State-of-Charge balance of distributed energy storage in DC microgrids,” *Energy Conference (ENERGYCON), 2014 IEEE International*, 13-16 May 2014, Cavtat, pp: 1310-1314.
- [92] Q. Shafiee, J. M. Guerrero, J. C. Vasquez, “Distributed Secondary Control for Islanded Microgrids—A Novel Approach,” *IEEE Transactions on Power Electronics*, vol.29, no.2, pp. 1018-1031, April 2013.
- [93] Qobad Shafiee, Cedomir Stefanovic, Tomislav Dragicevic, Petar Popovski, C. Vasquez and Josep M. Guerrero, “Robust Networked Control Scheme for Distributed Secondary Control of Islanded Microgrids,” *IEEE Transactions on Industrial Electronics*, vol.61, no.10, pp. 5363-5374, December 2013.
- [94] D. Wu, F. Tang, T. Dragicevic, J. C. Vasquez, J. M. Guerrero, “A Control Architecture to Coordinate Renewable Energy Sources and Energy Storage Systems in Islanded Microgrids,” *IEEE Transactions on Smart Grid*, vol.6, no.3, pp. 1156-1166, December 2013.
- [95] D. Wu, T. Dragicevic, J. C. Vasquez, J. M. Guerrero, Y. Guan, “Secondary coordinated control of islanded microgrids based on consensus algorithms,” *Energy Conversion Congress and Exposition (ECCE)*, 2014 IEEE, 14-18 Sept. 2014, Pittsburgh, PA, pp: 4290-4297.
- [96] Chendan Li, Garcia Plaza, M., Andrade, F., Vasquez, J.C., Guerrero, J.M., “Multiagent based distributed control for state-of-charge balance of distributed energy storage in DC microgrids,” *Industrial Electronics Society, IECON 2014*, Oct. 29 2014-Nov. 1 2014, Dallas, pp: 2180 – 2184.
- [97] Diaz, N.L., Dragicevic, T., Vasquez, J.C., Guerrero, J.M. “Intelligent Distributed Generation and Storage Units for DC Microgrids—A New Concept on Cooperative Control Without Communications Beyond Droop Control,” *Smart Grid, IEEE Transactions on*, vol. 5, no. 5, pp: 2476 – 2485, Sept. 2014.

- [98] N. L. Diaz, T. Dragicevic, J. C. Vasquez, J. M. Guerrero. "Fuzzy-logic-based gain-scheduling control for state-of-charge balance of distributed energy storage systems for DC microgrids," *Applied Power Electronics Conference and Exposition (APEC)*, 2014 Annual IEEE, 16-20 Mar. 2014, Fort Worth, TX, pp: 2171 - 2176.
- [99] N. Pogaku, "Analysis, control and testing of inverter-based distributed generation in standalone and grid-connected applications," *University of London*, 2006.
- [100] Meng, L., Dragicevic, T., Roldan-Perez, J., Vasquez, J.C., Guerrero, J.M., "Modeling and Sensitivity Study of Consensus Algorithm-Based Distributed Hierarchical Control for DC Microgrids," *Smart Grid, IEEE Transactions on*, vol., no.99, pp., May. 2015.
- [101] Lexuan Meng, Tomislav Dragicevic, Josep M. Guerrero, Juan C. Vásquez, "Tertiary and Secondary Control Levels for Efficiency Optimization and System Damping in Droop Controlled DC-DC Converters," *IEEE Transactions on Smart Grid*, vol.6, no.6, pp. 2615 - 2626, June, 2015.
- [102] Lexuan Meng, Fen Tang, Mehdi Savaghebi, Juan C. Vasquez, Josep M. Guerrero, "Tertiary Control of Voltage Unbalance Compensation for Optimal Power Quality in Isolated Microgrids," *IEEE Transactions on Energy Conversion*, vol.29, no.4, pp.802-815, Dec. 2014.
- [103] Chengshan Wang, Xianshen Yang, Zhen Wu, Yanbo Che, Li Guo, Shuhuai Zhang, Yixin Liu, "A Highly Integrated and Reconfigurable Microgrid Testbed with Hybrid Distributed Energy Sources," *IEEE Transactions on Smart Grid*, vol.7, no.1, pp. 451 - 459, Jan. 2016.
- [104] Chengshan Wang, Xialin Li, Li Guo, Yun Wei Li, "A Nonlinear-Disturbance-Observer-Based DC-Bus Voltage Control for a Hybrid AC/DC Microgrid," *IEEE Transactions on Power Electronics*, vol.29, no.11, pp. 6162 - 6177, Nov. 2014.
- [105] Poh Chiang Loh, Ding Li, Yi Kang Chai, Frede Blaabjerg, "Autonomous Control of Interlinking Converter With Energy Storage in Hybrid AC-DC Microgrid," *IEEE Transactions on Industry Applications*, vol.49, no.3, pp. 1374- 1382, May-June 2013.
- [106] Farzam Nejabatkhah, Yun Wei Li, "Overview of Power Management Strategies of Hybrid AC/DC Microgrid," *IEEE Transactions on Power Electronics*, vol.30, no.12, pp. 7072- 7089, Dec. 2015.
- [107] Navid Eghtedarpour, Ebrahim Farjah, "Power Control and Management in a Hybrid AC/DC Microgrid," *IEEE Transactions on Smart Grid*, vol.5, no.3, pp. 1494 - 1505, May 2014.
- [108] Xiaonan Lu, Josep M. Guerrero, Kai Sun, Juan C. Vasquez, Remus Teodorescu, Lipei Huang, "Hierarchical Control of Parallel AC-DC Converter Interfaces for Hybrid Microgrids," *IEEE Transactions on Smart Grid*, vol.5, no.2, pp. 683 - 692, Mar. 2014.
- [109] X. Lu, K. Sun, J. M. Guerrero, J. C. Vasquez, and L. Huang, "Double-Quadrant State-of-Charge-Based Droop Control Method for Distributed Energy Storage Systems in Autonomous DC Microgrids," *IEEE Trans. Smart Grid*, vol. 6, no. 1, pp. 147-157, Jan. 2015.
- [110] I. Serban and C. Marinescu, "Control Strategy of Three-Phase Battery Energy Storage Systems for Frequency Support in Microgrids and with Uninterrupted Supply of Local Loads," *IEEE Trans. Power Electron.*, vol. 29, no. 9, pp. 5010-5020, Sep. 2014.
- [111] R. Teodorescu and F. Blaabjerg, "Flexible Control of Small Wind Turbines With Grid Failure Detection Operating in Stand-Alone and Grid-Connected Mode," *IEEE Trans. Power Electron.*, vol. 19, no. 5, pp. 1323-1332, Sep. 2004.
- [112] F. Blaabjerg, R. Teodorescu, M. Liserre, and A. V. Timbus, "Overview of Control and Grid Synchronization for Distributed Power Generation Systems," *IEEE Trans. Ind. Electron.*, vol. 53, no. 5, pp. 1398-1409, Oct. 2006.
- [113] D. Wu, F. Tang, T. Dragicevic, J. C. Vasquez, and J. M. Guerrero, "A Control Architecture to Coordinate Renewable Energy Sources and Energy Storage Systems in Isolated Microgrids," *IEEE Trans. Smart Grid*, vol. 3, no. 4, pp. 1156-1166, May 2015.
- [114] J.-Y. Kim, S.-K. Kim, and J.-H. Jeon, "Coordinated state-of-charge control strategy for microgrid during islanded operation," in *Proc. IEEE Conf. Power Electron. Distrib. Gener. Syst. (PEDG)*, Aalborg, Denmark, 2012, pp. 133-139.
- [115] K. T. Tan, P. L. So, Y. C. Chu, and M. Z. Q. Chen, "Coordinated control and energy management of distributed generation inverters in a microgrid," *IEEE Trans. Power Del.*, vol. 28, no. 2, pp. 704-713, Apr. 2013.
- [116] Wu Chun Sheng; Liao Hua; Yang Zi Long; Wang Yi Bo; Peng Yan Chang; Xu Hong Hua, "Research on control strategies of small-hydro/PV hybrid power system," *Sustainable Power Generation and Supply*, pp.1-5. 2009.

## LITERATURE LIST

- [117]Kusakana, K., Munda, J.L., Jimoh, A.A., "Feasibility study of a hybrid PV-micro hydro system for rural electrification," *AFRICON, 2009. AFRICON '09*, pp. 1-5, Sept. 2009.
- [118]Zhou, J.H., Ge, X.H.; Zhang, X.S., Gao, X.Q. and Liu, Y., "Stability simulation of a MW-scale PV-small hydro autonomous hybrid system," *Power and Energy Society General Meeting (PES)*, pp. 1-5. 2013.
- [119]Wang Yibo, Xu Honghua, "Research and Practice of Designing Hydro/Photovoltaic Hybrid Power System in Microgrid," *Photovoltaic Specialists Conference (PVSC)*, pp. 1509-1514. 2013
- [120]Priolkar, J.G., Doolla, S, "Analysis of PV-hydro isolated power systems," *2013 Annual IEEE India Conference (INDICON)*, pp. 1-6. 2013.
- [121]Hasmaini Mohamada,b, Hazlie Mokhlisa, Ab Halim Abu Bakara, Hew Wooi Ping, "A review on islanding operation and control for distribution network connected with small hydro power plant," *Renewable and Sustainable Energy Reviews*, vol.15, pp.3952-3962, August. 2011.
- [122]S.J. Williamson, A. Griffo, B.H. Stark, J.D. Booker, "A controller for single-phase parallel inverters in a variable-head pico-hydropower off-grid network," *Sustainable Energy, Grids and Networks*, pp. 1-11, Nov. 2015.
- [123]Khalilzadeh, E., Fotuhi-Firuzabad, M., Aminifar, F., Ghaedi, A., "Reliability Modeling of Run-of-the-River Power Plants in Power System Adequacy Studies," *Sustainable Energy, IEEE Transactions on*, vol. 5, No. 4, pp. 1949-3029, Oct. 2014.
- [124]Prabha Kundur, *Power System Stability and Control*, 1st ed., *New York: McGraw-Hill*, 1993, pp. 315-1022.
- [125]P.K Olulope, K.A Folly, Ganesh K. Venayagamoorthy, "Modeling and simulation of hybrid distributed generation and its impact on transient stability of power system," *Industrial Technology (ICIT), 2013 IEEE International Conference on*, pp.1757-1762, Feb. 2013.
- [126]J. H. Zhou, P. L. X. H. Ge, X. S. Zhang, X. Q. Gao, Y. Liu, "Stability Simulation of a MW-Scale PV-Small Hydro Autonomous Hybrid System," *Power and Energy Society General Meeting (PES)*, 2013 IEEE, pp.1-5, July 2013.
- [127] IEEE Guide for the Application of Turbine Governing Systems for Hydroelectric Generating Units, IEEE Std 1207TM-2011, June, 2011.
- [128]Hagihara, S., Yokota, H., Goda, K., Isobe, K., "Stability of a Hydraulic Turbine Generating Unit Controlled by P.I.D. Governor," *Power Apparatus and Systems, IEEE Transactions on*, vol. PAS-98, no. 6, pp. 2294 - 2298, Nov. 1979.
- [129]E. Ghahremani, M. Karrari, O.P. Malik, "Synchronous generator third-order model parameter estimation using online experimental data," *IET Gener. Transm. Distrib.*, vol. 2, no. 5, pp. 708 - 719, April, 2008.
- [130]Alizadeh, G., Ghiasi, A.R., Javadi, "A.Nonlinear  $H^\infty$  Control of a Third-Order Synchronous Generator Model," *Ultra-Modern Telecommunications and Control Systems and Workshops (ICUMT), 2012 4th International Congress on*, pp. 455-461, 2012.
- [131]IEEE Recommended Practice for Excitation System Models for Power System Stability Studies, IEEE Std 421.5-1992, March, 1992.
- [132]F. Katiraei, M.R. Iravani, P.W. Lehn, "Small-signal dynamic model of a micro-grid including conventional and electronically interfaced distributed resources," *IET Gener. Transm. Distrib.*, vol. 1, no. 3, pp. 369-378, 2007
- [133]Hongqing Fang, Long Chen, Dlakavu, N., Zuyi Shen, "Basic Modeling and Simulation Tool for Analysis of Hydraulic Transients in Hydroelectric Power Plants," *Energy Conversion, IEEE Transactions on*, vol. 23, no. 3, pp. 834 - 841, Sept. 2008.
- [134]Souza, O.H., Jr., Barbieri, N., Santos, A.H.M., "Study of hydraulic transients in hydropower plants through simulation of nonlinear model of penstock and hydraulic turbine model," *IEEE Transactions on Power Systems*, vol. 14, no. 4, pp. 1269 - 1272, Nov. 1999.
- [135]Thorne, D.H., Hill, E.F., "Field Testing and Simulation of Hydraulic Turbine Governor Performance," *Power Apparatus and Systems, IEEE Transactions on*, vol.93, no.4, pp.1183-1191, July 1974.

ISSN (online) – 2246-1248  
ISBN (online) - 978-87-7112-775-1

AALBORG UNIVERSITY PRESS