



Aalborg Universitet

AALBORG UNIVERSITY
DENMARK

Transforming PBL Through Hybrid Learning Models

Timely Challenges and Answers in a (Post)-Pandemic Perspective and Beyond

Scholkmann, Antonia; Telléus, Patrik K.; Ryberg, Thomas; Hung, Woei; Andreasen, Lars Birch; Kofoed, Lise Busk; Christiansen, Nanna Limskov Stærk; Nielsen, Stine Randrup

Creative Commons License
CC BY-NC-ND 4.0

Publication date:
2021

Document Version
Publisher's PDF, also known as Version of record

[Link to publication from Aalborg University](#)

Citation for published version (APA):

Scholkmann, A., Telléus, P. K., Ryberg, T., Hung, W., Andreasen, L. B., Kofoed, L. B., Christiansen, N. L. S., & Nielsen, S. R. (Eds.) (2021). *Transforming PBL Through Hybrid Learning Models: Timely Challenges and Answers in a (Post)-Pandemic Perspective and Beyond*. Aalborg Universitetsforlag. International Research Symposium on PBL

General rights

Copyright and moral rights for the publications made accessible in the public portal are retained by the authors and/or other copyright owners and it is a condition of accessing publications that users recognise and abide by the legal requirements associated with these rights.

- Users may download and print one copy of any publication from the public portal for the purpose of private study or research.
- You may not further distribute the material or use it for any profit-making activity or commercial gain
- You may freely distribute the URL identifying the publication in the public portal -

Take down policy

If you believe that this document breaches copyright please contact us at vbn@aub.aau.dk providing details, and we will remove access to the work immediately and investigate your claim.



PBL 2021

INTERNATIONAL CONFERENCE

TRANSFORMING PBL THROUGH
HYBRID LEARNING MODELS
– TIMELY CHALLENGES AND ANSWERS
IN A (POST-)PANDEMIC PERSPECTIVE AND BEYOND

AALBORG UNIVERSITY, AALBORG, DENMARK
AUGUST 17-19, 2021

Transforming PBL through Hybrid Learning Models

– Timely Challenges and Answers in a (Post)-Pandemic Perspective and Beyond

Edited by Antonia Scholkmann, Patrik Kjærdsdam Telléus, Thomas Ryberg, Woei Hung, Lars Birch Andreasen, Lise Busk Kofoed, Nanna Limskov Stærk Christiansen, Stine Randrup Nielsen

Series: International Research Symposium on PBL

© The authors, 2021

Cover designed by Vestergaards Bogtrykkeri

ISBN: 978-87-7210-745-5

ISSN: 2446-3833

Published by Aalborg University Press | forlag.aau.dk

PBL 2021 International Conference, August 17-19, 2021

Transforming PBL through Hybrid Learning Models – Timely Challenges and Answers in a (Post)-Pandemic Perspective and Beyond

All PANPBL conference proceedings are available at: <http://www.panpbl.org/conferences/>

The PBL 2021 conference proceedings will be officially launched two weeks before the conference. The PBL 2021 International Conference is hosted by Aalborg University in collaboration with the PAN-PBL Association of PBL and Active Learning and the PBL Future Research Initiative at Aalborg University. The conference will be held in conjunction with the IRSPBL 2021 conference. The PBL 2021 International Conference will be held as a virtual event which has been organised after its postponement in 2020 due to the COVID-19 pandemic and international restrictions imposed to control the spread of the disease.



Responsibility for the content published, including any opinions expressed therein, rests exclusively with the author(s) of such content.

General Copyrights

The authors and/or other copyright owners retain copyright and moral rights for the publications made accessible in the public portal and it is a condition of accessing publications that users recognise and abide by the legal requirements associated with these rights. Users may download and print one copy of any publication from the public portal for the purpose of private study or research. You may not further distribute the material or use it for any profit-making activity or commercial gain. You may freely distribute the URL identifying the publication in the public portal.

Take down policy

If you believe that this document breaches copyright, please contact aauf@forlag.aau.dk providing details and we will remove access to the work immediately and investigate your claim.

WELCOME BY THE ORGANIZING COMMITTEE

Dear participants at the PBL2021 International Conference (online),

A very warm welcome from the Organizing Committee.

Who would have thought that, when the first call for papers for our event was published in the summer of 2019, we would meet in a very differently looking world two years afterwards? The Corona pandemic has challenged the educational world. PBL practitioners and researchers alike were called upon to bring forward their knowledge, experience and creativity in designing and implementing solutions to digitally supported pedagogies.

In a way, the PBL and active learning community has held huge resources here – a deep understanding of the cognitive, motivational, emotional and social implications of the learning process. Extensive experience with the orchestration of self-directed and student-centered approaches as well as a long-standing engagement in exploration and enrichment of learning scenarios by digital possibilities. However, the challenges have been considerable as well: how do we maintain engagement amongst students in a time of physical and therefore also social distancing? How do we create places and spaces for group work and meaningful interaction in the digital sphere? And not to forget, how do we keep the relationships alive between the university-ecosystem and the rest of the world, in which the problems our students are working on have their arena?

The PBL2021 International Conference is intended as a space and place to bring together PBL practitioners and researchers to share our insights and experiences around the powerful approaches of PBL and Active Learning. Under the conference title *Transforming PBL Through Hybrid Learning Models* we want to invite all participants to share, watch, listen to, discuss and engage with the insights and experiences from both the Corona-period and from PBL and active learning practices in general. With three outstanding keynotes and almost 100 contributions in various formats we hope the conference will provide a rich (digital) environment for this. The proceedings certainly are a testament to the richness and breadth of the topics and insights the PBL and Active Learning community has to share.

The conference would not have been possible without the willingness to collaborate with us. We would like to express our gratitude to the PAN-PBL Association of PBL and Active Learning for entrusting us with the hosting of the 11th conference in the successful conference series, and for being excellent collaboration partners throughout this journey. Difficult decisions, such as the postponement of the conference, had to be made and we were extremely glad to have the PAN-PBL board with us on these decisions at all times.

From an Aalborg University perspective, the planning of the conference has been a cross-faculty/cross-department initiative connected with the PBL Future research project, headed by Prof. Anette Kolmos. We would therefore also like to thank Aalborg University and our faculties and departments for being willing to host the conference and for their generous financial support. There are several colleagues who were willing to dedicate their time to the conference as well: as members of the Scientific Committee throughout the submission and review process, and as chairs in our various sessions over the next three days. We would like to thank all of you for making this conference possible through your engagement.

Also, an incredible team of assistants has worked backstage to bring this event to life, both within Aalborg University and at our collaboration partner Morressier. Specifically, Stine Randrup Nielsen, Nanna Limskov Stærk Christiansen, Josefine Kristine Schou Jakobsen and Natalie Alisa Spaabæk Baliti must be mentioned here – thank you for the huge efforts you put into organizing the event and the proceedings.

Last but not least, we would like to thank all of you, the participants of the PBL2021 International Conference for being part of this event and for sharing your knowledge and experiences.

Antonia Scholkmann, Thomas Ryberg and Patrik Kjærdsdam Telléus

Organizing Committee PBL2021 International Conference.

WELCOME BY THE PAN-PBL ASSOCIATION

Dear PBL2021 participants,

On behalf of the PAN-PBL Association of Problem-Based Learning and Active Learning Methodologies, it is my pleasure to welcome you to the PBL2021 International Conference, co-organized by Aalborg University.

The PBL Conference series has had its origin in the year 2000, when Samford University in Birmingham, Alabama, USA, organized the first meeting, aiming to explore the use of PBL in undergraduate learning. Since then, the conference has been held bi-annually and altogether ten times, at the following universities and countries: University of Delaware, USA (2002), Instituto Tecnológico de Monterrey, México (2004), Pontificia Universidad Católica del Perú (2006), Universidad de Colima, Mexico (2008), Universidade de São Paulo, Brazil (2010), Universidad Autónoma de Occidente, Colombia (2012), Universidad del Bio-Bio, Chile (2014), Universidade de São Paulo, Brazil (2016) and Santa Clara University, USA (2018). In 2019 we organized the PBL2019 Immersive Virtual International Conference.

We are thankful to Aalborg University for hosting the 11th conference of this series. Aalborg University is an international reference for the development and diffusion of the Problem-Based Learning paradigm, and well recognized as an innovative and state-of-the-art higher education institution. Working with their professors and staff has been remarkable and a rich experience for the PANPBL Board and our community.

The COVID-19 pandemic has affected the whole world, recently, promoting changes in all dimensions of human life, and also, specifically, in the way we understand science and the processes of teaching and learning. The conference theme - ***Transforming PBL through Hybrid models – timely challenges and answers in a (post)-pandemic perspective and beyond*** - encourages us to think about a re-invention of education. We expect that the conference will foster powerful contributions to the educational world, and the practice of teachers and professors worldwide.

Thank you all for being part of this conference at this historical moment. Thank you for supporting the PBL2021 International Conference and for sharing your innovative and challenging experience on PBL and other active learning methodologies.



Prof. Dr. Ulisses F. Araujo

PAN-PBL Association President

University of São Paulo, Brazil

Transforming PBL through hybrid learning models

– timely challenges and answers in a (post-)pandemic perspective and beyond

Content

Welcome by the organizing committee	3
Welcome by the PAN-PBL association.....	5
Keynote 1 - Reimagining General Education: Design Thinking and Intrinsic Motivation Perspectives <i>Richard K. Miller</i>	14
Keynote 2 - Hybrid models and unbundled provision <i>Laura Czerniewicz</i>	16
Keynote 3 - The future of PBL: How to move from a one-size-fits-all copy-paste approach to customized PBL alternatives? <i>Diana Dolmans</i>	18

Interdisciplinary PBL and active learning

- *Kathleen Jantaraweragul, Minji Jeon, Krista Glazewski, Anne Ottenbreit-Leftwich, Cindy Hmelo-Silver, Seung Lee, Bradford Mott and James Lester*
The Participatory Co-Design of a Problem-Based Learning Artificial Intelligence Elementary Curriculum 21
- *Elisabeth Lauridsen Lolle and Antonia Scholkmann*
What have We Learned? On Students' Perceptions of Learning and Progressing through PBL..... 28
- *Mahnaz Moallem, Sridhar Narrayan and Gabriel Lugo*
Problem/Project-Based Learning and Computing: An Integrated Approach to Teaching STEM..... 29
- *Barbara Iverson, Martin Knobel, Eva-Maria Lindig and Adam Roe*
The First Semester at CODE: Preparing Students for Project-Based Learning in a Curiosity-Driven Higher Education Learning Environment 33
- *Vishalache Balakrishnan*
Integrating PBL in Service Learning: A Hybrid Approach for 21st Century Learning 38
- *Elvina Smith and Ryk Lues*
Teaching Entrepreneurship at Universities of Technology by using a novel pedagogic approach 39
- *María José Terrón-López, José Omar Martínez-Lucci and Víctor Manuel Padrón-Nápoles*
Practice-based study: Implementation of a multidisciplinary PBL approach in a design and manufacture of an UAV in Aerospace Engineering bachelor's degree..... 45

● <i>Derek Raine and Sarah Gretton</i> From PBL to Problem-based tuition: Adapting PBL for Interdisciplinary Science.....	53
● <i>Dorothy Haskell and Jerry Dunn</i> FORECAST for the Future: Problem Based Learning-Simulations to Equip Multidisciplinary Child-Serving Professionals.....	57
● <i>Caitrin Lynch, Lawrence Neeley, Joanne Pratt and Jason Woodard</i> Cultivating an Entrepreneurial Mindset in the Classroom and Beyond: Tools for Experimentation, Critical Learning, and Change	59
● <i>Simone Yuriiko Kameo, Glebson Moura Silva, Namie Okino Sawada, Ricardo Barbosa Lima, Tiago Vasconcelos Fonseca, Andressa Cabral Vassilievitch and Pablaine Matias Lordelo Marinho</i> Use of active teaching-learning methodologies in National Humanization Policy and Unique Therapeutic Project.....	65
● <i>Simone Yuriiko Kameo, Glebson Moura Silva, Namie Okino Sawada, Bruno Ferreira Amorim, Jessica Santos Costa, Maria Julia Oliveira Ramos and Pablaine Matias Lordelo Marinho</i> Clinical Practice Examination: experience with discents at the health area in Brazil	67
● <i>Dr. Anjali Bhalchandra, Sushama Agrawal and Dr. Pranesh Murnal</i> Role of PBL in Engineering Education (Robocon: Case Study of Multidisciplinary Project).....	69
● <i>Michiko Ito, Masato Nakamura, Hiroyo Sugimoto and Yukiyooshi Kobayashi</i> The Effects of Interdisciplinary Team Teaching on PBL.....	75

Project PBL - Case PBL

● <i>Mahnaz Moallem, William Sterrett and Christopher Gordon</i> An Investigation of the Effects of Integrating Computing and Project or Problem-based Learning: The Impact on Pakistani STEM Teachers.....	83
● <i>Eduardo Avendaño and Liliana Fernández-Samacá</i> Diagnose, Analysis, and Proposal of Project-Based Learning (PBL): A Case for Analog Communications Course.....	85
● <i>Nasser Drareni</i> Effectiveness of problem-based learning on learners' critical thinking skills on troponin I in myocardial infarction risk prediction	87
● <i>Vanessa F. M. de Queiroz, Celson P. Lima and Ricardo Kratz</i> PBL applied in the Freshman year of a Mechanical Engineering Program in Southern Brazil	91
● <i>Lihu Xu</i> Analysis of Entrepreneurship Education Pedagogy in Project-based Learning from the Perspective of Life Cycle Theory.....	98
● <i>Vinina Ferreira and Reboucas Patricia</i> PBL Applied to Fieldwork Classes of Zoology.....	104

● <i>Kaizhen Jia, Xiaohui Li, Bo Yan, Furong Gao and Jing Xiao</i> Reflection on How to Guide Students to Return to Value in Teaching A Case Study of PBL-based Construction Festival	105
● <i>Victor Dueñas</i> Course in Transfusion Medicine with a Pedagogical Approach to Problem-Based Learning	107
● <i>Vibeke Andersson and Helene Balslev Clausen</i> Co-Creation Knowledge for the World	112
● <i>Stine Bylin Bundgaard and Diana Stentoft</i> Cross-educational collaboration on case didactics	113
● <i>Luis Antonio Galhego Fernandes and Dulce Helena Soares</i> From Bullying to Solidarity - the PBL As A Pillar of Citizenship	118
● <i>David Hik and Paul Kench</i> Problem-based learning as the foundation for a new undergraduate program in Agricultural Technology (AgriTech)	122
● <i>Maria Patricia Leon Neira, Carola Hernández Hernández and Sofia Andrae Pardo</i> The Constructive Alignment in a Civil Engineering Capstone Project	125
● <i>Setsuko Isoda, Manabu Moriyama, Sadayuki Shimoda and Michiko Ito</i> PBL and Disaster–Regeneration by Students and Local Residents of a Historic Redbrick Warehouse Damaged in the 2016 Kumamoto Earthquakes	130
● <i>Armin Eilaghi, Fadi Alkhatib, Hayder Abdul-Razzak and Martin Jaeger</i> A Project-Based Learning Approach in the Course of “Engineering Skills” for Undergraduate Engineering	132
● <i>Shiva Sadeghi, Majed Alsarheed and Fadi Alkhatib</i> A project-based learning approach in the course of “Engineering Project” for Mechanical Engineering diploma students	140
● <i>Janaki Shah, Ventris D’Souza and Ivane Tay</i> Investigating the effectiveness of Team-Based Learning in combination with Problem-Based Learning to enhance overall learning in Genetics	148

Philosophy and theory of PBL and active learning

● <i>Birthe Lund</i> Is character quality essential to the development of a “sustainability pedagogy” within a PBL learning community?	154
● <i>Woei Hung, Mahnaz Moallem and Nada Dabbagh</i> Socio-cultural Constructivist Learning Components in PBL	159
● <i>Yin Zhang, Yuli Zhao, Bin Zhang, Kening Gao and Chunang Zhou</i> Designing an Intermediate Level Problem-Based Learning (PBL) Model	160

- *Nada Dabbagh*
Aligning Learning Design Principles with Problem Design Principles to Foster Critical Thinking Skills in PBL 175
- *Jeroen van Merriënboer and Diana Dolmans*
Transforming PBL through Four-Component Instructional Design (4D/ID) 180

Methods for researching PBL and active learning

- *Deirdre Phelan, Olive Lennon and Terry Barrett*
Does interprofessional problem-based learning (iPBL) develop Interprofessional Education Collaborative (IPEC) core competences? 183
- *Bart Johnson and Ronald Ulseth*
Design Based Research for Project Based Learning Curriculum Development 185
- *Kathrine Thorndahl*
Listen! Significant sounds of silence in problem-based learning 192
- *Woei Hung, Diana Dolmans and Jeroen van Merriënboer*
Trends, gaps and future research directions of PBL research 193

Use of digital media and technologies in PBL and active learning

- *Thomas Brush, Anne Leftwich and Kyunghbin Kwon*
Implementing a problem-based computer science curriculum with elementary students: Impact on knowledge, skills, and attitudes 195
- *Ulisses Araujo*
Education for Purpose through ICT and active learning methods 197
- *Hans Hüttel, Dorina Gnaur and Eskil Olav Andersen*
How did PBL manage during the transition to online teaching due to the COVID-19 lockdown? .. 198
- *Daniel Bateman and Adam Hendry*
The hybridisation of PBL pedagogies is no impediment to improving student performance in state-wide standardised exit exams 205
- *Carolina Costa Cavalcanti, Cintia Vasques Hélcias, Lília Mascarenhas and Cristiane Baeta*
Hybrid Design Thinking Model to Project Development in Executive Education at FDC 212
- *Mia Thyrré Sørensen*
Student collaboration in a hybrid PBL environment – diversity in collaboration practice 216
- *Saleh Al-Busaidi and Tariq Yusuf*
A hybridized PBL language course design model 221
- *Roy Hanney*
Writing Praxis: promoting critical reflection among media practice students through blogging in Project-led Problem-based Learning 228

● <i>Marisa Cavalcante, João Freitas, Elio Molisani and Marcia Sacay</i> Creative electronics: description of practices based on the TPACK model in the continuous training of technology teachers in the hybrid environments	233
● <i>Pengyue Guo, Nadira Saab, Lin Wu and Wilfried Admiraal</i> Relationship between collaborative learning, need satisfaction, and student satisfaction with a blended project-based learning course	240
● <i>Afsaneh Hamedi d’Escoffier, Luiz Ney d’Escoffier and Marco Braga</i> An experience using PBL online: the Expin48 case	246
● <i>Jing Zhou, Shiyong Hou, Tao Sun, Xiqian Hu and Xin Xiao</i> Enhance Engineering Practice with Problem-based Learning in Hybrid Teaching.....	251
● <i>Emma O Brien</i> Problem based learning for all: Integrating UDL and PBL to support diverse learner needs	257
● <i>Sharifah Mohamed, Val Pakirisamy and Joanna Sin</i> New Media Literacy Tools in Self-Directed Learning	263
● <i>Rendell Tan</i> Problem-Based Learning: Bringing in Cognitive and Collaborative Authentic Learning into the On-Line Classroom	264
● <i>Thomas Brush, Krista Glazewski, Kyungbin Kwon and Anne Ottenbreit-Leftwich</i> Supporting PBL Practice in K-12 Education: The Wise Practice Video Case Database (WPCD) ..	269
● <i>Fiona Truscott, Emanuela Tilley, Kate Roach and John Mitchell</i> Perspectives on Putting a Large Scale First Year Interdisciplinary Project Module Online	275
● <i>Min Zhong</i> Ongoing Project-Based Learning in Different Modalities of the Introductory Biology Course During the Pandemic.....	281

PBL, active learning and life-long learning

● <i>David Ross Olanya, Geoffrey Olok Tabo, Hanan Lassen Zakaria, Inger Lassen, Judith Awacorach and Iben Jensen</i> A narrative Inquiry into Learning Practices and Career Opportunities in Graduate Education at Gulu University, Uganda	287
● <i>Giajenthiran Velmurugan</i> Exploring Epistemic Fluency in Group Work.....	301
● <i>Sanne Rovers, Anique de Bruin, Jeroen van Merriënboer and Hans Savelberg</i> The effects of a Biomedical Sciences curriculum reform on students’ perceived competence development	306
● <i>Ruth Black</i> Roundtable Discussion: PBL MSc for Senior Consultant Clinicians and IT Professionals in the British NHS	308

- *Fei Xiong and Lei Lei*
Implementing project-based language learning in college EFL classroom: teacher's perspectives 309
- *Pedro Hernández-Ramos, Cheryl Bowen, Kathy Sun and Keith Yocam*
A Collaborative Faculty Project to Introduce a Complex Framework for Teacher Practice 317
- *Hans Savelberg, Jascha De Nooijer, Matt Commers, Eleonore Köhler and Diana Dolmans*
Which instructional formats enhance the development of generic competencies? 324
- *Nicolaj Johansson and Diana Stentoft*
Problem-Based Learning: Assumed and assigned roles in Medical education 328
- *Elisiane Oliveira, Fabiano Walczak and Luiz Antonio Tozi*
Learning experiences in the technological education of Paula Souza Center - São Paulo 332

PBL, active learning, sustainability and participation

- *Birthe Lund*
When Future Workshops lead to innovative and entrepreneurial skills within PBL learning communities 347
- *Anders Melbye Boelt, Nanna Svarre Kristensen and Nicolaj Riise Clausen*
Experiences from implementation of a flipped and integrated semester structure and supporting baseline studies 353
- *Roberto Rivas Hermann, Marilia Bossle and Marcelo Amaral*
Lenses on the post-oil economy: Integrating entrepreneurship into sustainability education through problem-based learning 357
- *Annie Aarup Jensen and Lone Krogh*
The case of co-creation in a PBL University – a student perspective 383
- *Pernille Andersson and Niclas Andersson*
Realistic Role-Play with industry as a hybrid PBL course design aiming for develop professional engineering skills 384
- *Lena Gumaelius, Anders Rosén and Marc de Vries*
How to Assess Key Competences for Sustainability in Engineering Education 390
- *Graziela Fuentes and Tarsila Cimino Carvalho*
Habitat Help 395
- *Krista Glazewski, Thomas Brush, Tarrence Banks, Scott Wallace, Cindy Hmelo-Silver, Bradford Mott and James Lester*
From Physical to the Virtual and Everything in Between: Local Implementations and Adaptations of PBL in a Multiyear Middle School / University Partnership 398
- *Manoela Barros Guimarães, Denise Castro and Lucas Peres Guimarães*
Case study and jigsaw cooperative learning in teaching of hazardousness of chemicals 405

- *Jon Ram Bruun-Pedersen, Nanna Svarre Kristensen, Lise Busk Kofoed and Lars Birch Andreasen*
Student Reactions to Simultaneously Flipping All Courses On A Semester..... 410
- *Ana Paiva*
Sustainability at the heart of 21st century language learning through student centred methodologies: a didactical proposal..... 415

Education management PBL and active learning

- *Flávio Augusto Naoum, Felipe Pacca and Patrícia Cury*
Perceptions about tutoring process and curriculum contents among PBL groups of medical students: does it impact on final grades?..... 422
- *Bayan Alnuman, Thamir Ahmed and Barham Haydar*
Investigation on the Application of Project Based Learning in an Engineering Faculty in Iraq... 430
- *Mike Sæderup Astorp, Mathias Aalkjær Brix Danielsen, Gustav Valentin Blichfeldt Sørensen, Diana Stentoft and Stig Andersen*
Small-scale spiral structure for organizing PBL case sessions in medical domains..... 440
- *Stella Wasenitz and Janneke Frambach*
Reflection as Action: Keeping Educational Culture Alive Through PBL Research 445
- *Grazyna Budzinska and Dagna Siuda*
IFTE Continuous Feedback Model for PBL courses..... 449
- *Mario Giampaolo, Loretta Fabbri and Maria Ranieri*
Designing problem-based learning for blended programs: the collaboration among practitioners and researchers..... 454
- *Glebson Moura Silva, Simone Yuri Kameo, Rosemar Barbosa Mendes, Fernanda Gomes De Magalhães Soares Pinheiro, Andreia Freire De Menezes, Allan Dantas Dos Santos and Maria Do Socorro Claudino Barreiro*
Problem based learning for nursing training at Federal University of Sergipe..... 459
- *Benoit Raucent, Xavier Bollen, Dephine Ducarme, Christine Jacqmot, Elie Milgrom and Sandra Soares Frazao*
Learning to work in a group 471
- *Maria Patricia León Leon, Alejandra Maria Gonzalez Correal, Joan Sebastián Peña Campos and Juan Sebastian Fontalvo Garcia*
Active Learning (AL) in Selection Processes of Engineering..... 476
- *Angelica Burbano*
PBL from an academic administrator point of view 481
- *Hironori Yamaguchi, Kanae Murayama, Keiko Kitade, Chika Tohyama and Yuko Yasuda*
The process of learning and growing of peer supporters through place management: for curriculum and co-curriculum hybridization 482

Professional development/staff development for PBL and active learning

- *Lala Mammadova*
**Use of project-based learning in preparation of educational leaders:
 case of post-soviet Azerbaijan** 488
- *Eli Borochovicius and Elvira Cristina Martins Tassoni*
PBL beginnings at brazilian school 489
- *Chin Pei Tan, Anthony Goff and Edwina Rigby*
**Enhancing the approach for learning clinical reasoning process for beginning
 student physiotherapists** 501
- *Meike Bredendiek and Emilia Dr. Kmiotek-Meier*
**What is my Role? About the Service Learning Lecturer Role from
 the Problem-Based Learning Perspective** 503
- *João Freitas, Marisa Cavalcante, Marcia Sacay and Elio Molisani*
Teaching physical computing with activity cards and online simulators 509
- *Roy Hanney and Paul Stevens*
**I'm (not) an academic - get me out of here: promoting academic reading
 through active learning** 514
- *Elio Molisani, Macia Nobue Sacay, Marisa Cavalcante and João Freitas*
**The development of collaborative projects for hybrid learning
 during continuing teacher training** 518
- *Karen Guerrero and Margarita Jimenez-Silva Jimenez-Silva*
**STEMSS strategies professional development to support academic language ... development
 using PBL** 526
- *Bárbara de Caldas Melo, Fábio Ferreira Amorim, Marina Dia Pereira and Geisa Santana*
The perception of the teacher in the active teaching and learning process 534
- *Herbert G Silva*
Training science teachers in Brazil: BNCC, PBL, challenges and solutions 536
- *Siska Simon, Marisa Hammer, David Fasani*
Process of developing an international PBL-based study program 542

KEYNOTE 1 - REIMAGINING GENERAL EDUCATION: DESIGN THINKING AND INTRINSIC MOTIVATION PERSPECTIVES



Richard K. Miller, Olin College of Engineering, Massachusetts, USA

Abstract

With the rapidly growing influence of AI and asynchronous learning resources, the role of general education is rapidly evolving. To an unprecedented degree, it now not only matters “what you know” but “what you can do” with what you know. Thus, experiential learning is of growing importance in all of education. It requires making sense of what you know, self-expression, and taking action. Learning only from a book (or other passive resources) is simply not enough. Ideally, a balanced general education today should enable all students to find things out (research), make sense of the world (reflection and integration), and envision what has never been while learning to do what it takes to make it happen (take initiative). Learning in this way may also address the most prominent problem in higher education today (identified by Howard Gardner at Harvard in his recent seven-year study): belonging, mental health and wellbeing. A life-transformative education today should lay the foundation for flourishing throughout a lifetime. This talk will present some lessons learned at Olin College in the last 15+ years of experimentation. At Olin, all students take multiple semesters of Design Thinking, integrated with efforts to build intrinsic motivation, and complete more than 20 collaborative group design-build projects before graduation. They also work for two semesters with a corporate client who pays more than \$50,000 for the privilege of setting goals for their design work. Much if not all of this is transferable to any academic discipline, not just Engineering.

About

Richard K. Miller was appointed President and first employee of Olin College of Engineering in 1999 where he served for 21 years until he stepped down in June 2020 and became Emeritus President and Professor of Mechanical Engineering. He served as the Jerome C. Hunsaker Visiting Professor of Aerospace Systems at MIT

during the 2020-2021 academic year. Previously, he served as Dean of Engineering at the University of Iowa, Associate Dean of Engineering at USC in Los Angeles, and assistant professor of engineering at UCSB in Santa Barbara. With a background in applied mechanics and current interests in innovation in higher education, Miller is the author of numerous reviewed journal articles and other technical publications. He received the 2017 Brock International Prize in Education for his contributions to the reinvention of engineering education in the 21st century. Together with two Olin colleagues, he received the 2013 Bernard M. Gordon Prize from the U.S. National Academy of Engineering (NAE) for Innovation in Engineering and Technology Education. Recently elected to the American Academy of Arts and Sciences, he is a member of both the NAE and the National Academy of Inventors. In 2011, he received the Marlowe Award for creative and distinguished administrative leadership from the American Society for Engineering Education. Miller has served as Chair of the U.S. National Academies of Science, Engineering, and Medicine Board on Higher Education and Workforce (BHEW) and as Chair of the Engineering Advisory Committee of the U.S. National Science Foundation. He has also served on advisory boards and committees for Harvard University, Stanford University, the NAE, NAS, and the U.S. Military Academy at West Point in addition to others. In addition, he has served as a consultant to the World Bank in the establishment of new universities in developing countries. A frequent speaker on engineering education, he received the 2002 Distinguished Engineering Alumnus Award from the University of California at Davis, where he earned his B.S. He earned his S.M. from MIT and Ph.D. from the California Institute of Technology, where he received the 2014 Caltech Distinguished Alumni Award.

Contact information: Richard.Miller@olin.edu

KEYNOTE 2 - HYBRID MODELS AND UNBUNDLED PROVISION

Laura Czerniewicz, University of Cape Town, South Africa



Abstract

The unbundling of teaching and learning provision has come to the fore due to the constellation of the pandemic with its concomitant shift online, the massification of higher education, and the tenets of neoliberalism which shape much of the sector. Unbundling is the process of disaggregating educational provision into its component parts likely for delivery by multiple stakeholders, often using digital approaches and which can result in rebundling. This talk will consider:

- What unbundled provision looks like in higher education;
- Who the stakeholders are in the reconfigured teaching and learning ecosystem;
- Which forms of rebundling are emerging;
- What the implications are of the unbundled hybrid provision landscape for pedagogy, equity, and the mission of public universities.

About

Laura Czerniewicz was the first director of the Centre for Innovation in Learning and Teaching (CILT), at the University of Cape Town (UCT, 2014 to 2020), having previously led UCT's Centre for Educational Technology, OpenUCT Initiative and Multimedia Education Group. Her many roles in education over the years include academic, researcher, strategist, advocate, teacher, teacher-trainer and educational publisher. Threaded through all her work has been a focus on equity and digital inequality. These have permeated her research interests which focus on the changing nature of higher education in a post-digital society and new forms of teaching and learning provision. She plays a key strategic and scholarly role in the areas of blended /online learning as well as in open education institutionally, nationally and internationally.

Contact information: laura.czerniewicz@uct.ac.za

KEYNOTE 3 - THE FUTURE OF PBL: HOW TO MOVE FROM A ONE-SIZE-FITS-ALL COPY-PASTE APPROACH TO CUSTOMIZED PBL ALTERNATIVES?

Diana Dolmans, Maastricht University, The Netherlands



Abstract

Although current instructional design models for complex learning differ in various ways, they all focus on real-life tasks as the main vehicle for driving student learning. These tasks are derived from professionally or societally relevant problems. In problem-based learning (PBL), but also in project-based learning and cognitive apprenticeship learning, the task is at the center of learning to encourage the integration of knowledge, skills, and attitudes and to enhance transfer of learning to new problems encountered in the workplace and in real life. PBL fits well with these current instructional design principles encouraging a deep approach to learning among students. Over the years, PBL has evolved within and across institutions, demonstrating that there is no true one-size-fits-all copy-paste approach to PBL. Triggered by these new insights, the current trend is to adapt PBL and develop alternative PBL approaches, to implement PBL variations, and to re-design and investigate these new PBL alternatives. As a result, we now regard PBL as a family of approaches with certain characteristics, in which tasks are at the center of learning. The challenge is to continuously adapt and redesign PBL to ensure that all elements within the learning environment are aligned with the intended outcomes. How else can we look at PBL practice and research? What are the alternatives? What are current insights on instructional design? These issues will be discussed during the lecture.

About

Diana HJM Dolmans is a full professor in the field of innovative learning arrangements and a staff member of the School of Health Professions Education (SHE) at Maastricht University. Her research focuses on key success factors of innovative curricula within higher education. She holds an MSc degree in Educational Sciences and a PhD degree in problem-based learning. She takes a special interest in understanding how to optimize the learning

environment. Her topics of interest are problem-based learning, faculty development, and quality assurance. Her line of research within problem-based learning is internationally well acknowledged. She is the scientific director of the Interuniversity Centre for Educational Research (ICO), a research school in which 15 Dutch and Flemish universities collaborate in offering a training program to their PhD candidates in educational sciences. Finally, she is an editorial board member of several international journals, has published over 150 peer reviewed manuscripts in many refereed international journals, and she has supervised 17 PhD candidates through to completion.

Contact information: d.dolmans@maastrichtuniversity.nl



Interdisciplinary PBL and active learning





THE PARTICIPATORY CO-DESIGN OF PBL FOR ARTIFICIAL INTELLIGENCE EDUCATION IN ELEMENTARY CLASSROOMS

Kathleen Jantaraweragul, Minji Jeon, Krista Glazewski, Anne Ottenbreit-Leftwich, Cindy Hmelo-Silver, Seung Lee, Bradford Mott & James Lester

ABSTRACT

Using the context of artificial intelligence (AI), researchers from two US-based universities partnered with practicing teachers to design an elementary grade problem-based learning (PBL) AI curriculum and educational game to teach AI, computer science (CS), and life science concepts. Four educational researchers, five computer science researchers, and three teachers co-designed an engaging curriculum and educational game that leveraged immersive PBL throughout.

Given the emphasis and encouragement of utilizing inquiry-based approaches when teaching CS in the US (United States Department of Education, 2013), it is important for teachers to be involved in the design process to gain a greater understanding of content and process specific knowledge. In the presentation, we will address how suggestions made by teachers shaped our curriculum development and how our co-design process served as content-specific professional development for teachers. We will also describe the online game and offline curriculum overview in detail.

KEYWORDS: Problem-Based Learning, Computer Science Education, Artificial Intelligence, Participatory Co-Design, Curriculum Design

TYPE OF CONTRIBUTION: Practice-based abstract

PRESENTATION FORMAT: Roundtable discussion

As an applied science oriented to tackle real world problems, Computer science (CS) pairs well with inquiry-based instructional approaches and have been recommended to be used in conjunction with one another (United States Department of Education, 2013). Specifically, problem-based learning (PBL) which is characterized with components such as ill-structured problems, learner-centered pedagogy, and authentic practice, is suitable to advance computational thinking skills aimed for CS education (Caceffo et al., 2018). Therefore, we are creating a PBL immersive learning environment where students adopt the role of environmental scientists and interact with a virtual ecosystem in both online and offline curriculum. The curriculum and online game will integrate CS and artificial intelligence (AI) concepts in addition to life science concepts. While engaging with the offline AI curriculum and the online game rooted in PBL, upper elementary

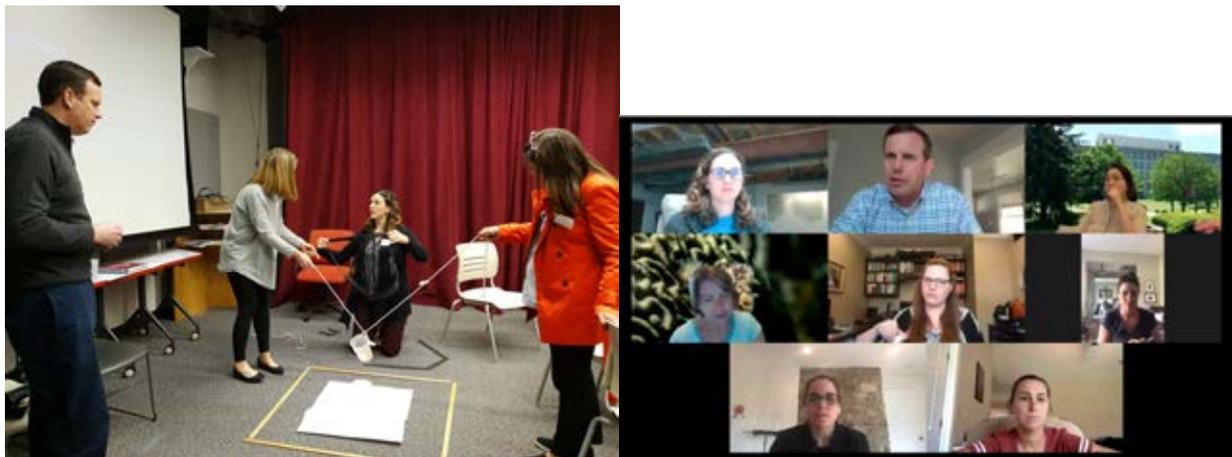


students will be guided to collaboratively find the factors causing the recent decline in the native population of yellow-eyed penguins and generate solutions to address identified causes. The research question of our study is as follows:

How can we create engaging learning experiences integrating AI and life science for upper elementary students by leveraging immersive PBL?

Through a participatory co-design curriculum development project with fourth and fifth grade teachers, researchers from two US universities partnered together to develop an AI PBL curriculum and online game. While the process is currently still ongoing, teachers and researchers began meeting in February of 2020 to learn about PBL, life-sciences, CS and AI and outline the needs of the curriculum to be developed (see Figure 1). This approach to participatory co-design (Penuel et al., 2007) allowed researchers to provide professional development to teachers to enrich their understanding of PBL, life science, CS, and AI concepts. An example of co-design sessions can be seen below in Figure 1.

Figure 1. Co-design Sessions with Teachers



Participants included three teachers with varying years of experience, each from either an urban, suburban, or rural school setting. Participants also included four researchers; one specializing in life sciences, one specializing in CS education, and two specializing in PBL.

To date there have been 16 co-design meetings with teachers. Early meetings focused on content learning as well as outlining the overall instructional goals for the curriculum. In later meetings, teachers and researchers brainstormed offline activities for the curriculum and provided practical feedback to the online game design. This allowed incorporation of more discussion opportunities and documentation practices that would enhance classroom PBL experiences for students (see Figure 2).



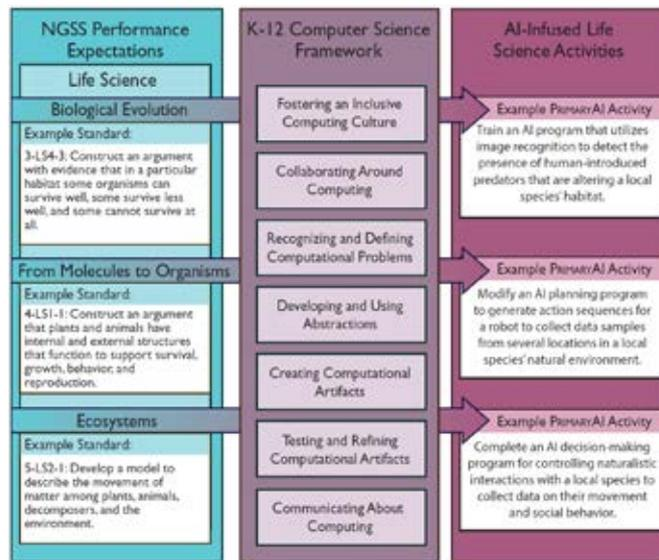
Figure 2. Online Game Interfaces



The co-design sessions have served as a platform for professional development around CS concepts, life science concepts, PBL, AI, and curriculum development (see Figure 3). We have found this method of using co-design meetings to democratically design the curriculum (Shrader et al., 2001), helpful to reduce reported teacher reluctance around teaching new concepts that are outside of their prior knowledge or comfort zone.



Figure 3. AI Curriculum Development Framework



Suggestions from teachers included specific prompts to be included in the game design signaling students to talk with partners, prompts that asked students to switch places so partners could experience gameplay, and the addition of an offline science notebook where students could take notes to document their online game decisions and make connections between online and offline learning. Teachers also co-developed the driving question for students that covered both online and offline instruction as well as generated a list of culminating activities for students to choose from after completing both offline and online learning.

The curriculum covers concepts around animal adaptation, endangered species, understanding common scientific misconceptions, AI planning problems, AI planners, AI content specific vocabulary (e.g., optimization, precondition, postcondition), AI ethics, and CS concepts. Teachers were involved in every aspect of the design process for the offline curriculum and online game development. All design decisions were made collaboratively with teacher voice being integrated and valued throughout the curriculum design process.

The offline curriculum currently consists of four offline lessons designed to introduce students to the driving question, the yellow-eyed penguins, and the problems they face as a species, animal adaptation and misconceptions, introduction to AI and its benefits, and an introduction to AI planners and AI planning problems. The decision to use the life science context of endangered species and yellow-eyed penguins was to help teachers feel more comfortable introducing students to the complex and technical content for AI. By taking concepts teachers were already familiar with, we hope to reduce barriers and cognitive load thus allowing teachers to focus on understanding AI concepts (Feldon, 2007).



The first lesson introduces students to the yellow-eyed penguin and their problems as an endangered species through videos and age-appropriate text. Students will then complete a physical activity that illustrates the complexities of their problems as an endangered species (e.g. disease, commercial fishing, injuries). The first lesson concludes with the introduction to the guiding question for the entirety of the PBL unit; what's causing the decline of the Yellow-Eyed Penguin and how can we use our knowledge of science, CS, and AI to help?

The second lesson has students participating in a discussion of misconceptions around animal adaptation that helps students frame their initial ideas about why the yellow-eyed penguin is endangered and cannot adapt to their changing environment. Students will also be introduced to a classic AI planning problem using the context of yellow-eyed penguins and a natural predator, the weasel. Through this problem, students will work with manipulatives to create a solution based on their given conditions and needs. By illustrating a simple AI planning problem to students, teachers will share examples of more complex AI planning problems to highlight why AI is helpful to humans.

The third lesson introduces students to different ways AI is currently being used to solve problems. These real-world examples of AI set the context for why AI needs to be understood for many future professions and functions in our society. Students will also engage in an AI planning problem that helps plan a family trip to the county fair. During this lesson, students will be introduced to key vocabulary including, initial state, goal state, possible actions, preconditions, postconditions, and optimization. Students will be given cards with initial states (e.g., county fair has 8 time blocks open), goal states (e.g., you filled all 8 time blocks), and possible actions (e.g., play a game, ride a roller coaster, eat cotton candy). Students will then be given cards for preconditions and postconditions. Students will work in groups to create their AI planners and will then share out their AI planners and their rationale for their choices. Students will also be given a unique AI plan based on their planner to aid in discussions on optimization and how AI machines make AI plans. At the conclusion of this lesson, students will be introduced to the online game and Quest 1.

The first online quest introduces students to the virtual world, the yellow-eyed penguins, and the problem needing to be solved (Figure 4). Students will generate an AI planner to capture photos of the yellow-eyed penguins to help the scientists on the island understand the problems the specific group of penguins is facing.



Figure 4. First Online Quest



Currently, teachers are working through the first implementation of the offline curriculum and online game play created to date. We anticipate future iterations of the Quest 1 curriculum and game will be needed before teachers and researchers can begin work on Quest 2. The team has 3 quests in total planned for the project and anticipate completion by summer 2022.

REFERENCES

Caceffo, R., Gama, G., & Azevedo, R. (2018, February). Exploring active learning approaches to computer science classes. In *Proceedings of the 49th ACM Technical Symposium on Computer Science Education* (pp. 922-927). <https://doi.org/10.1145/3159450.3159585>

Feldon, D. F. (2007). Cognitive load and classroom teaching: The double-edged sword of automaticity. *Educational Psychologist*, 42(3), 123-137. <https://doi.org/10.1080/00461520701416173>

Penuel, W. R., Roschelle, J., & Shechtman, N. (2007). Designing formative assessment software with teachers: An analysis of the co-design process. *Research and Practice in Technology Enhanced Learning*, 02(01), 51-74. <https://doi.org/10.1142/S1793206807000300>

Shrader, G., Williams, K., Lachance-Whitcomb, J., Finn, L. E., & Gomez, L. (2001). Participatory design of science curricula: The case for research for practice. In Annual Meeting of the American Educational Research Association (p. 65).

United States Department of Education: Committee on STEM Education National Science and Technology Council. (2013). *Federal science, technology, engineering, and mathematics (STEM) education 5-year strategic plan*. Washington, D.C. Retrieved from https://obamawhitehouse.archives.gov/sites/default/files/microsites/ostp/stem_stratplan_2013.pdf

AUTHOR INFORMATION

Kathleen Jantaraweragul, katemart@iu.edu, United States, Indiana University (corresponding author)



Minji Jeon, jeonmin@iu.edu, United States, Indiana University (corresponding author)

Krista Glazewski, glaze@iu.edu, United States, Indiana University (corresponding author)

Anne Ottenbreit-Leftwich, aleftwic@iu.edu, United States, Indiana University (corresponding author)

Cindy Hmelo-Silver, chmelosi@iu.edu, United States, Indiana University (corresponding author)

Seung Lee, sylee@ncsu.edu, United States, North Carolina State University (corresponding author)

Bradford Mott, bwmott@ncsu.edu, United States, North Carolina State University (corresponding author)

James Lester, lester@ncsu.edu, United States, North Carolina State University (corresponding author)



WHAT HAVE WE LEARNED? ON STUDENTS' PERCEPTIONS OF LEARNING AND PROGRESSING THROUGH PBL

Elisabeth Lauridsen Lolle & Antonia Scholkmann

ABSTRACT

In 2017 Aalborg University AAU launched a three-year cross-disciplinary project, the PBL Future project, that examines the core principles of PBL in the four subprojects, a baseline-study, curriculum-analysis and the building of scenarios. At the same time, the project explores and develop new digital approaches that opens up for new hybrid PBL learning models. The aim of Subproject 3 is to explore how students can identify the emergence of their specific PBL competences, and how this may benefit their development of a professional identity. Furthermore, it was also explored how reflective tools can trace the progression of individual competencies and how individual students can communicate these insights to different audiences, including other group members, supervisors, external (national and international) stakeholders and future employers. This paper proposes to look deeper into how the students them-selves describe their competences, and how this relates to the competence goals of their study program. The study is done through an inductive research design where students for three semesters worked with different reflective tools to identify their competences both in sessions face to face with the researchers and on-line.

KEYWORDS: Reflection, Competences, PBL competences, Digital tools

TYPE OF CONTRIBUTION: Extended scientific abstract

PRESENTATION FORMAT: Roundtable discussion

The authors have chosen not to have their full abstract published in the conference proceedings. We encourage you to look for existing or future publications by this author in other outlets.

AUTHOR INFORMATION

Elisabeth Lauridsen Lolle, elisabethll@hum.aau.dk, Department of Culture and Learning, Aalborg University (corresponding author)

Antonia Scholkmann, ansc@hum.aau.dk, Department of Culture and Learning, Aalborg University, (corresponding author)



PROBLEM/PROJECT-BASED LEARNING AND COMPUTING: AN INTEGRATED APPROACH TO TEACHING STEM

Mahnaz Moallem, Sridhar Narrayan & Gabriel Lugo

ABSTRACT

The study addresses the issue that despite attempts at integration, science, engineering, mathematics (STEM) education still exists mostly in silos, both at universities and in K-12 education. The fragmented curriculum results in students who are incapable of integrating their STEM knowledge when confronted with challenging problems in the classroom and the workplace. Thus, this two-year project that was funded by the National Science Foundation (NSF) proposed to design, develop, and offer two innovative integrated STEM programs at a mid-sized university. An undergraduate STEM teaching licensure program for students majoring in a STEM discipline and a graduate-level STEM teaching certification program for individuals who hold a STEM degree were developed. The proposed project was to emphasize the transfer of knowledge from one discipline to another, the retention of content, motivation and creativity, and an eventual increase in the number of students pursuing a teaching career in STEM disciplines. It was projected that as the graduates of these programs join STEM teaching forces, the indirect benefit of the proposed project is the production of self-reliant, technologically-literate K-12 students who are logical thinkers, problem-solvers, innovators, and inventors.

KEYWORDS: PBL and Computing; Integrate STEM Education; Innovative Approach to Preparing STEM Workforce

TYPE OF CONTRIBUTION: Extended scientific abstract

PRESENTATION FORMAT: Roundtable discussion

INTRODUCTION

The study addresses the issue that despite attempts at integration, science, engineering, mathematics (STEM) education still exists mostly in silos, both at universities and in K-12 education. The fragmented curriculum results in students who are incapable of integrating their STEM knowledge when confronted with challenging problems in the classroom and the workplace. Thus, this two-year project that was funded by the National Science Foundation (NSF) proposed to design, develop, and offer two innovative integrated STEM programs at a mid-sized university. An undergraduate STEM teaching licensure program for students majoring in a STEM discipline and a graduate-level STEM teaching certification program for individuals who hold a STEM degree were



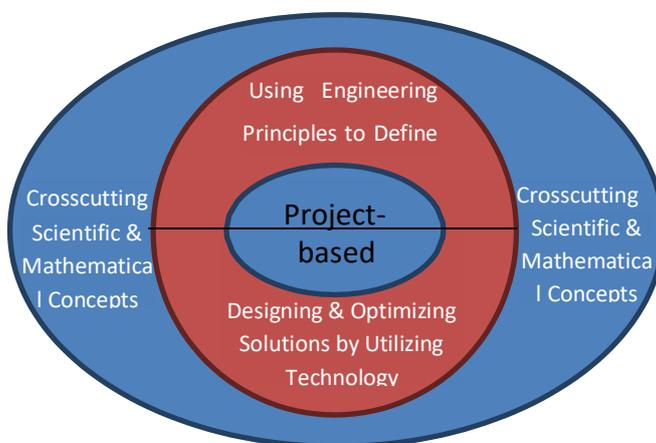
developed. The proposed project was to emphasize the transfer of knowledge from one discipline to another, the retention of content, motivation and creativity, and an eventual increase in the number of students pursuing a teaching career in STEM disciplines. It was projected that as the graduates of these programs join STEM teaching forces, the indirect benefit of the proposed project is the production of self-reliant, technologically-literate K-12 students who are logical thinkers, problem-solvers, innovators, and inventors.

THE CONCEPTUAL FRAMEWORK

The conceptual structure of designing the integrated programs were consistent with the framework released by the 2013 National Research Council (NRC) for K–12 Science Education to guide the development of the *Next Generation Science Standards (NGSS, 2013)*, the development of engineering academic standards in K-12 education (National Academy of Engineering, 2010, 2014), and Project-based Learning (PjBL) as the best teaching approach and instructional strategy (e.g., Capraro, Capraro, & Morgan, 2013). The NRC’s framework and standards for K–12 engineering education were aligned with the need for integrated STEM, not only in K-12 education but also in teacher preparation programs. According to NRC’s framework, science is organized into three dimensions: (1) Scientific and Engineering Practices, (2) Crosscutting Concepts, and (3) Disciplinary Core Ideas. The Scientific and Engineering Practices capture what scientists and engineers do, while Crosscutting Concepts convey how scientists and engineers view the world (e.g., patterns, cause, and effect). Disciplinary Core Ideas represent traditionally held science content understandings (Barakos, Lujan, Strang, 2012). The framework envisioned science as exposing students repeatedly to all three of these dimensions in an integrated fashion. The framework further focused on significantly fewer big ideas that students should understand by the end of grade 12. It arranged concepts as developmentally sound progressions of learning that lead to an understanding of those few big ideas (NGSS, 2013). The developed programs, using the framework, were aligned with the integrative approaches that teachers are expected to use to teach their students. It should be acknowledged that this task was challenging but through a project-based STEM curriculum focused on critical thinking, problem-solving, and collaboration, the new programs could train effective teachers who can prepare students to enter the workforce. See Figure 1 for a visual representation of the framework.



Figure 1: Conceptual Design Framework



METHODS

We designed a mixed-methods data collection strategy to monitor and document the design and development of the programs. Multiple sources of data such as observation, focus groups, interviews, document analysis, surveys were used to gather data.

RESULTS

The results of the first year of project implementation were needs analysis, organizing and conducting summer seminar to bring members of various stakeholders and experts together to assist the multidisciplinary, collaborative team of 15 STEM and STEM education faculty. The team conceptualized the design of the two new programs, drafted two new integrated programs to increase teacher workforce in STEM with specific emphasis on the integration of STEM disciplines and disseminated drafts of the programs to external and internal stakeholder and advisory board members. The second-year dissemination plan was focused on communicating the revised programs’ proposals with internal and external auditing groups as well as teacher education communities. Additionally, the two innovative programs were approved and made ready for implementation, followed by the development of several promotional materials and conducting an informational conference for the community.

CONCLUSIONS

The integrated approach to teaching and learning STEM content emphasizes the concept of interconnectedness among STEM disciplines by offering learning opportunities that demonstrate how disciplines interact and reinforce one another (i.e., integrates content from two or more disciplines such as biology, chemistry, physics, engineering, computer science, mathematics, environmental, earth sciences) and fostering scientific thinking



with approaches such as modeling, experimentation, simulation, optimization, computation, and invention. Two new programs were proposed for teacher preparation. A framework and a set of design principles in conjunction with the state and national standards for teacher preparation were used to design and develop both an undergraduate Integrated STEM teacher licensure program and a post-graduate certificate program for mid-career STEM professionals. In sum, as a result of this project and the continued work in this area, we have come to believe that although educators know of the importance of integrated STEM education, most need training in understanding what STEM education should be and how they should bridge the lines between disciplines.

REFERENCES

National Academy of Engineering (2010). *Standards for K-12 Engineering Education?* Washington, DC: The National Academies Press.

National Academy of Engineering and National Research Council (2014). *STEM Integration in K-12 Education: Status, Prospects, and an Agenda for Research*. Washington, DC: The National Academies Press.

National Academy of Engineering and National Research Council (2009). *Engineering in K-12 Education: Understanding the Status and Improving the Prospects*. Washington, DC: The National Academies Press.

National Research Council. (2011). *Successful K–12 STEM education: Identifying effective approaches in science, technology, engineering, and mathematics*. Washington, DC: The National Academies Press.

National Research Council. (2012). *A framework for K–12 science education: Practices, crosscutting concepts, and core ideas*. Washington, DC: The National Academies Press.

NGSS (Public Release II) (2013). Next Generation Science Standards: Standards for engineering, technology, and the applications of science—Appendix A: Conceptual Shifts in the Next Generation Science Standards - FINAL. Retrieved from [<http://www.nextgenscience.org/>] March 2013.

AUTHOR INFORMATION

Mahnaz Moallem, mmoallem@towson.edu, United States, Towson University (corresponding author)

Sridhar Narrayan, narrayans@uncw.edu, United States, University of North Carolina Wilmington (corresponding author)

Gabriel Lugo, lugo@uncw.edu, United States, University of North Carolina Wilmington (corresponding author)



THE FIRST SEMESTER AT CODE: PREPARING STUDENTS FOR PROJECT-BASED LEARNING IN A CURIOSITY-DRIVEN HIGHER EDUCATION LEARNING ENVIRONMENT

Barbara Iverson, Martin Knobel, Eva-Maria Lindig & Adam Roe

ABSTRACT

CODE University of Applied Sciences is designed around the competencies of 21st century skills with the vision of training digital pioneers. Students at CODE pursue a bachelor's degree designed around the key ideas of Project-Based Learning and Curiosity-Driven Education. The first year of studies at CODE provides certain academic structures, while encouraging curiosity and laying the groundwork for a highly self-driven study model. Following feedback from students and faculty, the goals of the first semester on campus were reconsidered, and the semester has been recently redesigned. A scaffolded approach was introduced, one which consists of two key parts: a workshop phase, which focuses on building knowledge and skills in the three fields of study, and a project-only phase, in which students work on their own, and check in regularly with faculty and advanced students for input, feedback and guidance. This contribution will focus on the first semester of studies at CODE, and the ways in which it prepares students for subsequent semesters, in which students work on semester-long projects, either alone or in interdisciplinary groups.

KEYWORDS: Interdisciplinary Project-Based learning, Curiosity-Driven Education, Active Learning, Higher Education, Lifelong Learning

TYPE OF CONTRIBUTION: Practice-based abstract

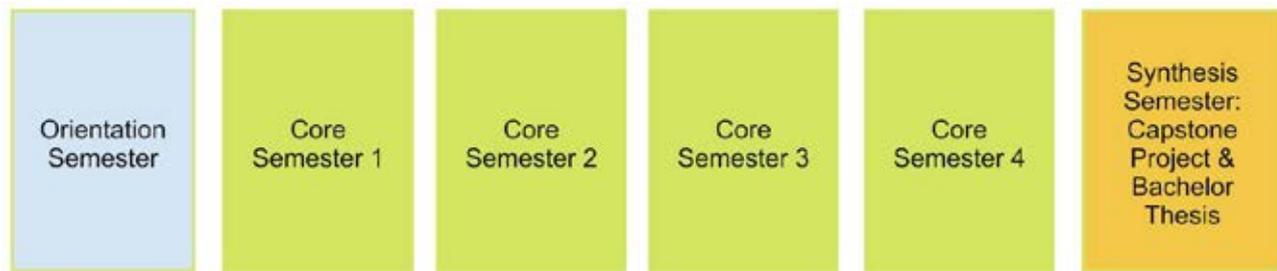
PRESENTATION FORMAT: Roundtable discussion

INTRODUCTION: THE WHAT AND WHY OF CODE UNIVERSITY OF APPLIED SCIENCES

CODE University of Applied Sciences is designed around the competencies of 21st century skills with the vision of training digital pioneers (AACU, 2007). Students at CODE may pursue a Bachelor's degree in Interaction Design, Product Management, or Software Engineering, and all students participate in a core liberal arts program, known as "Science, Technology, and Society," and the Interpersonal Skills program. The curricula at CODE are designed around the key ideas of Project-Based Learning and Curiosity-Driven Education (Dewey, 1938). CODE focuses on personal growth, interpersonal skills, the ability to make good judgements, and real-world learning.



Figure 1: Structure of the 3-year bachelor's degree at CODE



Each semester, students work on a semester-long project, either alone or in an interdisciplinary group. The project type and content of the semester-long projects are defined by students themselves, by faculty, or by partner organizations. Project types may be focusing on a market-ready product, learning specific technologies, or research. CODE faculty work together with industry experts from partner organizations, to design learning environments which enable project-based learning, peer-learning environments, and foster self-directed learning.

Students entering CODE represent a deeply heterogeneous background in terms of skills, previous education, age, and culture. By the end of their studies, CODE students are expected to continue to learn their life long, have a basic understanding of scientific practice, be able to work on teams, make good judgements, and be able to practice their field of study in a professional environment. The design of the first year of studies at CODE provides certain structures, while encouraging curiosity and laying the groundwork for a highly self-driven study model. This abstract will focus on the first semester of studies at CODE, the orientation semester.

THE ORIENTATION SEMESTER

The previous class of first-year students encountered a hectic first semester, which consisted of three short team projects of four weeks each, in which each student would take on an assigned role corresponding to the three study programs for duration of that project, before switching to the next project, team, and role. Students were not given detailed overviews of the expectations of each role in a project, but were encouraged to learn with and from their peers in weekly meetings with other students in the same role. This accomplished an introduction by fire into the responsibilities and mindsets of each of the three roles, where students discovered what it looks like to approach a project from each of the three perspectives. However, this structure also created a mountain of stress and frustration in students unprepared for intense teamwork, the constant pressure of finding a new project idea, and working with low input and support in an unfamiliar role.

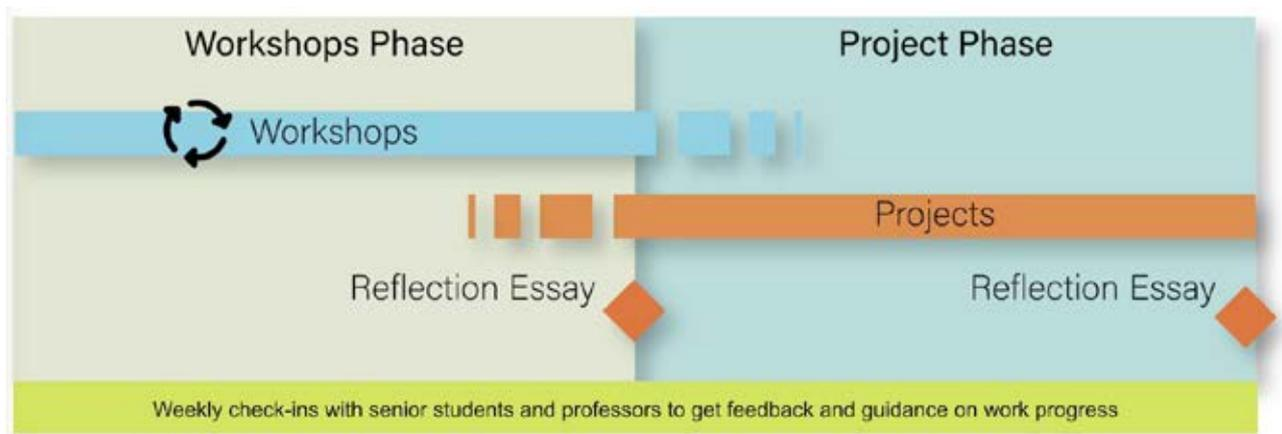


After receiving feedback from both students and faculty, the decision was made to re-think the goals for the Orientation Semester. In a co-creation session with faculty members and student representatives, the following core goals were defined:

- Begin to learn how to learn (in this environment)
- Gain an overview of the competencies expected of a CODE student
- Harness a working knowledge of the basic skills of each of the fields of study at CODE
- Begin to find their place in the CODE community
- Learn a number of essential soft skills
- Prepare their core studies

Based on this, a more scaffolded approach of two key parts, a workshop phase and a project-only phase, was designed. During the first seven weeks of this re-worked semester, students are encouraged to visit classes offered by each of the three study programs. These classes are intended to contribute to the goals of gaining an overview of the competencies of the field and gaining a working knowledge of the basic skills in specific areas of the field which are necessary in order to begin on a project. Heavily practice-based, the courses are designed around problem-based learning and other active learning techniques (Bonwell, C. C., & Eison, 1991).

Figure 2: Structure of the newly designed 2019 Orientation Semester



A core tension in the model arises during this period: Students are expected to challenge themselves to learn about fields they are not yet aware of and perhaps not interested in—a key element in CODE’s curiosity-driven education approach—while not being *required* to attend any of these classes, in order to prevent the stifling effects of obligatory attendance. The onus is therefore on the student to challenge themselves. In particular for younger students, those who are familiar with more traditional educational environments, and



those who do not yet understand enough of a field to comprehend where their knowledge and ability lies with respect to the course offerings, these decisions are quite difficult. Mechanisms to increase feedback, such as personal guidance, are being prototyped, but are often extremely time-intensive for the faculty.

The second phase of the orientation semester is focused solely on the creation of an interdisciplinary project. Each student is expected to create their own project, enact and apply the learnings from the three different disciplines, and document their learning journey. During this period, classes are not offered by the three study departments, but students meet in groups with faculty members and advanced students of all study programs in order to get feedback on their work and continue learning. Students are expected to show a commitment to interdisciplinarity during this period, but are not yet expected to demonstrate any degree of mastery in the fields at this stage. The emphasis for students is to embrace and focus on the learning process, including failure, rather than to complete the semester with concrete output. This period culminates with a campus-wide exposition at the end of the semester, marking the end of the orientation semester. This phase contributes heavily to the goals of preparing a student for their core studies, which focuses on project-based learning.

To accomplish the stated goals of integrating into the CODE community, learning how to learn in this very free environment, and developing the use of soft skills, the Interpersonal Skills department requires OS students to take part in three workshops offered multiple times throughout the semester. The “Basics” workshop is the most content-heavy of the workshops, offering students insights into mindsets, team development stages, and cultural mapping (Dweck, 2017; Meyer, 2015; Tuckman, 1965). The “Time Management” workshop challenges students to define their priorities, and then consider tools that could assist them through a variety of well-established methods, (Doran, 1981; Duhigg, 2012). The “How not to be an A\$@hole” workshop is the most discussion-heavy of the three, in which students are given real-life situations and discuss whether they find the behavior to be rude, inappropriate, and unprofessional or not. Many students express surprise at the variety of opinions and thoughts on the behaviors, realizing that not everyone thinks as they do.

OUTLOOK: FORMALIZING THE FIRST SEMESTER

Following the generally successful implementation of the orientation semester in 2019 as described above, those responsible for it—the authors of this submission—are looking toward fine-tuning the existing system. One key question remains how to create the spark of interest in fields other than that of intended study, especially for those who are advanced in their intended field of study, relatively speaking. As the spring semester draws to a close, we will be able to better evaluate if the orientation semester did indeed prepare students well for joining project teams, and, if not, how students can be better supported in their first



semester to prepare in that regard for their second semester. The faculties are also working on defining baseline expectations for skill levels in specific topics expected by the end of the first year of studies for students in their own study programs, allowing for students to orient their own learning goals.

REFERENCES

- Association of American Colleges and Universities. (2007). *College Learning for the New Global Century*. Washington, D.C.: AACU
- Bonwell, C. C., & Eison, J. A. (1991). *Active Learning: Creating Excitement in the Classroom*. Washington, DC: George Washington University, ERIC Clearinghouse on Higher Education.
- Dewey, J. (1938). *Experience & Education*. New York, NY: Kappa Delta Pi
- Doran, G. T. (1981). There's a S.M.A.R.T. Way to Write Management's Goals and Objectives. *Management Review*, 70 (11), 35–36.
- Duhigg, C. (2012). *The Power of Habit: Why we do what we do in life and business*. New York: Random House.
- Dweck, C.S. (2017). *mindset: Changing the way you think to fulfil your potential*. London: Robinson
- Kruger, J., & Dunning, D. (1999). Unskilled and Unaware of It: How Difficulties in Recognizing One's Own Incompetence Lead to Inflated Self-Assessments. *Journal of Personality and Social Psychology*, 77(6), 1121–1134.
- Meyer, E. (2015). *The Culture Map: Decoding how People Think, Lead, and Get Things Done Across Cultures*. New York: Public Affairs
- Tuckman, B. W. (1965). Developmental sequence in small groups. *Psychological Bulletin*, 63(6), 384–399.

AUTHOR INFORMATION

Barbara Iverson, barb.iverson@code.berlin, Germany, CODE University of Applied Sciences

Martin Knobel, martin.knobel@code.berlin, Germany, CODE University of Applied Sciences

Eva-Maria Lindig, eva.lindig@code.berlin, Germany, CODE University of Applied Sciences

Adam Roe, adam.roe@code.berlin, Germany, CODE University of Applied Sciences (corresponding author)



INTEGRATING PBL IN SERVICE LEARNING: A HYBRID APPROACH FOR 21ST CENTURY LEARNING

Vishalache Balakrishnan

ABSTRACT

Problem Based Learning (PBL) has been part of a learning pedagogy in most universities around the globe. Malaysian universities have also been encouraging lecturers in all fields to utilise PBL as one of their activities. In my application of PBL, I went one step further by marrying both PBL and Service Learning in one of the courses for undergraduate students in the Faculty of Education. Service Learning Malaysia-University for Society (SULAM) is an innovative idea to bring higher education students towards society and help improve their life in every aspect. In the words of National Service Clearinghouse, Service Learning is a strategy that integrates meaningful community service with instruction and reflection to enrich the learning experience, teach civic responsibility and strengthen communities. In this presentation I will narrate how PBL comes as a natural activity in the Service Learning process. The experiential education where learning occurs through a cycle of action and reflections as students work with others through a process of applying PBL when issues exist in the pre, while and post of the entire Service Learning programme.

KEYWORDS: service learning, problem based learning, 21st century learning

TYPE OF CONTRIBUTION: Practice based abstract

PRESENTATION FORMAT: Roundtable discussion

The author has chosen not to have their full paper published in the conference proceedings. We encourage you to look for existing or future publications by this author in other outlets.

AUTHOR INFORMATION

Vishalache Balakrishnan, visha@um.edu.my, Malaysia, Universiti Malaya (corresponding author)



TEACHING ENTREPRENEURSHIP AT UNIVERSITIES OF TECHNOLOGY BY USING A NOVEL PEDAGOGIC APPROACH

Elvina Smith & Ryk Lues

ABSTRACT

South Africa, 25 years post-apartheid, is being challenged by unemployment, poor economic growth, political and educational instability. The unemployment figures have reached an all-time high percentage above 29%. Students at Universities of Technology have been ineffectively exposed to the concept and practices of student-centred learning as a tool towards solving real life challenges and entrepreneurial understanding. As South Africa has a unique economic structure in terms of financial and labour challenges, it is suggested that the South African education sphere embark on a tailor-made entrepreneurship education model. The aim of the study was to combine problem-based learning (PBL) and knowledge-based learning (KBL) as teaching methodologies in the design of a novel challenge-oriented teaching and learning methodology (COL) for the training of entrepreneurs at Universities of Technology. COL combines the “pillars” of PBL and “KBL” to identify, address and solve real life challenges with entrepreneurial thinking. In the COL model, the specific outcome of the pedagogic process leads the student from existing knowledge, through outcome requirement, to identifying new or inherent challenges, and finally to sourcing or researching how this challenge may be addressed or resolved. Concomitantly, knowledge deepens and widens as students build new experiences and information on existing knowledge and, by so doing, they familiarise themselves with the context and content of the challenge. The stimulus for learning or acquiring new knowledge is therefore driven by the challenge and initiated by existing knowledge. The real-world challenges are incentives and the conduit for the learning process.

KEYWORDS: PBL, challenge oriented learning, unemployment, entrepreneurship

TYPE OF CONTRIBUTION: Practice-based abstract

PRESENTATION FORMAT: Roundtable discussion

INTRODUCTION

South Africa, 25 years post-apartheid, is being challenged by unemployment, poor economic growth, political and educational instability. The unemployment figures have reached an all-time high percentage above 29% (Trading Economics, 2019). In addition to this employment opportunities will remain limited for graduates due to inadequate workplace (cognitive, soft) and entrepreneurial skills (Sutton, 2016). Students at



Universities of Technology have been ineffectively exposed to the concept and practices of student-centred learning as a tool towards solving real life challenges and entrepreneurial understanding. As South Africa has a unique economic structure in terms of financial and labour challenges, it is suggested that the South African education sphere embark on a tailor-made entrepreneurship education model. A generic model that is purely inspired and influenced by global guidelines and specifically Western world economies might not be the sole solution to South Africa's socio-economic and financial challenges, particularly as this country is embedded in the African context. For this reason, an entrepreneurship education model that incorporates both Afrocentric and Eurocentric approaches is deemed most likely to precipitate the desired economic gains. Although current entrepreneurship learning is limited to business and the study of economics, it should, to be effective, not be packaged and limited to a certain field of study or pedagogic discipline. This thinking implies that future entrepreneurs may be found within any field of study where a student is trained or coached in how to recognise a need, a shortcoming and/or societal or communal challenges (Diphoko 2017).

Thus far, the most widely used teaching methodology for entrepreneurship education has been the traditional lecturing method combined with a research component (Hay, 2008; Meguid & Collins, 2017). Problem-based learning (PBL) is offered as an alternative to lecturing and is a student-centred teaching and learning methodology. It has roots in the constructivist epistemology, or study of knowledge. The objective is to challenge students with problems experienced in practice, and to allow them to view these issues as stimuli for learning and organisation of what has been learned. The body of knowledge and new understanding may later be recalled and applied to future work (Barrows, 1996). Students receive and interpret new knowledge in the context of their own knowledge and experiences. They subsequently construct meaning in relation to their needs, backgrounds and interests (Jonassen, 1992). For this reason, it is suggested that students should build on an existing reality and on their prior knowledge base. The creation of a new reality is a constructivist way of developing and acquiring new knowledge and understanding. This pedagogic approach is known as knowledge-based learning (KBL). Through this process, students become the best evaluators of the construction of new knowledge while the facilitator is the guide and scaffolder, as it is done for PBL. Contemporary, responsive models on PBL and KBL do not effectively address the predicaments that universities of technology face, and therefore a novel model is needed to provide solutions for the pedagogy of entrepreneurship and cognitive and soft skills.

AIM

To utilise problem-based learning (PBL) and knowledge-based learning (KBL) as teaching methodologies in the creation of a novel challenge-oriented teaching and learning methodology for the training of entrepreneurs at universities of Technology.

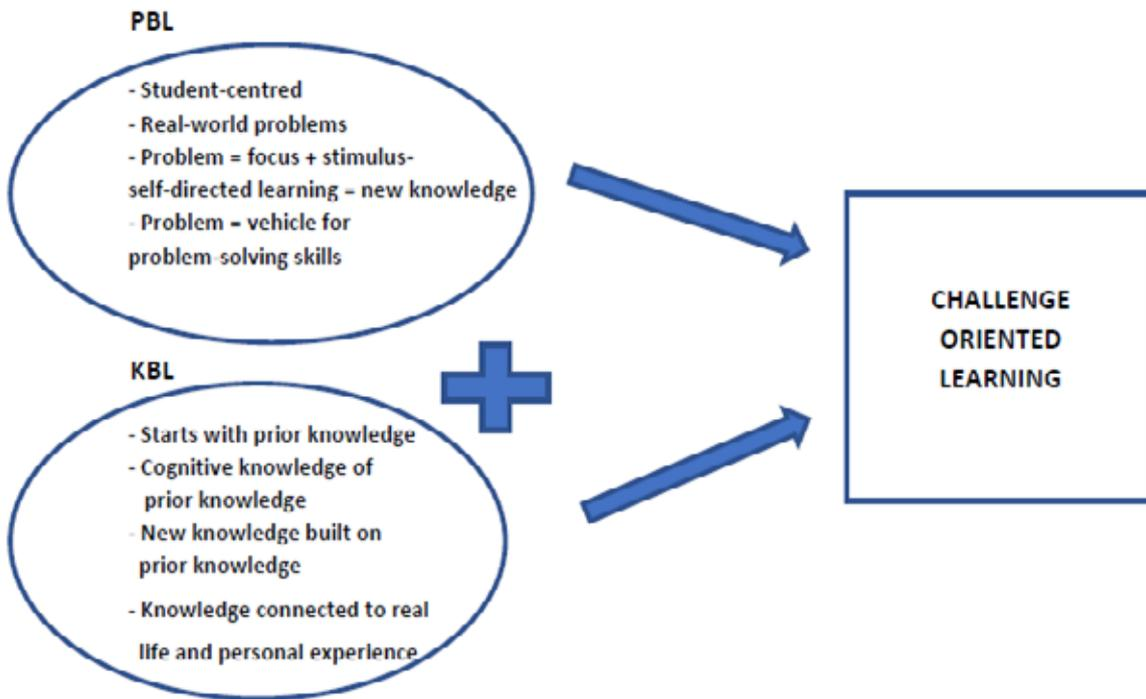


THE DESIGN METHOD OF CHALLENGE ORIENTED LEARNING

Challenge-oriented learning (COL) is an active student-centred pedagogy that allows students to build on previous knowledge, experience and understanding in order to learn about a subject through the process of solving open-ended, real-life challenges as triggers. COL is focused on students' reflection and reasoning to construct their own learning. COL combines the "pillars" of PBL and "KBL" to identify, address and solve real life problems with entrepreneurial thinking. PBL, the learning process may be described as active learning, which focuses on intricate real-world problems where the problems represent a vehicle through which the student learns concepts and principles. It rests on 5 pillars as shown in Figure 1. The emphasis of this method of learning is active participation in the learning process, development of problem-solving abilities, and the acquisition of critical thinking skills (Smits *et. al*, 2003). KBL is centred around the knowledge that students already have and incorporates new knowledge and understanding that they acquire during the learning process. In this model, learning is therefore built on existing knowledge combined with new knowledge, and the learning process exhibits a close connection with real life (Dowd *et. al.*, 2019). A curriculum based on this learning and teaching methodology favours knowledge acquisition instead of skills acquisition only. To this effect, it is noteworthy that knowledge acquisition and skills acquisition are not necessarily mutually exclusive, and it has been shown that it is challenging to teach skills without knowledge of the context and content associated with the skill. A responsible way to transfer knowledge and skills is therefore to teach content in a manner that teaches skills, too (Dasgupta, 2016). The transfer of knowledge does not happen after an educational intervention, but the process elicits existing knowledge. The pillars of and synopsis of this methodology is presented in Figure 1.



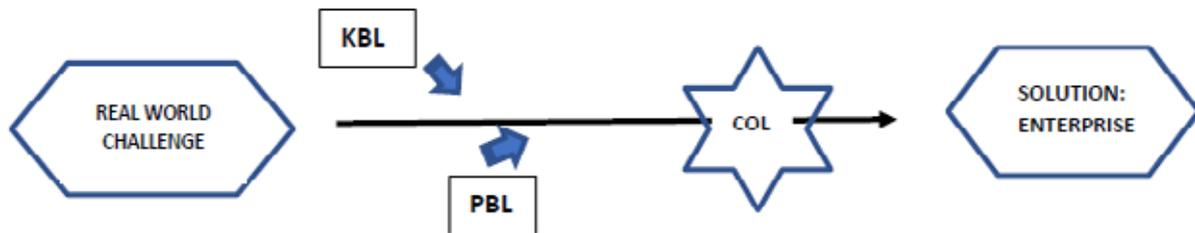
Figure 1: A schematic representation of the combination of problem-based learning (PBL) and knowledge-based learning (KBL) to yield challenge-oriented learning (COL).



In the COL model, the specific outcome of the pedagogic process leads the student from existing knowledge, through outcome requirement, to identifying new or inherent challenges, and finally to sourcing or researching how this challenge may be addressed or resolved. Concomitantly, knowledge deepens and widens as students build new experiences and information on existing knowledge and, by so doing, they familiarise themselves with the context and content of the challenge. The stimulus for learning or acquiring new knowledge is therefore driven by the challenge and initiated by existing knowledge as shown in Figure 2. The pedagogic process is self-directed and embedded in a real-world challenge, as opposed to being directed or delivered by the lecturer. The way COL is managed (self-directed and group learning) lends itself to creativity, critical thinking, collaboration, and the acquisition of much needed communication skills. The students' curiosity is triggered, and self-confidence and courage are developed. By means of scaffolding and 'side-line' facilitation, the challenge is unpacked, and thereby the development of problem-solving skills and critical thinking is nurtured (Smits *et al.*, 2003). These are the desired skills for graduates entering industry, and even more so for those having an entrepreneurial intent.



Figure 2: A diagrammatic representation of developing entrepreneurial Skills through Challenge oriented learning.



DISCUSSION

The salient needs for a holistic pedagogic approach were used as a guide for the design of the alternative teaching methodology. Various aspects of what will be required of the graduate or new entrepreneur were considered as the benchmarks for the methodology. This new methodology is embedded in a student-centred and knowledge-based approach to teaching. The crucial parameters are: real-life challenges led by and precipitated by the any subject content and outcomes; the learning process that is active and centred around the student; existing knowledge being recognised and used as an initial building block; allowing students to develop skills such as problem-solving, critical thinking, communication, collaboration and public speaking; assuring that formative and summative assessments are not the primary means of assessment or monitoring of progress; maintaining a flow-through of information and learning to ensure that units and outcomes are not dealt with mutually exclusively, and that they incorporate students' experiences. In this model, real-world challenges are incentives and the conduit for the learning process.

REFERENCES

- Barrows, H. S. (1996). Problem-based learning in medicine and beyond: A brief overview. *New directions for teaching and learning*, 1996(68), 3-12.
- Dasgupta, J. (2016). *Knowledge-based learning versus skills-based learning*. (<https://www.linkedin.com/pulse/knowledge-based-learning-vs-skill-jayanti-dasgupta/>)
- Diphoko, W. (2017). *Township Economy Report: It's time to recognise Township Economy*. (<https://www.iol.co.za/business-report/townshipeconomyreport-its-time-to-recognise-township-economy-10286926>)
- Hay, H. R. (2008). If walls could speak: reflections from visiting a South African higher education classroom: editorial: SAJHE Heltasa Conference. *South African Journal of Higher Education*, 22(1), 935-947.



Jonassen, D. H. (1992). Evaluating Constructivist Learning., In T. Duffy & D. H. Jonassen (Eds.) *Constructivism and the Technology of Instruction*. (pp. 137-148). Mahwah, NJ: Lawrence Erlbaum Associates.

Meguid, E. A., & Collins, M. (2017). Students' perceptions of lecturing approaches: traditional versus interactive teaching. *Advances in medical education and practice*, 8, 229.

Smits, P. B., D de Buissonjé, C., Verbeek, J. H., van Dijk, F. J., Metz, J. C., & Cate, O. J. T. (2003). Problem-based learning versus lecture-based learning in postgraduate medical education. *Scandinavian journal of work, environment & health*, 280-287.

Sutton, B. Z. (2016). Higher education's public purpose. *Retrieved August, 6, 2018*. Trading Economics, 2019. (<https://tradingeconomics.com/south-africa/unemployment-rate>) Accessed on 6 July 2019.

AUTHOR INFORMATION

Elvina Smith, esmith@cut.ac.za, South Africa, Central University of Technology (corresponding author)

Ryk Lues, rlues@cut.ac.za, South Africa, Central University of Technology



PRACTICE-BASED STUDY: IMPLEMENTATION OF A MULTIDISCIPLINARY PBL APPROACH IN A DESIGN AND MANUFACTURE OF AN UAV IN AEROSPACE ENGINEERING BACHELOR'S DEGREE

María José Terrón-López, José Omar Martínez-Lucci & Víctor Manuel Padrón-Nápoles

ABSTRACT

This paper describes a Project Based Learning (PBL) called “UE-UAV. Design and manufacture of a UAV”, which covers a set of interlinked subjects, those effectively help students to integrate their knowledge and explore the relationships between these subjects in the development of an aircraft. UE-UAV is developed during the third academic year of Aerospace engineering Degree. It addresses three technical subjects (Fluid mechanics II, Aerodynamics and Aeroelasticity, and Graphic and Mechanic Design), one project management related subject (“Managerial Skills”) and it is complemented with a non-formal learning activity, the “Workshop on Drones” closely related to “Air Division” students club.

PBL is a powerful teaching methodology that allows increase students’ motivation, learning effort and performance. However, PBL pedagogical features can be negatively affected during the development of complex projects, similar to the problems faced in the engineer professional life. To prevent it, this type of projects requires a multilateral approach that, not only, includes student learning and applying of previous knowledge, technical development of subsystems and their test and validation, but also, fair assessment of individuals and teams’ performance, an effective project management and fostering of communication skills. Another key aspect for effectively carrying out a project is a careful planning, which include a set of milestones that define the roadmap for the development and an effective risk assessing methodologies. In addition the activity of “Workshop on Drones” creates an opportunity to combine formal and informal learning, increasing involvement, motivation and collaboration with all engineering students interested in developing of aircraft.

KEYWORDS: UAV, SCRUM methodology, fair assessment, project management, informal learning.

TYPE OF CONTRIBUTION: Practice based abstract

PRESENTATION FORMAT: Roundtable discussion



INTRODUCTION

Critical thinking is an important part in education at different stages of students' learning this is why instructors focus their teaching methodologies on this characteristic. PBL is an effective mode to develop this skill. This paper describes the PBL developed "UE-UAV. Design and manufacture of an UAV". It was addressed to third-year aerospace engineering students. It covers a set of 6 ECTS subjects, to help students to integrate knowledge and explore the relationships in the development of an aircraft. It addresses three technical courses, one project management related subject and, it's complemented with a non-formal learning activity (Figure 1).

Figure 1: PBL Organization



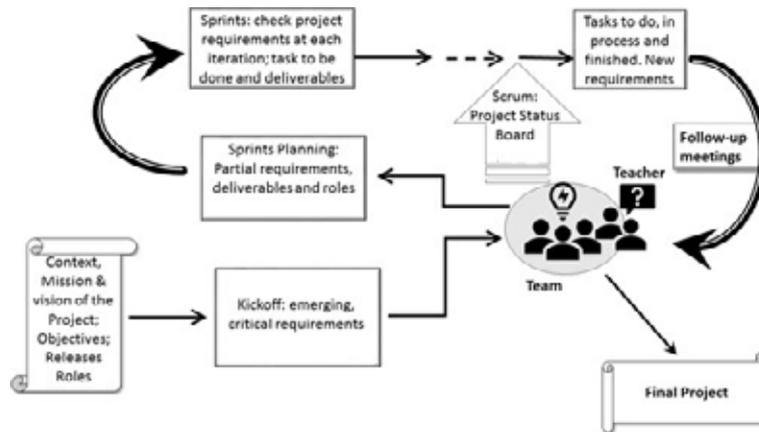
The objective is that students realize the importance that management has in their engineering education, integrating non-formal activities in their curricula. Thus, they become aware of the need to allocate time and human resources for the manufacturing, testing, and elaboration of documentation and the diffusion of their results which include a set of milestones that define the roadmap for the development and an effective risk assessing methodologies. This is an opportunity to combine formal and informal learning, increasing involvement, motivation and collaboration with all engineering students interested in developing aircrafts.

FRAMEWORK

The PBL implies working effectively in teams. It means that they must define goals, responsibilities, tasks and plan carefully. To do so, Agile methodologies are followed, in particular SCRUM methodology (Terrón-López, Blanco-Archilla, & Velasco-Quintana, 2020) (Schwaber & Sutherland, 2017) and a continuous feedback is given during the project development (Figure 2).



Figure 2. Follow-up PBL methodology (Terrón-López et al., 2020)



The project presented to the students has the following objectives:

- Design of an Unmanned Aerial Vehicle (UAV), by applying theoretical and software analysis to the subsystems of aerodynamics, structure, flight mechanics, mechanic and graphic design.
- Manufacture of the UAV model to be tested in wind tunnel and flown outdoors. The aims of the payload are mapping the ground elevation and measuring the flight altitude.

These are distributed among subjects as shown in Table 1.

Table 1 Objectives of each subject

“Fluid Mechanics II”.	“Managerial Skills”.
<ol style="list-style-type: none"> 1. Conceptual design of the UAV. 2. Preliminary design of an airfoil. 3. Determine the aerodynamics characteristics of the airfoil using a commercial CFD software, in this phase of the project the software must be Ansys-Fluent. 	<ol style="list-style-type: none"> 1. Establish the Mission. 2. Set the specific objectives of the conceptual of the design 3. Set the specific objectives of the preliminary design of the airfoil 4. Define tasks, roles of the teams’ members 5. Set detailed planning for the project
“Aerodynamics and Aeroelasticity”.	“Graphic and Mechanic Design”.
<ol style="list-style-type: none"> 1. Compare the result of CFD with that of the theory of thin airfoil. 2. Perform the preliminary design of the wing. 3. Compare the simulation result of the wing applying a commercial CFD software with that of the theory of wing. 	<ol style="list-style-type: none"> 1. Preliminary mechanic design of the complete UAV by applying CATIA software 2. Simplified Nastran/Patran model and analysis of UAV structure 3. Manufacturing and structural analysis of UAV and its components

Some specifications of the UAV are also given.



The optative activity “Workshop of Drones” plays a peculiar role in UE-UAV project. This activity is designed to teach students the use of Autopilots and Ground Stations to allow them to measure aircraft parameters during the test flights and to control and design specific missions and applications.

STAGES OF THE PROJECT

The project has two stages, corresponding to both semesters. In the first semester they obtain a conceptual design and in the second the preliminary and, if possible, the manufacture of the UAV.

In both semesters they must deliver:

- Minutes of meetings including action items, person in charge, due dates, etc.
- Weekly progress report
- Final Oral presentation
- Final report of this stage

First stage

During the first semester, they have delivered the following:

- Documentation including conceptual design of the UAV and the rationale behind this design.
- Report with the following aspects considered:
 - Comparison of airfoils using XFRL5 or XFOIL software
 - Reasons of airfoil selection
 - Aspects of airfoil:
 - Presentation of aerodynamic characteristics
 - Geometric characteristics of airfoils
 - Airfoil nomenclature/designation
 - Choice of airfoil camber
 - Choice of airfoil thickness ratio
- Conceptual design of the UAV

Second stage

During the second semester, students will ask to deliver:

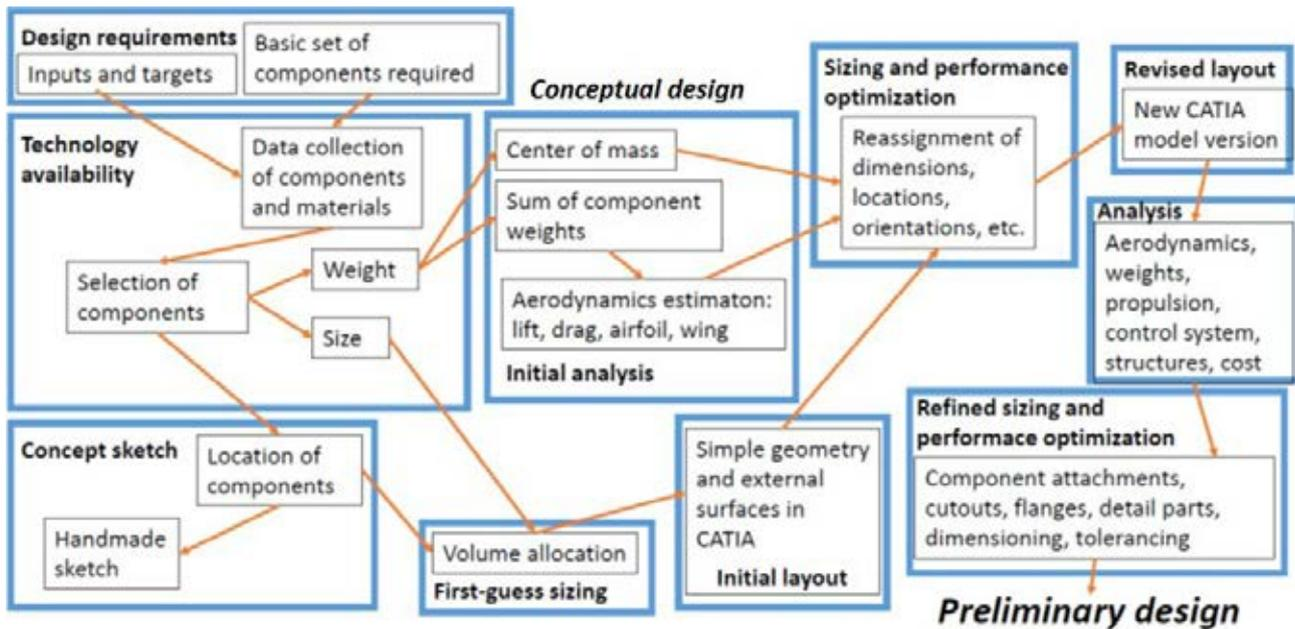
- Preliminary design following the scheme of Figure 3.
- Breakdown of subsystems, tasks and responsible
- List of materials
- Report of design budget costs
- CATIA v5 files



Final preliminary design report including:

- Introduction
- Concept design
- Description of preliminary design
- Mechanical analysis
- Graphic model
- Manufacturing description
- Conclusions, modifications and improvements
- Annexes: List of materials and part assignment; Node numbering and naming breakdown of graphic model; Engineering drawing of UAV model. General and detail views. Dimensioning and tolerancing; Pictures of available components that can be included on power and control subsystems of UAV

Figure 3. Phases of the development of the project.



Assessment

Each teacher will assess the corresponding part of the project using rubrics for peer and self-assessment (Terrón-López, Blanco-Archilla, & Velasco-Quintana, 2020). Final grade in each subject will be weighted as following:

- Final report: 70%
- Intermediate documents: 10%



- Final presentation: 20%
- Manufacturing of the UAV and test in wind tunnel: 1 extra point.
- Open air tests: take-off and crash = 0.5 extra points; take-off and land = 1 extra point

STUDENTS ROADMAP OF THE FIRST STAGE OF PROJECT DEVELOPMENT

A set of milestones was defined by each team during this stage creating a roadmap with the risks found for each of the goals they wanted to achieve (Figure 4) and Table 2.

Figure 4. Roadmap of the development with milestones

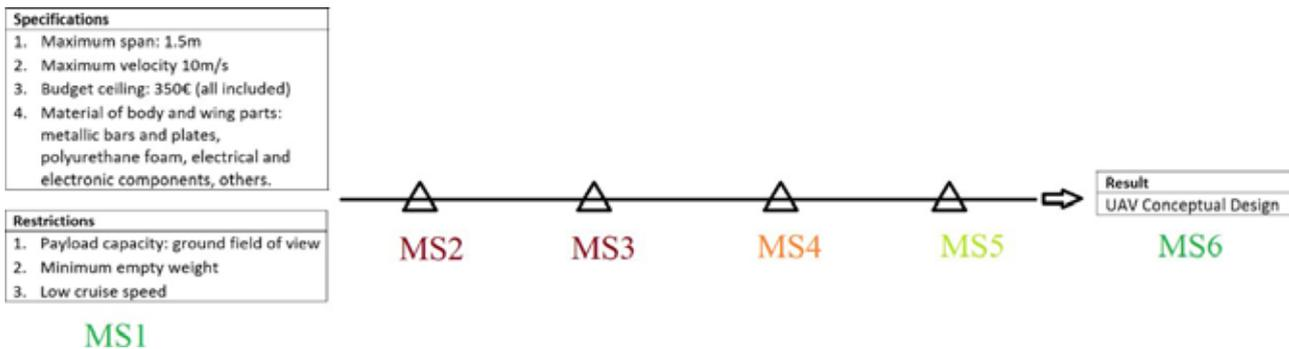


Table 2. Roadmap's milestones

MS1. Set UAV specifications and constraints
Goals Understand as clearly as possible project main goal specifications and constraints. Establish a clear planning and roles in teamwork. Select the most suitable research and design tools.
Risks No have a clear idea of the project Bad planning and organization Using inefficient research tools Uncertainty. Intense labour. Need for teamwork, and teachers' support
MS2. Research on airfoils used in UAV
Goals Get a sounded set of airfoils, get a good set of design parameters and their implication in the context of this project regarding UAV structure, construction, specifications and constraints
Risks Uncertainty. Intense labour. Need for teamwork and teachers' support to get the best set of candidates airfoils and study the design parameters.
MS3. Preliminary analysis of airfoils comparing their performance in XFLR5 or XFOIL analysis tools
Goals Preliminary analysis of the selected set of airfoils.



<p>Risks Uncertainty. Intense labour. Need for teamwork and teachers’ support. Failing to find an existing suitable airfoil implicates the need for designing your own one or modifying one of the previously selected. The sooner you reach this point of the project, the sooner level of uncertainty decreases and the need for extra work is determined. This milestone gets advantage of the minimisation of previous milestones risks</p>
<p>MS4. Final analysis of airfoils comparing their performance in CFD analysis tools</p>
<p>Goals Final analysis of the selected set of airfoils.</p>
<p>Risks Uncertainty. Intense computer labour. Need for teamwork and teachers’ support. It’s a very computer time-consuming task.</p>
<p>MS5. Comparison and selection of a final airfoils</p>
<p>Goals Obtaining the definitive airfoil for the UAV</p>
<p>Risks Uncertainty. Intense computer labour. Need for teamwork and teachers’ support. It’s a very computer time-consuming task. Pay attention to the construction process and the structural properties of the future wings.</p>
<p>MS6. Obtaining a conceptual design of the UAV</p>
<p>Goal Documentation for design and construction. Rationale behind this design.</p>
<p>Risks Finish on time, exams are getting close. Quality of the documentation.</p>

CONCLUSIONS

It seems that the impact of this practice implemented in the PBL developed by students has been quite positive.

The teachers’ perception is that the combined use of team and individual rubrics improve students’ involvement in teamwork. On the other hand, the use of Agile methodology (as framework to carry out the project), and the roadmap for the development (highlighting goals and potential risks) are improving the students’ performance regarding previous academic years. Also, they highlighted the importance of combining the informal learning such as students’ clubs and the drone workshop as it motivates students in a better involvement in the UAV project.

The students’ perception about the project is that “Agile methodologies” facilitate the development of it as it helps them to be more responsible. Also, most of them got involved in the Air division club and, got better



those got better results in this project. Regarding the evaluation system, it seems students feel happy as they see their individual effort reflected on the final mark.

REFERENCES

Schwaber, K., & Sutherland, J. (November de 2017). *The Scrum Guide*,. Obtenid de <https://www.scrumguides.org/docs/scrumguide/v2017/2017-Scrum-Guide-US.pdf#zoom=100>.

Terrón-López, M., Blanco-Archilla, Y., & Velasco-Quintana, P. (2020). Individual Assessment Procedure and its Tools for PBL Teamwor. *International Journal of Engineering Education*, 352 - 364.

AUTHOR INFORMATION

María José Terrón-López, m_jose.terron@universidadeuropea.es, Spain, Universidad Europea de Madrid, (corresponding author)

José Omar Martínez-Lucci, joseomar.martinez@universidadeuropea.es, Spain, Universidad Europea de Madrid, (corresponding author)

Víctor Manuel Padrón-Nápoles, victor.padron@universidadeuropea.es, Spain, Universidad Europea de Madrid, (corresponding author)



FROM PBL TO PROBLEM-BASED TUITION: ADAPTING PBL FOR INTERDISCIPLINARY SCIENCE

Derek Raine & Sarah Gretton

ABSTRACT

This paper describes the evolution of a degree programme in interdisciplinary science from PBL to what we describe as problem-based tuition. We claim that the programme maintains the distinctive features of PBL while evolving in response to student and staff feedback and changes in external circumstances. The programme involves a relatively small class (<25) taking a dedicated programme of interdisciplinary modules across biology, chemistry and physics with mathematics and computer programming support. Each problem-based module is set around an overarching problem or project supported by lectures, facilitation sessions and problem classes. The developments involve a greater scaffolding of learning issues and guidance on pre-session preparation built into the schedule. The evolution also involved the employment of dedicated teaching staff, the production of handbooks with detailed guidance, and experimentation with the frequency and duration of facilitation and tutorial sessions. The hybrid nature of the model centres round the degree of scaffolding which we found necessary to support learning in pure sciences where, in contrast to professional disciplines such as medicine and engineering, conceptual understanding is more central than practical implementation and where professional practice in research does not lend itself so readily to authentic problems. We describe this as “tuition” to emphasise the continued two-way dialogue involved in the learning support despite the additional structure. The main features were retained following a faculty-wide reorganisation of teaching. We recommend the implementation of PBL approaches to be treated as design science with a Kolb-style feedback loop.

KEYWORDS: problem-based tuition, design science, authentic assessment, interdisciplinary science

TYPE OF CONTRIBUTION: Practice-based abstract

PRESENTATION FORMAT: Roundtable discussion

This paper describes the evolution of a degree programme (“Natural Sciences”) in interdisciplinary science from PBL to what we refer to as *problem-based tuition*. The motivation for this development, carried out mainly over the initial five years of the programme (which is now in its fifteenth year) was the difficulty encountered in implementing PBL in the context of the pure sciences. In contrast to the applied professions such as medicine, the pure sciences provide a less ready supply of authentic problems that can be used to



motivate student-led learning issues that lead to conceptual understanding. While maintaining the key features of a problem-based approach, particularly the focus on the research process, we were led to provide a greater degree of scaffolding for the group activities. Recently, following a faculty reorganisation, the programme was modified to incorporate courses from other programmes taught with more traditional pedagogies while retaining at core the problem-based approach.

The programme involves a relatively small class with an entry of <25 per year in a three or four year course. Students take a dedicated core programme of interdisciplinary modules across biology, chemistry and physics with mathematics and computer programming support. Only the core modules are entirely problem-based (originally 5 in each year 1, now 4, 2 and 1 in years 1, 2 and 3 respectively). Each module, varying in length from five to twelve weeks, is worth 7.5 ECTS credits and is set around an overarching problem or project. Support is provided through two lectures a week, two group facilitation sessions (two hours and one hour) and a problem (or tutorial) class on set weekly exercises. The main assessment is through one or more group “deliverables” for each module with an additional examination. The problems and assessments are intended to cover a wide range of authentic contexts including presentations, reports and podcasts directed at specific audiences (for example, a grant-awarding body, an insurance company, museum visitors) (For a fuller description see Raine, 2019). No issues arose in embedding professional skills in the programme through the authenticity of the problems and assignments, but there were difficulties in using the problem context to direct students to the content at the required depth. We can classify these issues as:

- casual support (how to guarantee quality facilitation)
- direction (how to cover learning objectives)
- frequency of facilitation (how to guarantee engagement)
- practice (how to gain skills)

Initially, we found that graduate students as floating facilitators lacked ownership of the material (despite training in the mechanics and written guidance). A dedicated teaching staff, as later employed, could be more directive, but this meant that learning issues were only superficially raised by students. The eventual resolution was to transfer the guidance notes from the facilitator to the students. These have become detailed handbooks for each module. They specify a schedule of reading and exercises as preparation for each teaching session. This has become feasible through the almost zero marginal cost of electronic distribution now that all students have a laptop or tablet computer. An initial “brainstorming” workshop guides students to the learning objectives of the module in relation to the problem framework.



The dedicated teaching team involves a lead teaching –focussed member of academic staff (not necessarily full time on the programme) in each of the disciplines (biology, chemistry, physics, mathematic and computing) (Raine, 2013; Gretton et al. 2014). In addition, the lecture sessions – which are run much more interactively than the traditional sage on the stage – are provided by around 30 academic researchers teaching in their research specialisms, and consequently as we have found, with great enthusiasm. These sessions do not “cover” the material, but, along with the preparation for them, they provide a good guide to the material students need to research to tackle the problem at the appropriate level, thereby covering the learning objectives.

We tried various experiments with frequency and duration of facilitation. Having control of the timetable is crucial to ensure that students have time to prepare between sessions. However, we found that too frequent facilitation (once per day in one of our experiments (Raine and Symons, 2005)) led to only superficial preparation, whereas too infrequent (once a week initially) led to a lot of “busy work” (i.e. misdirected activity for the sake of activity). The 2+1 structure has been running for a number of years, somewhat constrained by resource and timetabling constraints. (It might be better to have 1.5+1.5, were that feasible.)

The learning (internalisation) of exemplar proofs and key arguments is crucial to being able to operate as a scientist. Set exercises are therefore a feature of all conventionally taught science programmes, both to develop skills and to test conceptual understanding. Often these are formative and optional, although the presence of an examination on the material is a good stimulus to ignore the optionality. Our programme does not have high stakes examinations, which limits the incentive for students to practice and memorise key material. We therefore introduced weekly “homework” with a tutorial session to feedback on submissions. To reduce the burden of marking as the class size grew we introduced group marking in the feedback sessions. Serendipitously this turned out to have considerable advantages in encouraging students to engage with the feedback!

What can we take away from this experience? Our main conclusion is that the introduction of problem-based approaches (or any pedagogical intervention) is a matter of design science. We go round a learning cycle using whatever evidence there is available to inform the development process. A feature of PBL as a pedagogy is that it provides intrinsic feedback to the instructor through interaction with the student, even aside from any extrinsic feedback through evaluation. Thus we have information on whether students come to class prepared and if they are engaged with the material at the right level, along with the usual metrics on performance and student feedback which are considered regularly by the student-staff committee and at each annual module review. One advantage of a relatively small cohort is that the student voice is likely to be representative. On the other hand, some judgement is required in responding to feedback. The students



on this programme had no experience of traditional lectures, yet regularly claimed to want more lectures (perhaps *because* they had no experience!). Surveys of graduates, with experience of the workplace, showed a deeper appreciation of the benefits of problem-based tuition.

These benefits survive the reconfiguration of the programme brought about by financial constraints (mitigating the risk associated with fluctuations in small student numbers and the costs of employment of permanent academic staff). We would categorise the benefits as arising from the problem-based focus, the research-oriented but highly scaffolded pedagogy, authentic assessments, and dedicated facilitators with ownership of the programme. Half of the modules in the later years are now taken from other traditionally taught programmes. However, for students on the Natural Sciences programme these modules have an additional problem-based element, thereby maintaining the pedagogical ethos.

REFERENCES

Raine D. J. (2019) *Problem-Based Approaches to Physics: Changing Perspectives in Higher Education*. IOP Series in Physics Education, IOP Publishing (Bristol). DOI:10.1088/2053-2563/ab3803

Gretton S N., Raine D J., & Bartle, C. (2014). *Scaffolding Problem Based Learning with Module Length Problems*, European Science Education Research Association Conference 2013 DOI:10.13140/2.1.2156.4162}

Raine D J. (2013) *Scaffolding problem-based learning in For the Love of Learning* ed T Bilham p84-88, Palgrave.

Raine D J. & Symons S. (eds) (2005) *PossibiLities: a practice guide to problem-based learning in physics and astronomy*. HEA Physical Sciences Centre (York).
https://www.heacademy.ac.uk/system/files/ps0080_possibilities_problem_based_learning_in_physics_and_astronomy_mar_2005.pdf

AUTHOR INFORMATION

Derek Raine, jdr@le.ac.uk, United Kingdom, University of Leicester (corresponding author)

Sarah Gretton, sng8@le.ac.uk, United Kingdom, University of Leicester (corresponding author)



FORECAST FOR THE FUTURE: PROBLEM BASED LEARNING- SIMULATIONS TO EQUIP MULTIDISCIPLINARY CHILD-SERVING PROFESSIONALS

Dorothy Haskell & Jerry Dunn

ABSTRACT

Project FORECAST (Foundations for Outreach in Experiential Child Advocacy Studies Training) is the first attempt, to our knowledge, to join both Problem Based Learning and Simulation learning methodologies in an undergraduate interdisciplinary setting focused on the child protection workforce. Specific areas of evaluation include: (1) the overall quality and accuracy of the Project FORECAST curricula, (2) success of the curricula in meeting learning objectives and developing PBL facilitation skills, (3) success of the curricula in helping learners recognize Core Concepts for Understanding Traumatic Stress Responses in Childhood, improve their Trauma-Informed Experiential Reasoning Skills (TIERS) competencies, increase their readiness to join the workforce, and enhance their ability to respond to clients' trauma, and (4) success of the curricula in enhancing subsequent employment success, retention rates, supervisor onboarding of new employees. Early results indicated self-reported improvement in trauma knowledge and trauma-informed skills. Qualitative feedback also indicates growth in collaboration skills and empathy for both other professionals and families served.

Given the demand for online courses, the FORECAST simulations are currently being adapted for use in hybrid and fully online courses. This practice-based experience demonstration will allow participants to participate in a small simulation, apply PBL within the group context, see pilot attempts at integrating PBL-S to hybrid and online teaching environments, including a virtual 360 mock house tour, and discuss potential applications within their own environment.

KEYWORDS: Problem Based Learning, Simulations, Multidisciplinary, Child-serving professionals, Hybrid

TYPE OF CONTRIBUTION: Practice based abstract

PRESENTATION FORMAT: Experience demonstration

The authors have chosen not to have their full abstract published in the conference proceedings. We encourage you to look for existing or future publications by this author in other outlets.



AUTHOR INFORMATION

Dorothy Haskell, dorothyhaskell@umsl.edu, United States, University of Missouri-St. Louis (corresponding author)

Jerry Dunn, dunnjer@umsl.edu, United States, University of Missouri-St. Louis (corresponding author)



CULTIVATING AN ENTREPRENEURIAL MINDSET IN THE CLASSROOM AND BEYOND: TOOLS FOR EXPERIMENTATION, CRITICAL LEARNING, AND CHANGE

Caitrin Lynch, Lawrence Neeley, Joanne Pratt & Jason Woodard

ABSTRACT

This paper describes a workshop that explores the power of an entrepreneurial approach to making change, using tools introduced in Products & Markets (P&M), the required first-year entrepreneurship course at Olin College of Engineering. The course focuses on identifying stakeholders, discovering what they value, and effecting change through quick iterations of experimentation and learning. P&M enables students to experiment with their identities, roles, and behaviors in the context of teamwork and entrepreneurial pursuits. This paper engages the PBL 2020 conference theme of engaging students as critical learners who develop the competences to actively participate and function in an increasingly complex, global, and network-based society, as well as the PBL 2021 theme of hybrid learning since we have now delivered the workshop online as well as in person. Workshop participants have the opportunity to apply tools, tips, and techniques from P&M to three different contexts: your students and their learning, projects you are personally involved with, and your own professional development. Tools include: value propositions, test cards and learning cards, and prototype-driven customer development activities.

KEYWORDS: entrepreneurial mindset, experimentation, prototyping, value propositions, critical learning

TYPE OF CONTRIBUTION: Practice-based abstract

PRESENTATION FORMAT: Experience demonstration

INTRODUCTION

Products & Markets is an introductory entrepreneurship class at Olin College of Engineering that is taken by every student in the second semester of their first year. In this course, students are introduced to a concept of entrepreneurship that is built upon experimentation, grounded in the context of engineering, and driven by the question, “How do we create value?” In small, dynamic teams, students explore their entrepreneurial curiosity and pursue their own definitions of value by creating real products and services, then testing them with real users and customers. Using these projects as a backdrop, students learn how to pursue “product–market fit” and develop team skills that provide a foundation for their success, not just as entrepreneurs but as engineers, innovators, and members of society.



Over the past three years, members of the P&M teaching team have conducted a series of workshops aimed at distilling the course into a format that enables participants to experience key elements of the students' journeys while acquiring tools they can apply to their own projects and professional development. This paper describes the workshop and its delivery in four different settings, as well as its impact on workshop participants, our students, and ourselves. We describe the proposed delivery of a new version of the workshop at PBL 2021, focused on the theme of engaging students as critical learners and change agents.

THE WORKSHOP

The P&M workshop is broadly aimed at educators, including faculty and administrators. The goals and objectives are summarized in the appendix of the paper. The delivery of the workshop is divided into three parts: Ideation, Experimentation, and Reflection. The length of each part can be varied to fit the time available and specific needs of each set of participants.

In the first part, we conduct an ideation activity in which participants generate ideas on sticky notes (one idea per note). We invite participants to respond to one of the following prompts: Create a “bug” list (things that bother you); What are roses (positives or opportunities) and thorns (annoyances, areas for improvement) related to a particular topic (e.g., your kitchen, traveling to this event, your office, teaching a PBL course)?; What are you curious/passionate about? Participants ideate individually for several minutes, then share in pairs or small groups, then select one idea to explore further as a group. Participants are asked to develop a value proposition for this idea using a fill-in-the-blank “ad-lib” value proposition template (Osterwalder, et al., 2014, p. 82), then share it with a larger group.

In the second part, we put participants through a full test–learn cycle in order to explore the assumptions embedded in their value proposition. Participants write Test Cards (p. 204) that outline an experiment that they will run to test a hypothesis about their customers or about product–market fit. They create a low-fidelity representation of their product (in the workshop setting, this is often a sketch, though with appropriate supplies provided it could be a low-fidelity physical prototype) and engage with customers (possibly students or other participants) to conduct their test. After engaging potential customers, participants fill out a Learning Card (p. 206) that indicates whether the evidence they collected supports their hypothesis. Finally, they update their value proposition to reflect their learning.

In the third part, we focus on how the course tools can be applied to one's own professional development. Participants complete an ad-lib template that is similar to the value proposition ad-lib they created for their product. However, this Personal Value Proposition encourages participants to think about how they could apply the tools to explore an area of potential personal learning, growth, exploration, or discovery.



The workshop is typically led by 2–3 members of the Products & Markets teaching team, with additional facilitation provided by 2–6 additional faculty, staff, and/or students.

FOUR ITERATIONS OF DEVELOPMENT AND DELIVERY

The workshop has been delivered multiple times, with 30 to 70 participants per session. It has been run as a 30-minute “mini-course” for prospective students; as a three-day internal retreat for faculty, staff, and current students; and as a workshop for educators from other institutions (in both 90-minute and 3-hour formats). When possible, it has been delivered with student facilitators who engage with the participants and share their experiences in the P&M course. Each iteration of the workshop has involved different constraints, formats, and types of participants, which has contributed toward the refinement of the ideas and execution.

Academic Life Retreat 2018

The first version of the P&M workshop was developed by Lawrence Neeley and Joanne Pratt for a three-day internal retreat at Olin College. Participants included 34 faculty members (from a range of disciplines), 23 staff members, and 7 students, with several dozen additional community members attending a report-out at the end. Staff represented several departments at the College, including Information Technology, Finance, Marketing and Communication, Student Life, Development, and the Library. The stated goals of the retreat were:

- To develop our collective capacity to build and sustain the College by exposing faculty, staff, and students to methods of experimentation and product development that are taught in Olin’s design and entrepreneurship curriculum.
- To accelerate the pace of organizational change at Olin by providing a safe environment to initiate new experiments, seek actionable feedback, and learn from failure.
- To support ongoing efforts to develop a culture of authentic, effective, and routine collaboration among all segments of the Olin community.

As this workshop was run over three days, there was time to incorporate several team-building activities, longer discussion periods, and a formal report-out session on the final day that was open to the entire Olin community. During the workshop, 10 projects that addressed areas for improvement in the college were identified. Approximately half of these ideas were pursued by teams of faculty, staff and students following the retreat.

***Summer Institute 2019***

The Olin Collaboratory Summer Institute provides participants from around the world with the opportunity to conceive and catalyze change in engineering education through participatory workshops, immersive design exercises, and presentations from experts. Our Summer Institute 2019 workshop aimed to create a learning environment for participants that embraced creativity, prototyping, and iterating, as well as introduced a set of tools, concepts, and language about student-centered experience design.

In this 3-hour version of the workshop, students were heavily involved in facilitating activities, answering participants' questions, and serving as potential "customers" for their products. This longer workshop included a 30-minute coffee break, during which participants engaged in customer development interviews to get feedback on their product and learn about what their customers value. This workshop fell in the middle of the week-long experience, which allowed participants to immediately begin applying the tools and concepts they learned to the projects that they had brought to the Summer Institute. Outcomes included a direct contribution to one university's development of a graduate-level product development course.

KEEN National Conference 2020

KEEN is a network of engineering educators committed to developing an entrepreneurial mindset (EM) in their students. Over 400 faculty and deans attended the 2020 national conference to explore the impact that "EMphasizing Value" can have on their work and the future of their students. The P&M workshop was one of the most highly attended sessions of the conference.

This iteration of the workshop provided a 90-minute engagement with the concepts and tools of the course. While there were challenges to running a shorter version of the workshop, the modifications to improve efficiency and clarity provided evidence of the flexibility of the workshop's format with very positive results. One participant wrote "Tools/worksheets I can immediately deploy in my own classroom from the Activate Change... session. (most valuable)" and another participant said "What I found valuable: examples of specific applications of the EM framework to university settings. E.g. In Activate Change, participants were led through a specific exercise modeling EM in Products and Markets." Materials from this workshop are available on the Engineering Unleashed platform (Pratt & Woodard, 2020), which is accessible to educators with a free account.

Olin College Virtual Summer Institute 2020, KEEN National Conference 2021

Due to the pandemic, this workshop was adapted and run in an online format with 20–40 participants at Olin's Virtual Summer Institute in June 2020 and the KEEN National Conference in February 2021. We again engaged students to share their experiences and serve as facilitators. We used Zoom breakout rooms and online tools including Miro for the brainstorming and prototyping activities.



CONCLUSION

Taken together, the several iterations of the P&M workshop have advanced the conference theme of engaging students as critical learners and change agents in three distinct ways. First, this is precisely what the course is about; in developing an entrepreneurial mindset, students learn to make change in the world by creating hypothesized value propositions and then adopting a critical stance toward them by subjecting them to experimentation. Second, the teaching team has actively sought to engage students in the delivery of the workshop, both as facilitators and as participants alongside faculty and staff; this is consistent with the idea of exploring “new types of collaborative engagements that go beyond the boundaries of a single group and engage students in complex networks of collaboration.” And third, by taking the ideas of the course into the domain of personal and professional development, we have expanded the role of students to include colleagues at our own institution and elsewhere.

We believe participants at PBL 2021 would benefit from the P&M workshop, and we would value the opportunity to adapt it for this audience. We therefore propose to run a 90-minute experience demonstration at the conference.

APPENDIX

The goals of the Products & Markets workshop are:

- To share tools from P&M that we have found useful in a variety of settings.
- To give you practice using these tools, so you can use them on your own and share them with your colleagues and students.
- To convince you that these tools are broadly applicable to projects aimed at purposeful, value-seeking change — including student-centered learning experiences, institutional innovation efforts, and your own professional development.

After attending the workshop, participants should be able to:

- Run (with modifications, if desired) a value proposition ideation activity with your students or colleagues.
- Execute (or have students/colleagues execute) a test–learn cycle involving a customer development interaction with a prototype.
- Reflect critically on the utility of these tools across multiple contexts, and their relationship to other tools you may already be using or familiar with.

Approximate timings for a 90-minute version of the workshop:

- Part 1: Ideation, 30 minutes



- Part 2: Experimentation, 45 minutes
- Part 3: Reflection, 15 minutes

REFERENCES

Osterwalder, A., Pigneur, Y., Bernarda, G., & Smith, A. (2014). Value proposition design. Wiley.
<https://www.strategyzer.com/books/value-proposition-design>

Pratt, J. C., & Woodard, C. J. (2020). Activate change through entrepreneurial mindset: Tools, tips, and techniques for your students, your institution, and you.
<https://engineeringunleashed.com/cards/cardview.aspx?CardGuid=deb44ad9-6673-4b61-bb6d-7c8d463392ac>

AUTHOR INFORMATION

Caitrin Lynch, caitrin.lynch@olin.edu, United States, Olin College (corresponding author)

Lawrence Neeley, lawrence.neeley@olin.edu, United States, Olin College

Joanne Pratt, joanne.pratt@olin.edu, United States, Olin College (corresponding author)

Jason Woodard, jason.woodard@olin.edu, United States, Olin College (corresponding author)



USE OF ACTIVE TEACHING-LEARNING METHODOLOGIES IN NATIONAL HUMANIZATION POLICY AND UNIQUE THERAPEUTIC PROJECT

Simone Yuri Kameo, Glebson Moura Silva, Namie Okino Sawada, Ricardo Barbosa Lima, Tiago Vasconcelos Fonseca, Andressa Cabral Vassilievitch & Pablaine Matias Lordelo Marinho

ABSTRACT

It is reported the experience lived during class involving National Humanization Policy (PNH) and Singular Therapeutic Project (PTS) in the activity Skills and Attitudes in Health at the Federal University of Sergipe, with 420 students from eight courses in the area of health, nursing, dentistry, medicine, speech therapy, occupational therapy, physiotherapy, pharmacy and nutrition. Students go to primary (basic health unit), secondary (specialty center) and tertiary (university hospital) health units and observe specific aspects, considering the guidelines of the PNH and PTS. Afterwards, group discussions are held and an explanatory video about the health unit visited is presented. Great interest and satisfaction is perceived by the students and professors, since it is possible to visit health units from the first cycle of graduation, arousing and polishing interest in their respective professions, with a focused and concerned look at issues related to humanization in the attendance.

KEYWORDS: Active methodologies, National Humanization Policy, Unique Therapeutic Project

TYPE OF CONTRIBUTION: Practice based abstract

PRESENTATION FORMAT: Interactive poster presentation

The authors have chosen not to have their full abstract published in the conference proceedings. We encourage you to look for existing or future publications by this author in other outlets.

AUTHOR INFORMATION

Simone Yuri Kameo, simonekameo@hotmail.com, Brazil, Universidade Federal de Sergipe (corresponding author)

Glebson Moura Silva, glebsonmoura@yahoo.com.br, Brazil, Universidade Federal de Sergipe (corresponding author)

Namie Okino Sawada, namie.sawada@unifal-mg.edu.br, Brazil, Universidade Federal de Sergipe (corresponding author)



Ricardo Barbosa Lima , ricardoblina17@gmail.com, Brazil, Universidade Federal de Sergipe (corresponding author)

Tiago Vasconcelos Fonseca, tiagovasconcelos@hotmail.com, Brazil, Universidade Federal de Sergipe (corresponding author)

Andressa Cabral Vassilievitch, , andy1_rbd@hotmail.com, Brazil, Universidade Federal de Sergipe (corresponding author)

Pablaine Matias Lordelo Marinho, , marinho.pablaine@usp.br, Brazil, Universidade de Sao Paulo (corresponding author)



CLINICAL PRACTICE EXAMINATION: EXPERIENCE WITH DISCENTS AT THE HEALTH AREA IN BRAZIL

Simone Yuriko Kameo, Glebson Moura Silva, Namie Okino Sawada, Bruno Ferreira Amorim, Jessica Santos Costa, Maria Julia Oliveira Ramos & Pablaine Matias Lordelo Marinho

ABSTRACT

The experience of the Clinical Practice Examination (CPE) in the Health Skills and Attitudes activity at the Federal University of Sergipe is reported, with 420 students from eight courses in the areas of health as, nursing, dentistry, medicine, speech therapy, occupational therapy, physiotherapy, pharmacy and nutrition. Groups of 5 students from these undergraduate courses are evaluated by 3 professors, through the resolution of problem situations that are simulated by monitors on the topics studied throughout the first cycle of graduation, such as first aid, clinical method (anamnesis and physical examination), anthropometric measurements, vital signs, communication, ethical issues, patient safety, among others. In this way, students were able to perform multi and interprofessional teamwork, by simulating situations that may occur in their specific professions. After the end of the CPE, teachers, monitors and students met and made a qualitative assessment of the performance of each student as an individual and in a health team. Such evaluation methodology encourages critical thinking individually and together with other students, future health professionals.

KEYWORDS: Clinical practice examination, health, methodology

TYPE OF CONTRIBUTION: Practice based abstract

PRESENTATION FORMAT: Interactive poster presentation

The authors have chosen not to have their full abstract published in the conference proceedings. We encourage you to look for existing or future publications by this author in other outlets.

AUTHOR INFORMATION

Simone Yuriko Kameo, simonekameo@hotmail.com, Brazil, Universidade Federal de Sergipe (corresponding author)

Glebson Moura Silva, glebsonmoura@yahoo.com.br, Brazil, Universidade Federal de Sergipe (corresponding author)



Namie Okino Sawada, namie.sawada@unifal-mg.edu.br, Brazil, Universidade Federal de Sergipe (corresponding author)

Bruno Ferreira Amorim, , brunofamorim@hotmail.com.br, Brazil, Universidade Federal de Sergipe (corresponding author)

Jessica Santos Costa, jessicas_costa@outlook.com, Brazil, Universidade Federal de Sergipe (corresponding author)

Maria Julia Oliveira Ramos, maju.oramos@gmail.com, Brazil, Universidade Federal de Sergipe (corresponding author)

Pablaine Matias Lordelo Marinho, marinho.pablaine@usp.br, Brazil, Universidade de Sao Paulo (corresponding author)



ROLE OF PBL IN ENGINEERING EDUCATION (ROBOCON: CASE STUDY OF MULTIDISCIPLINARY PROJECT)

Anjali Bhalchandra, Sushama Agrawal & Pranesh Murnal

ABSTRACT

Expectations from professional practicing engineering graduates are evolving and hence the demand for experiential learning. Project Based Learning (PBL) is the most suitable method of experiential learning in engineering education. It is widely used as an effective and innovative method. Present engineering education approach needs substantial change to provide students with attributes required in professional practices. Conduct of PBL is more effective when it is made part of the curriculum. PBL makes students learn and work on specific problem statements with focus upon the desired end product. Robocon is giving similar challenge at higher scale along with learning, it also has an aspect of competition.

In this paper, an attempt has been made to assess the abilities of participants of Robocon to gain higher order skills.

KEYWORDS: PBL, Graduate Attributes, Robocon, Teacher's Assessment, Programme Outcomes

TYPE OF CONTRIBUTION: Practice-based abstract

PRESENTATION FORMAT: Interactive poster presentation

INTRODUCTION

Engineering Education is continuously evolving. It has history of experiential learning through field/industry visits, lab experimentation *etc.* Douladeli E. has highlighted the advantages of Experiential learning [1]. "Doing project" was a major contribution towards learning through experiments. But doing only one project once is not enough, rather it needs continuous practice of experiential learning. Uziac J., Kolmos A have explained the importance of project and problem-based learning and life-long skills [2,3].

Government College of Engineering, Aurangabad (GECA) was granted Academic Autonomy in 2006. Academic Autonomy has given freedom to design and implement curriculum and evaluation reforms. Respective administration departments were established. Continuous evaluation method was adopted, i.e. along with traditional assessment methods, like Class Test(CT), End Semester Examination (ESE), Term Work (TW) and



Practical examination (PR), a small component was assigned as Teacher's Assessment (TA) with 20% weightage for theoretical courses. All other components except TA are based on prescribed theory and practical.

TA is something additional to the regular curriculum. Students are given task to use newly learned concepts to design a solution associated with a stated design objective. This practice makes students to develop design to provide solution. Students are given real-world problems or higher order topics. Few solutions developed in Microcontroller related courses are like Digital Speedometer using Arduino, RTOS(UC/OS-II) Programming, I2C programming, Development of Programmer kit, Design Traffic light controller, Stepper motor controller and many more. It was PBL but nomenclature was Teacher's Assessment i.e., Institute has implemented PBL in form of TA since 2006.

One important progression to PBL in form of TA, students were encouraged to participate in national and international competitions. Students started participating in 'Robocon' competition in 2010 and are performing well every year.

Introduction of Outcome Based Education (OBE) was a great help to measure students' abilities (Graduate Attributes). These abilities in the form of Program Outcome (PO) are measurable with direct and indirect assessment methods.

Recently GECA implemented Project-Problem Based Learning (PPBL) course 'Engineering Exploration' for all disciplines. Mukhandmath et. al have highlighted the role of Engineering design and its importance and different modules in this course [4]. Along with Engineering Exploration, all the disciplines in the institute have adopted PBL concepts for some of the higher semester courses. E &TC Department has adopted methodology for courses like Microcontroller, Electronics Design & Technology etc. Few interesting solutions are developed like XY plotter using Arduino, Automatic curtain operation, Smart Blind Stick, etc.

Virtue et. al [5] have highlighted about student's perspectives of PBL as "we are doing things that are meaningful". Keeping abreast them with the technology, industrial practices, project management, communication skills make them Industry Ready Engineers [6].

STRATEGY OF THE WORK

PBL makes students ready to accept challenges of national / international competitions like Robocon. Streamlined working of 25-30 students as Robocon team from first to final year and new students are added in phased manner. Technical, Finance, Documentation Committee etc. are formed. Once the problem statement is



declared, team starts preparing the overall outline of the project. The Budget plan is submitted to the Finance Committee and then Board of Management (BoM) for sanction. They are asked to give presentations as per requirement to these committees. A faculty member takes care of day to day requirements and a core committee is constituted for overall guidance in reviews, sponsors, finance. As an example of best practice, team Robocon conducts two-three hands-on workshops like PCB making, Arduino applications for students of other institutes. A research paper is published based on technology used each year.

OUTCOMES AND ASSESSMENT

Robocon is arranged by Asia Pacific Broadcasting Union, group of countries. Every year an organizing country floats a theme. Robot making requires multidisciplinary participation from students of Mechanical, ETC, Electrical, Computer Science, IT engineering. It is being observed that the complexity of the solution making is progressively increased and the participants are able to cope with it. Along with manual operated robots making an autonomous robot is cutting edge to the competition. In fact, these competitions allow students to acquire Graduate Attributes (GAs) as defined by Washington Accord [7]. Students go through a rigorous exercise making them a unique combination of promising engineering practitioner, team members, leader etc.

Research Objectives

Outcomes of students' participation in Robocon competition is measurable. With this objective, an attempt is made to analyze the impact of Robocon participation [8] in developing skills. Some of the objectives are to

1. Develop students with higher level skill set to solve complex engineering problem
2. Develop critical thinking and innovative skill to provide solution
3. Research aptitude
4. Learn modern tools
5. Relating technology to social issues
6. Team member/ Leader in multidisciplinary area
7. Communication skills
8. Project management and finance management
9. Impact on employability and higher education

In view of these objectives, a survey encompassing above-mentioned objectives was designed as given in Table I. Students across years right from 2010 to current batch participated in survey.



Table I: Survey questionnaire

1.	Name of the student	
2.	Gender	
3.	Branch	
4.	Duration of participation in Robocon	
5.	Present Occupation (Name of organization)	
Rate the change in following abilities with Robocon experience		
	Abilities	
PO1	Solve complex engineering problems	89%
PO2	Critical thinking	91%
PO2	Innovative skills	92%
PO3	Development of solution	92%
PO4	Research aptitude	86%
PO5	Learn modern tools	86%
PO6	Understand social issues	79%
PO9	Work as Team member/ Leader in multidisciplinary area	95%
PO10	Communication skills	85%
PO11	Project management and financial management	90%
Overall feedback		
1.	Did Robocon- experience helped in higher studies	97%
2.	Suggestions for next batch?	
3.	Any other comment?	

CONCLUSIONS

Students with cross-section domain were selected for survey. Out of fifty selected students forty- seven students participated. Data is analyzed and following are the inferences



Preparing robot for competition is not outcome of trial and error procedures. Students apply mathematical and domain knowledge to design robot (objective 1,5). Students start robot design once the theme is declared. They research, do literature review, study existing scenarios and prepare innovative ideas. They learn new softwares or new tools from existing softwares as per requirement (objective 2,3,4). Design is finalized through many discussions, debates and iterations to make it full proof (objective 6, 7). Simultaneously finance team members, prepare a budget in coordination with faculty in-charge taking care of expenses for robot, registration fees, transport, travel etc (objective 8). Team members start working from almost first/second year, working continuously for three to four years, making them fully professional, ready for industry, which increases their employability (objective 9).

Survey outcome in terms of percentage are expressed in table I. Senior students suggested that, present students should start working with microcontrollers projects at early years of engineering, indicating need of PBL. Robocon team won many prizes like Rookie award, best design, best MATLAB programming award. PBL has greatest impact on Robocon success.

REFERENCES

1. Efstratia D.(2014) Experiential Education through Project Based Learning, *Procedia, Social and Behavioral Sciences*, Elsevier, Vol 152, pp 1256-1260
2. Uziak, J., (2016) A project-based learning approach in an engineering curriculum. *Global Journal of Engineering Education*, Vol. 18, Number 2, pp 119-123
3. Kolmos A., J. & de Graaff, E. (2014) Problem-Based and Project-Based Learning in Engineering Education: Merging Models” *Cambridge Handbook of Engineering Education Research*. (pp. 141-161)
4. Mukhandmath S, Huddar,S., Savadi,R., Joshi, G., Kotturshettar, B B, Iyer, & N, Shettar, (2019). An Experience of Teaching Engineering Design for Freshman Students. *Journal of Engineering Education Transformations*. Special Issue No. 1, Vol. 33, pp 43-47
5. Virtue, E.E., & Hinnant-Crawford, B.N., (2019). “We’re doing things that are meaningful”, *Interdisciplinary Journal of Problem Based Learning*, 13 (2).
6. Ahuja, V.K., Suguna, I, & Swetha T., (2019). “The collaboration of industry institute interaction for delivering industry ready engineers”, *Journal of Engineering Education Transformations*, Special Issue No. 1, Vol. 33, eISSN 2394-1707
7. Raju, P.K., & Rajan, P. (2015) ‘Use of Serious Games to Teach Engineering Design Fundamentals’, *Journal of Engineering Education Transformations*, Volume 29, No.1, ISSN 2349-2473



8. Manual for Accreditation of UG Engineering Programs, [https://www.nbaind.org/ Files/engineering-programs.pdf](https://www.nbaind.org/Files/engineering-programs.pdf)

AUTHOR INFORMATION

Dr. Anjali Bhalchandra, asbhalchandra@gmail.com, India, Government College of Engineering, Aurangabad
(corresponding author)

Sushama Agrawal, agrawal.sushma1@gmail.com, India, Government College of Engineering, Aurangabad
(corresponding author)

Dr. Pranesh Murnal, pmurnal@yahoo.com, India, Government College of Engineering, Aurangabad



THE EFFECTS OF INTERDISCIPLINARY TEAM TEACHING ON PBL

Michiko Ito, Masato Nakamura, Hiroyo Sugimoto & Yukiyoishi Kobayashi

ABSTRACT

Starting in FY2020, our university will introduce PBL and certain additions to the curriculum, which will be compulsory subjects for students across all departments from first through third year. In their third year, students will challenge to solve the complex and messy problems in the real-world as a member of interdisciplinary team. Teachers will form interdisciplinary faculty teams and coach student's learning. In advance of the implementation of the new PBL subjects, we developed one of prototype teaching models. In it interdisciplinary team teaching took place; four teachers from different disciplines (i.e., physics, mechanical engineering, literary studies, and pedagogy) collaborated to design basic educational program for engineering students.

Students formed cross-fields teams to work on the project. The theme was “production of educational toys using springs”. In the final session, the students instructed schoolchildren using the toys various physics topics about springs.

The aim of this class was “transfer of learning” to enable students to integrate physical theory, learning theory, engineering knowledge, design thinking and technology and to apply their knowledge and skill to different situations through the process of toy production. A second aim was for students to develop abilities, such as collaborative learning, innovative thinking, all of which are required in the SDGs era.

In this study, our goal was to examine whether interdisciplinary team teaching is effective for PBL. So we discussed the benefits and challenges of collaborating from different disciplines on educational program development and clarified the significance of our work in the PBL process from the perspective of educational effectiveness and from faculty development.

KEYWORDS: PBL, interdisciplinary team teaching, integrate and transfer of learning, faculty development, educational effectiveness

TYPE OF CONTRIBUTION: Practice-based abstract

PRESENTATION FORMAT: Interactive poster presentation



BACKGROUND OF INTRODUCING PBL INTO CURRICULUM

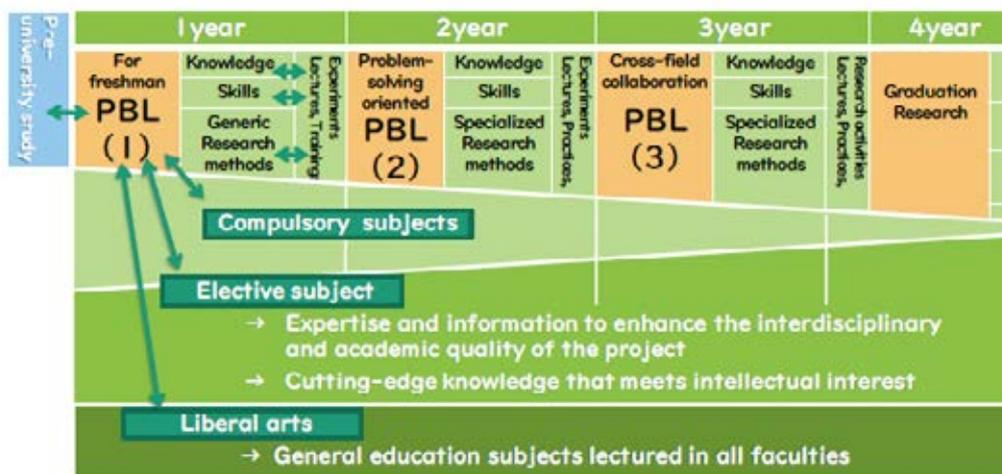
Our university is now advancing reforms based on our medium- and long-term plan, Action Plan 2030. The plan clarifies the ideals of the university for the 100th anniversary of its founding in 2029 and shows how to implement reforms in all aspects of education, research, management, and the campus.

The concept of the educational reform is “Learning and enhancing each other beyond division” that without being constrained by conventional fixed ideas between such as school and social, teacher and student, metropolitan and country side, generation. Under this concept, we aim to develop human resources that contribute to social innovation.

Table 1: Fact Sheet of Tokyo City University

Established	1929
Type	Private Institution
Organization	2 Graduate Schools, 7 Faculties, 18 Departments
Number of Students	7,486 (2019.5)
Location	Tokyo & Kanagawa, Japan
President	Prof. Chitoshi MIKI
Fields of application of PBL	All courses
Date of introduction of PBL	2020 (some teachers have been doing PBL for several years.)
PBL methodology	Hybrid
Website	https://www.tcu.ac.jp/english/index.html

Figure 1: New PBL Curriculum in our university





In order to acquire the competences necessary for the SDGs era, such as learning how to solve complex sustainable problems, substantial improvement should be made in education in a systematic manner covering everything from first-year education through after graduation education. Therefore, our university decided to introduce PBL as compulsory subjects into curriculum from 2020 as a part of educational reforms.

OVERVIEW OF PBL DESIGN AND IMPLEMENTATION

Two years ago, we had been trying to change the existing practical training class for enhancing the quality of learning. In advance of the implementation of the new PBL subjects, we were convinced that our developed class would be one of the good models in two respects. One was the theoretical PBL design model and the other was interdisciplinary prototype PBL model.

The class we developed was, which interdisciplinary team teaching took place; four teachers from different disciplines (i.e., physics, mechanical engineering, literary studies, and pedagogy) collaborated to design and implement the basic educational program for engineering students.

This class was conducted as follows:

- Students from different fields and years formed some teams and learned together on the project.
- 100-minutes session was held once a week through one semester, totalling 14 sessions.
- The theme of these projects was “production of educational toys using springs.”
- In the final (15th) session, the students held a science event in the elementary school near our university and used the toys they had produced to instruct schoolchildren on various physics topics.
- One of the targets of this class was “transfer of learning” to enable students to integrate physical theory, learning theory, design thinking, engineering knowledge, and technology and to apply their abilities to different situations through the process of toy production and instruction.
- The another targets was for students to develop certain competencies, such as resources allocating skills and interpersonal skills, information management skills, system thinking, all of which are required in the new era.
- PBL is said that it is one of the best exemplars of a constructivist learning environment. Implementing PBL requires us to assume the role of coach, facilitator, and supervisor. Above all, we tried to promote students’ thinking, their communication-including the gathering and sharing of information- their team building process, and their problem-solving strategies.
- Constructivist framework suggests posting relevant problems to learners and structuring new learning around primary concepts. So we promoted active student learning and provided several scaffoldings such as worksheets and workshops we developed for this class.

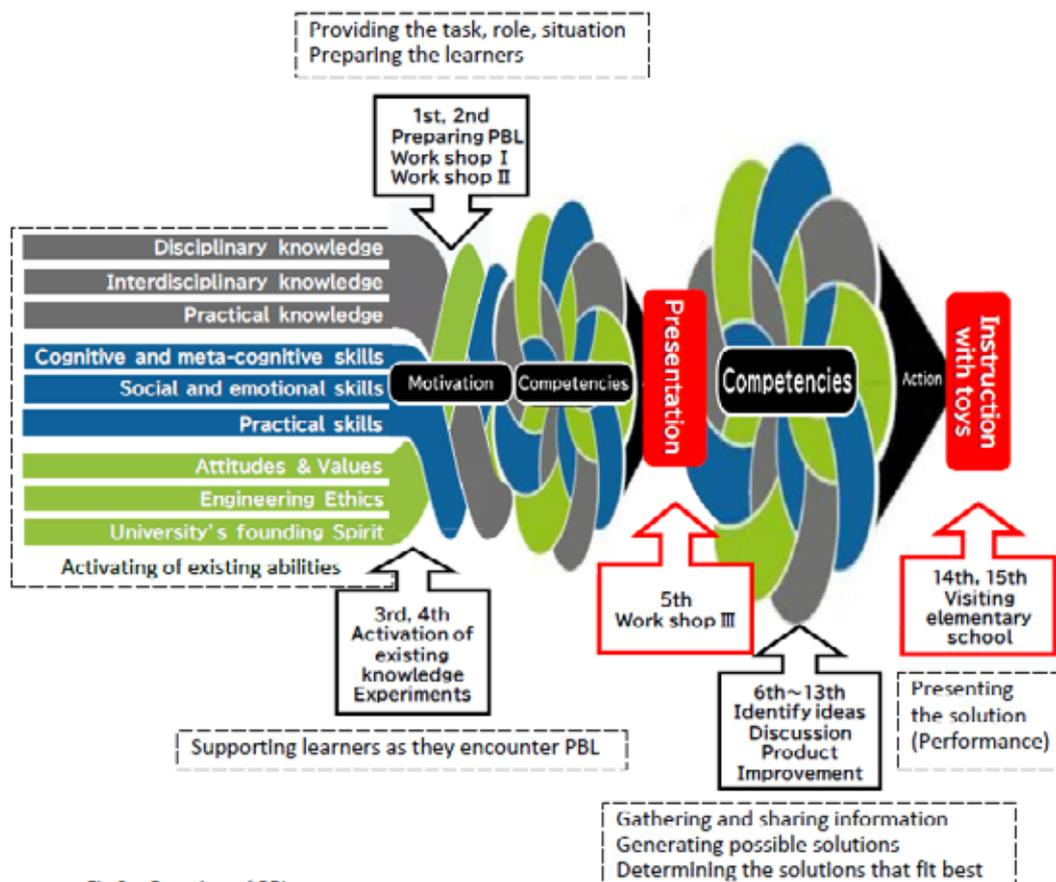


- Students bound the worksheets, survey documents, and experimental reports that they created during the PBL process into the 'Learning log-file'. We grasped the learning outcome by the log-file, products, and performances of demonstrations.

IMPLEMENTATION

PBL was implemented as follows. Figure2 is the overview of PBL showing the formation process of the ability. Figure3 shows the overview of Implementation as the graphic syllabus.

Figure 2: Overview of PBL (process by the author based on OECD Education 2030 Framework)



CONCLUSION

After implementation, in order to consider whether interdisciplinary team teaching was effective for PBL, we discussed the benefits and challenges of this PBL and clarified the significance of such work in the PBL process of design, implementation, assessment, and coaching.

1) From the perspective of educational effectiveness for students

- Interdisciplinary increased the probability of students recalling and applying what they have previously learned.



The notable achievement of this PBL is the role of each faculty member who have own speciality in teaching team was important in helping students to better understand the interconnectivity between different disciplines.

- The interdisciplinary team teaching affected the PBL process.

We discussed well in the presence of students, like one of the project teams.

In the beginning, we spent a lot of time trying to understand each field's words and each thinking patterns, but we were able to eventually deepen our understanding of each other.

By doing so, as a model of team, we could show social interactions that cognitive change often results from interactions with others who may hold different understandings.

2) From the perspective of faculty development

- Usually, university faculties only teach their own specialized content, viewpoints, and methods. But the teacher in new age will must be serve more as a coach or facilitator of learning, rather than as a lecturer or drill-and-response instructor.

PBL promotes metacognition and self-regulated learning. Students generate strategies for problem definition, information gathering, data analysis, and hypothesis building and testing. Teachers work were to encourage such learning and thinking.

So we had been comparing and sharing own field teaching strategies with the strategies of other teachers during this class. PBL process became the good opportunity of OJT (on the job training) for us.

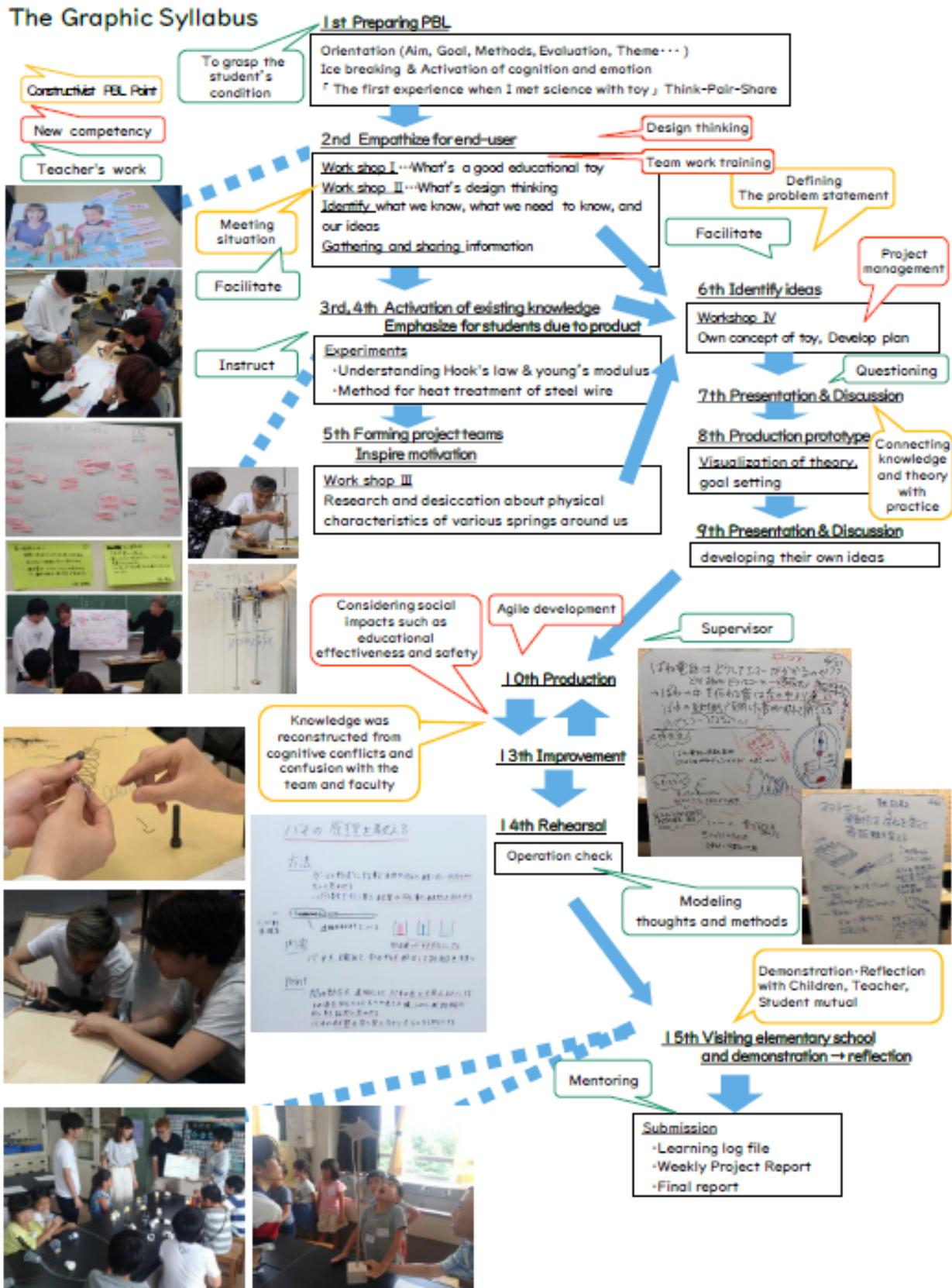
- The teaching abilities that can improve after team-teaching experience with interdisciplinary PBL are assessment skills, cognitive coaching skills, and having various teaching strategies.

For example, we've had a lot of discussions to clarify assessment in PBL, so we have come to see varying perspectives, not only subject teachers, but from the perspective of learning coaches, assessors and evaluators. The clarity of multifaceted facets of assessment and its contribution to the whole add to our insight into the student's understanding. The assessment from varying perspectives tell us much more than any one facet alone.

As described above, the interdisciplinary team teaching not only has an educational effect on students, but has also supported the personal development of teachers.



Figure 3: The graphic syllabus of our PBL class





REFERENCES

Linda Torp, Sara Sage, 2011. *PROBLEMS AS POSSIBILITIES, Problem-Based Learning for K-16 Education* (2nd ed.), ASCD

R. Keith. Sawyer, 2013. *The Cambridge Handbook of Learning Sciences* (2nd ed), Cambridge University Press.

M. Itoh, M. Jomura, H. Kuroda, S. Takamatsu, H. Toide, T. Ozawa, S. Uesaka, 2015. Advanced Methods for Enhancing the Quality of Learning in a Society Cooperation Model for Innovation Education, *Journal of JSEE*, 63, 1.74-1.80

AUTHOR INFORMATION

Michiko Ito, minto@tcu.ac.jp, Japan, Tokyo City University (corresponding author)

Masato Nakamura, mnaka@tcu.ac.jp, Japan, Tokyo City University (corresponding author)

Hiroyo Sugimoto, hsugimo@tcu.ac.jp, Japan, Tokyo City University (corresponding author)

Yukiyoshi Kobayashi, ykoba@tcu.ac.jp, Japan, Tokyo City University (corresponding author)



Project PBL – Case PBL



AN INVESTIGATION OF THE EFFECTS OF INTEGRATING COMPUTING AND PROJECT OR PROBLEM-BASED LEARNING: THE IMPACT ON PAKISTANI STEM TEACHERS

Mahnaz Moallem, William L. Sterrett & Christopher Gordon

ABSTRACT

The paper reports a study integrating computing, project or problem-based learning, and engineering processes to address the needs of preparing the STEM workforce in Lahore, Pakistan, through transforming STEM teaching and learning processes. It also aimed to build the capacity of the University of Education, Lahore, Pakistan, to improve the quality and relevancy of its STEM teacher education programs and its partnership schools. To design, develop, implement, and evaluate the project, a cross-disciplinary, collaborative team of STEM and STEM education faculty from two U.S. universities and the University of Education (UE), Lahore, was formed. The team worked with middle and high school STEM teachers from the four under-served, rural schools with a high level of poverty and lack of resources in the Province of Punjab. Three STEM learning units (with a specific focus on water and management of natural resources) were designed and developed using the integration of project-based and problem-based learning with Squeak Etoys simulation and modeling technology. The STEM teachers and teacher education faculty at UE participated in a week-long face-to-face professional developed workshop, which was also supported by an online learning environment and self-directed learning materials, and a series of follow-up online webinars. The results showed that STEM teachers embraced the opportunity to transform their traditional lecture and homework-based approach. Transformation in STEM teaching practices also helped 6-8 grade students to engage in community-based inquiry and using computing and engineering processes to apply their STEM content knowledge.

KEYWORDS: Problem/project-based Learning, STEM Education, Integrated STEM, Computing, Simulation and Modeling

TYPE OF CONTRIBUTION: Full scientific paper

PRESENTATION FORMAT: Interactive paper presentation

The authors have chosen not to have their full paper published in the conference proceedings. We encourage you to look for existing or future publications by this author in other outlets.



AUTHOR INFORMATION

Mahnaz Moallem, mmoallem@towson.edu, United States, Towson University, (corresponding author)

William Sterrett, sterrettw@uncw.edu, United States, University of North Carolina Wilmington (corresponding author)

Christopher Gordon, christopher.gordon@lr.edu, United States, Lenoir-Rhyne University (corresponding author)



DIAGNOSE, ANALYSIS, AND PROPOSAL OF PROJECT-BASED LEARNING (PBL): A CASE FOR ANALOG COMMUNICATIONS COURSE

Eduardo A. Fernández & Liliana Fernández-Samacá

ABSTRACT

This paper applies the strength, weakness, opportunity, and threat (SWOT) matrix as a tool to diagnose the learning results on the traditional curricula of analog communication course as a study case in an electronics engineering faculty. An analysis of surveys to students after finishing their courses during three semesters indicates that due to the lack of context, the math applications using fundamental concepts (i.e., Rayleigh and Parseval theorems) forced the students to face difficulties in understanding the basics of signal analysis. The proposed PBL design focuses on students to face little challenges (sub-problems) related to the implementation of a radio transmission system. Then, through different operations and modeling of distortive phenomena on signals as key elements, the effect was to approach real-life scenarios and enhance the students' knowledge and skills. The PBL was deployed by using programming Universal Software Radio Peripheral (USRP) devices and GNU Radio to validate a complete transmission scenario using amplitude modulation (AM) and frequency modulation (FM). This proposal is a first trial in the telecommunications area, seeks to motivate students, and evaluates the adoption of the PBL methodology. The experience will be conducted during more semesters looking for consolidating the theoretical and experimental skills through validation of the fundamental concepts used in analog communication systems.

KEYWORDS: Project-Based Learning, Analog Communications, SWOT Analysis

TYPE OF CONTRIBUTION: Full scientific paper

PRESENTATION FORMAT: Roundtable discussion

The authors have chosen not to have their full paper published in the conference proceedings. We encourage you to look for existing or future publications by these authors in other outlets.

AUTHOR INFORMATION

Eduardo Avendaño, eduardo.avendano@uptc.edu.co, Colombia, Universidad Pedagógica y Tecnológica de Colombia (corresponding author)



Liliana Fernández-Samacá, liliana.fernandez@uptc.edu.co, Colombia, Universidad Pedagógica y Tecnológica de Colombia (corresponding author)



EFFECTIVENESS OF PROBLEM-BASED LEARNING ON LEARNERS' CRITICAL THINKING SKILLS ON TROPONIN I IN MYOCARDIAL INFARCTION RISK PREDICTION

Nasser Drareni

ABSTRACT

Cardiac troponins are recommended as the preferred biomarkers for the diagnosis of acute myocardial infarction that comprises a variety of clinical scenarios. So High-sensitivity troponin I (hs-cTnI) concentrations reflect myocardial stress. The role of hs-cTnI in predicting long-term changes in the risk of cardiovascular disease in general populations is not clearly defined. Objective: The study aims to assess the effectiveness of problem-based learning (PBL) as a pedagogy tool in clinical years to improve learning of undergraduate learners in terms of acquisition and reflection of content knowledge, critical thinking and problem solving skills through PBL and traditional way of teaching troponin I in myocardial infarction (MI) risk prediction at the University of Medicine Algiers, Algeria. Methodology: A total of 30 fourth-year medicine learners attending were inducted as participants in this study. 15 learners in the PBL group that learnt relevant clinical knowledge through a modified PBL process. And 15 learners in the traditional lecture group that learnt through traditional teaching, involving bedside teaching and lectures in wards. The California critical thinking disposition inventory (CCTDI) was used to measure the learners' critical thinking, problem solving skills, lifelong and deep learning. Results: Compared with lecture learners, PBL learners showed significantly greater improvement in overall CCTDI and a positive learning attitude. In terms of critical thinking, problem solving for troponin I in MI risk prediction, a significant relationship was found among the PBL group. Conclusion: PBL is an effective instructional tool to foster critical thinking and problem solving skills among medical learners.

KEYWORDS: Problem-based learning, Cardiac troponins, problem solving skills, critical thinking skills.

TYPE OF CONTRIBUTION: Practice-based abstract

PRESENTATION FORMAT: Roundtable discussion

FULL ABSTRACT

Cardiac troponins are recommended as the preferred biomarkers for the diagnosis of acute myocardial infarction that comprises a variety of clinical scenarios. So High-sensitivity troponin I (hs-cTnI) concentrations reflect myocardial stress. The role of hs-cTnI in predicting long-term changes in the risk of cardiovascular



disease in general populations is not clearly defined. **Objective:** The study aims to assess the effectiveness of problem-based learning (PBL) as a pedagogy tool in clinical years to improve learning of undergraduate learners in terms of acquisition and reflection of content knowledge, critical thinking and problem solving skills through PBL and traditional way of teaching troponin I in myocardial infarction (MI) risk prediction at the University of Medicine Algiers, Algeria. **Methodology:** A total of 30 fourth-year medicine learners attending were inducted as participants in this study. 15 learners in the PBL group that learnt relevant clinical knowledge through a modified PBL process. And 15 learners in the traditional lecture group that learnt through traditional teaching, involving bedside teaching and lectures in wards. The California critical thinking disposition inventory (CCTDI) was used to measure the learners' critical thinking, problem solving skills, lifelong and deep learning. **Results:** Compared with lecture learners, PBL learners showed significantly greater improvement in overall CCTDI and a positive learning attitude. In terms of critical thinking, problem solving for troponin I in MI risk prediction, a significant relationship was found among the PBL group. **Conclusion:** PBL is an effective instructional tool to foster critical thinking and problem solving skills among medical learners.

REFERENCES

- Barrows, H.S., & Lynda, W.K.N. (2007). Principle and practice of PBL
- Barell, J. (2010). Excerpts from problem based learning: The foundation for 21st century skills
- Cooke, M. & Moyle, K. (2002). Students' evaluation of problem-based learning. *Nurse Education Today*, 22, 330-339
- Carrió, M., Larramona, P., Baños, J. E., & Pérez, J. (2011). The effectiveness of the hybrid problem-based learning approach in the teaching of biology: a comparison with lecture-based learning. *Journal of Biological Education (Society of Biology)*, 45(4), 229-235. doi:10.1080/00219266.2010.546011
- Dochy, F, Segers, M., Van den Bossche, P. & Gijbels, D. (2003). Effects of problem-based learning: a meta analysis. *Learning and Instruction*, 13, 533-568
- Elvan. (2010). Effects of problem solving method on science process skills and academic achievement. *Journal of Turkish Science Education*, 7(4), 13-25
- Facione, N. C., Facione, P. A., & Sanchez, C. A. (1994). Critical thinking disposition as a measure of competent clinical judgment: The development of the California Critical Thinking Disposition Inventory. *Journal of Nursing Education*, 33(8), 345-350.



Hmelo-Silver C. E. (2004). Problem-based learning: What and how do students learn? *Education Psychology Review*, 16(3), 235–266, doi: 10.1207/s15327809jls0702_2.

Henderson, G. (2014). The relationship between problem-based learning and the development of critical thinking skill in higher education (Doctoral dissertation, Texas A & M University, Texas). Proquest LLC, UMI 3636037

Keller, Till & Zeller, Tanja & Peetz, Dirk & Tzikas, Stergios & Roth, Alexander & Czyz, Ewa & Bickel, Christoph & Baldus, Stephan & Warnholtz, Ascan & Fröhlich, Meike & Sinning, Christoph & Eleftheriadis, Medea & Wild, Philipp & Schnabel, Renate & Lubos, Edith & Jachmann, Nicole & Genth-Zotz, Sabine & Nicaud, Viviane & Blankenberg, Stefan. (2009). Sensitive Troponin I Assay in Early Diagnosis of Acute Myocardial Infarction. *The New England journal of medicine*. 361,868-877. DOI: 10.1056/NEJMoa0903515

Inel, D., & Balim, A.G. (2010). The effects of using problem-based learning in science and technology teaching upon students' academic achievement and levels of structuring concepts. *Asia-Pacific Forum on Science Learning and Teaching*, 11(2).

Januzzi JL, Bamberg F, Lee H, Truong QA, Nichols JH, Karakas M, Mohammed AA, Schlett CL, Nagurney JT, Hoffmann U, Koenig W. (2010). High-sensitivity troponin T concentrations in acute chest pain patients evaluated with cardiac computed tomography. *Circulation*, 121,1227-1234. doi: 10.1161/CIRCULATIONAHA.109.893826

Khoshnevisasl P, Sadeghzadeh M, Mazloomzadeh S, Hashemi Feshareki R, Ahmadiafshar A. (2014). Comparison of problem-based learning with lecture-based learning. *Iran Red Crescent Med J*, 16:e5186

Major, C. H. & Palmer, B. (2001). Assessing the effectiveness of problem-based learning in higher education: Lessons from the literature. *Academic Exchange Quarterly*, 5, 4-9.

Michel, M. C., Bischoff, A. & Jakobs, K. H. (2002). Comparison of problem- and lecture- based pharmacology teaching. *TRENDS in Pharmacology Sciences*, 23(4), 168-170 McParland M, Noble LM, Livingston G. (2004). The effectiveness of problem-based learning compared to traditional teaching in undergraduate psychiatry. *Med Educ*, 38,859-67

Nalesnik, S. W., Heaton, J. O., Olsen, C. H., Haffner, W. H. J. & Zahn, C. M. (2004). Incorporating problem-based learning into an obstetrics/gynecology clerkship: impact on student satisfaction and grades. *American Journal of Obstetrics and Gynecology*, 290, 1375- 81



Oja, K. J. (2011). Using problem-based learning in the clinical setting to improve nursing students' critical thinking: An evidence review. *Journal of Nursing Education*, 50(3), 145- 151. doi:10.3928/01484834-20101230-10

Reichlin T, Hochholzer W, Bassetti S, Steuer S, Stelzig C, Hartwiger S, Biedert S, Schaub N, Buerge C, Potocki M, Noveanu M, Breidthardt T, Twerenbold R, Winkler K, Bingisser R, Mueller C (2009) .Early diagnosis of myocardial infarction with sensitive cardiac troponin assays. *N Engl J Med*, 361,858-867. DOI: 10.1056/NEJMoa0900428

Schwartz RW, Burgett JE, Blue AV, Donnelly MB, Sloan DA.(1997). Problem-based learning and performance-based testing: Effective alternatives for undergraduate surgical education and assessment of student performance. *Med Teach*, 19,19-23

Singaram VS, Dolmans DH, Lachman N, van der Vleuten CP.(2008). Perceptions of problem- based learning (PBL) group effectiveness in a socially-culturally diverse medical student population. *Educ Health (Abingdon)*, 21:116

AUTHOR INFORMATION

Nasser Drareni, drareninacer@yahoo.fr, Algeria, University of Blida 2 (corresponding author)



PBL APPLIED IN THE FRESHMAN YEAR OF A MECHANICAL ENGINEERING PROGRAM IN SOUTHERN BRAZIL

Vanessa F. M. de Queiroz, Celson P. Lima & Ricardo Kratz

ABSTRACT

This paper presents a case study of a Problem Based Learning (PBL) application in the freshman year of the Mechanical Engineering program from SENAI College, in the southern city of Blumenau, Brazil. Students were challenged to solve accessibility-related problems in public playgrounds designing recreational devices that could be used by all children, irrespectively of their physical limitations. The challenge was carried out during a full academic year, and it was divided into two stages: 1) problem analysis and project proposal; and 2) construction of the prototype. The aim was to integrate knowledge coming from various disciplines (e.g. Mechanical Engineering Introduction; Calculus; Technical Drawing; Algebra; Physics; Programming) in order to help the students to develop their (real world) engineering skills as part of their education. Four prototypes were designed and built, namely a Double Swing for Wheelchair People, an Inclusive Skateboard, a Zip Lining for Children with Reduced Mobility, and a Mechanized Swing.

KEYWORDS: Active methodologies, PBL, Social Inclusion, PWSN, Mechanical Engineering

TYPE OF CONTRIBUTION: Practice-based abstract

PRESENTATION FORMAT: Roundtable discussion

INTRODUCTION

The adoption of active methodologies in engineering has been object of study of different authors (Ulseth & Kolmos, 2017; Dahms, 2014; Teixeira & Souza, 2018; Ferreira, Silva, Borges & Luz, 2019; Guerra,) reflecting the transformations that have been occurred in the last decades impacting directly the engineering education.

Problem based learning (PBL) “is an educational approach whereby the problem is the starting point of the learning process” (Graaff & Kolmos, 2003). In this way, the undergraduates are challenged to understand and solve a problem of real life integrating the subjects learned in the classroom, which allows them to have an active role in their education.

This paper presents the application of a PBL case in the freshman year of the Mechanical Engineering program from SENAI College, in the southern city of Blumenau, Brazil. It is worth recalling that newcomers have a



whole world of expectations combined with some lack of experience related with the professional domain they have chosen.

According to Guimarães (2003 APUD Berbel, 2011), individuals are naturally willing to perform a task based on their own free will, meaning that they want to do it, and not because they are forced by external demands. Therefore, PBL methodology is applied in order to make them autonomous and confident when solving a relevant societal problem, thus transforming this expectation into self-realization, and allowing them to develop fundamental skills for their future careers: leadership, team spirit, planning, and the ability to sell projects and ideas.

The challenge was to stimulate the students to exchange of engineering knowledge and techniques aiming at creating a playground equipment that would promote the inclusion of children with physical and/or mental disabilities.

METHODS

When the semester started the newcomers were introduced to the curriculum and the structure of the Mechanical Engineering program. At this moment, the learning approach adopted in the program was presented, which is essentially rooted in the development of an Integrated Project (each semester, starting from the very first one). Such a project is proposed to the students who are guided by a group of professors. Essentially, we try to integrate subjects of several disciplines in order to solve engineering-related problems that are relevant to the society. The subjects covered in the periods of this case study and the weight of each one in the final grade of Integrated Project are shown in Table 1.

Table 1: Subjects index in the Integrator Project.

Period	Subject	Weight
First (2019/1)	Introduction to the Mechanical Engineering	30%
	Calculus I	10%
	Technical Drawing I	20%
	Science, Technology and Society	20%
	Algebra I	10%
Second (2019/2)	Physics I	20%
	Calculus II	10%
	Programming I	30%
	Research Methods and Techniques	10%
	Algebra II	10%



As already mentioned, the challenge initially presented to the students was to develop a device using a CAD software that could be used in public playgrounds, whose primary function is social inclusion.

The project was split into two phases, namely problem analysis and design of a solution, and construction of the prototype. The students were grouped into five teams of four students to develop the projects.

First Phase

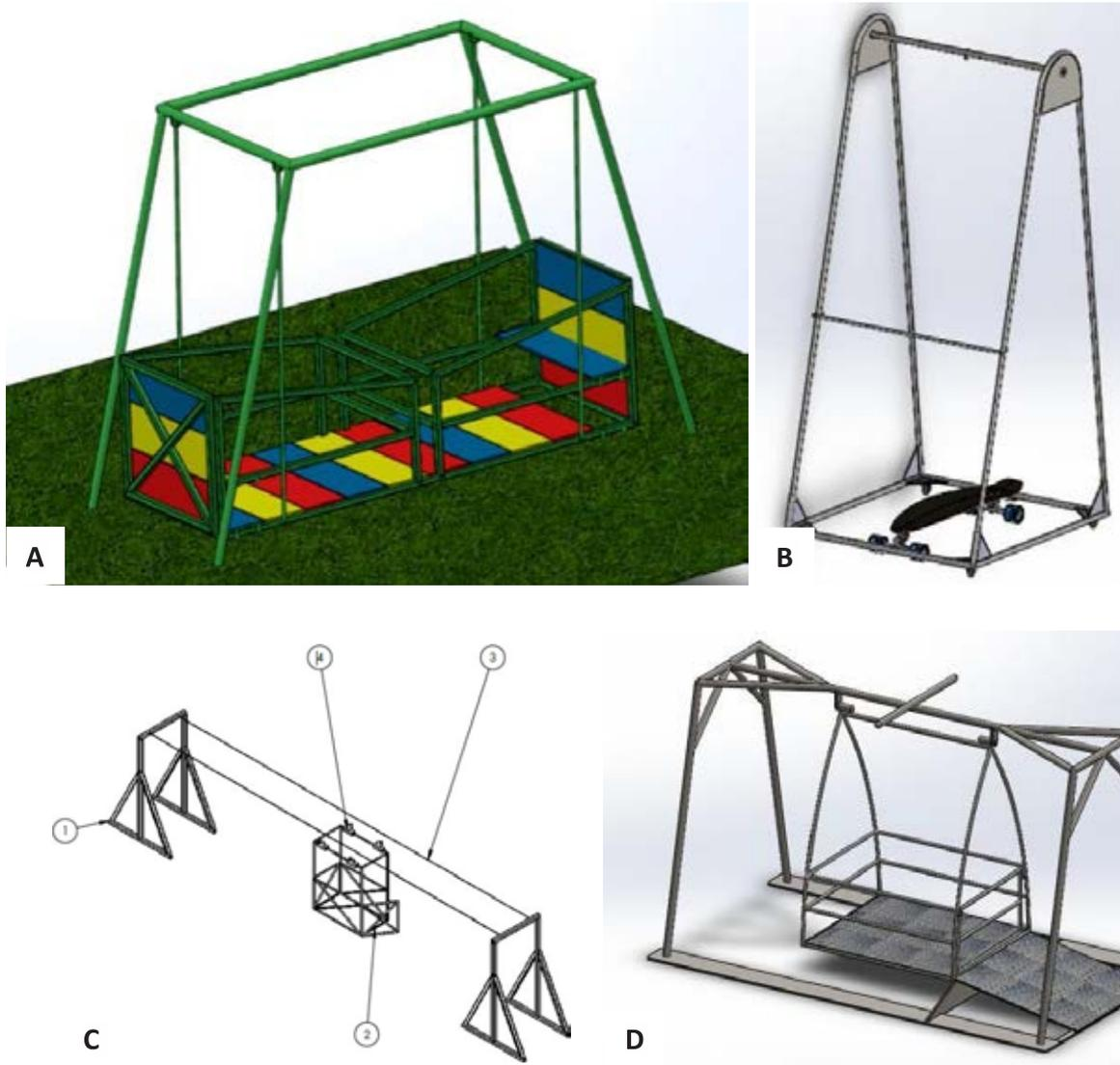
The first phase, focused in the problem analysis and design of a solution, was carried out based on the activities related to each discipline as presented in Table 2.

Table 2: Activities executed per discipline in the first phase.

Subject	Activities
Mechanical Engineering Introduction	- Previous research about solutions already created for the problem.
Calculus I	- Modeling of the device parts using functions.
Technical Drawing I	- Sketch development. - Project analysis. - Technical feasibility analysis. - Purchase list for the prototype construction. - Process analysis for industrial scale manufacturing.
Science, Technology and Society	- Mechanical Project. - Social discussion. - Reporting techniques.
Algebra I	- Definition of the movement performed algebraically by the equipment and standard displacement matrix to describe it.

To close this phase, each group delivered a technical report, a pitch, and an oral presentation. Figure 1 presents the devices designed by the students.

Figure 1: Devices designed. A) Double Swing for Wheelchair People, B) Inclusive Skateboard, C) Zip Lining for Children with Reduced Mobility, and D) Mechanized Swing.



Second Phase

The second phase, focused in the construction of the prototype, was carried out based on the activities related to each discipline as presented in Table 3.

Table 3: Activities executed per discipline in the second phase.

Subject	Activities
Physics I	- Analysis of prototype movement based on kinematic knowledge identifying the equations that describe it.
Calculus II and Algebra II	- Resolution of equations for estimation of



Programming I	physical parameters: speed, friction, relative forces, cable stresses, etc.
Research Methods and Techniques	- Modeling of equations developed in the subject of calculus. - Bibliographic research - Writing an academic paper

To close this phase, each group produced an academic paper and made oral presentation. Figure 2 presents the real prototypes of all devices constructed by the students.

Figure 2: Prototypes. A) Double Swing for Wheelchair People, B) Inclusive Skateboard, C) Zip Lining for Children with Reduced Mobility and D) Mechanized Swing.





CONCLUSIONS

The evolution of the students regarding their commitment and engagement to the project was evident, as they were able to get involved through previous research and understanding of the end user's needs. A meeting was held with a disabled person who is active in the local community, which allowed the students to have a better perception of the context in which their devices would be inserted and the development of empathy for the client they should answer.

The feeling of effectively contributing to society even with a small project, triggered in the students a sense of responsibility and contributed to make them feel actors of change as future engineers. The power of change rely on their hands and heads.

Final conclusion is that the use of PBL proved to be a solid and well-suited approach to promote hands on knowledge creation. The challenge was overcome amazingly well in terms of the activities proposed in each discipline and the development of the maturity level of the students, preparing them for the next academic challenges.

REFERENCES

Stefani Teixeira, C., Vieira de Souza, M. (2018). Educação fora da caixa: tendências internacionais e perspectivas sobre a inovação na educação. (Vol. 4). São Paulo: Blucher.

Gomes Pinto Ferreira, M., Souza da Silca, W. Albuquerque Benevente Borges, C., Silveira Luz, R. (2018). Metodologias ativas de aprendizagem aplicadas no ensino da engenharia. CIET:EnPED, [S.l.]. São Carlos, SP. ISSN 2316-8722. Disponível em: <http://cietenped.ufscar.br/submissao/index.php/2018/article/view/877>. Acesso em: 07 ago. 2019.

Guerra, A., Ulsth, R., Kolmos, A. (2017). PBL in Engineering Education. Netherlands: Sense Publishers.

Lisa Dahms, M. (2014). Problem Based Learning in Engineering Education. Aalborg, Denmark.

De Graaff, E., Kolmos, A. (2003). Characteristics of Problem-Based Learning. International Journal of Engineering Science. (Vol. 19, n° 5, pp. 657-662).

Aparecida Navas Berbel, N. (2011). N. As metodologias ativas e a promoção da autonomia de estudantes. Semina: Ciências Sociais e Humanas. (Vol. 32, n° 1, pp. 25-40).

AUTHOR INFORMATION

Vanessa F. M. de Queiroz, felicianovanessa@gmail.com, Brazil, Faculdade de Tecnologia SENAI (corresponding author)



Celson P. Lima, celson.pantoja@sc.senai.br, Brazil, Faculdade de Tecnologia SENAI

Ricardo Kratz, ricardok@edu.sc.senai.br, Brazil, Faculdade de Tecnologia SENAI



ANALYSIS OF ENTREPRENEURSHIP EDUCATION PEDAGOGY IN PROJECT-BASED LEARNING FROM THE PERSPECTIVE OF LIFE CYCLE THEORY

Lihui Xu & Pan Zhu

ABSTRACT

Many founders of small and medium-sized sci-tech companies are sci-tech personnel themselves. They know how to start research and development of the products, but they don't know how to transfer their research and development results into business smoothly or to start a technological enterprise successfully. They haven't received professional entrepreneurship education and training. Start-ups have different characteristics of business development in different stages of their life cycle. The characteristics of business development determine that entrepreneurship education must be carried out hierarchically and evolutionally development in combination with the objective laws of business development and talent training. This study aims at exploring such a new model - project-based learning (PBL) by using entrepreneurial project from the perspective of life cycle theory. The study takes McMaster University and Ryerson University's entrepreneurship education programs as case study and proposes a "four stages of advanced entrepreneurship education model". The first stage is popularization stage, which means entrepreneurship awareness + confidence cultivation. The second stage is early stage, which means entrepreneurship thinking + idea extraction. The third stage is startup stage, which means entrepreneurship ability + resource integration. The fourth stage is maturity stage, which means entrepreneurship efficiency + strategic planning. At the end of the stages, the learners (entrepreneurs) will commercialize their entrepreneurial products or technologies and eventually go to the market.

KEYWORDS: Entrepreneurship education; Project-based learning; Life cycle theory

TYPE OF CONTRIBUTION: Practice-based abstract

PRESENTATION FORMAT: Roundtable discussion



FULL ABSTRACT

“It's not magic; it's not mysterious; and it has nothing to do with genes. It's a discipline and, like any discipline, it can be learned.” (Peter Drucker, 1986) According to the real business environment and the relationship between universities and the outside campus, Kevin Hindle (2004) designed a concentric circle model of entrepreneurship education teaching pedagogy. Although this model basically reflects the relevance and integration between entrepreneurship courses and other courses in curriculum setting, forming an entrepreneurship course group that can "embed" the existing curriculum system. However, it can be seen from the correlation among the elements of the model that the model lacks the advanced and coherent knowledge granting, and ignores the logic of education itself.

The principle of "step by step" put forward by J.A. Comenius in his book of "The Great Didactic" shows that order exists in all activities of nature and human beings, and teaching must be carried out step by step and systematically. (Comenius, 1632) The reason why teaching should be carried out in order systematically and coherently is that scientific knowledge itself has internal logical connection, and that human cognitive activities follow the order from known to new knowledge. Entrepreneurship education should be based on the students who are the main entrepreneurs. Therefore, the design of the teaching model should not only conform to the teaching law of cultivating entrepreneurial talents' ability, but also be combined with the objective law of the development of business entrepreneurship.

The concept of "business ecosystem" was first proposed by James Moore in 1993. Moore then put forward the "life cycle theory" of business ecosystem. Moore divides the life cycle of business ecosystem into four stages: development, expansion, leadership and renewal. With the maturity of the business ecosystem dominated by innovation and entrepreneurship, entrepreneurship education in colleges and universities plays an increasingly important role in the innovation and entrepreneurship ecosystem. The entrepreneurship education led by the engineering school implemented by McMaster University and Ryerson University in Canada fully embodies the principle of gradual progress of life cycle theory, and forms a distinctive teaching model of entrepreneurship education.

The entrepreneurship education teaching model at the Walter G Booth School of Engineering Practice at McMaster University is a kind of commercialization process of students' start-up products, which consists of three stages and each of which has an evaluation procedure. At the end of each stage, the Entrepreneurship Review Committee (ERC) evaluates the progress of the entrepreneurship project and then decides the start-up whether to continue to the next stage or terminate the entrepreneurship project. The ERC calls it as the tollgate,



which is divided into three levels: 1) the concept initiation tollgate; 2) the business initiation tollgate; 3) the business start-up tollgate. Through this process, students can test the effectiveness of entrepreneurial projects, so that the deliverables of each stage can be refined and strengthened. In the process of continuous improvement, entrepreneurial projects have completed the whole commercialization process from entrepreneurial ideas to business concepts, and to the establishment of start-ups.

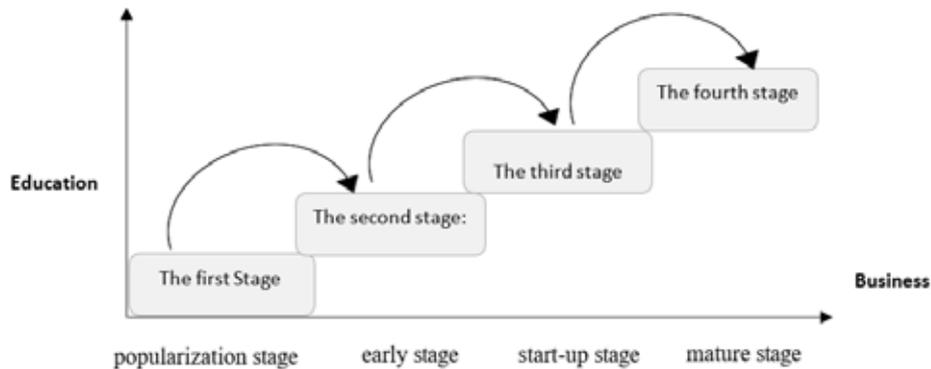
The Master of Engineering Innovation and Entrepreneurship (MEIE) program at Ryerson University is mainly designed for engineering students and industry professionals who intend to establish technological start-ups. The total duration of the program is 16 months, including 8 courses and 8 months of entrepreneurial practice. The MEIE program has 8 courses in total, which provide entrepreneurs with the tools and knowledge they need to master at each stage of their entrepreneurship program. In the practice stage of entrepreneurial projects, entrepreneurs need to develop and complete a business plan from commercialization of technical concepts to market entry within 8 months. At the end of the study, entrepreneurs will commercialize their entrepreneurial products or technologies and eventually go to the market.

It can be seen from the teaching model of entrepreneurship education in the two schools that the entrepreneurship education not only inspires the entrepreneurs' awareness of innovation and entrepreneurship, but also enables the students to master the skills needed in the process of entrepreneurship. At the same time, the process of entrepreneurship education is also the process of commercializing students' entrepreneurial products. The process of entrepreneurship education in the two schools is in line with the process of development, expansion, leadership and renewal of the life cycle theory model, which enables students to better understand the generation, development and evolution of entrepreneurship.

Based on the above model introduction and case analysis, we realize that entrepreneurship education on the one hand should conform to the essential characteristics of business entrepreneurship. On the other hand, it should be combined with the cultivation of entrepreneurs' personal quality. Not only that, entrepreneurship education should also pay attention to the coherence and logicity of knowledge education itself. Therefore, this study proposes a four-stages advanced entrepreneurship education teaching model with project-based learning (PBL) by using life cycle theory (Figure 1).



Figure 1. Four-stages Advanced Entrepreneurship Education Teaching model



The first stage: popularization stage (entrepreneurship awareness + confidence cultivation).

Entrepreneurial consciousness, which dominates the attitude and behavior of entrepreneurs towards entrepreneurial activities, has strong selectivity and initiative, and is an important part of the personal quality of entrepreneurs. On the one hand, the main teaching objectives of this stage are to carry out general entrepreneurship education for students and improve the entrepreneurial awareness of potential entrepreneurs; on the other hand, to cultivate the confidence of potential entrepreneurs, explore their entrepreneurial motivation and establish their entrepreneurial ideals.

The second stage: early stage (entrepreneurial thinking + idea refining).

Entrepreneurial thinking is a kind of special thinking mode that entrepreneurs actively train their own mental operation process based on their own knowledge structure and combine their own entrepreneurial ideas to form a preference for innovation and entrepreneurship. The main teaching goal of this stage is to provide the basic courses of entrepreneurship, at the same time, cultivate entrepreneurial thinking and ideas, and explore entrepreneurial ideas and ideas. At this stage, the technical mentor begins to get involved, so as to help entrepreneurs transform entrepreneurship concepts into product prototypes and prepare for the formation of entrepreneurial products in the next step.

The third stage: start-up stage (entrepreneurship ability + resource integration).



Entrepreneurial ability is the assembly of all knowledge and skills to ensure that entrepreneurs can successfully achieve their entrepreneurial goals. It is the main condition reflected in entrepreneurial practice that affects the efficiency of entrepreneurial practice and promotes the smooth progress of entrepreneurial practice. Resource integration means the formation of entrepreneurial team and business model in this stage. The main teaching goal of this stage is to test the teaching results of the first two stages and to screen the entrepreneurial projects. At this stage, the business mentor begins to get involved, and the entrepreneurship education begins to enter the incubation stage.

The fourth stage: mature stage (entrepreneurial efficiency + strategic planning).

Entrepreneurial effectiveness is a study on the field of entrepreneurship by scholars using social cognitive theory. It is the specific application of self-efficacy in the field of entrepreneurship. Scherer (et al, 1989) defined entrepreneurial efficacy as the strength of belief that individuals can successfully play the role of entrepreneurs and complete entrepreneurial tasks. The main teaching goal of this stage is to evaluate the entrepreneur's ability in the entrepreneurial activities, including the judgment of self-confidence in completing the entrepreneurial tasks, as well as the entrepreneurial strategic planning. This stage is to provide continuous entrepreneurship education for those entrepreneurs who have already carried out business, which also marks the start-up enterprises begin to enter the formal operation period.

At present, the governments in all over the world take technological innovation as the driving force of national economic growth, and universities as incubators to enhance national "capabilities". (Ruth Graham, 2014) Colleges and universities should build a more scientific and reasonable advanced teaching model of entrepreneurship education, accelerate the cultivation of innovative and entrepreneurial talents, and then provide strong talent support for social and economic development.

REFERENCES

- Drucker, P.E. (1986). *Innovation and Entrepreneurship*. New York: Harper and Row.
- Kevin, H. (2004). *Teaching entrepreneurship at university: from the wrong building to the right philosophy*. The 21st Annual Conference of the Canadian Council for Small Business & Entrepreneurship. University of Regina.
- Michael, H. M., et al. (2013). *Entrepreneurship Programs and the Modern University*. Edward Elgar Pub.
- Moore, J. (1993). *Predators and prey: a new ecology of competition*. *Harvard Business Review* 71, 75-86.



Moore, J.F. (1996). The death of competition: leadership and strategy in the age of business ecosystems. Harper Paperbacks.

Robert F. S., et al. (1989). Role Model Performance Effects on Development of Entrepreneurial Career Preference. Entrepreneurship: Theory & Practice 13.3: 53-71.

Ruth Graham. (2014). Creating university-based entrepreneurial ecosystems - evidence from emerging world leaders. MIT Skoltech Initiative.

AUTHOR INFORMATION

Lihui Xu, xulihui@tsinghua.edu.cn, China, International Center for Engineering Education, Tsinghua University (corresponding author)

Pan Zhu, zhupan@tsinghua.edu.cn, China, International Center for Engineering Education, Tsinghua University



PBL APPLIED TO FIELDWORK CLASSES OF ZOOLOGY

Vinina Silva Ferreira & Patricia Luiza de Oliveira-Reboucas

ABSTRACT

We used the PBL method to improve the teaching and learning of the Protostomes discipline in the fieldwork classes from 2010 to 2020. This discipline is offered at the 2^o year of the undergraduate course of Biological Sciences at Universidade Federal do Vale do São Francisco, Brazil. Protostomes study the ecology, morphology, and phylogeny of some invertebrate animals, such as crustaceans, molluscs, insects, and worms. During the field activities, students traveled to the coast to study protostomes from rocky shore and Restinga ecosystems. At study local, the students in groups of four or five were encouraged to ask and to answer questions and solve problems on the animals visualised by the naked eye. Also, they designed an experimental model to collect by traps some samples of protostomes, which were identified for them. Students also were stimulated to build or adapt a collect trap useful to study and conservation of protostomes. After the fieldwork class, the students did a presentation explaining their questions and problems. To evaluate this fieldwork class, we applied an online test and 37 students responded. They considered that PBL was better than the traditional method because it increased their learning and motivation in the fieldwork classes.

KEYWORDS: Protostomes, Biological Sciences, Parque das Dunas

TYPE OF CONTRIBUTION: Practice-based abstract

PRESENTATION FORMAT: Experience demonstration

The author has chosen not to have their full abstract published in the conference proceedings. We encourage you to look for existing or future publications by this author in other outlets.

AUTHOR INFORMATION

Vinina Ferreira, vininasf@gmail.com, Brazil, Universidade Federal do Vale do São Francisco (corresponding author)

Patricia Reboucas, patlu13@gmail.com, Brazil, Universidade do Estado da Bahia (corresponding author)



REFLECTION ON HOW TO GUIDE STUDENTS TO RETURN TO VALUE IN TEACHING: A CASE STUDY OF PBL-BASED CONSTRUCTION FESTIVAL

Kaizhen Jia, Xiaohui Li, Bo Yan, Furong Gao & Jing Xiao

ABSTRACT

The Construction Festival is one of the basic design courses for all freshmen of School of Architecture and Urban Planning, Chongqing University. It is a teaching demonstration project that combines design theory with on-site construction practice, which is opened to the public, welcoming all teachers and students, surrounding communities, enterprise organizations (see Figure 1). As a comprehensive practical teaching activity, this course integrates teaching, competition, public participation, social events and festivals. It has been exploring changes and improvements in materials, personnel composition, organization mode, etc. ever since 2013. And it has gradually developed from a course practice into a challenging and enthusiastic competitive social activity with primary school group, middle school group and university group engaged. The whole project consists of four parts, namely assignment, development, preparation and Construction. In the end, the course requires students to use real building materials for outdoor on-site construction within a certain time limit (usually 8 hours in a row) and requires the built space to be able to overcome the influence of self-weight, self-deformation and external force, and to provide stable, reliable and communication space for people within a predetermined time period. Details of teaching links, task requirements, teaching methods, etc. are shown in fig. 2. During the development of the program, regular teaching seminars on curriculum improvement and teaching methods were hold. Core concepts, such as "problem-oriented", "project-based platform integrating teaching and learning capital", "student-focused" and "return to value" have been studied. This research aims to explore at the teaching observation and thinking after the improvement of PBL-based curriculum.

KEYWORDS: Construction festival, PBL, Teaching observation and thinking, return to value

TYPE OF CONTRIBUTION: Practice-based abstract

PRESENTATION FORMAT: Experience demonstration

The authors have chosen not to have their full abstract published in the conference proceedings. We encourage you to look for existing or future publications by these authors in other outlets.



AUTHOR INFORMATION

Kaizhen Jia, 190266087@qq.com, China, Chongqing University (corresponding author)

Xiaohui Li, lilyxiaohui@cqu.edu.cn, China, Chongqing University (corresponding author)

Bo Yan, 375037414@qq.com, China, Chongqing University

Furong Gao, 86380710@qq.com, China, Chongqing University

Jing Xiao, xjarch@cqu.edu.cn, China, Chongqing University



COURSE IN TRANSFUSION MEDICINE WITH A PEDAGOGICAL APPROACH TO PROBLEM-BASED LEARNING

Victor Dueñas

ABSTRACT

The implementation of the pedagogical approach to problem-based learning (BPL) is presented in a course offered to students of Bacteriology and Clinical Laboratory at Universidad del Valle, Cali, Colombia. The course is offered to three groups of students, each consisting of 10 students in an academic period of 18 weeks.

The Transfusion Medicine course (axes I and II) is the result of the integration of two subjects that were offered under the traditional behavioral approach in the Academic Program of Bacteriology and Clinical Laboratory and is the product of numerous transformations as a result of evaluations and observations of students as main actors in the teaching-learning process.

The subjects that were integrated were Clinical Immunohematology and Health Services Administration, for this it was necessary to rethink the entire structure of the courses, so that from the elaboration of problem axes and objects of study, the most relevant and basic aspects of Both disciplines. The result at present is a course that allows, through problematic axes and objects of study, that the student appropriates administrative and technical scientific concepts of transfusion medicine, making it clear that in order to appropriate these concepts, the different social, economic, cultural, legal, ethical and scientific aspects of both disciplines.

KEYWORDS: Transfusion medicine, BPL in higher education, BPL in health sciences

TYPE OF CONTRIBUTION: Practice-based abstract

PRESENTATION FORMAT: Experience demonstration

PRESENTATION

The implementation of the pedagogical approach to problem-based learning (BPL) is presented in a course offered to students of Bacteriology and Clinical Laboratory at Universidad del Valle, Cali, Colombia. The course is offered to three groups of students, each consisting of 10 students in an academic period of 18 weeks.



The Transfusion Medicine course (axes I and II) is the result of the integration of two subjects that were offered under the traditional behavioral approach in the Academic Program of Bacteriology and Clinical Laboratory and is the product of numerous transformations as a result of evaluations and observations of students as main actors in the teaching-learning process.

The subjects that were integrated were Clinical Immunohematology and Health Services Administration, for this it was necessary to rethink the entire structure of the courses, so that from the elaboration of problem axes and objects of study, the most relevant and basic aspects of Both disciplines.

The result at present is a course that allows, through problematic axes and objects of study, that the student appropriates administrative and technical scientific concepts of transfusion medicine, making it clear that in order to appropriate these concepts, the different social, economic, cultural, legal, ethical and scientific aspects of both disciplines.

The approach through the pedagogical approach to learning based on problems, projects, processes, people and the person (BPL5), in which the student is an active part, allows knowledge to be acquired in a more participatory and more relevant way, On the other hand, it allows tutors to permanently evaluate interpretative, argumentative and propositive competencies in students.

The problem-based learning approach integrates tools of information and communication technologies (ICT) to favor the learning process.

For the development of the course a website has been created that provides all the necessary information to the student: <https://sites.google.com/correounivalle.edu.co/inmunohematologia/inicio>

DESCRIPTION OF THE COURSE DEVELOPMENT

Moment 1: Induction

In the first session the presentation of the students, the tutor and the course is made, emphasizing the pedagogical approach to problem-based learning that will be used and a course start evaluation is carried out to value previous knowledge and characteristics of students.

Moment 2: Individual definition of learning needs

In this phase the students, in independent time; they observe the problem axis and relate it to the proposed objects of study. Based on this, they proceed to:

- Arguing the problem or problems, who are affected by the situation and the relevance of the problem in the local, national and international context.



- Define unknown terminology or ambiguous aspects that prevent you from understanding the problem.
- Identify learning needs. This is achieved through the approach of a general learning objective and specific objectives.
- Ask guiding questions that respond to those goals. The questions are categorized into four dimensions: a) the socio-economic dimension that includes questions related to social, cultural, economic, normative, political and legal issues; b) the behavioral psychological dimension that includes questions related to the ethical, aesthetic, attitudes and aptitudes and competences of being; c) the biological dimension that has to do with explanations of the principles and foundations of biological processes, the fundamentals of laboratory tests and in general with the scientific technical processes of evidence-based transfusion medicine; and d) the dimension of competencies that allows students to identify, according to the social division of work, which competences they must gain related to knowledge and know-how.

This individual work is published by the student in his digital academic portfolio.

Moment 3: Proposal for a collective work agenda

At this stage, students socialize their individual work and negotiate among them, in the classroom, a general objective, specific objectives and guiding questions for the group. In this way, it is passed from a personal interest to a collective and collaborative one as the students elaborate a work agenda for the problem axis with which they commit.

The collective work agenda is published in the digital portfolio of the course.

Moment 4: Discussion and conclusions in the tutorial

Sessions Four tutorial discussion sessions are assigned for each problem axis. In these sessions, students discuss and answer the different questions posed in the collective agenda and generate new questions that are added to the agenda. In these discussion sessions, the tutor can clarify and motivate student participation through justifying, amplifying or hypothetizing questions.

Each discussion session includes student self-assessment through a structured online format. In the same way, the tutor evaluates the students in each session through a tool called a field notebook in which they record the participation of the students and their quality, as well as other significant aspects that occur in the classroom.



At the end of the discussion sessions scheduled for each problem axis, conclusions are drawn about what has been learned, the difficulties that were experienced in the development of the axis are evaluated, and a basic knowledge assessment workshop is held.

COMPREHENSIVE EVALUATION OF THE COURSE

The course includes the following aspects of evaluation that are carried out through structured online formats:

- Evaluation of the beginning of the course: in which characteristics of students such as expectations of the course and the BPL pedagogical approach are explored, as well as as proficiency in the management of ICT tools and the availability of electronic support equipment among other aspects.
- Self-assessment: each student self-evaluates five aspects: a) academic preparation; b) participation; c) communication skills; d) comprehension of the issues and e) punctuality.
- Evaluation of the pedagogical approach, of the course and of the tutor: through two instruments, one institutional of the University and another of the course itself, the course, the pedagogical approach used, the tutor and the students are evaluated. These formats are online and are internal to the University.
- Evaluation by the tutor: the tutor evaluates the students in the following aspects: a) publication of the digital portfolio for which there is a rubric and work guide; b) permanent monitoring of student work through the field notebook tool; c) knowledge assessment workshops at the end of each axis and d) a final exam.

FINAL ANNOTATION

For several years, the course has been offered and evaluated, the following results or assessments have been obtained from the students in relation to the development of the problem-based learning approach. The results presented here correspond to the response of 159 students:

- 89.9% of the students believe that the BPL approach allowed them to improve their communication skills.
- 92% believe that the BPL approach stimulated their participation in the discussions.
- 91% report that the BPL approach permanently stimulates the identification of learning needs.
- 95% believe that the ABP approach allows them to legitimize their peers as subjects from which they can learn.
- 96% believe that the BPL approach contributes to the integration of content for the best understanding of problems.



- 91% believe that the BPL approach stimulates learning to learn by giving autonomy to the student.
- 94% state that the BPL approach allows improving their search and information synthesis skills.

These results together with other aspects evaluated can be presented in more detail if this paper is accepted.

AUTHOR INFORMATION

Victor Dueñas, victor.duenas@correounivalle.edu.co, Colombia, Universidad del Valle, (corresponding author)



CO-CREATION KNOWLEDGE FOR THE WORLD – IMPROVING EMPLOYABILITY FOR STUDENTS THROUGH CO-CREATION AND EXTERNAL COLLABORATION

Vibeke Andersson & Helene Balslev Clausen

ABSTRACT

This paper reflects experiences and discussions we had we had after having been working with student's external partners through a semester. During this semester, students were expected to collaborate with a company or an organization to solve a task set by the company. They pitched their solution to the task at the exam as a part of the evaluation of the semester. The students had to use their academic and analytical skills and competences as a part of working with the 'product' (pitch and report), which they had to deliver to their collaboration partners. This means that the students were aware of the competences they used. The collaboration with companies and organizations formed, at the same time, part of and were integrated in the courses taught during the semester; the theories, concepts and themes, we presented in our teaching could be used by the students in their collaboration with the companies both practically and theoretically.

KEYWORDS: Co-creation, employability, external partners, PBL, competences

TYPE OF CONTRIBUTION: Practice-based abstract

PRESENTATION FORMAT: Experience demonstration

The authors have chosen not to have their full abstract published in the conference proceedings. We encourage you to look for existing or future publications by these authors in other outlets.

AUTHOR INFORMATION

Vibeke Andersson, van@cgs.aau.dk, Denmark, Aalborg University, (corresponding author)

Helene Balslev Clausen, balslev@hum.aau.dk, Denmark, Aalborg University, (corresponding author)



CROSS-EDUCATIONAL COLLABORATION ON CASE DIDACTICS

Stine Bylin Bundgaard & Diana Stentoft

ABSTRACT

This article explores how case-PBL was transformed and brought into education of Social Workers in a university college. The article presents the process of adaptation and the initial collaboration between Centre for Health Science Education, Aalborg University (AAU) and Social Work, University College of Northern Jutland (UCN). The aim of this collaboration was to develop a structural and didactical framework for case-PBL related to the field of Social Workers based on the case-PBL as used in medical education. At present the first phase of the process is completed focusing on the first-year students in Social Work. The theoretical underpinnings and conception of case is in this article studied as a frame in which the students collaboratively and self-directed can develop analytical skills to grasp real-life contexts within their field of study. Case is seen as a fundament based on which the students can discuss and reflect upon real-life problems in an educational setting, and as a room where the student can reflect and combine theory with practise.

KEYWORDS: Case-PBL, Experiential learning, Case didactic, Reflective practise-based learning

TYPE OF CONTRIBUTION: Extended scientific abstract

PRESENTATION FORMAT: Interactive poster presentation

INTRODUCTION

The close connection between theory and practise is one of the main principles of the learning approach at UCN labelled Reflective Practise-based learning (RPL), and central to the education of Social Workers.

Throughout the first year of the education, students are introduced to the complexity of the field, including academic strategies such as analytical and reflective skills to apply theoretical perspectives real-life scenarios of the Social Worker.

One way of creating reflective learning spaces is through work with cases and PBL inspired by the approach found in many medical educations. Following research in into case-PBL, we initiated a collaboration with Centre for Health Science Education and PBL at Aalborg University, to draw their experience with case-PBL and experiential learning (Stentoft, 2019). The aim of the collaboration was to uncover experience from the health sciences and to inspire educators in Social Work to develop a systematic case approach suitable in Social Work education. The point of departure was a need for an educational approach which would support



students' ability to analyse, reflect and engage in "real-life" challenges and to understand theory with practise.

EXPERIENTIAL LEARNING

The learning approach is based on experiential learning theory leaning on Kolb's definition, that learning is "the process whereby knowledge is created through the transformation of experience. Knowledge results from the combination of grasping and transforming experience." (Kolb 1984, p. 41). Experience is essential in this position, as is how experience transforms into knowledge by reflection (Dewey 1933). The learning process is here seen as responsive to the situation and reflection on the experience is seen as a strategy enabling the interplay between theory and practise in order to qualify thinking and acting.

In the following we will unfold case-PBL and how the approach was inspired by case-PBL in medicine.

CASE-DIDACTICS AS A PRACTISE-ORIENTED AND PROBLEM-BASED STRATEGY

In our efforts to adapt Case-PBL to Social Work education we see cases as accounts of real-life problems that can be studied through a strategy in research or education, and thereby – in the educational context - creating a learning space in which to develop methodological and analytical capabilities (Stake 2005). A case can be anything from a short, focused example that emphasizes an important point from real-life to a longer narrative that highlights the complexity and dilemmas that e.g. characterize social workers' or physicians' everyday practices.

Thus, our understanding of case is as a framework that allows students to study the complexity and particularity of real-life circumstances (Stake 1995; Simmons 2009; Thomas 2016). In addition to this, cases give an opportunity to systematize practice and bring it into an educational context as an object for research.

On this basis, we initially approached case-PBL as a problem-based way of working with cases originating within medical education (Schmidt, 1983). Case-PBL is a systematic approach to working with cases where the case provides the framework for learning usually lasting up to a week and where the case is designed by the teacher (Stentoft 2019). Through their step-by-step interaction with cases, the students enter into a professional analytical and reflective dialogue with a facilitator and co-students about the needs for learning and the theoretical and practical knowledge necessary to comprehensively address the case (Wood, 2003).

CASE-PBL FROM A REFLECTIVE PERSPECTIVE WITHIN SOCIAL WORK

Throughout the collaboration it has been important to develop a case-didactic related to the field of social work, that can support the formation of practitioners who can navigate within a complex relation based practice. The work with case-PBL on the first semester offers a way of scaffolding experiential learning and developing and practising analytical skills, that allows the students at a later stage in the education to



construct their own cases in their own work with professional dilemmas. Thus, the ambition is to create a steppingstone for developing sustainable reflective practitioners (Schön 1983).

Discussions on how to use Case-PBL in a University College-setting revealed the importance of the cases being constructed on present and relevant professional dilemmas, that can open a discussion with specific theoretical perspectives. This should support the student-centred learning process by motivate and activate the students to analyse practise from a specific point of view and in a systematic manner. In this activity, exploration of the case leads the student to initiate own learning and to collaborate with co-students on analysing and discussing possible action, that can contribute addressing the case.

Based on this and the experiences of case-PBL in medical education, the following principles for where developed for case-didactics in Social Work education:

- Professional nearness
- Motivation and student activity
- The students initiate their own learning and contributes to the collaborative learning process
- Guided by teachers and facilitators and through specific structures for learning
- Encourage critical reflection and action

The last point highlights the need for learning how to reflect critically on a case, and here it is found necessary to scaffold critical reflection by using analytical models. Our focus was here drawn to Tønnesvang, Hedegaard & Nygaard's Quadrant model, which assists the students to focus on a specific phenomenon – or in Social Work – a specific person (Tønnesvang, Hedegaard & Nygaard 2015). To support the critical thinking, the model is followed by reflective questions built on the SOLO taxonomy and the ability of reflecting on a complex level.

- Goal: Identify and explain a subject relevant challenge of the case.
 - *Which challenges are described in the case? Which one do you find interesting to work on?*
- Goal: Analyse and asses the challenge with relevant research, theory and data.
 - *Which preunderstandings do you have on the challenge? Which relevant knowledge can contribute to greater understanding of the challenge? How can this knowledge contribute to analyse and discuss different understandings of the challenge?*
- Goal: Develop relevant, pedagogical actions that relates to the learning goal of the course.



- *Which actions does your analysis call of? Which do you prefer?*

The questions support, qualifies and guides the student's reflection on the case, and prepare them for the case-based examine. These questions might seem too controlling and steering the reflection, but at the first semester of Social Work, the students presumption for critical reflection differs, and leaves a need of scaffolding how to open up the case and relate it to a complex theoretic field where argumentation are to be thought.

The collaboration between the educations has not ended, and this paper highlight the most essential parts of the great work translating experience of working with case-PBL as a base for combining theory and practise and training critical reflection.

REFERENCES:

Bjerregaard, Mark, Nistrup (2014) Case - Hvordan bruges case i undervisningen? VIA University College

Dewey, J. (1933). *How we think: a restatement of the relation of reflective thinking to the educative process.* Boston: Heath.

Horn, Line H.; Jensen, Camilla G.; Kjærgaard, Thomas; Lukassen, Niels B.; Sørensen, Ingrid Maria; Valbak-Andersen, Camilla, Bundgaard, Stine B. (2020): *White Book on Reflective Practise- based Learning*, Peer-reviewed policy paper, UCN

James, W. (1904). *The pragmatic method.* *The Journal of Philosophy, Psychology and Scientific Methods*, 1(25), 673–687.

Kolb, D. (1984). *Experiential learning: Experience as a source of learning and development.* Upper Saddle River, NJ: Prentice Hall.

Pettersen, Roar C: *Problembaseret læring*, Dafolo A/S 1999.

Rokkjær, Å. & Højberg, K. (2009). *CASEstudier i profession og uddannelse*, VIA Forlag.

Schön, D. (1983). *The Reflective Practitioner: How Professionals Think In Action.* New York: Basic Books

Simmons, Helen (2009): *Case Study Research in Practice*, Sage Stake, R.E. (1995): *The Art of Case Study Research*, Sage

Stake, R. E. (2005): *Qualitative Case Studies*, in N. K. Denzin & Y.S. Lincoln (eds.): *The Sage Handbook of Qualitative Research*, 3rd edition, Sage



Stentoft, Diana (2019): Problem-based projects in medical education: extending PBL-practices and broadening learning perspectives, in: Advantages in Health Sciences Education, Springer

Thomas, Gary (2016): How to do your case study, 2nd edition, London, Sage Tønnesvang, Hedegaard &

Nygaard (2015): Kvadrant-modellen, KLIM

Schmidt, H. G. (1983). Problem-based learning: Rationale and description. *Medical Education*, 17(1), 11–16.

Wood, D. F. (2003). ABC of learning and teaching in medicine—Problem based learning. *British Medical Journal*, 326, 328–330.

AUTHOR INFORMATION

Stine Bylin Bundgaard, sib@ucn.dk, Denmark, UCN (corresponding author)

Diana Stentoft, stentoft@hst.aau.dk, Denmark, Aalborg University (corresponding author)



FROM BULLYING TO SOLIDARITY - THE PBL AS A PILLAR OF CITIZENSHIP

Luis A. G. Fernandes & Dulce H. Soares

ABSTRACT

This work presents the description of an activity developed in the discipline Methods for Knowledge Production, which addresses the teaching of research methodologies and academic works. It focuses on the use of active methodologies, specifically project-based learning. The project developed by the author with students in the first semester of the Phonographic Production Technology course is the realization of a show presenting songs to the residents of a nursing home when the material collected by all the freshmen of the institution is delivered in a Solidarity Hazing. This activity allows for the realization of the project as an experimental activity requiring the integration of the various groups formed in the classroom, as well as the development of each part of an academic work, bringing very positive results mainly in relation to reducing school dropout.

KEYWORDS: Active methodologies, project-based learning, dropout in higher education

TYPE OF CONTRIBUTION: Practice-based abstract

PRESENTATION FORMAT: Interactive poster presentation

FROM BULLYING TO SOLIDARITY - THE PBL AS A PILLAR OF CITIZENSHIP

Looking for alternative ways to enrich activity in the classroom demands more and more from the teacher, pressured by the high dropout rates in higher education, as cited Pereira (2003). Educating for a culture of peace is a kind of Education of Values and must be performed from and to action, according to Jares (2004). Active methodologies can prove to be an interesting tool This work highlights the use of project-based learning, PBL, for disciplines as Scientific Work Methodology, SWM. The concern in teaching-learning approach to motivate the generation Z, which reaches classrooms in higher education, was addressed by Ezenwabasili (2016):

"A colleague from a university in Spain told me something interesting: 'Today, at our university, young people do not come to study. They come to work, have an experience in making and building things. Learning and reflection are consequences of that '. In other words, the university has to offer other forms of teaching so that these students can learn more and better. " (p. 1)



In the Phonographic Production course syllabus, SWM presents the types of academic works, to the students in the first semester. Thus, this article presents the dynamics of developing experimental work, using PBL, with the following initial challenges: 1. The first semester has historically received criticism for being too theoretical, demotivational, causing possible school's dropouts due to the student having little contact with practical activities; 2. Practical activities may need prior theoretical knowledge so that they can be developed by students; 3. To change the negative practice of hazing, which is any conduct or method of initiation that may willfully or recklessly endanger the physical or mental health of any student or other person, in order to promote citizenship, empathy and solidarity.

One concern was to resolve the issue of hazing in college, as it is a bullying action, which, according to Chaves and Souza (2018), is an aggressive intentional behavior, usually when there is an imbalance in the power relationship. This is a recurrent fact when the student enters the college and is cornered by seniors and subjected to humiliating actions.

ACTIVITIES CARRIED OUT

The proposal includes the PBL methodology, with the creation of two main blocks. The first one is the group of musicians who must organize themselves to form three to five groups for musical performances during the event. The second block is the executive production which should make the musical event at the chosen location feasible and of quality.

Issues such as the success of the event, promoting the happiness of those assisted by the visited institution, integration among students and a better knowledge of the competences and skills the course intends to develop are always raised by the class. These results allow a reflection on how it would be possible to measure these parameters and assess whether they have been fully achieved. It is possible to work on the matter of presentation and discussion of results in experimental works focusing on recording the public reaction during the show, mainly the enthusiasm of the students' and the institution's staff. Moreover, the final interviews allow the impressions of the event to be taken from all those involved besides enabling the discussion about the success of an event. Regarding this aspect, the expected results normally listed are: the event must follow the schedule without delay, the quality of the sound and the repertoire of the songs must please the audience and ensure that socialization takes place among the students effectively, how they felt with the activity (as a person). These points affect all the students' activities. It is essential to define the repertoire, the instruments used in each song to finalize the event's schedule and set the stage. All these actions require integration among the groups in the pre-production phase of the event. The materials and methods class has become more attractive as it deals with an activity that all students have already performed. In the final stage of developing the written part of this experimental work each group needs to



show the results achieved by the other groups. As an example, the musicians have used the photos and videos of their performance besides the interviews to show how receptive the public was and that the executive production had met the scheduled period for the program. Figures 1 and 2 depict the 2015 and 2018 presentations.

Figure 1 (a) and (b). Solidarity Hazing 2015 (a) and 2018 (b) to the residents of São Vicente de Paula Home



Figure 2 (a) and (b). Interaction of students and teacher with residents and employees of SVP Home



The accounts presented here were collected by the freshmen from 2011 until 2018 and were translated by the authors: Question (Q): Did you expect a “hazing” like this? Response (R): “I’ve always been afraid of hazing in college. Our class got united and seeing the elderly so happy was great!”; (Q): How do you think the activity added to your knowledge concerning the course? (R): “I believe that it was a great opportunity for everyone to get a little experience in an event, from rehearsals, the exchange of experiences between everyone, especially in the difficulties faced”.

The following are the questions asked to the residents, caregivers: (Q): Does today's event bring positive results for the elderly? To what degree does this help their well-being? M., caregiver: (R): “The most expected event of the semester. For us and the elderly. It enhances the elderly's self-esteem for the simple reason that they were remembered”. C., 72 years old, resident: “Yes, music moves many memories, although some have hearing impairment. Yes, it helps a lot to break routine. I remembered the cinema (some movie tracks) and loved the decor. It would be good for more events like this for us”.

A special account about the Solidarity Hazing came from one of the students, P.R.: “I was thinking about dropping out of the course, as I was far from home and I didn't see anything in the first semester that justified



the decision I had made when choosing this profession. But when doing the Solidarity Hazing I realized that acting in executive production was exactly what I wanted to do with my life and I decided to stay in college." Another student, B. P., said that the solidarity action was "super life-changing" for she continued visiting the nursing home along with her classmate E. L. as observed by this professor/author when meeting them in a subsequent visit to the same nursing facility.

CONCLUDING REMARKS

This activity has enabled the participants to work on all the required issues in the presentation of an experimental work, being also important to the enthusiasm of the student towards the course since it develops the skills for all the phases of this activity within their professional career, albeit amateurishly.

The engagement of the classes in general after the execution of the Solidarity Hazing proved to be much greater than when the process of teaching used examples from experimental work carried out in previous semesters by other students of the course in final papers, however interesting the examples might have been. The commitment of those two students who visited the home on Sundays also demonstrates that good fruit has been harvested with this action. The process described in this article helps students to feel integrated and has also played an important role in tackling school's dropout, as shown in P. R.'s account as well as in the making of solidarity citizens like B. P. and E. L.

REFERENCES

Chaves, D. R. L., & De Souza, M. R. (2018). Bullying e preconceito: a atualidade da barbárie. *Revista Brasileira de Educação*, 23. <https://doi.org/10.1590/s1413-24782018230019>

Ezenwabasili, M. (2016). Como as diferentes gerações aprendem. 2016. <http://www.revistaensinosuperior.com.br/como-diferentes-geracoes-aprendem>

Pereira, F. C. B. (2003). Determinantes da evasão de alunos e os custos ocultos para as instituições de ensino superior: uma aplicação na Universidade do Extremo Sul Catarinense. <https://repositorio.ufsc.br/bitstream/handle/123456789/86403/198634.pdf?sequence=1&isAllowed=y>

AUTHOR INFORMATION

Luis Antonio Galhego Fernandes, galhegofernandes@hotmail.com, Brazil, FATEC Tatui - Centro Paula Souza (corresponding author)

Dulce Helena Soares, dulce.nova@fatec.sp.gov.br, Brazil, FATEC Tatui - Centro Paula Souza (corresponding author)



PROBLEM-BASED LEARNING AS THE FOUNDATION FOR A NEW UNDERGRADUATE PROGRAM IN AGRICULTURAL TECHNOLOGY

David S. Hik & Paul S. Kench

ABSTRACT

The development of sustainable and innovative solutions for food production are necessary to overcome shortages of arable land and water, degradation of ecosystems and the impacts of climate change. In British Columbia (Canada) the recent Provincial Food Security Task Force (2020) recommended implementing the UN SDGs across all agricultural policies, and prioritizing new investments in the right mix of skills, capital, technology and training to support the emerging agricultural (AgriTech) revolution. Meeting this opportunity necessitates rethinking our approach to education. Simon Fraser University (SFU) is in the process of developing and launching a new undergraduate degree in Agricultural Technology that is framed around the demands of the 'fourth agricultural revolution', and that harnesses the power of science, technology and big data to ensure that food production is more sustainable. Our plan is that this undergraduate program will embrace the best practices of PBL by building partnerships with primary producers, the food production industry, and other research and post-secondary educational organizations, to train the next generation of students to lead new innovations in the BC agricultural sector, and globally. We are interested in sharing our experience so far, and in learning from colleagues that are further along in the implementation of PBL pedagogies that have embraced the entire curriculum (not just individual courses), and that have integrated digital technologies across disciplines to support project-based learning. We are keen to learn about new hybrid PBL models, and to explore innovative PBL environments for engaging students in solving wicked real-world problems.

KEYWORDS: Agriculture, AgriTech, New Curriculum Design, Interdisciplinarity

TYPE OF CONTRIBUTION: Practice-based abstract

PRESENTATION FORMAT: Interactive poster presentation

FULL ABSTRACT

The development of sustainable and innovative solutions for food production are necessary to overcome shortages of arable land and water, degradation of ecosystems and the impacts of climate change. In British Columbia (Canada) the recent Provincial Food Security Task Force (2020) recommended implementing the



UN SDGs across all agricultural policies, and prioritizing new investments that support the development of new skills, capital, technology and training to support the emerging agricultural (Agritech) revolution.

Meeting this opportunity necessitates rethinking our approach to education, but in many ways agricultural education has been innovating with problem-based and experiential learning for several decades. Problem solving and critical thinking skills are among the most cited educational needs in curriculum revitalization efforts of colleges of agriculture and natural resource management the world over (Salvador et al. 1995). Indeed, significant alignment exists between the recommended pedagogy for improving student achievement and the teaching and learning exercised in many agricultural education classrooms (Parr and Edwards 2004; Wells et al. 2015), and problem-based learning has been recognized as a valuable strategy for use in programs designed to prepare students for careers that involve ill-structured problem solving (Conroy and Johnson 1999). Experiential learning also forces students to reflect on and generalize about their learning, thus making it more transferable (Estepp and Roberts 2011).

Simon Fraser University (SFU) is in the process of developing and launching a new undergraduate degree in Agricultural Technology that is framed around the demands of the ‘fourth agricultural revolution’, and that harnesses the power of science, technology and big data to ensure that food production is more sustainable. There is some concern that the skills shortage in the agriculture industry has been exacerbated by the failure of universities to keep pace in educating students in the latest Agritech systems and innovations (Cosby et al. 2017). Our plan is that our new undergraduate program will embrace the best practices of PBL by building partnerships with primary producers, the food production industry, and other research and post-secondary educational organizations, to train the next generation of students to lead new innovations in the BC agricultural sector, and globally. We are still in the early phases of program development but there are some good examples to learn from. For example, the SmartFarm Learning Hub in Australia hosts a variety of learning modules that aim to increase the skills capability and knowledge of students by engaging them directly with industry partners, and to the latest advances in Agritech to improve their employability (Cosby et al. 2017).

Our participation in the PBL2021 will provide a wonderful opportunity to interact with colleagues who have already developed successful PBL programs. We plan to share our current experiences in an interactive poster as a means of generating more ideas for our initiative. It will be useful to learn from colleagues that are further along in the implementation of PBL pedagogies that have embraced the entire curriculum (not just individual courses), and that have integrated digital technologies across disciplines to support project-based learning. We are keen to learn about new hybrid PBL models, and to explore innovative PBL environments for engaging students in solving wicked real-world problems.



REFERENCES

Conroy, C.A. & D. Johnson. (1999). Agriculture as a Rich Context for Teaching and Learning, and for Learning Mathematics and Science to Prepare for the Workforce of the 21st Century. *National Science Foundation Report*, Teaching and Learning Conference. 27 pp.

Cosby, A., Flavel, R., Botwright Acuña, T., Fasso, W., Gregory, S., & Trotter, M. (2017). Implementing a 'real industry technology learning systems' module in agronomy within higher education systems. *Proceedings of the 18th Australian Society of Agronomy Conference*, 24 – 28 September 2017, Ballarat, Australia. (<http://www.agronomyaustraliaproceedings.org/>)

Estep, C.M. & Roberts, T.G. (2011). A Model for Transforming the Undergraduate Learning Experience in Colleges of Agriculture. *NACTA Journal*, September 2011, pp 28-32.

Parr, B. & Edwards, M.C. (2004). Inquiry-based instruction in secondary agricultural education: Problem solving – an old friend revisited. *Journal of Agricultural Education*, 45, 106-117.

Salvador, R.J., Countryman, D.W. & Miller, B.E. (1995). Incorporating Problem-Based Experiential Teaching in the Agriculture Curriculum. *J. Nat. Resour. Life Sci. Educ.*, 24, 58- 63.

The Future of B.C.'s Food System. 2020. <https://engage.gov.bc.ca/app/uploads/sites/121/2020/01/FSTF-Report-2020-The-Future-of-Food.pdf>

Wells, T., Matthews, J., Caudle, L., Lunceford, C., Clement, B., & Anderson, R. (2015). The Infusion of Inquiry-based Learning into School-based Agricultural Education: A Review of Literature. *Journal of Agricultural Education*, 56(4), 169 -181.

AUTHOR INFORMATION

David Hik, dhik@sfu.ca, Canada, Simon Fraser University (corresponding author)

Paul Kench, paul_kench@sfu.ca, Canada, Simon Fraser University



THE CONSTRUCTIVE ALIGNMENT IN A CIVIL ENGINEERING CAPSTONE PROJECT PBL 2020

Maria Patricia León Neira, Carola Hernández Hernández & Sofia Andrade Pardo

ABSTRACT

Currently, it is required to have curricular spaces for development and evaluation of the education through competencies. That is why the civil engineering curriculum of the Pontificia Universidad Javeriana proposes that, in the last semesters students must develop a project in two courses that follow the PBL-PO methodology.

In this curriculum space, teams of students use the disciplinary and non-disciplinary learning, that were developed during the other courses of the curriculum, to conceptualize and design an infrastructure project that allows an approach from different areas of civil engineering.

The ambiguities between what was assessed in the course and what the student was intended to develop led to carry out a teaching design, in accordance with the constructive alignment proposed by Biggs (1999). The alignment had as inputs: the technical requirements of the design project, the outcomes of the previous courses, the opinions of the professors and previous interviews with students. As a result of this alignment, new rubrics were proposed.

At the end of the second semester of 2019, the coordinator collected the students' perspectives about the course through a survey. The students positively assessed the objectivity of the evaluation using these rubrics. As a critical aspect, the students expressed the importance of having the rubrics well in advance of the due date. They also expressed the need to adjust the terms of reference to what was requested in the evaluation. The training and consolidation of a group of teachers aligned with the methodology was the last good result.

KEYWORDS: PBL-PO, Capstone Project, Engineering, Constructive alignment, Evaluation

TYPE OF CONTRIBUTION: Practice-based abstract

PRESENTATION FORMAT: Interactive poster presentation

The PO-PBL curriculum works with disciplinary content and competences; examples of competences include learning to learn, group work, define and delimit complex problems, use different resources and theories to propose a solution, and critical thinking (Hernandez, C., Ravn, O., & Valero, P., 2015). In this sense, it is



important for higher education pedagogy to improve its understanding of the learning process because this practice has shown an effective way of introducing and implementing an education suited to current social and economic demands.

Currently, it is required to have curricular spaces for development and evaluation of the education through competencies. That is why the civil engineering curriculum of the Pontificia Universidad Javeriana (Bogotá, Colombia) proposes that, in the last semesters students must develop a project in two courses that follow the PBL-PO methodology.

In this curriculum space, teams of 5 or 6 students use the disciplinary and non-disciplinary learning, that were developed during the other courses of the curriculum, to conceptualize and design an infrastructure project that allows an approach from different areas of civil engineering. For example, buildings, docks, roads, bridges, linear infrastructure works have been developed.

A professor, who functions as general coordinator of the course, presents the engineering requirements of the project. He/she is also responsible for coordinating expert professors in each area involved in the project. Together with this team, it defines the tools for evaluating the course. The professors of each area of the project (preferably designers in the consultancy sector) meet weekly for 2 hours with the students, to review and guide the students' progress based on the requirements initially set.

This document shows the experience of the first capstone project course. The conceptualization and evaluation of design alternatives are carried out in this class. The teamwork challenge is that, each student has to conceptualize the solution of one of the engineering areas related to the problem, and then, the whole team has to put together the individual solutions in order to obtain the general solution to the engineering problem. The solution presented by each student must take into account the context constraints and the inter-restrictions posed by the other areas. Therefore, the solution problem must include all civil engineering areas, which means, teamwork, self-management skills development, assertive communication, autonomous learning, in addition to the necessary skills to show a technically supported solution to the problem. The course has been implemented since the second semester of 2015. The definition of the evaluation criteria has been the subject of intervention and has been evolving since this year. Initially, the grade was associated with the deliverables. The professor and an external pair evaluated the process. Still, the evaluation was associated with the deliverables, and the evaluation criteria were not defined in terms of rubrics. Each professor assessed with their own technical standards, which in many cases could differ from one professor to another. This led to the students being dissatisfied with the evaluation of the project. However, the type of learning experience they found was enormously significant.



From the first semester of 2017, attempts were made to incorporate more elaborate evaluation criteria to generate an aligned evaluation. Figure 1 presents an example of the rubric developed in that first attempt that, as can be seen, still has as weakness the ambiguity of the criteria for evaluating complex processes of engineering design. It was limited to indicating the deliverables, and in this way, the evaluation carried out by the professor remained subjective. Deliverables were clarified for the student, but not conceptual elements that would be evaluated. There were confusions at the time of the evaluation, during the use of this rubric. How the rubric was written allows the student to present information that led him to be in two performances (e.g., High proficiency and Unsatisfactory) simultaneously.

Figure 1. Rubric example 2017.

Pavement area	
Performance Indicator	Description
Highly proficient	It is presented the climatic characterization of the area of influence of the project with minimum histogram content of multi-year average rainfall. Locate the courses that cross the road axis. Perform a complete geomorphological analysis to identify stability.
Satisfactory	It presents the criteria shown in "High Proficiency", not including some main requirements, being a partial design.
Developing	It presents the criteria shown in "High Proficiency", regardless of the main requirements: Important deficiencies are identified
Unsatisfactory	Poor design

The ambiguities between what was assessed in the course and what the student was intended to develop led to carry out a teaching design, in accordance with the constructive alignment proposed by Biggs (1999). In this alignment, the competences that students develop in the project were clearly defined and professors were accompanied to design pedagogical strategies that make students engage with the learning activities proposed in a way that optimizes their opportunities to achieve desired skills.

The alignment had as inputs: the technical requirements of the design project, the outcomes of the previous courses, the opinions of the professors and previous interviews with students. As a result of this alignment, new rubrics were proposed (see example Figure 2). Those rubrics allow us to account for the degree to which the student develops a competence and guide the teaching process.



Figure 2. Rubric example after teaching design 2019.

Task	High proficient	Developing	Unsatisfactory
Presentation of primary information collected in field data and site visit. It must include the description of the visit, the analysis of the surveys and the photographic record of the visit.	Analyze the primary information of the project collected in the field and technically support its relationship with the project.	Analyze the primary information of the project collected in the field without a technical support of its relationship with the project	It presents the primary information of the project collected in the field with an analysis based on wrong technical support or an analysis is not done.

CONCLUSIONS ON THE INTERVENTION AND ASPECTS OF IMPROVEMENT IDENTIFIED

The development of the rubric associated with the building project is an essential advance for the course. The rubric aligns the expected results in the project and the contributions of each of the engineering areas addressed.

At the end of the second semester of 2019, the coordinator collected the students' perspectives about the course through a survey; 47 of the 72 students who took the course answered it. This survey showed the inconveniences that were raised in the diagnosis. The students expressed that although the project was oriented to a conventional and straightforward structure, gave them context elements that they had not considered at other times in their career. And, positively assessed the objectivity of the evaluation using these rubrics. As a critical aspect, the students expressed the importance of having the rubrics well in advance of the due date. They also expressed the need to adjust the terms of reference to what was requested in the evaluation.

The professors' perspectives were collected in informal talking. They identified that the use of the rubric allowed the students to demonstrate the depth of their conceptual management in the different areas of the project. There is a significant result because the success of the project orientation is in these consultants outside the university.

Finally, the training and consolidation of a group of teachers aligned with the methodology was the last good result. These teachers can support future projects as area coordinators, guaranteeing alignment between the proposed activities, what the student is expected to develop, and how to measure it.



REFERENCES

Hernandez, C., Ravn, O., & Valero, P. (2015). The Aalborg University PO-PBL Model from a Socio-Cultural Learning Perspective. *Journal of Problem Based Learning in Higher Education*, 3(2), 16–36.

John Biggs (1999) *What the Student Does: teaching for enhanced learning*, *Higher Education Research & Development*, 18:1, 57-75.

AUTHOR INFORMATION

Maria Patricia Leon Neira, mpleon@javeriana.edu.co, Colombia, Pontificia Universidad Javeriana (corresponding author)

Carola Hernández Hernández, c-hernan@uniandes.edu.co, Colombia, Universidad de los Andes (corresponding author)

Sofia Andrae Pardo, sofia.andrae@javeriana.edu.co, Colombia, Pontificia Universidad Javeriana (corresponding author)



PBL AND DISASTER - REGENERATION BY STUDENTS AND LOCAL RESIDENTS OF A HISTORIC REDBRICK WAREHOUSE DAMAGED IN THE 2016 KUMAMOTO EARTHQUAKES

Setsuko Isoda, Manabu Moriyama, Sadayuki Shimoda & Michiko Ito

ABSTRACT

Disasters are unfortunate events, but various issues during arising the recovery can be highly effective from an educational viewpoint. In a tense situation following a natural disaster, students are presented with an “unstructured and unavoidable problem” to raise the level of motivation and maintain concentration. This paper discusses one concrete example of PBL in an unclear situation. Kumamoto Earthquake (M 7.3) occurred in April 2016. One section of a red brick warehouse built in 1921 in Hinagu, Yatsushiro City collapsed in the disaster. Immediately after the earthquake, local residents, our college students and teachers held a series of meetings about dismantling or conservation of the warehouse. The students proposed several preservation plans to the meetings. The owner decided to dismantle the warehouse at public expenditure. The students continued proposing the preservation of the legacy of the old warehouse by using the dismantled bricks to create a pocket part. With the agreement of the owner, local residents and the city, the park was completed through the cooperation of the students and residents. Students kept motivation high for about 2 years, worked independently on the site, and were left with a deep impression after the project. Also, as an effect of the education, their development of competence including knowledge and the skill was confirmed. In addition, many local residents got involved, learned deeply, and a future-oriented community development seems to have been triggered. The tension existing in the area following a serious disaster made this PBL possible and fruitful.

KEYWORDS: Disaster, Kumamoto Earthquake, Motivation, Local Residents’ Cooperation, Regeneration

TYPE OF CONTRIBUTION: Practice-based abstract

PRESENTATION FORMAT: Interactive poster presentation

The authors have chosen not to have their full abstract published in the conference proceedings. We encourage you to look for existing or future publications by these authors in other outlets.



AUTHOR INFORMATION

Setsuko Isoda, isodas@kumamoto-nct.ac.jp, Japan, National Institute of Technology, Kumamoto College (corresponding author)

Manabu Moriyama, m-moriya@kumamoto-nct.ac.jp, Japan, National Institute of Technology, Kumamoto College (corresponding author)

Sadayuki Shimoda, shimo@kumamoto-nct.ac.jp, Japan, National Institute of Technology, Kumamoto College (corresponding author)

Michiko Ito, minto@tcu.ac.jp, Japan, Tokyo City University (corresponding author)



A PROJECT-BASED LEARNING APPROACH IN THE COURSE OF “ENGINEERING SKILLS” FOR UNDERGRADUATE ENGINEERING

Armin Eilaghi, Fadi Alkhatib, Hayder Abdul-Razzak & Martin Jaeger

ABSTRACT

A summary of experiences, recommendations, and lessons learnt in the application of project based learning (PBL) in the course of “Engineering Skills” in the School of Engineering at our institution is presented. Twenty four students were grouped in 6 teams to develop their skills in 10 learning outcomes. The learning outcomes targeted skills such as drawing, design, modeling, manufacturing and analysis at a preliminary level; and also some lifelong learning and teamwork skills as these students were exposed for the first time to the PBL. The students were assessed for 10 learning outcomes of the course and students’ feedback was collected using an anonymous survey at the end of the semester. 67% of students preferred multiple smaller projects than a single big project because they provide students with more time and attention focus to improve their “soft skills” including project management, risk assessment, and failure analysis. Moreover, it is found that 63% of students preferred to work with different team members during the course to improve their professional communication skills. Among all, 62% of students believed that working with team members from other departments helped them to increase the innovative aspect of projects and improved their overall performance. However, 70% of students counted extra time needed to regenerate momentum with the new teams as the major challenge. Project based learning provided a suitable platform for introducing students to professional engineering practice and meeting the needs of students, employers and educators.

KEYWORDS: PBL, Engineering Skills, Undergraduate Engineering Education, Student Feedback

TYPE OF CONTRIBUTION: Practice-based abstract

PRESENTATION FORMAT: Interactive poster presentation

INTRODUCTION

The concept of problem/project based learning (PBL) was probably initiated from McMaster University (De Graaff & Kolmos, 2007) although the idea was applied in nursery schools, medical sectors, and other areas earlier (Schweinhart & Weikart, 1997; Van der Vleuten et al., 1991; Sang, 2001; Schmidt, 1993). The acronym PBL was later extended to “Project Based Learning” in engineering discipline (De Graaff & Bouhuijs, 1993; De Graaff et al., 2006). A PBL facilitator guide was developed for consistency of delivery in all PBL units presented



(Jaeger, 2017) with the aim to shift the instructor task from general lecturing to facilitating problem-solving activities (Jaeger & Adair, 2015; Jaeger, 2017).

In the “Engineering Skills” PBL unit, students are introduced to the role of professional engineers as mediators between the technical, businesses, social, cultural, environmental, economic and political contexts of engineering activities. They investigate and select materials and processes for engineering applications and justify decisions made. Students apply information literacy skills and information technology skills to engineering projects. They use drawing, modeling and simulation tools to analyze and present project outcomes. They apply risk assessment and workplace health and safety assessment to engineering activities. Also they design, conduct and report on practical and hands-on activities.

Students explore the complex nature of engineering activities and the need to deal with uncertainty and conflicting information. They prepare a portfolio to demonstrate development of a professional attitude, problem-solving skills, technical knowledge and productive work practices, and provide evidence of a professional capacity to communicate, and work and learn productively both individually and in teams. The learning outcomes are listed in Table 1.

METHODOLOGY

Students in the PBL unit were subjected to four projects during the spring semester 2017. Teams were randomly built at the beginning of each project including 4 members. The students had two sessions of two hours in classroom with the instructor (facilitator) and one session of two hours in the computer lab with the teaching assistant on a weekly basis. In class sessions, various topics were covered to support the learning of students for about 20 minutes. Students carried out team work during the remaining time of the class sessions. During class sessions, students were received feedback (formative assessment) on their project work.

The projects given for the “Engineering Skills” PBL unit were as follow:

1. Technical drawing of an object;
2. Designing a dancing robot using provided kits with microcontroller;
3. Stress analysis and design of a cantilever beam modeling problem
4. Designing a water disinfection device using solar energy.

For each project, the first few sessions of the course were allocated to the planning phase while the remaining sessions were focused on implementation. Progress of students was monitored on a weekly basis. Meeting minutes and agenda of student teams were discussed during meetings with their facilitator. The entries to



the workbooks of students and reflective journals were monitored weekly by the facilitator. Other aspects of the course include:

1. Formal assessment in this course is by submission of a portfolio which contains all of the individual work of students during the semester. The compulsory items (pieces of work) to be included in the portfolio are listed as below:
2. Individual workbook (handwritten);
3. Individual reflective journal (handwritten);
4. Individual Drawing Folder (Project 1, computer file and hardcopy);
5. Peer and individual (self) assessment (word processed);
6. Individual grade nomination (word processed);
7. Technical report for Projects (word processed, to be submitted through Moodle in order to allow TurnItIn plagiarism check.

The portfolios were followed up with a compulsory group presentation (15 minutes) related to Projects, and individual Viva Voce (oral interview, 45 minutes) that were used to confirm and enhance the material presented in the portfolio.

The evaluation was based on satisfying 10 learning outcomes. If one learning outcome was unacceptable or the attendance of a student was below 80% then the student had to repeat the unit.

To determine the students' opinion, an anonymous survey was conducted by the facilitator during the last session of the class. Twenty-one students completed the survey.

Students were not forced to answer all questions. Students responded on the following questions based on their experience during the semester:

- 1) One major project would be more suitable for this course or multiple smaller projects?
- 2) Do you prefer maintaining team members for all projects or changing team members?
- 3) Do you prefer having team members of the same discipline or both disciplines?
- 4) Do you prefer working in unisex teams or mixed teams?
- 5) How much would the most appropriate team work time/lecture time for each session of the class?

Students were asked to select one of the team work time/lecture time choices including 80/20, 50/50 and 20/80.

Results of the survey was gathered at the end of the session and analyzed by the facilitator.



Table 1. Learning outcomes for Engineering Skills unit.

#	Learning Outcome
1	Discuss the role of a professional engineer within a business environment, showing an appreciation of the interactions between the technical aspects of the role and the social, cultural, environmental, economic and political contexts.
2	Investigate and select materials and processes for engineering applications and justify decisions made.
3	Apply information literacy skills and information technology skills to engineering projects.
4	Use drawing, modeling and simulation tools to analyze and present project outcomes.
5	Describe, apply and justify risk assessment and workplace health and safety in engineering activities.
6	Design, conduct and report on practical activities, including devising appropriate measurements and procedures, analyzing and interpreting data and forming reliable conclusions.
7	Articulate an appreciation of the complex nature of engineering activities including ill-defined situations and problems involving uncertainty, imprecise information, and conflicting technical and non-technical factors.
8	Articulate and demonstrate personal application and development of the practice of professional engineering, including a professional attitude, problem solving skills, relevant technical knowledge, productive work practices and a commitment to lifelong learning.
9	Provide evidence of a professional capacity to communicate, work and learn; individually and in peer learning teams.
10	Demonstrate professional oral skills during the presentation and Viva Voce

RESULTS AND DISCUSSION

The results of questions 1 to 4 are summarized in Figure 1. It is observed that two third of students preferred multiple smaller projects versus one bigger project. They highlighted the lack of experience with PBL courses as the main reason for their selection. Having multiple smaller projects may allow students to allocate more time for building up on their so called “soft skills”. However, those who voted for one big project, one third of the votes, mentioned that the time spent for each project was not enough for them and could gain more technical expertise by spending more time on each project. This particular finding indicates the need of students to improve their skills regarding working under stress and to improve team work effectiveness, both are important learning outcomes in Engineering Skills course.

Among all, 63% of students preferred changing number of team members for different projects. The rationale for their selection included diversifying their teamwork skills by changing team members. Those who favored



maintaining team members during the semester mentioned that dealing with other discipline students could render developing a strong bond between team members. It was highlighted by students that changing team members might help in avoiding conflicts between team members particularly considering sociocultural incompatibilities amongst students. We found that it was very useful to provide some interactive lecturing material to students for their conflict management. There are approaches and techniques to overcome these conflicts professionally (Aarnio, 2013).

Having team members from both Mechanical and Civil Engineering disciplines (62%) was favored compared to a single discipline team (38%). Students who preferred multidisciplinary teams highlighted the additive value of having people with different perspective and skill set to the outcome of their projects.

Whereas those in favor of single disciplinary teams mentioned that they were more productive when they were working with students who they knew from previous semesters. Although the challenge of starting new professional relationships in team members takes time and effort, it is of great importance to the concept of the PBL (Parton, 2008) which is one of the key learning outcomes of this unit. Having team members from both genders, i.e. mixed group, was favored (60%) to having same gender teams (40%). Students highlighted more professional behavior of team members as a rational for mixed teams. Cultural differences and personal restrictions were counted as a reason for selecting a single gender team. Cultural and personal aspects of team work appear to be a stronger challenge in Middle East countries and need to be addressed with extra care. There was 71% of students that believed the majority of the class time should be spent on team work toward projects whereas 24% voted for a 50/50 choice and 5% voted for the majority of class being spent on lecturing.



Figure 1. Response of students voting A) having multiple small projects vs. one big project, B) Changing team members for each project vs. maintaining team s, C) selecting team members from one discipline or both, Mechanical and Civil Engineering, disciplines, and D) having team members from the same gender or not.

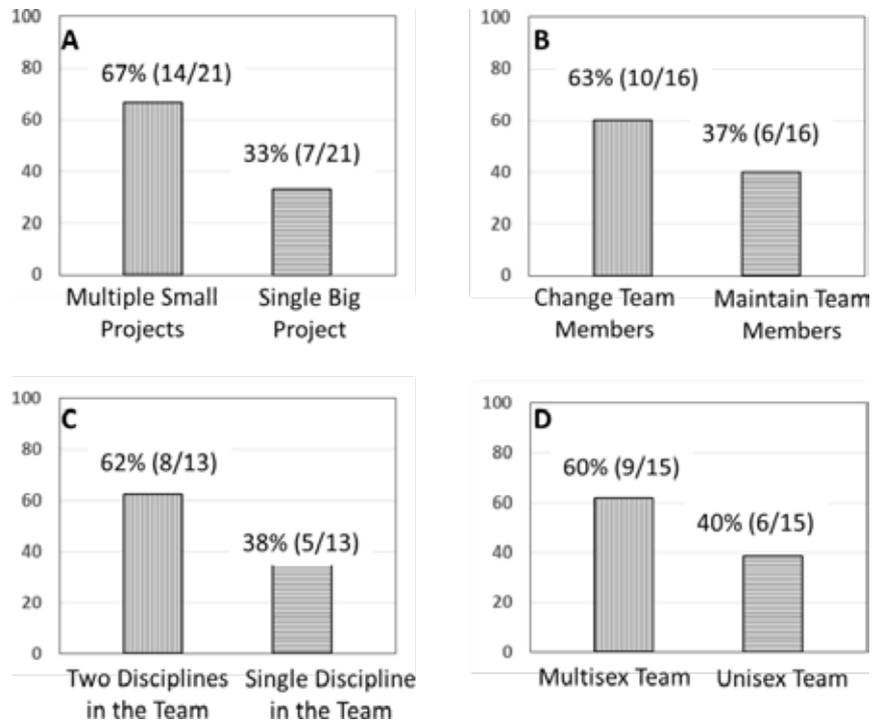
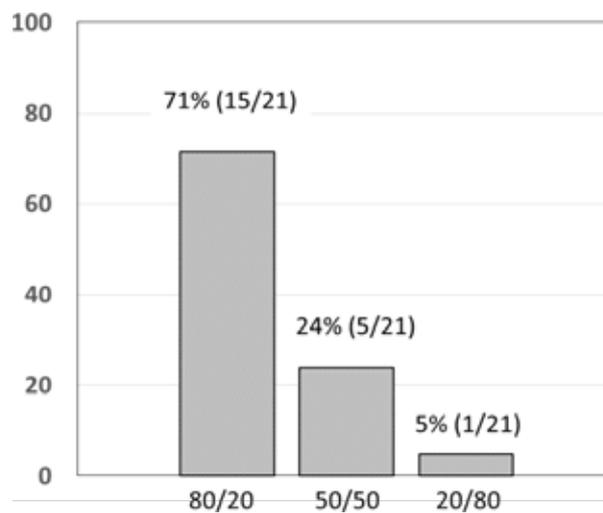


Figure 2. Response of students to the amount of time that should to be spent on team work for projects vs. lecturing the course material for each class session. Each column represents votes for a certain team work time / lecture time.



CONCLUSIONS

This paper has explored our experience in developing an Engineering Skills unit of multidisciplinary PBL subjects in the School of Engineering by surveying the PBL students. Here, we addressed the preferences and



challenges that students faced in the course including team formation and team work. The majority of students preferred a multidisciplinary and mixed gender team and preferred to work on multiple smaller projects.

ACKNOWLEDGMENT

The authors would like to acknowledge the work of colleagues at the Central Queensland University, Australia, in developing initially the Engineering Skills unit considered here.

REFERENCES

Aarnio, M, Lindblom-Ylänne, S., Nieminen, J., Pyörälä, E. (2013), "How do tutors intervene when conflicts on knowledge arise in tutorial groups?", *Advances in Health Sciences Education*, 19(3), pp 329–345.

AW Precision LTD, Metric punch and die set, http://penta-edm.cz/dokumenty/normalie/awprecision/awp_punch_and_die_metric.pdf, accessed January 2017.

De Graaff, E. & Peter A. J. Bouhuijs (1993). *Implementation of problem-based learning in higher education*. Amsterdam: Thesis Publishers.

De Graaff, E., W. Ravesteijn & J.O. Kroesen (2006). „Engineering the future: the social necessity of communicative engineers.” *European Journal of Engineering Education*, 31 (1), pp. 63-71.

De Graaff, E. and A. Kolmos, (2007). *History of problem-based and project based learning, Management of change implementation of problem-based and project-based learning in engineering*, E. de Graaff and A. Kolmos (eds.), Rotterdam: Sense Publishers, pp. 1-8.

Edwards, Metric punch and die set, <http://www.edwardsironworkers.com/c-15-metric.aspx>, accessed January 2017.

Goyal, P., Srivastava, G., Singh, R., Singh, N., Review on Pneumatic Punching Machine and Modification in Punch Tool to Reduce Punching Force Requirement, *International Journal of Engineering Technology Science and Research (IJETSRS)*, Volume 2 Issue 2, February 2015.

Jaeger, M. & D. Adair (2015). "Students' perception of learning facilitation during an interdisciplinary engineering design course- a case study." *Proceedings of 19th International Conference on Engineering Education*, July 20-24, 2015, Zagreb, Zadar (Croatia).

Jaeger, M. (2017). "The PBL facilitator guide: A week by week guide", version 1.3, Australian College of Kuwait, Kuwait, 9 January 2017.



Johnson, D.W. & Johnson, R.T. (1999). *Learning Together and Alone: Cooperative, competitive, and individualistic learning* (5th ed.). Needham Heights, Massachusetts: Allyn and Bacon.

Parton, G., Bailey, R, "Problem-based learning: a critical rationalist perspective", *London Review of Education*, Volume 6, Number 3, November 2008, pp. 281-292(12), UCL IOE Press, DOI: <https://doi.org/10.1080/14748460802528475>.

Salehi-Isfahani D., Dhillon, N. (2008) "Stalled Youth Transitions in the Middle East: A Framework for Policy", Reform Middle East Youth Initiative Working Paper No. 8.

Sang, Y.Y. (2001). "Implementing problem-based learning in nurse specialists continuing education program - an experience of an emergency department." *Proceedings of 3rd Asia Pacific conference on PBL*. Queensland, Australia.

Schmidt H.G. (1993). "Foundations of Problem-based Learning: some explanatory notes." *Medical Education*, 27, pp. 422-432.

Schweinhart, L. J., and Weikart, D. P. (1997). "The high/scope pre-school curriculum comparison study through age 23." *Early Childhood Research Quarterly*, 12 (2), pp. 117-143.

Van der Vleuten, C.P.M., Norman, G. R. and De Graaff, E. (1991). "Pitfalls in the pursuit of objectivity: Issues of reliability." *Medical Education*, 25, pp. 110-118.

AUTHOR INFORMATION

Armin Eilaghi, armin.eilaghi@utoronto.ca, Kuwait, Australian College of Kuwait (corresponding author)

Fadi Alkhatib, f.alkhatib@ack.edu.kw, Kuwait, Australian College of Kuwait

Hayder Abdul-Razzak, h.abdulrazzak@ack.edu.kw, Kuwait, Australian College of Kuwait

Martin Jaeger, m.jaeger@ack.edu.kw, Kuwait, Australian College of Kuwait



A PROJECT-BASED LEARNING APPROACH IN THE COURSE OF “ENGINEERING PROJECT” FOR MECHANICAL ENGINEERING DIPLOMA STUDENTS

Shiva Sadeghi, Majed Alsarheed & Fadi Alkhatib

ABSTRACT

A summary of recommendations, experiences in the application of project based learning in the course of “Engineering Project” in the School of Engineering at a private university college in the Middle East are presented. In this unit, students will apply the knowledge and skills they have developed throughout their diploma program of Mechanical Engineering to a capstone project implemented in the workshop. Students using team work manage the project, identify and apply required technical knowledge, develop a project problem definition from a loosely formed client brief and produce detail drawings and documentation. Students are required to demonstrate a system approach to design activities incorporating sustainability principles in this unit and operate in an ethical manner, communicate effectively and provide evidence of professional conduct and a commitment to lifelong learning. The performance of students was assessed using compulsory items included in the final portfolio namely 1) Prototype, 2) Drawing Folder, 3) Peer Assessment Review and 4) Technical report 5) Presentation File. In this paper we provide details of the designed and instructed unit, feed-back received from students and analysis of results, lessons learned along the semester considering technical and socio-cultural aspects, and some practical recommendations for future consideration. Project based learning provided a suitable experiential platform for educating students to professional engineering practice through a capstone engineering project.

KEYWORDS: PBL, Capstone Project, Undergraduate Engineering Education

TYPE OF CONTRIBUTION: Practice-based abstract

PRESENTATION FORMAT: Interactive poster presentation

INTRODUCTION

Problem/project based learning (PBL) was probably started from McMaster University (De Graaff & Kolmos, 2007) although the idea was applied in many schools earlier (Schweinhart & Weikart, 1997; Van der Vleuten et



al., 1991; Sang, 2001; Schmidt, 1993). The acronym PBL was later extended to “Project Based Learning” in engineering discipline (De Graaff & Bouhuijs, 1993; De Graaff et al., 2006). In the “Engineering Project” PBL unit, students are introduced to the role of professional engineers as liaison between the technical, businesses, social, cultural, environmental, economic and political contexts of engineering activities. They investigate and select materials and processes for engineering applications and justify decisions made. Students apply information literacy skills and information technology skills to engineering projects. They use drawing, modeling and simulation tools to analyze and present project outcomes. They apply risk assessment and workplace health and safety assessment to engineering activities. Also they design, conduct and report on practical and hands-on activities. Students explore the complex nature of engineering activities and the need to deal with uncertainty and conflicting information. They prepare a

portfolio to demonstrate development of a professional attitude, problem-solving skills, technical knowledge and productive work practices, and provide evidence of a professional capacity to communicate, and work and learn productively both individually and in teams. The purpose of this unit is to build confident in students to plan, design, construct and test a real life example by simple engineering project using ethical, technical and soft skills they have developed in the first two years of their diploma program. The learning outcomes are listed in Table 1.

Table 1. Unit objectives and learning outcomes

1.	Create independent – self-managed project
2.	Understand how to work effectively with team - all team members are expected to contribute accordingly
3.	Apply knowledge on safety procedures and use personal protective devices
4.	Understand, analyze and apply selection of materials according to the requirements specified in the drawing
5.	Analyze and create features in accordance with drawing specifications using bench work tools and equipment
6.	Apply the components for conformance to specification
7.	Apply design implementation



METHODOLOGY

Methods of Delivery

This course will be delivered in handouts through a one 3-hour session per week in workshop. The handouts cover the basic principles of project management such as, decision matrix, planning, risk assessment, stakeholder analysis, cost analysis and team management. Students will be assessed through prototype testing, technical report and presentation at the end of the semester. Since this unit is based on a PBL approach, it is the responsibility of the students to identify, source and access additional supplemental materials as necessitated by the given projects.

Submission of Work

The compulsory items (pieces of work) to be included in the final portfolio are:

- Prototype
- Drawing Folder
- Technical Report
- Presentation files

Assessment Method

Details of assessment plan are given in Table 2. Students will also receive verbal feedback (formative assessment) on a regular basis throughout the semester during class sessions.

Table 2. Assessment plan for the unit

Assessment	Method of Assessment	Learning Outcome s Covered	Week	Weight
Numeracy Assessment	Prototype Model Testing	1, 2, 3, 4, 5, 6, 7	13	25% if pass



Written & Numeracy Assessments	<p align="center">Final Design Report Submission</p> <p>(Report should include team information and project details such as component and assembly drawings, Bill of Materials, assembly instructions, tools information, and any other issue assigned by the instructor)</p>	1, 2, 3, 4, 5, 6, 7	14	50% portfolio
Oral Assessment	<p align="center">Oral Presentation Assessment</p>	1, 2, 3, 4, 5, 6, 7	15	25% the result of the viva voca can fail or pass the students even if he/she cover all of the L.O by written portfolio

Students’ survey

To improve the methodology of this unit, students’ opinions were collected through an anonymous survey. The following questions were responded by twenty students based on their experience during the semester:

- 1) One major project would be more suitable for this course or multiple smaller projects?
- 2) Do you prefer working in unisex teams or mixed teams?
- 3) How much would the most appropriate team work time/lecture time for each session of the class?

Students were asked to select one of the team work time/lecture time choices including 80/20, 50/50 and 20/80.

Result of the survey was gathered and analyzed which presented in the following section.

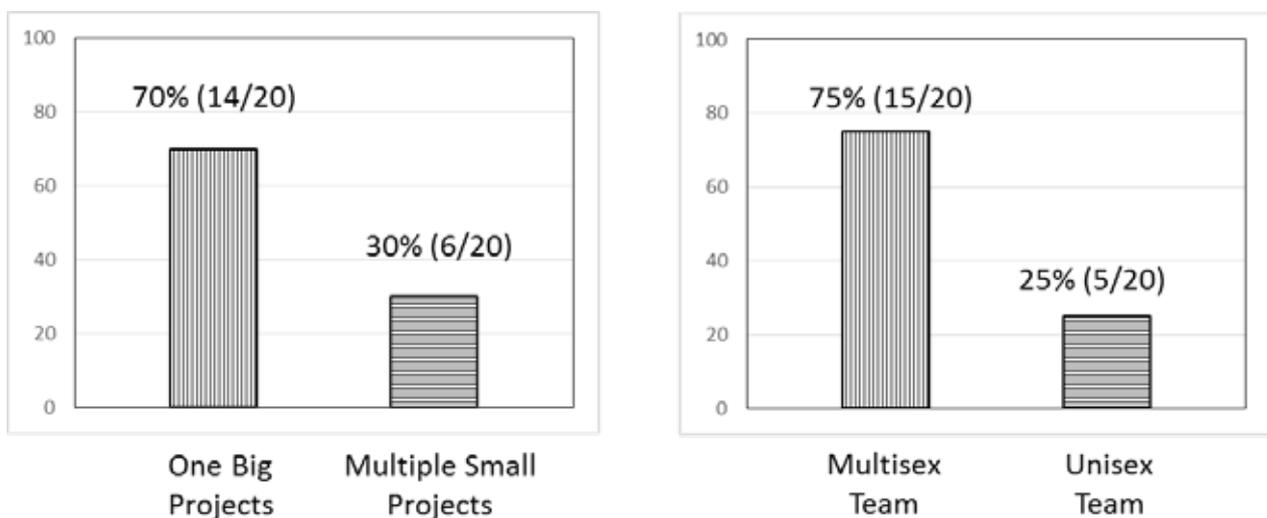


RESULTS AND DISCUSSION

This unit enables students to confidently apply project management skills along with fundamental engineering knowledge and hands on workshop skills to familiarize themselves to real world engineering project in a small scale. The students realize and face the challenges to work in a team, manage their time and cost while learn how to research for needed variables.

Figure 1 summarizes the results of question 1 and 2. Based on the observation, 70% of the students preferred one big project versus multiple small projects. Main reason behind this selection is their ability to focus on one idea and clearly understanding the fundamental principles of planning a project from scratch to the end. Since this is their first major engineering project working in a team, they highlighted their need for more time to understand and apply the learning outcomes of the unit. This finding shows the students are inspired and willing to design and produce an engineering project in an effective and stress free environment to express their learning as a successful result.

Figure 1. Response of students voting A) having one big project vs. multiple small projects, B) having team members from the same gender or not.

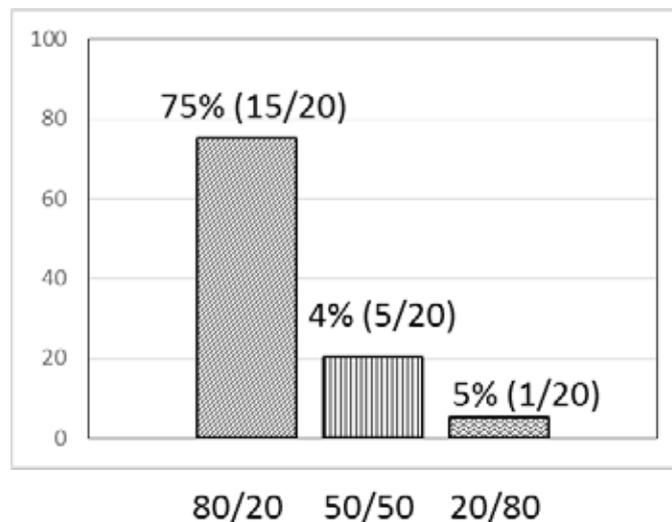


Among all, 75 % of students preferred having both genders in a team versus 25% who voted for same gender teams. It was observed that more professional behavior of team members results in both gender teams. Also, they highlighted that the point of views are different in each gender and this way they find a chance to share these views. However, students who favored having same gender teams are more concerned about cultural and communication challenges.



According to the result of question 3 shown in Figure 2 75% of students that favored in having 80 % of the class time on teamwork and constructing the project and only 20% should be spent on lecturing. They highlighted that it was challenging to finish their implementation of the work in one three-hour session per week while part of the class is taken for lecturing. Students also suggested to have multiple lecture hours per week versus one long session. Also, some believed in having different project per group, so they can be unique in design and implementation versus comparing and projecting other teams ideas.

Figure 2. Response of students to the amount of time that should to be spent on team work for projects vs. lecturing the course material for each class session. Each column represents votes for a certain teamwork time / lecture time.



CONCLUSIONS

This paper has explored our experience in developing an Engineering Project unit using multidisciplinary PBL approach at the Mechanical Engineering department in the School of Engineering suitable for Diploma students. Here, we addressed the preferences and challenges that students faced in the course including technical and project management challenges. The majority of students expressed satisfaction in structure and implementation of this unit through standard and anonymous evaluation survey.

ACKNOWLEDGMENT

The authors would like to acknowledge the work of colleagues at the workshop particularly Mr. Robin Kilner.

REFERENCES

Aarnio, M, Lindblom-Ylänne, S., Nieminen, J., Pyörälä, E. (2013), "How do tutors intervene when conflicts on knowledge arise in tutorial groups?", *Advances in Health Sciences Education*, 19(3), pp 329–345.

AW Precision LTD, Metric punch and die set, http://penta-edm.cz/dokumenty/normalie/awprecision/awp_punch_and_die_metric.pdf, accessed January 2017.



De Graaff, E. & Peter A. J. Bouhuijs (1993). Implementation of problem-based learning in higher education. Amsterdam: Thesis Publishers.

De Graaff, E., W. Ravesteijn & J.O. Kroesen (2006). „Engineering the future: the social necessity of communicative engineers.” *European Journal of Engineering Education*, 31 (1), pp. 63-71.

De Graaff, E. and A. Kolmos, (2007). History of problem-based and project based learning, *Management of change implementation of problem-based and project-based learning in engineering*, E. de Graaff and A. Kolmos (eds.), Rotterdam: Sense Publishers, pp. 1-8.

Edwards, Metric punch and die set, <http://www.edwardsironworkers.com/c-15-metric.aspx>, accessed January 2017.

Goyal, P., Srivastava, G., Singh, R., Singh, N., Review on Pneumatic Punching Machine and Modification in Punch Tool to Reduce Punching Force Requirement, *International Journal of Engineering Technology Science and Research (IJETSRS)*, Volume 2 Issue 2, February 2015.

Jaeger, M. & D. Adair (2015). “Students’ perception of learning facilitation during an interdisciplinary engineering design course- a case study.” *Proceedings of 19th International Conference on Engineering Education*, July 20-24, 2015, Zagreb, Zadar (Croatia).

Jaeger, M. (2017). “The PBL facilitator guide: A week by week guide”, version 1.3, Australian College of Kuwait, Kuwait, 9 January 2017.

Johnson, D.W. & Johnson, R.T. (1999). *Learning Together and Alone: Cooperative, competitive, and individualistic learning* (5th ed.). Needham Heights, Massachusetts: Allyn and Bacon

Parton, G., Bailey, R, "Problem-based learning: a critical rationalist perspective" , *London Review of Education*, Volume 6, Number 3, November 2008, pp. 281-292(12), UCL IOE Press, DOI: <https://doi.org/10.1080/14748460802528475>.

Salehi-Isfahani D., Dhillon, N. (2008) "Stalled Youth Transitions in the Middle East: A Framework for Policy", Reform Middle East Youth Initiative Working Paper No. 8.

Sang, Y.Y. (2001). “Implementing problem-based learning in nurse specialists continuing education program - an experience of an emergency department.” *Proceedings of 3rd Asia Pacific conference on PBL*. Queensland, Australia.

Schmidt H.G. (1993). “Foundations of Problem-based Learning: some explanatory notes.” *Medical Education*, 27, pp. 422-432.



Schweinhart, L. J., and Weikart, D. P. (1997). "The high/scope pre-school curriculum comparison study through age 23." *Early Childhood Research Quarterly*, 12 (2), pp. 117-143.

Van der Vleuten, C.P.M., Norman, G. R. and De Graaff, E. (1991). "Pitfalls in the pursuit of objectivity: Issues of reliability." *Medical Education*, 25, pp. 110-118.

AUTHOR INFORMATION

Shiva Sadeghi, s.sadeghi@ack.edu.kw, Kuwait, Australian College of Kuwait (corresponding author)

Majed Alsarheed, m.alsarheed@ack.edu.kw, Kuwait, Australian College of Kuwait

Fadi Alkhatib, f.alkhatib@ack.edu.kw, Kuwait, Australian College of Kuwait



INVESTIGATING THE EFFECTIVENESS OF TEAM-BASED LEARNING IN COMBINATION WITH PROBLEM-BASED LEARNING TO ENHANCE OVERALL LEARNING IN GENETICS

Janaki H. Shah, Ventris M. D'souza & Ivane Tay

ABSTRACT

Problem-based learning (PBL) and Team-based learning (TBL) are learner-centric approaches to learning. Students work in interactive small groups, and use peer-assisted learning to solve authentic, real-world problems. The two pedagogical approaches complement each other and have been shown to enhance learning in some studies. The principles of TBL centre around self-directed learning, team work, problem solving and students receiving feedback – all of which are congruent with the principles of PBL. We believe that the two pedagogical approaches can be used synchronously to enhance students' overall learning. A mixed-methods study was conducted to examine the effectiveness of using TBL in conjunction with PBL to enhance learning of concepts and application of concepts in Genetics. The hybrid pedagogy was implemented in a total of seven classes. Access to all resources was comparable for both groups of students. Hallmarks of a hybrid TBL-PBL lesson included learning content related to the lesson, followed by readiness assurance tests at an individual and team level (iRAT/tRAT). This was followed by application of the concepts related to the lesson to solve real-world problems.

In this study, lecturers found that students experienced increased levels of engagement, interaction and perceived confidence in their problem-solving and concept learning. They were able to learn concepts well, and then apply them to solving problems effectively. Students enjoyed the classes, felt they were able to learn more effectively and felt that solving problems as a team was an effective way to practice what they learnt through the day.

KEYWORDS: Team Based Learning, Hybrid, Engagement of Students

TYPE OF CONTRIBUTION: Practice-based abstract

PRESENTATION FORMAT: Interactive poster presentation

FULL ABSTRACT

In this study, the effectiveness of a hybrid of Team-Based Learning in combination with Problem-Based Learning to enhance overall understanding and concept-learning in Genetics was investigated. At our institute, Genetics is currently taught primarily using a Problem- Based Learning (PBL) pedagogical approach.



The module requires students to explore and understand concepts related to inheritance and heredity, and apply them to case-studies and real-world problems. Students at our institute come from varying backgrounds, and many students often find it challenging to apply the concepts to different scenarios after they have been learned. This study aims to investigate if the combination of the PBL approach with Team-Based Learning (TBL) approach would enhance the learning experience for students taking this module.

Problem-based learning is a pedagogical approach designed to promote critical thinking and problem-solving in authentic learning situations. PBL enables students to learn while engaging actively with meaningful problems. Students are given opportunities to problem-solve in a collaborative setting, create mental models for learning, and form self-directed learning habits through practice and reflection (H.G. Schmidt, 2000; Hmelo-Silver, 2004). The underpinning philosophy of PBL is that learning can be considered a “constructive, self-directed, collaborative and contextual” activity (Dolmans, De Grave, & Wolfhagen, 2005). At Republic Polytechnic, our beliefs about effective teaching and learning are primarily built on social-constructivism, in which learners actively construct their knowledge and skills through purposeful social interaction. Learner centric approaches such as PBL form the core of our teaching and learning practices (Republic Polytechnic, 2019).

TBL is an innovative teaching and learning pedagogical approach that was developed by Dr. Larry K. Michaelson in the 1970s (Team-Based Learning Collaborative, 2018). It is widely adapted across many disciplines, especially in disciplines related to the health sciences (Parmelee & Hudes, 2012). Patricia Hrynchak and Helen Batty (Hrynchak & Batty, 2012) proposed that team-based learning incorporates the main elements of constructivist learning, in which the focus is on the “mental representation of information by the learner”. They proposed that, in TBL:

- The Lecturer is a guide to facilitate learning.
- Learners should encounter inconsistencies between preconceptions and new experiences to provide a basis for development of new understandings.
- A focus on relevant problems accompanied by group interaction promotes learning.
- Learning requires reflection.

These key elements of TBL are also important cornerstones of the PBL approach, which makes a hybrid between the two approaches conceivable. A hybrid of TBL and PBL would combine the best, and most important attributes of both approaches—one that incorporates both self-directed and collaborative learning. We believe that this would help to enhance overall learning outcomes and “soft-skills” such as problem-solving skills for the students.



A mixed-methods study was conducted for students taking Genetics. The module was taken by 350 students in 15 classes; of these, seven classes across four diplomas were randomly selected as the intervention group. All students received similar curricular materials including a carefully crafted problem statement. In intervention classes, resources for learning of concepts were provided before the problem was introduced, whereas in control classes, the problem was introduced first, along with scaffolding and resources to enable learning of concepts as part of the problem solving process. The team of lecturers teaching the module were also split into two groups, one to teach the intervention group and one to teach the control group. In the intervention classes, students were carefully assigned into teams following the principles suggested in TBL guides (Farland, 2013; Team-Based Learning Collaborative, 2018). Additionally students' learning, understanding and readiness for the "application" stage was conducted via the Readiness Assurance Process common to the TBL pedagogy (Team-Based Learning Collaborative, 2018). Reflection, which is key to both pedagogical approaches, was incorporated into the lessons for both groups. A common set of questions were used in both the intervention and the control groups but one in the form of the Readiness Assurance Process (intervention group) and one in the form of a regular quiz assignment (control group). Summative assessment data, survey results, focus group discussions and reflections were also analysed from both groups.

Focus group discussions revealed that the experience of a hybrid classroom was positive for both lecturers and students – there was increased enjoyment, interaction and reduced stress in most lessons. Lecturers found that classrooms were more interactive with students being more engaged in peer learning and team discussions, and that students were able to learn concepts well. Significantly, it was observed in classroom interactions, reflections and in surveys that students were more comfortable with making mistakes in the lesson, as they knew that errors could be rectified during team discussions. This is an important aspect of self-directed learning in a safe space. It was also observed by lecturers in classes that students were faster and more effective in problem-solving during lessons that were delivered via the hybrid approach.

A post-study survey showed that students enjoyed the hybrid pedagogical approach, especially aspects that allowed them to separate the concept learning from problem solving. Results showed that 87% of the students enjoyed the classes with the TBL-PBL hybrid approach. Over 80% of them felt that the hybrid approach stimulated their interest in learning and over 70% felt that they had an improved understand of the content and also felt that they were able to better apply these concepts. 76.9% of the students felt that they were able to better prepare for summative assessments (examinations). The summative assessment grades obtained by students in the both groups were examined. The grade profile between the students was skewed, with more students in the hybrid classes generally getting higher grades (32% A grade in the intervention group compared to 27% A grade in the control group) and fewer students obtaining moderate



grades (5.8% C grades in the intervention group compared to 8.5% in the control group. Percentage of students obtaining D grades or lower was comparable.

Overall, the hybrid TBL-PBL classroom was able to draw on the best aspects of both pedagogies to create a classroom learning environment that resembled the constructivist ideal. Students were given a broad topic to explore, to activate prior knowledge, create chaos and learn the content before and during class. After this, students were assessed on their understanding through readiness assurance tests. This was beneficial both to the students (as it helped them to assess and gain confidence in their own learning) and to the lecturer (as it enabled them to gauge the levels of understanding and depth of learning in the classroom). There was time and opportunity for the lecturer to implement corrective measures if needed. The readiness assurance process being conducted at an individual and a team level allowed students to assess their own learning, but also allowed them opportunities for them to obtain immediate feedback, understand gaps in their learning and to fill in any gaps in concept understanding that may have remained. This created a good platform for the problem-solving phase of the class, where the students were able to use this knowledge to interact with and solve real-world problems.

Drawing on the attributes of both constructivist pedagogical approaches, TBL-PBL hybrid classrooms can benefit students in the learning of concepts as well as in the application of these concepts to real-world problems. The hybrid classroom was engaging for both lecturers and students and presents an excellent alternative for a learner centric classroom. Care needs to be taken to encourage students to prepare for class, and to ensure that they are not overloaded in the class. Time to internalise concepts, as well as results from the readiness assurance tests appear to be of paramount importance.

REFERENCES

- Burgess, A. B. (2017). Team-based learning (TBL) in the medical curriculum: better than PBL? *BMC medical education*, 17(1), 243.
- D. Dolmans, W. D. (2005). Problem-based learning: future challenges for educational practice and research. *Medical Education*, 732-741.
- Epstein Educational Enterprises. (2018). *Epstein Educational Enterprises*. Retrieved December 17, 2018, from <http://www.epsteineducation.com/home/>
- Farland, M. Z. (2013). Best practices for implementing team-based learning in pharmacy education. *American journal of pharmaceutical education*, 77(8), 177.



H.G. Schmidt, J. M. (2000). Factors affecting small-group tutorial learning: a review of research. In *Problem-based Learning: A Research Perspective on Learning Interactions* (pp. 19-52). NJ: Lawrence Erlbaum, Mahwah,.

Hmelo-Silver, C. (2004). Problem-based learning: What and how do students learn? *Educational psychology review*, 235-266.

Hrynchak, P., & Batty, H. (2012). The educational theory basis of team-based learning. *Medical Teacher*, 34(10), 796-801.

Parmelee, D. X., & Hudes, P. (2012). Team-based learning: a relevant strategy in health professionals' education. *Medical Teacher*, 34(5), 411-413.

Republic Polytechnic. (2019). Engaged Learners, Empowered Lecturers. A Guide for Delivering Transformative Education in Republic Polytechnic. *Republic Polytechnic, Learning Retreat 2019*. Singapore .

Team-Based Learning Collaborative. (2018). *Team-Based Learning Collaborative*. Retrieved December 1, 2018, from <http://www.teambasedlearning.org/>

AUTHOR INFORMATION

Janaki Shah, janaki_shah@rp.edu.sg, Singapore, Republic Polytechnic (corresponding author)

Ventris D'Souza, ventris_dsouza@RP.EDU.SG, Singapore, Republic Polytechnic

Ivane Tay, ivanetay@RP.EDU.SG, Singapore, Republic Polytechnic



Philosophy and theory of PBL and active learning





IS CHARACTER QUALITY ESSENTIAL TO THE DEVELOPMENT OF A “SUSTAINABILITY PEDAGOGY” WITHIN A PBL LEARNING COMMUNITY?

Birthe Lund

ABSTRACT

Sustainable Development Goals are intended to achieve a better and more sustainable future for all. This must be transformed into pedagogy in order to influence students' conception and understanding of common challenges, like poverty, inequality, climate change and justice.

How do we educate students to act and relate constructively and ethically?

Intended behaviour change is linked to environmental programs and sustainability. UNESCO mentions character quality as an educational instrument in Education for Sustainability. Character qualities, interpersonal and soft skills relate to behaviour and understanding of environments: how we make sense and interact with others. The former determine how we behave and engage with complex environments. The UN stresses that sustainability encompasses promoting the social, economic and political inclusion of all, allowing *all* citizens to participate in political processes and representing their interests.

I address the concept of sustainability pedagogy from the perspective of pedagogical philosophy and the PPL origin within critical pedagogy in order to discuss how to deal with character quality development in a sustainability curriculum. I draw on Peter Kemp and Lévína's ideas about the consideration of “The Other” as well as Klafki's concepts of categorical formation, about students' understanding of their relationship to society and the world, and *how to act on the basis of this understanding*.

I argue that the traditional foundation of knowledge creation and scientific processes is challenged and a new political and ethical understanding requires co-construction and inclusive collaboration, which must be reflected in a conceptualisation of a sustainability pedagogy.

KEYWORDS: sustainability, ethics, character formation, pedagogical philosophy

TYPE OF CONTRIBUTION: Extended scientific abstract

PRESENTATION FORMAT: Roundtable discussion



EXTENDED ABSTRACT

The Sustainable Development Goals are intended to achieve a better and more sustainable future for all. They address the global challenges, including poverty, inequality, climate change, environmental degradation, peace and justice. This must be transformed into pedagogy in order to influence students' conception and understanding of common challenges.

The Brundtland report's formulation of sustainability as a development that meets current needs without jeopardising future generations' ability to do the same, advocates for the use of ethics as a moral compass (Brundtland Commission (1987)). Meeting such a sustainability requirement in a University setting requires pedagogical innovation, and it is emphasised that the realisation of both sustainability and pedagogy is a complex task, as the emphasis on common values, collaboration and inclusion challenge current political and ethical conceptions.

Character quality plays an integral part in intended behaviour change aimed at being more sustainable and to develop sustainability. Action competence has been a key concept in educational circles in Denmark since the 1980s, an educational ideal referring to the German notion of 'Bildung' (Lund, B. (2020)). (Klafki, 2011)

It is advocated that education for sustainability should be integrated into the formal curricula of all university programs, something which has proved difficult within the existing curricula in many cases (Lehtonen, A. et al (2018) (SY Chen, SY Liu (2020)).

Literature studies indicate that action competence is developed best when students obtain insight into environmental problems by inter-disciplinary inquiry through working on projects, but this does not necessarily take into account ethical aspects or character formation: in short, Bildung. Consequently, in this paper, I address the subject from the perspective of pedagogical philosophy to address these shortcomings.

Research question:

How do we educate students in a PBL setting to act and relate constructively and ethically in complex collaborative change processes to deal with Sustainable Development Goals (SDG)?

Within a PBL settings we intend to empower students to make changes and to solve authentic problems. (Lund, B. (2020)). Students are expected to act on and engage with problems independently, but how might we guide their actions with an ethical perspective in mind, if they should become able to judge a situation and develop ownership in the individual sense, when the enactment of empowerment must be collective. Which values might best help guide and develop appropriate and ethical actions for this purpose as part of character?



This paper is a conceptual work based upon review documents addressing SD in a concept employed to address any pedagogical challenges regarding formation and SD. The complexity in understanding sustainability and implementing action in higher education is widely recognised, but few articles discuss this issue specifically within higher education (Chi-Yen Chen (2020))

Intended behaviour change is linked to international environmental programs and sustainability: UNESCO mentions character quality as an educational instrument in Education for Sustainability (Hughes, C (2020)). Character qualities, interpersonal and soft skills relate to behaviour and understanding of environments: how we make sense and interact with others (Garcia Alvarez, Maria (2020)).

The UN policies emphasise that sustainability encompasses promoting the social, economic and political inclusion of all, allowing *all* citizens to participate in political processes and representing their interests equally. (United Nation (2015))

I address the *concept* of sustainability pedagogy from the perspective of pedagogical philosophy and its PPL origin within critical pedagogy. I draw on Peter Kemp and Lévinas's ideas about the consideration of "the other" as well as Klafki's concept of categorical formation, about students' understanding of their relationship to society and the world, and *how to act on the basis of this understanding*.

The Danish philosopher Peter Kemp (Kemp, P. (2005) regards sustainability as an ethical issue. Ethics is not just about what *I* need but about what we all need, and what the coming generations will need. This leads to the idea of social sustainability and justice, which include sharing and creating equal access to resources. Ethics is a notion of the good life that we ourselves help to create through the lifestyle we choose by which we evaluate each other's actions. Our ethics guide us, telling us that we must not destroy conditions for the good life for the coming generation. Hence, a need to be concerned for the *Other*, put forth by the French philosopher Lévinas, who's work revolves around the ethics of the Other. Kemp claimed that a sustainability pedagogy must teach students to treat the Other as valuable and to treat nature similarly, as an Other - that is to say, as irreplaceable. This fundamental ethical appeal is an absolutely essential aspect of the conceptualisation of sustainability and therefore the development of a pedagogy for sustainability.

CLAMES:

The educational system address climate change related behavioural change as a moral issue as these challenges continue to grow. Global challenges then begins to impact pedagogical formation theories.

In order to be sustainable a new political and ethical understanding, which better allows for co- construction and inclusive collaboration at universities, may be required. This must be reflected in a sustainability



pedagogy in order to implement and translate the UN's Sustainable Development Goals. This discursive framework for sustainability pedagogy as a whole is addressing key issues – such as equality and justice – which should be reflected in new knowledge production processes, to allow a more democratic and inclusive problem definition if (SDG) are to be met.

Consequently, pedagogical conditions for the development of an ethical action competence that enable participation in socio-political processes are a prerequisite for moving society towards a more sustainable future. Previous research has documented that Problem-Based and Project-Based Learning (PBL) can be an innovative pedagogy for sustainability education, but the ethical issues have so far been neglected or at least less reflected on than the strictly technical aspects of presented problems.

REFERENCES

Brundtland Commission (1987) *Our Common Future*. Oxford University Press

Garcia Alvarez, Maria (2020) *Character Qualities in Educating for Sustainability* January 2020 DOI: 10.1007/978-3-319-95870-5_111.

Hughes, Conrad (2020) *The Universal Learning Programme: educating future-ready citizens*. UNESCO International Bureau of Education [12127] No.34 IBE/2020/WP/CD/34 REV IBE\$

Kemp, P (2005) *Verdensborgeren som pædagogisk ideal. Pædagogisk filosofi for det 21. århundrede*. Hans Reitzels Forlag.

Klafki, W. (2011/1994). *Dannelsesteori og didaktik – nye studier*. Aarhus: Klim.

Lehtonen, A et al. (2018). A pedagogy of interconnectedness for encountering climate change as a wicked sustainability problem. *Journal of Cleaner Production*, 199, 860–867.

Lund, B. (2020). Bæredygtighedspædagogik og handlekompetence – et velkommen tilbage til 70'erne? *Forskning og Forandring*, 3(2), doi.org/10.23865/fof.v3.2433

Mogensen, F.; Schnack, K. (2010) The action competences a approach and the new” discourses of education for sustainable development, competence and quality criteria. <https://doi.org/10.1080/13504620903504032> *Environmental Education Research*,16

Schild, R. (2016). Environmental citizenship: What can political theory contribute to environmental education practice? *The Journal of Environmental Education*, 47(1).

Servant-Miklos, V., Holgaard, J. E., & Kolmos, A. (2020). A! PBL effect”? A longitudinal qualitative study of sustainability awareness and interest in PBL engineering students. In A. Guerra,



A. Kolmos, M. Winther, & J. Chen (Eds.), Educate for the future: PBL, Sustainability and Digitalisation 2020 (1 ed., pp. 45-55). Aalborg Universitetsforlag

SY Chen, SY Liu (2020) Developing Students' Action Competence for a Sustainable Future: A Review of Educational Research. Sustainability 2020, 12, 1374 <https://doi.org/10.3390/su12041374>.

United Nation (2015): Transforming our world: the 2030 Agenda for Sustainable Development. October 2015

Xiangyun Du a,1, Liya Su b,2 , Jingling Liu b,(2013) Developing sustainability curricula using the PBL method in a Chinese context. Journal of Cleaner Production.

AUTHOR INFORMATION

Birthe Lund, bl@hum.aau.dk, Denmark, Institute for Cultur and Learning, Aalborg University (corresponding author)



SOCIO-CULTURAL CONSTRUCTIVIST LEARNING COMPONENTS IN PBL

Woei Hung, Mahnaz Moallem & Nada Dabbagh

ABSTRACT

Deeply rooted in socio-cultural constructivism, Problem-based Learning (PBL) is equipped to foster students' social-cultural competencies that traditional instruction fails to do. Socio-cultural constructivism is centered around the core concept of social interaction where individual as well as collective knowledge is constructed. Individual knowledge cannot be formed within the individual's own personal cognition without the social interaction and mutual meaning-making process. Therefore, ensuring proper and sufficient interaction in instruction is key for students to engage in and benefit from social learning. Although the social interactivity and enculturation in PBL is assumed and understood by PBL researchers and educators, the discussion of its theoretical foundations seems to be relatively much scarce if compared to the discussion of its cognitive foundations. In the roundtable discussion, we will focus on the theoretical foundation that support the social learning aspects of PBL as well as student learning outcomes of socio-cultural competence.

KEYWORDS: Problem-based Learning, Socio-cultural Constructivist, Learning Components, Learning outcomes

TYPE OF CONTRIBUTION: Extended scientific abstract

PRESENTATION FORMAT: Roundtable discussion

The authors have chosen not to have their extended abstract published in the conference proceedings. We encourage you to look for existing or future publications by this author in other outlets.

AUTHOR INFORMATION:

Woei Hung, woei.hung@und.edu, United States, University of North Dakota (corresponding author)

Mahnaz Moallem, mmoallem@gmu.edu, United States, George Mason University (corresponding author)

Nada Dabbagh, ndabbagh@gmu.edu, United States, George Mason University (corresponding author)



DESIGNING AN INTERMEDIATE LEVEL PROBLEM-BASED LEARNING (PBL) MODEL

Yin Zhang, Yuli Zhao, Bin Zhang, Kening Gao & Chunfang Zhou

ABSTRACT

Recently, PBL has been regarded as a popular strategy in engineering education around the world. However, challenges and barriers have been evidenced in the changes of traditional institutions towards PBL, for example, in single course level or multicourse level. This drives this paper to fill in a knowledge gap and address to apply PBL on an intermediate level as a good strategy to facilitate the changes. This paper aims to provide a design of intermediate level PBL follows a “course module”-based approach. A detailed case is demonstrated by showing how to apply the new PBL model in Computer Science education in China that also indicates practical significances. Briefly, this paper contributes to a new curriculum design for implementing intermediate level Problem-Based Learning (PBL). This further contributes to inspire and promote the implementation of PBL in engineering education among other traditional institutions in the future.

KEYWORDS: Intermediate Level PBL, Curriculum Model, Case

TYPE OF CONTRIBUTION: Full scientific paper

PRESENTATION FORMAT: Roundtable discussion

1. INTRODUCTION

As a potential strategy to facilitate engineering education reforms for dealing with growing challenges of the changing societies, Problem-Based Learning (PBL) has been drawn much attention by educational organizations all over the world (Alves, et al., 2016) (Li & Henriksen, 2011) (Nielsen, Du, & Kolmos, 2010) (Raine & Symons, 2005). In traditional universities, the most widespread pedagogical strategy of changing towards PBL is to apply PBL at a course level (Kolmos, 2017). However, this strategy has been pointed out several disadvantages including 1) the short time frame for PBL activities, 2) the lack of an overview of the entire curriculum, 3) the extra workload caused by multiple parallel projects, and 4) the unstable academic staff (Kolmos, 2017). To overcome these disadvantages, Kolmos (2017) also suggested applying PBL at a higher level than on a course level and develop systematic organizational changes towards PBL.

The other previous studies have also contributed to much discussions on strategies of developing PBL beyond a course level, for example, the integration strategy (Mynderse, Gerhart, Liu, & Arslan, 2015) (Schaller & Hadgraft, 2013) (Zehra, Nisar, Haider, & Munir, 2009). The integration strategy maps and coordinates the



various courses, integrating the employability aspects (Kolmos, Hadgraft, & Holgaard, 2016). The result of applying the integration strategy is usually a multicourse level PBL curriculum, which involves multiple courses in one educational program, usually across several semesters (Kolmos, 2012) (Kolmos, 2017).

An essential advantage of multicourse level PBL is that it integrates the competencies and projects into the curriculum across existing courses, especially the projects that require a cross-disciplinary approach (Kolmos, 2017). The multicourse level PBL also provides an environment for teachers to learn, practice, and participate in developing new teaching activities. Such an environment is necessary for keeping PBL in traditional organizations (Kolmos & De Graaff, 2014) and meanwhile improving both teaching and learning. Moreover, the multicourse level PBL helps staff members and organization administrators to understand what they might need to change and what they can get in return when pushing PBL to an even higher level (Uden & Beaumont, 2006). However, along with the advantages of multicourse level PBL are some challenges, as discussed in the following lines.

The first challenge is that since the scale of change involved can be substantial, supports from the academic managers (e.g., program leaders, Deans, and Heads of School) are usually required (Kolmos, Hadgraft, & Holgaard, 2016). However, PBL staff members may not be able to handle a large-scale change when the number of staffs is low, and the staffs may not receive enough supports when the institution does not have a strong will to change.

The second challenge is the complexity of the change process. As Kolmos and De Graaff (2007) pointed out, processes of changing to PBL always happen in contexts where are complex and unique. The development of PBL on a Course level concerns resources only within one course at a time, which leads to a complexity that a single staff member may handle (Kolmos, 2017). However, applying PBL at a multicourse level adds extra dynamics (such as the coordination between courses, and the overview of the curriculum) to the change process, which leads to increased complexity (Kolmos, 2017) (Kolmos, Hadgraft, & Holgaard, 2016).

Dealing with the above challenges is critical for PBL staff members when trying to push PBL beyond a course level; and therefore, a new solution should be developed in order to manage these challenges successfully. To respond to such an issue, this paper aims to study how to implement PBL at an “intermediate” level. Therefore, a “course module”-based approach to design new PBL course modules at an intermediate level will be designed firstly. The “course module”-based approach helps to maintain the compatibility with current academic policies to gain more opportunities for PBL staff members to receive support from organization administrators. Secondly, a case will be shown and discussed to demonstrate the design process of intermediate level PBL in Computer Science education in China. Briefly, this paper contributes to implications for innovative curriculum design and implementation in engineering education.



2. DEVELOPING INTERMEDIATE LEVEL PBL FOR A CHANGE

The “intermediate” we are discussing in this paper means to integrally concern several parallel courses (e.g., 2 or 3 courses) and to integrate them into one framework. Intermediate level PBL is a particular case of multicourse level PBL. It has the following advantages to benefit staff members to meet the challenges of applying multicourse level PBL:

- 1) Being highly compatible with current academic policies and educational programs. Traditional universities may have academic policies and educational programs that are highly optimized for traditional learning methods. As it is the same with PBL on a single course level, intermediate level PBL can also be implemented under the current academic policies. Meanwhile, the coordination between parallel courses may also cause minimum changes or no changes to the current educational program. Given such an advantage, PBL staff members can have more chances to receive support from organization administrators.
- 2) Contributing to the control of complexity involved in the changes. The number of courses involved in intermediate level PBL is still low (e.g., 2 or 3 courses), limiting the scale of change to a manageable level. Controlled complexity may increase the possibility of successful changes.

Furthermore, we propose a “course module” based approach to develop intermediate level PBL. A course module is a module of parallel courses. Teaching and learning of the parallel courses in a course module are integrated and scheduled integrally. Meanwhile, a course module still takes the form of the parallel courses at an administration level. The phrase “integrating courses into a course module” is differentiated from “merging courses into a new course”. Merging courses into a new course leads to removing of the original courses and creating the newer, more extensive course. Removing and creating courses can lead to changes in the educational program and may conflict with academic policies, for example, in a situation when the scale of a course is limited by policy.

Being different from merging courses into a new course, integrating courses into a course module still keeps the format of original courses. A course module integrates the activities of teaching and learning of the parallel courses. Such integration will not cause any changes both in the educational program and at an administration level.

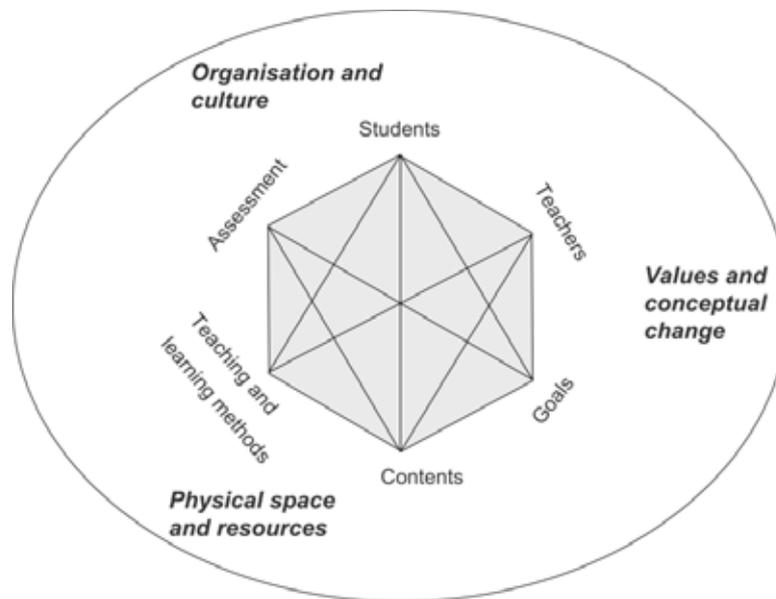
3. A CURRICULUM MODEL FOR CHANGE

When changing to a new pedagogy of PBL, staff members may have troubles in understanding the pedagogy and may need a theoretical model to help them to change (Lueddeke, 1999). Driven by such needs, various curriculum change models have been developed, such as the Trendsetter model proposed in (Barnes, 2005),



and the cyclic model proposed in (Fernandez, 2008). Among these models, this paper regards a model developed by Kolmos and De Graaff (2007) as a potential solution for understanding the changing processes towards PBL in organizations (see Figure 1).

Figure 1: Curriculum model for change (Kolmos & De Graaff, 2007)



As shown in Figure 1, the curriculum model for change provides a comprehensive understanding in revealing the essential elements, as well as the complex interrelation, in the change processes towards PBL. Compared to other curriculum change models, this model adopts a system view of teaching and learning analysis, involving most of the elements mentioned in other models such as goals, contents, resource, policies, and culture. The ability to reveal the complex elements and interrelation comprehensively has been considered as necessary in the design of a curriculum change model (Lueddeke, 1999). Furthermore, the elements and the interrelation in the model coincide with the PBL learning principles (e.g., student-centered learning) (Kolmos & De Graaff, 2014), and thus this model has been widely used in helping staff members change to PBL (Nielsen, Du, & Kolmos, 2010) (Alves, et al., 2016). So it helps us to understand the pedagogical aspect of proposing an engineering-style iterative process model in designing intermediate level PBL.

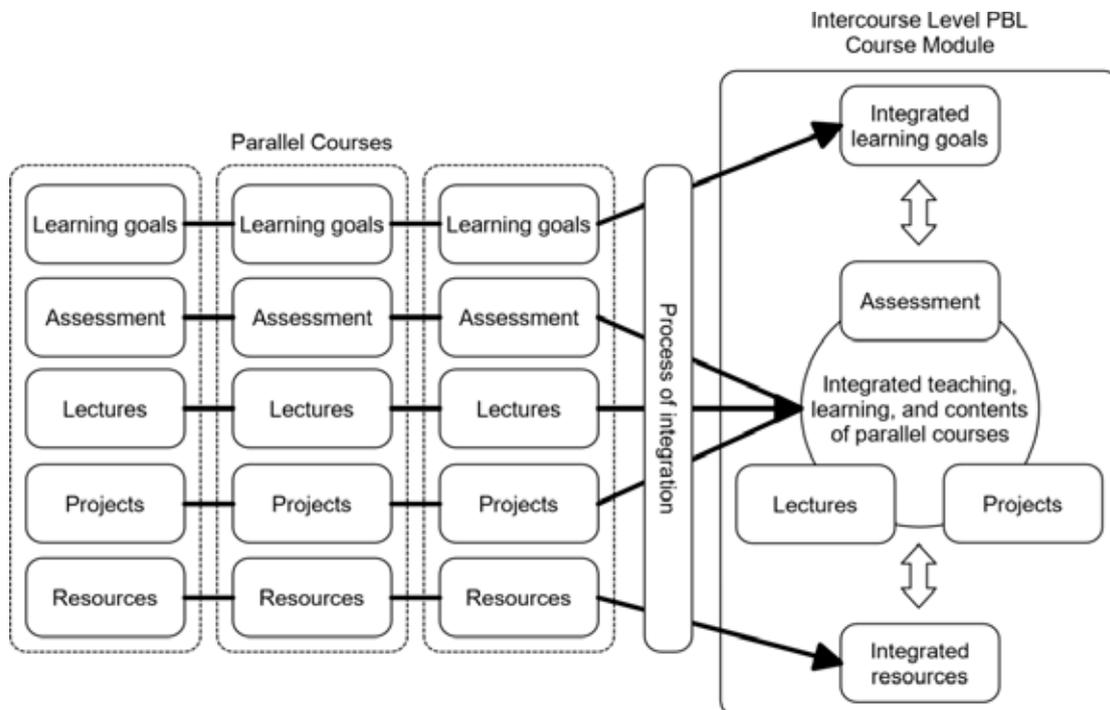
4. MODEL DESIGN

Figure 2 illustrates our proposed model of integrating parallel courses into an intermediate level PBL course module. Two or three parallel courses, each with its own elements of learning goals, assessment, lectures, projects, and resources, are integrated into a PBL course module through a process of integration. The learning goals of the parallel courses are aligned and integrated by, perhaps, organizing learning goals around the knowledge, skills, and competencies connecting the parallel courses. The resources of the parallel



courses, especially the teaching and learning hours, are integrated and redistributed as the integrated teaching, learning, and contents of parallel courses may be more efficient. As a result, more time can be given to PBL activities, including projects and assessment.

Figure 2: Integrating parallel courses into an intermediate level PBL course module.



As mentioned, in a single course, the possible problem domain may be limited by the learning goals. However, real-life problems are usually complex and may not be solved by using knowledge from one specific course. By integrating teaching and learning of multiple courses, students can work on more complex problems that require knowledge from several courses. This helps students to reach more solutions of real-life problems, which may be helpful in motivating them (Barrows, 1986). Also, by integrating learning hours of several courses, more time can be assigned to PBL learning activities. This can make the learning process to be more student-centered. This may also lead to enhanced self-directed and self-reflective learning. Meanwhile, by working on larger projects, learning of culture-related transferable skills and competencies could also be improved (Kolmos & De Graaff, 2014).

Pushing PBL to an intermediate level also brings challenges to teaching and learning. As the complexity of projects increases, stronger problem analysis and project management abilities should be developed. This does not just affect students, but also challenge teachers. A formal method may help teachers and students to understand and develop necessary problem analysis skills (Holgaard, Guerra, Kolmos, & Petersen, 2017). More group work also requires higher facilitation skills from teachers. A proper understanding on how students collaborate to work on problems is necessary for teachers when they try to understand how to



facilitate students (Spliid, 2016). Despite these challenges, if several courses or course modules can be implemented in a programme, students can start to reuse some PBL learning skills. Teachers can also have a chance to push these PBL learning skills to a higher level.

The key difference between course-level PBL and intermediate level PBL is that, teaching and learning resources of parallel courses are integrated. This enables students to work on a single project for a much longer time, instead of working on several parallel projects from separated courses, thus it reduces the overall workload (Kolmos & De Graaff, 2014). Longer time frames on projects also enable students to work on more complex projects, thus help them to develop skills and competencies of solving more complex problems than the relatively simple ones in separate PBL courses. Longer time frames can also be given to different teaching and learning activities, bringing more diversified active learning activities. However, the assessment may become more challenging as proper evaluations of skills and competencies are expected to be harder than evaluations of remembering of knowledge.

5. A CASE ON A PBL COURSE MODULE AT AN INTERMEDIATE LEVEL

In this section, we propose the design of an intermediate level PBL course module Web Engineering (WE) for students from the bachelor programmes of Computer Science and Technology (CS) and Internet of Things (IoT) at Northeastern University (NEU), China. WE is an extension of the course-level PBL course Visual Programming and Applications (VPA) for students from CS and IoT. In the following, we first provide background information about VPA, the disadvantages of VPA as a course-level PBL course, and the reasons to develop WE. And secondly, we introduce the detailed design of WE by PBL.

5.1 Background

VPA is an elective course given at the 6th semester. It introduces a Windows 10 app development platform named Universal Windows Platform (UWP). In Spring 2017, VPA was revised to introduce Active Learning into the whole course. Then in Spring 2018, VPA was revised again to introduce certain PBL concepts. As a course-level PBL course, VPA suffers from several problems that most course-level PBL courses may have (Kolmos, 2017):

1. The ability to develop competencies to solve authentic engineering problems is limited. An authentic Windows 10 app usually works in a Client-Server manner, involving seamlessly integrated development of both the app on the client side and the Web service on the server side. However, the students cannot integrate Web Service development into UWP effectively in real practice.
2. Parallel projects from different courses demotivate the students. Although few courses adopt PBL, lots of courses do use projects as assessments. These parallel projects cause lots of workloads to the students



since working on projects usually take more time than remembering books or working on assignments. These overloaded work may demotivate the students.

3. The short timeframe limits the learning of transferable skills. VPA lasts for 8 weeks, which is a typical case of the elective courses at NEU. The short timeframe greatly limits the scale of the projects, and together they limit the transferable skills that could be developed in complex projects such as project management and interpersonal skills.

To overcome the aforementioned shortcomings of VPA as a course-level PBL course, we propose an intermediate level PBL course module Web Engineering (WE). WE extends VPA by including Web Service development to help develop competencies to solve authentic Web engineering problems. By using an integrated project for all the courses in the module, WE effectively reduces the number of parallel projects the students need to work on. WE also extends the timeframe to the whole semester so that students can spend more time on one complex project to learn necessary transferable skills.

5.2 Module Design

WE is designed to be an elective course module consisting of three courses: 1) Web Engineering: Client Side Development (WE-CS), 2) Web Engineering: Server Side Development (WE-SS), and 3) Web Engineering: Project (WE-P). Each of the three courses in WE is a standard 32 hours course with 2 credits. That makes WE a 96 hours course module with 6 credits. The first two courses, WE-CS and WE-SS, are held during week 1-8, and the last course, WE-P, is held during week 9-16. The exam are held during week 17-20. The teaching and learning are integrated in WE.

5.3 Learning Goals

The design of learning goals of WE starts from a set of teaching visions, listed as bellows. The teaching visions of WE are a merge of the key ideas of WE-CS and WE-SS, as well as general development principles in Software Engineering (SE).

1. Understanding key concepts of Graphical User Interface (GUI) and Web Service (WS) designing and programming, being able to scale these concepts to GUI platforms other than UWP (such as WPF, Android and iOS), and to WS platforms other than ASP.NET Core Web app (such as ASP.NET Web app, and Apache CXF).
2. Being able to integrate various techniques such as Web Services, Audios, Videos, Cameras, Sensors, Maps, Calendars etc. to build a Web client app.



3. Being able to ensure security on client side such as safe data storage, on server side such as authentication and authorization, and on the communication between clients and servers.
4. Being able to specify user needs on apps clearly.
5. Being able to design and program in an Objective-Oriented (OO) manner leveraging modern design and architecture patterns.
6. Being able to program according to coding conventions.
7. Knowing how to ensure software quality by, e.g., testing, debugging and performance profiling.
8. Being able to work as a team facilitating collaborative development tools such as GitHub through the whole development process to build complex apps.
9. Knowing how to find and learn about new techniques effectively.

The teaching visions would lead to a set of learning goals shown as Table 1.

Table 1 Learning goals of Web Engineering

<p>Knowledge</p>	<p>Client Side</p> <ul style="list-style-type: none"> • Know how to use common controls and layout controls • Know how to use various client side techniques such as Web Services, Audios, Videos, Cameras, Sensors, Maps, Calendars, etc. • Know how to connect to servers and store data safely • Know how to use data binding • Understand what is and why we need Dependency Injection (DI), Model-View-ViewModel (MVVM) and services to propose Objective-Oriented Design (OOD) on client side <p>Server Side</p> <ul style="list-style-type: none"> • Know how to use Model-View-Controller (MVC) to program Web services • Know how to use Identity Server to protect Web services <p>Integrated</p> <ul style="list-style-type: none"> • Know how to use Entity Framework (EF) Core to access data both on client side and server side • Understand the coding conventions of .NET • Know how to unit test, debug and profile on performance both on client side and server side • Know how to use collaborative development tools such as GitHub • Know where to find new techniques
<p>Skills</p>	<p>Client Side</p> <ul style="list-style-type: none"> • Be able to design and implement complex GUI with various controls • Be able to integrate various techniques into GUI apps • Be able to ensure data security on client side • Be able to use data binding, DI, MVVM and services to propose and implement OOD <p>Server Side</p> <ul style="list-style-type: none"> • Be able to design and implement MVC Web services • Be able to ensure security on server side <p>Integrated</p>



	<ul style="list-style-type: none"> • Be able to communicate safely between clients and servers • Be able to use EF Core to manage data on client side and server side • Be able to program according to coding conventions • Be able to test, debug and profile on performance effectively both on client side and server side • Be able to specify user need on apps clearly • Be able to collaboratively design and implement complex apps following SE principles • Be able to find and learn about new techniques effectively
Competencies	<ul style="list-style-type: none"> • Be able to provide integrated solutions to complex user needs on modern apps • Be able to adapt to new techniques and development platforms quickly and effectively • Be able to collaborate effectively on complex projects

5.4 Teaching and Learning Methods

Both lectures and projects are used in WE. All the lectures are Active Learning based to maximize the delivery of knowledge, skills and competence. Meanwhile, projects are used to help students to practice knowledge and develop skills and competencies. There are 96 (32 x 3) teaching hours in WE. According to the knowledge of learning goals, lectures take 40 hours. The other 56 hours are used as facilitation and group work hours. As specified in the module design, two courses of WE, i.e. WE-CS and WE-SS, are given during week 1-8. According to the current policies of NEU, there could be at most 4 lectures, each with 2 teaching hours, during week 1-8. An example of a detailed plan of the lectures is shown as Table 2. The Active Learning methods are explained as below:

1. Follow-me coding: Ask the students to follow the teachers to code right in the class. Check if all the students can follow up.
2. One answer to sit down: Ask a set of students to stand up and propose one or a series of questions. Each student has to give at least one answer to sit down.
3. Figure it out: Teams of students are asked to figure out instances of given concepts.
4. Good to agree: Pairs of teams share their answers and figure out common answers.
5. Good to disagree: Pairs of teams share their answers and figure out different answers.
6. Prove it: Read materials, make sense of them and prove your understanding is right.

Table 2 Lecture Plan of Web Engineering

#	Week	Contents (Including estimated time and Active Learning methods)
1	1	1) The HelloWorld app (30 minutes, follow-me coding); and 2) Layout controls: Grid, StackPanel (80 minutes including 10 minutes break with activities, follow-me coding, one answer to sit down)



4	2	1) NavigationView (15 minutes, follow-me coding); 2) Navigation (45 minutes including 10 minutes break with activities, follow-me coding, figure it out + good to disagree (navigations in Cloud Music)); 3) Connected animations and page transitions (30 minutes, follow-me coding, figure it out + good to agree (transitions in XAML Controls Gallery)); and 4) ScrollView (20 minutes, follow-me coding)
7	3	Scaffolding Web services with EF Core (110 minutes with 10 minutes break): SQL Server, 1 entity and 2 entities
10	4	MVVM (110 minutes with 10 minutes break, follow-me coding, figure it out)
20	8	Miscellaneous techniques: GPS, in-app purchase, publishing, ad, etc. (110 minutes with 10 minutes break, follow-me coding, figure it out)

The lectures cover almost all the learning goals of knowledge and skills, except for the following:

- Knowledge - Client Side - Know how to use various client side techniques such as Web Services, Audios, Videos, Cameras, Sensors, Maps, Calendars, etc.: Only some of the techniques are introduced
- Knowledge - Client Side - Know where to find new techniques: Only some of the ways to find new techniques are introduced
- Skills - Integrated - Be able to specify user need on apps clearly: Not covered
- Skills - Integrated - Be able to collaboratively design and implement complex apps following SE principles: Not covered
- Skills - Integrated - Be able to find and learn about new techniques effectively: Not covered

Projects, as well as assignments, are used to help the students to practice the knowledge and develop skills and competencies, including the uncovered ones in lectures. The students are asked to propose an integrated solution of an app and a Web service. The requirements on projects are shown as Table 3.

Table 3 Requirements of the projects of Web Engineering

Technical Requirements	
1.	Use UWP or any equivalent platform on the client side, and ASP.NET Core Web app or any equivalent platform on the server side
2.	Use at least one technique besides WS and database, such as GPS, Audios, etc.
3.	Ensure data security on client side, server side and on the communication between clients and servers
4.	Use data binding or any equivalent or more advanced technique
5.	Use DI, MVVM (or any equivalent or more advanced technique) and services to propose OOD on client side
6.	Use MVC or any equivalent or more advanced pattern on the server side



<ol style="list-style-type: none"> 7. Use EF Core or any equivalent or more advanced ORM tool to access data 8. Follow certain coding conventions 9. Propose unit tests or any more advanced testing methods to ensure quality on software 10. Develop collaboratively using tools such as GitHub
Non-Technical Requirements
<ol style="list-style-type: none"> 1. Solve authentic problems that make sense. Problems can be from you or people you know 2. Document user needs according to SE principles 3. Document to explain your design, e.g. functional modules, GUI elements, software architectures, techniques used, in detail 4. Document MetaNotes to explain how you manage to solve your problems

The projects and the lectures can cover most of the learning goals of WE, but we still need to consider the competence of “Be able to adapt to new techniques and development platforms quickly and effectively” in more details. We cover these goals in the assignments of WE.

5.5 Assessment

The assessment of WE completes the learning goals. Transferable skills such as creativity, project management, and interpersonal skills need extra practice to develop. The assessments are designed not just to expand the coverage of knowledge, but also to guide and help the students to develop transferable skills in solving complex WE problems. The assessments are also used to make tacit knowledge of transferable skills and metacognition skills explicit so that the students can reflect on and share it.

There are three types of assessments in WE: assignments, milestones, and the final exam, as shown in a 4W1H manner as Table 4. The list of assignments is shown as Table 5. The alignment of learning goals, methods and assignments are shown as Table 6.

Table 4: Types of assessment in Web Engineering

	Assignments	Milestones	The Final Exam
Who	Individual students	Groups	Individual students in groups
What	Technical knowledge & transferable skills	Project status	Learning goals
When	Weekly	Alpha release (around week 6) & beta release (around week 12)	Week 19 & 20
Where	Online	Booked classrooms	Booked classrooms
How	1. The students are asked to work on open-ended assignments and document how they solve the problems.	1. Groups present their alpha release reports and softwares for 20 minutes. 2. After one groups' presentation, another	1. Groups present their final reports and softwares for 45 minutes. 2. Each group member takes a 45-minute oral exam,



	<ol style="list-style-type: none"> 2. The teacher’s comment and score on the assignments online using streaming videos. 3. A technical score: pass or not pass, will be given and published. This score will be dismissed. 4. A transferable skill score will be given and published. The highest score from all the assignments of a student contributes to the student’s final exam score. 	<p>chosen group and the teachers comment on the project and the softwares for 20 minutes.</p> <ol style="list-style-type: none"> 3. A performance score will be given and published by the teachers. This score will be dismissed. 	<p>covering the learning goals of WE.</p> <ol style="list-style-type: none"> 3. A final score will be given by the teachers.
--	---	---	---

Table 5: List of some example assignments

Week	Assignment
1	Know your weapons, Part 1 <ul style="list-style-type: none"> • Install XAML Controls Gallery from Microsoft Store. • Figure out 5 controls that may contribute to your project and impress you the most. • Explain how they may contribute to your project and why they impress you.
1	Step outside, Part 1 <ul style="list-style-type: none"> • Choose a client development platform other than UWP such as Android, iOS or Qt that you have no or limited knowledge in. • Figure out if it has any two of the controls you found useful in assignment 1. Make sure to use the latest version of that platform. • Document what are they, how to use them with demos and how you manage to understand them.
2	Know your weapons, Part 2 <ul style="list-style-type: none"> • Install Windows Community Toolkit from Microsoft Store. • Figure out 5 controls that may contribute to your project and impress you the most. • Explain how they may contribute to your project and why they impress you.
3	Know your weapons, Part 3 <ul style="list-style-type: none"> • Browse the list of available techniques in UWP. • Figure out 5 techniques that may contribute to your project and 3 limitations that UWP may prohibit you from realizing your ideas. • Explain how they may contribute to your project and prohibit you.
3	Step outside, Part 2 <ul style="list-style-type: none"> • In the platform, you have chosen for assignment 2. • Figure out how to use any two of the techniques you found useful in assignment 4. • Document what are they and how you manage to find and understand them. For any one of the limitations that troubles you, does it still trouble you in your chosen platform? • Document what are they, how you manage to find and understand them, and why you think it may or may not be a trouble.

Table 6 Alignment of some learning goals, methods and assessments of Web Engineering

Knowledge
Client Side



Know how to use common controls and layout controls <ul style="list-style-type: none">• Learning methods: Lecture 1, 2, 3, 4, Assignment 1, 2, Technical requirement 1• Assessments: Assignment 1, 2, Technical requirement 1
Integrated
Know how to use Entity Framework (EF) Core to access data both on client side and server side <ul style="list-style-type: none">• Learning methods: Lecture 7, 17, Assignment 9, Technical requirement 7• Assessments: Assignment 9, Technical requirement 7
Skills
Client Side
Be able to design and implement complex GUI with various controls <ul style="list-style-type: none">• Learning methods: Lecture 1, 2, 3, 4, Assignment 1, 2, Technical requirement 1, Non-Technical Requirement 3• Assessments: Assignment 1, 2, Technical requirement 1, Non-Technical Requirement 3
Integrated
Be able to communicate safely between clients and servers <ul style="list-style-type: none">• Learning methods: Lecture 13, 14, Technical requirement 3• Assessments: Technical requirement 3
Competencies
Be able to provide integrated solutions to complex user needs on modern apps <ul style="list-style-type: none">• Learning methods: Technical and non-technical requirements• Assessments: Technical and non-technical requirements

6. CONCLUSION

In traditional institutions, the implementation of PBL beyond a course level may be prohibited by practical problems such as the resistance against changes and the complexity of implementing PBL at a higher level. In this paper, we proposed a meaningful solution to solve the problems and suggest to implement PBL at an intermediate level. The solution also includes a “course module” based approach to designing an intermediate level PBL course. As the case discussed in this paper, the proposed model can be a good strategy to be applied to an intermediate level PBL in a programme of Computer Science in a university in China. However, the case also implies other engineering programmes in Chinese universities or in other cultures for facilitating changes towards PBL or other advanced pedagogical models. Therefore, this paper has both theoretical and practical significances on new curriculum design, facilitation of changes, and engineering education innovation around the world.

ACKNOWLEDGEMENTS

This research was financially supported by the Ministry of Education Industry-University Cooperation Collaborative Education Project (Tencent Corporation Project), the PBL Research and Application Project of Northeastern University (Grant No. PBL-JX2021yb029), and the Liaoning Common Higher Education Reform Research Project



REFERENCES

- Kolmos, A., & De Graaff, E. (2007). Process of changing to PBL. In *Management of change: Implementation of problem-based and project-based learning in engineering* (pp. 31-44). Sense Publishers.
- Kolmos, A. (2017). PBL Curriculum Strategies. In *PBL in Engineering Education* (pp. 1-12). Rotterdam: Sense Publishers.
- Kolmos, A., & De Graaff, E. (2014). Problem-based and project-based learning in engineering education. In *Cambridge handbook of engineering education research* (pp. 141-161).
- Uden, L., & Beaumont, C. (2006). Curriculum and Organisational Issues. In *Technology and Problem-Based Learning* (pp. 212-222). IGI Global.
- Barrows, H. S. (1986). A taxonomy of problem - based learning methods. *Medical education*, 20(6), 481-486.
- Li, H., & Henriksen, L. B. (2011). How we implement PBL in a university: two case studies. In *Pbl across the Disciplines: Research into Best Practice* (pp. 660-673). Aalborg: Aalborg Universitetsforlag.
- Raine, D., & Symons, S. (2005). Experiences of PBL in Physics in UK Higher education. In *PBL in Context— Bridging Work and Education* (pp. 67-77). Tampere University Press.
- Alves, A. C., Sousa, R. M., Fernandes, S., Cardoso, E., Carvalho, M. A., Figueiredo, J., & Pereira, R. M. (2016). Teacher's experiences in PBL: implications for practice. *European Journal of Engineering Education*, 41(2), 123-141.
- Nielsen, J., Du, X., & Kolmos, A. (2010). Innovative application of a new PBL model to interdisciplinary and intercultural projects. *International Journal of Electrical Engineering Education*, 47(2), 174-188.
- Kolmos, A., Hadgraft, R. G., & Holgaard, J. E. (2016). Response strategies for curriculum change in engineering. *International Journal of Technology and Design Education*, 26(3), 391-411.
- Schaller, C., & Hadgraft, R. (2013). Developing student teamwork and communication skills using multi-course project-based learning. *The 24th Annual Conference of the Australasian Association for Engineering Education*.
- Mynderse, J. A., Gerhart, A. L., Liu, L., & Arslan, S. (2015). Multi-Course Problem-based Learning Module spanning across the Junior and Senior Mechanical Engineering Curriculum: Mechatronics, Fluid Mechanic, and Heat Transfer. *ASEE Annual Conference*.
- Zehra, N., Nisar, N., Haider, G., & Munir, A. A. (2009). Innovation in teaching strategies for undergraduate medical students at Isra University Hyderabad, Sindh-Pakistan. *JLUMHS*, 8(2), 169-172.
- Kolmos, A. (2012). Changing the curriculum to problem-based and project-based learning. In *Outcome-Based Science, Technology, Engineering, and Mathematics Education: Innovative Practices* (pp. 50-61). IGI global.
- Lueddeke, G. R. (1999). Toward a constructivist framework for guiding change and innovation in higher education. *The Journal of Higher Education*, 70(3), 235-260.
- Barnes, R. (2005). Moving Towards Technology Education: Factors That Facilitated Teachers' Implementation of a Technology Curriculum. *Journal of Technology Education*, 17(1), 6-18.



Fernandez, T. S. (2008). Cycles of Curriculum Change: Bridging Educators as Curriculum. The 8th Conference of the New Zealand Association of Bridging Educators, (pp. 30-45).

Holgaard, J., Guerra, A., Kolmos, A., & Petersen, L. (2017). Getting a hold on the problem in a problem-based learning environment. The International journal of engineering education, 33(3), 1070-1085.

Spliid, C. (2016). Discussions in PBL project-groups: construction of learning and managing. The International journal of engineering education, 32(1), 324-332.

AUTHOR INFORMATION

Yin Zhang, zhangyin30@outlook.com, China, Software College, Northeastern University (corresponding author)

Yuli Zhao, zhaoyl@swc.neu.edu.cn, China, Software College, Northeastern University

Bin Zhang, zhangbin@mail.neu.edu.cn, China, Software College, Northeastern University

Kening Gao, gkn@cc.neu.edu.cn, China, Computing Center, Northeastern University

Chunfang Zhou, chunfang618@gmail.com, Denmark, Institut for Planlægning, Aalborg Universitet



ALIGNING LEARNING DESIGN PRINCIPLES WITH PROBLEM DESIGN PRINCIPLES TO FOSTER CRITICAL THINKING SKILLS IN PBL

Nada Dabbagh

ABSTRACT

Problem Based Learning (PBL) has been shown to foster the development of critical thinking skills such as problem solving, analytic thinking, decision making, reasoning, argumentation, interpretation, synthesis, evaluation, collaboration, communication, and self-directed learning. However, there is wide variation in the literature as to how PBL should be implemented to foster critical thinking. This paper provides research-based guidelines for implementing PBL that focus on learning design principles and problem design principles to promote critical thinking. This includes consideration of the characteristics of ill-structured problems that frame learning in PBL and how these problems are presented to learners to ensure engagement in critical thinking. A three-phased mapping process that aligns PBL problem characteristics with PBL pedagogical principles to foster critical thinking skills is provided.

KEYWORDS: problem-based learning, critical thinking, problem solving, ill-structured problems, learning design, problem design, pedagogical principles

TYPE OF CONTRIBUTION: Practice-based abstract

PRESENTATION FORMAT: Roundtable discussion

Critical thinking skills have consistently made the cut as desirable higher education student learning outcomes when government and consumer agencies call for education reforms that will ready graduates for professional and societal responsibilities (Koh, et al., 2015; Markle, et al., 2013). In a 2013 Educational Testing Services (ETS) report, Markle et al. identified critical thinking as one of seven key domains common to 21st century skills and defined critical thinking skills as “thinking critically, solving problems, synthesizing information, and sense-making” (p. 14). Additional established descriptors of critical thinking include “the ability to think deeply about an issue, consider evidence for and against a proposition, and apply reasoning skills and logical inquiry to arrive at conclusions” (Nargundkar, et al., 2014, p. 92). Further elaboration by Markle et al. (2013) describes critical thinking, problem solving, and decision making as “one’s ability to reason effectively, use systems thinking and evaluate evidence, solve problems, and clearly articulate the result of the inquiry and exhibit” (p. 14).



While problem solving and decision making have been coupled with critical thinking in the 2013 ETS report, problem solving has its own prominence as a key cognitive process that must be cultivated to enable individuals to be productive members of society. Jonassen (2011) argued that problem solving is the most authentic and relevant learning activity that students can engage in, and that knowledge gained in the context of problem solving is better comprehended and retained, and therefore more usable and transferrable. Jonassen (2011) defined problem solving as a process that has two critical attributes: the ability to form a mental representation or mental model of the problem and the ability to test the mental model in order to generate a solution to the problem. As such, problem solving can be described as a heuristic process requiring the ability to form a hypothesis, find and sort information, think critically about information, ask questions, and reach a viable resolution or solution to the problem. In a 2012 National Research Council report, Pellegrino and Hilton found that *the ability to solve problems* is one of the most important 21st century skills sought by employers. Further elaboration on this skill resulted in the following descriptors: problem solving, creativity, innovation, critical thinking, analysis, reasoning, argumentation, interpretation, decision making, adaptive learning, or executive function (Clark & Mayer, 2016, p. 344).

It is clear from this brief overview that problem solving, decision making, and critical thinking are interdependent and not mutually exclusive skills. Rather, critical thinking can be perceived as an overarching or broad set of skills that encompass several competencies including problem solving and decision making. The question then becomes, how effective is PBL in supporting critical thinking skills? And, are there specific PBL processes or pedagogical principles that influence critical thinking skills more than others?

PBL has been shown to foster the development and improvement of critical thinking skills such as problem solving, analytic thinking, decision making, reasoning, argumentation, interpretation, synthesis, evaluation, collaboration, communication, and self-directed learning (Abrami et al., 2015; Loyens et al., 2015). In fact, since the origins of PBL, researchers (e.g., Barrows & Kelson, 1995) have consistently emphasized that the goals of PBL are to develop critical thinking skills and competencies necessary to operate effectively in professional and private life. However, what this research also demonstrates is that PBL implementation varies across disciplines and contexts making it difficult to replicate how these outcomes are realized. For example, Nargundkar et al. (2014) used a guided PBL approach, dubbed reverse order textbook, in a college business course to promote critical thinking. Challenges were introduced prior to the content but students were aware that answers to these challenges were in the back of the textbook. This suggests that the challenges were well-defined with clear solutions and solution paths. Kumar and Refaei (2017) implemented PBL in an intermediate college composition



course to support critical thinking through writing. They challenged students with three different writing prompts on human rights, two of which did not require collaboration.

Additionally, different measures were used to assess critical thinking in these studies to include student perceptions, content knowledge, and problem solving knowledge.

Research has also revealed that while PBL results in improved critical thinking, a number of implementation challenges were detected. For example, Cavalho (2016) found that PBL teams struggled with defining and following team roles and emphasized the importance of training tutors in guiding team dynamics throughout the PBL experience. Wilder (2015) argued that PBL has a learning curve which requires student acceptance of their central role in the learning process and that longer interventions may be necessary for students to gain the necessary skills and attitudes to engage in PBL. Wedelin and Adawi (2015) suggest that students should be trained in problem solving skills before entering a PBL program so that they understand the power of *learning by exploration* and are ready to handle ill-structured problems. So what exactly are ill-structured problems and how are they designed or presented?

Jonassen (2011) defines ill-structured problems as problems that occur in the everyday world, are complex, emergent, and interdisciplinary, and have multiple solutions and solution paths. In other words, it would not (or should not) be possible for a student to develop a viable solution to an ill-structured problem on their own, nor would it be possible for students to solve such problems without a pedagogical expert's facilitation. Additionally, it would not be possible to solve ill-structured problems in one problem solving cycle; rather, multiple problem solving cycles are needed to develop viable solutions.

In order to effectively implement PBL and ensure that critical thinking skills are fostered, the characteristics of ill-structured problems should be aligned with the pedagogical principles of PBL in a three-phased learning design approach. Table 1 illustrates how this can be done for phase 1, "problem posing and representation". Due to space limitations, phase 2 (problem solving process) and phase 3 (problem resolution and reflection) will be described at the conference should this proposal be accepted for presentation.



Table 1

PBL Problem Characteristics	PBL Pedagogical Principles	Critical Thinking Skills
Phase I – Problem Posing and Representation		
<ul style="list-style-type: none"> ● Problem lacks the needed information for being defined or resolved when first encountered (problem is messy) ● Goal of the problem is vaguely stated and requires analysis and refinement in order to make the particular issue tractable ● Constraints of the problem are typically not found in the problem statement; the problem solver needs to retrieve and examine the constraints during the problem solving process 	<ul style="list-style-type: none"> ● Learning activities in PBL must be those valued in the real world ● PBL should promote self-directed learning by allowing students to generate hypotheses, set their own learning goals, apply their own learning strategies, and solve the problem through searching for and identifying relevant resources ● PBL should promote a student-centered, group learning environment in which collaboration is essential ● PBL should promote facilitation and scaffolding through instructor coaching and guidance 	<ul style="list-style-type: none"> ● Self-directed learning ● Causal reasoning ● Analytic ability ● Information seeking skills ● Problem solving ability ● Communication skills ● Collaboration skills ● Situational awareness and thinking ● Searching, evaluating, and synthesizing ● Interpersonal skills ● Group and chairperson skills ● Time management ● Strategic thinking

REFERENCES

Abrami, P. C., Bernar, R. M., Borokhovski, E., Waddington, D. I., Wade C. A., & Persson, T. (2015). Strategies for teaching students to think critically: A meta-analysis. *Review of Educational Research, 85*(2), 275-314.

Barrows, H. S., & Kelson, A. C. (1995). *Problem-based learning in secondary education and the problem-based learning institute*. Springfield, IL: PBL Institute.



- Carvalho, A. (2016). The impact of PBL on transferable skills development in management education. *Innovations in Education and Teaching International*, 53(1), 35-47.
- Clark, R.C., & Mayer, R.E. (2016). *e-Learning and the science of instruction (4th ed.)*. San Francisco, CA: Wiley.
- Jonassen, D.H. (2011). *Learning to solve problems: A handbook for designing problem-solving learning environments*. New York, NY: Routledge.
- Koh, J. H. L., Chai, C. S., Wong, B., & Hong, H.-Y (2015). *Design thinking for education: Conceptions and applications in teaching and learning*. Singapore: Springer.
- Kumar, R., & Refaei, B. (2017). Problem-based learning pedagogy fosters students' critical thinking about writing. *Interdisciplinary Journal of Problem-Based Learning*, 11(2).
- Loyens, S.M.M., Jones, S.H., Mikkers, J., & van Gog, T. (2015). Problem-based learning as a facilitator of conceptual change. *Learning and Instruction*, 38, 34-42.
- Markle, R., Brenneman, M., Jackson, T., Burrus, J. & Robbins, S. (2013). Synthesizing frameworks of higher education student learning outcomes. *ETS Research Report Series*, 2013(2), i-37.
- Nargundkar, S., Samaddar, S., & Mukhopadhyay, S. (2014). A guided problem-based learning (PBL) approach: Impact on critical thinking. *Decision Sciences Journal of Innovative Education*, 12(2), 91-108.
- Pellegrino, J.W. & Hilton, M. L. (2012). *Education for life and work: Developing transferable knowledge and skills in the 21st Century*. Washington, DC: The National Academies Press.
- Wedelin, D., & Adawi, T. (2015). Warming up for PBL: A course in mathematical modelling and problem solving for engineering students. *Högre utbildning*, 5(1), 23 – 24.
- Wilder, S. (2015). Impact of problem-based learning on academic achievement in high school: A systematic review. *Educational Review*, 67(4), 414-435.

AUTHOR INFORMATION

Nada Dabbagh, ndabbagh@gmu.edu, United States, George Mason University, (corresponding author)



TRANSFORMING PBL THROUGH FOUR-COMPONENT INSTRUCTIONAL DESIGN (4D/ID)

Jeroen van Merriënboer & Diana Dolmans

ABSTRACT

A common issue in problem and project-based curricula is that problems/projects are not ideally designed and sequenced to support students' competence development. Like problem and project-based learning, four-component instructional design (4C/ID) stresses the use of learning tasks (e.g., problems, projects, cases) based on real-life tasks as the driving force for learning. But in addition, 4C/ID provides design guidelines for relating the real-life tasks to other educational components and for sequencing them in the whole curriculum, so that the development of intended competencies is optimally supported and can be monitored in a development portfolio. A basic assumption of 4C/ID is that educational blueprints can always be described by four basic educational components, namely (a) learning tasks, (b) supportive information, (c) procedural information, and (d) part-task practice. Learning tasks provide the backbone of the program; they provide learning from varied experiences and explicitly aim at transfer of learning, that is, the ability to apply the things that have been learned to new problems in new situations (e.g., the workplace). The other three components are connected to this backbone. The workshop consists of three parts. In the first part (15 minutes), the presenters will briefly describe the 4C/ID model. In the second part (30 minutes), the audience will work on an assignment and develop an educational blueprint according to the 4C/ID design principles. In the third and final part (15 minutes), the developed blueprint will be discussed with the audience and be critically compared with traditional problem and project-based curricula.

KEYWORDS: Four-component instructional design (4C/ID), Task-centered learning models, Competence-based education, Problem-based learning, Project-based learning

TYPE OF CONTRIBUTION: Practice-based abstract

PRESENTATION FORMAT: Experience demonstration

The authors have chosen not to have their full abstract published in the conference proceedings. We encourage you to look for existing or future publications by this author in other outlets.

AUTHOR INFORMATION

Jeroen van Merriënboer, j.vanmerriënboer@maastrichtuniversity.nl, Netherlands, Maastricht University, School of Health Professions Education (corresponding author)



Diana Dolmans, d.dolmans@maastrichtuniversity.nl, Netherlands, Maastricht University, School of Health Professions Education



Methods for researching PBL and active learning





DOES INTERPROFESSIONAL PROBLEM-BASED LEARNING (IPBL) DEVELOP INTERPROFESSIONAL EDUCATION COLLABORATIVE (IPEC) CORE COMPETENCES?

Deirdre Phelan, Olive Lennon & Terry Barrett

ABSTRACT

Interprofessional competences are important requisites for interprofessional collaborative practice to ensure effective and comprehensive patient care and service delivery. The collaborative nature of interprofessional problem-based learning (iPBL) makes it an ideal method to develop the required non-discipline specific competences. The focus of this systematic review was to synthesise the currently published evidence to support iPBL as a method that develops interprofessional competences as identified by the Interprofessional Education Collaborative (IPEC, 2016) framework.

Seven online databases were searched, guided by the preferred reporting items for systematic reviews and meta-analyses (PRISMA) statement. Terms relating to: 'undergraduate health professional students'; 'interprofessional' and 'problem-based learning' were used. All study types were included. Thirty-two studies were identified for inclusion following independent double review and results were aggregated and analysed to provide a narrative summary.

Most iPBL (n=26), was conducted in university rather than clinical settings. Two studies were based in clinical practice settings and 4 studies combined university and practice settings for their iPBL initiatives. Evidence, when broadly considered from both quantitative and qualitative methodologies identified, supports iPBL in promoting competences in 'Ethics/Values' (7 studies); 'Roles/Responsibilities' (27 studies); 'Interprofessional Communication' (19 studies) and 'Teams/Teamwork' (21 studies). Qualitative research dominated the literature. Limited, high level quantitative data observed the largest effects on students' attitudes and perceptions of interprofessional competences. Reporting of iPBL context and implementation mechanisms (e.g., theoretical grounding, trigger design and facilitator training) were largely absent in identified studies.

KEYWORDS: Interprofessional Competences, Interprofessional Problem-based learning, Systematic Review

TYPE OF CONTRIBUTION: Extended scientific abstract

PRESENTATION FORMAT: Roundtable discussion



The authors have chosen not to have their full abstract published in the conference proceedings. We encourage you to look for existing or future publications by this author in other outlets.

AUTHOR INFORMATION

Deirdre Phelan, deirdre.phelan@ucd.ie, Ireland, University College Dublin (corresponding author)

Olive Lennon, olive.lennon@ucd.ie, Ireland, University College Dublin (corresponding author)

Terry Barrett, terry.barrett@ucd.ie, Ireland, University College Dublin



DESIGN BASED RESEARCH FOR PROJECT BASED LEARNING CURRICULUM DEVELOPMENT

Bart Johnson & Ronald Ulseth

ABSTRACT

In a rapidly changing world, more and more is expected of engineers in meeting the societal needs. Just as more is expected of engineers, more is required of engineering education to provide students the opportunity to develop the skills needed for the professional world of engineering. Not only is curriculum and program development an integral part of this, but also the research methodology that supports the development. With the rapid pace of change, traditional research methodology may not be responsive enough to guide the future of engineering education. This extended abstract explores the use of Design-Based Research (DBR) in the ongoing development of a Project Based Learning curriculum and explores its potential in engineering education. This exploration of DBR is based on an adapted DBR approach that is grounded in the development of a PBL program.

KEYWORDS: Research Methods, Curriculum Development, Program Development, Design-Based Research

TYPE OF CONTRIBUTION: Practice-based abstract

PRESENTATION FORMAT: Roundtable discussion

INTRODUCTION

The past few decades in engineering education have seen increasing calls from several international professional organizations like the Royal Academy (Spinks, Silburn, & Birchall, 2006), the National Academy of Engineering (National Academy of Engineering, 2004), the McKinsey Global Institute (Mourshed, Farell, & Barton, 2013), and the American Society for Engineering Education (American Society for Engineering Education, 2015); through several prominent publications (Sheppard, Macatangay, Colby, & Sullivan, 2009; Hasse, Chen, Sheppard, Kolmos, and Mejlgaard, 2013; Martin, Maytham, Case, & Fraser, 2005; Almi, Rahman, & Purusothaman, 2011; & Lindsay & Morgan, 2016); through efforts similar to Denmark's PROCCED-2-WORK (Kolmos et al., 2018), through accreditation bodies like ABET and EUR-ACE; and through political processes such as European Bologna for an international conversation regarding approaches to improving engineering education with specific focus developing approaches to closing the gap identified between engineering education and the skills needed in the engineering workforce (Johnson et al., 2018). This has resulted in many new models developing to create or existing programs adapting to craft a student learning



experience centered on engineering practice, through university-business cooperatives, all in an effort to develop more practice-ready engineering graduates (Lindsay & Morgan, 2016).

One new model is the Iron Range Engineering “Bell Program” (IRSPBL 2018) which takes inspiration from two models named as emerging engineering education world leaders in a report published by the Massachusetts Institute of Technology (Graham, 2018). These models are the Iron Range Engineering (Johnson, 2016) and Charles Sturt University (Lindsay & Morgan, 2016) models in the U.S. and Australia respectively. Iron Range Engineering (IRE) is a project-based learning model that utilizes ill-structured, complex problems directly from industry (Ulseth, 2016) and Charles Sturt University (CSU) is a model that uses extensive cooperative education apprenticeships and on-line technical learning (Morgan & Lindsay, 2015). The Bell program draws its structure from CSU and its learning strategies from IRE (Johnson, Ulseth, and Wang, 2018). The Bell model is separate from the IRE model but being co-located under the same Iron Range Engineering administrative umbrella. An integral part of the Bell Program development is the use of Design-Based Research (DBR). DBR provided the program development with an iterative process simultaneously identifying practice needs leading to model improvements while contributing to the body of engineering education knowledge for the highest impact on preparedness of students for engineering professional practice.

Certainly, traditional research methods have an important role as we seek to understand pedagogical approaches to engineering education in terms of what works and why, specifically looking for the elements that are essential to successful pedagogies. This extended abstract explores the value of DBR as a research methodology that can be effectively used to develop new programs and facilitate rapid innovation in existing programs. A description of the adapted design-based research (DBR) design process will be provided along with how it has shaped the Bell Program development and why a case can be made for broader consideration of DBR as an important education research complement (Dede, 2005) to engineering education research.

INTRODUCTION OF DBR FOR PROGRAM DEVELOPMENT

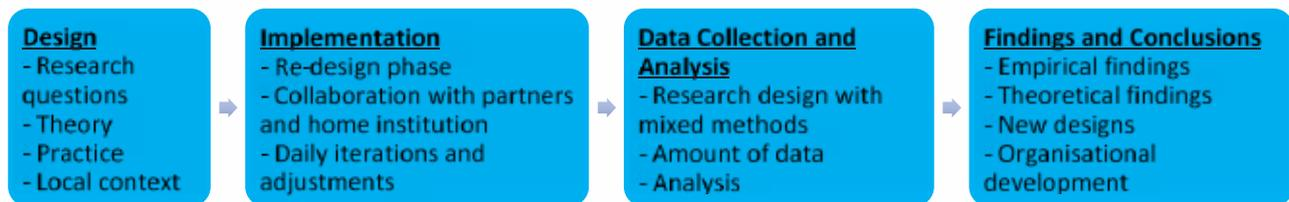
When the design of this PBL program began in 2016 (Johnson & Ulseth, 2018), design-based research (DBR) was selected as the design and research methodology to guide the curricular development work. It was important to the development of the program that the research have meaningful impact on the curriculum development (Haertel & Means, 2003). Design-Based Research (DBR) provided the program developers with the ability to combine what is being learned with the PBL development work, along with both the knowledge derived from each improvement in the curricular design and the theoretical understanding of the model being developed (Anderson and Shattuck, 2012).

This work incorporated the four basic succinct phases of DBR: 1) address learning theories, 2) to study learning in context, 3) to develop measures of learning, and 4) to contribute to new designs and learning



theories (Reimann, 2011) and was enhanced by incorporating curriculum development into the four DBR phases identified by Kolmos (2015): design; implementation; data collection and analysis; and findings and conclusions, as illustrated in Figure 1, with specific elements for consideration in the research approach.

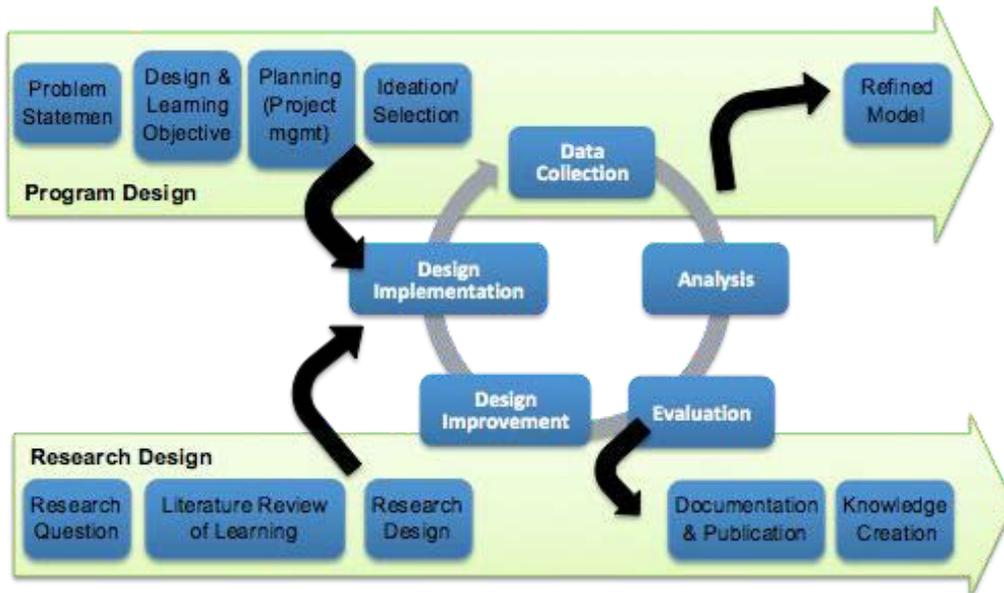
Figure 1: DBR Phases



To further develop the DBR, the phases were combined with Andriessen's (2007) dual purpose of DBR model and to create the Adapted DBR Process Cycle shown in Figure 2. This cycle adapts Andriessen's streams of Knowledge and Practice as Research Design and Program design, respectively. The focus of cycle supports program design through progressive refinement of 1) the problem statement; 2) defining the design and learning objectives; 3) planning (project management) of the curricular design; 4) development of the curricular ideation and selection of a design for initial implementation; and 5) ultimately a continuously reformed model with a curricular model improvement process. At the same time, the cycle supports research design through a focus on establishment of 1) the research questions; 2) identifying the learning theories applicable to the research work; 3) design of the research work that influences the curricular implementation and improvement; and 4) ultimately to disseminate what is learned and add to the body of knowledge on engineering education.



Figure 2: Adapted DBR Process Cycle



APPLICATION AS A DEVELOPMENT AND RESEARCH TOOL

This Adapted DBR Process Cycle provides program developers with a research methodology which simultaneously supports program design, dissemination and knowledge creation. As DBR is a form of action research, the research is being done both by and for the researchers in an effort to improve their systems (Bauer and Brazer, 2012). The goal of developing a new program requires this created knowledge iteratively to ensure emerging information feeds the next stages in the development process.

In the case of PBL model development, there are multiple segments of the curriculum that can benefit from DBR. Such segments include staff development, curricular element development, student professional development, recruitment to the model of both students and staff, retention in the model to graduation, placement of the students in internships and post-graduation, and interactions with industries are among many more potential segments where emerging information can foster improvement in development.

The Bell program began development in 2017 with the first cohort of students arriving in 2019. As of publication, there are now three cohorts in varying stages of completion. An example of how DBR can achieve its purpose can be found in the work of Rogalsky, Johnson, and Ulseth (2020 and 2021). As the first cohort completed their intensive skills training period and were about to enter the workforce as interns, they were interviewed regarding the experience and process provided by the program to acquire placements. Four research findings were identified regarding both the student actions and the program structure that could be implemented in the future. Those design changes were implemented in fall 2020 for the second cohort. Now a new study applying the same methods has been conducted upon the conclusion of the second



intensive training session both to measure the impacts of the changes and to identify the potential for new changes. The first study was presented at ASEE 2020 and the second is in publication for presentation at ASEE 2021.

DBR has been used in other studies during Bell's early development and is being considered for many more including curricular element design, staff and student perceptions, and self-directed learning skill development.

CONSIDERATIONS FOR ENGINEERING EDUCATION

This adapted DBR has worked effectively for the development of the PBL curriculum in the BELL program. It has been critical to both the development of the program and the evaluation of its effectiveness for the sake of dissemination with the broader engineering education community. In this era of rapid engineering program development, it is critical that consideration is given to the value of both of these outcomes and the broader usage of DBR in engineering education to rapidly develop and better position itself to meet society's needs. It provides program and curriculum developers with the important ability to combine what is being learned with the development work, which, added to the knowledge derived from each, leads to improvements in the curricular design and the theoretical understanding of the model being developed.

REFERENCES

- ABET, (2017) <http://www.abet.org/accreditation/accreditation-criteria/criteria-for-accrediting-engineering-programs-2016-2017/> [Accessed: 17-October-2017].
- Almi, N., Rahman, N., & Purusothaman, D. (2011) Software Engineering Education: The Gap Between Industry's Requirements and Graduates' Readiness, in IEEE Symposium on Computers and Informatics, pp. 542–547.
- American Association of Community Colleges, (2017). <http://www.aacc.nche.edu/AboutCC/Pages/fastfactsfactsheet.aspx> . [Accessed: 17-October-2017].
- American Association of Community Colleges (2017). <http://www.aacc.nche.edu/AboutCC/Documents/FastfactsR2.pdf> [Accessed: 12-October-2017].
- American Society for Engineering Education, The Attributes of a Global Engineer Project, Global Engineering Deans Council (GEDC), 2015. [Online]. Available: <http://www.gedcouncil.org/publications/attributes-global-engineer-project>. [Accessed: 20-Jul-2017].
- Andersen, A., Persavento, U., & Wang, Z. J. 2005. Unsteady Aerodynamics of Fluttering and Tumbling Plates. *Journal of Fluid Mechanics*, **541**, 65–90.
- Anderson, T., and J. Shattuck. "Research-based design: a decade of progress in Educational Research." *Educational Researcher* 41.1 (2012): 16-25.



- Andriessen, D. Combining (2007) design-based research and action research to test management solutions. Paper presented at the 7th World Congress Action Learning, Action Research and Process Management, Groningen, 22-24 August, 2007.
- Bauer, S., & Brazer, S. (2012). *Using research to lead school improvement*. Thousand Oaks, Calif.: SAGE.
- Chan, C., Zhao, Y., & Luk, L. (2017), A validated and reliable instrument investigating engineering students' perceptions of competency in generic skills, *Journal of Engineering Education*, 106, 299-325.
- Dede, C. (2005). Why design-based research is both important and difficult. *Educational Technology*, 45(1), 5-8.
- Guerra, A., Ulseth, R., & Kolmos, A. (2017). *PBL in Engineering Education: International Perspectives on Curriculum Change*. Rotherdam: Sense Publishers.
- Haertel, G. D., & Means, B. (Eds.). (2003). *Evaluating educational technology: Effective research designs for improving learning*. Teachers College Press.
- Hasse, S., Chen, H. L., Sheppard, S., Kolmos, A., & Mejlgaard, N. (2013). What does it take to become a good engineer? Identifying cross-national engineering student profile according to perceived importance of skills, *Int. J. Eng. Educ.*, vol. 29, no. 3, pp. 698–713, 2013.
- Johnson, B. (2016). Study of professional competency development in a Project-Based Learning (PBL) curriculum (Ph.D.). Aalborg University, Aalborg, Denmark.
- Johnson, B. & Ulseth, R. (2018) Developing the Next Generation of Co-operative Engineering Education. Paper presented at the PAEE 2018, Brasilia, Brazil.
- Kolmos A. (2015) Design-Based Research: A Strategy for Change in Engineering Education. In: Christensen S., Didier C., Jamison A., Meganck M., Mitcham C., Newberry B. (eds) *International Perspectives on Engineering Education*. *Philosophy of Engineering and Technology*, vol 20. Springer, Cham.
- Kolmos, A. (2015). "Design-Based Research: A Strategy for Change in Engineering Education", In: Christensen S., Didier C., Jamison A., Meganck M., Mitcham C., Newberry B. (eds) *International Perspectives on Engineering Education*. *Philosophy of Engineering and Technology*, vol 20. Springer, Cham.
- Lindsay, E., & Morgan, J. (2016). Charles Sturt University Model – Reflections on Fast-track implementation. Paper presented at the American Society of Engineering Education Annual Conference and Expo, New Orleans, Louisiana, U.S.A.
- Martin, R., Maytham, B., Case, J., & Fraser, D. (2005). Engineering graduates' perceptions of how well they were prepared for work in industry, *Eur. J. Eng. Educ.*, vol. 30, no. 2, pp. 167–180, 2005.
- National Science Foundation (2017), <https://www.nsf.gov/nsb/sei/edTool/data/college-13.html>. [Accessed: 17-October-2017].



- Mourshed, M., Farrell, D., & Barton, D. (2013). *Education to employment: Designing a system that works*. McKinsey Center for Government.
- National Academy of Engineering, (2004). *The engineer of 2020: Visions of engineering in the new century*. Washington, D.C.: National Academies Press.
- Reimann, P. 2011 "Design-Based Research", In: L. Markauskaite , P. Freebody, J. Irwin (eds) *Methodological Choice and Design*, vol 9. Springer, Dordrecht, 37-50.
- Rogalsky, D., Johnson, B., & Ulseth, R. (2020). *Design-Based Research: Students Seeking Co-op in New Educational Model*. Paper presented at the American Society of Engineering Education Annual Conference and Expo, Montreal, Canada.
- Selingo, J.L. (2016). *There is life after college*. New York, NY: Harper Collins.
- Sheppard, S. D., Macatangay, K., Colby, A., & Sullivan, W. M. (2009). *Educating engineers: Designing for the future of the field*. San Francisco, CA: Jossey-Bass.
- Spinks, N., Silburn, N., & Birchall, D. (2006). *Educating Engineers in the 21st Century: The Industry View*. Retrieved from http://www.raeng.org.uk/news/releases/henley/pdf/henley_report.pdf.
- Ulseth, R. R. (2016). *Self-directed learning in PBL* (Ph.D.). Aalborg University, Aalborg, Denmark.
- Ulseth, R. & Johnson, B. (2015). *Iron Range Engineering PBL Experience*. Presented at PAEE 2015 International Symposium on Project Approaches in Engineering Education, International Joint Conference on the Learner in Engineering Education, Donostia-San Sebastian, Spain.

AUTHOR INFORMATION

Bart Johnson, bart.johnson@itascacc.edu, United States, Iron Range Engineering (corresponding author)

Ronald Ulseth, ron.ulseth@ire.minnstate.edu, United States, Iron Range Engineering (corresponding author)



LISTEN! SIGNIFICANT SOUNDS OF SILENCE IN PROBLEM-BASED LEARNING

Kathrine Thorndahl

ABSTRACT

A comparison of field notes made on two different occasions approximately two years apart revealed a marked difference in the prevalence of silent moments noticed in two different, but similar, groups of undergraduate students doing problem-based learning. While no silent moments were noted in the field notes describing the first group of students, the field notes describing the second group were littered with frequent mentions of silent moments and descriptions of what transpired during these quiet interstices. Taking this difference as my point of departure, I argue that while what I initially described as silent moments are significant, they are not really silent at all.

KEYWORDS: Silence, Problem-based learning, Higher education, Posthumanism, Research methodology

TYPE OF CONTRIBUTION: Extended scientific abstract

PRESENTATION FORMAT: Roundtable discussion

The author has chosen not to have their full abstract published in the conference proceedings. We encourage you to look for existing or future publications by this author in other outlets.

AUTHOR INFORMATION

Kathrine Thorndahl, klt@hst.aau.dk, Denmark, Aalborg University, (corresponding author)



TRENDS, GAPS AND FUTURE RESEARCH DIRECTIONS OF PBL RESEARCH

Woei Hung, Diana Dolmans & Jeroen van Merriënboer

ABSTRACT

Since its first implementation in the 1970s, Problem-based learning (PBL) has been a widely adopted pedagogy that best reflects the philosophy of constructivism. It is also one of the most researched pedagogy in history as it defied many philosophical views and practices of objectivism that was the dominant educational paradigm and requires more instructional resources in its original format. At the 50-year anniversary of Problem-based learning (PBL), we conducted a systematic review of the synthesized meta-analyses and systematic reviews of PBL research conducted over the past 50 years. We identified three waves of PBL research – polarization, from outcomes to processes, and specialization. Fifty years of research has given us a better understanding and the knowledge gaps of PBL. We suggest qualitatively conceptualizing the mechanism of PBL to be a primary goal of future study and a broad research question, “Why does PBL with particular implementation characteristics for specific outcomes work or not work in the condition where it is implemented?” We also suggest contextually specific (disciplinary, institutional, social, and cultural) PBL research and diverse research methods to be the focus of the next wave of PBL research. In this roundtable discussion, we will report the results of this review, reflect on what conceptual paradigm shifts have taken place, what lessons we can learn from past iterations, and how they can inform future research.

KEYWORDS: Problem-based Learning, Pedagogy, Meta-analysis, Systematic Review

TYPE OF CONTRIBUTION: Extended scientific abstract

PRESENTATION FORMAT: Roundtable discussion

The authors have chosen not to have their full abstract published in the conference proceedings. We encourage you to look for existing or future publications by this author in other outlets.

AUTHOR INFORMATION

Woei Hung, woei.hung@und.edu, United States, University of North Dakota (corresponding author)

Diana Dolmans, d.dolmans@maastrichtuniversity.nl, Netherlands, Maastricht University

Jeroen van Merriënboer, j.vanmerriënboer@maastrichtuniversity.nl, Netherlands, Maastricht University



Use of digital media and technologies in PBL and active learning



IMPLEMENTING A PROBLEM-BASED COMPUTER SCIENCE CURRICULUM WITH ELEMENTARY STUDENTS: IMPACT ON KNOWLEDGE, SKILLS, AND ATTITUDES

Thomas Brush, Anne Leftwich & Kyungbin Kwon

ABSTRACT

The purpose of this study was to examine how introducing elementary-aged students to computer science (CS) concepts and coding skills via problem-based learning (PBL) impacted students' knowledge of CS concepts and skills as well as students' attitudes towards CS. Specifically, this study addressed the following research questions: (1) How does a problem-based computer science curriculum impact elementary students' knowledge of computer science concepts and coding skills, and are there differences in students' knowledge of computer science concepts and coding skills based on their prior knowledge level of computer science? (2) How does a problem-based computer science curriculum impact elementary students' attitudes towards and interest in computer science? Four teachers and 360 sixth-grade students from four elementary classrooms participated in the study. Data collected for the study included student pre- and post-test results from an assessment on CS content and debugging skills, and results from a student attitudinal survey.

Results indicate that student achievement results demonstrated statistically significant increases for all students participating in the PBL unit, including students with a low level of prior knowledge of CS content. Student attitudes towards CS after completion of the unit were positive, however students with high prior knowledge of CS also had more positive attitudes towards CS. These results suggest that engagement in PBL instruction focusing on CS content may have a positive effect on students' knowledge of CS and ability to apply CS coding skills content regardless of their level of prior knowledge.

KEYWORDS: Computer science, coding, elementary students

TYPE OF CONTRIBUTION: Full scientific paper

PRESENTATION FORMAT: Interactive poster presentation

The authors have chosen not to have their full paper published in the conference proceedings. We encourage you to look for existing or future publications by this author in other outlets.



AUTHOR INFORMATION

Thomas Brusht, brush@indiana.edu, United States, Indiana University (corresponding author)

Anne Leftwich, aleftwic@indiana.edu, United States, Indiana University (corresponding author)

Kyungbin Kwon, kwonkyu@indiana.edu, United States, Indiana University (corresponding author)



EDUCATION FOR PURPOSE THROUGH ICT AND ACTIVE LEARNING METHODS

Ulisses Araujo

ABSTRACT

This article presents a Brazilian experience in training teachers to educate for Purpose. Understanding that Purpose is a value to be constructed through real-world and contextualized experiences, the authors discuss how a purpose development program conducted for in-service teachers, using innovative ICT tools and pedagogies, such as Problem-Based Learning, Project- Based Learning, and Design Thinking can support teachers to educate youth for Purpose.

KEYWORDS: Purpose, teachers' professional development, active learning methods.

TYPE OF CONTRIBUTION: Extended scientific abstract

PRESENTATION FORMAT: Roundtable discussion

The authors have chosen not to have their full abstract published in the conference proceedings. We encourage you to look for existing or future publications by this author in other outlets.

AUTHOR INFORMATION:

Ulisses Araujo, uliarau@usp.br, Brazil, University of Sao Paulo (corresponding author)



HOW DID PBL MANAGE DURING THE TRANSITION TO ONLINE TEACHING DUE TO THE COVID-19 LOCKDOWN?

Hans Hüttel, Dorina Gnaur & Eskil Olav Andersen

ABSTRACT

We present our findings from a survey of student experiences with online teaching from the first lockdown in Denmark during the spring of 2020. Students were in favor of recorded presentations (as opposed to live lecture-style presentations). On the other hand, activities that involve active learning were affected: student-teacher interaction as well as student-student interaction took a hit. This is in particular a cause for concern for group-based PBL projects, which are central to the degree programmes at AAU.

In this paper we discuss these findings. On one hand the move to online teaching has been a rapprochement to the notion of flipped teaching in the sense that video presentations are becoming widespread and accepted by-need. On the other hand, the rationale of flipped teaching, which has been to move the focus away from presentations to active learning, has not been realised in the setting of the lockdown. When it comes to PBL, the negotiation of meaning and group dynamics are in danger of being severely hampered by the limited technological affordances experienced within an online setting.

The results of our survey point towards the need for hybrid approaches to be used in online PBL settings that involve project work including student supervision, group collaboration and association with external partners.

KEYWORDS: Online teaching, COVID-19, problem-based learning, hybrid approaches

TYPE OF CONTRIBUTION: Extended scientific abstract

PRESENTATION FORMAT: Roundtable discussion

INTRODUCTION

On 11 March 2020, much of Danish society was subjected to a lockdown because of the COVID-19 pandemic. Staff at higher education institutions was sent home; all teaching activities were to be carried out online. Students had to turn their private abodes into learning spaces. This continued until the end of the spring semester of 2020 and began anew in the autumn semester; at the time of writing, online teaching remains a fact of life for students and teachers.



Two of the current authors carried out a survey in May 2020 of the experiences with online teaching during the lockdown by teaching staff at Aalborg University (AAU). In September 2020, the present authors conducted a follow-up university-wide survey of how students experienced online teaching during the same period.

PBL constitutes a foundational pillar of the pedagogical approach. Students employ approximately 50% of their semester work in problem-oriented projects, where they organize themselves in groups and benefit from teacher supervision. Projects are special to each degree programme; the problem setting of a project is chosen by the students based on the learning goals of a given part of the degree programme. PBL projects often involve a third party in the form of public or private partners – the problem owner. In all subject areas, student projects involve collaborative group processes such as brainstorming, meaning negotiations and knowledge sharing.

The goal of our research is to determine how the use of online teaching has affected the practice of problem-based learning (PBL) at AAU, based on reflections by students about their experiences from the second survey. Our hypotheses were that central PBL practices such as teacher/student interaction and interaction between students would be negatively affected by the transition to an online setting. We consider this in the context of generally observed difficulties with active learning in online settings.

OUR SURVEY

Our survey was completed by 1853 students across all degree programmes at AAU. The survey was distributed via e-mail as a questionnaire using the SurveyXact platform and was deliberately anonymous; no personal information such as gender or age was gathered, but we assumed that attitudes and impression of PBL projects have largely been shaped by past experience with such projects at AAU.

The questionnaire had two parts. The quantitative part used questions scored on a Likert-scale to uncover the circumstances under which online teaching had been conducted, including the technological solutions employed and the frequency of supervisor meetings. The qualitative part used open-ended text questions to obtain reflections from students about their experiences and thoughts about the future. The findings here were intended to uncover more detailed explanations of student experiences that could be used to form further hypotheses.

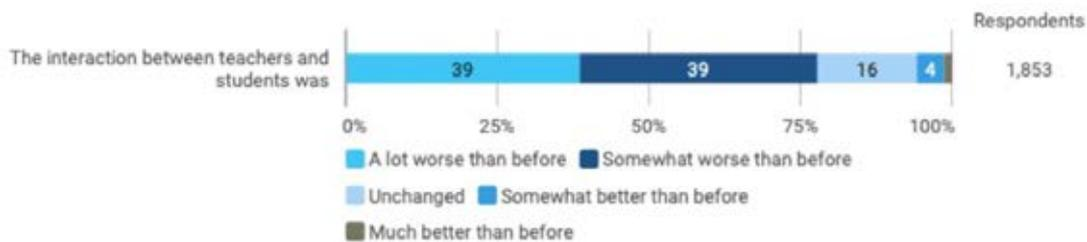
RESULTS

We present the *key findings* of the quantitative part, followed by additional qualitative findings.



1. **Activities that involve active learning were affected:** student-teacher interaction as well as student-student interaction took a hit. See Figure 1.

Figure 1: Perceptions of teacher/student interaction



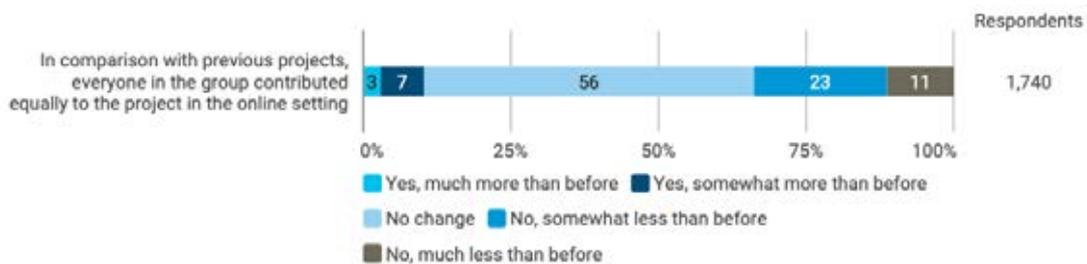
Qualitative statements indicating this are:

"Teaching becomes very "filling up", it is not as engaging and interacting as when one can meet physically. There is no daily contact with fellow students. Harder to maintain the social community. Harder with group formation for project"

"Basically online teaching works fine, it's more the lack of social interaction with fellow students that can be hard to do without"

2. **44 per cent of the students experienced that not everyone in a group contributed equally to the project.** See Figure 2.

Figure 2: Perceptions of contributions to the project within a group



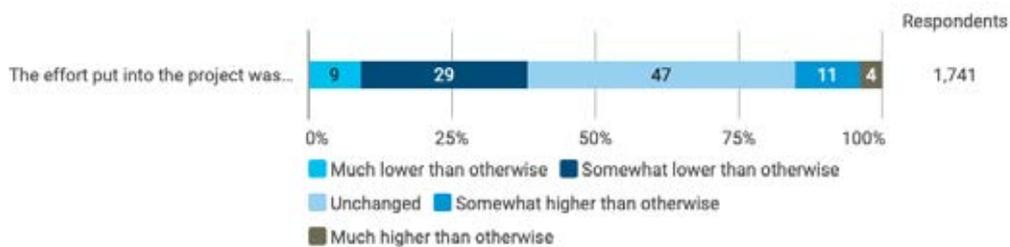
A typical qualitative statement that indicates this is:

"Online lectures are very nice [...] but the lack of face-to-face project work is murder on productivity, especially since a lot of people dont have any discipline and basically stop doing work. Choosing you groupmates have never been more critical "

3. **38 per cent of the students experienced that less effort was put into the project.** See Figure 3.



Figure 3: Perceptions of effort put into the project.



This manifests itself in quotes such as:

"The benefits of both teaching, tutoring, and project meetings are much lower than usual when it comes online."

"Project work is hard to do online you almost have to meet to talk things through. communication between associate professor and students is important to keep the motivation for further participation up [..]"

"It works well that some of the teaching is online, but the group work works really poorly online."

All of the above are causes for concern for group-based PBL-projects, which are central to the degree programmes at AAU and constitute the main active learning component here.

4. Regarding the course teaching, the qualitative part of the survey showed a noticeable preference for pre-recorded presentations to live lectures. The move to online teaching has been a rapprochement to the notion of flipped teaching in that video presentations are becoming widespread, accepted and preferred. However, the rationale of flipped teaching is to move the focus away from presentations to active learning. This was hampered by the absence of an adequate environment for promoting active learning. For PBL, central processes such as meaning negotiations and group dynamics are in danger of being severely hampered by limited technological affordances experienced within an online setting.

Students say:

"More pre-recorded lectures! You get a lot more out of it when you can watch it again pause and rewind"



"Can be a really powerful tool if they are recorded so you make "flipped class room" so you can prepare more as you need also with the opportunity to pause and revisit things. The time you then spend with lecturer can focus on the most difficult things and discussions "

5. The qualitative part of the survey contained considerable references to the detrimental effect of online teaching wrt. the basic principles of PBL. It affects students' internal 'reading' of a situation and of one another, which causes evasive techniques rather than discussions, out of fear of confrontations. The social relationships emerge particularly critical in an online setting as they are inherently important to group work.

Students write:

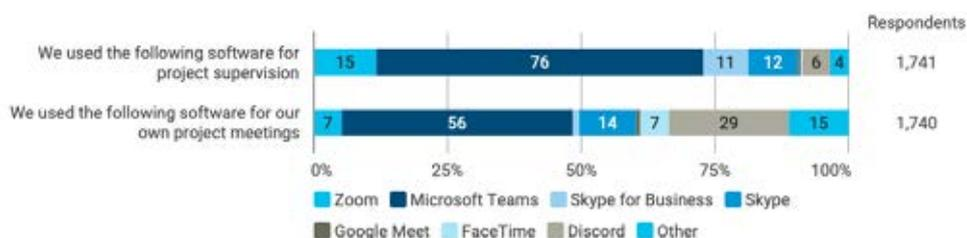
"I think that the principles of PBL can not be fulfilled through online teaching. The knowledge exchange and the communication between both students and professors and within students' groups are less effective and the overall experience is lacking of the fundamental interactions [...]"

"I feel that the lack of the social framework has a great negative effect on one's learning motivation and participation. [...]"

TECHNOLOGICAL OPPORTUNITIES AND DEMANDS

A variety of software was used during the lockdown in 2020. Figure 4 shows the choices of software used for PBL project meetings. AAU subscribes to Microsoft software and Microsoft Teams was predominantly used. It was only in May 2020 that Aalborg University signed a campus-wide licence with Zoom. A popular choice among students was to use Discord for internal project meetings; Discord is widely used by gamers.

Figure 4: Choices of software



It is important to note that none of the software used was specifically designed for online teaching, let alone for PBL. Microsoft Teams was introduced as a replacement for office phonedlines at AAU and for online staff meetings. Zoom was originally intended for videoconferences.



CONCLUSIONS

The findings indicate that students experience less student/teacher interaction, which is particularly detrimental to PBL-work processes. It is important to note that findings in (Hüttel and Gnaur, 2020) indicate that teachers share this opinion. The available technology does not seem to offer any viable solution, at least in the short term. On the other hand, technology provides an alternative to live lecturing in the form of pre-recorded content presentations, although the opportunity for direct interaction is severed. It is though important to remember that spontaneous questions from students are not easily incorporated into physical lectures. It is certainly no better in online settings.

More effort must go into developing new approaches to active learning sessions with structured, teacher-driven interaction in online settings. This also involves designing alternative ways of learning, such as hybrid learning that mediates between different learning spaces – online as well as physical — and makes use of the learning potential in such spaces. For project work this entails involving student supervision, group collaboration as well as association with external partners in these different spaces and navigating across these.

The results of our survey point towards the need for such hybrid approaches as a default mode of orchestrating PBL, which then can be more easily adapted to online settings.

REFERENCES

- Aalborg University (2015). Principles of Problem and Project Based Learning - The Aalborg PBL Model. https://www.aau.dk/digitalAssets/62/62747_pbl_aalborg_modellen.pdf
- Hilli, C., Nørgård, R.T., and Aaen, J.H. (2019) "Designing Hybrid Learning Spaces in Higher Education". Dansk Universitetspædagogisk Tidsskrift, Vol 15, No. 27, pp 66-82.
- Hüttel, H., & Gnaur, D. (2020). How higher education adapted to online teaching at aalborg university after COVID-19: Experiences and perspectives. In European Conference on e-Learning (pp. 243-XV).
- Jahnke, I. (2015) Digital didactical designs: Teaching and learning in Cross Action Spaces. Routledge.
- Jahnke, I., Mårell-Olsson, E., Norqvist, L., Olsson, A., and Norberg, A. (2014) "Digital didactical designs–reimagining designs for teaching and learning". In ICED 2014 conference proceedings Stockholm, pp 15–18.
- Kergel, D. and Heidkamp, B. (2018) "The digital turn in higher education towards a remix culture and collaborative authorship". In The Digital Turn in Higher Education, Springer VS, Wiesbaden, pp 15-22.
- King, Alison (1993). "From sage on the stage to guide on the side". College Teaching. 41 (1): 30–35.



Savin-Baden, M. (2007). A practical guide to problem-based learning online. Routledge.

AUTHOR INFORMATION

Hans Hüttel, hans@cs.aau.dk, Denmark, Aalborg University (corresponding author)

Dorina Gnaur, dgn@hum.aau.dk, Denmark, Aalborg University (corresponding author)

Eskil Olav Andersen, eo@business.aau.dk, Denmark, Aalborg University (corresponding author)



THE HYBRIDISATION OF PBL PEDAGOGIES IS NO IMPEDIMENT TO IMPROVING STUDENT PERFORMANCE IN STATE-WIDE STANDARDISED EXIT EXAMS

Daniel Bateman & Adam Hendry

ABSTRACT

The purpose of this study was to determine whether the implementation of constructivist teaching and learning pedagogies (including hybridised versions) across one secondary school proved no impediment to performance; and indeed, resulted in improved overall student performance in state-wide standardised exit exams. We hypothesised that those cohorts more thoroughly immersed in constructivist pedagogies (including hybridised models) would perform better in the state-wide standardised exit examinations than those cohorts who had been partially educated in more traditional teacher-centred pedagogies in the period 2008 to 2019 due to the staggered implementation of constructivist pedagogies in the school in that time. Moreover, we hypothesised that students educated in constructivist pedagogies performed better again than those graduating classes educated only in more traditional approaches in the school in the period prior. Both hypotheses were supported in this study.

KEYWORDS: Project-based learning, Problem-based learning, Flipped problem-based learning, Flipped Classroom

TYPE OF CONTRIBUTION: Extended scientific abstract

PRESENTATION FORMAT: Roundtable discussion

INTRODUCTION

The notion that 'learning by projects' has been around for over 120 years (Dewey, 1987); and it is over 50 years since McMaster University medical faculty began problematizing curricula to assist students in developing critical diagnostic and soft skills required by doctors. Since that time, 'PBL', in all its forms, has become a popular and effective method of instruction in all areas of education as well as in the private sector. Research into constructivist pedagogies like PBL have reported positive benefits for students such as more developed interpersonal skills, reduced drop-out rates (Schmidt, Van Der Molen, Wijnen & Te Winkel, 2009), improved self-regulation behaviours in learning (Sungur & Tekkaya 2006), as well as the greater retention of knowledge and the fostering of conceptual change (Loyens, Jones, Mikkers & van Gog, 2015). However, as noted by Norman and Schmidt (2000), PBL is practised very differently in different institutions with the little acronym covering "a multitude of sins" (p. 725). They go on, "since PBL has a number of characteristics, it can



be implemented in very different ways in different places” (Norman & Schmidt, 2000, p. 725). Indeed, in most contexts where PBL has been implemented, it has been adapted to meet local conditions and, therefore, has been subjected to some form of hybridisation to varying degrees. That being said, research into hybrid constructivist models has also shown the ability of these hybrid models to improve long-term knowledge acquisition (Carrio et al. 2016) as well as improved problem-solving abilities (Lian & He 2013). There are, however, a lack of studies into how these hybrid constructivist models impact upon student performance in mandated state-wide standardised exit exams in secondary school education.

In New South Wales (NSW), Australia, secondary education culminates in the Higher School Certificate (HSC). The HSC is comprised of a series of in-school assessments that are moderated by a standardised norm-referenced exit exam for each course. These ‘high-stakes’ exams are also used by Australian universities to determine entry into their courses. Although evidence shows that hybrid pedagogies can have positive benefit for students in a range of areas, their impact on student performance in state-mandated assessment has not been demonstrated in Australia. We hypothesise that the use of hybrid constructivist pedagogies are no impediment to student performance in external exams and indeed, may contribute to improved performance better in state-mandated curriculum-based assessment regimes like the HSC.

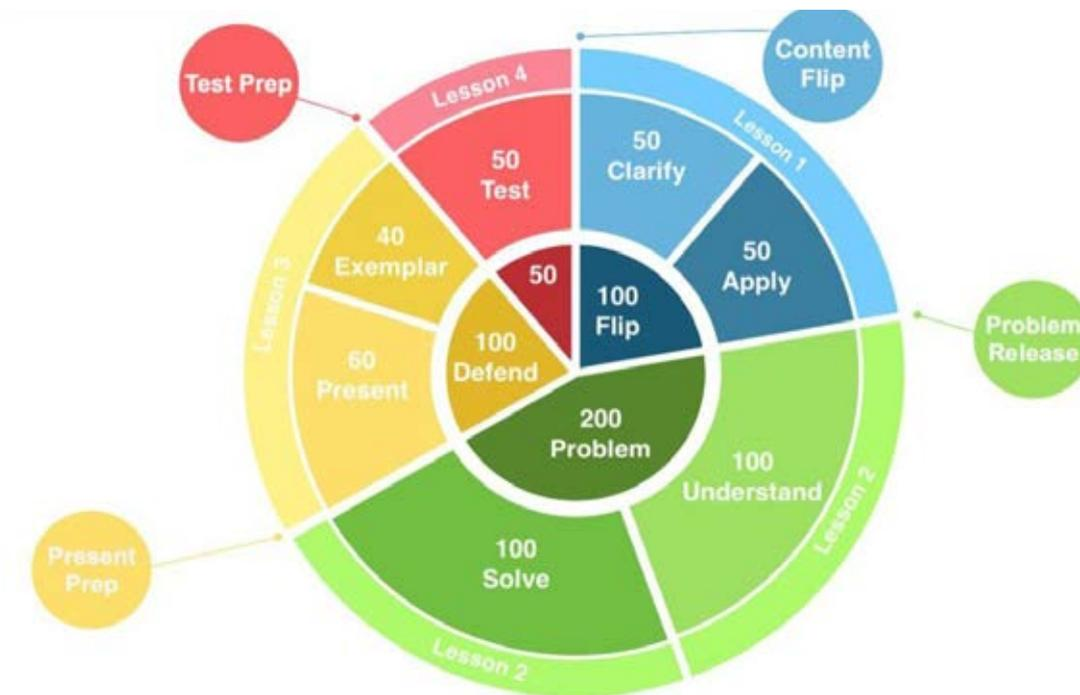
CONTEXT

XXXXXXXX YYYYY High School (XYH), a systemic Catholic comprehensive boys’ secondary school in Western Sydney, has successfully utilised student-centred constructivist pedagogies across the school for more than a decade (A, B, C & D, 2017). The nature, implementation and deployment of these student-centred constructivist pedagogies has changed over this period. Initially, in 2008, Project Based Learning was introduced into the middle school curriculum (Year 9) and into the following school year (Year 10) in 2009. Subsequently, a problem-based Learning approach, derived from the “One Day, One Problem” model pioneered at Republic Polytechnic (RP), Singapore, was adopted as these students moved into their penultimate year of schooling (Year 11) in 2010 (see Yew & O’Grady, 2012). This hybrid model (based itself on a hybrid model?) was known at the school as ‘1-5-1’—this designation indicating the organisation of the 7 hours of learning required over a fortnight to meet state-mandated indicative hours—with the ‘5’ being a full school day dedicated to one problem. In 2013, project-based learning was rolled down into Years 7 and 8 and a ‘Flipped Classroom’ approach was introduced for final year (Year 12) students to better meet the demands of the Higher School Certificate. Following key learnings from the Flipped Classroom approach, contemporary research (Tawfik & Lilly, 2015) and perceived deficiencies with the 1-5-1 model, a Flipped PBL (fPBL) hybrid model was adopted in 2016 in Year 11. The organisation of 7.5 hours of learning over a fortnight in fPBL in Year 11 is shown below in Figure 1.



Figure 1.

Flipped Problem Based Learning hybrid model developed and employed at XXXXXXXX YYYYY High School from 2016 in the penultimate year (year 11) of high school. Numbers represent minutes spent by students in each stage of the model.



This evolution and staggered introduction of constructivist pedagogies over a period of time within the same school with a relatively constant socio-economic status, the same enrolment criteria, and under the same state-wide assessment regime, affords us the opportunity to examine the effect of all constructivist approaches and in particular, the hybridised PBL approaches, on student performance in the state-wide standardised exit exams and be able to compare these effects to traditional methods of teaching within the school prior to whole school pedagogical change.

OBJECTIVES

The purpose of this study was to determine whether the implementation of hybrid constructivist teaching and learning pedagogies proved no impediment to performance and indeed, resulted in improved overall student performance in state-wide standardised exit exams. Echoing similar findings at university level (Freeman et al., 2014), we hypothesised that those cohorts more thoroughly immersed in constructivist pedagogies (including hybridised models) would perform better in the HSC examinations than those cohorts who had been partially educated in more traditional teacher-centred pedagogies in the period 2008 to 2019



due to the staggered implementation of pedagogies; and better again than those educated in more traditional approaches in the school in the period prior.

METHODOLOGY

To determine whether the implementation of PBL and hybrid pedagogies resulted in improved HSC performance, the HSC marks of every course studied by every student at XYH from 2008 to 2019 were collected (n = 9516). As shown in Table 1, graduating cohorts were divided into four groups representing the different combinations of pedagogies employed during their time at XYH.

Table 1. Four different combinations of pedagogies utilised at XXXXXXXX YYYYY High School from 2008-2019.

Pedagogical Combination	Years 7 & 8	Years 9 & 10	Year 11	Year 12	Time period
1	Project-based learning	Project-based learning	Flipped problem-based learning	Flipped	HSC Classes 2017-2019 (n=2332)
2	Traditional	Project-based learning	1-5-1 problem-based learning	Flipped	HSC Classes 2013-2016 (n=3130)
3	Traditional instruction	Project-based learning	1-5-1 problem-based learning	Traditional instruction	HSC Classes 2011-2012 (n=1548)
4	Traditional instruction	Traditional instruction	Traditional instruction	Traditional instruction	HSC Classes 2008-2010 (n=2506)

Initial investigations revealed that assumptions of normality could not be made, hence a Kruskal Wallis test (non-parametric one-way ANOVA) was used to assess whether differences occurred between the different pedagogical treatments at $\alpha < 0.05$. Separate post hoc Mann Whitney U tests were used to determine where the differences between treatments occurred. Given that multiple tests were implemented, a Bonferroni correction was applied such that differences were deemed significant at $\alpha < 0.008$.

RESULTS

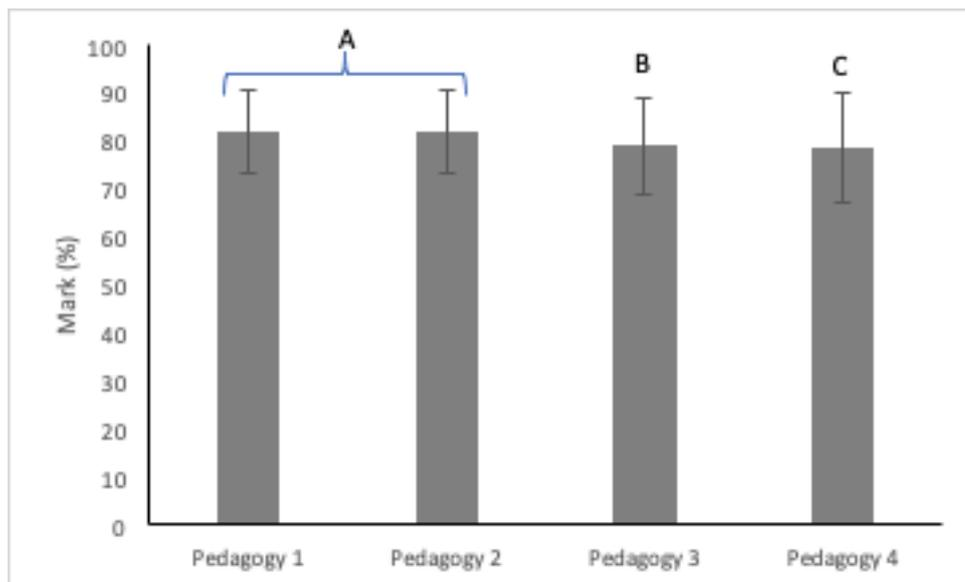
Differences were found between the different pedagogies used at XYH from 2008 to 2019 ($\chi^2 = 288.07$, $df = 3$, $p < 0.001$). Post hoc tests revealed no difference between hybrid pedagogies 1 and 2, but both of these pedagogies resulted in greater mean HSC marks than pedagogy 3, and all three hybrid pedagogies had higher HSC marks than pedagogy 4 - traditional teacher-centred learning (Table 2, Fig. 2).



Table 2. Results of post hoc Mann Whitney U tests exhibiting differences in HSC marks between different pedagogies (Pedagogy A vs. Pedagogy B) used at XYH 2008-2019. Bonferroni correction used, so differences significant at $\alpha < 0.008$.

Pedagogy A	Pedagogy B	Z	p-value
1	2	-1.313	0.189
1	3	-9.523	<0.001
1	4	-13.827	<0.001
2	3	-8.830	<0.001
2	4	-13.559	<0.001
3	4	-3.724	<0.001

Figure 2. Mean (\pm SD) HSC marks of students exposed to one of four different hybrid teaching and learning pedagogies at XYH 2008-2019. Letters indicate significant differences between pedagogies at $\alpha < 0.008$.



DISCUSSION

As hypothesised, our findings indicate the more that students were educated in constructivist pedagogies (including hybridised problem based learning models), the better they performed in state-wide standardised exit exams than those who were less immersed in those pedagogies over their time at school; and even more than those who were educated through more traditional, passive, teacher-centred methodologies. While not examining the mechanism that drives this improved performance, we show here that the implementation of hybrid constructivist teaching and learning pedagogies can also lead to improvements in student



performance. These findings have implications for teachers who see the implementation of such hybrid pedagogies as too time-intensive to implement especially when constrained by a prescriptive state-mandated curriculum. Additionally, the notion that students educated in a constructivist pedagogy may be better able to develop '21st century' skills at the expense of performance in traditional assessment modes is not supported here either.

CONCLUSIONS/RECOMMENDATIONS/LIMITATIONS

Whilst more detailed research is required, it can be safely said that the hybridisation of PBL models (at least in the context of this school) is certainly no impediment to performance in state-wide standardised exit exams and perhaps, the more immersive the experience for students, the better they perform in those exams. To what extent these hybrid pedagogies contribute to that performance requires further investigation, especially in the context of whole school implementation of constructivist pedagogies.

REFERENCES

- Carrió, M., Agell, L., Baños, J., Moyano, E., Larramona, P., Pérez, J., & Fahnert, B. (2016). Benefits of using a hybrid problem-based learning curriculum to improve long-term learning acquisition in undergraduate biology education. *FEMS Microbiology Letters*, 363(15), FEMS Microbiology Letters, 2016, Vol. 363(15).
- Dewey, J. (1897) My Pedagogic Creed, in: J. J. McDermott (ed.), (1973) *The Philosophy of John Dewey: The lived experience* (New York, Capricorn Books).
- Freeman, S., Eddy, S., McDonough, M., Smith, M., Okoroafor, N., Jordt, H., & Wenderoth, M. (2014). Active learning increases student performance in science, engineering, and mathematics. *Proceedings of the National Academy of Sciences of the United States of America*, 111(23), 8410-8415. A, B, C & D, 2017.....
- Lian, J., & He, F. (2013). Improved performance of students instructed in a hybrid PBL format. *Biochemistry and Molecular Biology Education*, 41(1), 5-10.
- Loyens, S., Jones, S., Mikkers, J., & Van Gog, T. (2015). Problem-based learning as a facilitator of conceptual change. *Learning and Instruction*, 38, 34-42.
- Norman, G. R., & Schmidt, H. G. (2000). *Effectiveness of problem-based learning curricula: theory, practice and paper darts*. *Medical Education*, 34, 721–728.
- Schmidt, H., Van Der Molen, H., Te Winkel, W., & Wijnen, W. (2009). Constructivist, Problem-Based Learning Does Work: A Meta-Analysis of Curricular Comparisons Involving a Single Medical School. *Educational Psychologist*, 44(4), 227-249.



Sungur, S., & Tekkaya, C. (2006). Effects of problem-based learning and traditional instruction on self-regulated learning. *The journal of educational research*, 99(5), 307-320.

Tawfik, A., & Lilly, A. (2015). Using a Flipped Classroom Approach to Support Problem-Based Learning. *Technology, Knowledge and Learning*, 20(3), 299-315.

Yew, E., & O'grady, G. (2012). One-Day, One-Problem at Republic Polytechnic. In *One-Day, One-Problem: An Approach to Problem-based Learning* (2012 ed., pp. 3-19). Singapore: Springer Singapore.

AUTHOR INFORMATION

Daniel Bateman, dbateman@parra.catholic.edu.au, Australia, Parramatta Marist High (corresponding author)

Adam Hendry, ahendry@parra.catholic.edu.au, Australia, Parramatta Marist High (corresponding author)



HYBRID DESIGN THINKING MODEL TO PROJECT DEVELOPMENT IN EXECUTIVE EDUCATION AT FDC

Carolina Costa Cavalcanti, Cintia Vasques Hércias, Lília Mascarenhas & Cristiane Baeta

ABSTRACT

Design Thinking (DT) has been used as a hybrid learning model by 70 executives that participated in the 2019 class of the Executive Development Program (EDP) offered by Fundação Dom Cabral (FDC) - Brazil. In 2019, the program held online activities and face-to-face classes organized in 3 modules. In each module, participants had to access contents indicated by their business professors that covered topics on management, strategy, leadership, entrepreneurship, finances, innovation, sustainability (among others). At EDP, learning was put into practice by the executive participants through the development of the Value Generation Project (VGP). VGP focused on articulating concepts discussed in EDP classes with a real problem situation that the participants faced in their organization or career. The methods and strategies of Design Thinking were adopted in VGP and the program participants counted with a mentor (an FDC teacher specialist on the subject investigated in the project) to guide them through the different phases of project development. The VGP schedule, contents, guiding materials and activities were organized in the program's Learning Management System (LMS). EDP participants accessed these materials and started to work on the project by choosing a strategic challenge they wanted to solve in the next couple of months while developing VGP. Then, participating in activities proposed in the LMS the executives went through the DT phases: Hear, Create, Implement (IDEO, 2009). As a result, 32 projects were developed through the use of the DT hybrid project model at the VGP program.

KEYWORDS: Design Thinking, Hybrid Learning Model, Project Development, Executive Education, Active Methodologies

TYPE OF CONTRIBUTION: Practice-based abstract

PRESENTATION FORMAT: Roundtable discussion

EXTENDED PRACTICE-BASED ABSTRACT

This paper presents how Design Thinking (DT), a creativity and innovation methodology, has been used in a hybrid learning model by 70 executives that participated in the 2019 class of the Executive Development Program (EDP) offered by Fundação Dom Cabral (FDC) in Brazil. According to the 2019 Financial Times Ranking, FDC in the



best business school in Latin America and is among the 15 best schools in the world. In 2019, the 84th class of EDP was offered to executives from more than 30 large, medium and small national and multinational companies. This is an FDC's traditional short-term program (with 3 months duration) that aims to expand the understanding and mastery of leaders that have influence in organizations and institutions strategy, enabling them to better intervene in processes and projects under their responsibility adding value to the business and to society in a sustainable manner.

In 2019, the program's curriculum was remodeled and offered in a hybrid learning model with online activities and face-to-face classes organized in 3 modules. The first module featured face-to-face classes at the FDC campus in Nova Lima between 6/24 to 6/28, the second module classes were held at FDC's São Paulo campus from 8/5 to 8/9 and the third module was held in São Paulo from 10/23 to 10/25. In each module, participants had to access contents indicated by their business professors that covered topics on management, strategy, leadership, entrepreneurship, finances, innovation, sustainability (among others).

At EDP, learning was put into practice by the executive participants through the development of the Value Generation Project (VGP). The project development methodology was also remodeled and in 2019 the VGP focused on articulating concepts discussed in EDP classes with a real problem situation that the participants faced in their organization or career. The methods and strategies of Design Thinking were adopted in VGP and the program participants counted with a mentor (an FDC teacher specialist on the subject investigated in the project) to guide them through the different phases of project development.

The VGP schedule, contents, guiding materials and activity were organized in the program's Learning Management System (LMS). EDP participants were organized in groups, accessed these materials and started the project by choosing a strategic challenge they wanted to solve in the next couple of months while participating in VGP. Next they participated in a two hours face-to-face class section held in module 1 where the project technical coordinator gave general orientations on the project methodology and presented the mentors.

Then, participating in activities proposed in the LMS the executives went through the DT phases: *Hear, Create, Implement* (IDEO, 2009). In the *Hear* phase they collected data related to the problem they intended to solve through observation, empathic interview, immersion, and analyzed the data using DT strategies like empathy map, persona and users' journey. Next, in the *Create* phase, they held brainstorming sections and categorized the best ideas created. Finally, they developed prototypes of the solutions to be implemented in their organizations, which were evaluated by two external experts in a two hours *Express Mentoring* face-to-face



section held in module 2. At that section, they heard suggestions from the specialists and other program participants on how to improve the prototype. Each participant also had the chance to comment on other group's projects. Finally, the groups refined the prototypes and developed an implementation plan. In the last face-to-face class section held at module 3, the prototypes and the implementation plan were presented by each group and to their organization sponsors, other program participants and mentor. Each project received feedback on how to implement the prototype in the organization context. The participants were also able to see the results of other group's VGP work.

As a result, 32 projects were developed through the use of the DT hybrid project model at the EDP program. In the paper we will briefly present a couple of very creative prototypes elaborated by the program participants and how the methodology helped these business executives create solutions that are desirable to the stakeholders, financially viable and technically practicable. Most participants mentioned in the program's evaluation form that the hybrid model and methodology adopted to develop the VGP added value to their learning experience at the Executive Development Program.

REFERENCES

IDEO. HCD Toolkit. Palo Alto: Ideo, 2009. Disponível em: <<http://www.ideo.com/work/human-centered-design-toolkit/>>. Acesso em: set. 2016.

CAVALCANTI, C. C. & FILATRO, A. Design Thinking na Educação. São Paulo, Saraiva, 2019.

D.SCHOOL. Bootcamp Bootleg. Palo Alto: Hasso Plattner Institute of Design at Stanford, 2011. p. 1-44. Disponível em: <<http://dschool.stanford.edu/wp-content/uploads/2011/03/BootcampBootleg2010v2SLIM.pdf>>. Acesso em: set. 2016.

DUNNE, D.; MARTIN, R. Design thinking and how it will change management education: an interview and discussion. *Academy of Management Learning & Education*, v. 5, n. 4, p. 512-523, 2006.

HASSI, L.; LAAKSO, M. Conceptions of design thinking in the design and management discourses. In: 4TH WORLD CONFERENCE

ON DESIGN RESEARCH – IASDR 2011, Delft, Netherlands. Anais Delft, Netherlands, 2011.

AUTHOR INFORMATION

Carolina Costa Cavalcanti, carolinacavalcanti.ead@gmail.com, Brazil, Invited professor at Fundação Dom Cabral (corresponding author)



Cintia Vasques Hércias, cintia.vasques@fdc.org.br, Brazil, Fundação Dom Cabral (corresponding author)

Lília Mascarenhas, lilia.mascarenhas@fdc.org.br, Brazil, Fundação Dom Cabral (corresponding author)

Cristiane Baeta, cbaeta@fdc.org.br, Brazil, Fundação Dom Cabral (corresponding author)



STUDENT COLLABORATION IN A HYBRID PBL ENVIRONMENT – DIVERSITY IN COLLABORATION PRACTICE

Mia Thyrré Sørensen

ABSTRACT

This abstract presents the preliminary results of a multi-sited ethnographical study of students' collaboration in a hybrid PBL environment. By short descriptions of five project groups, focusing on digital technology, meeting frequencies and –locations, the abstract illustrates the diversity in the collaboration practice across the groups. Further, it argues that empirical insights on students' collaboration practice and use of technology is essential for nuance the debate on technology and education. Empirical studies, showing the hybridity and diversity of self-directed learning, can move the debate from deterministic questions of use-or-not-use to concerns of how to support students to develop and reflect on their existing digital practice.

KEYWORDS: PBL, technology, collaboration

TYPE OF CONTRIBUTION: Practice-based abstract

PRESENTATION FORMAT: Roundtable discussion

INTRODUCTION

Technology has become an embedded and almost unremarkable feature of higher education. Students work in hybrid learning environments, and their informal use of technology increasingly influences their academic life. Several demands further empirical scrutinise of students' self-organised use of technology for learning; how students *actually* use technology (Henderson *et al.*, 2015), how they configure learning spaces for self-directed learning (Ellis and Goodyear, 2016) and mobile learning across formal and informal context (Traxler and Kukulska-Hulme, 2016).

This abstract presents preliminary findings from a multi-sited ethnographical study of students' collaboration in a hybrid problem-based and project-oriented learning (PBL) environment. We have followed project groups across physical and digital field sites. Ryberg, Davidsen and Hodgson (2017) argue that a hybrid environments leads to “*complex entanglements between physical and digital technologies, spaces, activities and time*”, and that a one-sided focus on the digital can make us overlook essential aspects of the students' collaboration practice.



By short descriptions of the five participating project group focusing on meeting time and space, the abstract illustrate diversity in collaboration practice across groups.

The project is a part of subproject 2 of the PBL future project carried out at Aalborg University (AAU) 2017-2020.

THE HYBRID PROJECT AND PROBLEM-BASED LEARNING ENVIRONMENT

Since the augmentation in 1974, AAU has practised and developed a project-oriented and problem-based pedagogical model, implemented across the entire university (AAU, 2015). Each semester (3-4 months), students work in groups of 4-6 members with an authentic and self-selected problem. The project work provides a framework for the students to formulate, analyse and solve their problem. The students have a joint responsibility to plan and manage the work process. Each group is assigned a supervisor functioning as process facilitator and professional support. At the end of the semester, the project groups hand in a joint report.

Students use a variety of digital tools to support their collaboration and project management; among other things, students apply technology for communication, sharing resources, organising of project work and collaborative writing.

AN ETHNOGRAPHICAL STUDY

The study has taken form as a multi-sited and connective ethnographical study (Hine, 2015). During a semester, we have followed five project groups from study programmes across the faculties of the university. We have followed project groups across digital and physical field sites; meetings at physical locations and activities on the digital platforms, they applied. We have met with each group 10-12 times. As ethnographical memory, at each observation, we made field notes and video recording. Additionally, photos, screenshot and -recordings of activities on digital platforms were done in the case it was found relevant. Between each observation, we follow their activity on the digital platform, taking screen-shots and making notes.

Table 1: Overview of the project groups

Study programme	Sport Science	Robotics	Communication	Machine and Production	Sociology
Semester	6 th	6 th	4 th	6 th	6 th
Members	2 female + 2 male	4 male	3 female 3 male	1 female 3 male	4 female



Technologies applied for organisation and collaboration (excluding discipline- specific tools)	Facebook Google Docs Google Drive	Discord Facebook Google Docs Google Drive Overleaf	Facebook Google Calendar Google Docs Google Drive Trello	Facebook MS Onedrive Overleaf	Facebook Google Docs Google Drive
Meetings	Varied over the project period	Daily meetings	Varied over the project period	Daily meeting	Weekly meeting
Dedicated group room	No	Yes	No	Yes	No
Locations	Library Meeting-room	Group room Virtual meetings Laboratory	Open study area Meeting room	Group room Laboratory	At home Meeting room

RESULTS

In the current study, we have identified diversity in the collaboration practice of the participating project groups. In the following, five short descriptions of the group, focusing on technology for collaboration, meeting frequency and –locations will illustrate this diversity.

Table 1 provides an overview of the five project groups; study programs, members, technology, meeting frequency and locations. The facilities vary for each study program, e.g. whether or not the groups shared group room (See Table 1).

Sport Science

The group studying Sports Science meets various places. They visit the library's sofa corner several times. The atmosphere is informal; the conversation shifts dynamically between project-related topics and small-talk regarding cakes and films. They have a 'calendar'- document, in where they write meeting time for the coming days (or if they work from home.) However, the agreements are often changed ad-hoc through Facebook Messenger. Sometimes with less than a half hour's notice. Halfway in the project-period, the group stops updating the 'calendar'-document. Instead, they do day-to-day planning though Facebook. No plan sticks anyway, they argue. More often, they work from home because it is more productive than sitting together working.

Robotics

The group studying Robotics meets either in their group room, the laboratory or Discord, a virtual platform initially created for video gaming. They usually hold status meetings at 9 am daily.

Where they meet, they agree on a daily basis. The group members know each other well both from previous projects and as good friends. The conversation quickly moves over to not project-related topics. According to the group, however, it happens to a lesser extent when they meet virtually.



They talk and write to each other in Discord, all while they write in Overleaf, an online Latex collaborative writing editor, or Google Docs. They dynamically shift between work individually (with muted sound), in pairs (via two voice channels) and all four together.

Communication

The group studying Communication often meets in an open study area. When the group meets it rather sit together when they work, or for a meeting. At the meeting, an agenda is both written at a blackboard and in a shared Google document, in which they collaboratively write. How often they meet vary. Some days a part of the group meets while others work from home. They use Google Calendar for schedule meeting and deadlines and Trello for coordinating tasks. They do not update the platforms regularly. Instead, they use the tools, when they “need an overview”.

Machine and production (MP)

The MP group meet daily from 9 am to 4 pm in the group room - unless they have lectures or are in the laboratory. They have furnished the group room with fridge, coffee maker, music system and “minibar” and in the corner stands two bags overflowing with empty bottles. The cleaning staff has called it a messy boy's room. Two of the members brought their stationary displays. The blackboards witnesses of professional discussions and planning; however, plans on the boards are not always updated. They work primarily individually. There is good support from the group, where questions and answers are regularly exchanged over the screens.

Sociology

The group studying sociology meets in the apartment of a group member - at lecture or supervisor meeting they meet on campus. They meet around once a week. A group member lives an hour and a half-hour away from the university. The rest of the time, they work individually from home. The evening or the morning before they meet, they read the new-written text, which they mark by changing the text-colour, and write comments. When they meet, they go over and review the new- written text, including comments. The conversation becomes incomprehensible without any insight into what is going on in Docs. Written and oral comments go into the conversation on an equal footing.

CONCLUDING DISCUSSION

The above descriptions substantiate that the students work in hybrid learning environments, where the physical and the digital are deeply interwoven. Furthermore, it shows a great extent of diversity in the collaboration practice across groups. The hybridity and diversity of the student practice challenges the deterministic approach, which characterises the everyday discourse as well as the academic debate regarding education and technology (Selwyn, 2012). A typical deterministic stance is the students are non-competent



digital learners because they mostly use commercial tools and not ‘professional’ or ‘academic’ tools. The empirical data shows complex collaboration practices; students use of technology dynamically, move fluidly physical and digital contexts and between technologies and adjust their practice due to ‘what works’. Empirical studies, showing the hybridity and diversity of self-directed learning, can move the debate from questions of use-or-not-use to concerns like how to support students to develop and reflect on their current digital practice.

REFERENCES

AAU (2015) *Problem-based Learning*. Available at: https://www.aau.dk/digitalAssets/148/148025_pbl-aalborg-model_uk.pdf (Accessed: 29 January 2020).

Ellis, R. A. and Goodyear, P. (2016) ‘Models of learning space: integrating research on space, place and learning in higher education’, *Review of Education*, 4(2), pp. 149–191. doi: 10.1002/rev3.3056.

Henderson, M. *et al.* (2015) ‘Students’ everyday engagement with digital technology in university: exploring patterns of use and “usefulness”’, *Journal of Higher Education Policy and Management*. Routledge, 9508(June), pp. 1–12. DOI: 10.1080/1360080X.2015.1034424.

Hine, C. (2015) *Ethnography for the Internet: embedded, embodied and everyday*. VLE Books.

Ryberg, T., Davidsen, J. and Hodgson, V. (2017) ‘Understanding nomadic collaborative learning groups’, *British Journal of Educational Technology*. doi: 10.1111/bjet.12584.

Selwyn, N. (2012) ‘Making sense of young people, education and digital technology: the role of sociological theory’, *Oxford Review of Education Vol*, 38(1), pp. 81–96. DOI: 10.1080/03054985.2011.577949.

Traxler, J. and Kukulska-Hulme, A. (2016) *Mobile learning: the next generation*. Routledge.

AUTHOR INFORMATION

Mia Thyrrø Sørensen, mts07@hum.aau.dk, Denmark, Aalborg University (corresponding author)



A HYBRIDIZED PBL LANGUAGE COURSE DESIGN MODEL

Saleh Al-Busaidi & Tariq Yusuf

ABSTRACT

Problem based learning (PBL) has been widely lauded as a teaching approach that addresses the needs of a rapidly changing world informed by the rise of digital technology and the complexity and connectedness associated with globalization. While PBL has been extensively implemented in a wide-ranging number of disciplines and subjects, it remains relatively unexplored as a tool for enhancing language learning. This paper consolidates the expertise acquired through implementing PBL in a number of courses at the Center for Preparatory Studies at Sultan Qaboos University, Oman, and proposes a working model for designing innovative hybrid PBL courses with the aim of enhancing language learning and teaching.

KEYWORDS: Hybrid, language learning, Oman, Problem-based learning

TYPE OF CONTRIBUTION: Practice-based abstract

PRESENTATION FORMAT: Roundtable discussion

INTRODUCTION

Based on the constructivist epistemology, problem-based learning is student-centered and focused on the development of skills through an extended and collaborative process of enquiry using complex, ill-structured problems based on real-world situations (Hmelo-Silver, 2004). There has recently been a significant increase in the use PBL across disciplines, age levels and content domains largely in response to the perceived inadequacy of traditional practices in preparing learners for the changing needs of the 21st century. Growing evidence suggests that PBL is more effective than traditional teaching methods in the development of cooperative learning, integration of information, critical thinking, problem-solving, communication skills, self-directed learning, and retention and application of knowledge (Dolmans, Grave, Wolfhagan & Vleuten, 2005; Hmelo-Silver, 2004; Kain, 2003; Kim, 2019). In language instruction, there has been widespread acknowledgement of the potential benefits of PBL. A few studies have investigated the effects of PBL on language performance (Jiriyasin, 2014), vocabulary acquisition (Lin, 2015), and students' perceptions (Azman & Shin, 2012). However, research on design and implementation has been very limited. This dearth of research may be due to "limiting



conditions” including resources, student attitudes towards active learning and time constraints (Lin, 2016, pp. 53-54).

CONTEXT AND RATIONALE

The study took place at the Center for Preparatory Studies at Sultan Qaboos University, a government university in the Sultanate of Oman. The University has a student population of around 18,000 in nine colleges. English is the medium of instruction in most programs. Students receive intensive English instruction upon admission for one to three semesters. This is followed by additional, more specialized credit bearing language support courses (e.g. English for medicine, English for science, English for engineering) that students take concurrently with their college courses. The PBL language course design model was initially applied to one of the credit courses, titled LANC2058, which is a course taken by the College of Science students. This alternative course design was adopted because of the need to restructure the existing course that was no longer deemed suitable in terms of equipping students with the necessary language and academic skills, and the requirements of the 21st century. It was also based on the premise that problem formulation as a learning framework can enhance students’ cognitive skills through a collaborative teamwork (Palupi, Subiyantoro, Rukayah, & Triyanto, 2020). The work on implementing a PBL approach started in spring 2011 and the course was implemented in the fall of that year. The model was developed over the course of seven years and builds on insights and observations over 14 iterations of the course involving 2800 students and 14 teachers.

THE UNDERLYING PRINCIPLES OF THE MODEL

The proposed model is based on three main principles: hybridization, scaffolding and the development of a PBL culture. With regards to hybridization, effective implementation necessitates a recognition of institutional and curricular constraints, existing resources and teaching methodologies, teacher training capabilities and student culture, expectations and abilities. In our own case, PBL was integrated into existing courses incrementally, moving from a structured, teacher-driven hybrid course to a more learner-centered course embodying more targeted scaffolding and teacher support. This reflects the difference between *standard* and *hybrid* forms of PBL, which lies in the level of supplementation, facilitation, support and scaffolding. Standard PBL formats provide little or no support, and promote a more self-directed and self-regulated learning environment. In EFL contexts, the implementation of standard PBL can raise a number of issues and challenges for students. Students may not have the requisite language and study skills to engage effectively with the PBL process and they may lack awareness of the expectations of PBL because of their educational background (Azman & Shin, 2012, p.110). Therefore, more hybrid forms of PBL integrating scaffolding may be suited to institutions that “want to benefit



from the advantages of PBL methodology but do not want a complete reform to switch to an entirely PBL-based curriculum” (Carrió et al., 2016, p.1).

The second principle is scaffolding which refers to the “tools, strategies, or guides that enable learners to reach higher-levels of understanding and performance than would be possible without them” (Wood, Bruner, & Ross, 1975 as cited in Ertmer & Simons, 2006, p. 44). Scaffolding can include providing clear direction, clarifying purpose, keeping students on task and elucidating expectations (McKenzie, 1999). It can help support weaker students who have less proficiency in the use of thinking skills but the extent and amount of scaffolding can be reduced over time as students adapt to the new learning environment (Hmelo-Silver & Barrows, 2006). We explain this concept in more detail in the description of the model.

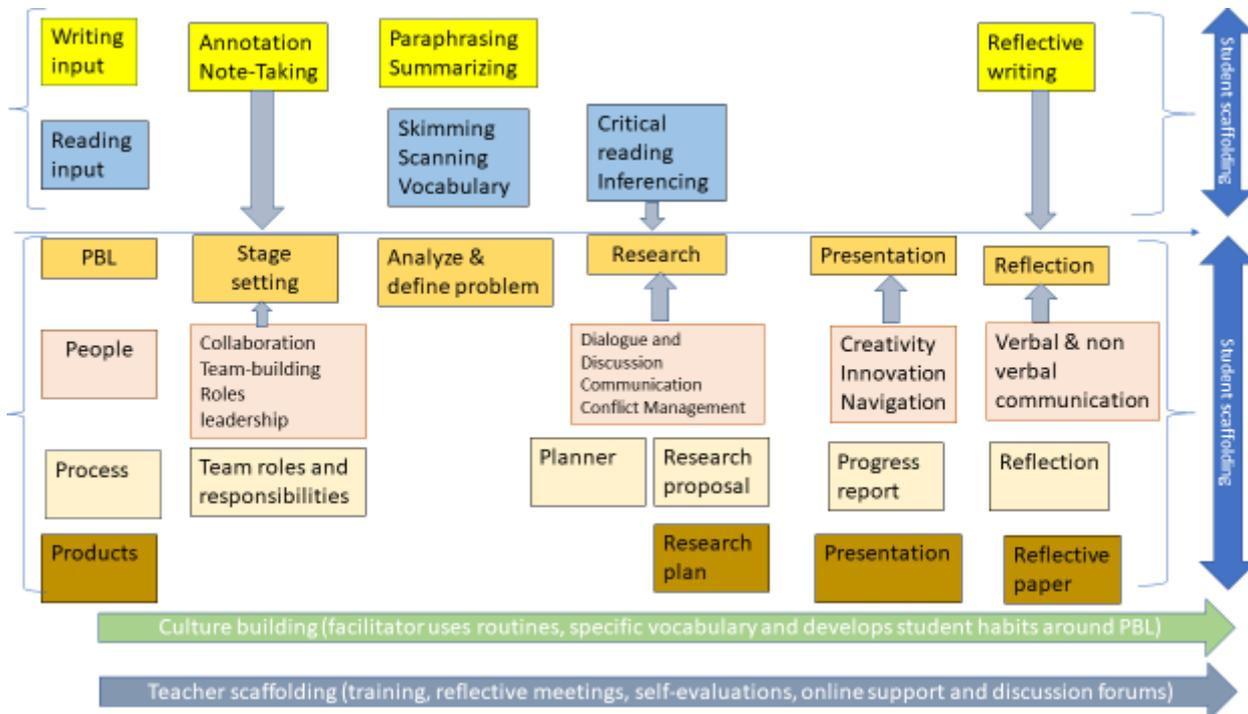
The third principle is developing a PBL culture among students and teachers. Moving from traditional teacher-centered instructional methods to a learner-centered PBL approach requires a shift in the classroom culture (Lee & Blanchard, 2019). In his definition of culture, Kennedy (2002, p. 430) states that, “Culture is not just a matter of overt behavior, it is also the (social) rules, beliefs, attitudes and values that govern how people act and how they define themselves”. PBL is about inquiry, self-directed learning, collaboration and risk taking which are necessary for learner active engagement and productivity (Boss & Larmer, 2018). Students may be used to a particular way of learning and teaching style. Developing a learning environment where students work jointly to achieve a common goal definitely necessitates a change in the mindset of students, teachers and administrators. In other words, the implementation of PBL requires not only endorsing a certain course material but more importantly it is about emphasizing and fostering the underlying principles and values that underpin the approach. The development of such a learning environment that is conducive to PBL requires learners who “have shared goals and experiences, who feel empowered to contribute, who trust in one another, and who feel understood and capable as individuals” (Kane, 2016, p.1).

THE MODEL

The model, as shown in Figure 1, can be divided into three main levels: process, skills support and language input. These levels reflect the range of skills that can help facilitate students through problem solving. In the process, students go through certain steps such as stage setting, analyzing and defining the problem, research, presentation and reflection. Students are presented with an ill-structured, real-world problem and work in groups to resolve the problem through pre-defined steps.



Figure 1: A hybridized PBL Model



The number of steps and how the process is broken up is dependent on a number of factors including the timeframe of the course, assessment and course objectives. These steps also act as the organizing feature or backbone of the course in terms of providing a solid foundation around which to add or design supplementary support and scaffolding. In our case, we designed the course around five main component steps with students completing each step in approximately two-three weeks. The second level of the model is student scaffolding and support in terms of input that guides students through the process of PBL. Students receive scaffolding throughout the process of problem solving through inputs (hard and soft) at the level of the people skills they require to complete the tasks. Visualizing the scaffolding in terms of people, process and product skills allows for more targeted and needs-driven support for students. A student handbook organized around the PBL steps was produced. The handbook provides a range of activities and materials that students complete at each stage of the PBL process. The third level of the model is the language input. This was the *hybrid* part of the course which used traditional inputs in terms of a course-book which was designed based around the language learning objectives of the course. This part of course was taught traditionally but progressed in tandem with the PBL course so that language input was aligned to the steps in the PBL process in such a way that positions the target language as



both the object and vehicle of learning (Greenier, 2018). Finally, the model incorporates teacher scaffolding and culture building as important elements in the PBL process. This was achieved through guided-training, seminars and workshops.

CONCLUSION

Problem-based learning can potentially help foster competencies learners require to engage more effectively with a globalized and interconnected world. However, the implementation of PBL in traditional language learning environments can raise a number of fundamental challenges. The proposed model has attempted to address some of them through hybridization, scaffolding and developing a supportive culture. We believe that these are important considerations of working around rigid institutional and curricula requirements. It is our hope that our model may support future implementations of successful PBL.

REFERENCES

- Azman, N. & Shin, L. K. (2012). Problem-based learning in English for a second language classroom: Students' perspectives. *The International Journal of Learning*, 18(6), 109-126. DOI: [10.18848/1447-9494/CGP/v18i06/47648](https://doi.org/10.18848/1447-9494/CGP/v18i06/47648)
- Boss, S., & Larmer, J. (2018). *Project based teaching: How to create rigorous and engaging learning experiences* (3rd ed.). ASCD: Novato, CA: USA.
- Carrió, M., Agell, L., Baños, J., Moyano, E., Larramona, P., & Pérez, J. (2016). Benefits of using a hybrid problem-based learning curriculum to improve long-term learning acquisition in undergraduate biology education. *FEMS Microbiology Letters*, 363(15), 1-7. <https://doi.org/10.1093/femsle/fnw159>
- Dolmans, D.H., W. De Grave, I.H. Wolfhagen, and C.P. Van der Vleuten. (2005). Problem-based learning: future challenges for educational practice and research. *Medical Education*, 39, 732–41.
- Ertmer, P. & Simons, K. (2006). Jumping the PBL implementation hurdle: Supporting the efforts of K–12 teachers. *Interdisciplinary Journal of Problem-based Learning*, 1(1), 40-54.
- Greenier, V., T. (2018) The 10Cs of project-based learning TESOL curriculum, *Innovation in Language Learning and Teaching*, DOI: [10.1080/17501229.2018.1473405](https://doi.org/10.1080/17501229.2018.1473405)
- Hmelo-Silver, C.E. (2004). Problem-based learning: what and how students learn. *Educational Psychology Review*, 16(3), 235–66.



- Hmelo-Silver, C. E., & Barrows, H. S. (2006). Goals and strategies of a problem-based learning facilitator. *Interdisciplinary Journal of Problem-based Learning*, 1(1), 21-39.
- Jiriyasin, T. (2014). Enlivening EFL discussion classrooms with a problem-based learning approach. *Journal of Language Teaching and Learning in Thailand*, 47, 129-146. Retrieved on May 18, 2019 from: <http://www.culi.chula.ac.th/Research/e-Journal/2011/Tanisaya.pdf>
- Kain, D. L. (2003). *Problem-based learning for teachers, grades 6-12*. Boston: Allyn and Bacon.
- Kane, K. (2016, December 8). Back to school: Why creating classroom community is so important. Naeyc. <https://www.naeyc.org/resources/blog/why-creating-classroom-community-so-important#:~:text=Strong%20communities%20have%20members%20who,draw%20on%20one%20another's%20skills.>
- Kennedy, P. (2002). Learning cultures and learning styles: Myth-understandings about adult (Hong Kong) Chinese learners. *International Journal of Lifelong Education*, 21(5), 430-445. DOI: 10.1080/02601370210156745
- Kim, Y. (2019). Observational application comparing problem-based learning with the conventional teaching method for clinical acupuncture education. *Evidence-Based Complementary and Alternative Medicine*, 2019, 1-6. <https://doi.org/10.1155/2019/2102304>
- Lee, H., & Blanchard, M. R. (2019). Why teach with PBL? Motivational factors underlying middle and high school teachers' use of problem-based learning. *Interdisciplinary Journal of Problem-Based Learning*, 13(1), 1-20. <https://doi.org/10.7771/1541-5015.1719>
- Lin, L. F. (2015). The impact of problem-based learning on Chinese-speaking elementary school students' English vocabulary learning and use. *System*, 55, 30-42. DOI: [10.1016/j.system.2015.08.004](https://doi.org/10.1016/j.system.2015.08.004)
- Lin, L. F. (2016). The effects of the task-based language teaching and the presentation-practice-production models on grammar instruction. *Journal of English Education*, 5(1), 45-79.
- McKenzie, J. (1999). Scaffolding for success. *The Educational Technology Journal*, 9(4), 1-4.
- Palupi, B. S., Subiyantoro, S., Rukayah, & Triyanto. (2020). The Effectiveness of guided inquiry learning (GIL) and problem-based learning (PBL) for explanatory writing skill. *International Journal of Instruction*, 13(1), 713-730. doi:10.29333/iji.2020.13146a



AUTHOR INFORMATION

Saleh Al-Busaidi, asad@squ.edu.om, Oman, Sultan Qaboos University (corresponding author)

Tariq Yusuf, tariqy@squ.edu.om, Oman, Sultan Qaboos University



WRITING PRAXIS: PROMOTING CRITICAL REFLECTION AMONG MEDIA PRACTICE STUDENTS THROUGH BLOGGING IN PROJECT-LED PROBLEM-BASED LEARNING

Roy Hanney

ABSTRACT

The adoption of blogging as a pedagogic tool in Higher Education is widely explored in the learning and teaching literature and is commonly thought to provide a range of benefits such as promoting the attainment of skills in research for creative practice, academic writing, critical reflection and professional identity formation. Notwithstanding some of the difficulties faced by educators wishing to employ blogging in an educational context, there is a clear sense of an opportunity for learners to engage with acts of personal and critical reflection, identity building and community membership through the use of Web 2.0 technologies such as course blogs. The paper explores some of these ideas through research undertaken into the implementation of course blogs on Project-led Problem-based Learning (PjPBL) modules on an undergraduate media practice programme at an English university. It asks questions about how educators can better model the writing process more clearly through increased writing activities in class and in particular the development of skills in synthesis and strategies for narrativising assessed writing.

KEYWORDS: Course, Blogging, Academic, Writing, Affect, Affordance, Modelling

TYPE OF CONTRIBUTION: Practice-based abstract

PRESENTATION FORMAT: Roundtable discussion

INTRODUCTION

The adoption of blogging as a pedagogic tool in Higher Education is widely explored in the learning and teaching literature (cf. Sim & Hew, 2010) and is commonly thought to provide a range of benefits such as promoting the attainment of skills in research for creative practice, academic writing, critical reflection and professional identity formation. Notwithstanding some of the difficulties faced by educators wishing to employ blogging in an educational context (cf. Robertson, 2011), there is a clear sense of an opportunity for learners to engage with acts of personal and critical reflection, identity building and community membership through the use of Web 2.0 technologies such as course blogs. The paper that follows explores some of these



ideas through research undertaken into the implementation of course blogs on Project-led Problem-based Learning (PjPBL) modules on an undergraduate media practice programme at an English university.

THE PROBLEM

The initial aim of the study was to investigate whether or not blogging might address a number of previously identified issues with the use of critical reflection as an assessment of practice on the programme. The first issue concerned the need to integrate theory and practice into course activities so that the student's creative media practice would be informed by theory, thereby deepening the critical dimension of problem solving for creative practice. Secondly, there was a need to promote an engagement with critical concerns that circulate around ideas of practice so that the student's critical reflections are located within an appropriate theoretical framework. Finally, there is the need to promote an early engagement with contextual material so that there could be a formative component to the act of looking back upon practice. The problem being, in the experience of the course team, students will tend to leave work on their written assessment until the last few weeks of a practice unit. Thus, the theory doesn't inform practice, engagement is purely strategic and importantly there is no draft presented for formative feedback.

Reflective writing is commonly used as an assessment tool in media practice education as, in and of itself, the output of a project doesn't necessarily evidence learning and/or critical thinking (Hanney, 2013). By its very nature the output of project is a complex intertangling of actions, intentions, problem encounters, risk strategies and group dynamics. That is to say, while a project output may be of a high quality the reason for this can often be as much down to luck and good timing as it can be down to high quality critical thinking. The value of reflective writing for assessment is then very clear, it adds an individual component to the assessment of group projects, a clearly useful academic imperative is at play here since group-working can also serve to mask effort, contribution and participation by individual students working as part of a project team.

If, following Dewey (1938) it is the case that reflection and in particular reflective writing is a manifestation of critical thinking. Then the promotion of this skillset through the writing of course blogs would seem an appropriate strategy. It is argued here that if expertise is the capability for 'thinking through problem encounters based on acquired knowledge and experience' (Chi, Feltovich and Glaser 1981), then the challenge for educators is to encourage novice practitioners to take hold of knowledge as it pertains to their domain of practice and use it to inform their practical work. *Critical reflection* is key to the process of integrating theory and practice and the use of course blogs aims to ensure *critical reflection* is located within an appropriate theoretical framework.



THE SOLUTION

After an initial pilot project the use of course blogs was rolled out across all modules where critical reflection was an assessment component. At the conclusion of each semester further reviews were undertaken on the use of course blogs on practice modules. This has led to the development of a clear methodology for the use of course blogs on the programme.

For all modules where critical reflection was an element of assessment students would be asked to write a minimum of three blog posts during the life cycle of the module. We employ a simple model for explaining how students should approach this writing task suggesting that there should be a balance between their reflection on their personal experience, their theoretical research and their creative practice. Each blog post is triggered by a writing task that is directly related to the set reading for the module and reflecting the particular form of practice for that unit. Classroom time is given over to the initiating of each writing task in the form of class discussion, exploratory research or even the drafting of the post. As blogs are posted tutors are expected to comment on the post and provide quick feedback on the students writing, relevance of content, structure of arguments and so on. High quality posts by students can be used in class to illustrate good practice and students are encouraged to read their tutors own blogs in order to model the practice of blog writing and to promote the development of a community of practice around this activity.

At a mid-point in the module students are asked to read each other's blog posts and provide their own comments. Encouraging students to comment on each other's posts has a number of additional benefits since it requires the students to learn how to give and receive feedback, plus it has the potential to further promote the development of a learning community. At the end of the semester students are instructed to copy and paste their blog posts into a new document and to use this as the basis for their final critical reflection. The re-reading and subsequent editing of their initial blog posts is construed as a form of meta-cognition, while the synthesis of the original posts into a newly edited and narrativised critical reflection is recognised as evidence of the application of high-level critical thinking skills. It also mirrors a commonly recognised framework for the writing process that will be familiar to anyone who has undertaken academic and other professional writing: research, draft, write, re-write.

FINDINGS

The roll out of course blogging as a means of effecting a change in students' engagement with critical reflection; 'for-action, in-action as well as on-action' (Schon, 2016), has been ongoing now for close to three years at the writing of this paper. The method above has emerged out of an ongoing process of reflection by the staff team on the programme out of which a number of findings emerge.



Early on we found that staff buy in to the use of course blogs was patchy, in part due to the need to better communicate purpose. But also, it was discovered that the level of digital literacy among staff was extremely uneven. We subsequently ran a staff blogging group which provided technical support for staff, developed a model for students and importantly aimed to get all academic staff to think of themselves as academic writers.

Through focus groups we learned that students were reluctant to undertake the blogging tasks as they were not assessed. Consequently, we re-wrote the assessment brief so that while the blogs were still only formatively assessed. The writing of these posts became an assessment requirement.

Initially the choice of topic for assessed critical reflections was left to students resulting in a number of issues. There was a tendency to go for safe options such as reflecting on group working. The selection of reference sources was largely a result of last-minute googling. Plus, there was a potential for plagiarism as students realised, they could recycle the previous year's reflections.

More focused writing tasks rooted in set readings specific to their creative practice has worked to resolve this issue.

CONCLUSION

Further reflection by the course team has also identified a number of additional issues that we are now trying to tackle which include the need for:

- Provision of more support for the development of reading skills among a generation that has pretty much abandoned the reading of books and eschews the reading of academic texts.
- Modelling of the writing process more clearly through increased writing activities in class and in particular the development of skills in synthesis and strategies for narrativising the content of the assessed critical reflection.

REFERENCES

Chi, M. T. H., Feltovich, P. J., & Glaser, R. (1981). Categorization and Representation of Physics Problems by Experts and Novices. *Cognitive Science* 5(2), 121.

Dewey, J. (1938). *Experience and education*. New York: MacMillan.

Hanney, R. (2013). Towards a situated media practice: Reflections on the implementation of project-led problem-based learning. *Journal of Media Practice* 14(1), 43-59.

Robertson, J. (2011). The educational affordances of blogs for self-directed learning. *Computers & Education* 57, 1628-44.



Schon, D., (2016). *The reflective practitioner: how professionals think in action*. London: Routledge

Sim, J.W.S. & K.F. Hew. (2010). Review: The use of weblogs in higher education settings: A review of empirical research. *Educational Research Review* 5, 151-63.

AUTHOR INFORMATION

Roy Hanney, roy.hanney@solent.ac.uk, United Kingdom, Southampton Solent University (corresponding author)



CREATIVE ELECTRONICS: DESCRIPTION OF PRACTICES BASED ON THE TPACK MODEL IN THE CONTINUOUS TRAINING OF TECHNOLOGY TEACHERS IN THE HYBRID ENVIRONMENTS

Marisa Almeida Cavalcante, João Adriano Alves de Freitas, Elio Molisani Ferreira Santos & Marcia Nobue Sacay

ABSTRACT

We have been following a growing transformation in the organization of old computer labs in schools into more creative spaces, a learning dynamic supported by projects and the dissemination of a digital culture. One example is the creation of the well-known Makers laboratories in both private and public schools. These transformations, in addition to the acquisition of prototyping equipment, include the training of teachers to guide students in the use and creation of technologies in a critical, reflective, and ethical way, both during social interaction and within their lives. As a support to the continuing education process, the authors have structured an extension course in Physical Computing through active methodologies and hybrid learning, based on the TPACK model. This course was conducted in two classes of 50 teachers of the Municipal Secretary of Education in Sao Paulo-Brazil in 2020. This course was created from the increased use of Arduino as a facilitator for the development of computer thinking. The proposed work aims to present the practices developed in this extension course for the teacher's learning, involving the necessary electronics in prototypes with Arduino, not only to solve problems of technical nature, but in the construction of narratives from the Tinkercad platform usage. The playful and hybrid nature of this proposed work allowed teachers to develop projects and activities that were applied in their remote classes and, according to testimonials, gained greater motivation from students.

KEYWORDS: Hybrid environments, continuous teacher training, e-learning by narratives, Physical Computing Online, computer thinking.

TYPE OF CONTRIBUTION: Practice-based abstract

PRESENTATION FORMAT: Experience demonstration

INTRODUCTION

In the 1980s, with the implementation of innovation and educational technology policies in Brazil, the aim was to equip school laboratories with computers and offer training to teachers. However, these continued training were restricted to the usage of tools, without any pedagogical or curricular connection. These



laboratories, over time, were sought out by teachers who had greater affinity with the technological field, regardless of their area of training and who, through personal initiative, brought their students into contact with technology.

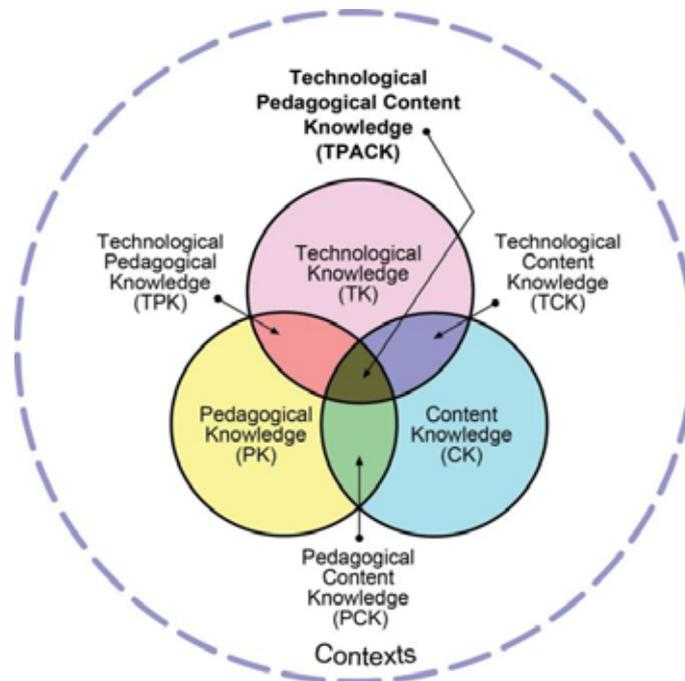
According to the bibliographic survey on the effects of the National Educational Technology Program of Brazilian schools, it is evident that there are no concrete results about social inclusion in Brazilian public schools due to two essential factors, one of them due to the difficulty of accessing the equipment, but above all the inadequate teacher training to use the digital technological resources, privileging the merely instructional nature of the tools available (Basniak & Soares 2016). According to the authors, there is no or little exploitation of the cognitive- pedagogical potentiality.

In the last 10 years, due to the popularization of knowledge in Physical Computing through the dissemination of open-source systems and cost reduction, schools have adhered to the increased use of technologies, as a fundamental component of curriculum and pedagogical practice, bringing Technologies for Learning as an area of content knowledge. In this perspective, the old computer laboratories become spaces of creativity and invention for the development of projects. In this space, teachers incorporate the task of creating alternatives, so the student not only knows how to use it, but also create technologies, and above all, learn to interact in a critical, ethical, and reflective way, while building and re-signifying knowledge, as an autonomous subject in the various social practices and in conducting their lives.

Therefore, the continued or initial teacher training of the teacher responsible for the Maker space, requires an analysis of the knowledge, necessary to obtain the proper acknowledgement as a professional in education. To plan the continuing education proposed in this work, we sought support from TPACK (Technological Pedagogical Content Knowledge) model (MISHRA & KOEHLER 2006). This model establishes and seeks to explain the teaching basic knowledge for the integration of technologies in educational contexts, based on the alignment with pedagogical approaches and teaching of specific content. Figure 01 shows a scheme of the TPACK model.



Fig 01: TPACK framework and the integration of its components Source <http://tpack.org>



METHODS

Strategies and Methodological Practices in Continuing Training Course EAD

Most teachers did not know basic electronics, with just a few exceptions, which limits the use of sensors and actuators in prototypes with Arduino. Based on that, the continued training should expand the technological knowledge, seeking methodological strategies from the TPACK model, in addition to ensure the principle of equity and quality in this training, considering that there are different levels of knowledge for this technology within this virtual learning space. In addition to this knowledge, we should also consider that the guiding questions of the projects developed in these creativity laboratories ensures an intersection between different curricular contents in an inter- and trans- disciplinary perspective.

Another relevant point is that all continuing education must occur remotely in synchronous and asynchronous meetings, ensuring that this virtual space allows interactivity, for creation and inventiveness.

Use of Electronic Simulators in the context of Narratives

We used the Tinkercad platform to build concepts in basic electronics. This platform allows a multitude of applications from the prototyping of simple to highly complex circuits, through assembly and use of sensors and actuators that can be programmed with microcontrollers such as ARDUINO, ATTINY and



MICRO:BIT. Figure 02 shows the illustration of three microcontrollers programmed to operate simultaneously.

Fig. 02. from left to right: ATTINY with PBO Blink, MICRO:BIT with the A button pressed generating icon and ARDUINO with presence sensor that with HIGH output turn on the LED located in output pin 12

(Source: Authors and Link <https://www.tinkercad.com/things/e1OmKfNOCyX>)



To make the articulation possible between the three knowledges in the PTACK model and equity, activities were developed where narratives (PK) are integrated to electric circuits (PC) and programming in the Tinkercad platform (PT). This integration includes the overlapping of drawings on paper placed in front of the computer screen, characterizing an overlap between the cursist’s imaginative and the stimulator’s virtuality in basic electronics (PTACK). This is not learning through electronics but learning electronics toward something that motivates you. This motivation moves him/her to want to learn more and to be enchanted by electronics that makes all the sense in his/her life. This strategy of learning in Physical Computing we have given the name of Creative Electronics.

Figures 03a, 03b, 04a, 04b, and 05 contemplate three examples of projects developed by students with image superposition and simulated circuits in the Tinkercad with or without the use of Arduino. Other projects and activities developed can be seen in the (Santos, et al; 2020).

Fig 03a. Superimposition of mandalas drawings; author: Prof. Douglas Maris Antunes Coelho. 03b: Circuit in the Tinkercad for serial and parallel Leds association study (Marin,D. 2020)

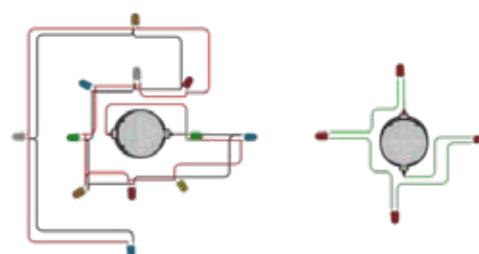
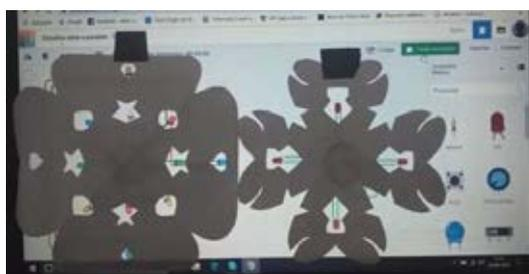




Fig 04a. Keeping the Social Distance Author Prof. Erlene Gomes Fig. 04b. Circuit in Tinkercad. (Gome, E; 2020)

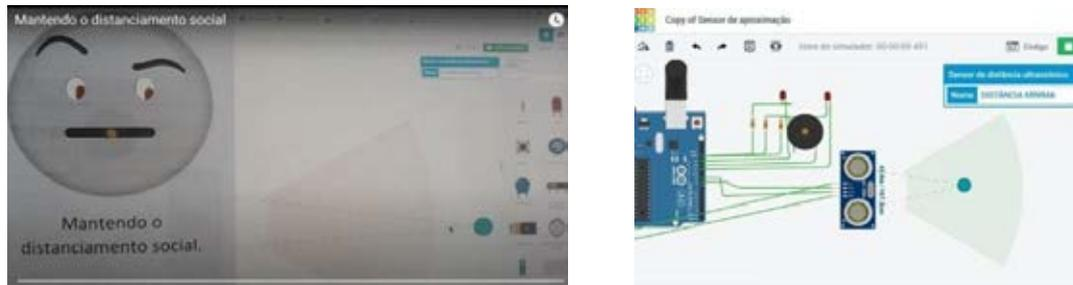
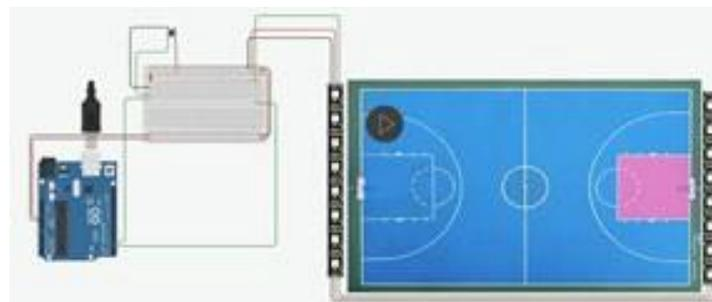


Fig. 05. Example of a final project, a prototype in the Tinkercad developed by Professor Daniela Takara. It is an inclusion project that aims to answer the question "Do deaf people play sports on the court?". The teacher brings an innovative solution, replacing the judge's whistle with signs indicated by the ledstapes.



RESULT ANALYSIS AND CONCLUSION

One of the difficulties encountered when providing our young people with a greater understanding of the world of Physical Computing was associated with the mechanical use of the kits, which sensors and actuators are programmed often as something magical, considering that all components and connections are closed for their use.

However, physical interactions with the environment need to be better known in order to obtain a more complete view of the whole and to allow progress in the development of more complex systems, often desirable by students and teachers. The lack of this improvement often leads to frustration, as the search for solutions occurs by trial and error, without any scientific method.

To enable an expansion in technological knowledge, it is important that teachers take ownership of the basic operating principle of sensors and actuators, which implies in understanding how the measures are processed. For this, we have chosen the Tinkercad platform as an environment to simulate circuits, to carry out tests safely without the burning of components occurring in this learning. This platform has the advantage of presenting a great similarity with the real components and performing tests remotely and online, which



allows the execution of activities of an experimental nature in your home even without having available real kits and meeting the conditions of social isolation due to COVID-19.

In this platform, we can "learn by doing", which is one of the characteristics of the creativity spaces that are taking place in old computer labs of the schools; it is, therefore, an important tool that contributes to the implementation of hybrid learning.

In these spaces (virtual or not), teachers must be able to select the most appropriate technological resources to communicate a particular curriculum content, as well as to know how to use these resources in the teaching and learning process (Technological Pedagogical Knowledge (TRAESEL & SCHMITT 2018)). For the organization of strategies and methodological practices of this training, we take as reference the PTACK model.

As a facilitator of this articulation of knowledge, we use activities that establish the superposition of images and drawings in a 2D plane on the PC screen or notebook, where the simulation was developed and executed. The superposition of the image with the simulated circuit can attribute to the drawing an infinity of applications in different areas of knowledge, using narratives, legends, or simple portraits of a physical, biological or social phenomenon, and where your imagination leads you.

The playful nature and the learning potential prompted many teachers to make adaptations of this activity during the extension course, and in their testimonies, they found a strong student engagement, something paramount in any learning, especially in this moment of social isolation.

We noticed from the evaluation forms and projects presented by teachers that a good articulation of knowledge and an expansion in technological knowledge were present, allowing greater appropriation of resources and possibilities of prototyping with Arduino.

In light that the whole course was developed within a dynamic that makes use of active methodologies in remote modality, cursists were able to temporarily hold the student's position and get closer to the impact and difficulties that these methodologies can offer for student's learning. This positioning of the teacher establishes a bond of empathy and different perceptions, which is fundamental in the relationships established in the learning environment and will certainly help guiding their actions in planning the activities they will develop and apply in their classes.

ACKNOWLEDGEMENT

The authors gratefully acknowledge Gedutec Tecnologia Educacional and the Municipal Education Secretariat of São Paulo for the support of this work.



REFERENCES

- Basniak, M. I., & Soares, M. T. C. (2016, August). The ProInfo and dissemination of Educational Technology in Brazil. *Educação Unisinos*, 20(2), 201-224. Retrieved from <https://doi.org/10.4013/edu.2016.202.06>
- Coelho, D. M. A. "Video in Portuguese of activity; 2020 <<https://youtu.be/rHD2vWv4Y1U> > access on 29/01/2021
- Gomes, E. "Video in Portuguese of activity; 2020"; < <https://youtu.be/Yq2ordg5lxw> > access on 29/01/2021
- Mishra, P., & Koehler, M. J. (2006, June). Technological pedagogical content knowledge: A framework for teacher knowledge. *Teachers college record*, 108(6), 1017-1054.
- Nakashima, R. H. R., & Piconez, S. C. B. (2016). Technological pedagogical content knowledge (TPACK): modelo explicativo da ação docente. *Revista Eletrônica de Educação*, 10(3), 231- 250.
- Catalogues of Activities and Projects 2020. *Continued training course in Physical Computing*. Catalog 1 retrieved from <https://drive.google.com/file/d/1YeXH8g-MpFZFegbcoYXSOfdRsh2vd5Tk/view?usp=sharing>.
- Catalog 2 retrieved from: https://drive.google.com/file/d/1iXteVvwh-TU57oeJQk-xMis_Y2g1NI-G/view?usp=sharing (access on 29/01/2021)
- Silva, A. M. D. (2016). Social and formative appropriation of digital technologies by adolescents and their relations with the teaching and learning at school. [Master's thesis, Faculty of Science and Technology of UNESP]. UNESP. Retrieved from <https://repositorio.unesp.br/handle/11449/143439> (access on 29/01/2021).
- Traesel, N., & Schmitt, L. (2018). Os saberes docentes necessários ao desenvolvimento do Tpack. CIET: EnPED. Retrieved from <https://cietenped.ufscar.br/submissao/index.php/2018/article/view/58> (access on 29/01/2021).

AUTHOR INFORMATION

Marisa Cavalcante, marisacavalcante1@gmail.com, Brazil, Universidade Federal do Amazonas (corresponding author)

João Freitas, jaafreitas@gmail.com, Brazil, Estúdio Hacker (corresponding author)

Elio Molisani, eliomolisani@ufam.edu.br, Brazil, Universidade Federal do Amazonas (corresponding author)

Marcia Sacay, sacaymarcia@gmail.com, Brazil, Centro Educacional Pioneiro (corresponding author)



RELATIONSHIP BETWEEN COLLABORATIVE LEARNING, NEED SATISFACTION, AND STUDENT SATISFACTION WITH A BLENDED PROJECT-BASED LEARNING COURSE

Pengyue Guo, Nadira Saab, Lin Wu & Wilfried Admiraal

ABSTRACT

This study examines the influence of collaborative learning and need satisfaction on student satisfaction with a blended project-based learning course in higher education. During the course, students accomplished two activities (i.e. proposal writing and video creation) in small groups. They (N=76) answered three questionnaires of perceptions of collaborative activities, need satisfaction, and course satisfaction. Path analysis revealed that students' perceptions of video creation, through the mediating effect of students' feelings of autonomy, had a positive impact on their course satisfaction.

KEYWORDS: Blended project-based learning, Collaborative learning, Need satisfaction, Student satisfaction

TYPE OF CONTRIBUTION: Extended scientific abstract

PRESENTATION FORMAT: Interactive poster presentation

INTRODUCTION

The creation of artifacts and collaborative learning are two essential features of project-based learning (PBL). Research has shown that working together on products tends to promote learners' interest and satisfaction with the course. Yet it remains unclear how collaborative learning, learners' interest and satisfaction in PBL are related.

COLLABORATIVE LEARNING IN PBL

From both theoretical and empirical perspectives, we propose that two factors, i.e. collaborative learning and need satisfaction, might have an influence on student course satisfaction. It is important to understand students' experience during PBL activities as they develop products together. Previous studies (e.g. So & Brush, 2008), albeit about online learning, has reported positive relationships between students' perceptions of collaborative learning with course satisfaction. As for need satisfaction, Deci and Ryan (2000) claimed that the degree to which people are interested in activities depends on the extent to which they perceive satisfaction for autonomy, competence, and relatedness while engaging in those activities. However, different findings of the relationship between need satisfaction and course satisfaction have been reported.

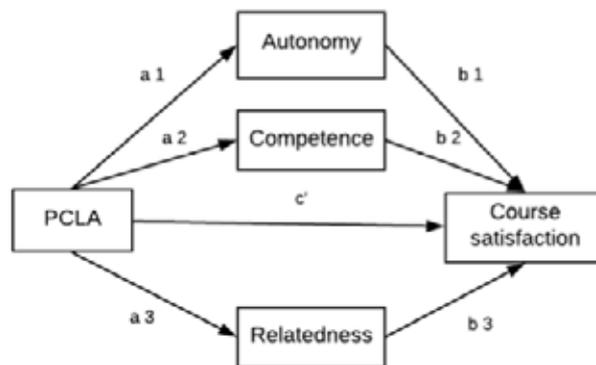


RESEARCH QUESTIONS

We aim to explore the impact of collaborative learning and need satisfaction on student satisfaction with PBL courses. In order to reveal students’ experience during collaborative learning, perceptions of collaborative learning activities (PCLA) are measured in the current study. The research questions (RQs) and models (Fig. 1) are as follows:

- RQ1: What is the relationship between students’ PCLA and need satisfaction in PBL?
- RQ2: What is the relationship between students’ need satisfaction and satisfaction?
- RQ3: What is the relationship between students’ PCLA, need satisfaction, and satisfaction?

Fig. 1 Hypothesized research models



METHOD

Research context

This study was based on a general education course of mental health for the freshmen in a research university. This course was a blended course of eight weeks that combined F2F lectures and online learning. In the first, third, fifth, and seventh week, students attended F2F lectures in class. In other weeks and their free time, learners were required to watch 26 online teaching videos of 10 minutes for the course. These videos contained all the information that students needed to learn and students were able to choose their own watching sequence. They took a final exam in the last week.

Students were required to create a video as one of the final products in small groups (around 5 members). In the video, they should answer a driving question, namely a certain problem they found in the real-world that needs to be responded by what they learned in this course. Before they started making the video they were first asked to write a proposal together for this. Both projects were graded which resulted in a final grade for the course. During the whole process, students could communicate by text, audio, and video in their WeChat groups.



MEASURES

PCLA. Students' PCLA was measured by 20 items based on the work of Mouw et al. (2019) and Shea et al. (2010). Students answered each item separately based on proposal writing (P) and video creation (V) on a 4-point Likert type scale from 1 (disagree) to 4 (agree). Principal Component Analysis (PCA) with Varimax rotation revealed 16 items for the scales of both activities. One example of items for the scale of P and V was "All group members could actively be engaged in the activity" and "We disagree on each other or each other's ideas". The overall Cronbach's α of each scale (P and V) is 0.873 and 0.802.

Need satisfaction. Three aspects of students' need satisfaction (i.e. autonomy, competence, and relatedness) during the course were measured on 14 items adapted from Standage et al. (2005) and Chen et al. (2015). Three factors were revealed by PCA with Varimax rotation after the exclusion of three items: *Autonomy* (2 items, Cronbach's $\alpha = 0.80$ with, for example, "I can decide which learning activities I want to participate"), *Competence* (4 items, Cronbach's $\alpha = 0.84$ with, for example, "I feel competent to achieve my goals"), and *Relatedness* (5 items, Cronbach's $\alpha = 0.86$ with, for example, "I feel supported by the other students"). Students gave their responses to each item on a 6-point Likert type scale from 1 (Strongly disagree) to 6 (Strongly agree).

Satisfaction. Students' satisfaction with the current course and their intention for future courses were measured by two items with a 0.80 Cronbach's α . These two items were "I am satisfied with this course" and "If this course is offered in the future, I would like to participate". Students used the same format of scale as for need satisfaction.

DATA COLLECTION AND ANALYSIS

Students were asked to answer three online questionnaires (with consent letters) in the last and directly after the last class. In total, 76 students finished all surveys.

To answer the three research hypotheses, a mediation model (Fig. 1) was estimated via path analysis based on PROCESS macro version 3.4 (Hayes, 2018) in SPSS version 26.

RESULTS AND DISCUSSION

The results of two mediation models (i.e. model P and model V) are presented. Model P showed a non-significant total model fit; $F(0.78) = 1.10$; $p = .30$; $R^2 = .01$, while model V showed a significant total model fit; $F(0.51) = 11.17$; $p = 0.00$; $R^2 = .39$. The results of each path in these two models are shown in Table 1.



Table 1. Model P and Model V coefficients (RQs 1-3, N=76)

Path	Estimate ¹		S.E.		CI limits ²	
	P	V	P	V	P	V
a1 PCLA → Autonomy	0.44	0.92	.30	.37	(-.16, 1.04)	(.17, 1.66)
a2 PCLA → Competence	0.47	1.02	.25	.30	(-.02, .97)	(.42, 1.62)
a3 PCLA → Relatedness	0.95	1.17	.26	.34	(.42, 1.47)	(.50, 1.84)
b1 Autonomy → Course satisfaction	0.35	0.34	.11	.11	(.13, .57)	(.12, .56)
b2 Competence → Course satisfaction	0.42	0.40	.15	.15	(.12, .72)	(.09, .70)
b3 Relatedness → Course satisfaction	-0.00	-0.04	.14	.14	(-.29, .28)	(-.31, .23)
c' PCLA → Course satisfaction (direct effect)	-0.03	0.38	.26	.33	(-.56, .49)	(-.29, 1.04)
c1 PCLA → Autonomy → Course satisfaction (indirect effect 1)	0.15	0.31	.13	.19	(-.04, .46)	(.02, .76)
c2 PCLA → Competence → Course satisfaction (indirect effect 2)	0.20	0.40	.15	.28	(-.01, -.57)	(-.04, .99)
c3 PCLA → Relatedness → Course satisfaction (indirect effect 3)	-0.00	-0.04	.12	.13	(-.19, .31)	(-.27, .27)
c PCLA → Need satisfaction → Course satisfaction (total effect)	0.31	1.05	.30	.36	(-.28, .90)	(.33, 1.77)

1: Unstandardized estimates

2: CI limits = lower and upper 95% confidence interval

Students' perceptions of proposal writing only significantly influenced their feelings of relatedness, whereas learners' perceptions of video creation were positively related to all three need satisfaction variables (RQ 1, a1, a2 and a3 in Table 1). The reason might be the difference in freedom of creation and difficulty of creation for these two activities. Regarding proposal writing, students were bound to a particular format as required, while video creation gave learners a sense of freedom of choice. Likewise, students were not familiar with producing a video, compared to writing a document, which made them feel confident after finishing it.

Students' feelings of autonomy and competence rather than relatedness had positive relationships with their course satisfaction (RQ 2, b1, b2 and b3 in Table 1). This indicates that learners are more satisfied with courses if they feel the freedom of choice during learning. Moreover, if they feel fewer challenges and much confidence to follow courses they will also be satisfied.

Last, students' perceptions of both activities had no significant direct impact on course satisfaction. However, (only) students' perceptions of video creation were positively related to course satisfaction through the influence of their need satisfaction (RQ 3, c' and c). The latter means that PCLA led to higher course satisfaction only if it was positively related to students' feelings of autonomy (RQ 3, c1, c2, and c3).

CONCLUDING REMARKS

The present study reveals the positive influence of collaborative learning, through the mediating role of need satisfaction, on student satisfaction with PBL courses. The most important conclusion might be that collaborative learning does not naturally affect student course satisfaction unless their feelings of autonomy are supported by appropriate PBL activities (i.e. video creation in this study).



REFERENCES

Chen, B., Vansteenkiste, M., Beyers, W., Boone, L., Deci, E. L., Van der Kaap-Deeder, J., Duriez, B., Lens, W., Matos, L., Mouratidis, A., Ryan, R. M., Sheldon, K. M., Soenens, B., Van Petegem, S., & Verstuyf, J. (2015). Basic psychological need satisfaction, need frustration, and need strength across four cultures. *Motivation and Emotion, 39*(2), 216–236. <https://doi.org/10.1007/s11031-014-9450-1>

Deci, E. L., & Ryan, R. M. (2000). The “What” and “Why” of Goal Pursuits: Human Needs and the Self-Determination of Behavior. *Psychological Inquiry, 11*(4), 227–268. https://doi.org/10.1207/S15327965PLI1104_01

Hayes, A. F. (2018). *Introduction to Mediation, Moderation, and Conditional Process Analysis: A Regression-Based Approach* (Second edition). Guilford Press.

Mouw, J. M., Saab, N., Pat-El, R. J., & van den Broek, P. (2019). Student- and Task-Related Predictors of Primary-School Students’ Perceptions of Cooperative Learning Activities. *Pedagogische Studiën, 96*(2), 98–122.

Shea, P., Hayes, S., Vickers, J., Gozza-Cohen, M., Uzuner, S., Mehta, R., Valchova, A., & Rangan, P. (2010). A re-examination of the community of inquiry framework: Social network and content analysis. *The Internet and Higher Education, 13*(1–2), 10–21. <https://doi.org/10.1016/j.iheduc.2009.11.002>

So, H.-J., & Brush, T. A. (2008). Student perceptions of collaborative learning, social presence and satisfaction in a blended learning environment: Relationships and critical factors. *Computers & Education, 51*(1), 318–336. <https://doi.org/10.1016/j.compedu.2007.05.009>

Standage, M., Duda, J. L., & Ntoumanis, N. (2005). A test of self-determination theory in school physical education. *British Journal of Educational Psychology, 75*(3), 411–433. <https://doi.org/10.1348/000709904X22359>.

AUTHOR INFORMATION

Pengyue Guo, p.guo@iclon.leidenuniv.nl, Netherlands, ICLON, Leiden University Graduate School of Teaching, Leiden University (corresponding author)

Nadira Saab, n.saab@iclon.leidenuniv.nl, Netherlands, ICLON, Leiden University Graduate School of Teaching, Leiden University

Lin Wu, wulin@hqu.edu.cn, China, Mental Health Education Center, Huaqiao University



Wilfried Admiraal, w.f.admiraal@iclon.leidenuniv.nl, Netherlands, ICLON, Leiden University Graduate School of Teaching, Leiden University



AN EXPERIENCE USING PBL ONLINE: THE EXPIN48 CASE

Afsaneh Hamed d'Escoffier, Luiz Ney d'Escoffier & Marco Braga

ABSTRACT

The increasing population density in cities causes serious social disturbances. Many of these problems can be solved through innovative and creative solutions, designed by its own residents. The use of the PBL methodology is a relevant strategy in the training of young people as a stimulator of creativity and innovation. In this paper, we describe an online PBL experience through Expin48, an educational hackathon, carried out by CEFET / RJ. Questions arose regarding the feasibility of this undertaking with regard to infrastructure and process development, especially at the time of prototyping. However, with the help of the Microsoft Teams® platform and various CAD-type tools, the event was held successfully with the participation of high school, undergraduate and graduate students. The use of digital prototypes provided greater flexibility in defining requirements and correcting flaws in the project. Thus, we conclude the total viability of this type of event in the virtual modality, as long as adequate tools are available for communication, cooperation and problem solving.

KEYWORDS: PBL; innovation; prototyping; virtual event; active methodologies.

TYPE OF CONTRIBUTION: Practice-based abstract

PRESENTATION FORMAT: Interactive poster presentation

INTRODUCTION

Until 2050 more than 70% of world population will be living in the cities. These issues demand solutions that are appropriate to the reality of each location. No one better than the local population to identify and find the best solution to them. Thus, for young people to become active citizens in their communities, it is necessary to stimulate and develop specific skills and competences, such as creativity, cooperation, teamwork, among others.

The PBL methodology seems to be adequate for this purpose. The teachers can define broad real themes and present them to students through inspiring questions. Based on these questions, students are encouraged to discover specific problems in their communities and seek solutions. Freire (1996) when created the methodology of literacy, used the proposal to read the reality before to read texts. Based in this idea, we created a similar process where students organize themselves into groups, according to the affinity of the problems, and begin the search for information for resolution. The teacher never offers answers, but corrects



directions and guides, acting as a mentor, leading students to realize that they need to learn to achieve their goals, building collective knowledge through a collaborative experience (Graaf & Kolmos, 2007; Bender, 2014; Kokotsaky, Menzies & Wiggins, 2016).

Based in these fundamentals, it arises to hold events in schools where students will have the opportunity to develop the skills and competencies needed for today's world. The CEFET/RJ, the University of Technology based in Rio de Janeiro-Brazil, developed in 2019 an event called Expin48. This event works as a kind of educational hackathon, which brings together Technical High School (THS), undergraduate and graduate engineering students so that together they can find, within 48 hours, creative, innovative and viable solutions to real problems related to general themes.

In 2020, the pandemic caused by COVID-19 posed countless challenges to different sectors at the international level, realigning urgencies and imposing adaptations. The area of education has not escaped the consequences imposed by social detachment, with thousands of schools behind closed doors and around 1.5 billion students without classes in 160 countries. Thus, very quickly, educational institutions sought ways out of digital technologies to introduce new methodologies for remote formation.

The 2020 edition of Expin48 needed to be carried out completely online. However, it is known that a remote collaboration differs from the one in person, being necessary an especial support to the activities that occur in dispersed geographical distances, adapted to all the participants. The use of the PBL methodology in virtual environments is not new (Ryberg, 2013), with several successful experiences (Garcia, 2016; Creelman, Àrnason & Röthler, 2017).

The online experience brought out new challenges. Which platform would be used? How to separate teams by rooms with access to mentors? What platform we would use to publicize the event? Students no longer use emails. Your communication in Brazil was made in its vast majority by the Whatsapp® application or by Instagram®. How to make prototyping possible in different environments without lab support?

In this work we will present the solutions found and the learning in this event model.

EVENT METHODOLOGY

The Expin48

All the students could enroll voluntarily, without any desiring rewards. In case the number of students exceeds the limit 36, It is made a draw. A week before the event, students attend a motivational talk addressing concepts of innovation and techniques associated with the development of the project. At the end of the lecture, the general themes to be worked on are disclosed.



During the event, there are four moments:

1. Interaction – During an hour, they select the themes according to their interest and form groups. There were rules: All the teams must have representatives from three levels of education. In this moment, it is necessary to exercise the negotiation skill.
2. Project - in approximately 6 hours, the teams define the problems related to the theme and present three possible solutions for mentors that help them choose only one of the three.
3. Prototyping - in this stage, lasting approximately 37 hours, ideas are developed, and a prototype must be built.
4. Presentation - in 4 hours, the groups prepare three types of presentation for the judges: a 90-second video (elevator pitch), a brief technical description of the project (White paper) and a 15-minute presentation. In this stage, a jury composed of six experts from the industry and university chooses the best work, according to criteria such as feasibility, innovation, technical quality and presentation.

Throughout the process, teachers act as mentors, advising and correcting routes. At the end of each stage there are meetings, where all the teams participate together to review the status, discussing all the projects together with the mentors.

Expin48 online

For the experience to reach its objectives, the configuration used in the face-to-face format was maintained. Due to the reduced number of participants, the composition of the groups was modified, with at least one THS and higher education student (undergraduate and graduate).

The platform used was Microsoft Teams[®], which allowed an environment with virtual private meeting rooms for groups, collaboration space, where documents relevant to the projects were posted, open to all, and conference rooms, where the presentations were made. Mentors and consultants had access to all rooms.

RESULTS AND DISCUSSION

The resumption of classes online allowed the education network to accumulate enough experience to manage the event. Thus, most of the adversities were successfully overcome. The motivational lectures and dissemination of topics were held in the form of webinars, being transmitted through the YouTube[®] platform. The use of social networks (Facebook[®] and Instagram[®]) and contact with teachers and colleagues, provided by the virtual return to classes, made it possible to publicize the event. It also permitted students to feel comfortable in the virtual environment, interacting with colleagues and mentors.

Only 33 students signed up, only 16 showed up to participate, leading to the creation of 4 groups with 4 members each.

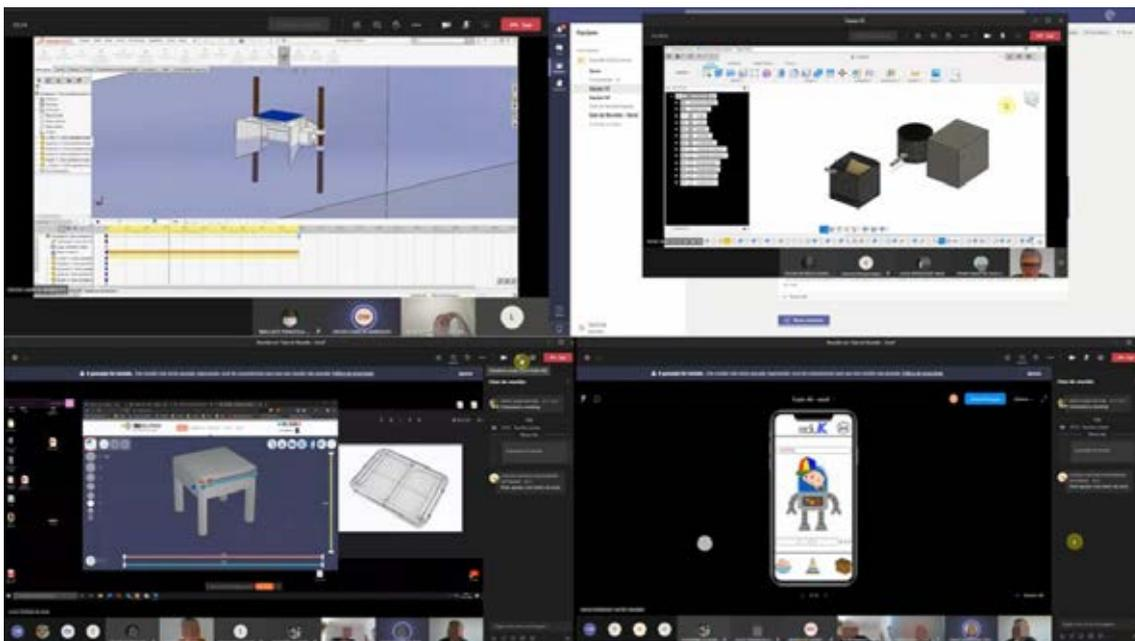


The themes in 2020 have 5 items related to pandemic times (PT): 1-jobs in PT 2-Urban mobility in PT 3-Small businesses in PT 4- Smart Cities in PT 5- Poor communities in PT. And other generics: 6-Sustainable cities, 7-Sanitation, 8-Energy renewable.

The big issue to be resolved was the prototyping phase. A prototype is understood as a preliminary version that includes testing functions, to clarify requirements, reduce design errors and test whether the projects respond to the intended performance. In the online version, the labs access was not possible. However, they developed the prototypes with digital tools, such as CAD® and Solid Works®, could replace physical models.

The use of these tools, together with the facilities offered by Microsoft Teams®, had a positive impact on the execution of the projects. From the meetings with the mentors, the students were able to quickly adjust their prototypes, making the developed solution clear and understandable. This was not possible in the face-to-face version (2019), because it required concrete construction, spending much time and the use of several materials. Many teams do not complete the prototypes in time.

Figure 1: Screenshots of digital prototypes made using CAD® and Solid Works® tools and presented during virtual meetings at Microsoft Teams®.



CONCLUSION

In this work, we analyzed an educational hackathon online event. We demonstrate the applicability of a PBL methodology in the virtual modality. Using the Microsoft Teams® platform, students developed innovation projects in 48 hours, like the classroom model carried out the previous year. The results demonstrate that the participants were able to develop their projects on time, without reduction of motivation, teamwork, creativity, and technical quality.



The fact that prototyping was performed digitally provided greater agility in defining requirements and correcting project failures.

This reveals that virtual learning is feasible, if adequate tools are provided. In the latter case, we can highlight the replacement of physical prototypes with digital prototypes.

REFERENCES

Bender, W.N. (2014). *Project-based learning: Differentiating instruction for the 21st century* (1st ed.) Corwin Publ.

Creelman, A., Arnason, H., Röthler, D. (2017). Webinars as active learning arenas. *European Journal of Open, Distance and e-Learning*, 2017/II.

Freire, P. (1996). *Pedagogy of the Oppressed*. Berkeley, Penguin Books.

Garcia, C. (2016). Project-based learning in virtual groups – collaboration and learning outcomes in a virtual training course for teachers. 2nd International Conference on Higher Education Advances, Valencia, Spain. *Procedia – Social and Behavioral Sciences*, 228, pp. 100-105.

Graaf, E., Kolmos, A. (2007). History of problem-based and project-based learning. In Graaf, E. & Kolmos, A. (ed.). *Management of Change* (pp. 1-8) Rotterdam: Sense Publ.

Kokotsaki, D., Menzies, V., Wiggins, a. (2016). Project-based learning: a review of the literature. *Improving Schools* 19 (3), pp. 267-277.

Ryberg, T. (2013). Designing problem-based learning in virtual learning environments – positioning teachers as competent and practitioners and designers. In Christiansen, E.T., Kuure, L., Mørch, A., & Lindström, B. (Eds.). *Problem-based learning for the 21st century: New practices and learning environments* (1 ed.) Aalborg Universitetsforlag.

AUTHOR INFORMATION

Afsaneh Hamedí d'Escoffier, afsanehamed@gmail.com, Brazil, CEFET/RJ (corresponding author)

Luiz Ney d'Escoffier, lescof@gmail.com, Brazil, FIOCRUZ (corresponding author)

Marco Braga, marcobraga@namelab.education, Brazil, CEFET/RJ (corresponding author)



ENHANCE ENGINEERING PRACTICE WITH PROBLEM-BASED LEARNING IN HYBRID TEACHING

Jing Zhou, Shiyong Hou, Tao Sun, Xiqian Hu, Xin Xiao & Xingming Long

ABSTRACT

In China, after large-scale construction of MOOCs, amount of digital learning resource is provided on the Internet, which not only promotes the study of students, but also provides diverse teaching resource for educators in different fields. Now the most important challenge facing the instructors has gradually shifted to teaching design based on MOOCs. How to plan the course efficiently to get benefits out of the MOOC resource is really count. Taking the course "Electrical and Electronics Circuits" in Chongqing University as an example, a combination of the hybrid teaching with Problem-based Learning (PBL) to strengthen engineering education is presented in this paper. The three stage of the hybrid teaching is presented firstly. And then the face-to-face instruction and lab instruction based on PBL are demonstrated in details. The PBL enhances the engineering application of knowledge, when the PBL problems are analyzed by the methods of theoretical discussion in the classroom and simulation or testing in the lab. And the PBL also helps students construct an extensive knowledge base; develop self-directed learning skills and effective problem-solving skills; and become effective collaborators.

KEYWORDS: Problem-based learning, Hybrid teaching, BJT amplifier circuits, motivate rules, combination of theoretical analysis and lab working

TYPE OF CONTRIBUTION: Practice-based abstract

PRESENTATION FORMAT: Interactive poster presentation

INTRODUCTION

"Electrical and Electronics Circuits" is an interdisciplinary course designed to provide comprehensive and accessible coverage of the evolving field of electrical and electronics for students of non-E.E. majors such as mechanics, mining, and environmental engineering. The contents consist of a concise review of electrical circuits, analog circuits, digital circuits, and motors. The objective of this course has two-fold: 1) to familiarize students with basic concepts and elements of electrical and electronics engineering, and 2) to establish a skill-based working knowledge.



1. HYBRID TEACHING PRACTICE

This course is typically taken during the first semester of the sophomore year. Before entering this class, students have completed the study of mathematics and physics. Meanwhile, as a sophomore, they have adapted to self-directed learning and team working. Therefore, hybrid teaching is proposed by using "online + offline" in the course, which requires about 30% of self-study online, 20% of lab practice, and the rest of face-to-face learning in the classroom. The whole course is divided into several units according to the contents. The implementation of hybrid teaching for each unit can be divided into the following three stages shown in table 1.

Table 1 The three stages of the hybrid teaching

Stage	Methods	Instructions	Motions
The first stage: "Pre-class" learning	Online self-directed study	i. Layout the time schedule of the unit; ii. Design the PBL Problems; iii. Answer questions online.	i. Watch the lecture videos; ii. Finish exercises provided on the MOOC platform; iii. Work on the PBL problems and prepare for the discussion as small collaborative groups;
The second stage: Face-to-face instruction	Theoretical analysis in class	i. Ask questions; ii. Give comments; iii. Summarize.	i. Share the solutions to the PBL problems; ii. Discuss: ask questions or give alternative solutions;
The Third stage: Lab practice	Simulating and testing in lab	i. Step-by-step demonstration;	i. Carry out simulations and experimental tests for the PBL problems; ii. Submit lab reports.

2. PBL INSTRUCTIONS

There are several deficiencies of MOOC-based online learning:

(1) online learning is un-organized, which results in the fragmentation of knowledge. The students receive inputs of knowledge while without knowing its real meanings.

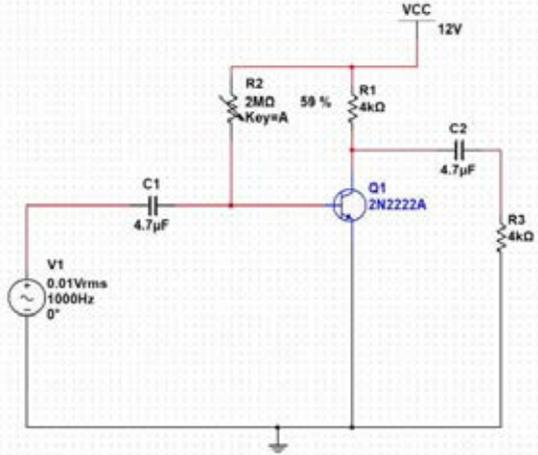
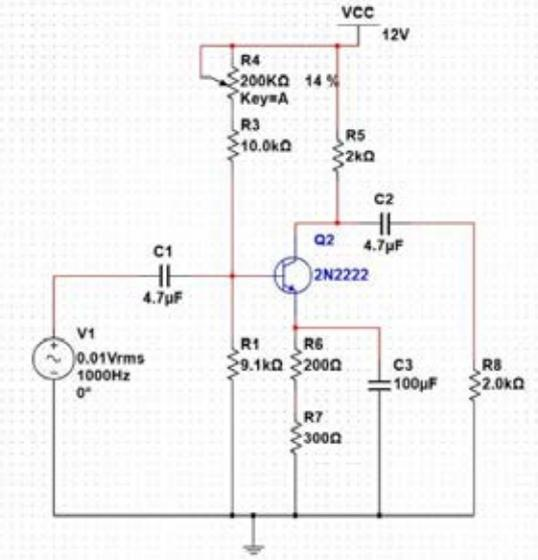
(2) self-directed learning is a big challenge of study habits and persistence to the students. And most of them fail to complete it only due to lacking motivation (Oriol, 2016).

The PBL is an efficient instructional solution to the deficiencies of online learning. When planning the hybrid teaching, the instructions based on the PBL focus on the following two aspects. Firstly, problems provide a purpose for learning, so define the problem carefully. Secondly, motivate the students to change their learning behavior. In this paper, we limit our discussion to the BJT transistor circuit unit to demonstrate how the PBL process during hybrid teaching.

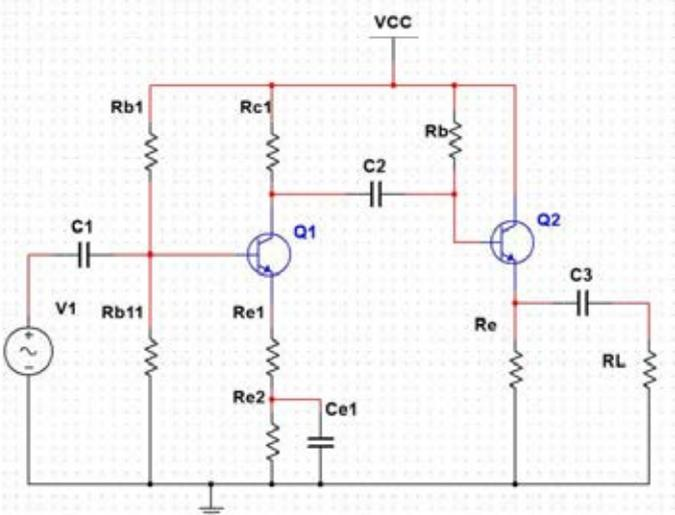


Firstly, a total of five problems (shown in Tab. 2) are developed, which focus on the different aspects of transistor circuit behavior.

Tab. 2 Five proposed problems of the transistor circuits

Problem Number	Tasks	Keywords
P1	<p>Given a canonical bipolar junction transistor (BJT) common-emitter amplifier circuit shown in Fig. 1, analyze the change of the quiescent point Q and the waveform of the output voltage when the bias resistor R2 raises up or decreases.</p>  <p>Fig.1 The BJT common-emitter amplifier circuit with fixed base bias circuit</p>	<p>Common-emitter amplifier Fixed base bias circuit Quiescent point</p>
P2	<p>Given the second BJT common-emitter amplifier circuit shown in Fig. 2, analyze how the improved bias circuit stabilizes the quiescent point Q; and analyze the influence of the negative feedback resistors R6 and R7.</p>  <p>Fig. 2 The BJT common-emitter amplifier circuit with Four-Resistor Bias Circuit</p>	<p>Four-Resistor Bias Circuit Negative feedback</p>



<p>P3</p>	<p>C3 of the BJT amplifier in Fig. 2 is called a bypass capacitor. How to choose the value of C3? Determine the performance of the BJT amplifier with or without the bypass capacitor C3? Discuss the influence of C3.</p>	<p>Performance of amplifier (gain, input resistance, and output resistance) Bypass capacitor</p>
<p>P4</p>	<p>Draw the circuit diagram of an emitter follower. What can you say about the voltage gain of an emitter follower?</p>	<p>The common-emitter amplifier vs. emitter follower (the common-collector amplifier)</p>
<p>P5</p>	<p>Analyze the performance of the given cascaded amplifier (shown in Fig.3), and discuss the influence of the coupling capacitor C1, C2 and C3.</p>  <p>Fig.3 Cascaded amplifier with coupling capacitor</p>	<p>Cascaded amplifier Coupling capacitor</p>

All these step-by-step problems are well designed to cover the main stream of knowledge of the BJT amplifier (Hambley,2016). And the answers can't be given just by yes or no, while needs the comprehensive understanding and applying of the knowledge in this unit.

Secondly, plan the PBL instructions. The PBL-problems are handed out to the students at the very beginning of the unit and give a guideline for the self-direct study. Students prepare before the face-to-face class and then share and discuss in the classroom. But this process can be completed successfully only if all the students have good self-controlling and study hard. Anyway, it is not the truth. Tali Sharot (2014), one of the cognitive neuroscientist, reveals three ingredients to motivate people: (1) Social incentive- We are motivated through the positive actions of others; (2) Progress monitoring- We are motivated by seeing progress; and (3) Immediate reward- Reward good behavior. So we try to figure out the rules of the practice of PBL accordingly.



The students work in small groups and try to find out the solutions by watching the video lectures, reading the textbook, and even searching for information through the Internet. So how to encourage the students to participate in online learning and teamwork?

- (1) The PBL discussion accounts for 20% of the total grade.
- (2) When the teacher guides the discussion in the face-to-face class, which group sharing their answers to the given PBL problem is decided at that time randomly, and which student of this group being the presenter is decided in the same way.
- (3) Each member of the group will get the same grade according to their performance, but the performance of the presenter will greatly affect the grade of the entire group.
- (4) Everyone will have his/her chance to be the speaker in the PBL discussion during the course.

In order to get a satisfactory grade, all the groups have to go through all the 5 problems in the unit and all the members of each group are required to take part in the problem-solving. The teachers take part in the discussion and give feedback immediately. Interactivities are very important to promote good learning behavior. Catch them when the students do well.

Finally, the lab instruction is designed carefully based on the PBL model. The same PBL problems discussed in the second stage will be verified in the lab. Some of the problems will be verified by simulation method and some of the circuits will be tested on a breadboard. For example, when discussing P1, we can observe the waveform of the output voltage when changing the bias resistor R2 by using the simulation method with Multisim software. We also can observe the waveform of the output voltage with an oscilloscope after building the amplifier circuit on the breadboard, changing the working temperature of the BJT by using an iced-water package or hot water package. During the process, the conceptual understanding is strengthened and the abilities of knowledge application and the lab skills of simulation and measurement are developed.

3. CONCLUSION

- (1) Hand out the PBL problems in advance and set a deadline for the first stage.
- (2) The designed PBL problems integrate the three stages of hybrid learning closely, as shown in this paper. The engineering practice of the BJT amplifier is enhanced when the PBL problems are analyzed by whatever the theoretical method, simulation software, or experimental tests in a lab.
- (3) The PBL procedure also helps students: 1) construct an extensive knowledge base; 2) develop self-directed learning skills; 3) develop effective problem-solving skills; 4) become effective collaborators.



4. ACKNOWLEDGEMENT

This work is partly supported by *Chongqing higher education teaching reform research project (182063)* and Chongqing Education Science Planning Project (2020-GX-277).

REFERENCES

Hambley, Allan R. (2016). *Electrical engineering: principles & applications (Seventh edition)*. Hoboken: Pearson Education.

Oriol, B.G., Margarita, M.N., A'ngel, F.B., (2016). New Challenges for the Motivation and Learning in Engineering Education Using Gamification in MOOC. *International Journal of Engineering Education*, 32 (1B), 501–512.

Tali S. (2014, Oct. 28). How to motivate yourself to change your behavior, Retrieved February 15,2020, from <https://www.youtube.com/watch?v=xp002vi8DX4>.

AUTHOR INFORMATION

Jing Zhou, jeanne_z@cqu.edu.cn, China, Electrical Engineering College of Chongqing University (corresponding author)

Shiyong Hou, houshiying@cqu.edu.cn, China, Electrical Engineering College of Chongqing University

Tao Sun, suntao@cqu.edu.cn, China, Electrical Engineering College of Chongqing University

Xiqian Hu, ppmlhxq@126.com, China, Electrical Engineering College of Chongqing University

Xin Xiao, 2300811805@qq.com, China, Electrical Engineering College of Chongqing University

Xingming Long, lennydragon@163.com, Department of Physics of Chongqing Normal University



PROBLEM BASED LEARNING FOR ALL: INTEGRATING UDL AND PBL TO SUPPORT DIVERSE LEARNER NEEDS

Emma O'Brien

ABSTRACT

Problem based learning naturally lends itself to supporting diverse approaches to learning, students direct their own learning by engaging in the PBL process which encourages them to develop and apply the most appropriate skills to the problem trigger based on their interpretations. Studies have found that using PBL with mixed ability learners enhances both affective and cognitive learning for both cohorts however these have been mainly conducted in face to face contexts (Belland et al, 2006; Belland et al 2009). Brodie, 2006 conducted a study in an online context with and found that the problem solving and communication skills of learners was significantly enhanced. This research illustrates the potential of PBL in both an online and face to face context to facilitate learner diversity. However these studies are not underpinned by inclusive pedagogical practices and are explore the capacity of current PBL model in a face to face or online context to satisfy the learning needs of diverse groups of learners.

Universal Design for Learning has widely gained traction over the past decade in designing learning inclusive learning environments that accommodate the needs of all learners. To date the integration of UDL with PBL has not been widely explored. This paper discusses the role of PBL in facilitating learner diversity and its alliances with UDL. It explores a case study of how the two pedagogies were combined to provide a universal, inclusive approach for problem based learning using the UDL principles.

KEYWORDS: Problem based learning, universal design for learning, technology enhanced problem based learning, inclusive pedagogies

TYPE OF CONTRIBUTION: Practice-based abstract

PRESENTATION FORMAT: Interactive poster presentation

THE IMPORTANCE OF DIVERSITY IN HIGHER EDUCATION TODAY

The increasingly diverse learner profile in higher education offers a rich environment where peers can learn from each other's experiences. However the focus has too often been on catering for individual learners and their differences rather than leveraging from these.



Gardner's theory of multiple intelligences highlights that several types of intelligences exist and are developed differently in each individual. (Gardner 1993) The capacity to develop different intelligences may depend on the developmental stage a learner is at, their natural disposition, their experiences and background. Many educators highlight that learning environments must consider all forms of intelligence to foster an inclusive approach to education.

Multimodal approaches to learning and teaching allow all types of students to fully engage in learning by combining different modes of portraying information, including text, video, audio, graphical. Learners can then choose the most relevant resources to their individual needs (Jewitt, 2006). However, the pedagogical underpinnings of this approach are not clearly defined.

Universal Design for Learning (UDL) is a multimodal pedagogy which advocates the use of technology to offer flexibility to learners. UDL ensures the learning environment caters for all students regardless of their individual needs (Hayden, 2011). It has three primary principles:

- Multiple means of representation. The student is provided with learning material in different modes and can choose the mode that best meets their individual preferences.
- Multiple means of action and expression. This principle allows the learner to convey and apply their learning in a variety of modes (not just written) so it aligns to their individual learning needs.
- Multiple means of engagement. This principle involves motivating learners and offering flexibility to allow students to align learning to their individual motivations and interests. It provides students multiple ways to interact with the educator and their peers.

However many of these approaches focus on individual learners and do not consider the context of social or collaborative learning. By integrating inclusive approaches to problem based learning we can cater for learners of all cultures, backgrounds and abilities in a collaborative context.

PBL AND DIVERSITY

Problem based learning is a socio constructivist pedagogy in which learners work in groups through a pedagogical process to solve a problem while at the same time constructing their own knowledge.

Problem based learning naturally lends itself to diversity as the learner can choose the role which they would like to undertake in the PBL process, allowing them to 'play to their strengths'. However it is still largely reliant on the written word and face to face contexts. More recently studies of PBL in an online or virtual environment have been conducted, however these studies have been in specific contexts e.g. the impact of



technology mediated PBL on academic achievement and on student experience (Brodie, 2006;Gibbings et al, 2015;Cetin et al, 2019)

Regarding diversity, several studies have been conducted regarding the capacity of PBL to develop intercultural learning and developing empathy in diverse cultural groups (Busse and Krause, 2015) However Robinson, 2011 found that face to face interactions in diverse groups can be difficult given communication differences and social distances can be useful in fostering relationships, however initial rapport building in an online environment is key.

In addition studies were done with mixed ability PBL groups in K12 settings and it was found that the social elements of PBL encouraged traditional students to develop an empathy towards those with special needs in face to face contexts (Belland et al, 2009)

Little research has been conducted into how to provide a universal problem based learning environment underpinned by inclusive pedagogical approaches to meet the needs of learners regardless of ability, culture or individual needs. This paper aims to address this gap by describing a practical case study in which technology supported learner preferences in a PBL group that takes account of visible and invisible learner differences.

UNIVERSAL PBL: A CASE STUDY

This case study illustrates how Universal Design for Learning (UDL) was embedded in the PBL process to support diverse learning needs. In Autumn 2019 a module on *ICT in the primary classroom* was redesigned to embed the three principles of UDL, providing an inclusive PBL model for students.

Learners were given a problem trigger to work on in collaborative PBL groups over a twelve week period. Below is an overview of how the UDL and principles were addressed in the PBL process.

Multiple forms of engagement refers to providing several ways/mediums to allow students to interact with their peers and the educator. It also encourages multiple methods to appeal to the learners individual learning motivations. In the case study learners were required to work in groups develop an ICT resource to teach a subject which met the needs of a group of primary school children outlined in the problem trigger. To appeal to their motivations, students could choose the subject which the ICT resource would teach. Learners could choose from one of five subject areas (English, Maths, Science, Geography or History), using the choice activity on the Virtual Learning Environment (VLE). This allowed them to form their PBL groups, once in their groups the leaners could choose their preferred role.

In groups students could engage with each either face to face (synchronously) or via the VLE (asynchronously). Face to face PBL tutorials were held each week so students could physically meet.



Alternatively learners could complete each stage of the PBL process in groups through a variety of asynchronous approaches using VLE functions (Wikis, glossaries, survey, choice and journaling).

These functions allowed the learners to express their knowledge through text, video, images. In a PBL group you might have some learners working face to face and others contributing asynchronously using the VLE. This allowed the PBL process to extend outside the physical classroom.

Learners could ask the PBL lecturer questions during face to face sessions which were scheduled weekly or send the lecturer a message via the VLE which allowed them to express their questions through text, video or audio.

Multiple forms of Expression refers to how learners convey their learning. In the case study learners could express their learning in a variety of ways. In the module there were two assignments which needed to be developed as part of the PBL trigger. For both assignments learners could choose the mode of assessment - they were given a choice of written, audio, video, poster, mind map, infographic or a combination of modes and were scaffolded in the process of choosing. This allowed learners to express their learning in a manner that met their individual needs.

Multiple forms of representation refers to how learning material is disseminated to the student group. In the case study learners were supported to address the problem trigger through one guest lecture and one ICT lab each week. The guest lecture was a one hour session in which a topic on the use of ICT to enhance primary education was presented. This was delivered face to face and was recorded for self-directed learners; a pod cast was extracted for those learners who were auditory learners and a script for text based learners. Students could review the mode of content that met their individual learning needs.

For the ICT lab, each week the learners could choose the ICT they would like to explore further, through an electronic poll. The poll was opened 7 days before the scheduled ICT lab and closed three days prior to allow the lecturer time to prepare. To support the ICT lab students could either come to a face to face laboratory session in which the lecturer was there to work with them, guiding them through self-directed lab activities. The written and video based lab activities were made available to students who wished to study independently and they could send messages to the educator via the VLE.

CONCLUSIONS

The model allowed learners the flexibility to choose what, how and where they wanted to learn and engage with the PBL process. The students that participated in the integrated pedagogical process were students who had only experience engaging in traditional face to face learning environments in which they were expected to be physically present for all classes and group work. The students had never experienced



problem based learning, although as student teachers they had learned about the pedagogy but not engaged in this approach. The class were not diverse in the traditional sense, in that they were not from diverse cultural backgrounds, However they had diverse needs with students having competing demands including long distance commutes and additional care and working arrangements. Students completed a questionnaire identifying their multiple intelligence profile and there were a variety of learner preferences in the class.

Initial informal discussions were conducted with students overall, they enjoyed the flexibility particularly regarding the representation of content in multiple forms. They felt that this allowed them to choose how they could learn without competing with other demands. However they struggled with the uncertainty associated with problem based learning. This uncertainty was fuelled further by the responsibility of having choice in how they engaged in the learning process and expressed their learning. During the sessions and the online queries there were many discussions about how they should express their assignment work and how they should work together.

To determine the impact of the hybrid approach on the overall learning experience, further empirical research needs to be conducted regarding its effect on the academic performance of students.

Furthermore research needs to be conducted regarding the impact of multimodal PBL on the dynamic of PBL groups. Previous studies highlighted the importance of socialising beyond the PBL tutorial in fostering community between diverse PBL groups (Robinson, 2011) However Gibbings, et al 2015 highlighted the difficulties in developing high levels of communication between diverse groups in virtual environments. Studies need to be conducted to determine if multimodal PBL can foster community and socialisation in PBL groups.

REFERENCES

Belland, B.R., Ertmer, P.A. and Simons, K.D., 2006. Perceptions of the value of problem-based learning among students with special needs and their teachers. *Interdisciplinary Journal of Problem- Based Learning*, 1(2), pp.1-18.

Belland, B.R., Glazewski, K.D. and Ertmer, P.A., 2009. Inclusion and problem-based learning: Roles of students in a mixed-ability group. *RMLE online*, 32(9), pp.1-19.

Brodie, L., (2006). Problem based learning in the online environment-successfully using student diversity and e-education. In *Proceedings of the 2006 Annual Conference on Internet Research 7.0:(IR 7.0): Internet Convergences*. Association of Internet Researchers.



Busse, V. and Krause, U.M.(2015) Addressing cultural diversity: effects of a problem-based intercultural learning unit. *Learning environments research*, 18(3), pp.425-452.

Cetin, Y., Mirasyedioglu, S. and Cakiroglu, E., 2019. An Inquiry into the Underlying Reasons for the Impact of Technology Enhanced Problem-Based Learning Activities on Students' Attitudes and Achievement. *Eurasian Journal of Educational Research*, 19(79), pp.191-208.

Gardner, H. (1993). *Frames of mind: The theory of multiple intelligences*. (Second Ed.). London: Fontana Press

Gibbings, P., Lidstone, J., Bruce, C. (2015) Students' experience of problem-based learning in virtual space, *Higher Education Research & Development*, 34:1, 74-88, DOI: 10.1080/07294360.2014.934327

Hayden, S. (2011). *Enabling Curricula: The Development of a Teaching Observation Protocol to Address Students' Diverse Learning Needs*. ProQuest LLC. 789 East Eisenhower Parkway, PO Box 1346, Ann Arbor, MI 48106.

Jewitt, C. (2006). *Technology, literacy and learning: A multimodal approach*. London: Routledge.

Robinson, L (2011) *The influence of cultural diversity on student learning interactions: a qualitative study of rapport management in an undergraduate problem based learning group*. Doctoral thesis, University of Huddersfield.

AUTHOR INFORMATION

Emma O'Brien, emma.obrien@mic.ul.ie, Ireland, Mary Immaculate College, Limerick, Ireland (corresponding author)



NEW MEDIA LITERACY TOOLS IN SELF-DIRECTED LEARNING

M. Sharifah, P. Val & S.C.J. Sin

ABSTRACT

Critical learning in a self-directed problem based learning (PBL) environment requires information literacy where students are able to “recognise when information is needed and have the ability to locate, evaluate, and use effectively the needed information” (American Library Association, 1989); these are good practices while learning within a digitally networked environment. To inculcate discipline in student’s processing of real world information, information literacy tools were developed and incorporated within a macroeconomics module. The tools were developed using widely accepted information literacy resources and where possible, new media tools such as Metaverse and The Factual News Evaluator were utilised. Student surveys and recordings of their search behaviour were conducted before and after the implementation of the literacy tools. To provide more context to these findings, focus group discussions were conducted with the lecturers. Analyses reveal three key findings: 1) There is an increased awareness amongst students on the need for information processing. 2) Certain practices became more frequent post-intervention but only applies to senior students and less active users of social media in schoolwork. 3) Social environment needs closer attention as our recordings of student search behaviour show broader use of social media and discussions with lecturers address the importance of nudging by team members. Post-intervention, students’ practices in evaluating sources and verification still remain unchanged and points to the need for complementary scaffolding support from lecturers and classmates.

KEYWORDS: Self-directed learning; information retrieval and evaluation; information literacy tools; online learning environment.

TYPE OF CONTRIBUTION: Practice-based abstract

PRESENTATION FORMAT: Interactive poster presentation

The authors have chosen not to have their full abstract published in the conference proceedings. We encourage you to look for existing or future publications by these authors in other outlets.

AUTHOR INFORMATION

Sharifah Mohamed, sharifah_mohamed@rp.edu.sg, Singapore, Republic Polytechnic (corresponding author)

Val Pakirisamy, val_pakirisamy@rp.edu.sg, Singapore, Republic Polytechnic

Joanna Sin, joanna.sin@ntu.edu.sg, Singapore, Nanyang Technological University



PROBLEM-BASED LEARNING: BRINGING COGNITIVE AND COLLABORATIVE AUTHENTIC LEARNING INTO THE ON-LINE CLASSROOM

Rendell Tan

ABSTRACT

The human factors module equips the engineering undergraduates with the knowledge, skills and attitude for the aviation industry. Problem-Based Learning is adopted as the anchor pedagogy in the on-line module. The aim is to bring in cognitive and collaborative authentic learning, for students to work in virtual teams on real-world aircraft maintenance challenges. As team dynamics take time to nurture and develop, with the added challenge of learning on-line, “mini-PBL” in-class sessions are scaffolded early in the module to build trust as the virtual teams work on smaller problems. Students are next given two consecutive PBL assignments, increasingly complex and challenging. Students feedback that they find real-world problems worthwhile, and learned to work well as a team. They valued the feedback and facilitation by the instructor. None of the students felt learning on-line was a barrier. Some students’ feedback that overall workload affected effort needed for the more challenging PBL assignments. The facilitator must be mindful not to be too eager towards guiding the teams to a solution, but rather to be patient and to allow awkward pauses for students to reflect. An important facilitation skill is to ask empowering questions to deepen learning, leading to self-discovery “aha moments”, and to self-determine their next steps forward. It cannot be over emphasized that design of PBL is important for the students to progressively achieve the learning outcomes. Overall, students find PBL challenging but worthwhile, allowing them to learn as an individual and as a team to work on real-world problems.

KEYWORDS: On-Line PBL, Mini-PBL, Problem-Based Learning

TYPE OF CONTRIBUTION: Practice-based abstract

PRESENTATION FORMAT: Interactive poster presentation

INTRODUCTION

The Bachelor of Engineering with Honours in Aircraft Systems Engineering is built on an interdisciplinary curriculum and grounded on an industry approach. The focus of this programme is to produce graduates who are both theoretically grounded and practice-oriented for the aviation maintenance, repair and overhaul (MRO) industries. Constructive Alignment (CA) framework was adopted in designing and developing the



Human Factors module pedagogy – shifting the paradigm from a teacher-centred teaching to a student-centred self-directed learning approach (Tran, Nguyen, & Nguyen, 2010).

PBL - CREATING AN AUTHENTIC LEARNING ENVIRONMENT IN THE ONLINE CLASSROOM

One of the key learning outcomes of the Human Factors module is to be able to analyze potential human factors that may cause an aircraft accident. Students are required to analyze and evaluate findings from investigations to aircraft accidents, to identify root cause(s) and recommend measures to prevent future accidents.

The Human Factors module prepares the students with the knowledge, skills and attitude towards working safely as an individual and as a team. The authentic learning environment is adopted to deepen learning by bringing in real-world problems into the classroom. Students learn the skills to understand the problem, work collaboratively to rationalize and develop plausible solutions, before presenting their final solution. The aim is to bring in cognitive and collaborative authentic learning modelling real-world industry, based on real-world data, into the online classroom.

The pedagogy of Problem-Based Learning (PBL), based on the Maastricht model is adopted to achieve the learning outcomes of the Human Factors module. Maastricht University's research shows that PBL provide opportunities for the learners to have a deeper understanding of the subject matter (instead of just learning facts), collaborate within a team, think critically with an objective to solve the problem at hand, motivated to self-directed learning and more comfortable to present their views (Maastricht University - Problem Based Learning, n.d.). Given their prior knowledge and experience, the students will discover their knowledge gaps and are compelled to research, study and evaluate what is needed to solve the problem (Brodie, 2012).

SCAFFOLDING THE LEARNING OUTCOMES

Due to the Covid-19 safety measures introduced, the module is taught fully online. The class comprising 46 students formed themselves into eleven permanent and virtual teams. The students were briefed on the PBL pedagogy, supplemented by a "PBL video at Maastricht University" (Maastricht University, 2014). The module profile was given to the students via the Learning Management System prior to the start of the Trimester. Team dynamics takes time to nurture and develop and is especially challenging due to the virtual meeting discussions. Students need time to practice and develop skills of collaboration and inter-dependence as they work as a team to achieve the learning outcomes. Given the dual challenge of online class, and being new to PBL, it is only sensible to take a scaffolding approach, beginning with smaller and manageable problems which can be done within 30 minutes, followed by an instructor-led facilitation on the teams' learning. This approach allows feedback on formative assessments where students can learn and reflect on their learning – without concerns on grading.



The instructor plays an important role as facilitator to guide and direct the team learning through open-ended questions to challenge the thinking on the teams' considerations and assumptions. The class is recorded for students to review their learning. The instructor also adds value to the teams' presentations by sharing perspective and experience gained from years in the aviation industry. The discussion sessions are lively and engaging, as students are empowered to put forth their analysis, and are encouraged to pose questions to deepen their learning.

As the trimester progresses and students cover more topics in the module, the students are given more complex aircraft accident PBL scenarios. Teams are to evaluate controversial investigation reports, carry out additional research to formulate their analysis, and to put forth their arguments and recommendations. Students understand there is "no one solution". Instead, as guided by the rubrics, they are challenged to argue and rationalize their considerations, options and proposed solution.

For the third and final PBL assignment, the teams worked on a current and open-structured scenario involving our home-grown Singapore Airlines (SIA) who is currently ranked 6th safest airline in the world by Airline Ratings (Airline Ratings, 2020). In this challenging assignment which stretched over 4 weeks, the teams reviewed and evaluated actual aircraft accident investigation reports from Federal Aviation Administration Accident and Incident Database (National Transportation Safety Board), identified relevant data, made connections on weaknesses and lessons learnt, and proposed an integrated safety approach that can be applied to SIA with the objective of improving their safety ratings, and hence strengthen the value of the airline.

RESULTS AND DISCUSSION

With the approval from the Institutional Review Board, SIT (Project 2020124, 19 August 2020), a survey was carried out on the class of 46 students at the end of the module, of which a total of 35 students responded. Students need not be named. The survey on the PBL pedagogy comprise responses to statements based on a Likert Scale of 1 to 5. Students may pen their feedback on how they have benefited, and where are areas for improvements.

Almost 100% of the students (34 students: 15 Strongly Agree, 19 Agree) responded that in-class PBL sessions are interactive and engaging sessions. In such sessions, teams can view each other's solutions real-time. Students can comment or ask questions, and they benefit from the immediate and interactive feedback from fellow students and instructor. About 90% of the 35 respondents (32 students: 13 Strongly Agree, 19 Agree) responded that the challenging PBL assignments based on real-world data deepened their learning. Some of the students' feedback are:



Substantial number of real-life examples and cases are discussed to make learning more interesting & easier to remember.

I feel that having questions in PBL make the lessons engaging, and the group breakout enabled a great brainstorming during the class. Love it!

Honestly, the module was constructed well. By far, it has got to be one of the best modules I've taken. I've really enjoyed this module.

REFLECTIONS ON IMPROVEMENTS

Some students' feedback that they are uncomfortable with PBL, even though they recognized that it is designed to develop self-directed learning and teamwork. Some felt that they were unsure of what the PBL requires them to do well so that they can get a better grade. Some also felt that the PBL workload is higher than anticipated, especially when they must grapple with the demand from class quizzes, reports, presentations, and oral assessments. These are constructive and valid feedback for self-reflection on how the instructor can better explain and encourage the students to embrace PBL to develop the skills to prepare themselves as aviation engineers. There is also a need to evaluate the overall workload on the students, as they must manage a total of four module within the 12 study-week trimester. Hence, it is essential to factor adequate time in class for the students to work on the most challenging PBL, and to allow team growth and learning through effective facilitation.

It is noteworthy that there is no adverse feedback from the survey that online learning and virtual teamwork are barriers to PBL outcomes. Could it be that the students are comfortable with online collaboration given their early exposure and high utilization of social media and messaging networks?

The instructor reflected on his role as facilitator, as facilitation and timely feedback is also an important key to assuring students to achieve their learning outcomes. The facilitator must be mindful not to be too eager and too hurried towards guiding the teams to a solution, but rather to be patient and to allow "awkward" pauses for students to reflect, and to ask empowering questions to deepen learning. Facilitators need to know how to ask open ended questions to challenge thinking and raise issues that might need to be considered, hence can help scaffold student learning (Brodie, 2012).

CONCLUSION

The employment of PBL as a pedagogy is well aligned to the learning outcomes to produce practice-oriented engineers. Feedback from students is encouraging in that they are engaged and empowered to learn, and to work as a team despite being 100% online. Students find real-world problems challenging and worthwhile.



Continual assessments are to drive learning outcomes, but not to overwhelm the students. Instructors must acquire the necessary skills to guide team learning and reflections towards achieving the goals of PBL.

REFERENCES

- Airline Ratings. (2020, Jan). <https://www.airlineratings.com/news/safest-airlines-in-the-world-qantas-2020>.
- Brodie, L. (2012). Problem Based Learning. In *University Teaching in Focus - A Learning Centred Approach* (pp. 145-163). New York: Routledge.
- Maastricht University - Problem Based Learning. (n.d.). Retrieved from <https://www.maastrichtuniversity.nl/education/why-um/problem-based-learning>.
- Maastricht University. (2014, Oct 14). <https://www.youtube.com/watch?v=cMtLXXf9Sko>.
- National Transportation Safety Board. (n.d.). https://www.nts.gov/_layouts/nts.aviation/index.aspx.
- Tran, N. D., Nguyen, T. T., & Nguyen, M. (2010). The Standard of Quality for HEIs in Vietna: A Step in the Right Direction? *Quality Assurance in Education* 19 no. 2, pp. 130-40.

AUTHOR INFORMATION

Rendell Tan, rendell.tan@singaporetech.edu.sg, Singapore, Singapore Institute of Technology (corresponding author)



SUPPORTING PBL PRACTICE IN K-12 EDUCATION: THE WISE PRACTICE VIDEO CASE DATABASE (WPCD)

Thomas Brush, Krista Glazewski, Kyunbin Kwon & Anne Ottenbreit-Leftwich

ABSTRACT

The Wise Practice Case Database (WPCD) is an ever-expanding online database of multimedia video cases of authentic problem-based learning classroom practices with multiple resources and tools to enable teachers and teacher educators in a variety of disciplines to have access to models of innovative teaching practices along with additional resources to assist them with implementing these practices in their own classroom settings. The primary goal of this project is to document the innovative practices of teachers through multimedia video cases. Each case consists of instructional lesson plans and other artifacts, classroom video, and interviews with the teacher and students. We will provide an overview and demonstration of the WPCD and discuss how the WPCD is currently being used to support both pre-service teachers and practicing teachers in successfully implementing PBL in their current and future classrooms.

KEYWORDS: Video cases, PBL practice, Pre-service teachers, Teacher professional development

TYPE OF CONTRIBUTION: Practice-based abstract

PRESENTATION FORMAT: Interactive poster presentation

INTRODUCTION

An ongoing challenge facing teacher educators attempting to provide field experience opportunities for pre-service teachers involves the desire to provide multiple examples of a variety of instructional models and effective teaching practices in numerous disciplines that also involve a range of students and school demographics. In many cases, mentor-teachers providing field experiences for pre-service teachers lack the experience and expertise to effectively model and coach a multitude of teaching strategies in their classrooms. Moreover, when mentor-teachers do have expertise with multiple strategies, the limited time pre-service teachers are in actual classrooms may provide limited opportunities for them to actually observe these strategies in action.



These issues have led many researchers and educational policymakers to suggest that the use of rich, case-based video databases of teaching practices can supplement actual classroom experiences and address the issues with more traditional field experiences. The case analysis approach has been successful in a variety of disciplines (law, medicine, and even instructional design). Similar to teacher education, these are professions in which a wide variety of potential issues can arise in a given professional situation – thus, providing opportunities to explore, discuss, and reflect upon multiple authentic situations can be an effective instructional strategy.

OVERVIEW OF THE PROJECT

The Wise Practice Case Database (WPCD) is an ever-expanding online database of multimedia video cases of authentic problem-based learning classroom practices with multiple resources and tools to enable teachers and teacher educators in a variety of disciplines to have access to models of innovative teaching practices along with additional resources to assist them with implementing these practices in their own classroom settings. The primary goal of this project is to document the innovative practices of teachers through multimedia video cases. Each case consists of instructional lesson plans and other artifacts, classroom video, and interviews with the teacher and students (see Table 1).

Table 1. General components of a WPCD case.

Video Case Component	Description
Lesson/Unit Narrative	Online document providing an introduction to the lesson/unit. Information included in the introduction will include a brief description of the lesson, and a detailed chronological lesson plan for that activity.
Pre- and Post-Instruction Teacher Interview	Online video of teacher's description of the focus lesson, content standards addressed, assessment strategies, descriptions of students, teacher's debriefing after lesson implementation, etc. Video duration: approx. 15 minutes.
Classroom Video	Online video of classroom lesson or unit. Each lesson or unit contains a video or series of videos of actual classroom implementation of the instructional activity. Video duration: approx. 20 - 30 minutes, depending on overall length of instructional activity.
Teacher Reflection	Online video of teacher's review of the classroom videos and his/her reflections on the implementation of the activity.
Background Information	Online documents including a biography of the teacher, school information, and information about the student population.

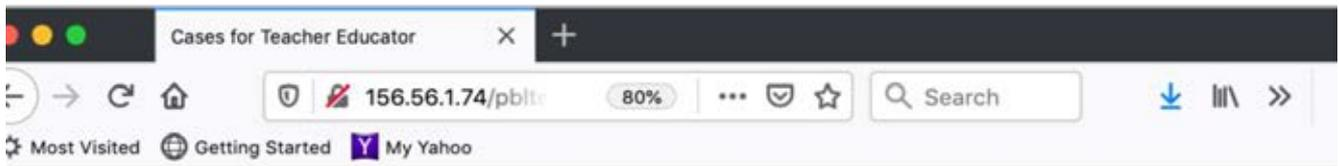


Lesson Materials	Online documents of teaching materials used in the lesson. These materials will include a description of academic standards addressed in lesson (state and national), materials used to deliver lesson (e.g., powerpoint slides, student worksheets, web sites), and assessment materials.
Student Materials	Online documents of student materials used in the lesson. These materials will include work samples of student assessments.

Design and development of each WPCD cases is managed by a team of university teacher education and instructional technology faculty, practicing teachers, and experts in instructional design, multimedia development, and computer science. The team solicits nominations each year for exceptional teachers who are implementing innovative instructional strategies in their classrooms. Based on a review of these nominations, a small number of teachers are selected for participation in wise practice case development. Cases are disseminated utilizing a web-based resource database. Current cases are already available to any interested teachers or teacher educators via an online portal (see Figures 1 and 2).



Figure 1. List of current WPCD cases.



Wise Practice Case Database for Teacher Educators

As a service to our colleagues in teacher education, we offer this selection of video cases to support teacher development. The Wise Practice Cases models authentic classroom practices with multiple resources and tools to enable both pre-service and in-service teachers to assist their students with problem-based inquiry. Cases include teaching resources (lesson plans, assessment tools, activity materials as well as video of classroom instruction and pre- and post-lesson interviews with classroom teachers. To access the video cases, click on one of the categories below.

Powerful Learning Strategies

Strategy	Description	Example
Socio-Scientific Inquiry	An activity in which students engage in an authentic science problem that also involves ethical decision-making.	Genetics Information
Introductory Grabber	An activity occurring at the beginning of a unit that provides relevance and authenticity for student learning. The activity typically links the students' experience to the unit's central question.	Civil Rights Movement
Interactive Lectures	An active learning strategy that has teacher and students work together to build the foundational historical, cultural, and conceptual contexts for inquiry into an issue.	Civil Rights Movement
Think-alouds: Historical Dilemmas	An interior monologue that gives students access to historical and conceptual understandings of an historical figure as they reason about a difficult historical decision	The Cold War
Perspective Taking: Historical Representation	Creation of a first-person account or performance that demonstrates understanding for the historical time and perspective of a real or fictitious historical figure.	Virginia Religious Freedom: Patrick Henry
Concept Discovery	Student-centered activity designed to develop mastery of a complex concept or concepts.	Just War
Analogous Case Study	Examination of an event from another time that raises the persistent issue under study. Students test the fit of the analogy and attempt to draw more general principles for deciding the issue.	Washington's Presidency: Little Rock
Discussion: Seminar	Discussion focusing on powerful texts (print, visual, or performance) that contain or raise important issues, ideas, or values. The discussion seeks to deepen participants understanding of the phenomena raised in the text.	Civil Rights Movement: Letter from a Birmingham Jail
Discussion: Deliberation	A discussion aimed at making a policy decision about a public issue. Participants frame the problem, identify and weigh alternative actions, and seek a solution that serves the common good.	Spreading Democracy
Performance: Press Conference	Small groups work together to represent the views of particular historical or contemporary actors or interest groups in a simulated press conference. Group members take on the roles of actors, public relations agents, and the press to defend their assigned positions and challenge the positions of those whose views differ.	Washington's Presidency
Performance: Hearing/Trial	Small teams work together to prepare and conduct an inquiry into the actions of historical or contemporary individuals or groups. Group members take on the roles of witnesses, legal counselors, questioners, judges, and reporters.	U.S. 1920's Congressional Hearing
Performance: Talk Show	Students assume the roles of historical or contemporary figures who hold varying views on a controversial issue. Either a student or the teacher assumes the role of talk show host and guides the panel in an examination of the different perspectives on the issue. The host takes questions from the class who pose as the studio audience.	The Future of Iraq Supreme Court - Civil Rights
Performance: Public Meeting	Small groups work together to represent the views of particular historical or contemporary actors or interest groups in a public meeting called to decide or recommend a policy position. Roles assumed by group members may include spokespeople, public relations agents, investigators, public officials, reporters, and legal counselors.	Civil Rights Movement: 1968

Contact: Dr. Tom Brush (tbrush@indiana.edu) or Dr. John Saye (sayejoh@auburn.edu) for any inquiry.



Figure 2. Screenshot of current WPCD online interface.

SIGNIFICANCE OF THE PROJECT

The significance of this project to the teacher education community is that it provides assistance to teacher educators in three distinct areas. First, the WPCD provides an extensive database of online video cases developed by collaborative teams of teacher educators and teachers throughout the world that will continue to expand in breadth and depth as the project progresses. Second, the database incorporates web-based tools and model curricula to assist teacher educators with integrating the cases into their programs. Third, we are continuing to research and disseminate various strategies to integrate these cases into existing methods and field experiences in order to increase pre-service teachers' knowledge of teaching methodologies and integration of these methodologies in their teaching.



NEW RESEARCH AND DEVELOPMENT EFFORTS

We are continuing the process of conducting research with the goal of determining the most effective methods for integrating the use of these cases into both pre-service teacher education programs and professional development with practicing teachers. This is an ongoing effort.

In addition, we are currently developing additional wise practice cases focusing on additional content areas and grade levels. These areas include:

- Computer science education (6th grade)
- English language education (7th grade)
- Food sustainability and aquaponics (7th grade)
- Robotics (5th grade)
- Paralympics sports and science (2nd grade)

AUTHOR INFORMATION

Thomas Brush, tbrush@indiana.edu, United States, Indiana University (corresponding author)

Krista Glazewski, glaze@indiana.edu, United States, Indiana University (corresponding author)

Kyungbin Kwon, kwonkyu@indiana.edu, United States, Indiana University (corresponding author)

Anne Ottenbreit-Leftwich, aleftwic@indiana.edu, United States, Indiana University (corresponding author)



PERSPECTIVES ON PUTTING A LARGE SCALE FIRST YEAR INTERDISCIPLINARY PROJECT MODULE ONLINE

Fiona Truscott, Emanuela Tilley, Kate Roach & John Mitchell

ABSTRACT

2020 introduced many challenges for those teaching in Higher Education. For the academic year 2020/21, UCL moved to online delivery of all core teaching and UCL Engineering increased its student intake by nearly 50%. This has had a significant impact on the Integrated Engineering Programme (IEP), particularly its three first year core modules. (Mitchell et al., 2019, and 2021) One of the biggest impacts has been on the Engineering Challenges module, our introduction to team-based and interdisciplinary projects for first year undergraduates. Prior to 2020, this module consisted of two 5-week, hands on, team projects where students would research problems, propose solutions and build a basic prototype. To move online we had to attempt to replicate the design-build-test process as well as the in-class facilitation that is central to active learning approaches. An added complication was the scale of the cohort, consisting of over 1,000 students who were located around the world and had not previously met. To meet these challenges, our teaching team re-structured the module by introducing the use of simulation and collaborative tools, similar to those used in industry, and revised all the content to work as a blend of synchronous and asynchronous delivery. In this paper we will discuss our approach to teaching team-based project work online as well some of the conclusions and suggestions that we have come to.

KEYWORDS: Online, Project Work, Teamwork, Large Scale

TYPE OF CONTRIBUTION: Practice-based abstract

PRESENTATION FORMAT: Interactive poster presentation

FULL ABSTRACT

The global pandemic has necessitated significant changes throughout our individual lives and society itself. Significant changes have had to be made in the education sector as our usual face-to-face set up, which brings large numbers of students together on campus and into classrooms, is a key way that the virus spreads (Adedoyin & Soykan, 2020). This has led to educational settings all over the world and at all levels moving some or all of their activities online to reduce the need for students and teachers to be brought together (Ali, 2020). In June 2020, University College London (UCL) made the decision to move to online delivery of all core teaching in Term 1 (UCL press release). As UCL Engineering is at the forefront of Engineering Education,



particularly with respect to the use of PBL and active learning methodologies, this led to a need to take modules with significant active learning content, online (Graham, 2018). One key first year module, Engineering Challenges, was a particularly challenging proposition. It consists entirely of team-based project work, contains hands-on teaching activities and is a cross faculty module taken by almost all first year undergraduates in 7 departments within UCL Engineering (Mitchell et al., 2021).

When delivered face to face the module consists of two 5-week projects, typically taken by over 700 students from 7 departments within the Faculty of Engineering. The first 5-week project is based within a student's home department, with students working in teams of 2-8 depending on the project. The aim here is to introduce students to some of the skills they will need, to project work and to their departments. Many of the projects are based around research conducted within a student's home departments and all projects are tailored to a particular discipline. For example, previous projects have included building your own computer for Computer Science students and investigating the impact of research within the Electrical and Electronic Engineering department. The second 5-week project is interdisciplinary, with departments divided into three groups and teams composed of students from 2 or 3 departments working on different aspects of the same project based around global health.

All of the assessment within the module is coursework based and is divided into several separate assignments. We utilise a range of assessment methods, including written reports and reflections, live presentations and demonstrations. Face to face sessions with students also follow a range of different formats depending on the project and the discipline. Due to the size of the module and the need for disciplinary teaching, the teaching team consists of at least one academic from each department, coordinated by a faculty level module lead. It is common for one academic to run the departmental project and another to work on the interdisciplinary project. In some aspects Engineering Challenges runs and is managed as one module with a common structure, assessment pattern and learning outcomes. However, in some aspects, the large and complex teaching team required and the tailoring of content to be discipline specific, for example, the module is more like seven 5-week projects run in parallel, followed by three 5-week projects running in parallel.

2020 provided us with two challenges – an increase of nearly 50% in student numbers (focused particularly in our four largest departments) and a need to work and teach entirely online. Another constraint we had to take into account were time zones. UCL has a large international student population and Engineering is no exception. Approximately 50-60% of our undergraduate population in the Engineering Faculty are international students. UCL gave all students the option to study remotely meaning that at 2pm in the



afternoon in London, it was midnight for our students in Australia and 9 am for our students in Peru. This only gave us a limited window in the timetable that we could use for synchronous live sessions.

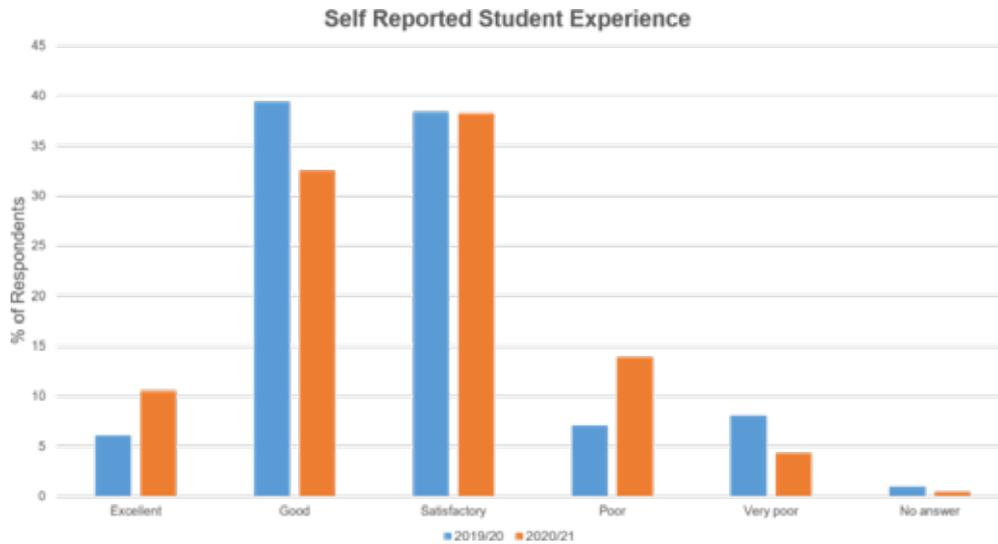
Our approach to moving the module online was to focus our limited synchronous time on meeting with individual teams and supporting and guiding their project work. This meant that we had to provide information and resources via asynchronous methods e.g. videos, text and forums. We also decided to restructure the module to provide one longer team project. We felt that the fact that our students were new to online learning and working as well as potential difficulties caused by working across time zones meant that it would take them longer to organise their team and complete tasks. Online teams work in different ways to face to face teams, with communication and trust taking longer to build (Vance et al., 2015). We wanted to give students time to adjust to learning online before they then took on the challenge of online team projects. To this end we converted the first departmental based 5-week project into a 2-week individual piece, an abridged version of the face to face departmental project, we extended the interdisciplinary project to 8 weeks. Alongside the change in structure, we brought in a streamlined assessment pattern, by reducing the complexity of individual assessments as well as combining assessments to reduce the number, in order to simplify the workload for students while still structuring the project work.

UCL already uses Moodle as it's virtual learning space so we revamped our existing Moodle site as a hub for the module, adding in more structure with weekly materials for students, links to other modules, UCL and external resources, forums for asynchronous Q&As. We saw our Moodle site as the central point for students; everything they needed would be either on the Moodle page or linked to from that page. Microsoft Teams became our collaboration platform as well as a teaching platform. We set each team up with a private channel, giving them a space that they could use to communicate and collaborate as well as were we would meet with them once a week to discuss their progress. We identified one or more project and discipline specific simulation tools that could provide our student with a virtual building experience.

The module ran from October to December 2020. Our first time delivering the module online taught us many things about how to run team project work online as well as where our assumptions about student preferences were incorrect. Using a combination of data from student feedback questionnaires (anonymised online survey, 20% response rate) and anecdotal evidence from teaching staff and students we wanted to answer two questions, 'how well did the move to online learning go?' and 'how can we improve the experience?'. When compared to student feedback data from 2019/20 (18% response rate in 2019/20), student satisfaction with the module is largely similar (**Figure 1**) as is students' self-reported achievement of the learning objectives.

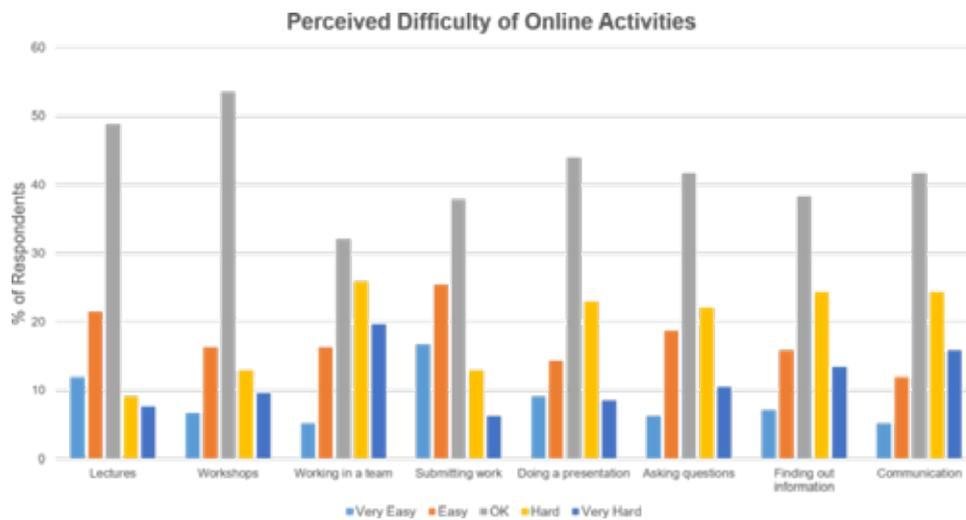


Figure 1: Self-Reported Student Satisfaction with the Module.



However, when we asked students how easy they found various learning activities to do online they reported that teamwork was one of the hardest (Figure 2). A subsequent question on where students would prefer to learn skills gave a clear majority preferring the classroom (60% in the classroom vs 8% online).

Figure 2: Students rated how easy or hard they had found particular learning activities online



We found that moving the module online exacerbated issues that we had experienced with face to face active learning. Areas such as student engagement within a team and the difficulty of working in a second language either became more obvious when working online or had a greater impact. With online teamwork we had a



larger number of reported 'non-engaging team members' than we have had previously. Whether this a direct result of online teamwork, a consequence of the more formalised reporting process we put in due to being online or due to the increase in student numbers is currently unclear. We also discovered that some of our assumptions on how students would interact with online material were not correct. In a meeting with student representatives, they corrected our assumption that students would prefer small group meetings where they wouldn't have to talk in front of large numbers of their peers. While they did find the small group meetings useful they also liked large synchronous sessions because they all could get information at the same time.

Students also used communication channels differently to approaches we had anticipated, with many teams setting up with own communication channels rather than using the ones we had provided.

In answer to our first question, how well did the move to online delivery go, it seems that it mostly went well, it is clear from our feedback that students find online teamwork very difficult. This aligns with Vance et al.'s finding that online students show more negative attitudes to teamwork than face to face students (Vance et al., 2015). In terms of improving any future online experiences, alongside adjusting our ideas of how students engage with online learning and revising our material accordingly, one key area is to find a way to add a face to face component into the module. This would provide students with a more concrete sense of the project itself and give teams a chance to bond and build trust.

REFERENCES

- Adedoyin, O. B., and Soykan, E. (2020) Covid-19 Pandemic and Online Learning: the Challenges and Opportunities. *Interactive Learning Environments*, DOI: 10.1080/10494820.2020.1813180
- Ali, W. (2020). Online and remote Learning in higher Education Institutes: A Necessity in Light of COVID- 19 Pandemic. *Higher Education Studies*. Vol. 10, No 3, p16-25, DOI: 10.5539/hes.v10n3p16
- Graham, R. (2018). The Global State of the Art in Engineering Education. MIT New Engineering Education Transformation, MIT.
- Mitchel, J. E., Nyamapfene, A., Roach, K. and Tilley, E. (2021). Faculty Wide Curriculum Reform: the Integrated Engineering Programme. *European Journal of Engineering Education*, 46:1, p46-66, DOI: 10.1080/03043797.2019.1593324
- Mitchell, J., Nyamapfene, A., Roach, K. and Tilley, E. (2019). DOI: 10.1080/23752696.2018.1507624
- UCL. (2020). UCL Announces Plans to be Open and Ready to Teach for September 2020. (<https://www.ucl.ac.uk/news/2020/jun/ucl-announces-plans-be-open-and-ready-teach-september-2020>)



Vance, K., Kulturel-Konak, S., and Konak, A. (2015). Teamwork Efficacy and Attitude Differences Between Online and Face-to-face Students. 2015 IEEE Integrated STEM Education Conference, Princeton NJ, p246-251, DOI: 10.1109/ISECon.2015.7119933

AUTHOR INFORMATION

Fiona Truscott, f.truscott@ucl.ac.uk, United Kingdom, University College London (corresponding author)

Emanuela Tilley, e.tilley@ucl.ac.uk, United Kingdom, University College London

Kate Roach, katherine.roach@ucl.ac.uk, United Kingdom, University College London

John Mitchell, j.mitchell@ucl.ac.uk, United Kingdom, University College London



ONGOING PROJECT-BASED LEARNING IN DIFFERENT MODALITIES OF THE INTRODUCTORY BIOLOGY COURSE DURING THE PANDEMIC

Min Zhong

ABSTRACT

As an active learning strategy, project-based learning (PBL) is widely advocated in STEM disciplines. Incorporating PBL into the lower-level science core courses has been challenging due to the large class size. Especially during the COVID-19 Pandemic in 2020, there have been significant challenges raised for project- and problem-based learning implemented in remote environments worldwide. In this study, a semester-long curiosity-driven project was carried out in the introductory biology courses in the form of a scientific research poster, with three different course modalities – face-to-face classroom, asynchronous online class and HyFlex class. Utilization of the Virtual Exhibition Hall (VEH) as an innovative instructional platform is proposed to overcome the limitations of project exhibition and interaction due to the large class size and course modalities. To examine the effectiveness of PBL in different modalities of the same science core course and to assess the use of an innovative virtual reality platform, the SoTL research method with both quantitative and qualitative instruments was designed to collect data regarding students' learning experience. Preliminary data has demonstrated a positive impact on student outcomes and satisfaction, including a considerable increase in intrinsic motivation and attitudes regarding science. More data will be collected from all three course modalities in 2020 and 2021.

KEYWORDS: Course modality, PBL, Virtual reality, Introductory Biology, Learning experience

TYPE OF CONTRIBUTION: Practice-based abstract

PRESENTATION FORMAT: Interactive poster presentation

BACKGROUND

Project-based learning (PBL) is an active learning approach that enables students to conduct authentic research, integrate theory, and apply knowledge (Savery, 2006). Studies have shown that PBL not only promotes students' skills in reading, writing, communication, collaboration, synthesis, and evaluation, but also enhances long-term retention in the STEM field (Emery and Morgan, 2017, LaForce et al., 2017).



Moreover, engaging in at least one project-based course during the first four semesters was found to improve student perceptions of STEM skills and STEM career aspirations (Beier et al., 2018). Therefore, incorporating a PBL component into a freshman-level science course can prepare college students to consider their career development and improve their engagement and interest in STEM professions. However, incorporating PBL into lower-level science core courses has been challenging due to the large class sizes. Especially during the COVID-19 Pandemic in 2020, there have been significant challenges raised for project- and problem-based learning implemented in remote environments worldwide.

In this study, a semester-long curiosity-driven project was carried out in the introductory biology courses in the form of a scientific research poster, with three different course modalities. Each student participating in this study experienced one of the following modalities:

Face-to-face classroom: also called in-person classroom. Regular instructional interactions are hosted in real time for students.

Asynchronous online: fully online course setting. Students are not required to make real-time interactions. All course contents are available online for student to access whenever they choose.

HyFlex class: hybrid learning model in a flexible course structure, which provides students with different learning choices of attending classes in the classroom, participating in online class synchronously, or participating asynchronously.

Principles of Biology, BIOL1020, is the introductory science core course at Auburn University. The enrollment is usually 1,500-2,000 students per academic year, with over 95% freshmen. The course is usually taught in multiple sections with large enrollment (100 to 270 students each). Additionally, Principles of Biology Online, BIOL1023, was developed and launched in summer 2019, consisting of about 20-40 students. PBL has been implemented in my face-to-face BIOL1020 classes since 2017, as well as in the BIOL1023 online class since its launch in 2019. PBL was not stopped due to COVID-19. Thus, there are an estimated 600-700 students involved in PBL per academic year.

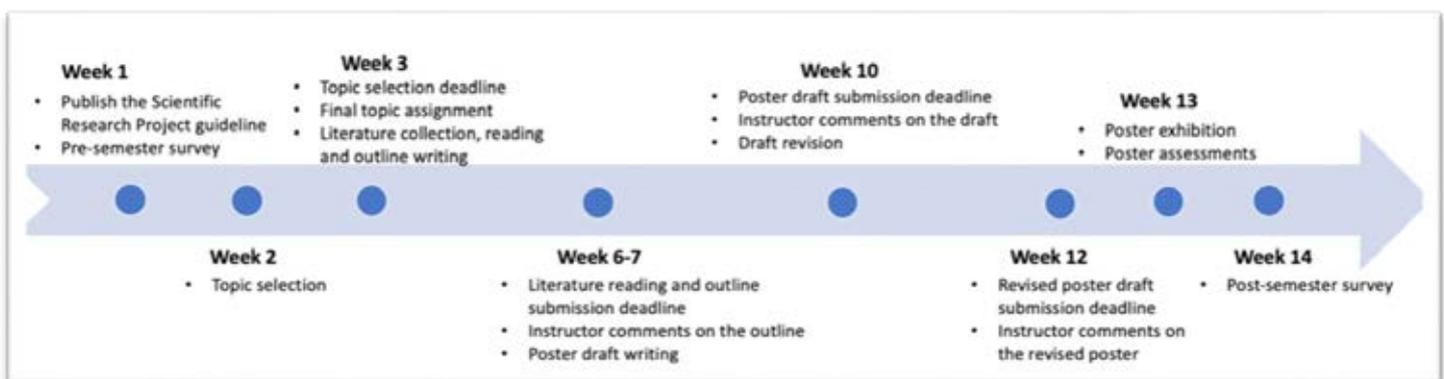
DESCRIPTION OF THE PROJECT DESIGN

The objectives of the project are to solidify students' knowledge and reasoning of science, increase team collaboration, improve scientific communication skills, promote scientific literacy, and develop oral presentations skills. The project is structured in a team-based manner and is scaffolded in several steps throughout the semester (Figure 1). The process includes research topic selection, literature reading and outline



submission, poster draft submission, revised poster draft submission, and poster exhibition. Students are given 20 research topics to choose from. The project is designed with a step-by-step approach to motivate students' learning. Students submit the assignments by each deadline and feedback is provided by the instructor. Learning assistants (LAs) and the librarian specialist provide additional assistance outside the classroom. At the end of the semester, the posters are exhibited and presented to the whole class. Assessments include grading from other student teams, faculty visitors, LAs, and the instructor.

Figure 1. Overview of the scientific research project design in the Principles of Biology class.



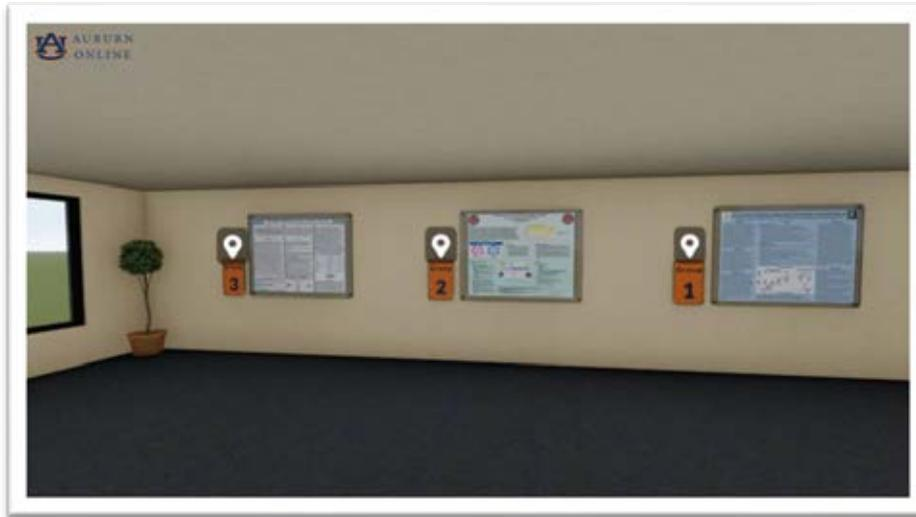
NATURE OF INNOVATION

An innovative instructional platform, the Virtual Exhibition Hall (VEH) was developed and incorporated into PBL in all course modalities. The utilization of the VEH is proposed to overcome the limitations of project exhibition and interaction due to the large class size.

The VEH uses virtual reality. The technical platform used to host the VEH allows for it to be embedded within the Canvas LMS, allowing students and instructors to easily navigate to the experience. The technical platform also allows the VEH to be accessed via a web browser for external reviewers. The first generation of the VEH was launched in the summer of 2019 class (Figure 2) with poster exhibition and audio presentation. The interactive discussion board has been developed in the 2nd generation. The maximum number of posters per room and the number of rooms are flexible. Additionally, the VEH can be open during any time period, which provides flexibility for students to access the posters for interactions.



Figure 2. The first generation of the VEH in the PBL of BIOL1023 in summer 2019



SCHOLARSHIP OF TEACHING AND LEARNING (SOTL) RESEARCH

To examine the effectiveness of PBL in different modalities of the same science core course and to assess the use of an innovative virtual reality platform, the SoTL research method with both quantitative and qualitative instruments was designed to collect data regarding students' learning experience from 3 years (Table 1).

Table 1: Data collections from different course modalities.

Intro-Biol Class	Semester	Class type	Class enrollment	Poster exhibition
BIOL 1020	Fall 2019	Face-to-face	200-273	Face-to-face
	Fall 2021			
BIOL 1020	Fall 2020	HyFlex	70-120 each	Online via VEH
	Spring 2021			
BIOL 1023	Fall 2019	Asynchronous	20-50 each	Online via VEH
	Summer 2020	Online		
	Fall 2020			
	Spring 2021			



Preliminary data has demonstrated a positive impact on student outcomes and satisfaction, including a considerable increase in intrinsic motivation (e.g. actively posting and answering questions through the classroom interaction), teamwork skills and attitudes regarding science. Over 70% of students reported the skills improved in terms of managing conflicts and solving scientific problems. Student experience with the innovative VEH showed that the VEH is a very effective platform to enhance their learning outcome through reading other groups' posters and increasing the quality of classroom interaction. More data are being analyzed from all three course modalities.

REFERENCES

Beier ME, Kim MH, Saterbak A, Leautaud V, Bishnoi S, Gilberto MJ. 2018. The effect of authentic project-based learning on attitudes and career aspirations in STEM. *J. Res Scie Teach.*, 2019, 56: 3-23.

Chen B, Bastedo K and Wendy H. 2018. Exploring Design Elements for Online STEM Courses: Active Learning, Engagement & Assessment Design. *Online Learning Journal.* 22(2): 59-75.

Emery LR, Morgan SL. 2017. The application of project-based learning in bioinformatics training. *PLoS Comput Biol* 13(8): e1005620. <https://doi.org/10.1371/journal.pcbi.1005620>

Freeman S, Eddy SL, McDonough M, Smith MK, Okoroafor N, Jordt H, Wenderoth MP, 2014. Active learning increases student performance in science, engineering, and mathematics. *PNAS* 111 (23), 8410–8415.

Gormally C, Brickman P, Lutz M. Developing a Test of Scientific Literacy Skills (TOSLS): measuring undergraduates' evaluation of scientific information and arguments. *CBE Life Sci Educ.* 2012 Winter;11(4):364-77. doi: 10.1187/cbe.12-03-0026. PMID: 23222832; PMCID: PMC3516792.

LaForce, M., Noble, E., & Blackwell, CK. (2017). Problem-Based Learning (PBL) and Student Interest in STEM Careers: The Roles of Motivation and Ability Beliefs. *Education Sciences*, 7(92), 1-22.

Savery JR. 2006. Overview of problem-based learning: Definitions and distinctions. *Interdiscip. J. Probl. Based Learn.* 1, 8-20.

Young A and Norgard C. 2006. Assessing the quality of online courses from the students' perspective. *The Internet and Higher Education.* 9 (2): 107-115.

AUTHOR INFORMATION

Min Zhong, zhongmi@auburn.edu, United States, Auburn University (corresponding author)



PBL, active learning and life-long learning



A NARRATIVE INQUIRY INTO LEARNING PRACTICES AND CAREER OPPORTUNITIES IN GRADUATE EDUCATION AT GULU UNIVERSITY, UGANDA

David Ross Olanya, Geoffrey Olok Tabo, Hanan Lassen Zakaria, Inger Lassen, Judith Awacorach & Iben Jensen

ABSTRACT

Narrative inquiry is concerned with the production, interpretation and representation of storied accounts of lived experience, and this provides us with an effective way of understanding the lives of graduate students. While much focus has concentrated on teachers' stories and the transmission of theoretical knowledge through lectures, little attention has been given to the relevance of narrative inquiry of student stories as lived experience in changing the delivery in higher education in view of applying theoretical and practical knowledge for solving problems in society. This study explores graduate students' life experience of a problem-based learning (PBL) approach, which introduced reflective learning and research into their respective programmes. The overall aim of the study is to strengthen career opportunities by improving graduate education, teaching and research at Gulu University, Uganda. We foreground students' narratives on mainly three themes: (a) their motivation for joining a Master's programme, (b) their experience of engaging in student-centred approaches to learning and research and (c) their hopes for career opportunities. Through the method of narrative inquiry and as a way towards improving quality in graduate education, we explore to what extent the students see an impact of a student-centred PBL approach on graduate education. Our findings reveal that while being taught using traditional approaches to learning, most students appreciate the innovative practices associated with active and problem-based learning. This study will add value to the existing field in narrative inquiry from a student perspective.

KEYWORDS: Qualitative methods, narrative inquiry, higher education quality

TYPE OF CONTRIBUTION: Extended scientific abstract

PRESENTATION FORMAT: Roundtable discussion

INTRODUCTION

This study explores graduate students' life experience of a problem-based learning (PBL) approach, which introduced reflective learning and research into their respective programmes. (For details on the approach, see Awacorach et al, 2021). Our focus is on graduate students who participated as researchers as well as



narrators. The overall aim of the study is to strengthen career opportunities by improving graduate education, teaching and research at a higher education institution. For this purpose we are foregrounding students' narratives on mainly three themes: (a) their motivation for joining a Master's programme, (b) their experience of engaging in student-centred approaches to learning and research and (c) their hopes for career opportunities.

This study aims to contribute to narrative inquiry in graduate education, bringing into perspective the students as narrators and constructors of lived experience in higher education. Our study illuminates the lived experience of 10 graduate students who were at different levels of research progress, across the faculties of science, education and humanities and business and development studies. Moreover, there is limited information on narrative inquiry from an East African context on the lived experience of students in graduate education. Our findings reveal that students get into graduate programmes on the basis of their previous subject undertaken at the undergraduate level rather the existence the various programs available at graduate level. While being taught using traditional approaches to learning, most students appreciate the innovative practices associated with active learning and problem-based learning that allow them to identify problems and seek for the solutions, in addition to other learning practices such as peer-to-peer learning, collaborative project work, seminars and reflective learning. This study will fill the gap in the existing field of narrative inquiry from a student perspective.

A review of narrative inquiry across research traditions such as education, health care, and more frequently in organizational psychology, management (particularly human resource management) (Webster and Mertova, 2007), human sciences (Bruner, 1991) showed the gain in many disciplines. For example, narrative inquiry is edging its way into leadership studies (Smit, 2017; Steyn, 2013), including the field of applied disciplines such as public administrative and public policy (Ospina and Dodge, 2005a; 2005b; Dodge, Ospina and Foldy, 2005). In the context of higher education, narrative inquiry is increasingly being conducted on teachers' experience following a constructivist tradition (Dewey, 1938); and recently in 'narrative turn' of interpretative epistemology (Dodge, Ospina, and Foldy, 2005). While much focus is concentrated on teachers' stories and the transmission of theoretical knowledge through lectures, little attention has been given to the relevance of narrative inquiry of student stories as lived experience in changing the delivery in higher education institutions, in view of applying theoretical and practical knowledge for solving problems in society.

Previous studies have focused on the cohort of teacher educators' benefits of participating in narrative inquiry by identifying personal and professional issues from local as well as global perspectives in order to improve teaching and learning (Parker, Murray-Orr, Milton-Kukner, Griffin and Pushor, 2017). In particular, the emphasis has concentrated on teacher education through narrative inquiry, and thus the sharing of



experience by teacher educators has been promoted in order to understand the context, and to make curricula reflect on lives in teacher education. Here, narrative inquiry is concerned with the production, interpretation and representation of storied accounts of lived experience (Schacklock and Thorp, 2005), and this provides an effective way of understanding the lives of graduate students. This article is organized into sections. First, is the systematic review of the literature review on narrative inquiry in the context of the global south, theoretical perspective on narrative inquiry, narrative inquiry as a methods, results, discussion and conclusion.

REVIEW OF THE LITERATURE

Literature on narrative inquiry in an African context is very limited, except in South Africa. Müller, Motai, Nkopane, Mofokeng, Lephatsoe, & Mouton (2018) explored the lived experience of post-graduate education students at the University of Pretoria as part of decolonizing of higher education. The narrative inquiry was developed through creative collaborative narrative to focus on teacher's identity and experience. Hlalele and Mashiya (2019) explore narrative expressions of two female migrant teachers in Southern Africa. They looked at narrative inquiry from a stand point of decision making practices to migrate to another country. The resolution of mobility is considered from a stand point of globalization and found that mobility is driven by conditions at the place of destination such as economic prosperity, prosperity, political stability, better living conditions, and attractive incomes. Theoretically, appreciative inquiry was used in studying teacher's narrative and argue that everyone has some unique talents to do something at the right time.

Smit (2017) investigated rural school leadership in South Africa through the lens of relational and emotional labour in education service occupation. The aim was to promote professional aspects of visioning, collaborating, encouraging and intuition. Two schools were selected for narrative inquiry by using ethnographic observation field texts to construct the past, present and future experiences. It was found that leadership role is worthwhile when there is hope, courage, high points and pleasant experiences. Similarly, Steyn (2013) studied leadership in principal's succession within South African schools where quality education is of the utmost importance. Here, the focus was on professional and organizational socialization. A total of five narrative interviews were conducted over a period of three years with the principal. At the beginning, it was found that the principal used a task oriented approach to measure objectively the core business - the academic performance, but later balanced a core business with a 'value system' of spiritual organization, and adapted a 'collaborative leader'.

Sunday, Ramugondo and Karthard (2020) examine the professional development role transition among occupational therapists in post-apartheid South Africa. Theoretical constructs were developed in order to understand the professional role transition through an interplay of 'habitus' and structures. Narrative inquiry



as a method was done through key informants, document analysis, participant observations and reflective journals. At the beginning of analysis, participant's experiences were foregrounded, thematized with supportive with relevant quotes from participants. Themes only provided us with experiences, but not with description of theoretical description.

To sum up, very few studies, if any, look at the perspective of students in narrative inquiry in the East African context. Elsewhere, studies applying narrative inquiry have mainly focused on narrative inquiry from the perspective of teachers (Webster and Mertova, 2007). Our contribution to narrative inquiry is to bring in a student perspective based on the students' motivation for joining a Master's programmes, their learning and research process and the future of their employability within the East African perspective.

THEORETICAL AND CONCEPTUAL FRAME

Handbook of Narrative Analysis (2015) edited by Georgakopoulou and De Fina (2015) offers a trajectory from the focus on text, form and structure (Labov 1972) through Barthes' (1977) critique of Saussurean structuralism, to the narrative turn that moves beyond literary theory (Bakhtin, 1981; Bruner 1991) and finds its way into social studies with a stronger focus on social interaction and the interactional accomplishment of story-telling (Georgakopoulou and De Fina, 2015, p 10). English (2006) explored different approaches to narrative inquiry including autobiography, life-history, historical accounts, ethnographic fiction and personal diaries. For example, Bignold and Su (2013) explored the role of narrator in narrative inquiry in education by using a case-study approach.

Following the seminal contribution from narrative inquiry scholars (Colne, 2000; Connelly and Clandinin, 1986; 1988, 2006) who foregrounded the importance of John Dewey's (1938) theory of experience in teaching and learning, our study was motivated by the current practices in narrative inquiry as a field where teachers develop personal, practical knowledge of students and their work in teaching by storying their experience as teachers and educators (Parke et al. 2017). For example, Colne (2000) has focused on collaborative narrative inquiry, mainly among teachers, to make their voices heard.

Paulo Freire (1985) stressed the importance of recognizing the teacher and students as historical beings, the identity and experience can influence curriculum transformation after being foregrounded as autobiographical, lived, and storied practice (Pinar, 2012). What is common here is the call for a collaborative sharing of experience and also seeking new knowledge. Following critical narrative inquiry (Chase, 2011), this study turns to a analytic lens fully and specifically on themselves as they write, interpret, or perform narratives about their own experience. Interpretation happens throughout the research process, and in which the researcher uses "themes either within or across an individual's experience and in the social setting"



(Clandinin and Connelly, 2000, p.123) in order to create stories in the process of 'storying and restorying' (Polkinghorne, 1995, p.11).

From a theoretical perspective, this study is inspired by De Fina's (2020) concepts of doing 'narrative-as-practices' focusing on mobility (possibility of story circulation), connectivity (inter-textuality) and time and space (chronotopicity) (2020, p. 17). However, such approaches leave out the experience of the students in the process, thereby paying little attention to accounts by graduate students on topics such as motivation, learning and research practices, and career opportunities. Thus, in organizing our thinking about narrative inquiry in graduate education, we use these concepts as our guiding principle. In doing the narrative inquiry, we focus on narratives of the lived story and context of the graduate students. Our concern is about improving the quality of higher education teaching and research. The lived experience of graduate students is expected to fill the gap in narrative inquiry that has mainly reported the lived experience of teachers as one way of promoting teacher professional development.

NARRATIVE INQUIRY AS A METHOD

Design strategy

Data collection was done in a two-stage process. First, data was collected through semi-structured, written questions from a group of 10 graduate students who were selected from three faculties (education and humanities, science and business and development studies) and their programmes respectively. Ethical approval from the participants was sought before participating in the essay writing process and group focus discussions. They wrote their motivation for the different programmes and shared their teaching and research experiences through written one-to-two page essays ranging between 30-40 minutes. Here, the graduate students were participants (narrators) of their own life stories and thus constructed their lived experience at their respective programmes. The autobiographical writing is a written narrative of an individual's experience, and it is written in a way in which an individual constructs and makes sense of one's life at a particular moments.

In the second stage, an organized group interviews with students from the various programmes were conducted with the aim to combine autobiographical narratives with interview data to gain more insight into the participants' education experiences. A group interview was conducted with the 10 students to discuss and compare their individual experiences. The group interview was audio-recorded and had a duration of 3.5 hours to share their own experiences around a number of suggested areas, including the motivation, teaching and research (in relation to the focus of the study). We then used group interviews to talk through participants' narrative accounts on prior motivation, education experience at Gulu University and the hopes



of employability. The aim was to understand the students' learning experience and research process. Here, the research participants acted as narrators.

Analytical approach

At level 1, the autobiographical interviews describe the narrative content of the 10 written student essays regarding their motivation for a Master's programme; lived experience of engaging in student-centered learning and research respectively and the future of employability. While our analysis did not focus on the narrative structure, but it only focused on aspects of relevance to our three themes. For the purpose of analysis, the exercise on narrative structure was necessary for story selection purpose only. Here, we became narrators of student's stories and lived experience in graduate education. *Level 1 explores* narratives content at a surface level derived from written essay about the learning practices and career opportunity available to graduate students who were at different level of research completion.

At level 2, we identified stories on the basis of well-known criteria for the story genre (Labov, 1972; Bakhtin, 1982; Bruner, 1991), which include an orientation (imply certain directedness, or orientation to certain goal), a complication or a breach (events, or problems upon which action arises), a resolution (where action falls, or characters are able to solve their problems), and possibly a coda (lesson). Following De Fina's concepts (mobility, connectivity and space/time) we analyse stories selected on three analytical levels as illustrated in level 2 analysis. This involves a deep analysis of selected narratives, applying theoretical concepts of mobility, connectivity and time during learning and research process. At level 3, we combine findings from levels 1 and 2, moving to the discussion section on graduate students' lived experience of problem based learning (PBL) approach.

RESULT

Analysis at level 1 – Narrative content based on written essays.

The first level of analysis describes the narrative content of 10 written student essays. As indicated in our analytical approach, we do a surface level analysis at this level. This is to pave the way for a deeper analysis of selected narratives at level 2 of the analysis.

a) Motivation for joining the courses.

A brief analysis of narrative content at a surface level showed that prime motivational factors for enrolling in the courses included ambition to obtain a post-graduate degree in view of enhancing career development, job opportunities and self-employment. A further general motivation was a felt need for obtaining research and problem solving skills in order to contribute to society through better suited practices. Although there were many similarities among the 10 student essays, there were also differences that reflected their different educational backgrounds. Common to the ICT students was a desire to do something good for society and to



obtain practical ICT skills; the teacher training students were generally interested in improving interpersonal relations and in learning new teaching practices, while the MBA students tended to attach greater importance to management skills and job creation.

b) Experience of engaging in student-centred learning and research.

In response to our question about the experience of engaging in student-centred learning and research, a majority of students were very enthusiastic about the participatory approach offered by PBL. They enjoyed peer learning and found the practice-oriented approach to learning useful, not least for community outreach and ICT for development. The relationship with lecturers and supervisors was generally good. They found the lecturers committed, knowledgeable and inspirational and there was an atmosphere of free communication with many supervisors. However, some of the students also raised a number of issues, which mainly related to institutional infrastructure. These included challenges such as a shortage of classrooms, lack of internet access and lack of outreach collaboration agreements. Some students also found that some lecturers were still using traditional teaching methods with less interaction and peer learning. An issue raised by a number of students was that they found it confusing when two supervisors did not agree on the choice of a topic for a student thesis, which sometimes forced a student to find a new topic. Some students also expressed frustration about delays in the final thesis report, resulting in missed opportunity for a job promotion.

c) Hopes for career opportunities.

Our co-constructed analytical narrative of student hopes for career opportunities indicated that all 10 students were able to add a positive outcome of their engagement with student-centred learning and research. These included personal outcomes such as strengthened personal qualifications and boosted self-confidence. Through the learning process, they had developed the ability to solve community problems and to handle emergencies, and they felt better equipped to do research and apply critical thinking. Some students had been promoted to a better job and others had developed new engagements with organizations outside university. A general trend among the 10 students was that they felt that their employment situation and motivation had improved, whether aiming at a managerial position, teaching position, self-employment, public administration or a research career. In what follows, we proceed to level 2 of our analysis where we go deeper into analysis of selected narratives, applying the theoretical concepts of mobility, connectivity and time-space as indicated under Analytical Approach.

Level 2 - Connectivity, Time-Space and Mobility

This analysis draws on narrative inquiry as a practice theory. Practice theory perspective of students' lived stories and experiences are inspired by De Fina's (2020) concepts of doing 'narrative-as-practices'. These include understanding mobility as a possibility of story circulation, connectivity which involves inter-



textuality and time and space (chronotopicity) (2020, p. 17). Our presentation follows themes such as the motivation for enrollment into the graduate course, student-centered approaches to learning and research, and skills development for employability.

a) Motivation for enrollment into the courses

Our analysis focuses on individual narratives across different moments, across space and temporal scales in teaching, learning and research in the three graduate programmes. Time also helps in understanding the decision to enroll in their different programmes.

MBA 1, 2017 looks for a resolution to the complication that the job market is very competitive. The story indicates that by making an effort to upscale to a higher level of education, it is possible to withstand competition on the job market by being creative as well as being socially responsible to society.

We all know that in Uganda the job market is too competitive and stiff and for you to get a well paid job, you must improve on your level of education. So for you to be safe, you have to upgrade the level of your education. The course tunes your mind from being a job seeker to a job creator and this helped me to employ a lot of people in my business.

Similarly, ICT 1 2018 student is oriented by job requirement and course content (e-services), and gender inequality in the ICT programmes. The story has a number of complications of which some relate to the student's upscaling possibility, while others like gender inequality concerns a societal issue. The zest for 'climbing the social ladder' is resolved through decision to enrol. At the same time s/he contributes to solving the societal problem of gender inequality. What we see here is connectivity between the two stories as they both identify complications and resolutions.

I have a background in IT (graduated in 2014) but also working in the IT department for 4 years and also teaching. As a requirement to teach in the university one must have a minimum of an Undergraduate degree to be a Teaching Assistant, so I had to look for ways of climbing the ladder so that I don't remain a teaching assistant. One of the course units (E-service delivery) was one of the courses that motivated me to enrol for the course. When I enrolled for the course, out of about 23 students, six were ladies. So I looked at the gender inequality because even in the Computer Science department I would see only about 3 to 4 ladies. That was a motivating factor for me because out of the six students, four dropped out of the programme and only two were left.

b) Student-centred approaches in learning and research

The graduate students move from complication of time delays and mobility - upscaling the time experience during the research process. They connect their memories as they tie up with the past to play out in the



present moment. These complication stories circulate among students including ethical considerations which need approval by either a departmental review, or the most commonly known by the Ethics and Research Committee. This is confirmed by the MPA 1, 2015 student who narrated that:

In the trainings I got, I learnt that ethical considerations are very important in research so you have to look at the person you are interacting with as an important part of your study. So you are asked for your proposal which is submitted to the Ethics and Research Committee which goes through your proposal, gives you areas that you need to work on where you have not given ethical considerations properly before they can give you permission to carry out the research. In my case it took them a very long time to do that and I paid Ugs 300,000.

MBA 2, 2017 shows orientation in ICT as a resolution to study business administration, but this is complicated by lack of background in quantitative method. ICT as a course becomes connected to a business administration course in quantitative method. The movement between two spaces complicates the learning experience, due to pressure and time requirements to do the course. The complication is further seen in the time of moving between the faculty of medicine and main campus, and the shared stories of structural challenges which arise due to lack of space for lectures are common to many of the students' lived stories and experiences with graduate education. The student shows resolution through an aspiration for problem-based group formation and solving besides the complication arising from traditional lecture-based approaches which are common in the business and management education. However, the coda is that the new approach led to quicker research completion time and the innovation of the programme as a week-end mode of delivery.

My experience with the course was very interesting in that I was coming with my IT background into MBA. I was seeing myself falling off because a lot of things were not adding up, QM (Qualitative Methods) was not coming. I always reached class tired, during the week I am engaged at work and then travel from Lira and reach the University already exhausted and yet I have to do a marathon of two days of lectures. So I always felt exhausted and under a lot of pressure. A lot of time lost because you have to walk from the Faculty of Medicine to the main Campus to attend lectures due to limited classrooms. Personally my group contributed a lot (maybe 80%) of completing my course within the time I did because most of the things we did (research) we went through discussions at every level.

Despite the resolution in business and management and ICT programmes sharing positive lived stories and experiences in research process, MED 1. 2017 faces a complication on the basis of the research topics and professional training being linked to determination of choosing a research idea. The complication is resolved by following the degree of his/her parents.



The topic that I came out with is because I had an experience which maybe some other people also had. My topic is career management and students' academic achievements in secondary schools in Gulu District. These days parents dictate so much on what their children should be in future, which prompted me to do a research if parents should really dictate on what a child should do or what a child should become in future, or should it be from the heart of that child? So I wanted to do a research and come out openly and tell the world that children should be allowed to become what they feel they should become in future.

Here, the student's choice of research area is sometimes complicated by past critical events in life rather than the current issues being time-space shared across the programmes.

c) Hopes for career opportunities

The resolution for hopes in career opportunities by graduate students are shared across the three programmes. The resolution connects to transition from being graduate students to being skilled in problem solving, interpersonal and stress management skills and creating job. This includes transforming a research idea into usefulness to employment and problem solving. Lessons learnt by ICT 2, 2017 is that s/he managed to change a research idea into a business model that enabled self-employment, and at the same time s/he learnt how to manage stress. The coda connects involvement of undergraduate students and resolution as a part-time position at the department of computer science.

I benefitted so much from the course, personally from day one I had a very clear picture of what I wanted. I was tired of the situation where you finish your research and it is parked in a DVD in the department and with my research am looking at taking the mobile app to the market. I am focusing on self employment because I have been self employed for the last three years and with this course I have actually improved on my skills set after adding on the mobile app development. I have learnt to manage stress and now I don't care what kind of stress you're going to bring, we shall still talk. Before even finishing (the Course) I am already having a proposal from some department to apply for a part-time position, am grateful for the course and the curriculum.

MBA 1, 2017 further confirms the importance of finding a resolution to unemployment through upward mobility along the continuum of the organizational hierarchy. The Coda of the story is rich in lessons learnt as well as mobility and time-space elements. The student has gained stronger management and proposal writing skills, which has led to a promotion to a better position. Movements in time and space have improved the student's ability, leading to more self-confidence and self-respect. The student's educational story has circulated to stakeholders outside university (artisan community; Uganda Tourism Board), paving the way for the story to travel even further.



Immediately I started school some of the things were directly applicable to my job, it enabled me to perform and manage better and was easily seen by my employer and I was promoted from being a branch Manager to a regional Manager. I was able to grow a lot of revenue for the organization after the promotion by over 50% and this was basically because of the things I learnt in class and I was able to apply them. My reasoning has changed, these days when having a company meeting my overall opinion is sought and that means my opinion matters. I have so far written two major proposals for the company which brought in a lot of revenue and also made me shake hands with the President of Uganda. I also did a proposal for the artisan community and the Uganda Tourism Board has involved me and are now developing policies to make the craft sector a product of tourism. And this is where Gulu University is unique, community transformation; the training is tailored towards solving the problems of the community.

In the following discussion section, the graduate students' lived experience in the context of problem-based learning (PBL) approach is stressed into details.

DISCUSSIONS

In the discussion section, level 3 is stressed in details regarding graduate students' life experience of a problem-based learning (PBL) approach, which introduces reflective learning and research into their respective programmes. The coda (lesson) of graduate students on traditional lecture-based approach is in terms of generating commitment of lecturers to teaching. This coda on traditional lecture-based approach however meets complications due to its limited engagement with the graduate students and also in promoting research writing abilities. The complication in the traditional lecture-based approach is resolved by the orientation in the alternative PBL approach, where teaching, learning and research in graduate programmes are linked to problem solving, practices and thus complementing the delivery of knowledge-based curriculum, in addition to the connection and orientation leadership and managerial skills, collaborative learning with community.

The resolution in the alternative approach (PBL) is shared among the graduate students, especially in the ICT and business and management students who connect the PBL approach to problem solving, interpersonal interaction, leadership and managerial skills. The space between these disciplines promotes inter-disciplinarity both at knowledge and practice levels. The PBL approach meets complication in terms of inter-disciplinary in well-established professional disciplines such teaching where graduate students see complication of being supervised by non-professional, or technical disciplines like accounting and finance from a business and management field. The resolution of the students coming from a professional programme prefers to be supervised by professional supervisors at the expense of scientific approach to doing research.



In the traditional setting where conferences are organized to develop the capacity of academic staff, students' presentation at 4th Gulu University annual conference tended to complicate the knowledge-based, methodological approaches instead of the resolution in the practice-based approach. The orientation of the students' presentation to encourage student participation in research process and to resolve the attrition and increase research completion rates by learning to work together through collaborative research projects.

At the university, the resolution is that university and students is complicated in generating practical solutions to societal problem. This is resolved across the three programmes represented in our study. At the same time, this orientation is further complicated by the ethical consideration. Teaching through research is complicated by the ethical requirements. The resolution is that research sits in the community where the students have to be exposed and gain more skills that create positive impact in the community. The perception of the community is that the research should them solve their problem, not only for knowledge generation which is traditionally known.

CONCLUSIONS

In this paper, our aim is to contribute to narrative inquiry as method that can improve the quality of higher education teaching, learning and research process. This is possible when students are integrated into the planning and ensuring the quality in the delivery subject and research related issues that have implication to completion of the programmes.

Our findings reveal that while being taught using traditional approaches to learning, most students appreciate the innovative practices associated with active and problem-based learning. This study will add value to the existing field in narrative inquiry from a student perspective.

In our study, however, the students tell their complication through stories to the Dean, who has access to higher levels in the hierarchy and thus has a possibility of circulating the students' narratives to the top. This is how a narrative inquiry technique like the one used in this study might help the stories to circulate, not only among the students but also from the students to the decision making levels.

REFERENCES

- Awacorach, J, Jensen, I., Lassen, I., Olanya, D.R., Zakaria, H.L. & Tabo, G.O. (2021). Exploring Transition in Higher Education. JPBLHE. Early view.
- Bakhtin, M.M. (1981) *The Dialogic Imagination: Four Essays*. Edited by M. Holquist. University of Texas Press.
- Barthes, R. (1977). *Image – Music – Text*. Translated by Stephen Heath. London.



- Bignold, W., & Su, F. (2013). The role of the narrator in narrative inquiry in education: Construction and co-construction in two case studies. *International journal of research & method in education*, 36(4), 400-414.
- Bruner, J. (1991). The Narrative Construction of Reality. *Critical Inquiry*, 18(1), 1-21.
- Conle, C. (2000). Narrative inquiry: Research tool and medium for professional development. *European journal of teacher education*, 23(1), 49-63.
- Connelly, F. M., & Clandinin, D. J. (1986). On narrative method, personal philosophy, and narrative unities in the story of teaching. *Journal of research in science teaching*, 23(4), 293-310.
- Connelly, F. M., & Clandinin, D. J. (1988). *Teachers as Curriculum Planners. Narratives of Experience*. Teachers College Press, 1234 Amsterdam Ave., New York, NY 10027.
- Connelly, F. M., & Clandinin, D. J. (2006). Narrative inquiry. *Handbook of complementary methods in education research*, 3, 477-487.
- De Fina, A. (2020). Doing narrative analysis from a narratives-as-practices perspective. *Narrative Inquiry*.
- Dewey, J. (1938). *Experience and Education*. New York, Collier Books.
- Dodge, J., Ospina, S. M., & Foldy, E. G. (2005). Integrating rigor and relevance in public administration scholarship: The contribution of narrative inquiry. *Public administration review*, 65(3), 286-300.
- English, F. W. (2006). Understanding leadership in education: Life writing and its possibilities. *Journal of educational administration and history*, 38(2), 141-154. Fontana.
- Georgakopoulou, A. & De Fina, A. (Eds.) 2015. *Handbook of Narrative Analysis*. Wiley-Blackwell.
- Hlalele, D., & Mashiya, N. (2019). Understanding Women Teacher Transnational Migration: A Narrative Inquiry From Southern Africa. *SAGE Open*, 9(3), 2158244019865366.
- Labov, W. (1972) *Language in the inner city*. Philadelphia: University of Pennsylvania Press.
- Müller, M., Motai, C., Nkopane, M., Mofokeng, T., Lephatoe, N., & Mouton, R. (2018). Working toward a socially just curriculum in South Africa: A collaborative autobiographical narrative inquiry. *Journal of Education (University of KwaZulu-Natal)*, (74), 85-101.
- Ospina, S. M., & Dodge, J. (2005a). It's about time: Catching method up to meaning—The usefulness of narrative inquiry in public administration research. *Public administration review*, 65(2), 143-157.
- Ospina, S. M., & Dodge, J. (2005b). Narrative inquiry and the search for connectedness: Practitioners and academics developing public administration scholarship. *Public administration review*, 65(4), 409- 423.



Parker, D.C., Murray-Orr, A., Mitton-Kukner, J., Griffin, S.M., Pushor, D. (2017). Problematizing Complexities and Pedagogy in Teacher Education Programs: Enacting Knowledge in a Narrative Inquiry Teacher Education Discourse Community. *Canadian Journal of Education*.

Polkinghorne, D. E. (1995) Narrative configuration in qualitative analysis, in: J. A. Hatch & R. Wisniewski (Eds) *Life History and Narrative*, pp. 5–24 (London: Falmer Press).

Shacklock, G., & Thorp, L. (2005). Life history and narrative approaches. *Research methods in the social sciences*, 156-163.

Smit, B. (2017). A narrative inquiry into rural school leadership in South Africa. *Qualitative Research in Education*, 6(1), 1-21.

Sunday, A., Ramugondo, E., & Kathard, H. (2020). Case Study and Narrative Inquiry as Merged Methodologies: A Critical Narrative Perspective. *International Journal of Qualitative Methods*, 19, 1609406920937880.

Steyn, T. (2013). Professional and organisational socialisation during leadership succession of a school principal: a narrative inquiry using visual ethnography. *South African Journal of Education*, 33(2).

Webster, L., & Mertova, P. (2007). *Using narrative inquiry as a research method: An introduction to using critical event narrative analysis in research on learning and teaching*. Routledge.

AUTHOR INFORMATION

David Ross Olanya, d.olanya@gu.ac.ug, Uganda, Gulu University, (corresponding author)

Geoffrey Olok Tabo, go.tabo@gmail.com, Uganda, Gulu University, (corresponding author)

Hanan Lassen Zakaria, hananlassenzakaria@gmail.com, Denmark, Danish Centre for African Business (DanCAB) (corresponding author)

Inger Lassen, inglas@hum.aau.dk, Denmark, Aalborg University, (corresponding author)

Judith Awacorach, j.awacorach@gu.ac.ug, Uganda, Gulu University, (corresponding author)

Iben Jensen, ibenj@hum.aau.dk, Denmark, Aalborg University, (corresponding author)



EXPLORING EPISTEMIC FLUENCY IN GROUP WORK

Giajenthiran Velmurugan

ABSTRACT

Problem-Based Learning is often praised for its ability to develop work-related competencies in students (Chu et al., 2017; Kek & Huijser, 2017). These competencies are often developed from group work and through the engagement of a real-life problem relevant for the students' professional practice. By engaging in real-life problems students gain abilities to utilize their gained knowledge to different contexts (Bransford et al., 2000). When explaining students how to engage in PBL we tend to explain it in different phases and what methods and types of knowledge are relevant for these different phases. However, limited knowledge exists on how students actually engage with PBL when working in groups. On the other hand, workplace studies suggest that different types of epistemics are used interchangeably when engaged in professional practice (Markauskaite & Goodyear, 2017). But what about the students doing PBL? How do they use epistemics in their groupwork? And which types of epistemics are deemed more relevant than others through their interaction? In this extended scientific abstract video recordings of students doing Problem Based Project work will be analyzed from an interactional perspective to focus on what kind of epistemics are deemed relevant by the students themselves. Findings show that students fluently change between different kinds of epistemics when having discussions relevant for the nature of the project they engage in.

KEYWORDS: Group-Work, Epistemic Fluency, Team-Work, Interaction, Problem-Based Learning, Student Learning, Social Learning

TYPE OF CONTRIBUTION: Extended scientific abstract

PRESENTATION FORMAT: Roundtable discussion

THEORY

We will base this analysis on interaction analysis which can be defined as an: "*interdisciplinary method for the empirical investigation of the interaction of human beings with each other and objects in their environment*" (Jordan & Henderson, 1995, p. 39). The most important assumption to draw from this theory is that knowledge and action are social and situated in social and material ecologies, thus knowledge is not seen as something in the heads of individuals but situated in the interactions among members of a specific community in the material world (Jordan & Henderson, 1995).



RESEARCH METHODOLOGY

360-degree video recordings of students working together in their Problem-and Project Based Learning course were recorded. From the first day of the semester to the last. The students signed confidentially agreements allowing the researcher to use the video for research and public showing in conferences without any anonymization.

Video can be categorized as rich data, meaning it has the ability to capture different kinds of modes as for example talk, gestures, object handling and the visual layout of the place in which the interaction takes place. Furthermore, video provides the opportunity to re-examine an interaction providing the opportunity for detailed analyses of the interaction going on among the participants (Goldman, 2006). In this example the video recordings will be used to make an analysis of the interaction going on among the participants.

The video recordings are based on a group of 3rd semester Engineering students at Aalborg University engaged in Problem- and Project Based Learning. The students themselves form groups the first day of the semester with an initial problem they find interesting. This group of students decided to work with a problem related to the possibilities of saving energy from private houses' solar cells to a battery connected to the house. In other words, private energy storage. We enter the recording when they are discussing the size of the battery they want to examine. The interaction is originally in Danish but has been translated by the author in the shown transcripts.

PRESENTATION AND ANALYSIS OF DATA:

A CA approach will be used to show the verbal transcripts based on the Jefferson Transcript system (Jefferson, 2004). The important part of understanding a CA transcript is that numbers for example (1) means a pause of 1 second, which is deemed a long pause in interaction.

Furthermore, square brackets [] symbols overlapping speech. Conventional grammar rules do not apply to CA transcripts. We will start by showing how P introduces the idea of putting the batteries down in the floor to get heat from the batteries.

```
1 P: °like ↑if you put it down in the floor then you could make so:::me
2 (1)
3 F: but if you put it down in
4 P: [heat in it]
5 F: if you put it down in the floor then it is difficult to remove|
6 S: [yeah but the problem is if you] need to change it
7 like every fifth year after tsk like you usually don't
```

We see is that P makes a 1 second pause in line two. This might be interpreted by F as a transition relevant place as he then takes the word and provides a counter argument to P. in line 3 and 5 stating that it will be



difficult to remove if it is put down in the floor. We also see in line 4 that P. is continuing her turn from line 1 explicating that you could make heat from the batteries in the floor. S then provides a second counter argument stating the necessity of changing the batteries in line 6 and 7. When P. suggests the battery being put down in the floor because of its ability to produce heat in the floors she is talking out of a general method of heating households in Denmark. Her concern towards the placement of the battery focuses on the end-user. Giving the end-user the advantage of both getting electricity and heat at the same time without extra costs. Thus, she is speaking of an imaginary possible future for the end-user application of the solution provided. However, they know from theory that the batteries need to be changed over time which is why F objects in line 3 and 5. S. continues this line of objection but within the imaginary future scenario of the end-user; it will not be user-friendly to break up floors. In the next example P. readjusts her suggestion:

```

28 P: like you you could also do it like have a giant closet (0.5)
29 M: [°a dungeon] ((laughs))
30 P: and then have like some small battery packs that like is taken up and down
31 (1)
32 P: then you don't have to have a big battery but it is like small components
33 F: yes then you don't need need batteries in a series
34 M: [e:::::::::::::::::::::::::::::::::::::::::::::hm] but you would like to get
35 the batteries' (0.5) cells drained
36 (1)
37 M: e:::qualy to get like when it is finally drained then it is the whole
38 battery you just switch
39 (2)
    
```



In line 28 which is also shown in the picture P. readjusts her suggestion to be a closet while showing the size of the closet nonverbally with her hands. She is still in an epistemic of a future imaginary scenario of the end-



user and how the end-user would interact with the closet/battery holder. She then changes epistemic towards a more theoretical notion in line 32 suggesting that you could have small components instead of a big battery, this is then picked up by F in line 33 stating you then would not need batteries in a series staying within a theoretical epistemic. Then, in line 34 M provides the counter argument that the cells in the battery needs to be equally drained, so he stays in the theoretical epistemic. We finish the discussion in the next transcript:

```
57 P: but it is not something we could test on (0.5) we could see if li:::ke if
58 maybe two batteries in a series is the same as one battery that should have the
59 same capacity like the two
60 M: but it is
61 (2)
62 P: does it drain like what what drains more what is better
63 F: what
64 M: o:::h
65 S: THEORETICALLY I think it doesn't matter
66 P: yeah theoretically but like
67 S: [(laughs)]but]
68 M: but I know
69 F: [in prac]tice
70 M: like
71 (1)
72 S: like it helped
73 M: [if] you buy a battery a bbbb bigger battery then it is not one
74 then it is not one cell
75 (1.5)
76 M: then it is several cells that are connected
77 F: it is
78 (3)
79 F: they are connected in some sort of way
80 S: and it is like if you have it in ONE box or what you say then you would like
81 to have it all drained e:::qually for then you switch the whole battery
82 otherwise you have to switch something if some of it is too drained and some of
83 the cells is not too drained then you will have to switch a battery where some
84 of it is actually all right
```

In line 57 P now makes the suggestion to test which batteries drain quickest the ones connected to each other or one big battery. She is once again changing the epistemics of the discussion, moving from an end-user imaginary scenario towards a test-situation relevant for their project. She is suggesting an experiment the group could conduct thus suggesting a potential problem to address for the group during their Problem and Project Based Course. The first counterargument towards this suggestion is seen in line 60 by M. stating that it is the same, then P. suggesting testing that. We then see a counterargument by S. in line 65 talking from a theoretical epistemic, suggesting that it does not matter from a theoretical perspective, which is then suggested to be tested in practice. M then provides the counterargument in line 73-76 stating that a big battery contains several cells and if several cells are connected, they need to be drained equally. He is continuing in a both theoretical and end-user epistemic, stating that if cells are not drained equally which



they will not be by the suggested design (theoretical epistemic) it will become costly for the end-user as they are then switching batteries that are not fully utilized (end-user epistemic).

CONCLUDING REMARKS

Throughout the discussion it becomes evident that the members of the group use different kinds of epistemics. It starts with a possible end-user epistemic which is then mixed with both a theoretical (equally drained cells) and experimental (something to test on) these kinds of epistemics is used interchangeably and fluid, the students navigate seamlessly in them. This shows that the changing fluid epistemics used in work practices shown by Markauskaite and Goodyear (2017) is also evident in Problem- and Project Based Learning tutorials when students conduct groupwork. Furthermore, it shows how students construct and negotiate future directions for their Problem and Project Based tutorial.

REFERENCES

- Bransford, J. D., Brown, A. L., & Cocking, R. R. (Eds.). (2000). *How People Learn: Brain, Mind, Experience, and School: Expanded Edition*. National Academies Press. <https://doi.org/10.17226/9853>
- Chu, S. K. W., Reynolds, R. B., Tavares, N. J., Notari, M., & Lee, C. W. Y. (2017). *21st Century Skills Development Through Inquiry-Based Learning*. Springer Singapore. <https://doi.org/10.1007/978-981-10-2481-8>
- Goldman, R. (2006). Video Representations and the Perspectivity Framework: Epistemology, Ethnography, Evaluation and Ethics. In *Video Research in the Learning Sciences* (pp. 3–39).
- Jefferson, G. (2004). Glossary of transcript symbols with an introduction. In *Conversation Analysis Studies from the first generation* (pp. 13–31). John Benjamins Publishing Company.
- Jordan, B., & Henderson, A. (1995). Interaction Analysis: Foundations and Practice. *Journal of the Learning Sciences*, 4(1), 39–103. https://doi.org/10.1207/s15327809jls0401_2
- Kek, M. Y. C. A., & Huijser, H. (2017). *Problem-based Learning into the Future*. Springer Singapore. <https://doi.org/10.1007/978-981-10-2454-2>
- Markauskaite, L., & Goodyear, P. (2017). *Epistemic Fluency and Professional Education* (Vol. 14). Springer Netherlands. <https://doi.org/10.1007/978-94-007-4369-4>

AUTHOR INFORMATION

Giajenthiran Velmurugan, vel@hst.aau.dk, Denmark, Aalborg University



THE EFFECTS OF A BIOMEDICAL SCIENCES CURRICULUM REFORM ON STUDENTS' PERCEIVED COMPETENCE DEVELOPMENT

Sanne Rovers, Anique de Bruin, Jeroen van Merriënboer & Hans Savelberg

ABSTRACT

In 2016-2017, the Biomedical Sciences bachelor program at Maastricht University, traditionally a PBL university, was reformed, aiming at a stronger focus on developing students' general academic competencies. To this end, being a communicator/ collaborator, professional/organizer, investigator/scholar and a biomedical expert were explicitly introduced as intended learning outcomes in this new curriculum.

By a longitudinal study we evaluated the effects on students' perceived competence development. Throughout the three years of their bachelor program, we surveyed two cohorts of students, following respectively the old and the revised curriculum. Focus groups were organized to gain deeper insight into questionnaire results.

RM ANOVAs indicated that students from the revised curriculum reported greater development of the general academic competencies. The interaction between cohort and study year was not significant. Contrarily, when asked about their general self-efficacy about studying Biomedical Sciences, there was a trend towards significance for students from the old curriculum reporting higher confidence in their ability to study Biomedical Sciences. The interaction between cohort and year also showed a trend towards significance.

One of the main findings from the focus groups was that students from the revised curriculum were often unclear about what was meant by the competencies. This could explain the conflicting findings described above: although students from the revised curriculum were better able to develop the general academic competencies, being confronted with them and with uncertainty about their meaning, might have made them realize that they still had a long way to go in the field of Biomedical Sciences more generally.

KEYWORDS: Curriculum reform, Competence development, Multi-method

TYPE OF CONTRIBUTION: Extended scientific abstract

PRESENTATION FORMAT: Roundtable discussion



The authors have chosen not to have their full abstract published in the conference proceedings. We encourage you to look for existing or future publications by this author in other outlets.

AUTHOR INFORMATION

Sanne Rovers, s.rovers@maastrichtuniversity.nl, Netherlands, Maastricht University (corresponding author)

Anique de Bruin, anique.debruin@maastrichtuniversity.nl, Netherlands, Maastricht University

Jeroen van Merriënboer, j.vanmerrienboer@maastrichtuniversity.nl, Netherlands, Maastricht University

Hans Savelberg, hans.savelberg@maastrichtuniversity.nl, Netherlands, Maastricht University



INTRODUCTION OF THE NHS DIGITAL ACADEMY'S PBL MSc IN DIGITAL HEALTH LEADERSHIP

Ruth Black

ABSTRACT

The goal of this roundtable application is to introduce the MSc in Digital Health Leadership, a part of the new NHS Digital Academy. Commissioned by the British Government, the Digital Academy is delivered by a partnership of Imperial College London, the University of Edinburgh and Harvard Medical School. The NHS Digital Academy is a key element of the British Health Services' Five Year Forward Plan and was set up to develop a new generation of digital leaders who will drive the information and technology transformation of the British National Health System. In just two years, the MSc in Digital Health Leadership has become the largest Master's Program within the Institute for Global Health Innovation (IGHI) at Imperial College London. The MSc in Digital Health Leadership uses a project based dissertation to support deep competency development in leading a range of innovation and transformation projects in NHS clinical environments. The goal of each project is to lead a key component of the organisation toward digital maturity or digital readiness. The organisation based dissertation projects are designed and developed for maximum local impact and are intended to be national exemplars and road maps for success in fast follower and other regional and national health care settings. All MSc students are senior consultant clinicians or IT leaders within regional or national NHS healthcare organisations. In the process of sharing information about this new nationally funded programme, Imperial College London hopes to learn about similar PBL programmes focused on high impact innovation and transformation.

KEYWORDS: Digital Health Leadership, Innovation, Transformation, Clinician Students, IT Professional Students, Digital Maturity, Digital Readiness, Partnership Delivered Education, British National Health System

TYPE OF CONTRIBUTION: Practice-based abstract

PRESENTATION FORMAT: Roundtable discussion

AUTHOR INFORMATION

Ruth Black, ruth.black@imperial.ac.uk, United Kingdom, Imperial College London (corresponding author)



IMPLEMENTING PROJECT-BASED LANGUAGE LEARNING IN COLLEGE EFL CLASSROOM: TEACHER'S PERSPECTIVES

Fei Xiong, Lei Lei & Ting Wang

ABSTRACT

While the number of studies on learners' practice of project-based language learning (PBLL) is increasing, fewer publications focus on teacher's perspectives of PBLL which are of importance to its implementation. This qualitative study attempts to explore college EFL teachers' perspectives of successes and challenges in PBLL implementation, the factors contributing to the both and tentative solutions to the challenges in the project implementation process. Three research questions were formulated: 1) What are college EFL teachers' perspectives of implementing PBLL? 2) What are influencing factors to teachers' perspectives? 3) What do college EFL teachers perceive as tentative solutions to the challenges met in implementing PBLL? Multiple data collection methods were employed: semi-structured interviews with fifteen college EFL teachers from one university in China at the end of the project about their perceptions of three phases (Project initiating & constructing, conducting, and presenting & evaluating), observations of classroom and student/teacher conferencing among three teachers, and analysis of documents including teacher lesson plans and students' final written reports and presentation videos. This study employed a constant comparative method to analyze the data and obtain the findings on teachers' perspectives of successes and challenges, the factors contributing to the both and tentative solutions to the challenges. Voicing college EFL teachers' insightful thoughts on the PBLL practice, the study is expected to have significant pedagogical implication and empower the teachers to employ PBLL in the university in China and beyond.

KEYWORDS: Project-based language learning, EFL teacher perceptions, College English teaching

TYPE OF CONTRIBUTION: Practice based abstract

PRESENTATION FORMAT: Experience demonstration

Project-based language learning (PBLL) originates from project-based learning (PBL) and is a language teaching method adopted in second/foreign language (ESL/EFL) learning context. PBLL integrates language



and content, and facilitates students to collaboratively conduct the projects of real world problems in English (Beckett & Slater 2005). In implementing PBL, teachers play an active role. Their practice is largely influenced by their perspectives of PBL, which are primarily shaped by the implementation experience. “Like students, teachers need to feel competent and value what they are doing in order to be willing to engage in new forms of instruction” (Blumenfeld et al., 1991, p. 381). Thus, teachers’ perspectives of PBL are of great importance to the quality of their practice.

Recent years witnessed an encouraging number of studies on the implementation and validity of PBL. However, the researches accentuate learners’ practice and progress, such as learner effort, improvement of learners’ competences (Bas, 2008; Greenier, 2020; Kettanun, 2015; Malkova & Kiselyova, 2014; Xia & Zhang, 2017).

Comparatively, fewer publications focus on teacher’s perspectives of PBL. Two studies probed into both the students’ and teachers’ perceptions (Kim, 2015; Petersen & Nassaji, 2016). By analyzing the learners’ and the teacher’s journals and interviewing the learners, Kim (2015) acknowledged the benefits of projects: encouraging learners to develop linguistic and topic-related knowledge, and promoting independent and collaborative learning. Meanwhile, the author identified the resistance from both the students and the teacher, along with the challenges such as teacher’s changing role and plagiarism, and believed that the communication between teachers and students could ease students’ frustration. But the study that only involved one teacher’s reflection was insufficient to represent a big picture. By comparing the students’ and teachers’ perspectives, Petersen and Nassaji (2016) summarized that compared with students, teachers may have agreed more with many of the attributes, such as learner engagement, group work and language learning, and examined the possible reasons behind. Similarly, another study investigated among 162 English teachers from 26 secondary schools in Ningbo, China. It found “most of language teachers are positive towards the implementation of PBL, even though the educational culture is opposite to the principles of conducting PBL in secondary schools in Ningbo” (Xu et al., 2017).

The preliminary studies above on teachers’ perspectives serve as a foundation of the current research. Previous studies on teachers’ general attitudes toward PBL concerned its attributes but failed in in-depth



exploration of the successes and the challenges perceived in every phase of project implementation process, neither did they present specific tentative solutions to the challenges from teachers' perspective.

The current study attempts to explore college EFL teachers' perspectives of implementing PBLL in college EFL classroom, including successes and challenges they perceive, the influencing factors to the perspectives and the tentative solutions to the challenges met in the project implementation process. Three research questions were formulated:

- 1) What are college EFL teachers' perspectives of implementing PBLL?
- 2) What are influencing factors to teachers' perspectives?
- 3) What do college EFL teachers perceive as tentative solutions to the challenges met in implementing PBLL?

METHODS

This qualitative study focuses on college EFL teachers' perspectives of implementing PBLL, including successes and challenges they perceive, the influencing factors to the perspectives and the tentative solutions to the challenges encountered in the project implementation process. A single exploratory case study approach will be adopted to answer the research questions. It is appropriate because the current study posed "how" and "why" questions with the concentration at "a contemporary phenomenon within some real-life context" (Yin, 2003).

Context and participants

The research was conducted in one university in China in the spring term, 2021. All non-English major freshmen need to take English placement test comprised of two parts: listening and reading comprehension. According to the test results, approximately top 20% of students, totally 800 students, are enrolled as Level 3 starters (intermediate level) each year. The university, as a Double First-Class University, takes a lead in higher educational reform, where School of Foreign Language and Cultures have assigned a group of teachers to enact PBLL among Level 3 students since 2011. The participants of the study are 15 college English teachers. Among them, 2 are male and 13 are female. They are reported to have an average of 25 years of teaching experience (ranging from 1 to 47 years) and average of 6 years of experience teaching PBLL (ranging



from 1 to 9 years). The number of students in each class ranges from 25 to 30 and a class is usually divided into 5-6 groups.

These level 3 freshmen were required to conduct a group project on a certain subject they were interested in, based on the topics in the textbooks or from their life, throughout 17 weeks. The PBL teachers would supervise the students in and out of the class, online and offline. The project incorporated the steps suggested by Stroller (1997) and Sheppard and Stroller (1995) and the concrete three phases were as follows:

Phase 1 Initiate and construct a group project

- Students construct a proposal including survey topic, questions, design and group work allocation.
- Students search for and read literature, and write literature review.
- Students present proposals and invite peer & teacher feedback.
- Student/teacher conferencing on refining survey questions and research design.

Phase 2 Conduct a group project

- Students collect data.
- Students analyze data.
- Students present data analysis and invite peer & teacher feedback.
- Student/teacher conferencing on data analysis.
- Students write the survey report collaboratively.
- Students have peer review and revise the survey report.

Phase 3 Present and evaluate a group survey project

- Students present the survey report in group.
- Students invite peer & teacher feedback.
- Students reflect upon the whole project.

Data sources and collection

Multiple data collection methods were employed to address the purpose of this study.



Interviews. Semi-structured interviews were conducted with 15 college EFL teachers at the end of the project about their perspectives of project implementation. The interviews center around three aspects: the successes and the challenges in support of students' project implementation, influencing factors to both successes and challenges, and solutions to the challenges.

Classroom and student/teacher conferencing observations. We selected three teachers with 10-, 5- and 1-year teaching experience for observation through purposeful sampling. Firstly, two of them are experienced with an average of 7 years of PBL enactment (Creswell & Plano Clark, 2011). Secondly, the three teachers are willing to participate and capable of articulating their opinions in an expressive and reflective manner (Bernard, 2002; Spradley, 1979). Thirdly, observing the teachers with different lengths of teaching period also gave us a chance to diversify the perspectives. Two sessions from each project phase and two groups' student/teacher conferencing were selected for observation. One session was on how teacher prepared students to conduct the project, while the other session was on how students presented their work and invited peer & teacher feedback. The observers were the authors of this article and three graduate students. The observation notes were on the following themes: 1) teacher's use of technology; 2) teacher's support to language learning; 3) student engagement; 4) student teamwork; 5) difficulties emerging in teaching; 6) teaching strategies to deal with difficulties.

Documents. Other sources of data included the teacher lesson plans on the sessions for class observation, and students' final written reports and presentation videos.

Data analysis

We recorded and transcribed the interviews with participants and used a constant comparative method (Glaser & Strauss, 1967/2017). Iterative rounds of data analysis began from separate analysis of a few transcripts through an open coding approach, followed by the note comparison to identify common potential patterns and categories to answer the research questions. Three strategies were used to ensure the rigor and trustworthiness of this study.

Triangulation.

Three sources of data were collected to ensure triangulation: semi-interviews, classroom and tutorial observations, and documents. We had a constant back and forth between coding of interviews, observation results and documents such as teacher lesson plans.



Member checks. The interview transcripts were sent to all the teachers for the review and necessary changes (Creswell, 2008). We also emailed a draft copy of the research paper to all the teachers.

Peer debriefing. We held a numerous debriefing session and discussed the codes and emerging themes to guarantee consistency, negotiate and resolve differences.

This study aims to have an in-depth exploration of college EFL teachers' perspectives of implementing PBL, including successes and challenges they perceive, the influencing factors to the perspectives and the tentative solutions to the challenges encountered in the project implementation process. Voicing teachers' insightful thoughts, the study is expected to have significant pedagogical implication and empower the teachers to employ PBL in the university in China and beyond.

NOTES

In order to collect the most updated data, the data collection and analysis will continue in the spring term, 2021. Therefore, the final results and discussions are not included in the current abstract. We ensure that the whole research will be completed in five months and the findings will be obtained before August.

REFERENCES

- Bas, G. (2008). Implementation of multiple intelligences supported project-based learning in EFL/ESL classrooms. *Online Submission*, 11. Retrieved October 22, 2019, from <https://eric.ed.gov/?id=ED503870>.
- Beckett, G. & Slater, T. (2005). The project framework: a tool for language, content and skills integration. *ELT Journal*, 59(2), 108-116.
- Bernard, H. R. (2002). *Research methods in anthropology: Qualitative and quantitative approaches* (3rd ed.). Walnut Creek, CA: Alta Mira Press,
- Blumenfeld, P., Soloway, E., Marx, R., Krajcik, J., Guzdial, M., & Palincsar, A. (1991). Motivating project-based learning: Sustaining the doing, supporting the learning. *Educational Psychologist*, 26, 369-398.
- Greenier, T. V. (2020). The 10cs of project-based learning TESOL curriculum. *Innovation in Language Learning and Teaching*, 14(2), 27-36.



Creswell, J. W. (2008). *Educational research: Planning, conducting, and evaluating quantitative and qualitative research* (3rd ed.). Upper Saddle River, NJ: Pearson/Merrill Prentice Hall.

Creswell, J. W., & Plano Clark, V.L. (2011). *Designing and conducting mixed method research* (2nd ed.). Thousand Oaks, CA: Sage.

Glaser, B. G., & Strauss, A. L. (2017). *The discovery of grounded theory: Strategies for qualitative research*. New York: Routledge (Original work published in 1967).

Kettanun, C. (2015). Project-based learning and its validity in a Thai EFL classroom. *Procedia - Social and Behavioral Sciences*, 192, 567-573.

Kim, M. K. (2015). Students' and teacher's reflections on project-oriented learning: A critical pedagogy for Korean ELT. *English Teaching*, 70(3), 73-98.

Malkova, I. Y. & Kiselyova, P. V. (2014). Development of personal competences in project-based learning in the EFL classroom. *Procedia - Social and Behavioral Sciences*, 154, 254-258.

Petersen, C. & Nassaji, H. (2016). Project-Based Learning through the Eyes of Teachers and Students in Adult ESL Classrooms. *The Canadian Modern Language Review*, 72(1): 13-39.

Sheppard, K., & Stroller, F. L. (1995). Guidelines for the integration of students projects in ESP classrooms. *English Teaching Forum*, 33, 10-15.

Spradley, J. P. (1979). *The ethnographic interview*. New York: Holt, Rinehart & Winston.

Stroller, F. L. (1997). Project work: A means to promote language and content. *English Teaching Forum*, 35, 2-9.

Xia, S. H. & Zhang, W. Z. (2017). Learner Effort in Project-based Language Learning. *Foreign Languages and Their Teaching*, 3, 78-88.

Xu, Y.J., Kuan, K.J., Rajoo, G. S. R. & Chua, S. P. (2017). English Teachers' Perceptions of Project-based Language Learning in Secondary Schools in Ningbo China. *The Southeast Asian Journal of English Language Studies*, 23(4): 235 – 250.



Yin, R. K. (2003). *Case study research*. Thousand Oaks, CA: Sage.

AUTHOR INFORMATION

Fei Xiong, xiongf@cqu.edu.cn, China, Chongqing University (corresponding author)

Lei Lei, leileicindy@cqu.edu.cn, China, Chongqing University

Ting Wang, 2938274741@qq.com, China, Chongqing University



A COLLABORATIVE FACULTY PROJECT TO INTRODUCE A COMPLEX FRAMEWORK FOR TEACHER PRACTICE

Cheryl Bowen, Pedro Hernández-Ramos, Kathy Sun & Keith Yocam

ABSTRACT

The Universal Design for Learning (UDL) framework was proposed in the 1990's to guide practicing and new teachers in the adaptation and modification of learning plans so that the needs of all students are met, regardless of physical or learning limitations (Meyer, Rose, & Gordon, 2014). In the United States, future teachers generally receive very limited instructional time to prepare them to work with the wide range of student skills, background knowledge, physical or learning disabilities, and other characteristics that make the typical classroom a very demanding professional space (Stites, Rakes, Noggle & Shah, 2018).

Rather than assume that future teachers would be able to assimilate all the information and benefits of knowing how to integrate the UDL framework in their lesson and curriculum planning, a team of four faculty in a Northern California teacher preparation institution collaborated on a strategy to introduce UDL in two courses that engaged students in meaningful project-based learning (PBL) activities that required them to think about the many ways in which UDL can benefit both their learning designs and student performance. This paper describes the experiences in each of the courses and argues that this collaborative, PBL-inspired approach was successful in developing students' knowledge of the UDL framework and their confidence in their ability to integrate it into their professional practice.

KEYWORDS: Teacher Education, Universal Design for Learning, Collaborative Project-Based Learning

TYPE OF CONTRIBUTION: Practice based abstract

PRESENTATION FORMAT: Experience demonstration

INTRODUCTION & CONCEPTUAL FRAMEWORK

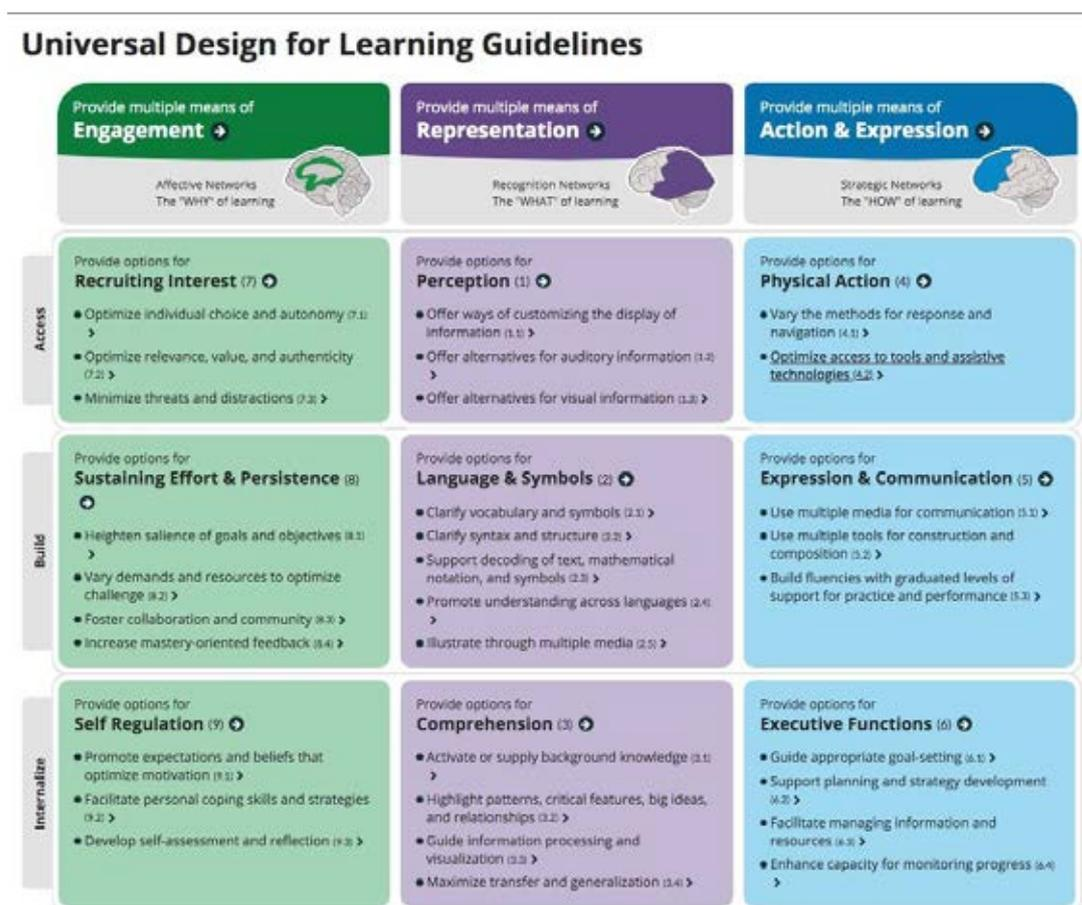
Universal Design for Learning is an approach to teaching that aims to give all students equal opportunities to succeed, no matter how they learn. In 1984, the Center for Applied Special Technology (CAST) embarked on a journey to construct technologies that would help learning disabled (LD) students overcome the learning barriers



that they faced in their home and school environments. The initial goal was to provide tools to amplify student strengths and support individual student needs.

As the CAST research evolved, the team realized that success for LD students should not hinge on helping them overcome the barriers they faced in the classroom, but in helping teachers eliminate those barriers (Meyer, Rose, & Gordon, 2014). They developed a new, more inclusive approach and in the late 1990s named it Universal Design for Learning (UDL). The UDL approach combined neuroscience and educational research while leveraging the power of digital technology to design learning opportunities that offered options for a range of diverse learners. This early work culminated in the publication of *Teaching Every Student in the Digital Age: Universal Design for Learning* (Rose & Meyer, 2002), which outlined how teachers could utilize the UDL framework for all students. Figure 1 presents the core principles of the UDL framework as presented to students in this project across four courses.

Figure 1. Universal Design for Learning Guidelines





METHODS

Setting. This project took place in the Department of Education at Santa Clara University, a private Jesuit university located in the Silicon Valley region of California. The department offers a Masters of Arts in Teaching and Teacher Credential program that prepares Multiple Subject (elementary) and Single Subject (secondary) teachers. The department's values of reflective practice, scholarship, diversity, ethical conduct, social justice, and collaboration inform both theory and practice throughout the program, with the explicit goals of having graduates whose competence, conscience, and compassion promote the common good as they transform lives, schools, and communities.

Implementation in Teacher Preparation Courses. Each participating faculty member had the freedom to decide how best to introduce the UDL framework in the context of the course they were leading. Two faculty were teaching sections of the same course and planned together, while the other faculty member worked independently. In this section, we present how we introduced UDL and the student activities that were planned in two courses.

Course 1: Technology for K-12 Teachers

In this course (Fall 2019, 94 students in four sections), the goal was to first introduce students to the UDL framework by having a poster of the UDL guidelines (see Figure 1) permanently displayed in the classrooms where the classes met, and then to require that they explicitly consider the UDL framework as they worked in their existing teams to modify a lesson or unit idea they had collaboratively developed over several weeks.

Working in teams of 3-6 people, formed by either subject-matter focus (for secondary school teachers) or preferred grade (lower or upper elementary), students first created a "lesson outline" that in one paragraph described the lesson or unit they would design, with the specification that it had to identify one or more relevant California Common Core Standards and "integrate technology in a meaningful way." In subsequent class sessions, the same teams created a WebQuest activity ([Dodge, 1995](#)) for their lesson outline, followed by an assessment plan and a rubric (using the website [Rubistar](#)), then by an idea for a game or simulation—either existing or proposed—that would fit the lesson or unit. With all that work behind them, students were introduced formally to UDL in a class session with a short lecture and video, followed by group work to make modifications to their lesson outline based explicitly on the UDL framework and focusing on one category of learner (e.g., deaf/hard of hearing, dyslexia, gifted).



In the next-to-last class session, the groups re-purposed their work into a Google Slides deck that summarized their project in a brief, five-minute presentation to the entire class. (See Figure 2.) This allowed each group to review everyone else's work, and to compare and contrast the decisions each group made when modifying their lesson overviews to accommodate the needs of their target students.

Figure 2. Selected slide from one group's presentation of a mathematics lesson outline created for the Technology for K-12 Teachers course.

Universal Design for Learning—Connections

Engagement: Recruiting Interest

- Optimize individual choice and autonomy: In our lesson plan, we give students the freedom and choice to figure out how they want to manipulate the equation however they want, leading to their own discoveries with their group members. They can manipulate what they feel comfortable with, and they're able to work at a pace that's comfortable for them.
- Optimize relevance, value, and authenticity: Students are able to apply the equation to a real-world situation (creating a roller coaster), which might be a more fun situation than just equations, and see the relevance to parabolic equations to their daily lives.

Representation: Comprehension

- Students can create data tables to record what happened when they plugged in different options. The lesson is structured in a very visual way where students highlight patterns, critical features, and relationships themselves.
- Students are also working in groups so they can explain their observations and ideas to each other. They work in groups where everyone is at different levels of language, so ELL students can practice conversation with Bilingual speakers.

Action and Expression: Expression and Communication

- Students use multiple media for their presentation. They can film videos, make a podcast, create a powerpoint or poster. It will be up to the group of students how they want to present the relationships they have noticed. We can further support ELLs by offering possible sentence patterns, having them work with an academically strong student, or a bilingual student if they need it.

At the end of each class session, students had to complete an “exit ticket” that asked them to reflect or respond on a topic or issue(s) addressed in class. Examples of students' ability to think about ways of integrating UDL into their future teaching practice are presented in the Results section below.

In sum, the PBL-informed structure of this course and the activities the students engaged in seemed to have helped the vast majority of them to work effectively with the UDL framework and more clearly envision how they could rely on it during their professional teaching practice.

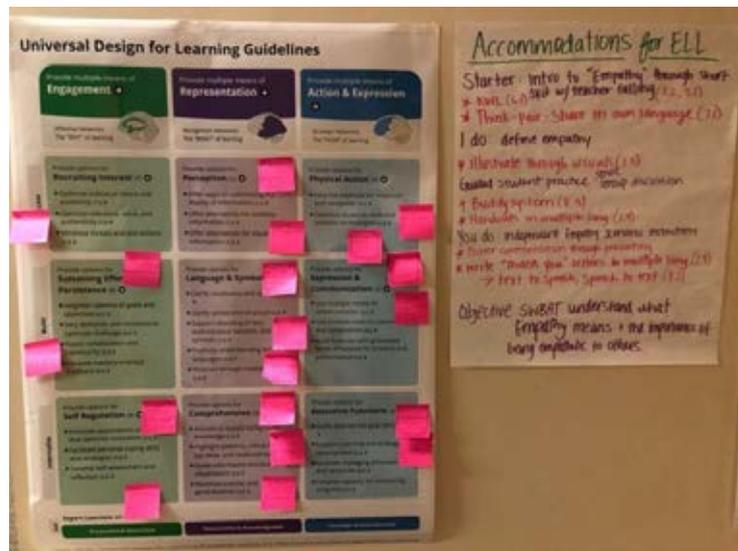
Course 2: Classroom Management for Elementary Teachers

In this course, one faculty member taught two sections during the Summer 2019 (20 students) and Winter 2020(24 students) quarters. The goal was to help students develop their ability to apply UDL Guidelines to daily instruction in the classroom. All students were preservice Multiple Subject candidates who had not yet experienced their student teaching placements. The Summer quarter students were unfamiliar with the UDL Framework; however most of the students in the Winter quarter class had an introductory knowledge of UDL—many from the *Technology for K-12 Teachers* course.



Both sections were introduced to the notion of UDL and experienced the same Common Task Activity. The instructor started the class session by showing a [UDL YouTube video](#). Next, students were asked to register for free lessons on the [Overcoming Obstacles website](#) and scan through a couple of lessons. In grade leveled groups, students chose a lesson plan and discussed what they would do to make the lesson more accessible to their assigned special needs student (ELL, Dyslexia, ADHD, Autism). The Summer quarter students posted their instructional recommendations via [Boardthing](#), while the Winter Quarter students posted their recommendations on large UDL Guideline posters (see Figure 3).

Figure 3. Student-generated UDL instructional recommendations in the Classroom Management for Elementary Teachers course, Winter quarter



Students reflected on each groups’ responses noting which guidelines had powerful recommendations and which areas were lacking. Next, the instructor encouraged students to explore websites looking for recommended instructional practices for special needs students. Finally, each student group was instructed to develop instructional accommodations for all nine UDL Guidelines and apply it to their Overcoming Obstacles Lesson Plan.

RESULTS

As instructors, we were happy to see the high levels of engagement with the UDL framework in the context of two different courses, and that students appreciated the opportunity to encounter, work with, and reflect upon the integration of the UDL framework into their preparation for teaching.



In the *Technology for K-12 Teachers* course, the exit tickets provided evidence of positive results:

- “UDL is so important because it’s focused on creating a *flexible* learning environment that accommodates all students and gives them diverse and dynamic opportunities.”
- “I really like the Universal Design of Learning because it allows teaching to be more personal and it caters to each student’s learning abilities. Providing multiple modes of representation for all instruction gives students different ways to process information and it will likely engage more of their interests.”
- “As an educator it is stressful to think about how I can reach out to all of my students, but thanks to the Universal Design for Learning Guidelines I have a clearer understanding of how I can create my lesson plans to keep in my mind all my diverse learners.”

In the *Classroom Management for Elementary Teachers* course, the class session ended with a discussion of what students learned. Examples of student work demonstrating their critical abilities around UDL are presented below:

- One Summer quarter student said, “I never understood how to specifically meet the needs of all kinds of special needs students, this was really helpful.”
- A Winter quarter student commented, “I never knew how to help kids learn when there were so many special needs students in my class. This is a great model for differentiating my instruction.”
- Another Winter Quarter student reflected, “In the Technology for Teachers class that I took during the Fall quarter, I felt like I was just introduced to the UDL Framework. Now I feel like I can really use it to guide my lesson planning.”

CONCLUSIONS

The student comments cited above, plus other student work and observations from faculty, indicate the effectiveness of the project the collaborating faculty designed to introduce and build future teachers’ knowledge of and confidence in using the UDL framework. Rather than assume that our students would be able to assimilate and deeply learn the intricacies of UDL from “exposure” to it in a single course, by introducing UDL in meaningful ways over several courses students were able to develop their understanding in a more relevant and organic way.



REFERENCES

Dodge, B. (1995). *Some thoughts about WebQuests* [web page]. Accessed at http://webquest.org/sdsu/about_webquests.html on February 24, 2020.

Meyer, A., Rose, D.H., & Gordon, D. (2014). *Universal design for learning: Theory and Practice*. Wakefield, MA: CAST Professional Publishing.

Rose, D., & Meyer, A. (2002). *Teaching every student in the digital age: Universal Design for Learning*. Alexandria, VA: Association for Supervision and Curriculum Development.

Stites, M.L, Rakes, C.R., Noggle, A.K., & Shah, S. (2018). Preservice teacher perceptions of preparedness to teach in inclusive settings as an indicator of teacher preparation program effectiveness. *Discourse and Communication for Sustainable Education*, 9(2), 21-39.

AUTHOR INFORMATION

Pedro Hernández-Ramos, phernandezramos@scu.edu, Mexico, Santa Clara University (corresponding author)

Cheryl Bowen, cbowen@scu.edu, United States, Santa Clara University

Kathy Sun, ksun@scu.edu, United States, Santa Clara University

Keith Yocam, kyocam@scu.edu, United States, Santa Clara University



WHICH INSTRUCTIONAL FORMATS ENHANCE THE DEVELOPMENT OF GENERIC COMPETENCIES?

Hans Savelberg, Jascha De Nooijer, Matt Commers, Eleonore Köhler & Diana Dolmans

ABSTRACT

The rapid evolution of knowledge and technology changes the expectations that society and employers have of university graduates as future employees. As a result, universities are required to continuously adapt their higher education programmes to assist graduates to develop into adaptive experts that are able to rapidly acquire new discipline-specific knowledge and communicate about it with diverse stake-holders. Though universities have always been places where students did not only acquire knowledge but also academic skills, higher education programmes currently pay more attention to training a wider range of competencies. We refer to these so-called 21st century skills as generic competencies.

Though broader in nature than disciplinary knowledge and skills, it would be a mistake to treat these generic competencies as skills that can be trained and acquired separately from those. In fact, to develop as an adaptive expert who possesses and applies such competencies, generic skills training has to be discipline-specific and embedded within a disciplinary knowledge context.

The goal of this Experience Presentation is to discuss firstly a more specific definition of generic skills and identify discipline-specific elements therein, and secondly how to create instructional formats that foster the development of generic competencies. The workshop will consist of three parts: 1) a brief, plenary introduction, defining the main concepts and presenting the challenge of training generic competencies (15min), 2) the development of discipline-specific generic competencies and appropriate instructional formats in small groups (45min), and 3) plenary presentation and discussion of the results from the small-groups session (30min).

KEYWORDS: adaptive expertise, autonomously driven behaviour, 21st century skills, generic competencies, instructional formats

TYPE OF CONTRIBUTION: Practice-based abstract

PRESENTATION FORMAT: Experience demonstration



Following the exponential growth in knowledge and technological developments and the ensuing change in expectations of society and employers towards graduates and future employees, universities are adapting their educational programmes. Universities have always taught more than mere knowledge by aiming to develop academic skills in their students. In our rapidly changing society, also these academic skills underwent changes and require more attention and possible redefinition.

Technological developments have changed work environments considerably, making them more complex while simultaneously increasing the pace. They change faster and require input from diverse disciplines. For employees this evolution implies that mono-disciplinary experts no longer fit the bill, instead they are expected to be flexible enough to cooperate across disciplines and borders and to quickly adapt to new situations and challenges. This changes requirements not only with respect to content, but also asks employees to be agile and adaptable, to communicate expertly with a wide range of stake-holders, to be cooperative, to show curiosity and imagination, to think critically and to be entrepreneurial (Wagner, 2008).

To adequately prepare their graduates, academic programmes increasingly incorporate generic competencies. In the nineties of last century, the CanMEDS were introduced into the medical domain as a framework of essential competencies (Frank and Danoff, 2007).

Inspired by the CanMEDS and the European competencies framework for public health workforces, we introduced at Maastricht University a framework of competencies for biomedical scientists (BioMECS, Savelberg et al. 2018) and for students in European Public Health (EPH), respectively.

The BioMECS in the bachelor programme of Biomedical Sciences distinguishes four main competencies, namely the biomedical expert, the communicator and collaborator, the well-organized professional and the investigator and scholar. The comparable four competences of an EPH bachelor are expert, investigator, communicator, and professional. To support students in their development of these competencies, competency-specific intended learning outcomes and matching teaching and learning activities and assessment tasks were designed and implemented, following the principles of constructive alignment (Biggs and Tang, 2011). Typically, these competencies are trained in longitudinal trajectories. Within these trajectories, students learn and receive formative feedback on their development of all competencies. Based on this expert and peer feedback, students build a portfolio, and reflect on their progress in competency development supported by a personal mentor. The revised curriculum for Biomedical Sciences was implemented in the academic year 2016-2017. For European



Public Health, the first cohort will start in 2020. The development of these competencies for the European Public Health curriculum were informed by the first experiences with the Biomedical Science programme.

The regular evaluation of the Biomedical Sciences programme revealed that students highly appreciated the mentoring system. Moreover, they reported that their leadership, communication and collaboration skills had been developed sufficiently throughout the bachelor programme. They were, however, less enamoured by personal reflection and peer feedback tasks and complained about the associated paperwork.

Mentors gave similar feedback with respect to the positive aspects; they observed students' growth in communication, collaborations and professional behaviour. Despite these positive changes, we noticed that, even in the revised programme that was designed around competency development, students still strongly focus on studying for and passing exams and struggle in becoming the autonomously-driven, adaptive expert.

In this EXPERIENCE PRESENTATION we aim to start a dialogue on two questions: 1) what do we mean when we talk about generic competencies? and 2) which instructional formats are optimal to assist students in developing them? CanMEDS were developed when the medical community realized that being a good physician requires more than excellent knowledge of biomedical principles, mechanisms and processes, namely also well-developed social skills (Frank and Danoff, 2007). The revision of the curricula in Biomedical Science and European Public Health was partially inspired by CanMEDS and the insight that to be a good biomedical scientist or public health professional requires skills above and beyond content expertise. In addition to these discipline-related competencies, the idea of 21st century skills and the concept of adaptive expertise (Bohle Carbonell et al., 2014) also relate to skills that address interaction with relevant partners/stake-holders, require cross-disciplinary, interprofessional cooperation, flexibility and agility and autonomously driven behaviour. Thus the term generic skills covers a wide variety of competencies and skills. Although it is accepted that development of skills is best trained in context-specific settings, given the wide definition and variety of generic competencies, good instructional formats should be applicable to a wide range of disciplines.

The workshop will consist of three parts. After a brief introduction of changing societal contexts, the need for adaptation of academic curricula and the concept and approaches of generic competencies, we will ask participants to discuss and design frameworks of generic competencies in sub-groups for programmes they are involved in. Subsequently, we will have a plenary dialogue during which these sub-groups present their designs and further discuss instructional formats suited for enhancing development of generic competencies.



REFERENCES

- Biggs, J. and Tang, C. Teaching for quality learning at university. (2011) Maidenhead: McGraw-Hill Education.
- Bohle Carbonell, K., Stalmeijer, R.E., Könings, K.D., Segers, M. and van Merriënboer, J.J.G. How experts deal with novel situations: A review of adaptive expertise. *Educ. Res. Rev.*, 12:14-29, 2014.
- Frank, J. R., & Danoff, D. (2007). The CanMEDS initiative: implementing an outcomes-based framework of physician competencies. *Medical Teacher*, 29(7), 642- 647. doi:10.1080/01421590701746983
- Savelberg, H.H.C.M., Roebertsen, H., Govaerts, M., Vernooij, J., Heeneman, S. and Köhler, S.E. Supporting students' development as self-regulating, life-long learners: a competency-based programme in biomedical sciences. In Wang, S., Kolmos, A., Guerra, A., and Qiao, W. (eds.) 7th International Research Symposium on PBL. http://vbn.aau.dk/files/289259682/2018_IRSPBL_Proceedings_Innovation_PBL_and_Compotence.pdf
- Wagner T. The Global Achievement Gap. The Perseus Books Group, 2008.

AUTHOR INFORMATION

- Hans Savelberg, hans.savelberg@maastrichtuniversity.nl, Netherlands, Maastricht University (corresponding author)
- Jascha De Nooijer, j.denooijer@maastrichtuniversity.nl, Netherlands, Maastricht University
- Matt Commers, matt.commers@maastrichtuniversity.nl, Netherlands, Maastricht University
- Eleonore Köhler, leo.koehler@maastrichtuniversity.nl, Netherlands, Maastricht University
- Diana Dolmans, d.dolmans@maastrichtuniversity.nl, Netherlands, Maastricht University



PROBLEM-BASED LEARNING: ASSUMED AND ASSIGNED ROLES IN MEDICAL EDUCATION

Nicolaj Johansson & Diana Stentoft

ABSTRACT

Based on an ethnographic study in which seven medical students enrolled in problem-based learning medical education were observed and interviewed during clinical practice. It became clear that clinical practice requires medical students to assume two distinctly different roles depending on the specifics of the situations in which they find themselves. While they are sometimes expected to contribute to the treatment of patients on a par with the doctors, at other times they are perceived as students who are still in the process of *becoming* doctors. Adapting to the demands of these roles requires students to be able to switch between two different ways of thinking about the nature of the different responsibilities that follow from these roles. As students they are responsible for learning whereas the role of doctor requires them to feel responsibility for the treatment of patients.

The aim of this paper is to explore how a problem-based learning curriculum assumes students' to adapt to various roles and how students experience these roles during clinical practice.

An ethnographic study was conducted at Aalborg University Hospital involving 200 hours of participant observation and 10 hours of semi-structured interviews. The fieldnotes and interviews were analysed thematically.

The findings illustrate how a problem-based learning curriculum influences medical students' abilities to handle the responsibilities for learning as well as treatment of patients allowing them to assume the role of medical student and doctor at various times depending on the context.

KEYWORDS: Medical education, professional identity, transition, work-based learning, preparedness

TYPE OF CONTRIBUTION: Extended scientific abstract

PRESENTATION FORMAT: Interactive poster presentation

INTRODUCTION

PBL originated in medical education to enable a smoother transition of medical students into clinical practice and prepare them better for the work as doctor (Boud & Felitti, 1998).



In PBL, students work in collaborative groups to identify what they need to learn in order to solve an authentic problem (Dolmans, De Grave, Wolfhagen & Van Der Vleuten, 2005). They engage in self-directed learning and apply their prior knowledge to the problem and reflect on what they have learned (Hmelo-Silver, 2004). The intention of PBL include helping students develop flexible knowledge, problem-solving skills, self-directed learning skills, collaboration skills, and intrinsic motivation (Hmelo-Silver, 2004).

The medical education at Aalborg University is based on a combination of PBL and clinical practice and the signature pedagogy of this medical education can be defined as learning *for* work, learning *at* work and learning *from* work, with an emphasis on observation, social interaction and supervision in an authentic environment (Billet, 1994).

The purpose of this paper is to explore how a problem-based learning curriculum assumes students' to adapt to various roles and how students experience these roles during clinical practice.

METHOD

Because of my specific concern with how PBL supports medical students in changing between different roles, learning environments, and social groups in their everyday work life. Data was produced using participant observations and semi-structured interviews. I carried out the observations to capture students' social acting in the clinical practice and go beyond what they say to what they do.

A thematic analysis of the fieldnotes from the participant observations and the semi-structured interview was conducted to identify and analyse themes and categories.

RESULTS

Below an example from the results of one medical student are presented illustrating three main themes: "Role as a doctor" and "Role as a student" & "The role of problem-based learning".

Role as a student:

"The morning conference is about to start, and the doctors are busy preparing their presentation of the ward cases. I am seated with the medical students, along the wall as we are told. Even though, there are several empty seats around the table in the conference room, no one of us are invited to take a seat at the table and join the discussions. I got this strange feeling of "us and them", because of the way the room is furnished and the missing interaction between the doctors represented at the conference and the medical students". (Maria, 5th year graduate medical student)



In this situation, the medical students are not encouraged to contribute to the discussion of the ward cases. It becomes clear that the medical students are attending to the conference as learners and not as an integrated part of the professional community and they are assigned the role as students. In the situation described above the medical students' primary responsibility is to acquire new knowledge and develop the ability to self-directed learning, problem-solving which is supposed to support their ability to handle other demanding situations.

Role as a doctor:

"Her supervisor asks her if she is prepared to carry out the consultation on her own, which she accepts. Shortly after we leave the office and walk down the aisle toward the patient who is waiting for a consultation according to the cancer treatment. She is obviously nervous, she blush and speak in a faltering voice to the patient. [...] on her own in the examining room, responsible for asking the right questions, acting and thinking like a doctor." (Maria, 5th year graduate medical student)

In this situation the medical student is assigned the role as doctor. In a demanding situation like this, the ability to employ the acquired knowledge and problem-solving skills, self-directed learning skills, collaboration and communication skills, becomes important.

The role of problem-based learning:

"Maria is told to update the patient's medication list by her supervisor. At first, she hesitates to assume the task, but the supervisor encourages her to try and she finally agree. [...] While watching her sitting by the computer searching for information about medicine, I ask her where she acquired the knowledge to solve a case like this? By reading plenty of patients' records, but primarily it is the case-work at the university and the clinical practice, that has prepared me and developed that kind of thinking about what is important and how to get one's priorities right." (Maria, 5th year graduate medical student)

In this situation the medical student rapidly adapt to the requirements of the task and are expected to switch role from student to doctor in a few seconds. She emphasize that PBL case-work at the university and case-work in the clinical practice, has developed the ability to adapt to the requirements of demanding situations and switch between different ways of thinking.



CONCLUSION

The findings indicate that PBL competencies such as problem-solving, self-directed learning, ability to reflect on what they learned, collaboration, and communication skills influence the abilities of medical students to adapt to the requirements of the roles they are expected to assume in the clinical setting. This leads us to the conclusion that the PBL curriculum in medical education has an important and meaningful role to play in supporting the medical students' ability to handle the responsibilities for learning as well as treatment of patients allowing them to assume the role of medical student and doctor at various times depending on the context.

REFERENCES

- Billett, S. (1994). Situating Learning in the Workplace - Having Another Look at Apprenticeships. *Industrial and Commercial Training*, 26(11), 9–16.
- Boud, D. J., & Feletti, G. (1998). *The challenge of problem-based learning*. New York, NY: Routledge. Buy
- Dolmans, D., De Grave, W., Wolfhagen, I., & Van Der Vleuten, C. (2005). Problem-based learning: future challenges for educational practice and research. *Medical Education*, 39(7), 732–741.
- Hmelo-Silver, C. (2004). Problem-Based Learning: What and How Do Students Learn? *Educational Psychology Review*, 16(3), 235–266.

AUTHOR INFORMATION

Nicolaj Johansson, nijo@hst.aau.dk, Denmark, Aalborg University (corresponding author)

Diana Stentoft, stentoft@hst.aau.dk, Denmark, Aalborg University



LEARNING EXPERIENCES IN THE TECHNOLOGICAL EDUCATION OF PAULA SOUZA CENTER - SÃO PAULO

Elisiane Oliveira, Fabiano Walczak & Luiz Antonio Tozi

ABSTRACT

This paper shows learning experiences and management performed at Paula Souza Center, an educational institution specialized in mid and higher level courses, training technicians and technologist for the labor market. The practices described, specially about the Technological College located in São José dos Campos, São Paulo-Brazil, were based on Education 4.0 concept, that includes the joining of knowledge, abilities, attitudes, values and emotions; the use of the information and communication technologies; and active learning methodologies. These experiences are bringing a lot of learnings for students, teachers and all the academic community, that look for walking according to the education and market changes. Some of the authors that supported this article are ABIO (2010), ARAÚJO (2011), BIRCH and PICONEZ, CENTRO PAULA SOUZA, CESU (2020), CRUZ, DUSSEL (2003), MOLNÁR (2015), MONDA (2016) and PERRENOUD (1999).

KEYWORDS: Technological education; Education 4.0; Blended learning; Quality education; Learning Recovery.

TYPE OF CONTRIBUTION: Full scientific paper

PRESENTATION FORMAT: Interactive poster presentation

PAULA SOUZA CENTER

The Paula Souza Center is a government agency in the state of São Paulo, which aims to train professionals for the labor market and, for that, offers mid-level courses - technical courses - and higher level - technological courses.

To this end, the institution has 223 ETECs - Technical Schools - and 73 FATECs - Technological Colleges - distributed in 322 municipalities, serving more than 294,000 students. It also has partnerships and agreements, such as companies and industries that offer internships and on-site learning environments, exchange programs for learning in both specific and foreign languages, and policies for technological updating and innovation.

Technologists graduated at a higher level by the Paula Souza Center have a good reference in the professional market, but in areas closer to engineering and administration, they still suffer differentiation in terms of



remuneration because it is a course, in general, that requires less hours for their training, and exclusion of some notices and searches in selection processes, which prioritize more generalist and traditional careers, typical of baccalaureate courses. However, the trainee's employability rate is very good, as the job market ends up recognizing the best qualified professionals.

Technical and Technological Axes

The courses offered by the Paula Souza Center are geographically distributed among the municipalities, seeking, in some way, to be compatible with the socioeconomic characteristics of the region where the teaching unit is installed. The technological axes adopted are:

- Environment and Health;
- Control and Industrial Processes;
- Educational and Social Development;
- Management and Business;
- Information and Communication;
- Infrastructure;
- Food Production;
- Cultural Production and Design;
- Industrial Production;
- Natural Resources;
- Safety;
- Tourism, Hospitality and Leisure.

Active Learning Methodologies

The teaching at Centro Paula Souza has sought to find ways to incorporate the use of active methodologies, both in high school and in higher education, looking for references for alignment with educational trends. New methodologies have been adopted by teachers, trained inside and outside the institution, aiming for a creative, autonomous and innovative performance in society, in face of the demands of new professions, technologies, creative economy and emergencies.

The attempt at institutional advances has been through continuing education activities, such as training meetings whose intention is to lead teachers to diversify or transform their classes into more dynamic learning environments. The focus of the transformation is the student's educational experience, who must find opportunities to learn while his personality and skills are respected, joining them in practical activities, when the student can test what he is learning, make mistakes and correct his mistakes, and record the useful



conclusions for the next stage of learning. In this way, the student exercises the role previously centered on the teacher, who was seen as the sole holder of knowledge and, therefore, the one who classified students according to their mistakes and successes.

The active methodology, regardless of the didactic procedure that uses it, takes the student from the role of a mere spectator and places him as a co-author and be competent.

Blended learning

The Higher Education Unit (CESU) of the Paula Souza Center shared on its website the subject of “challengesdaeducacao.grupoa” that explains, justifies and corroborates hybrid education in Education 4.0. In summary, we will emphasize the pillars of this learning model that is being adopted by some universities, which include: personalization of teaching, encouragement to experimentation and the combination of the classroom and the online environment. Education 4.0 is centered on the concept of “learning by doing”, which prioritizes student self-development and the construction of values, knowledge and skills based on the experience of different activities. Technology arises to flexibilize and increase learning, as proposed in Hybrid Teaching.

It is not just a matter of inserting smartphones, readers, tablets and computers in the classroom, but of making a careful and intelligent curation of content available online beforehand, so that we can employ resources that really stimulate the digital skills and intelligence of students.

Social networks, virtual rooms and applications, such as Whatsapp; Messenger; Skype; Microsoft Teams; Moodle; the Tutor; Google Classroom; YouTube; audio, video, text, photography, etc., if used with planning, can contribute not only to the learning of content, but to the appropriation of the language that gives rise to these things, avoiding digital illiteracy. To do this, however, teachers also need to be digitally literate.

TECHNOLOGICAL COLLEGES

The demands of the labor market, the productive sectors and technological prospecting combined with the prospects for social impact actions must be the basis of the curriculum of technological professional education at the Paula Souza Center, and, in sum, the ODM Declaration and the 2030 Agenda must be guiding parameters for the elaboration of new Pedagogical Proposals and Course Plans.

FATEC in São José dos Campos and the community

São José dos Campos is a city, according to IBGE data (2016), with approximately 700 thousand inhabitants, a high HDI index (0.807) and a per capita income above the national average (R \$ 40.7 thousand). In addition, the city has a low level of illiteracy and high average schooling (10.9 years of study) and a considerable proportion of masters and doctors, which facilitates the hiring of teachers with excellent training.



In terms of economy, the city had the 22nd largest GDP in the country (IBGE, 2014) distributed as follows: 0.15% in the agricultural sector, 48.31% in the industrial sector and 51.54% in services. Its industrial park has approximately 1900 industries distributed in the aeronautical, automobile, space and defense, chemical and pharmaceutical sectors, and oil and energy.

Despite these very promising indicators and the fact that it is a city in economic transformation, which was listed in 2019 as one of the best cities for business in the Americas, the future scenario for the city, as for the country, is of great uncertainties generated from the stagnation in the pace of technological evolution.

The FATEC of São José dos Campos (Images at <http://fatecsic-prd.azurewebsites.net/galeria.php>) is inserted in the region nucleated by the Technological Park. The Teaching Unit identified three major actions involving the community and its need to develop an innovation ecosystem in the city. To this end, the roles of its participants must be clear: 1 - the faculties and vocational schools are responsible for the action of initial and also ongoing training of new talents; its contribution to the ecosystem must be to deliver integrated people, stimulated, with relevant purposes, competent, qualified to always learn. In order for bonds to be created, college representatives make routine visits to companies and workspaces, schedule meetings and visits to the Faculty. 2 - It is up to these companies to bring traction to the ecosystem, providing business knowledge, investments, collaborative actions, projects, competitions, hackaton and short courses, inviting schools to improve their teaching process based on this relationship and students learn better. 3 - And, finally, to the Institutes of Technology, ICTs and research centers of the universities, it is up to the action to produce and share technologies, their uses, advances and challenges with the other elements of the ecosystem, in order to become effective partners, training better students across the local ecosystem.

All of this is only possible today in a digital, hybrid and shared environment. The Faculty must include itself in the ecosystem and accelerate the learning process of its target audience, with the use of available digital resources and previewing the need for student autonomy in learning the coming technological resources.

Educational Management at FATEC “Professor Jessen Vidal”: corporate tools

At FATEC in São José dos Campos, educational management is carried out in a collaborative way, through the agreed adhesion of its members to a continuous improvement process based on semiannual cycles of the PDCA tool (Plan-Do-Check- Act). Every six months, there are two or three Strategic Planning meetings, to which all teachers and employees are invited, but without obligation. According to the number of members, subgroups are formed, which start to work as a team to present action plans aimed at solutions to the unit's challenges.



Challenges are diagnosed using the business management tool called SWOT (Strengths, Weaknesses, Opportunities, Threats), in Portuguese, FOFA (*Forças, Oportunidades, Fraquezas, Ameaças*). The weaknesses and threats to the growth of the teaching unit, as well as the development of pedagogical practices, are the challenges for which the teams present the action plans, elaborated using the 5W2H tool (What, Why, Who, Where, When, How, How much). During the semester, the teams, including the boards and coordinators, work to put the actions into practice and achieve the objectives set.

In order to bring transparency and constant visibility to the management processes, the Sight Management model is being adopted, which consists of monitoring all the projects of the unit through a panel exposed to everyone. As the steps are carried out, your situation will be marked on the panel - whether in progress, overdue or if fulfilled. It is a model similar to Kanban, used to control the production flows of an industry.

Educational management is also carried out by department, pedagogical coordinators, academic, administrative and college directors.

Project-based learning (collaborative learning)

Understanding the importance of the active methodology for materializing the theory and transposing the abstract to the concrete, FATEC “Professor JessenVidal” adopted as a didactic-pedagogical procedure the development of projects based on real problems. These projects are divided into four types: Integrator Projects, which aim to integrate the contents of the subjects of a semester and are carried out in 04 months; Graduation Projects, done in 06 to 12 months by veteran students; Technological Development Projects with support or involvement from companies or ICTs; and Scientific Research Projects, always in partnership with ICTs or universities and with the support of research promotion agencies and companies.

The projects are carried out in a collaborative way: group of student-teachers; student-teacher-company; student-professor-university. Problem situations are defined jointly by teachers, companies, and presented to students to prepare a project whose outcome is the proposal or prototype for solving the problem presented, considering that, in the Integrating Projects (PIs), students are presented with the general characteristics of the problem, thus composing the model of a problem, so that the proposed solution is neither owned by the company nor protected by intellectual rights or patents.

Still to develop the PIs, two methodologies are used: Design Thinking, a practical-creative approach, which aims, in a collaborative way, to find innovative solutions to the identified problems; and SCRUM, an agile methodology for project management, widely used by software development teams, but not exclusively for this purpose. The great contributions of this methodology are: team meetings and scheduled deliveries, known as Sprints.



To carry out this type of learning method, teachers offer subsidies through classes in the disciplines most related to the desired project. Obstacles and doubts arise all the time, but those involved seek alternative paths, seeking knowledge also outside the classroom.

Gonzalo Abio (2010) shows, in his work on Andragogy, that the use of prior knowledge is more evident in learning among young people and adults than among children and adolescents; therefore, their experiences must be treated as relevant for these students to gain self-confidence, in order to learn to conduct their own learning process. In addition, it gives reference to the importance of collaboration.

Zmeyov (1998) adds three other characteristics to those described by Knowles: the importance of the students' life context, the role of the student himself as a guide for his learning as well as the cooperation of students with teachers in all stages of learning (p. 106). (ABIO, 2010, p.03)

It is seen, then, that learning happens from: a proactive behavior, from the relationship between theory and reality, from practical application, correction of errors and the transfer of knowledge from oneself to another object. Abio (2010) also makes the relationship between Andragogy and the student's ability to learn alone: Heutagogy:

As a refinement of Andragogy, rather than as something antagonistic, the concept of Heutagogy, developed by Stewart Hase, appears, with a focus on self-directed learning (self-directed learning), already raised by Knowles as a characteristic of learning of adults. In these times of great access to information, Heutagogy does not deal directly with the teaching-learning relationship, it takes the discussion about learning more deeply. Therefore, the issue is in individual development. How to learn to learn? The proposal is that contents and offer models are thought and prepared aiming at the ability to learn the process of acquiring knowledge (HASE; KENYON, 2000). (ABIO, 2010, p.04)

Regarding the content of the subjects, it was common, almost unanimous, the concern of teachers to use class time and the new didactic procedures to develop the project, when other content could be being studied and, consequently, there would be a delay in programming. However, gradually, some have noticed the maturity shown by students in the appropriation of knowledge related to the project.

In this context, the teacher left the exclusive role of content writer and started to act as content curator and stimulator of discussions about a specific subject. Quantity has given way to quality. Teachers testified about this experience at the last teacher meeting in 2019.



At this point, the construction metaphor fits: when the strong wind comes, not all parts of a house remain standing. Many accessories, such as tiles, clotheslines and sconces fly away, but the most solid foundation is the one most likely to remain intact. This is how learning is: not all subjects studied are remembered at the time of need, but those that have been well assimilated.

Perhaps this is one of the ways to reduce the difference between the quality levels indicated in figures 1 and 2, by ARAÚJO (2011):

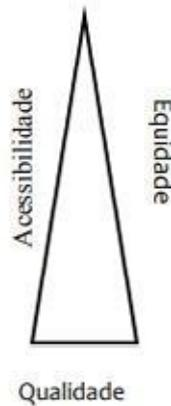


FIGURA 1 – Desequilíbrio entre qualidade, acessibilidade e equidade na educação²

The biggest challenge is to reconcile the relevance of these three dimensions, so that the universalization of education and the democratization that ensures diversity in school spaces do not compromise the quality of education desired by societies at this historical moment (Figure 2). (ARAÚJO, 2011, p. 38)



FIGURA 2 – Equilíbrio entre qualidade, acessibilidade e equidade na educação³

² and ³ SOURCE - Prepared by ARAÚJO (2011), based on debates at the World Conference on Higher Education, Paris, 2009.

FATEC “Professor Jessen Vidal” is expanding the use of the Project - and also Problem, People, Process, and Product - Based Learning methodology to more classes, as the pilot project did not cover all periods and courses. It is expected to improve learning environments, enriching them with resources useful for project development and adapting them to the advancement of technology.



Communication and learning recovery in the hybrid model

Based on the experience of using the Teams application, from Microsoft, and the Moodle platform, used by some teachers and students of FATEC “Professor Jessen Vidal” for communication and carrying out pedagogical activities, it was decided that the learning recovery program, called the Learning Recovery Acceleration Program, it will have the improvement of the Moodle platform for the participation of a larger number of students, teachers and monitors, also interacting at a distance, an action corroborated by one of the goals of the Higher Education Coordination (CESU-CPS) , to incorporate the hybrid model into the matrices of all courses.

According to a study performed with students from Hungary, by Dr. PhD György Molnár, and published in his article Teaching and Learning in modern digital Environment (2015), Moodle is the most used learning environment among Internet- based services.

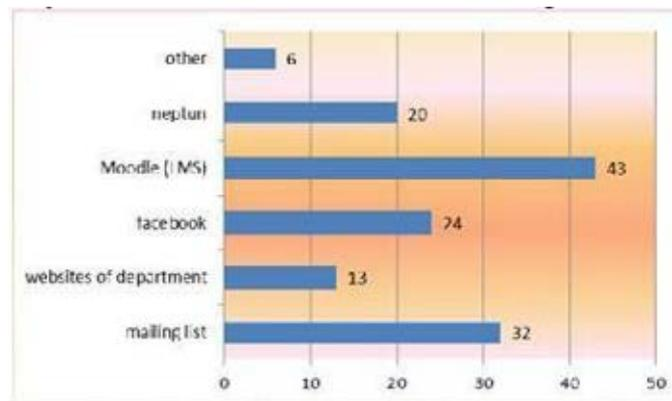


Figure 7. Usage of Internet based services, source: own figure

SOURCE: MOLNÁR (2015)

From this example, we can see that information and communication technologies are used by students from different parts of the world, and infer that this use must be beneficial for learning to occur. Both MOLNÁR (2015) and ABIO (2010) address the importance of the technological resource, in this case Moodle, being thought and elaborated to facilitate learning, allowing students with more or less skills in the digital environment to be able to study.

Learning in a virtual environment, today, is much more related to the purpose for which we use it than to a change in the physical learning space, as technology is inserted everywhere. As Eszter Monda (2016) said, in his research on the proliferation of new ICT tools and communities in higher education,

[...] it can be said that technology will be more present, increase the user experience, enable more functions and, at the same time, significantly transform the job market and



the necessary skills, in addition to creating new markets, jobs and change our social habits. [...] It is society that decides how widespread the technology will be. (Klein-Kleinman, 2002). It is also observed that the growing generation is adapting to changes and, therefore, has other needs. The use of technologies that will emerge by 2025 will depend not only on the value of the technology, but also on what, for what purpose and how we use the technology. (MONDA, 2016, p.9) (our translation)

Two needs drove the option for a hybrid model (in the sense of the combination of classroom teaching with distance learning) for parallel recovery - as continuous recovery occurs in the current semester along with classes - and are:

- Maintain contact with the recovering student as he or she is excused from the subjects / classes in which he / she obtained satisfactory performance;
- Optimize time and improve monitors-students participation in follow-up activities for students with learning disabilities. Until now, the monitors remained in the unit at a time other than class time to attend to colleagues; however, the frequency was very low because most students are not available to be in the unit for more than one period, because of work or the difficulty to move, because the college is located in a very distant peripheral zone in the central region.

It is intended, therefore, to involve the monitors in the monitoring of students in recovery, to verify the frequency in the virtual environment, deliveries, dialogue and facilitate contact between students and teachers according to their needs.

This proposal will be effective in the first half of 2020, accompanied by pedagogical and academic coordination for interventions throughout the semester, and reports should be issued with the program evaluation made by all participants: students, monitors and teachers.

The recovery program foresees that, for the effective recovery of learning, students must be treated in their individuality, as the difficulties may vary just as the school is an environment of diversity. Also for this reason, Education 4.0 aims to train different people, valuing their skills, instead of standardizing and massifying, which does not meet the demands of the contemporary market. PERRENOUD, twenty years ago, warned of the need for individualization and diversification in the process of evaluating:

An assessment is only formative if it results in one form or another of regulation of pedagogical action or learning. In the most elementary case, there will be at least a change in the pace, overall level or teaching method for the whole class. The teacher who



finds that a notion has not been understood, that his instructions are not understood, or that the working methods and attitudes he requires are missing, will take up the problem at its base, renounce certain developmental goals to rework the fundamentals, modify his/her didactic planning, etc.

A formative assessment, in the broadest sense of the term, does not work without individualized learning regulation. The change in assessment practices is then accompanied by a transformation of teaching, classroom management, and care for students in difficulty. Between moments of support

- internal or external - and true differentiated pedagogies, there are all kinds of more or less ambitious intermediary organizations. It is not necessary, in the sense of formative evaluation, to disturb the organization of work from the top down. [...]

Overloaded personnel sometimes prevent any change. The real obstacles come rather from the rigidity of school hours, the program, the rules, the values and the representations of the agents. More than the number of apprentices, it is the organization's rules that compel us to constantly offer the same thing to everyone, even when it is useless. [...] (1999, pp. 148 e 149. original emphasis)

Thus, the learning recovery program is more than the remedy for ephemeral pain, it is a path that, associated with active learning methodologies, leads teachers and students to the mediating assessment / self-assessment of learning, which is contrary to the classificatory end, which puts a unique success model on top and, at the same time, offers few opportunities for each student to demonstrate their skills.

TECHNICAL AND HIGH SCHOOL EDUCATION

To present a little of the work of ETECs - Technical Schools –, we briefly discuss only three topics: digitization; the approximation of reality and the appreciation of diversity.

Digitalization

It is with urgency that the school seeks methodologies that incorporate digital knowledge. In secondary education, we can see a constant increase in pedagogical activities that include social networks, video production, blogs, web radio, podcasts, editing programs, use of applications, e-books and even programming logic.



In addition to connectivity, the Digital Age is characterized by the great flow of information around the world, resulting in increased data availability and increased accessibility, and requires the ability to critically analyze data and information, turning it into knowledge.

Therefore, in technical schools there has been a greater commitment to understand and select the technological resources of information and communication that will contribute to training students with the skills of self-knowledge, self-reliance and self-confidence (BIRCH and PICONEZ, FEUSP).

Sustainable methodology for approaching reality

So that successful experiences in student education, such as practical activities and projects, are not lost, it is essential to adopt a methodology that allows the repetition of this type of experience, throughout the series, in the same series in a transdisciplinary way and with the new generations. At least one of the solutions for sustainable pedagogy is teacher education, also immersed in practical experiences with tools and digital content, with projects created for problem solving and with scientific background to share and support their students in their difficulties.

Involvement of as many teachers as possible can be done through interdisciplinary projects; these, in turn, ensure learning that can go beyond listening or reproduction; through the convergence of disciplines, the theory makes more sense to the student, because he himself makes relationships between the sciences (human, nature, exact and languages) during the realization of the project. To illustrate, we can think of a problem situation that motivates a project, such as the excess of garbage in the streets of downtown São Paulo. Certainly, to solve this problem, a group of students can use knowledge of chemistry to treat waste; Mathematics to calculate volumes, frequency of collection, selling price of recyclables, flows and others; Communication to educate people about disposal, publicizing campaigns and contests, writing standards or using social networks; Geography to understand and contribute to human development; Biology to take care of people who work with waste; and many other more specific and technical knowledge, such as Logistics, Administration, Medicine, Psychology and Anthropology.

When talking about a project carried out at school, one soon thinks of teamwork, as each one can contribute with their skills, the ease they have in a certain area of knowledge, and increase collective intelligence, because in a group whose members contribute with their knowledge, individual knowledge can become greater than if each projected alone. And it is a fact that, as a benefit to the project being implemented, the sum of the knowledge of a group of people will be much higher than the knowledge of an individual, considering everyone in the same learning phase.



In short, project and problem-based learning is an active methodology that has been strongly encouraged at the Paula Souza Center for over half a decade in the language we have still heard today and for over two decades thinking about solving real problems of the labor market, but not with the interdisciplinary view practiced by many high school and technical teachers today, and growing among technological higher education teachers.

Appreciation of diversity and democratic school environment

The appreciation of diversity is an item that causes concern when it comes to diversity of thoughts and a space that guarantees freedom to express themselves, which contributes a lot to the formation of young people and adolescents especially, but also of adults, who carries so many concerns and also finds in the school environment a place to share its experiences and discover new ways. Hence the importance of making the school a democratic environment, in which everyone can participate and that everyone can build, valuing the diversity and expression of thoughts and emotions, often not expressed elsewhere, causing anxieties and frustrations.

Many ETECs have the support of a professional in Sociology or Psychology, who works as an Educational Advisor, helping teachers to assist students who suffer from some kind of disorder. With the increase in cases of depression and suicide among young Brazilians, with occurrences among the students of the Paula Souza Center, the institution created a program in the area of Psychiatry that, as well as the Advisory Support for People with Disabilities, seeks to guide the CPS's professionals to increase their knowledge of the subject and be better prepared to accommodate people with disorders.

It is believed that, with greater opportunities for participation, students express themselves more and become more transparent in these aspects, allowing greater exchange of knowledge on the subject, possibilities for resolution and referral, and minimization of isolation. This is also a school role that, unnoticed, cooperates when it creates interaction activities.

TWO ESSENTIAL CONSIDERATIONS: EDUCATING MORE PEOPLE AND SOLVING MORE PROBLEMS

Digitization and hybrid education transforming the school

Hybrid education translates the combination with digital education 4.0 and can be seen not as a distance learning or semi-classroom mode, but as a dynamic education that allows the use of mixed technologies, including digital, in the performance of school activities in any environment.

This change has been taking place from the outside into the school and this is how it should happen, because the academic environment is where the world's changes find a place for study, analysis, systematization, improvement and multiplication.



Transforming the school should not be an extraordinary event as a striking fact within a century; rather, the school must be the first to experience what is new, using its established critical, analytical, and theoretical foundation to generate new knowledge rather than stagnate, and attracting youths, especially those who failed to find meaning in school for their life project.

Problem-solving education and the millennium goals

The Information and Communication Age has enabled new ways to solve problems. Just as in mathematics or physics we learn to deal with quantities without materializing them, we can use other abstract knowledge to create solutions. The mistake would be to mobilize new tools, technological resources and millions of people, but to lose sight of society's real needs for health, comfort, income, food production and distribution, safety, family structure, child education, care for the elderly, leisure, transportation, environmental preservation, new ecosystems.

With Quality Education and effective learning as one of the goals of the millennium, we need to collect evidence, test and share as many experiences as possible that can contribute to improving learning and, consequently, improving well-being and development social, when we are talking about the current and future generation, prone to develop other intelligences.

REFERENCES

ABIO, Gonzalo. (2010). Andragogia e inclusão digital: algumas reflexões. Comunicação a Distância e Práticas Educativas Comunicacionais e Interculturais. *Revista EDaPECI*, Edição nº 6, pp. 19.

ARAÚJO, Ulisses F. (2011). A quarta revolução educacional: a mudança de tempos, espaços e relações na escola a partir do uso de tecnologias e da inclusão social. Campinas: ETD: educação temática digital, Vol. 12. Número especial.

BIRCH, Daniel e PICONEZ, Stela C. B. Competências para um aluno bem sucedido no ambiente de e-Learning. Faculdade de Educação da Universidade de São Paulo – FEUSP.

CENTRO PAULA SOUZA. Base tecnológica do Curso de atualização docente em fundamentos e legislação da educação profissional e tecnológica: conhecimento, currículo e cultura escolar. Governo do Estado de São Paulo. Editoras Teste digital e Evolución metodología b-learning.

CRUZ, Paulo Emílio de O. e. Metodologias Ativas para a Educação Corporativa. Ebook: Prospecta.

DUSSEL, Inês. (2003). *A invenção da sala de aula: uma genealogia das formas de ensinar.*/Inês Dussel, Marcelo Caruso. (tradutora: Cristina Antunes). – São Paulo: Moderna. – (Educação em pauta)



MOLNÁR, György. (2015). Teaching and Learning in modern digital Environment. International Symposium on Applied Machine Intelligence and Informatics. Eslováquia.

MONDA, Eszter. (2016). Az új infokommunikációs eszközök és közösségek várható elterjedése a felsőszintű oktatásban. (Proliferação esperada de novas ferramentas e comunidades de TIC no ensino superior). *Opus et Educatio*, Vol. 3, Nº 4.

O futuro do ensino superior: a Era da Educação 4.0. (16/12/2019). Disponível em <https://cesu.cps.sp.gov.br/>. Acesso em 02/01/2020.

Perfil dos cursos Etec e Fatec. (2017). *Mercado de trabalho, Onde estudar*. Disponível em <http://www.portal.cps.sp.gov.br/publicacoes/perfis-de-cursos-etecs-fatecs/2017/2017-perfil-cursos-cps.pdf>. Acesso em 15/12/2019.

PERRENOUD, Philippe. (1999). *Avaliação: da excelência à regulação das aprendizagens – entre duas lógicas* / Trad. Patrícia Chittni Ramos. – Porto Alegre: Artes Médicas Sul.

SOUZA, Claudio. (24/07/2019). São José é a 4ª melhor cidade das Américas para negócios.. Disponível em: <https://www.sjc.sp.gov.br/noticias/2019/julho/01/sao-jose-e-a-4%C2%AA-melhor-cidade-das-americas-para-negocios/>. Acesso em 02/01/2020.

Transformando Nosso Mundo: A Agenda 2030 para o Desenvolvimento Sustentável. Disponível em: <https://nacoesunidas.org/pos2015/agenda2030/>. Acesso em 15/12/2019.

AUTHOR INFORMATION

Elisiane Oliveira, elisianeoliveira@usp.br, Brazil, Centro Paula Souza (corresponding author)

Fabiano Walczak, fsabha@gmail.com, Brazil, Centro Paula Souza (corresponding author)

Luiz Antonio Tozi, luiz.tozi@cps.sp.gov.br, Brazil, Centro Paula Souza (corresponding author)



**PBL, active learning, sustainability
and participation**



WHEN FUTURE WORKSHOPS LEAD TO INNOVATIVE AND ENTREPRENEURIAL SKILLS WITHIN PBL LEARNING COMMUNITIES

Birthe Lund

ABSTRACT

This paper identifies how problem-based Learning (PBL) can foster the development of an “entrepreneurial mindset” and “value creation” when students collaborate and invent as part of their master’s program at the University of Aalborg. Research suggests a need for informal assessments of content and performance, as knowledge, skills and attitudes are integrated and used to perform in the real world (Bacigalupo, M, 2016) (UNESCO 2020) UNESCO (2006) (United Nations. 2015).

Entrepreneurial learning seeks to foster self-esteem and confidence, and it is based on students’ talents, creativity and action competences. Hence it is both complicated to develop, identify and to measure entrepreneurial competences. (Lund,B. 2019) Vestergaard, J. (red.) 2019).

Methodologically, the explorative in-dept study of a PPL group is based on a qualitative study, founded on data from evaluation of student projects, their work processes, value creating products, students’ self-evaluations as well as interviews with student groups in order to measure and evaluate the development of entrepreneurial skills in a traditional PBL context within the humanities.

The research identifies the processes through which entrepreneurial learning is produced by introducing the evaluation model: EntreComp wheel (McCallum et al. 2018).

The research further documents students’ competence development and identifies how using the method (Future Workshops) influences both students’ attitudes, problem-solving, collaboration skills and self-reflecting during a transformative learning process in which students manage to seize opportunities and create new value in collaboration with stakeholders and partners outside of academia.

KEYWORDS: entrepreneurial skills, E-PPL, Future workshop, Competence evaluation, Action competence

TYPE OF CONTRIBUTION: Extended scientific abstract

PRESENTATION FORMAT: Roundtable discussion



EXTENDED ABSTRACT

The 21st century demands that all individuals develop the capacity to be creative and innovative at work and in their communities (Entrepreneurial learning for TVET institutions. A practical guide)(UNESCO (2020)

This paper identifies how problem-based Learning (PBL) can foster the development of an “entrepreneurial mindset” and “value creation” when students collaborate and invent as part of their master’s program at the University of Aalborg. Research suggests a need for informal assessments of content and performance, as knowledge, skills and attitudes are integrated and used to perform in the real world (Bacigalupo, M, 2016) (UNESCO 2020) UNESCO (2006) (United Nations. 2015).

It is the intention with entrepreneurial learning “to foster self-esteem and confidence, and [entrepreneurial learning] is based on students’ talents, creativity and action competences. Hence it is both complicated to develop, identify and to measure entrepreneurial competences”. (Lund,B. 2019) Vestergaard, J. (red.) 2019). Sarasvathy, S.D. (2001).

Methodologically, the explorative in-dept study of a PPL group is based on a qualitative study, founded on data from evaluation of student projects, their work processes, value creating products, students’ self-evaluations as well as interviews with student groups in order to measure and evaluate the development of entrepreneurial skills in a traditional PBL context within the humanities.

The assumption is that innovative learning processes are associated with group and problem- oriented project work. The originality and value of the solutions are seen as an expression of the students' innovation competences. Ideally the students should create *new* knowledge and *new* solutions, which may be valuable to the field as a whole. As a result of this, PPL has a very strong entrepreneurial foundation and association at Aalborg University. From a PBL perspective, problem definition, problem solving and collaboration are highly valued learning-promoting initiatives, the latter of which refers not only to collaboration with fellow students, but also supervisors and the surrounding community. However, conscious pedagogical and methodological measures are required to support these dimensions.

There is no unambiguous common understanding of what it means to be entrepreneurial, but is often by definition closely linked with value creation and action:

“Entrepreneurship is when you act on opportunities and ideas and transform them into value for others. The value created can be financial, cultural or social” (This definition was developed by the Foundation for Entrepreneurship and Young Enterprise in 2012) (my translation).



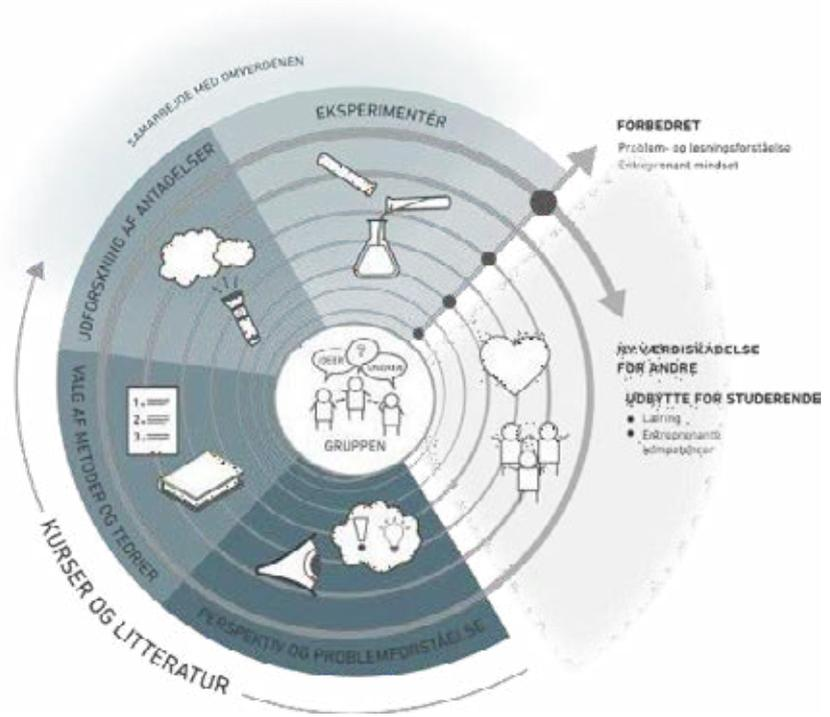
Entrepreneurship competencies are here a collective term linked to: action, resources, getting ideas and exploiting opportunities. Entrepreneurship PBL is “a form of study in which students - through iterative learning processes - develop an entrepreneurial mindset to tackle problem-oriented project work. Curiosity and wonder are driving forces on these projects and existing theoretical, methodological and empirical knowledge is translated into new value creation through targeted action on an ethical basis and through interaction with relevant stakeholders.” (Vestergaard, J. et al 2019)

My research questions are: How may this be expressed in practice in order to illustrate and discuss what is required of the pedagogy and the participants in the process? And how may these requirements be fulfilled so that the learning community at large gain to access to the benefits of this approach?

This will be answered by an analysis of a concrete project group's experience and journey, which included the development/adaptation of a tool (Future Workshop) (Jungk, Rt & Norbert R. M (1984) which demonstratively lead to value-creating collaboration with the outside world during the COVID-19 pandemic during which all communication had to be digital.

VALUE CREATING COLLABORATION WITH THE REAL-WORLD INTEREST GROUPS

Ideally, students should develop an entrepreneurial mindset during the course of their studies and become innovative, enterprising and value-creating developers in their own right, and they should face challenges undaunted and preferably always with an eye for solutions. This process and the entrepreneurial mindset, however, is closely linked with a willingness to take risk at multiple stages of the proces. How this process may look in practice has been illustrated below, using PPL’s wheel of learning:





The development of action competences is intricately connected to the relationship between the ability to act and the willingness to do so, since the emotional dimension - the will to be innovative - is awarded crucial significance in the development of readiness to act in combination with imaginings of the resulting outcome (Lund 2017). This creates the challenging pedagogical paradox that one only gains action experience, when one is *willing* to act, which means that - in order for the pedagogy to help develop the action competences of participants - participants must be able to see themselves in the pedagogical processes or they will not make sense to them.

CASE STUDY

The concrete evaluation is based on interviews with a group of students and it contains an analysis of their reports, their project and their independent descriptions of the product and work process.

FINDINGS

Students, who have developed an entrepreneurial mindset during the course of their education, are presumed to be more innovative, effective, enterprising and value-creating and empirical evidence supports this claim: the students have developed the courage to face challenges and come up with solutions in a way, which characterises an entrepreneurial mindset; they demonstrated the ability to plan a project, to tackle contradictory relationships and interests, to collaborate and to adjust according to their experiences along the way. They also found new opportunities and developed their creativity and their visions. They demonstrated the ability to mobilise not only people, but also resources and networks and remained motivated and persevering throughout the process, which suggests that this type of project contributes to the development of ownership as well as self-awareness and self-esteem. The students were able to use their imagination to identify opportunities, to explore the social and cultural landscape and pinpoint needs and challenges and thus managed to combine cross-disciplinary elements in order to create value through new forms of collaboration.

Based on this, it is reasonable to conclude that the students developed valuable entrepreneurial skills as a result of this project and the associated collaborations - through the meeting of practice and theory - and on that basis the project meets the evaluation criteria used in the EntreComp wheel (McCallum et al. 2018)



This does not mean that a general conclusion can be reached on so little foundation as a single case study, but it is possible to state that in this particular case the students developed complex entrepreneurial competences as was intended and that this points to a possible usefulness in using the EntreComp wheel (McCallum et al. 2018) as a practical pedagogical tool for the evaluation of project groups as it considers the interplay between students' project, work processes, inventions and personal as well as inter-personal reflections, which may result in transformative learning processes.



REFERENCES:

Bacigalupo, M., Kampylis, P., Punie, Y., Van den Brande, G. (2016). *EntreComp: The Entrepreneurship Competence Framework*. Luxembourg: Publication Office of the European Union; EUR 27939 EN; doi:10.2791/593884

Jungk, R. & Norbert R. M. (1984): *Håndbog i Fremtidsværksteder*, Politisk Revy.

Lund, B. (2017). Managing student's emotion in order to foster innovation: View on entrepreneurship education in school. I T. Chemi, S. Grams Davy & B. Lund (Red.), *Innovative pedagogy: recognition of emotions and creativity in education* (1. udg., s. 91–105). Rotterdam: Sense Publisher



Lund, B. (2019) Innovation og entreprenørskab i et pædagogisk perspektiv Duch, H. (red.). *På diplom. At lære som voksen*. 1 udg. Gyldendal

Politis, D. (2005) The Process of Entrepreneurial Learning: A Conceptual Framework .

Entrepreneurship Theory and Practice, vol. 29, 4: pp. 399-424. , First Published Jul 1, 2005.

Sarasvathy, S.D. (2001). Causation and effectuation: Toward a theoretical shift from economic inevitability to entrepreneurial contingency. *Academy of Management Review*, 26(2), 243–263.

UNESCO (2020) *Entrepreneurial learning for TVET institutions. A practical guide*

UNESCO. 2006. *Towards an Entrepreneurial Culture for the twenty-first century: Stimulating Entrepreneurial Spirit through Entrepreneurship Education in Secondary Schools*. Paris, UNESCO.

United Nations. 2015. Transforming Our World. The 2030 Agenda for Sustainable Development. <https://sustainabledevelopment.un.org/post2015/transformingourworld> (Accessed on 20 June 2020.)

Vestergaard, J. (red.), Andreasen, M. B. (red.), Strand, A. M. C., Thorsted, A. C., Østergaard, A., Bak-Jensen, B., Lund, B., Gertsen, F., Aaen, I., Christensen, J. L. & Vistisen, P., (2019). *PBL og Entrepenørskab: Sammenkobling og udvikling af begreber og praksis, der fremmer entreprenante kompetencer på tværs af AAU*.

AUTHOR INFORMATION:

Birthe Lund, bl@hum.aau.dk, Denmark, Institut for kultur og læring, AAU (corresponding author)



EXPERIENCES FROM IMPLEMENTATION OF A FLIPPED AND INTEGRATED SEMESTER STRUCTURE AND SUPPORTING BASELINE STUDIES

Anders Melbye Boelt, Nanna Svarre Kristensen & Nicolaj Riise Clausen

ABSTRACT

This extended abstract takes its point of departure in research conducted within the scope of the PBL-future project, a research endeavor at Aalborg University (AAU). The project seeks to examine different aspects of PBL, making sure that it, as a pedagogical model practiced at AAU, is ready and adaptable for new and changing needs for competences as well as new educational technologies. In this abstract we will present results from a subproject within PBL-future focused on implementing a flipped learning approach on a cohort of fourth semester mediaology students, seeking to further the integration between course curriculum and projects. The semester structure is meant to facilitate the integration of some of the content from 15 ECTS worth of courses into a project making up the remaining 15 ECTS. This subproject addresses a problem of apparent lack of synergy between what the students learned in the courses and what they applied in the projects, through the application of a flipped learning approach.

The preliminary findings of this ongoing endeavor will be discussed alongside insights gained from the PBL-future baseline subproject, which is meant to act as a supporting and contextualizing element to the other subprojects. The baseline project looks at curriculum structures, learning objectives in documents central to the semester and also include results from a survey study made on all students and teaching staff at AAU. The ambition of the authors is that the insights from either project can, through a discussion of the results, enrich and contextualize each other.

KEYWORDS: Flipped learning approaches, semester planning, PBL, curriculum analysis, student survey, staff survey, PBL future, AAU

TYPE OF CONTRIBUTION: Extended scientific abstract

PRESENTATION FORMAT: Roundtable discussion

FULL ABSTRACT

In an ever-complex world, where it is 'open hunting season on education,' there is an imperative to keep pedagogical models relevant with emerging requirements from a variety of actors, international organizations, and new applications of technologies with the potential to support and integrate pedagogy



and learning activities. The research project PBL Future at Aalborg University (AAU) is such an effort, addressing a diverse range of topics researching how the pedagogical model implemented nearly half a century ago can remain relevant for students, staff, and stakeholders now as well as in the future. PBL Future reaches across faculties, involving multiple researchers and educational programs in four distinct subprojects. A baseline study comprised of surveys on all students and teaching staff at AAU, and a broad curriculum analysis supports the subprojects. The subprojects revolve around themes such as postdigital collaboration, student-centered problem construction, self-directed learning, and flipped learning, all set in an educational context of systemic PBL at AAU. The authors are part of the baseline study and subproject 4, addressing flipped learning approaches. For the remainder of this abstract, we will move from the general to the particular, from the baseline study and curriculum analysis to a concrete change of an existing curriculum on a single semester.

Since AAU's inauguration, problem-based and project-organized learning have been the learning approach and identity of the university. Iterations and revisions aside, social learning using authentic and exemplary problems as the point of departure for learning is still very much at the core. A semester at AAU is typically structured around a 15 ECTS project that take up a continuously larger part of the students time as the semester progresses and they finish the courses that make up the remaining 15 ECTS of the semester.

A curriculum analysis for all educational programs included as cases in subprojects was conducted. The overall aim was to investigate whether or not generic competencies are present in the form of learning outcomes. The rationale behind the analysis is then partly aligned with the notion of learning outcomes as a means to draw students' attention to expected outcomes of their education. Further, it is bolstered by global movements highlighting the necessity of generic, key, or 21st century competencies for future employability. Some frameworks describing the ephemeral future competencies emphasize inquiry-based learning approaches such as PBL as viable pedagogical models, supporting generic competence development. However, research shows that students struggle to vocalize the derived positive effects and generic competence development of PBL at the end of their education. These movements and problems have not gone unnoticed, and as part of an institutional strategy, generic competencies are currently being integrated into existing curricula across all educational programs. To demarcate generic competencies obtained by students in a PBL environment from those obtained by other pedagogical models, AAU has dubbed these 'progressive PBL competencies.' The PBL Academy at AAU has established four general categories of competencies based on the core learning principles of AAU: problem-oriented, interpersonal, structural, and meta-cognitive. These reflect the specific dimensions of the project work, mainly how students relate to the particular problem, to each other and other relevant actors, project management, and strategies for



individual and collective learning, to name a few. The progressive aspect indicates a temporal perspective in the development and presence throughout an educational program. Further, PBL competencies are constituted by intertwined experiential and theoretical elements, each supporting and enriching the other.

The curriculum analysis was conducted by applying a theoretically informed content analysis. The analysis was directed by the four progressive PBL competencies, which constituted the coding tree. To enable comparison of the integration on each semester, the same coding tree was applied on each semester; n. semester, type of competence, and descriptors of either knowledge, skills, or competence. Results from the curriculum analysis show that the majority of generic learning outcomes is within the first year of study, only sporadically appearing afterwards. Between the educational programs, there is variation in the presence of said outcomes. This points to a lack of vertical integration in existing formal curricula, an issue that includes outcomes addressing both the practical and theoretical dimensions of the progressive PBL competencies.

One of the subprojects of PBL Future focused on the potential of flipping the teaching, facilitating a better connection between semester courses and student projects. To mitigate a perceived disconnect between courses and projects in the curriculum structure of the 4th semester of Medialogy in Copenhagen, an initiative of a new flipped and integrated semester structure was planned and executed in the spring of 2019. The semester theme was "Sound Computing and Sensor Technology," and the core content consisted of subjects such as math and programming that the students thus far had found challenging and demotivating, a fact underpinned by the students' final grading (Kristensen, 2019). The semester project on the other hand had the students highly motivated and they likewise did well on their project exams (Busk 2019). One of the challenging aspects was that a rule of structuring the semester was that the courses and projects were evaluated separately, something that might lead the students to misunderstand the requirement for them to integrate elements from the courses into their projects. Results from student surveys with previous students from the 4th semester Medialogy, showed that students did not recognize the connection between the courses and the semester project. A fact that diametrically opposes the overall aims of the AAU PBL model: that course content is supposed to support the project work. By applying and consolidating disciplinary knowledge from courses to also qualify the semester projects, the two different curriculum elements should support each other.

The flipped learning approach was chosen because it builds on the same pedagogical ideas as PBL where social and active learning is the pedagogical foundation (Jensen et al 2015). By removing traditional and transmissive lectures and replacing it with more social and active in-class workshops/activities, the approach was intended to create a potential for more flexibility in how to handle the curriculum and making time for



integration activities. Another objective of flipping the semester was to create more time for interactive learning, and ultimately of course to connect core content of courses with the project work.

Integration initiatives build on different co-operating strategies aimed at increasing and facilitating communication in the teacher group, developing joint teaching activities, framing student activities within course and project integrated themes and joining forces in a uniformed supervisor effort. Within the curriculum framework interdisciplinarity is not mentioned. Courses are meant to progressively build upon the learning goals of earlier courses, but references between the different semester elements are weakly defined by the semester theme. In the execution of the new semester structure, cooperation and interdisciplinarity tasks beyond the official curriculum demands was to be initiated.

Experiences from the first cohort of student to come through the new flipped and integrated semester structure, show a number of implementation difficulties. The digital homework consisting of different video- and podcast- material showed a lack of uniformity characterized the first iteration. Some students found it difficult to get used to the new way of studying and came unprepared for the lectures while other students adapted quickly.

Teachers struggled with planning the activities while also taking into consideration the increased need for scaffolding. Teachers found that a group of students reached further in their understanding of the disciplinary performance while another group felt lost quite early in the semester. When looking at the final grades compared to the 4th semester 2018 less students failed the courses but more students came to fail the project. The reason for this development and possible ways of mitigating negative effect on the project is still being investigated and will be one of the foci of the round table. Another central point of discussion the authors hope to bring forth, is that of the frames of curriculum, for example the alignment between assessment and learning activities.

AUTHOR INFORMATION:

Anders Melbye Boelt, boelt@plan.aau.dk, Denmark, Aalborg University (corresponding author)

Nanna Svarre Kristensen, nsk@create.aau.dk, Denmark, Aalborg University (corresponding author)

Nicolaj Riise Clausen, nclausen@plan.aau.dk, Denmark, Aalborg University (corresponding author)



LENSES ON THE POST-OIL ECONOMY: INTEGRATING ENTREPRENEURSHIP INTO SUSTAINABILITY EDUCATION THROUGH PROBLEM-BASED LEARNING

Roberto Rivas Hermann, Marilia Bossle & Marcelo Amaral

ABSTRACT

In the context of enormous global challenges such as climate change, poverty, and the unequal distribution of wealth, sustainability education within higher education has gained momentum as a tool to train a new generation of change agents. In practice, previous research has examined the relationship between sustainability education and entrepreneurship education. Both educational domains share similar teaching and learning frameworks as they both seek to train action-oriented professionals. Yet despite these similarities, there is a knowledge gap regarding course development strategies that can integrate entrepreneurship competencies into sustainability education. Following a classroom action research (AR) approach, we developed a three-week graduate course aimed at an interdisciplinary cohort of students in the social sciences from partner universities in Brazil and Norway. The course integrated a problem-based learning (PBL) framework. As part of the methodology, teachers introduced real-world challenges in the context of a post-extractive economic transition. Working in groups of four to five members, the students provided business solutions framed in a post-oil development context. The results indicate tension points in the integration of the learning principles of PBL along the different phases of PBL, namely during the group formation and problem analysis phases. To tackle these tensions, we propose that this type of course should facilitate early group formation and integrate formative feedback and progressive problem analysis. Our framework contributes to the debate on competence-based frameworks within the sustainability education literature. The framework can also serve as an inspiration for course designers in higher education.

KEYWORDS: sustainability education, entrepreneurship education, problem-based learning, participatory action research, higher education, interdisciplinarity

TYPE OF CONTRIBUTION: Full scientific paper

PRESENTATION FORMAT: Roundtable discussion

INTRODUCTION

The United Nations Environment Program (UNEP) Stockholm Conference in 1972 named universities as key actors in the promotion of sustainable development (Wals 2014). Multiple experiences show that the



challenges linked to sustainable development are inherently complex because they require multi-stakeholder solutions and interdisciplinarity, necessitating the adoption of sustainable development principles in day-to-day activities and across study programs (Lozano et al. 2013). In recent years, the literature has focused on the links between sustainability education and entrepreneurship education (Mindt and Rieckmann 2017), with the argument being that entrepreneurship should be another basic competence in sustainability education along with systems understanding, interdisciplinarity and foresight (Hermann and Bossle n.d.). Entrepreneurship education is relevant in the context of sustainability because its goal is to train students to identify and exploit opportunities that can give rise to new businesses, products or commercial services while also tackling sustainability challenges (Lourenço and Jayawarna 2011). The focus of entrepreneurship education is the development of key competences such as opportunity identification; social, business, and industry-specific competences; and entrepreneurial self-efficacy (Lans, Blok, and Wesselink 2014).

Sustainability challenges are ‘wicked’ problems, which call for ‘off-the-shelf’ solutions. In this regard, problem-based learning (PBL), an active-learning approach, is a good fit with sustainability education because it facilitates a process of problematization, investigation and critical reflection. Throughout this process, students can work towards feasible solutions to the wicked problems under consideration (MacVaugh and Norton 2012). PBL is relevant for entrepreneurship education programs as it creates a learning environment that allows students to tackle real entrepreneurship problems; mirrors learning in the workplace; engages students’ previous knowledge and complements it with emerging interests; and sets a learning arena where collaboration and sharing enhance responsibility (Wee 2004). Extant research identifies some commonalities in programs leading to sustainability and entrepreneurship learning objectives. These commonalities include active-learning and real-world oriented learning approaches, both of which characterize PBL. From a pedagogical point of view, then, PBL has the potential to develop students’ competences to grasp the complexity of sustainability challenges while enhancing creativity grounded in local needs (Mindt and Rieckmann 2017). Despite this potential, studies lack detail on how to develop a higher education curriculum that applies active learning approaches in a real- world oriented setting. This paper responds to calls for a better understanding of curriculum design that incorporates sustainability and entrepreneurship competence development in multiple disciplines in a higher education setting (Wyness, Jones, and Klapper 2015; Mindt and Rieckmann 2017) and thus tackles the research question: *How is active learning best integrated into a higher education curriculum with entrepreneurship and sustainability learning objectives?*

To answer this question, this article proposes the integration of PBL (Hung 2011). We first conceptualize entrepreneurship and sustainability education, then analyze the key pedagogical characteristics of PBL within this sphere. We then present the results of our work, in which we relied on action research (AR) as the inquiry



strategy along the PBL framework in order to design and teach a five-credit course at the masters level in Norway and Brazil. Considering that PBL is not integrated into the partner institutions' routines, AR fits well with the purpose of inspiring institutional reflection at an organizational level (Elo 2016). Classroom action research (Kemmis and McTaggart 2005), in particular, fits well with these objectives as it allows students and teachers to critically analyze their practices for the purpose of improvement.

This research contributes to the emerging literature of sustainability education, which inquires about the integration of sustainability with entrepreneurship by arguing that PBL is an approach where students can disentangle their learning. In practice, teachers in higher education can draw inspiration from the PBL method presented here to create heuristic tools to organize their own courses.

The paper is organized as follows: in the next section, the literature review examines previous research on the use of PBL in entrepreneurship and sustainability education, while the third section presents the materials and methods. The fourth section summarizes the findings, and it is followed by the discussion, conclusion and suggestions for further research.

LITERATURE REVIEW

Problem-based learning as a pedagogical approach

Universities across the world are increasingly adopting PBL in different disciplines. PBL originated in the 1960s in the medical school at McMaster University (Canada). It was influenced by existing pedagogical currents, particularly by Dewey's ideas about intrinsic interest, Bruner's "learning by discovery" and the case-based learning of Harvard Business School (Schmidt 2012).

Initially, PBL integrated a rather rigid methodology that had students work in small groups to examine a problem-scenario and engage in their own learning to identify knowledge gaps (Savin-Baden and Major 2004). This methodology highlights one central component of PBL, which is the relationship between learning and the 'problem'. Some authors widely define a problem as a collection of phenomena and events (Schmidt 2012). A problem is also defined as an unsettled issue that is not necessarily negative but that needs to be resolved (Maudsley 1999), and in that sense it can be considered in relation to students' own knowledge production. Here, the focus is on how the student applies a logical analytical process in order to disentangle the setting of the core problem. What makes PBL special in terms of student learning, in addition to differentiating PBL from other approaches, is the so-called "theory before application" discussion, or the question of whether pre-existing knowledge is required for a student to meaningfully engage with the approach. PBL does not require a sound theoretical base before application (Maudsley 1999).



The adoption of PBL by different higher education programs goes along with the inclusion of some of the key principles of learning as a constructive process, learning as a self-directed process, and learning as a contextual process (Moust, Berkel, and Schmidt 2005). First, problems are introduced as a stimulus for learning and so learning is constructive, implemented through forms of elaboration including discussion, note taking and answering questions. Second, problems stimulate the students' prior knowledge and help them to engage in the sense-making process with their peers. This requires students to take ownership of the knowledge building process. In order to solve a given problem, students need to plan, monitor, and evaluate their own learning, and learning is therefore self-directed. Lastly, a PBL setting provides context by integrating previous knowledge as a benchmark against which to measure learning goals and by building a social framework in which students collaborate and come to share common goals or responsibilities. PBL settings also provide a context for learning, since one goal of PBL is for students to identify situations in which their new knowledge can be used (Dolmans et al. 2005).

Programs that share these design characteristics tend to have a strong focus on the learner's experience, students who take responsibility for their own learning, a close relationship between theory and practice, interdisciplinarity, a strong focus on the learning process, instructors who act as facilitators rather than experts, and students who are capable of self-assessment (Savin-Baden and Major 2004; Dochy et al. 2003).

Problem-based learning in sustainability education and entrepreneurship education

PBL is increasingly integrated in the teaching of sustainability and entrepreneurship. An argument for this integration is that education in both fields is increasingly training students to be agents of change, to be able to work in teams, and to produce relevant knowledge in context.

The definition of sustainability education is often scoped within the context of the education program, and its goal is framed as the integration of sustainable development principles holistically across educational programs (Leal Filho et al. 2017). PBL and sustainability education promote principles of interdisciplinary and collaborative learning, and both promote a meaningful experience through providing ample context (Guerra 2017). PBL has also been discussed in the literature of entrepreneurship education, and in this way it shifts the conceptualization of entrepreneurship. On one hand, entrepreneurship is commonly understood as the process of starting an organization from scratch (Wee 2004). On the other hand, entrepreneurship is also understood as a professional attitude towards professional or daily life challenges, its main characteristic being how a person transforms ideas into action. Innovation and creativity play a large role in this process (Santateresa 2016). In relation to this perspective on entrepreneurship, researchers have argued that entrepreneurship education should train students with competences to recognize opportunities that others have overlooked (San Tan and Ng 2006). In this light, entrepreneurship education is increasingly relevant to



fulfilling a set of objectives such as developing skills to adapt to change and learn in an ever-changing context. This is achieved through a pedagogy where the learning is partly carried out in collaboration with stakeholders beyond the classroom and through learning by doing, which manifests in internships and new ventures developed during entrepreneurship courses (San Tan and Ng 2006). In entrepreneurship programs, including those that use PBL as a learning approach, problems are structured with the aim of giving students greater freedom to self-direct their knowledge development process. Similarly, problems are authentic, which intensifies learners' inspiration to search for knowledge gaps. Students are thus in close contact with businesses and their problems (Rossano et al. 2016).

How PBL-inspired courses are best conducted for sustainability and entrepreneurship education

Despite already being integrated in a variety of educational programs in different countries, the principles of PBL still inspire the learning process, and we can summarize four general stages of student learning in sustainability and entrepreneurship courses: problem design and presentation, group formation and planning, problem solving, and assessment.

During the first stage, problem design and presentation, those responsible for the course often take the time to prepare or set the learning conditions for the relevant problems. Problems are grounded in real-world issues and are to a large degree unstructured. Course organizers need close collaboration with local stakeholders to identify problems with the right characteristics. In such cases, the lecturers are the initial contacts with stakeholders as a result of other ongoing collaborations (Rossano et al. 2016). Problems or challenges can also be inspired by news sites, newspapers, or magazines (San Tan and Ng 2006). In other courses, problem preparation runs in parallel with student training on the pedagogical tenets of PBL, including project management skills (Kolmos et al. 2008). During this initial phase, the facilitator introduces the students to the real-life problem. This allows them to activate previous knowledge but also inspires them to identify knowledge gaps and pursue new objectives (Wee 2004).

During the second stage, groups are organized and a plan is made in terms of the required hours for group activities. Program requirements depend on the institution. In some programs, right after the problem is introduced, the instructor and students hold a first session focusing on problem analysis. The idea is to identify issues about which the students would like to become more knowledgeable (San Tan and Ng 2006). Later planning involves a 35-minute brainstorming meeting where students form teams and complete a PBL worksheet to create a work plan, which they can then discuss with the tutor (Wee 2004). Various institutions suggest different group sizes. In the environmental studies programs at Arizona State University the size of the group varies, from one group/ one project including 2-6 students to larger groups (Brundiars and Wiek



2013). In the engineering program at Aalborg University, PBL is combined with courses at a 50/50 rate, and groups comprise up to eight members (Holgaard et al. 2016).

The third phase is problem-solving. Institutions provide different resources to facilitate group work in such a way that students apply peer learning, teamwork and self-direction in their learning process (Wiek et al. 2014). At Aalborg, each group is provided with resources including group rooms and a supervisor who will tutor them throughout the project (Guerra 2017). Increasingly, IT solutions such as videoconferencing or virtual boards are used as resources in PBL environments. Blended learning is therefore integrated into this type of learning (Santateresa 2016), and virtual learning environments and remote supervision are increasingly part of PBL integration in entrepreneurship courses (Clarke and Underwood 2011). In sustainability programs, much of a group's time is spent analyzing the problem. Hence, students brainstorm possible solution scenarios based on their existing knowledge (Holgaard et al. 2016). By the end of this phase, groups present preliminary findings, clarify gaps in knowledge, and identify potential solutions for the problem (San Tan and Ng 2006).

The final phase is the assessment of the group work. Among researchers and educators who use PBL principles, there is increasing agreement about using formative assessment (Black and William 2009). The purpose of the assessment is thus giving feedback and facilitating the students' improvement of their learning during the course, not only at the end of the course. Often it is the tutor who provides feedback throughout the PBL process (Kolmos et al. 2008). In a course on entrepreneurship education, assessment is largely driven by student reflections as opposed to an end project/product (Clarke and Underwood 2011). However, most courses require students to prepare a report. In one course with a focus on water management in communities, a team's final project was to propose an intervention plan that would ultimately help the community face the challenge presented in the study. In one case, real community intervention was inspired by the students' projects (Wiek et al. 2014).

METHODOLOGY

Research design

This paper follows an action research (AR) approach, which has been applied in similar experiences of competence development such as sustainability education (Jensen 2016) and entrepreneurship education (Winkler 2014; Elo 2016). Adopting an AR approach implies that the researcher takes a participant observer role (Bryman 2012). In educational development projects, AR is often applied following the incremental curricular steps of curricular design, intervention and analysis. Subsequently, the cycle starts again, and once the intervention is analyzed, a new intervention is carried out based on this reflection (Jensen 2016; Elo 2016).



Curricular design

The competence framework was adapted to a summer course consisting of 5 European credits (ECTS) and aimed at master's level students in business administration and social sciences (Figure 1). The course was part of an education project involving four partner higher education institutions (HEIs) in Norway and Brazil. Through this project, the partners aimed to increase management graduate students' competencies within the overall themes of entrepreneurship and regional development in the context of a post-oil economic transition. Network partners in both countries aimed to provide the small groups of students with real-world cases that would illustrate how the private sector's challenges need to be solved through entrepreneurial action.



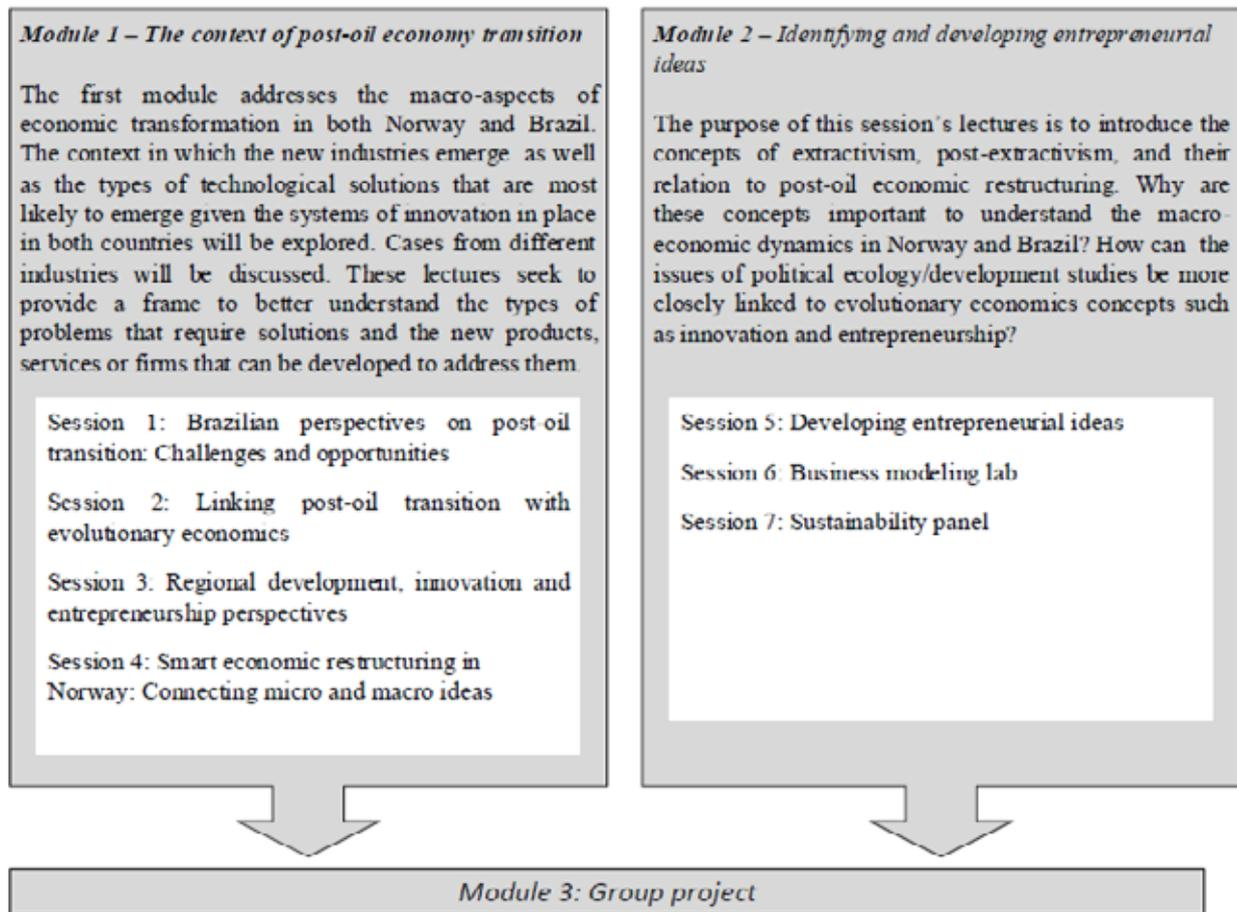
Figure 1: Intended learning outcomes of the course

Knowledge
<ul style="list-style-type: none">• Gain an understanding of the hegemonic and counter-hegemonic discourses about extractivism and post-extractivism in the context of Norway and Brazil.• Gain an understanding of the main theoretical approaches to understand innovation dynamics at a societal level with emphasis on triple helix and innovation systems.• Gain an understanding of the concept of smart specialization and how it can generate windows of opportunities in Norway and Brazil.• Gain an understanding of the entrepreneurial process, with an emphasis on entrepreneurial opportunity identification and exploitation.• Gain an understanding of business model concepts and explore how entrepreneurs and innovators can use them as a tool.• Become familiar with the main aspects of design thinking, new product development, and new venture creation, the elements of what it takes to be an entrepreneur.
Skills
<ul style="list-style-type: none">• Be able to analyze the main components of innovation systems at a national and regional level. Will be asked to answer questions such as: What can predict whether or not an innovation system is suited to post-extractivism?• Critically outline the consequences of development pathways focused on extractivism at national and regional levels. Explore the implications of smart specialization as a pathway diversification strategy.• Identify the conditions necessary for certain entrepreneurial ideas to contribute to path diversification and the conditions necessary to exploit the market opportunities around these entrepreneurial ideas.• Be able to use tools, such as the business model canvas, to plan for business ideas in the context of new products, services, or processes developed in the context of post-extractivism.
Competencies
<ul style="list-style-type: none">• Increase their ability to analyze complex problems and frame them as a research questions.• Gained competence in collaborating in team work with intercultural groups and using digital learning tools.• Increased their ability to reflect on and consider theoretical problems in a general sense in research.• Increased their ability to communicate problems, analyses, and results to colleagues both orally and in writing, including by contributing to academic debates.

The course was conducted in three modules, as outlined in Figure 2. Each session included lectures but also activities such as site visits and presentations from companies or staff from science and technology parks. In addition, the course was structured such that most lectures within module 1 were given by staff from the partner universities and took place in Rio de Janeiro. Module 2 took place in Bodø (Norway), also with the participation of staff from the local partner university in Norway. Module 3 was shared in both locations, and supervision was provided to the students; this module was organized following a PBL approach.



Figure 2: Course structure of three modules and seven sessions



Problem-based learning as merging sustainability and entrepreneurship education

Module 1 and module 2 provided a theoretical basis for the two perspectives of sustainability and entrepreneurship. During the three weeks of the summer program (two weeks of physical meetings and one week of virtual work), the students organized their own groups around a selected theme focused on ‘post-oil’. The course projects aimed to advance societal solutions that could have spillover effects to tackle sustainability challenges while generating new business opportunities. The contrasting visions of ‘post-oil’ economies embedded in narratives of ‘economic restructuring’ (Norway) and ‘post-extractivism’ (Brazil/South America) offered an opportunity to discuss sustainability issues within a business development setting. In Norway, in the context of manifest concerns about the future of an extraction-based economy, debates have emerged about what type of development pathway is necessary, and substantial investment currently goes towards financing expensive R&D subvention programs (Isaksen, Normann, and Spilling 2017; Bodas Freitas et al. 2017). On the other hand, in Latin America, including Brazil, where the oil and gas industry is important to the economic matrix (Burchardt and Dietz 2014; Raftopoulos 2017), an academic and political



debate has emerged regarding the perverse effects of relying on extractive sectors and primarily on exports (Arsel, Hogenboom, and Pellegrini 2016; Rosales 2016; North and Grinspun 2016; Van Teijlingen 2016).

Course development and analysis

After the course, we carried out in-depth interviews of nine students; each interview was 25-120 minutes long (for a total of 450 minutes of recordings; see Table 1). The purpose of these interviews was to assess the elements of the problem-based module and the combination of the seven sessions (Appendix 1).

Table 1 List of interviews

Interview ID	HEI's country	Study program
1	Brazil	Management
2	Brazil	Economics
3	Brazil	Management
4	Brazil	Economics
5	Brazil	Management
6	Norway	Management
7	Norway	Sociology
8	Norway	Sociology
9	Brazil	Engineering

The authors transcribed the interviews verbatim and coded them in two iterative cycles (Saldaña 2009). The first coding cycle entailed in vivo coding of students' experiences. This inductive approach resulted in 88 items. Subsequently, through axial coding (Saldaña 2009), these codes were grouped into main categories, largely inspired by the competence framework but also related to other issues mentioned by the interviewees that we found relevant for assessment. Seventeen main categories were identified. These categories were subsequently reduced to five main themes (Table 2).



Table 2 Data structure of the empirical materials (the number of codes linked to a particular category are given in parentheses)

Categories	Themes
Real-world oriented (6) Problem-based learning (23) IT in pedagogics (1) Improving the course (8) Course structure (4) Course implementation (1) Course impact (5) Active-learning approaches (9)	Teaching learning approaches
Post-oil discussion (10) Innovation design (2) Entrepreneurship ecosystem support (1) Sustainability literacy (1) Social entrepreneurship (1)	Main themes tackled by the course
Practice (5) External collaboration (1)	External collaboration
Faculty training (3)	Educational focus

RESULTS

The analysis of the interview data reveals that most of the students’ reflections focused on the way learning approaches were taught. We were particularly interested in assessing how the students perceived PBL in combination with the sessions and with the other elements of the course (intercultural learning, post-oil). The second most discussed themes related to the course’s topics. The external collaboration with industry and companies, along with the educational focus, were marginal themes throughout the interviews.

Participants reflections about “post-oil” from a sustainability and entrepreneurship perspective

The students’ assessment of the course’s core themes mentioned the following: corporate aspects of sustainability, the concept of post-oil, innovation design, social entrepreneurship, sustainability literacy, and entrepreneurship ecosystem support. Of these ideas, the program’s main theme, the concept of post-oil, proved to be the largest focus of student feedback and will be addressed here in greater detail.



Some participants were not entirely clear about the relation between ‘post-oil’ and entrepreneurship at the outset of the course:

Personally, I didn't have that much idea about what are the problems that actually, Norway and Brazil are facing, because they have come up with a title, the post-oil transition. So why have they come up with this title? Why this is that important? (Int. 6)

Others had some knowledge. Interviewee 1 claimed that:

It was kind of common knowledge that the peak-oil era had a time window of 40 years, and countries with an economy based on oil – Saudi Arabia, Qatar, Venezuela, or even Norway – need to find renewable energy sources. (Int. 1)

Another student was familiar with the topic because she was involved in a research group working on energy, technology, industry and territory at Fluminense Federal University (Rio de Janeiro), and post-oil discussions are one theme of the group's research (Int. 4).

The overall impression was that the post-oil theme was a good background and inspiration for the project work and for interlinkages among different themes:

It is not only the economy that is making the world turn around, but societies need to become sustainable; therefore, this is something that this course made clear to me. It is not only a question about gasoline, diesel, oil-derived products. (Int. 3)

The lecture introducing the concept of triple helix, a framework to explain industry-government-university collaboration, was particularly mentioned as being relevant in this regard (Int. 7).

Students thought that the way the course addressed post-oil made a good deal of sense in light of the complex discussions around the subject. As one student mentioned, it is not merely an economic issue but also a social issue that requires a transversal analysis (Int. 3).

Students barely mentioned entrepreneurship in the interviews, even though the course aimed to conceptually link post-oil with entrepreneurship. One exception was an interview that linked it with “social entrepreneurship” (Int.1). Other mentions considered the importance of introducing the Norwegian perspective on entrepreneurship. Interviewee 5 considered the Scandinavian perspective to be slightly different than the Brazilian perspective, which is often portrayed as individualist and not linked to an ecosystem of support for the entrepreneur. Brazilian students considered the summer program valuable because of this knowledge (Int. 5).



Circular economy was not a core theme within the program, but students found it valuable that it was mentioned by several lecturers, thus enhancing their knowledge and revealing hidden links with the overall theme of post-oil transitions (Int. 6).

Students also commented on innovation design, which was addressed in some of the lectures during week 2 and which introduced hermeneutical tools that enhanced the creativity linked to their projects (Int. 1).

Teaching and learning approaches

Students also reflected on the teaching and learning approaches. These comments are classified into six categories: course structure, active learning approaches, problem-based learning, real-world oriented learning, course impact, and suggestions for improvement. The course integrated one module that was exclusively focused on the development of competences for group projects. The feedback on the use of PBL was generally positive, and one student mentioned that this allowed there to be a common thread between lectures, which led them to look for knowledge and evidence to help solve the problem (Int. 6). We therefore analyzed the students' assessment of the PBL module through the general stages of group formation, problem analysis and project development, dynamics within the groups, and challenges of carrying out the approach.

Group formation

During the second day of the course, the students formed groups by identifying common interests through a "café dialogue" group dynamic. The purpose was to create diverse and interdisciplinary groups with members from different universities, programs and countries. The dynamic involved setting four tables, each with a different title

("eco-innovation", electric cars, societal transition, education), and every five minutes students had the opportunity to join a table and discuss the designated topic with others. After three rounds, students decided which table to join, forming groups of four to five students. Students appreciated this approach to forming groups (Int. 7). Similarly, students liked the idea of comparing themes and meeting other students who had some shared interest:

So, I was moving in all four groups, at first there were like four different headings. I participated in all four groups with an open mind, considering that if there's some new possibilities, I will join them. (Int. 6)

Previous knowledge played a role in students' selection of the theme and ultimately of the group they worked with. The café dialogue took place before any lectures:



I think everybody had an idea of what eco-innovation was, if we want to work with this concept because it is intriguing, it's interesting and is also something that is future related. (Int. 7)

Even after students chose a table theme, what this meant in practice was not always evident. Therefore, discussions and negotiations about the project focus also took place at this initial stage:

When I was talking to Eduardo, Pablo and Andre I got an idea about eco-innovation. Later, together with Eduardo, I discussed having a focus on entrepreneurship instead. We ended up doing that anyway, talking about policies and the role of the government and other things. (Int. 6)

Problem analysis and planning

When students reflected on the group formation phase, they also observed that in addition to shared interest in a theme, mixing experienced and novice students helped to improve the group:

It is true, in our group, all having a common language helped us to create affinity, better exchange our points of view. However, the most important thing was to have a good blend of experienced and non-experienced students. (Int. 3)

Other interviewees highlighted experience as the determinant factor used to focus the group discussions and filter ideas:

Students without much experience are often looking to stand over the others; those with more experience are more mature, they don't have that need. Instead they focus their energy to help the group progress in their tasks. (Int. 5)

During the initial stages of problem analysis, experience played a key role in problem formulation and in choosing a post-oil perspective to develop the projects. More experienced students often built the problem analysis on issues they dealt with every day as part of their jobs:

At some point we were unsure how to proceed methodologically. Then student D. picked up the idea of working with MOOCs, which later we built our paper on. All materials are available online. (Int. 5)

This student claimed that he had worked 22 years in the administration of a Brazilian university and before that he was an IT entrepreneur (Int. 5); therefore, his contextual knowledge obviously helped him to guide



the group choices at this initial stage. Besides experience, students also highlighted complementary skills as something that moved the groups forward during initial discussions and framing:

I felt like my understanding of how things work came from my social sciences perspective. I was the only social science scientist in my group. [Student G.] is a philosopher and the two others are from the business school. We came from different perspectives, so I really think I brought something to the table when I, when we discussed ideas, discussing where we are going and so forth. (Int. 7)

In addition to the interdisciplinary combination of group members, the students highlighted the problem analysis tools as a great support in identifying their key issue (Int. 5). As the course progressed, group discussions provided a good arena to reflect on the theories learned during the lectures. An example is a theory used to understand the agency of universities in societal change, namely the triple helix, which is related to socio-ecological issues relevant to post-oil and the students' own experiences:

After the lectures, I was having a debate with [Student E.] regarding the triple helix because we had different opinions about the meaning of triple helix and its different parts. So, talking about that, I told him that I have an interest in the ecological relevance of the model for Norway because I also studied plastic pollution. (Int. 6)

Group dynamics

All students had previously worked in groups during their various educational programs; however, for many of them integrating ideas from other disciplines was something new. This interdisciplinary integration proved to be a challenge when developing a project on post-oil:

[Student E.] proposed focusing on something with development policies. [Student P.] and I were mostly interested in the ecological implications of the ecological theme for Norway, plastic pollution, because it helps both of our studies. P. is also working on climate change, an issue affecting everything. (Int. 6)

Other groups, facing similar situations, framed the project around an idea inspired by one of the members with more experience:

Personally, I had certain interest in including some elements of cross-analysis [of MOOC education]. I was afraid it could jeopardize our work at the time. Hence, I refrained from mentioning it. I'm indeed convinced we made the right choice and we are preparing a good report. (Int. 3)



Students often highlighted how communication and exchanges of ideas emerged during the group work. In an intercultural learning context, it is interesting to note how Brazilian students assessed the Norwegian students as posing critical questions; at the same time, language barriers prevented a full sharing of critical ideas in relation to other opportunities:

Yes, we had this [Norwegian student], who was always teasing us, in the good sense; she was provocative, asking the critical questions: "This must improve, right?" I found it superb, very positive. Sometimes [Brazilian student] was quite reserved, afraid of not finding the right English term. Even if my English is not perfect, I share my ideas, no problem if I make mistakes. At the end [Brazilian student] also managed to share his ideas. (Int. 4)

A number of factors played a role in helping the group integrate previous knowledge with new knowledge delivered through the lectures. Among the factors mentioned by students are critical interactions through questioning but also leadership through previously matured ideas (Int. 4).

Challenges

Students faced some challenges during the PBL process, such as moving from brainstorming to actually writing the project. As interviewee 5 put it:

One difficulty we passed through was transitioning from the stage of internal debate and brainstorming to the actual project writing. It was extremely difficult for our group. At some point, it was like all the members tried to convince the others to integrate their own ideas. Getting approval from the others and moving ahead was time consuming. (Int. 5)

Similarly, some students argued that the initial problem analysis was difficult because the groups were large and most of their ideas were therefore too unfocused:

At the outset I had difficulties collaborating and contributing to the discussions. In group work, the person who speaks the most can impose his/her ideas with ease; the others, as result, fall behind. I prefer that tasks are fairly distributed from the outset. In Rio, when we were five in the group, we did not manage to identify a focus FOR our project. In Bodø, working closely together with [Student D.], we made better progress. (Int. 5)

Another challenge was fitting the PBL framework into a short summer course timeframe. The limited time allocated to developing the project had consequences for how students budgeted their time and planned the scope of their projects. As interviewee 7 highlighted:



I think we were pretty set on our idea, it's just that it was too huge for just a two-week assignment. We weren't narrowing it down to a manageable substance for a manageable timescale, and that was the problem because I recognized when we had the lecture with the PhD candidate that suddenly my idea is worthy of a PhD proposal and that is way too much for two weeks. (Int. 7)

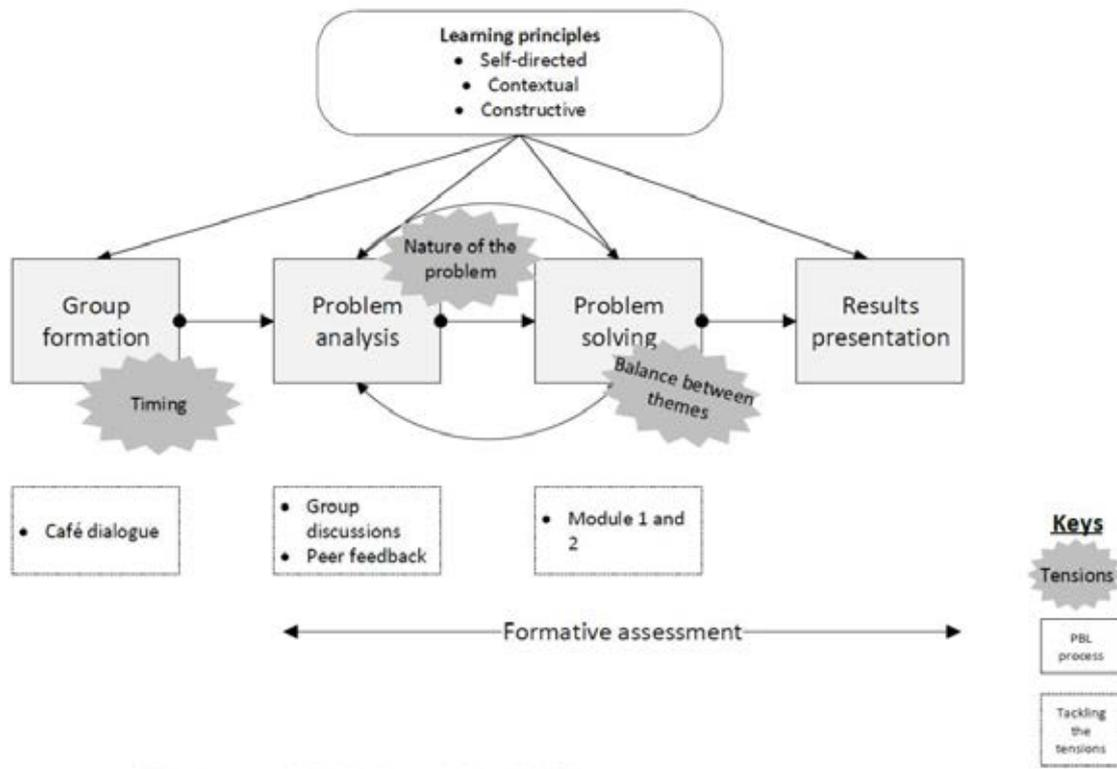
DISCUSSION

In this article, we addressed the question: *How is active learning best integrated into a higher education curriculum with entrepreneurship and sustainability learning objectives?* Relying on classroom action research (AR) methodology (Jennings et al. 2015; Johnson-Burel, Drame, and Frattura 2014), we took a reflective approach in which students and the researcher-participants engaged with the purpose of improving the course, their own learning process, and their professional development (Kemmis and McTaggart 2005). Based on our classroom AR experience, we argue for a course design inspired by the PBL process (Figure 3). Such a design builds on previous research on sustainability and entrepreneurship education, with a focus on either competences (Lans, Blok, and Wesselink 2014) or teaching methods (Mindt and Rieckmann 2017).

Therefore, in the course structure we used in our study, PBL pedagogy was integrated as a group-based project that was also used to assess the course. Our framework sheds light on the relationship between the key principles of PBL and the thematic balance of sustainability and entrepreneurship education in the curriculum, on the process of integrating PBL into course design, on related tension points, and on strategies to tackle those tensions.



Figure 3: PBL process framework, tension points, and strategies for addressing the tensions in the course



We integrated the key principles of PBL, namely, learning as a constructive process, learning as a self-directed process, and learning as a contextual process (Moust, Berkel, and Schmidt 2005). The PBL process included the stages of group formation, problem analysis, problem solving and results, presentation, and validation. After conducting the student interviews, we identified tension points along the PBL process.

The first tension, which we call "timing" (Figure 3), emerged early in the group formation phase. Our findings indicate tensions in relation to the elaboration processes on one hand and to the heterogeneity (multi-cultural, interdisciplinary and experience) of the group on the other hand. Elaborations indicate the oral exchange among group members with the purpose of stimulating self-directed learning and ownership of the knowledge-building process (Dolmans et al. 2005). In the context of our short courses integrating PBL at the graduate level, it is often common to have diverse groups (in terms of discipline, experience, and cultural background). Meanwhile, during the group formation stage, we set up a framework to align students' diverse interests and maintain self-directed learning principles. We achieved this through the café dialogue dynamic, which allowed a relatively quick alignment of interests and the identification of group leaders who were experienced in one of the themes. As the students mentioned, the initial ideas evolved during the three-week period of the course. These changes in the problem analysis also indicate the importance of the lectures during the later stages of the PBL process.



A second tension was the quality of the problems that students can develop and subsequently 'solve' in connection with the course's learning objectives. Here is one aspect in which PBL differs from the case study teaching method, namely the relative freedom students have to structure their own problems (Graaf and Kolmos 2003). The background of this tension is often portrayed in the PBL literature as a wide difference of problem integration approaches across programs and disciplines. We framed the initial problem within a broad theme and subsequently allow students to scope it with relative autonomy and freedom from teachers' influence; this contrasts with other course designs in sustainability and entrepreneurship education, where the teacher's role is more important (Ban et al. 2015). Yet this can introduce tension as students formulate and scope the problem. To tackle this tension, we allowed students relative flexibility in problem formulation during the course. An initial problem analysis was carried out by the end of the first week, and subsequently, students modified this problem formulation according to inputs they received during modules 1 and 2.

A third tension emerged in relation to the two broad themes of the course: on one hand, it encompassed sustainability as a societal transformation interlinked with regional planning aspects of extractive economic development, and on the other hand, it referred to micro-economic issues linked to entrepreneurship (new business development, creativity, start-ups, technology). The students' overall feedback about how both themes were combined in modules 1 and 2 indicated that while the scope of the themes can be broad enough, it is extremely important to have a common thread that aligns the PBL principles. In our course, the common thread that helped to focus these discussions was the discussions about phasing out an oil-dependent economy. Engaging this theme also allowed us to maintain a balance between the two educational areas sustainability and entrepreneurship education, which have both generated associated research and education experiences with PBL. From this perspective, our approach also differs from previous graduate courses that adopt PBL as the guiding pedagogical approach but focus overwhelmingly on one of the two issues (either environmental planning or new business creation) but do not combine them into single PBL projects; examples of these experiences at the graduate level are listed in Ban et al. (2015) and Rossano et al. (2016). To address the third tension we provided formative feedback to students during the learning process and not after, with the intent of ensuring that any student mistakes that affected their assignments was caught on time and that reflection would be integrated into their work (Biggs and Tang 2015). Inspired by other experiences of formative feedback in PBL contexts (i.e. Spliid and Qvist 2013), we used multiple types in our course: reflections during group work, oral presentations where students received peer recommendations and comments from teachers, meetings with tutors during group work, and self-assessments where students had the opportunity to critically explain their group collaboration.



CONCLUSION

As entrepreneurship education gains momentum across higher education institutions worldwide, it is key to think critically about its contribution to training the next generation of entrepreneurs who will create value for stakeholders and the environment – not just shareholders. In addition, discourses across the private and public spectrum seem to converge to provide new potential roles for entrepreneurs, such as those working towards sustainable development goals or tackling market externalities.

This paper engages in this discussion and contributes to a better understanding of how sustainability can be combined with entrepreneurship education. We developed a conceptual framework for making sustainability education more entrepreneurially oriented in higher education; this was achieved through a problem-based learning process. This framework was further tested through a course designed in the context of a summer program, while students' evaluation of the program offered ways to improve the course design in the future.

This paper also has practical implications, including a framework that can be used to design new educational programs combining sustainability and entrepreneurship objectives in graduate programs. Since the framework was developed in collaboration with partner programs in Norway and Brazil, we also provide a detailed overview of three potential tensions that course designers might face and ways to address those tensions right from the start.

As with other studies following a classroom action research approach, this research has limitations in terms of external validity. The transferability of our results and analysis can be evaluated by comparing our original context to that in which the study is to be replicated. To facilitate transferability, we provide a thick description of our setting. Further contributions could enhance our framework by analyzing in greater detail the role of formative feedback during the different stages of the PBL process, as this seemed to be our key strategy for addressing tensions at the group level and finding a balance between entrepreneurship and sustainability issues. Quasi-experimental designs could be particularly useful in this research.

DISCLOSURE STATEMENT

No potential conflict of interest was reported by the author.

REFERENCES

- Arsel, Murat, Barbara Hogenboom, and Lorenzo Pellegrini. 2016. "The Extractive Imperative in Latin America". *The Extractive Industries and Society* 3 (4): 880–887. doi:10.1016/j.exis.2016.10.014.
- Ban, Natalie C, Emily Boyd, Michael Cox, Chanda L Meek, Michael Schoon, and Sergio Villamayor-Tomas. 2015. "Linking Classroom Learning and Research to Advance Ideas about Social-Ecological Resilience". *Ecology and Society* 20 (3): art35. doi:10.5751/ES-07517-200335.



- Biggs, J., and C. Tang. 2015. *Teaching for Quality Learning at University*. New York: Open University Press.
- Black, Paul, and Dylan William. 2009. "Developing the Theory of Formative Assessment". *Educational Assessment, Evaluation and Accountability* 21: 5–31.
- Bodas Freitas, Isabel, Fulvio Castellacci, Roberto Fontana, Franco Malerba, and Andrea Vezzulli. 2017. "Sectors and the Additionality Effects of R&D Tax Credits: A Cross-Country Microeconometric Analysis". *Research Policy* 46 (1): 57–72. doi:10.1016/j.respol.2016.10.002.
- Brundiers, Katja, and Arnim Wiek. 2013. "Do We Teach What We Preach? An International Comparison of Problem- and Project-Based Learning Courses in Sustainability". *Sustainability* 5 (4): 1725–1746. doi:10.3390/su5041725.
- Bryman, Allan. 2012. *Social Research Methods*. 4th ed. Oxford, UK: Oxford University Press.
- Burchardt, Hans-Jürgen, and Kristina Dietz. 2014. "(Neo-)Extractivism – a New Challenge for Development Theory from Latin America". *Third World Quarterly* 35 (3): 468–486. doi:10.1080/01436597.2014.893488.
- Clarke, Julia, and Sarah Underwood. 2011. "Learning Based on 'Entrepreneurial Volunteering'". *Industry and Higher Education* 25 (6): 461–467. doi:10.5367/ihe.2011.0068.
- Dochy, Filip, Mien Segers, Piet Van den Bossche, and David Gijbels. 2003. "Effects of Problem-Based Learning: A Meta-Analysis". *Learning and Instruction* 13 (5): 533–568. doi:10.1016/S0959-4752(02)00025-7.
- Dolmans, Diana H J M, Willem De Grave, Ineke H A P Wolfhagen, and Cees P M van der Vleuten. 2005. "Problem-Based Learning: Future Challenges for Educational Practice and Research". *Medical Education* 39 (7): 732–741. doi:10.1111/j.1365-2929.2005.02205.x.
- Elo, Janne. 2016. "The Benefits and Challenges of Enterprise Education: Results from an Action Research Project in the Third Grade in Finnish Basic Education". *Educational Action Research* 24 (4): 535–549. doi:10.1080/09650792.2015.1113886.
- Graaf, Eirk De, and Anette Kolmos. 2003. "Characteristics of Problem-Based Learning". *International Journal of Engineering Education* 19 (5): 657–662. doi:0949-149X/91.
- Guerra, Aida. 2017. "Integration of Sustainability in Engineering Education: Why Is PBL and Answer?". *International Journal of Sustainability in Higher Education* 18 (3): 436–454. doi:10.1108/IJSHE-02-2016-0022.



Hermann, Roberto Rivas, and Marilia Bonzanini Bossle. n.d. "Bringing an Entrepreneurial Focus in Sustainability Education: A Teaching Framework Based on Content Analysis". *Journal of Cleaner Production*. <https://doi.org/10.1016/j.jclepro.2019.119038>

Holgaard, Jette Egelund, Roger Hadgraft, Anette Kolmos, and Aida Guerra. 2016. "Strategies for Education for Sustainable Development - Danish and Australian Perspectives". *Journal of Cleaner Production* 112 (4): 3479–3491. doi:10.1016/j.jclepro.2015.09.063.

Hung, Woei. 2011. "Theory to Reality: A Few Issues in Implementing Problem-Based Learning". *Educational Technology Research & Development* 59 (4): 529–552. doi:10.1007/s11423-011-9198-1.

Isaksen, Arne, Roger Henning Normann, and Olav R Spilling. 2017. "Do General Innovation Policy Tools Fit All? Analysis of the Regional Impact of the Norwegian Skattefunn Scheme". *Journal of Innovation and Entrepreneurship* 6 (1): 6. doi:10.1186/s13731-017-0068-x.

Jennings, Gayle, Carl I. Cater, Rob Hales, Sandra Kensbock, and Glen Hornby. 2015. "Partnering for Real World Learning, Sustainability, Tourism Education". *Quality Assurance in Education* 23 (4): 378–394. doi:10.1108/QAE-03-2015-0010.

Jensen, Cory D. 2016. "Action Research to Support Development of Engineering for Sustainable Development Degree Programs, Part I: Collaborative Community Action Research Vignettes". *Journal of Cleaner Production* 122 (May): 164–175. doi:10.1016/j.jclepro.2015.09.088.

Johnson-Burel, D, E Drame, and E Frattura. 2014. "Participatory Research in Support of Quality Public Education in New Orleans". *Educational Action Research* 22 (3): 288–305. doi:10.1080/09650792.2013.872576.

Kemmis, Stephen, and Robin McTaggart. 2005. "Participatory Action Research: Communicative Action and Public Sphere." In *The SAGE Handbook of Qualitative Research* edited by Norman K. Denzin and Yvonna S. Lincoln. 3rd Ed. Thousand Oaks, CA: Sage.

Kolmos, Anette, Xiangyun Du, E. Jette Holgaard, and Lars Peter Jensen. 2008. *Facilitation in a PBL Environment*. Aalborg: Aalborg University. www.ucpbl.net.

Lans, Thomas, Vincent Blok, and Renate Wesselink. 2014. "Learning Apart and Together: Towards an Integrated Competence Framework for Sustainable Entrepreneurship in Higher Education". *Journal of Cleaner Production* 62: 37–47. doi:10.1016/j.jclepro.2013.03.036.



- Leal Filho, Walter, Yen-Chun Jim Wu, Luciana Londero Brandli, Lucas Veiga Avila, Ulisses Miranda Azeiteiro, Sandra Caeiro, and Lucia Rejane da Rosa Gama Madruga. 2017. "Identifying and Overcoming Obstacles to the Implementation of Sustainable Development at Universities". *Journal of Integrative Environmental Sciences* 14 (1). Taylor & Francis: 93–108. doi:10.1080/1943815X.2017.1362007.
- Lourenço, Fernando, and Dilani Jayawarna. 2011. "Enterprise Education: The Effect of Creativity on Training Outcomes". *International Journal of Entrepreneurial Behavior & Research* 17 (3): 224–244. doi:10.1108/13552551111130691.
- Lozano, Rodrigo, Rebeka Lukman, Francisco J. Lozano, Donald Huisingh, and Wim Lambrechts. 2013. "Declarations for Sustainability in Higher Education: Becoming Better Leaders, through Addressing the University System". *Journal of Cleaner Production* 48 (June): 10–19. doi:10.1016/j.jclepro.2011.10.006.
- Maudsley, Gillian. 1999. "Do We All Mean the Same Thing by 'Problem-Based Learning'? A Review of the Concepts and a Formulation of the Ground Rules". *Academic Medicine* 74 (2): 178–185. doi:10.1097/00001888-199902000-00016.
- Mindt, Lisa, and Marco Rieckmann. 2017. "Developing Competencies for Sustainability-Driven Entrepreneurship in Higher Education: A Literature Review of Teaching and Learning Methods". *Teoria De La Educacion* 29 (1): 129–159. doi:10.14201/teoredu2017291129159.
- Moust, J .H. C., H. J. M. Van. Berkel, and H G Schmidt. 2005. "Signs of Erosion: Reflections on Three Decades of Problem-Based Learning at Maastricht University". *Higher Education* 50 (4): 665–83. doi:10.1007/s10734-004-6371-z.
- North, Liisa L, and Ricardo Grinspun. 2016. "Neo-Extractivism and the New Latin American Developmentalism: The Missing Piece of Rural Transformation". *Third World Quarterly* 37 (8): 1483–1504. doi:10.1080/01436597.2016.1159508.
- Raftopoulos, Malayna. 2017. "Contemporary Debates on Social-Environmental Conflicts, Extractivism and Human Rights in Latin America". *International Journal of Human Rights* 21 (4): 387–404. doi:10.1080/13642987.2017.1301035.
- Rosales, Antulio. 2016. "Deepening Extractivism and Rentierism: China's Role in Venezuela's Bolivarian Developmental Model". *Canadian Journal of Development Studies - Revue Canadienne d'Études Du Développement* 37 (4, SI): 560–577. doi:10.1080/02255189.2016.1208605.



Rossano, Sue, Arno Meerman, Tobias Kesting, and Thomas Baaken. 2016. "The Relevance of Problem-Based Learning for Policy Development in University- Business Cooperation". *European Journal of Education* 51 (1): 40–55. doi:10.1111/ejed.12165.

Saldaña, Johnny. 2009. *The Coding Manual for Qualitative Researchers*. Los Angeles: Sage.

San Tan, Siok, and C. K. Frank Ng. 2006. "A Problem-based Learning Approach to Entrepreneurship Education". *Education + Training* 48 (6): 416–428. doi:10.1108/00400910610692606.

Santateresa, P. I. 2016. "Fostering Entrepreneurship in Higher Education, by Problem- Based Learning". In *Education Tools for Entrepreneurship; Creating an Action- Learning Environment through Educational Learning Tools*, edited by Peris-Ortiz M., Gómez J., Vélez-Torres F., and Rueda-Armengot C., 167–182. Springer, Cham.

Savin-Baden, M., and C.H. Major. 2004. *Foundations of Problem-Based Learning*. Berkshire, UK: Open University Press.

Schmidt, Henk G. 2012. "A Brief History of Problem-Based Learning". In *One Day, One Problem*, edited by G. O'Grady, E. Yew, K. Goh, and H. Schmidt, 21–40. Singapore: Springer.

Spliid, C.M., and P. Qvist. 2013. "The Aalborg Model and Management by Objectives and Resources". In *Visions, Challenges and Strategies; PBL Principles and Methodologies in a Danish and Global Perspective*, edited by L. Krogh and A.A. Jensen, 87–102. Aalborg: Aalborg University Press.

Van Teijlingen, Karolien. 2016. "The 'Will to Improve' at the Mining Frontier: Neo- Extractivism, Development and Governmentality in the Ecuadorian Amazon". *Extractive Industries and Society - An International Journal* 3 (4): 902–911. doi:10.1016/j.exis.2016.10.009.

Wals, Arjen E J. 2014. "Sustainability in Higher Education in the Context of the UN DESD: A Review of Learning and Institutionalization Processes". *Journal of Cleaner Production* 62: 8–15. doi:10.1016/j.jclepro.2013.06.007.

Wee, Keng Neo Lynda. 2004. "A Problem-Based Learning Approach in Entrepreneurship Education: Promoting Authentic Entrepreneurial Learning". *International Journal of Technology Management* 28 (7/8): 685. doi:10.1504/IJTM.2004.005777.

Wiek, Arnim, Angela Xiong, Katja Brundiers, and Sander van der Leeuw. 2014. "Integrating Problem- and Project-Based Learning into Sustainability Programs A Case Study on the School of Sustainability at Arizona



State University". *International Journal of Sustainability in Higher Education* 15 (4): 431–449. doi:10.1108/ijshs-02-2013-0013.

Winkler, Christoph. 2014. "Toward a Dynamic Understanding of Entrepreneurship Education Research across the Campus - Social Cognition and Action Research". *Entrepreneurship Research Journal* 4 (1): 69–93. doi:10.1515/erj-2013-0039.

Wyness, Lynne, Paul Jones, and Rita Klapper. 2015. "Sustainability: What the Entrepreneurship Educators Think". *Education and Training* 57 (8–9): 834–852. doi:10.1108/et-03-2015-0019.

APPENDIX 1 – QUALITATIVE INTERVIEW GUIDE

- Part I: Student background
 - Field of study/work experience
 - Business experience
 - Sustainability experience
- Part II: Content and structure
 - Combination of activities
 - Structure
- Part III: Interpersonal interaction
 - Social
 - Group work
 - Report an issue
 - Report a good thing going on in your group
- Part IV: Self-assessment
 - What have you brought from your previous experience and how has it helped you further progress in the course?
 - How did you contribute to the whole project?
- Part V:
 - Perception/knowledge before vs. now about this topic
 - Did attending the summer program make you think about different plans for the future?

ACKNOWLEDGEMENTS

The authors thank the several guest teachers from our partner institutions who participated in the course and put this research project into action: Nord University, Federal Fluminense University, Federal University



of Rio de Janeiro, Engage Center for Entrepreneurship Education, Nordland Research Institute and Salten Science Park.

AUTHOR INFORMATION

Roberto Rivas Hermann, roberto.r.hermann@nord.no, Norway, Nord University (corresponding author)

Marilia Bossle, marilia.bossle@viamao.ifrs.edu.br, Brazil, Instituto Federal do Rio Grande do Sul

Marcelo Amaral, marceloamaral@id.uff.br, Brazil, Universidade Federal Fluminense



THE CASE OF CO-CREATION IN A PBL UNIVERSITY – A STUDENT PERSPECTIVE

Annie Aarup Jensen & Lone Krogh

ABSTRACT

At Aalborg University, PBL in the form of student-directed, group-based project-work accounts for approximately 50% of the curriculum, the remaining 50% consisting of lectures, seminars, laboratory work etc. In order to integrate PBL-principles (Illeris, 1974; Krogh & Jensen, 2013) further into the classroom and acknowledge students' resources by involving them in the creation of knowledge (Chemi & Krogh, 2017; Iversen, Pedersen, Krogh, & Jensen, 2015; Bovill & Bulley, 2011) from day one in their BA study, a semester was designed, where students co-create with teachers both in terms of deciding on student activities and in being responsible for organizing presentations and other teaching activities, incl. peer feedback. The experiment has run for four years with 36-58 students per cohort. It is continually being developed, based on experiences gained, evaluations and documentation through students' reflection papers, notes and observations from workshops, where students identified challenges and problems, notes from classroom observations of co-creative sessions, formal evaluation with student representatives, and formal evaluation by school management. The results show a.o.t.: reduced dropout rate, increased student contentment, a wish for increased student involvement and responsibility, and trained basic academic skills identified by others teachers at later semesters. However, the experiment also seems to be demanding for some students, not all colleagues agree with the approach, and logistics pose challenges. Finally, the paper reflects on the challenges such approaches may present specifically for students with mental health problems.

KEYWORDS: Co-creation, Participation, Peer-to-peer production, Challenges

TYPE OF CONTRIBUTION: Practice-based abstract

PRESENTATION FORMAT: Roundtable discussion

The authors have chosen not to have their full abstract published in the conference proceedings. We encourage you to look for existing or future publications by this author in other outlets.

AUTHOR INFORMATION

Annie Aarup Jensen, aai@hum.aau.dk, Denmark, Aalborg University (corresponding author)

Lone Krogh, lkr@hum.aau.dk, Denmark, Aalborg University (corresponding author)



REALISTIC ROLE-PLAY WITH INDUSTRY AS A HYBRID PBL COURSE DESIGN AIMING FOR DEVELOP PROFESSIONAL ENGINEERING SKILLS

Pernille Andersson & Niclas Andersson

ABSTRACT

This abstract elaborates on the hybrid model of Problem Based Learning in which realistic role-play with industry as a teaching and learning method are used in an engineering course in the disciplinary field of civil engineering at master level. In the course three major processes are designed to strengthen student learning in the course subject as well as the students' development of professional skills. The processes are the tutorial process, the project process and the social process. During the course the students are involved in a deep collaboration with a company and are given the task to solve an authentic and complex problem of the client. The students work in teams throughout the course and need to act as professional consultants using the knowledge they acquire in the specific course, as well as from their entire education to be able to solve the clients' problem. In their teams the students need to develop a deep collaboration in order to perform problem solving on a high level. This way of working in a disciplinary course expands the boundaries for education and engage the students directly in solving an authentic and complex problem. Likewise, it gives the students a possibility to engage in professional networks outside university and create own professional connections as a part of their education. Continuous evaluation through questionnaires and interviews with students has been conducted. Data indicates that students experience deeper learning and acquisition of knowledge about the conditions and skills needed for a professional engineer.

KEYWORDS: Realistic role-play, industry cooperation, professional skills, engineering education

TYPE OF CONTRIBUTION: Practice-based abstract

PRESENTATION FORMAT: Roundtable discussion

INTRODUCTION AND BACKGROUND

Motivation for develop a course design which includes explicit learning objectives for professional skills is that engineering education fundamentally aims at preparing students to become qualified professional. This requires knowledge of science, engineering and a general understanding of the complex products, processes, and systems that constitute the society of today. The practice of professional engineering also requires



abilities to work in teams with people of different professional and cultural backgrounds, communicate, understand the basics of business, be innovative and conduct to professional ethics and social responsibilities. Those aims have consequences for Engineering Education (Hadgraft & Kolmos, 2020).

Problem Based Learning (PBL) is a teaching paradigm which can fulfill many of the aims to train students to professionals that can meet the requirements mentioned above. PBL methods builds on the theoretical background of constructivism (Howell & Savin-Baden, 2004) and the framework of experiential learning described in the learning model of Kolb (Kolb 1984). Significant for this model is that learning is triggered from a concrete experience in format of a case or problem that actively involves the learner to apply new theoretical knowledge. The cases in PBL can vary from closed and discipline specific, created by the teacher, till open ended wicked problems, formulated by the students (Kolmos, De Graaff, Du, X 2009). The PBL hybrid using realistic role-play with industry, described in this abstract, aiming to enhance students learning the disciplinary content as well as train professional skills using wicked problems from industry partners are design on those principles. Role-playing for teaching purposes is part of a wider group of teaching methods known as simulation and gaming which provide a mechanism that involves and activates the participants embracing their roles (Druckman, D. and Ebner, N, 2008). In this hybrid PBL model focus is on strengthen student learning on the dimensions of social interaction, project as a realistic role-play with industry stakeholders and tutorials (Andersson, Andersson, 2010).

COURSE DESIGN

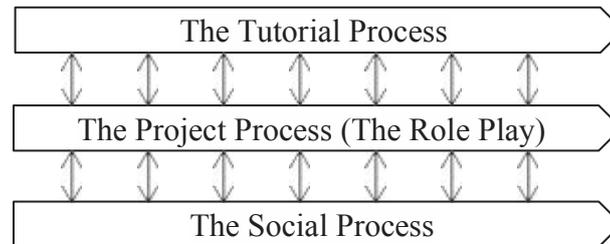
The role-play as a hybrid PBL-method is used in a master level engineering course with the main objective to learn students how to use “Building Information Modelling” (BIM) as an integrated tool in the planning and management of construction projects. The practical case come from two different cases, one took place at Lund University, Faculty of Engineering, in Sweden during 2003 to 2005, and case 2 refers to The Technical University of Denmark, during 2009 and 2012. Both the courses have the same traits:

- Optional for students in their final year of education.
- Credits correspond to about 30% of full-time studies for a semester.
- About 15 to 20 students from different engineering programs.
- A cross-disciplinary selection of students within the areas of civil-engineering, architectural and land surveying programs.
- International group of students
- Students work in groups of about four to five students formed by the teacher.



The pedagogic design of the course relies on three interactive processes the tutorial process, the project process, and the social process which run in parallel throughout the course, figure 1 (Andersson, Andersson, 2010).

Figure 1: The Tutorial, the Project and the Social Processes of the Course



The project process is a role play simulation where groups of students carry out a project in the role of BIM-consultant. The authentic problem the students work on is assigned by real clients represented by professional engineers from the industry. Each group of students has its own client. The PBL-process and the role play provide the corner-stone of the course.

The tutorial process includes lectures and exercises in which relevant theories and methods in BIM-modelling and project management are introduced. When the clients are introducing a new topic at meetings this creates a motivation among the students towards the theory. The project and teaching processes are synchronised throughout the course.

The social process includes a conscious and formal assessment of the students own personal development of personal and interpersonal skills, which also relates strongly to the role play of the PBL-process which needs skills in teamwork, leadership, and communications.

The role play start at the beginning of the course. Day one, each group of students received an invitation to a business-meeting with the professional client. The students contact their client and arrange the time and place for their first meeting. The early introduction of the role-play and the immediate need to prepare for the first meeting with the clients act as a strong motivator for the students to organise themselves as a fictitious consultancy company including a company name and a business plan etc. The teambuilding processes in the groups starts.

The meetings take place at the office of the industry representatives and strongly contribute to the realistic context. The students are responsible for the meeting, to prepare an agenda, and to keep the minutes. Four to five meetings are scheduled during the course and are milestones where the students report, discuss, and



get feedback. The clients pull the project forward in dialogue with the students as they introduce new requirements to the project. When the students return from a meeting they are motivated learning theory to provide the client with adequate solutions (Andersson & Andersson, 2010). The clients get a guideline for the project framework and the course-topics. The guideline has been developed in dialogue with the clients to make sure that the project assignment is realistic and valid.

ASSESSMENT

An approach to assessment of professional skills, consisting of three steps, has tested throughout many iterations:

Step 1: Define – Identification of relevant aspects of professional skills.

The first step included an introduction to, and a definition of the concept of professional skills. The student-teams identified aspects of professional skills relevant for them in the project.

Step 2: Monitor – Continuously monitor and document the professional skills.

In each meeting and the clients provided an immediate review and feedback to the students about their professional performance as formative assessment enhance students' self-assessment and awareness own learning (Shepard, L.A 2005). At every meeting a student took the role of an observer documenting the professional performance of the students using the list prepared in step 1.

Step 3: Assess – Reflect and report on the learning progression of professional skills.

Step 3 constituted an individual self-assessment of the professional skills achieved which were described together with personal thoughts and considerations about the learning process.

EVALUATION

Course evaluations from 2009 to 2012 indicates that the realistic role-play is appreciated by the students. Quotes from the evaluations are presented in the bullet lists below. There was a total of 14, 20, 14 and 17 students taking part in the course evaluations from 2009, 2010, 2100 and 2012. The shares of students who agree to the respective statements are put in brackets:

Positive:

- Direct contact with the industry made it more interesting (100%)
- Real Case - makes it realistic, (100%)
- Learned a lot from client, (100%)
- Professional skills developed, (100%)
- Insight in the "real world", (100%)
- Very good with role-play (real clients), (90%)



Challenges:

- Not being prepared for the 1st meeting, (63%)
- Too much uncertainty in the very beginning of the course concerning meetings with the client, (60%)
- Clients step out of the course topic, (50%)
- Project and teaching process sometimes not synchronised, (33%)
- Expectations from clients really high, (7%)

Interviews was made with the student-teams in 2011 and 2012 and indicates:

- The biggest value is the contact with professionals and the way it supports students' understanding of their future profession.
- The industry connection ensures the relevance to the subject field of the course.
- The students can experience and understand the context of the problems they are dealing with and the setoff of the solutions they provide.
- Most important for the learning experience is the interaction with industry.

CONCLUSIONS

This hybrid PBL method using realistic role-play with industry clients and authentic problems in a course seems to provide a learning context for students that motivates them to deeply engage in the learning of disciplinary knowledge as well as train them and arise their awareness of professional skills. This approach requires a developed network with industry-partners the students are welcome enter. It's crucial to develop clear expectations and strong commitment from all involved partners. The teaching and learning situation become more complex while more actors are involved and when the context for learning expands out from university. This complexity and its consequences will be further investigated in our work. In order to prepare students for their future and train them in understanding the prerequisites for professional work using PBL and role-play as hybrid seems to be an interesting area to develop and explore further.

REFERENCES

Andersson, N, Andersson P "Teaching professional skills – Industry participation in realistic role play simulation" Proceedings of the 6th International CDIO Conference, École Polytechnique, Montréal, June 15-18, 2010.

Druckman, D. and Ebner, N., "Onstage or behind the scenes? Relative learning benefits of simulation role-play and design", *Simulation & Gaming*, SAGE Publications, Vol. 39, 2008, Issue. 4, pp. 465-497

Hadgraft RG, Kolmos A "Emerging learning environments in engineering education", *Australasian Journal of Engineering Education*, DOI: 10.1080/22054952.2020.1713522, 2020



Howell, C, Savin-Baden, M. Foundations of Problem-based Learning, McGraw-Hill Education, 2004.

Kolb, D Experiential Learning: Experience As The Source Of Learning And Development, Publisher: Prentice-Hall, ISBN: 0132952610, 1984

Kolmos, A, De Graaff, E, Xiangyun Du “Diversity of PBL – PBL Learning Principles and Models”, Research on PBL practice in Engineering Education, Brill, 2009

Shepard, L.A., “Formative assessment: Caveat emptor”. ETS Invitational Conference *The Future of Assessment: Shaping Teaching and Learning*, New York, October 10-11, 2005.

AUTHOR INFORMATION

Niclas Andersson, niclas.andersson@mau.se, Sweden, Malmö University (corresponding author)

Pernille Andersson, pean@plan.aau.dk, Denmark, Aalborg University (corresponding author)



HOW TO ASSESS KEY COMPETENCIES FOR SUSTAINABILITY IN ENGINEERING EDUCATION

Lena Gumaelius, Anders Rosén & Marc de Vries

ABSTRACT

The consideration and implementation of competencies in educational systems has been an integral part of the shift from input-oriented knowledge-based teaching to outcome-oriented competence-based learning, driven by the Bologna process, the CDIO initiative, and similar activities around the world. Such a shift builds on the idea that education should not only provide knowledge in itself, but also foster the development of competencies as interplays between knowledge, skills, and attitudes among the learners.

KEYWORDS: Competence, assessment, key competences, engineering education, sustainable development

TYPE OF CONTRIBUTION: Practice-based abstract

PRESENTATION FORMAT: Roundtable discussion

FULL ABSTRACT

The term key competencies is sometimes used to distinguish competencies of particular importance. Within Education for Sustainable Development (ESD) the so-called key competencies for sustainability are considered necessary for all learners to cope with the increasingly diverse and interconnected world and to enable them to contribute to the urgently needed transformations towards a sustainable society (e.g. de Haan 2010; Wiek et al. 2011; Rieckmann 2012). There is no general consensus on a specific set of key competencies for sustainability and the concept is still under development and debate (e.g. Shephard et al 2018). Some sort of convergence can however be seen, where key competencies for sustainability are generally considered to be cross-cutting, multifunctional, context- and domain-independent. UNESCO (2017) outlines the following eight key competencies for sustainability based on a compilation from the research literature: systems thinking competency, critical thinking competency, collaboration competency, anticipatory competency, normative competency, strategic competency, self-awareness competency, and integrated problem-solving competency.

Only a few examples of the consideration of key competencies for sustainability in engineering educations are found in the research literature. Some of these are mainly focusing on intended learning outcomes (e.g. Segalàs et al 2009, Rosén et al 2019). Others are focusing on teaching-learning practices which typically are learner-centred action-oriented learning approaches such as challenge-driven education, problem-based



learning, and case-based collaborative learning (e.g. Guerra 2017, Goncalves Quelhas et al 2019, and Högfeldt et al 2019). Thürer et al (2018) states that there is a need for more research and development on how to assess the learning of key competencies for sustainability, and that is the scope of the here presented study with a particular focus on engineering education (EE).

Our first research question was formulated as, ***RQ1: 'What approaches are used for assessing key competencies for sustainability in EE?'***. We started out by turning to the literature, conducting an initial literature review using the database Web of Science core collection (WoS). This database was selected as it is a broad database including the journals of interest both within EE and ESD. A first trial resulted in 7 articles, where none was relevant for giving any further information on approaches for assessment of key competencies. This result led us to the conclusion that not much research has been conducted in this field. A second research question was therefore formulated as ***RQ2: 'What approaches are used for assessing key competencies in other disciplines?'***. A broader literature review was therefore conducted, still by using the same database, WoS. Since our interest lies in how to assess the learning of competencies in project- and problem-based and challenge-driven courses, the study was expanded to also include project- and problem-based learning. In order to limit the search, six of the eight key competencies for sustainability were included. The search criteria were formulated as follows: 1) only journal papers published between year 2000 to 2020 were considered; 2) problem based learn*, project based learn*, competence*, PBL as well as assess*, measure* or evaluate* was present in the title; 3) system think*, collaborate*, critical think*, problem solve*, interpersonal or ethic* was mentioned in the abstract; 4) teach*, learn* or educate* as well as higher education*, college, university, post-secondary OR engineer* was mentioned in the abstract.

In this search, 193 articles were found. However, among these only four articles were identified that particularly focused on assessment of key competencies for sustainability within education, whereas the others considered the here targeted competencies either in more generic or subject specific terms. Still, out of the 193 articles, 147 were found to be relevant for this investigation. Those articles were divided into two fields: educational studies and other. The first field was further divided into three sub fields, one representing education in health care, one engineering education and the third one education in all other areas. Health care education was selected to be a sub field as the majority of articles represented this field, engineering was the second largest sub field and among the other education areas no one was represented by more than ten articles. A summary of this analysis is presented in table 1.

A priori analysis found that the number of publications each year, in the area of interest, increases over the years, and articles are seen to be most prevalent in journals representing education or health care.



Table 1. Summary of analysis

Fields	Sub fields	Number of relevant articles
Education	Health care education	61
	Engineering education	22
	Other education areas (teacher education, higher education, etc.)	46
Other	(Social work, health, psychology, veterinary, food related areas etc.)	18
Total number of relevant articles out of 193		147

A first reflection on the overall results is that the fields differed when comparing which competencies the articles considered. In health care education, there was a somewhat greater focus on collaborative skills as well as other different interpersonal skills than for the other fields, whereas in EE a focus was placed especially on problem solving. In all fields, critical thinking and ethics were found to the same extent. Many different approaches to assessment were used across all fields, questionnaires and surveys being most common. Other methods described were interviews, expert observations, online simulation of real cases and the use of certified tools, most often described as self-evaluation scales.

Somewhat surprisingly, the analysis does not say that the problem-based learning community has focused on examining assessment of competences, as only ten articles are about PBL and assessment of possible competencies. This observation is further strengthened by a review article, which is one of the 10 PBL articles in this study, which points out that studies which include theoretical frameworks or other rationales for how PBL constructs were assessed are lacking (Selland, 2009).

Even though there are quite a few articles in the subject area of EE, there is almost no examples of studies where established methodology for EE have been used. Out of the eight articles describing a specific tool for assessment, seven are about development/testing a new tool.

Health care education, especially nursing education, stands out as a field with significantly higher number of articles than the other fields. Perhaps even more interesting is that, for this field, a different pattern can be discerned when comparing the content of these articles with the articles representing other sub fields of education. When examining the articles that handle tools for assessment, the majority of the articles are about applying an already developed tool. Out of 27 articles dealing with tools for assessment 20 describes implementation, evaluation, or validation of the tools and only seven discuss the development of new tools.

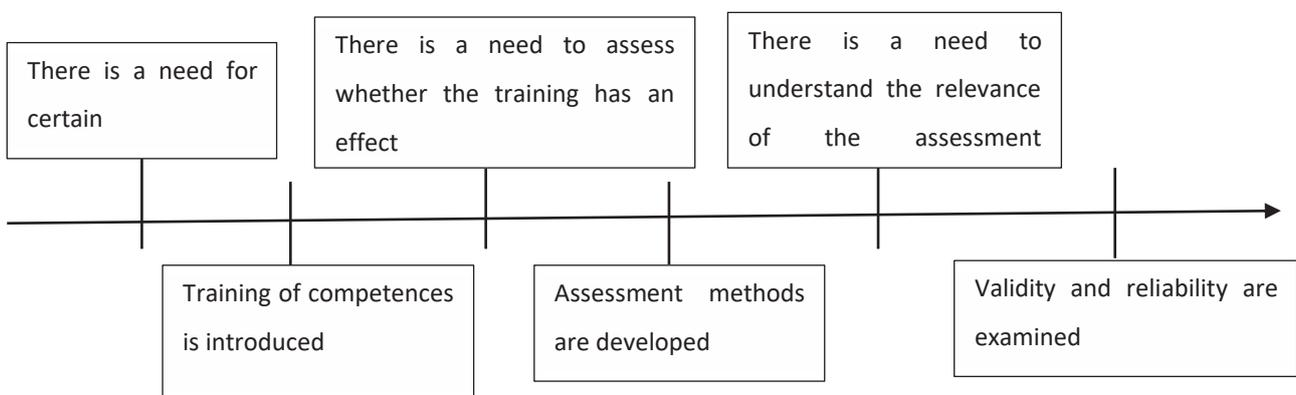
It should be noted that, due to the limitation of only using one database in this literature search, we are fully aware of the possibility that there are more fields that might have a well-developed understanding on assessment of competencies. Interesting fields we have not looked into are, for example, innovation and business studies as well as political science. To get an overall picture, it would be necessary to expand this



study to include more journals and conference proceedings, both in the areas we have studied, but also in completely different areas where the ability to act in a sustainable way is important.

The result further lead to the reflection on how the field of Engineering Education for Sustainable Development (EESD) can learn from other fields? Is it possible to transform any of the tools used in other education fields/areas? Can EE learn from how other areas work on assessment of competencies? Based on these reflections a third research question was formulated as, **RQ 3: ‘What research and development needs to be conducted in order to achieve a better consensus when it comes to assessing competencies?’**

Figure 1. Suggested development line for implementing competence learning in a specific subject area.



The third research question is up for discussion at a round-table discussion about strategies for developing assessment approaches for key competencies in different problem-, and project-based and other active learning settings in EESD. As a result of the analysis, the authors claim that it is possible to see a line of development for how competencies are implemented in education and other operations. The articles in this review reflect the different phases of this line of development (see Figure 1). It is primarily in healthcare education that the articles reflect the final development phase, ie where the relevance of the assessment methods used is discussed in a scientific manner (see figure 1.) To answer research question number three, we want to use this round table discussion to discuss how the results from this review article can be used to understand what progress should be made when moving towards a better consensus on how to assess different key competencies. The results presented in Table 1 together with the development line (Figure 1) will serve as a basis for this conference discussion.

REFERENCES

de Haan, G. (2010) The Development of ESD and Related Competencies in Supportive Institutional Frameworks. *International Review of Education* 56 (2&3), pp 315–28.

Goncalves Quelhas O L, et al. (2019) Engineering education and the development of competencies for sustainability, *International Journal of Sustainability in Higher Education*, Vol.20 No.4, pp.614-629.



Guerra A. (2017) Integration of sustainability in engineering education: Why is PBL an answer? *International Journal of Sustainability in Higher Education*, Vol.18, No.3, pp.436-454.

Högfeldt A-K, Rosén, A., Mwase, C., Lantz, A., Gumaelius, L., Shayo, E., Lujara, S. and Mvungi, N. (2019) Mutual Capacity Building through North-South Collaboration Using Challenge-Driven Education, *Sustainability* 11(24).

Rieckmann, M. (2012). Future-Oriented Higher Education: Which Key Competencies Should be Fostered Through University Teaching and Learning? *Futures*, Vol. 44, No. 2, pp. 127–135.

Segalàs J, Ferrer-Balas D., Svanström M. and Mulder K.F. (2009). What has to be learnt for sustainability? A comparison of bachelor engineering education competences at three European universities. *Sustainability Science*, Vol4, No.1, pp. 17-27.

Selland B.R., French F.F., Ertmer P.A. (2009) Validity and Problem-Based Learning Research: A Review of Instruments Used to Assess Intended Learning Outcomes. *Interdisciplinary journal of problem-based learning*. 3(1). doi.org/10.7771/1541-5015.1059

Shephard K, Rieckmann M, Barth M (2018). Seeking Sustainability Competence and Capability in the ESD and HESD Literature: An International Philosophical Hermeneutic Analysis, *Environmental Education Research*, DOI: 10.1080/13504622.2018.1490947.

UNESCO (2017). *Education for Sustainable Development Goals – Learning Objectives*, ISBN 978-92-3-100209-0.

Thürer, M., Tomasević, I., Stevenson, M., Qu, T. and Huisingh, T. (2018) A systematic review of the literature on integrating sustainability into engineering curricula, *Journal of Cleaner Production*, Vol.181, pp.608-617.

Wiek, A., Withycombe, L., Redman, C.L. (2011) Key Competencies in Sustainability: A Reference Framework for Academic Program Development. *Sustainability Science*, Vol. 6, No. 2, pp. 203–218.

AUTHOR INFORMATION

Lena Gumaelius, lenagu@kth.se, Sweden, KTH Royal Institute of Technology (corresponding author)

Anders Rosén, aro@kth.se, Sweden, KTH Royal Institute of Technology

Marc de Vries, M.J.deVries@tudelft.nl, Netherlands, Delft University of Technology



HABITAT HELP

Graziela Fuentes & Tarsila Cimino Carvalho

ABSTRACT

Our grade 4 Science design Project was based on researching about a local place that needed some improvement concerning its habitat. Students chose a local square near the school and planned a list of actions they could take in order to make a better place. Students were able to raise and apply hypothesis, anticipate problems, link knowledge from different disciplines with the reality, understand the consequences of their actions and finally promoting their ideas around school and community. It was an enriching project for their growth as learners and citizens.

KEYWORDS: citizenship, responsibility, cooperation, nature, city, local, teamwork, engagement, habitat, animals, plants, community, relevance, improvement,

TYPE OF CONTRIBUTION: Practice-based abstract

PRESENTATION FORMAT: Experience demonstration

INTRODUCTION

We would like to emphasize that all the teachers from Grade 4 got united to work on this project since one of our school's value is also to integrate and promote concepts such as respect, tolerance, citizenship and collaboration among the members of our community. Students collaboratively developed and carried out a plan to preserve, improve and restore a local habitat.

FIRST STEPS

First, they had to identify and choose a local place (habitat for animals and plants) that needed an improvement. So, during a week, students looked for places around our school. They found a local square close to school that they thought it needed some improvement (relevant for community/ problem-based learning/originality)

After that, we all went to check out this square, and there the students realized that the place needed to be clean (there was litter on the ground), needed more flowers (they thought about how important it is to have flowers for insects and bees) and the realized the toys for children needed to be painted. (problem-based learning/problem-solving).The science classes about habitat and communities enabled them to make connections between the theory and the real life and its real issues. With all in mind, students thought that



they could make the local square a better place for people, plants and some insects/animals that had that place as a habitat.

The big idea behind the project was to provoke some reflection and discussion among the students about how human actions would affect that habitat around school.

While designing a plan for the habitat, students considered all factors that allowed the plants and animals in the habitat to meet their needs as well as the consequences of their plan.

We divided the class into groups and each group focused in one thing to be done. Each group have made a list of suggestions for improving the habitat.

After each group discussed the possibilities, they made a table with their actions, advantages and challenges. In other words, the group in charge of planting flowers, defined the advantage as the appearance of more bees and the challenge as where to get the flowers and what kind of flowers was more suitable for the place. The groups were: planting flowers, cleaning and renewing the toys. Then a letter was sent home explaining the project and we asked parents if they could help us by donating materials (paint, flowers, tools). They were super enthusiastic, and we had lots of donations.

After we set all the groups, the students wrote a letter (use of English and writing for a real purpose) to the person responsible for maintaining the local square and asked if they could be responsible for the place for a month. The person went to our class to talk to the students and explain to them how he maintains and the reason which motivated him to do so.

After the conversation, in the following week the first group initiated the action plan for improving the local habitat. They planted more flowers in the ground. Every part of the project counted on with a volunteer coming from their families, so we had fathers, mothers, grandmas totally engaged with the students.

The next week, they went to clean the signs that were with scribbles and picked litter from the floor. (this group developed a tool to pick up the litter). They had the help from the school janitor and the used their STEAM knowledge to build up the tool. This tool building up moment was very rich since they had to try many different ideas and test them. The failure was part of their learning process. In the next week, the third group went to paint the toys. By doing that, students could notice with their own eyes the big difference they made for the local area.

THE FINAL MOMENT

In the last week of the project, the whole class went there together to celebrate their accomplishment with a picnic. They were amazed by the changes they made. They also invited the person responsible for the place



who couldn't believe his eyes when he saw the new place. Passing-by visitors also got impressed by the differences they could spot there. It was a very rewarding day.

ONGOING PROJECT AND LIFELONG PRESERVERS

After the project the students were engaged in maintaining the place and they started to discuss how this project could be applied in other local habitats of the city, and how important it is to think and preserve habitat. Therefore, they fully understood that the actions can affect the plants and animals that live in certain habitats.

AUTHOR INFORMATION

Graziela Fuentes, graziela.fuentes@escolabilingue.com, Brazil, Maple Bear Canadian School Vila Olimpia (corresponding author)

Tarsila Cimino Carvalho, tarsilascarvalho@gmail.com, Brazil, Maple Bear Canadian School Vila Olímpia



FROM THE PHYSICAL TO THE VIRTUAL AND EVERYTHING IN BETWEEN: LOCAL IMPLEMENTATIONS AND ADAPTATIONS OF PBL IN A MULTIYEAR MIDDLE SCHOOL / UNIVERSITY PARTNERSHIP

Krista Glazewski, Thomas Brush, Tarrence Banks, Scott Wallace, Cindy Hmelo-Silver, Bradford Mott & James Lester

ABSTRACT

One of the most formidable challenges when shifting teaching approaches toward PBL is lack of support for planning and enacting such practices in the classroom. Researchers have noted that sustaining changes in teacher practice is a guided process, and we need to support changes in practice that would accompany PBL vision. We argue that sustained change in teacher practice relies on a community context and sustain partnership that will support this change. In the context of an ongoing partnership, one university has engaged in sustained partnership with two middle school teachers for over five years to in ways that accommodate local adaptations of problem-based learning. In this practice-based demonstration, which will include both middle school teachers and university researchers, we highlight changes over the course of the five-year partnership and demonstrate specific PBL projects, which have spanned from physical table-top aquaponics systems to virtual game-based learning. We discuss features of the partnership and characteristics that have led to ambitious practices that enable robust implementations and accommodate local adaptation.

KEYWORDS: PBL in K12, Teacher Partnerships, Design Problem Solving, Sustaining PBL, Local Adaptation

TYPE OF CONTRIBUTION: Practice-based abstract

PRESENTATION FORMAT: Experience demonstration

INTRODUCTION

While problem-based learning (PBL) represents one pedagogy for supporting complex problem solving, research has documented several barriers toward adopting and sustaining PBL practice, particularly in K-12 contexts. One of the most formidable challenges when shifting teaching approaches toward PBL is lack of support for planning and enacting such practices in the classroom (Brush & Saye, 2017; So & Kim, 2009). Researchers have argued that this stems from lacking (1) a community of collaborators who would support quality instructional planning



and (2) a deep understanding of how to facilitate PBL with learners who may not be accustomed to assuming a more complex, active role (Bridges, 2019; Glazewski et al., 2014)

Researchers have noted that sustaining changes in teacher practice is a guided process, and we need to support changes in practice that would accompany PBL vision. Shulman and Shulman (2004) documented the connection between professional vision and teacher practice, and noted that movement between individual versus community units of analysis are critical for fostering sustained change. In other words, they place equal emphasis on community learning as on individual teacher learning, suggesting that sustained change in teacher practice relies on a community context and sustain partnership that will support this change (Glazewski et al., 2014).

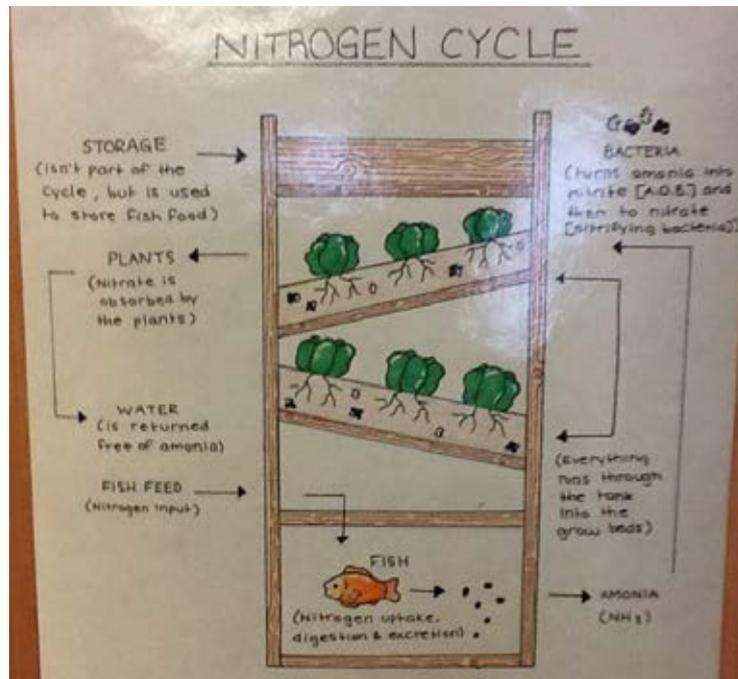
CONTEXT OF THE CURRENT PARTNERSHIP. In the context of an ongoing partnership, university faculty have engaged in sustained partnership with two middle school teachers for over five years to prioritize local implementations and adaptations of problem-based learning. The partnership in the classroom of two teachers from a unique local middle school in which the teachers taught all subjects with multiage students from grades 7 and 8 (60 students in total).

EARLY PHASE: THE AQUAPONICS INQUIRY IN 2015

The idea for the initial partnership was organized by one broad question over the course of the school year: *What do safe and sustainable food systems look like?* Because the teachers taught all content areas in their self-contained classroom, their unique context afforded the opportunity for extended study in PBL. Over the course of the school year, they asked about food, food systems, and food production. To meet standards and benchmarks in the Language Arts, students participated in literary analysis of *The Omnivore's Dilemma* by Michael Pollan, conducting inquiry related to food, where it comes from, and the ethics of consumption. In social studies study, the teachers engaged students in PBL inquiry related to questions of ethics and labor in food production. In science and math, students were given a design problem: *Design a self-sustaining, closed-loop aquaponic farming system that takes up the footprint of a classroom tabletop* (see Figure 1). After students planned and sketched ideas for their designs, they built conceptual models.



Figure 1. System sketch from one team.



This culminated in each of 10 different teams team building a functional aquaponics system (see Figure 2). Students exhibited a wide range of variability in their decisions regarding what to grow and sustain, supporting everything from bluegill fish to aquatic frogs, and growing a variety of herbs and vegetables. However, together we all also experienced struggle derived from balancing the tensions between cultivating success and supporting student agency. *How do we foster knowledge construction, and not just project building? Are we guiding students enough? Too much? What is our audience: the fish, the community, or both? And how do we fix all these problems the teams are having?* In our practice-based demo, we will explore these tensions and highlight the ways in which they surfaced and were addressed.



Figure 2. Functional aquaponics systems.



CURRENT PHASE: PARTICIPATORY CO-DESIGN WITH THE TEACHERS FOR VIRTUAL PBL

Most recently, our partnership has moved from the physical world to the online world. In this new context, we have engaged a process of participatory co-design with the teachers to support the construction of a virtual, game-based world. We combine the advantages of game-based learning with problem-based learning to achieve goals for virtual PBL inquiry. Centered around a common problem and immersed in a rich scenario, we seek to balance student agency with scaffolding and guidance. In this context, students enter the scenario, a fictionalized island in the Philippines that supports tilapia farming (see Figure 3), and their small group is enlisted to help observe, explore, and explain why fish might be dying at alarming rates (see Figure 4). In our co-design process with the teachers, we have sought to advance strategies to help students construct explanations, reason effectively, and become self-directed learners.



Figure 3. Orientation to the immersive PBL world.

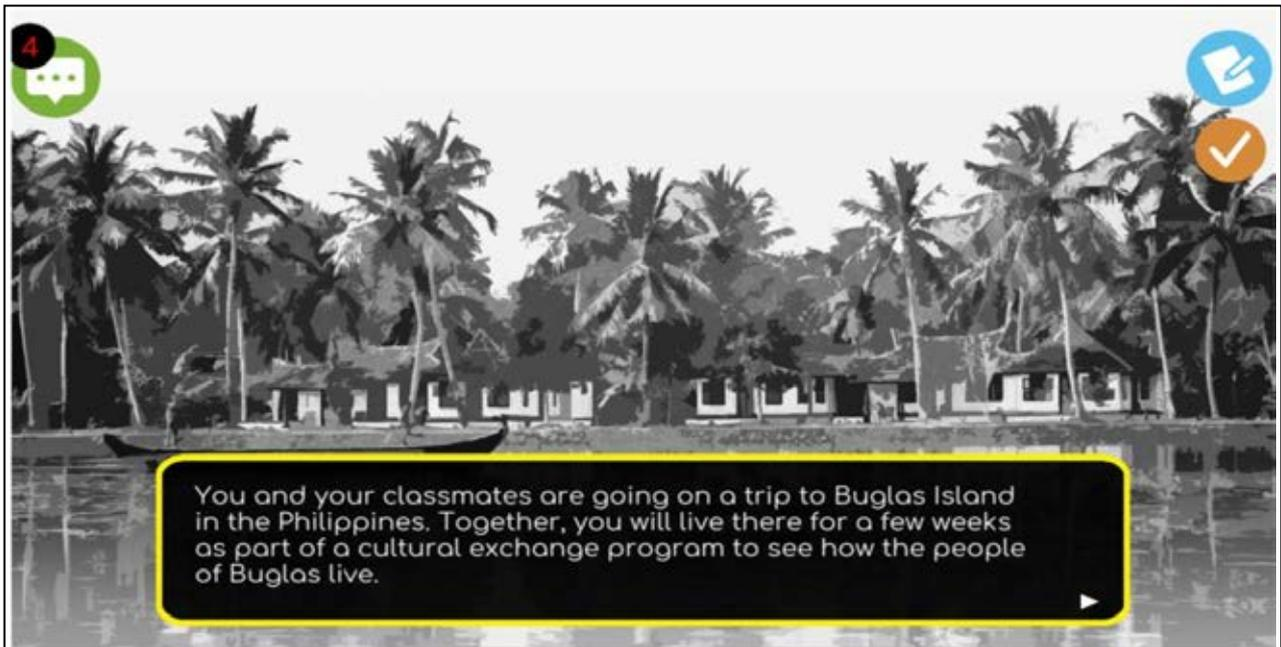


Figure 4. Students explore to observe, learn, and explain the mysterious fish death.



As such, in this practice-based demo, we will highlight the actions and interactions that enable students to cultivate collaborative learning competencies and support teachers in facilitating effective game-based learning. Key outcomes of the project include a model of collaborative scaffolding for game-based learning that is usable



in classrooms to help students learn STEM content and learning analytics designed to support the teacher in the roles of guide and collaborator.

SUSTAINED PARTNERSHIP FOR AMBITIOUS PRACTICES

The sustained partnership between the middle school teachers and university researchers has yielded a deeper understanding both of what can be done and how to do it. In this practice-based demonstration, which will include both middle school teachers and university researchers, we will discuss features of the partnership and characteristics that have led to ambitious practices that enable robust implementations and accommodate local adaptation.

REFERENCES

Bridges, S. M. (2019). Problem-based learning in teacher education. *Interdisciplinary Journal of Problem-Based Learning*, 13(1).

Brush, T., & Saye, J. W. (2017). *Successfully Implementing Problem-Based Learning in Classrooms*. West Lafayette, IN: Purdue University Press.

Glazewski, K., Michele, I., Brush, T., & Ellis, A. (2014). Conexiones: Fostering socioscientific inquiry in graduate teacher preparation. *Interdisciplinary Journal of Problem-Based Learning*, 8(1), 2.

Shulman, L. S., & Shulman, J. H. (2004). How and what teachers learn: A shifting perspective. *Journal of Curriculum Studies*, 36(2), 257-271.

So, H. J., & Kim, B. (2009). Learning about problem based learning: Student teachers integrating technology, pedagogy and content knowledge. *Australasian Journal of Educational Technology*, 25(1).

AUTHOR INFORMATION

Krista Glazewski, glaze@indiana.edu, United States, Indiana University (corresponding author)

Thomas Brush, tbrush@indiana.edu, United States, Indiana University (corresponding author)

Tarrence Banks, bankst54@theprojectschool.org, United States, The Bloomington Project School (corresponding author)

Scott Wallace, swallace@theprojectschool.org, United States, The Bloomington Project School (corresponding author)



Cindy Hmelo-Silver, chmelosi@indiana.edu, United States, Indiana University

Bradford Mott, bwmott@ncsu.edu, United States, North Carolina State University

James Lester, lester@ncsu.edu, United States, North Carolina State University



CASE STUDY AND JIGSAW COOPERATIVE LEARNING IN TEACHING OF HAZARDOUSNESS OF CHEMICALS

Manoela Guimarães, Denise de Castro & Lucas Guimarães

ABSTRACT

This study approaches the application of the case study method, in a group of middle school students from a technical course on occupational safety, in the discipline of Chemistry. The case stimulates decision forcing of the students when confectioning an educational leaflet about risk for chemical substances, to make employee aware of an oil refinery on the chemical risks. For the study of dangerous products, the Jigsaw classroom, teaching cooperative technique, was adopted during four meeting and the students had constructed concept maps about the dangerous substance class. The association of the active teaching methodologies provided an ambient interactive and motivator for the students.

KEYWORDS: Jigsaw Classroom. Case Study. Occupational safety.

TYPE OF CONTRIBUTION: Extended scientific abstract

PRESENTATION FORMAT: Interactive poster presentation

INTRODUCTION

This paper is part of an ongoing Master's research in Science Education. The main objective is to associate two active teaching methodologies in order to encourage students to take an active stance in the teaching-learning process, as well as being motivated to learn the subject in a cooperative way. The teaching methodologies are: Case Studies, a Strand of Problem-Based Learning and Cooperative Learning *Jigsaw*.

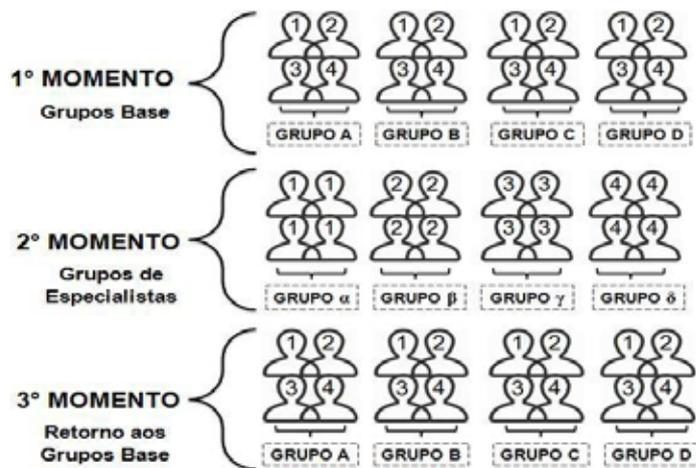
The Case Studies method is a variant of the Problem Based Learning method from the Problem Based Learning (PBL) method. It consists of the use of narratives of dilemmas experienced by individuals who need to make decisions about the problems faced (Sá & Queiroz, 2009).

The *Jigsaw* Cooperative Room is a strategy that was developed by Elliot Aronson to transform the competitive atmosphere among students into a cooperative environment. The solution identified was to structure the students into heterogeneous groups and to articulate them into different groups called: base groups and expert groups over three moments. The perspective during the process is that each student should learn the content



studied for themselves and be able to clearly explain to their classmates what was learned. Thus, all members are evaluated by reporting individually about the contents studied (Cochito, 2004). Figure 1 represents a detailed scheme of activity based on this cooperative learning method.

Figure 1 Schematic representation of activity based on the Jigsaw cooperative learning method. Source: Adaptado de Fatareli, Ferreira, Ferreira & Queiroz, 2010, p. 162.



COURSE METHODOLOGY

The research proposal consisted of the implementation of a case study in the chemistry discipline in a subsequent class of the occupational safety technician of a Federal Institution of the north of Rio de Janeiro state, located in Brazil. The target audience were 24 students who participated in four meetings mediated by a teacher.

The case narrates the work of safety engineer who works at the Petrobras company and organizes the Internal Work Accident Prevention Week (SIPAT), focused on discussions about the hazardousness of chemicals. This issue to be addressed arises from a fire that actually occurred at an oil refining unit in Duque de Caxias, Rio de Janeiro, due to a product leak from the unit. In this case, the engineer calls a meeting with the occupational safety technicians and asks everyone to plan, in group, a playful booklet to distribute to all employees of the company to raise their awareness. The booklet should address discussions regarding symbols, chemicals, characteristics, accidents and prevention of the following hazardous product classes: flammable, corrosive, oxidizing, toxic and explosive. At the end, students are encouraged to study the hazardousness of chemicals involved in oil refining and take the position of the occupational safety technician to develop a playful booklet



that is interactive with the reader. For the study of hazardous product classes, the Jigsaw Cooperative Learning Room, developed by Elliot Aronson, was adopted during four meetings with the class

This cooperative learning method is highly structured and its dynamics require interdependence among the students, who all actively participate in the development of the proposal. In the first meeting, after reading the case, the students gathered in basic groups for individual reading of a material on the hazardousness of chemicals. At the second meeting, students drawn to the expert groups discussed specific topics, and each expert group made a commitment to understand a subtopic of the hazardous product classes in detail and constructed a concept map. At the third meeting, the students returned to their home groups and an exchange of knowledge occurred when each member of the home group shared the concept map. During the third meeting, the grassroots groups shared ideas on the elaboration and presentation of the playbook. At the fourth meeting, all groups presented their booklets to solve the case.

FINDINGS AND DISCUSSIONS

At the first meeting of the base groups, the students had an initial and general view of the subject to be learned from reading an article that reported the working conditions on the oil rigs. The text exemplified cases of accidents and fires caused by hazardous substances, such as leaks of flammable gases or highly toxic substances. By reading the text, the students could recall some cases of platforms that were victims of accidents. At this moment, students' interest was identified, as they questioned their doubts and were using text markers to highlight, which in their view was essential for future discussions of their subject.

At the expert group meeting, students should differentiate the subject topics in more detail and specificity. During the construction of the concept maps, a motivation of the groups was observed and a negotiation of concepts took place between the members. Information was shared, students presented their thoughts, discussed about the ideal keywords to compose the concept map, and answered their doubts with the teachers throughout the process. The researcher positioned herself as a mediator during the activity and was willing to clarify all doubts questioned by the students.

For the construction of the concept maps, the members were advised to return to the more general, intermediate and specific aspects of their specialist topic. The third meeting, marked by the students' return to base groups, was characterized by a brief oral presentation of the expert concept map. At this time, there was an exchange of knowledge in an integrative perspective, there for, each student explained their topic, so that



everyone understood the processes involved in the water treatment plant. At the end, the grassroots groups discussed possible tools that could make up the primer that would be presented at the last meeting.

In the last meeting, the five playful booklets made by the five base groups was presented. Digital booklets were presented within 20 minutes by each base group. The students clarified why they chose a specific resource to deal with the hazardous substances hazard issue and how they did the activities. The students performed some activities of the booklet with the class during the presentation of the booklet. The proposals presented were: crossword puzzles, word search, dominox, curiosities, myth and truth and memory games.

It was observed that most of the students demonstrated domain of the subject, as they were able to explain the content safely and in detail, as well as showing excitement in conducting classroom hobbies.

FINAL CONSIDERATIONS

The data analysis shows that the didactic proposal is viable. Regarding the Case Study method, it is emphasized that its application at the beginning of the class acted as a stimulating resource to the students. They have committed a responsibility to study and understand the issue of substance hazard in a cooperative manner and to act as an active agent in class.

The use of Jigsaw co-operative learning room dynamics provided an interactive environment in which students shared knowledge, accepted opinions put to the group, some questioned, and others resolved the questions that arose, there for, there was a knowledge exchange. Each member assumed an individual responsibility in an active and participatory manner, which all contributed to the progress of the activities.

It was identified that the concept map is a learning resource that can be used as a learning assessment instrument, because it enables the student to externalize their interpretations when creating their concept map. At this time, there is an opportunity for students to communicate with each other and exchange ideas during their explanations of the map. Regarding the presentation of the base groups it was identified that most of the students demonstrated a mastery of the subject explained, because they were able to explain the content safely and in detail. Creativity was also identified in the works.

REFERENCES

COCHITO, M. I. G. S. *Cooperação e aprendizagem: educação intercultural*. Lisboa: ACIME, 2004. Disponível em: <http://cidadaniaemp Portugal.pt/wp-content/uploads/recursos/cooperacao-e-aprendizagem.pdf>.

FATARELI, E. F.; FERREIRA, L. N. A.; FERREIRA, J. Q.; QUEIROZ, S. L. Método Cooperativo de



Aprendizagem Jigsaw no Ensino de Cinética Química. *Química Nova na Escola*, v. 32, n. 3, p. 161-168, 2010.

SÁ, L. P.; QUEIROZ, S. L. *Estudo de casos no Ensino de Química*. Campinas: Editora Átomo, 2009

AUTHOR INFORMATION

Manoela Barros Guimarães, manoela_bg@hotmail.com, Brazil, IFRJ (corresponding author)

Denise Castro, denise.castro@ifrj.edu.br, Brazil, IFRJ (corresponding author)

Lucas Peres Guimarães, lucaspegui@hotmail.com, Brazil, IFRJ (corresponding author)



STUDENT REACTIONS TO SIMULTANEOUSLY FLIPPING ALL COURSES ON A SEMESTER

Jon Ram Bruun-Pedersen, Nanna Svarre Kristensen, Lise Busk Kofoed & Lars Birch Andreasen

ABSTRACT

Many universities have embraced flipped learning methods, as they provide opportunities for increased student interaction and deeper engagement with material important for students' learning processes. Flipped learning appears to be particularly well suited to engineering education, because of its potential to combine theories once thought to be incompatible, with active and problem-based learning (PBL) activities based on a constructivist ideology and instructional lectures. Based on this, it was decided to simultaneously flip all courses on the 4th semester of a BSC Medialogy programme, and to support the integration of courses and semester projects better to improve students' learning. Teachers and students had to, respectively, change their previous teaching approach and learning environment. This paper highlights the challenges and experiences of students, including their recommendations for future iterations of the semester - especially in relation to the coordination and coherence of the semester, the approach to flipped learning, and the connection between courses and projects.

KEYWORDS: PBL, Flipped semester, Integrating courses and projects, Student perspectives

TYPE OF CONTRIBUTION: Extended scientific abstract

PRESENTATION FORMAT: Interactive poster presentation

Many universities have embraced flipped learning methods, as they provide opportunities for increased student interaction and deeper engagement with material important for students' learning processes (Johnson et al. 2015). Flipped learning appears to be particularly well suited to engineering education, because of its potential to combine active and problem-based learning (PBL) activities based on a constructivist ideology and instructional lectures (Karabulut-Ilgu et al. 2018). At Aalborg University (AAU) there have been several studies of courses using flipped classroom, flipped learning, and blended learning approaches. Teachers and students have different experiences, which vary with regards to structure, learning outcome and (time) resources needed (Triantafyllou et al. 2016; Bertel & Svarre Kristensen 2018).

As part of forming the future directions of PBL practice at AAU, one research group has specifically focused on the flipped learning approach for courses and improving the integration of those courses into students' semester projects. In spring 2019, the research group developed a new concept for the 4th semester at the



Medialogy BSc programme, in collaboration with teachers - a 'flipped and integrated semester', where all courses applied flipped learning, and integrated the students' project work into their teaching (Kofoed et al. 2018).

The engineering education at 4th semester of Medialogy in Aalborg University Copenhagen consists of three 5 ECTS courses and a 15 ECTS semester project. The academic theme of the 4th semester is 'Sound Computing and Sensor Technology'. Compared to previous semesters' course curricula, this semester relies more on math and programming. Internal AAU data shows that many students fail the ordinary course exams, and empirical survey data show that students generally consider 4th semester a difficult semester (Kofoed et al. 2018).

By removing traditional lectures in the classroom and initiating more active in-class activities, the flipped learning approach should create more flexibility in how to approach the learning objectives and give time for integration activities. Strategies to succeed included increasing the communication within the teacher group, developing joint teaching activities, framing student activities within course- and project-integrated themes, and activities where students received supervision from several supervisors simultaneously.

The flipped and integrated semester was based on previous student and teacher surveys, interviews as well as theoretical studies on motivation and scaffolding (Svarre Kristensen et al. 2020). In the following we will present and discuss an empirical dataset from students' final evaluation questionnaire for the 4th semester (given after the exams), including their recommendations on upcoming iterations of this structure. 40 of 60 students responded to the questionnaire.

RESULTS FROM THE SURVEY

The semester in general were given some positive reactions including an overall appreciation of the entire span of the courses, including the teaching method applied by teachers and coordinators (both for lectures and workshops), as well as an impression of very capable and engaged teachers.

Critical points were also voiced, referring to a lack of consistency and structure to the application of the flipped learning approach for two of the courses, but also that an overly tight schedule, overwhelming lecture preparation, and too many topics covered in courses could cause a stressful experience. Another criticism was a perceived lack of coherence between the lecture curriculum and exam requirements.

Looking into the details, **the provided homework preparation material**, given prior to in-class activities, was perceived to be well chosen by some students, spread out through the courses. Others criticised some content being boring, unclear what parts were most important, some material not produced by the teachers



themselves, and material was inadequate to understand the in-class activity, or not applied in the following in-class session.

The in-class activities themselves were considered fruitful for the understanding of the lecture content by a certain sum of students, differentiating in rank between the courses. Compliments included good balancing and sense between preparation and in-class activities, when sessions included a good introduction to the prepared material and the expected application during the in-class exercises, and when considerations or practical work for the semester project was incorporated into the in-class sessions. Student critique included when in-class sessions were a repetition of homework preparation, if the relation between preparation material and in-class activities was too abstract or difficult to transfer, and if in-class exercises were too difficult (e.g. compared to the preparation material).

In terms of difficulty, student responses referred to how a clear structure between homework, teaching and the vision of the course in general, helped the difficulty level in one of the courses feel balanced. Lack of structure made students estimate the difficulty as either very easy or very difficult. Also, in cases of an abstract or unclear transfer of the preparation material content into in-class sessions, students generally perceived lectures to be very difficult. In these cases, students requested more in-class step-by-step explanations and practical examples of homework application. This perception of high difficulty was also related to lacking structure, in cases when exam assignments did not reflect learning students experienced from the preparation material or in-class exercise sessions.

For students' perceived learning outcome, students reported a high learning outcome for coursework with clear structure, in-class processes that were well planned with clear goals, and which included the initiating coverage of the homework preparation content in each in-class session before exercises, ensuring the correct perspective for students. Ratings were lower when this was not in place, including if the material or in-class sessions were too abstract, too high-level, without a clear purpose or connection between homework and in-class.

In one course, the coursework structure was gradually optimized during the semester, going towards the approach recommended by students. Interestingly, students reported that their highest learning outcome arrived at very different phases of the course, and through very different activities (e.g. while self-studying, during an in-class activity, through homework preparation, or even as late as the exam preparation itself).

From the data, it is clear that there are some central tendencies to whether teachers were successful, in their specific approach to implementing flipped learning on their courses. Overall, a minority of students expressed an overall positivity towards the flipped learning semester-initiative, and the issues described above clearly



shows that those less successfully applied flipped learning methods have resulted in negative consequences on students' overall experience of the semester. Much of the criticism builds on problems with coordination, structure, coherency and planning. This echoes when looking at the student's final recommendations.

CONCLUSION AND PERSPECTIVES

In their final recommendations, students generally in relation to *the overall semester and course structure* requested a clear relationship between courses and the semester project. Having cross-course workshops are perceived very useful for integrating courses and project work. In relation to *semester planning and preparation*, the semester should feel like a well-planned, clearly structured whole. This includes a clear progression through the courses, an overview of the entire semester, and better communication across courses, especially on assignments and increased workload phases, in order to avoid overlap.

Students stated the need of developing a *consistent and logical flipped learning approach*, where courses should apply a coherent approach to the utilization of the flipped approach. A clear connection between homework preparation material and in-class activities creates motivation for preparing from home, utilizes the flipped classroom format well, and increases learning. During in-class sessions, students value introductory in-class clarification before starting the activities, and recommends using smaller assignments that can be finished in a reasonable amount of time.

The students' recommendations are very useful pointing at some pedagogical and structural aspects, which the teachers might be able to use in their next iteration of the 4th semester, especially the coordination of the semester, the connection between courses and projects, and communication showing the coherence of the semester.

ACKNOWLEDGEMENTS

The research was supported by Aalborg University and the Obel Family Foundation as part of the research project "Future directions of PBL in a digital age".

REFERENCES

Bertel, L.B. & Svarre Kristensen, N. (2018). Student Engagement and study intensity in Flipped PBL Curriculum and Blended Learning Activities. In *7th International Research Symposium on PBL: Innovation, PBL and Competences in Engineering Education* (pp. 116-125). Aalborg Universitetsforlag.

Johnson, Adams Becker, Estrada, & Freeman (2015). *NMC Horizon Report: 2015 Library Edition*. Austin, Texas: New Media Consortium.



Karabulut-Ilgü, A., Jaramillo Chérrez, N., & Jähren, C.T. (2018). A systematic review of research on the flipped learning method in engineering education. *British Journal of Educational Technology*, 49(3), 398- 411.

Kofoed, L. B., Svarre Kristensen, N., Andreasen, L. B., Bruun-Pedersen, J. R., & Høeg, E. R. (2018). Integrating courses and project work to support PBL – a conceptual design for changing curriculum structure. *7th international Research symposium on PBL: Innovation, PBL and Competences in Engineering Education*. Aalborg Universitetsforlag.

Svarre Kristensen, N., Busk Kofoed, L., Bruun-Pedersen, J.R., & Andreasen, L.B. (2020). Flipped Learning in a PBL Environment – An Explorative Case Study on Motivation. *The European Journal of Social and Behavioural Sciences*, 27(3), 3084-3095.

Triantafyllou, E., Busk Kofoed, L., Purwins, H., & Timcenko, O. (2016). Applying a learning design methodology in the flipped classroom approach – empowering teachers to reflect and design for learning. *Tidsskrift for Læring og Medier (LOM)*, 9(15), 1-21.

AUTHOR INFORMATION

Jon Ram Bruun-Pedersen, jpe@create.aau.dk, Denmark, Aalborg University (corresponding author)

Nanna Svarre Kristensen, nsk@create.aau.dk, Denmark, Aalborg University

Lise Busk Kofoed, lk@create.aau.dk, Denmark, Aalborg University

Lars Birch Andreasen, lba@hum.aau.dk, Denmark, Aalborg University



SUSTAINABILITY AT THE HEART OF 21ST CENTURY LANGUAGE LEARNING THROUGH STUDENT CENTRED METHODOLOGIES: A DIDACTICAL PROPOSAL

Ana Paiva

ABSTRACT

The planet's urge for sustainable development requires a new educational paradigm. Experts on the future of education and the 21st century skills (UNESCO 1996; UNESCO 2017; Council of the EU 2018; OCDE 2019) are unanimous regarding the need to transcend the current mechanisms of pure knowledge transfer into others (Bowen, C.M. 2020) that put in practice what makes us different from robots. These competences, so intrinsically human are also the ones essential for individuals to act on their societies to change and transform them into more sustainable communities having a positive impact on their environment and socio-economic ecosystem (UNESCO 2009).

The author of the present study proposes the use of the Sustainable Development Goals [SDGs] (UN, 2015) and the EU Youth Goals (Council of the EU, 2018) as frameworks to build student-centred didactical proposals through small projects (PBL) within the Portuguese as a Foreign Language class and improve student participation in societal challenges.

This proposal emerged from a practical experience as reader of Portuguese Language in the University of Salento, Italy which paved the way for an action-research methodology that will be explained in this study. The investigation itself is based on three different didactic experiences revealing that there is still a long way to go in what learning experience design and Education for Sustainable Development is concerned.

KEYWORDS: Portuguese as a Foreign Language, Active Learning Methodologies, Learning experience design, Education for Sustainable Development, Sustainable Development Goals

TYPE OF CONTRIBUTION: Extended scientific abstract

PRESENTATION FORMAT: Interactive poster presentation

FULL ABSTRACT

The 21st century brings new challenges and opportunities for the planet's sustainable development that imply a new educational paradigm.



Several policy papers on the future of education and the 21st century skills (UNESCO 1996; UNESCO 2017; Council of the EU 2018; OCDE 2019) are unanimous regarding the need to transcend the current mechanisms of pure knowledge transfer into others (Bowen, C.M. 2020) that put in practice what makes us different from robots. These competences, so intrinsically human (critical thinking, communication, decision-making, negotiation, empathy, responsibility taking, creation and innovation, etc.) are also the ones essential for individuals to act on their societies to change and transform them into more sustainable communities having a positive impact on their environment and socio-economic ecosystem (UNESCO 2009).

According to UNESCO (2017), Education for Sustainable Development should be integrated in the curricula of all study levels from primary to higher education and be at the centre of teaching and learning experiences. Researcher Aida Guerra talks about the “need to develop frameworks, tools and approaches to bring sustainable development ‘to action’ and part of everyday life.” (2014: 28)

The foreign language classroom can cover a variety of topics through theme-based instruction (Jacobs, G. & Kip, C. 1999:5) and has potential to implement more successfully Education for Sustainable Development (Read, C. et al. 2017: 11).

The author of the present study proposes the use of the Sustainable Development Goals [SDGs] (UN, 2015) and the EU Youth Goals (Council of the EU, 2018) as frameworks to build student-centred didactical proposals through small projects within the Portuguese as a Foreign Language class.

The study has the following aims:

- Determining the potential contribution of the Foreign Language Classroom to create fairer and more sustainable societies.
- Building the case for the inclusion of Education for Sustainable Development themes in Portuguese Foreign Language classes through the organization of activities in the classroom that include for example interculturality, creativity, agricultural entrepreneurship, employability or sustainable tourism.
- Combining essential lifelong learning individual competencies with communicative competences during the foreign language classroom.
- Promoting the use of student-centred teaching methodologies such as Project Based Learning.

The idea behind this paper emerged after a practical experience as reader of Portuguese Language in the University of Salento, Italy which paved the way for an action-research methodology that will be explained in this study.



To outline the Problem Based Learning [PBL] activities, the study departs from other experiences of applying SDGs to teaching material.

One of these is the World's Largest Lesson which is an international campaign implemented by UNESCO and UNICEF with the national governments whose goal is to promote SDGs in schools from primary to secondary education. In Portugal, UNICEF made available to professors a free access toolkit in European Portuguese with materials to be applied in multidisciplinary contexts. These materials do not exist to be applied specifically to the Portuguese as a Foreign Language Classroom but can be adapted.

The second example is a British Council publication (2017) that is organized in 22 chapters in which various authors propose activities to develop in the language classroom having as bases the 17 SDGs. Carol Read, one of the authors, considers that using SDGs to teach a foreign language, has an impact on empowering learners (particularly in early-childhood) by fostering creativity, responsibility, critical-thinking, negotiation and problem-solving skills, tolerance, and mutual respect among others. Besides language competences, teaching through these global goals, provides possibilities to work on an important set of attitudes, beliefs and values fundamental for social cohesion.

The third example is the materials of a presentation that integrated an event organized at the Faculty of Arts of the University of Porto, Portugal (2020): *Education for Sustainable Development and Teaching of Portuguese as a Non-Native Language* (Carvalho, A & Pessanha Isidoro, P.). These materials included lesson plans that used SDGs to organize didactical units with the goal of developing language competences including sociocultural, intercultural and environmental competences and respective learning outcomes given specific SDG targets. In the lesson plans presented it was identified the use of action words such as *negotiate compare, debate, dialogue, decide, choose, explore or analyse* intertwined with tasks such as grammatical concepts, reading of texts or fill-in blanks exercises.

It is worth mentioning that the presenters defended that the use of SDGs in the classroom should take a non-judgemental stance, that it should not be considered as a moralization instrument but a practical tool to inform, reflect and transform people and societies. In this spirit, all opinions (even if opposing the SDGs) should be welcomed and regarded as enriching for the discussion.

These specific study-cases were chosen as they offer three different perspectives in terms of:

- 1) Format:
 - a. The World's Largest Lesson (WLL) is an international campaign implemented by governmental agencies in schools but not in Higher Education;



- b. The British Council (BC) publication is applicable to language learners per study level and is organized by an institution in charge of promoting English as a second language;
 - c. The materials of the sustainable development event held at the Faculty of Arts of the University of Porto (FLUP) were more directly targeting higher education students
- 2) Disciplinary approach:
- a. The WLL materials have a multidisciplinary approach (can be used for different disciplines including foreign language);
 - b. The BC publication is applicable to English as a foreign language.
 - c. The materials of the sustainable development event held at FLUP were adapted specifically to Portuguese as a Foreign Language
- 3) Learning outcomes:
- a. WWL provides a set of more general learning objectives,
 - b. BC publication includes aim, language, SDG and creative focus.
 - c. Material from FLUP event: is very specific on exact language competences and embeds the other dimensions (environmental awareness, sociocultural and intercultural) in the linguistic dimension without compartmentalize them.

AN ALTERNATIVE DIDACTICAL PROPOSAL USING SDGS AND OTHER GOALS

PBL experiences in this context are designed to create a “meaningful instruction” atmosphere in which “language learners engage in meaningful tasks where they use language for real purposes.” (Mukulec e Miller 2011: 82) This will be combined with the three previous best practises. Here is one example of a language project proposal designed by the author:

Figure 1. Example of a language project proposal designed by the author.

Lesson Plan: Discovering SDGs	
Level: A2 +/B1	
Duration: 60 min.	
1	The professor shows the UNICEF video campaign – The World’s Largest Lesson: https://ensina.rtp.pt/artigo/a-maior-licao-do-mundo-os-objectivos-globais/ [duration: 00:04:39 - in PT]
2	Asks the students to note down the hints given by the narrator to reach the “Global Goals” in their day-to-day. -Shows the pictures of the 17 SDG in the black board or in a poster



3	The students present (orally) 2 practical actions indicated in the video to reach the “SDG” and debate with their group colleagues about self-knowledge questions.
4	1) What moves you? 2) What is really important for you? 3) What are the global matters that most concern you? 4) What could change your life to improve these global matters?
5	In groups, the students prepare a summary-list with all the answers. Later there is an open dialogue to all class about each student options.
Discovering SDGs – Classroom Project	
To keep on exploring:	
Invite students to organize a Reading Club (annual project) with books whose themes they have to classify according to SDGs. The 17 SDG and 11 Youth Goals are distributed randomly among the class (depending on the number of elements), each student proposes a book/reading related to their goal.	
After reading each extract there will be space for Q&A. Vídeo PNL 2027 about the organization of reading clubs: https://www.youtube.com/watch?v=9Ev9HI6-GYk [in PT]	

The poster presentation will include both the design making process behind these exercises as well as expected outcomes for the implementation phase.

CONCLUSIONS

The production of didactical materials for Foreign Language teaching including themes of Sustainable Development should be encouraged, particularly in countries where these are less disseminated.

The next step will be to implement and monitor the application of the designed materials, as well as assessing if these provide support to professors in the road to a “transformative learning” through “transformative pedagogy” that challenges constantly and empowers the students beyond the simple knowledge transmission, inspired in the model of school envisioned by Paulo Freire, the power to think, understand and transform the world, through radical thinking and knowledge-production. (UNESCO 2017)

REFERENCES

Bowen, C. M. (2020). Interdisciplinary PBL Course Development in Higher Education. *Journal of Problem Based Learning in Higher Education*, 8(2).



Carvalho, A., & Isidoro Pessanha, P. (2020) Material: *Educação para o Desenvolvimento Sustentável e Ensino de Português Língua Não Materna Reflexões e Propostas* Faculdade de Letras da Universidade do Porto, Portugal.

Guerra, A. (2014) *Problem Based Learning and Sustainable Engineering Education - challenges for 21st century*. PhD Thesis. Aalborg University (DK)

Jacobs, George & Kip, Cates. (1999). *Global Education in Second Language Teaching* - Volume 1, Number 1, December 1999: 1-8

Maley A, Peachey N. (2017) *11 Integrating global issues in the creative English language classroom, With reference to the United Nations Sustainable Development Goals*. British Council.

Mikulec, Erin; Miller, Paul Chamness. (2011) *Using Project-Based Instruction to Meet Foreign Language Standards*. *Clearing House: A Journal of Educational Strategies, Issues and Ideas*, v84 n3 p81-86

OECD (2017) – *Report on Teaching for the Future: Effective Classroom Practices To Transform Education*, Qudwa Global Teachers' Forum, organised by the Crown Prince of Abu Dhabi on 7-8 October 2017. Available at: https://read.oecd-ilibrary.org/education/teaching-for-the-future/how-can-we-support-teaching-strategies-for-21st-century-learners_9789264293243-6-en#page16

OECD (2019) – *Future of Education and Skills 2030, Conceptual Learning Framework, Transformative Competencies for 2030*. Available at: [https://www.oecd.org/education/2030-project/teaching-and-learning/learning/transformativecompetencies/Transformative Competencies for 2030 concept note.pdf](https://www.oecd.org/education/2030-project/teaching-and-learning/learning/transformativecompetencies/Transformative%20Competencies%20for%202030%20concept%20note.pdf)

UNESCO (2009) *Education and the search for a sustainable future*. Policy dialogue: ESD and development policy, 1. Available at: <https://unesdoc.unesco.org/ark:/48223/pf0000179121.consultadoemJulho2020>

UNESCO (2017) *Educação para os Objetivos de Desenvolvimento Sustentável objetivos de aprendizagem* Assistant Director General for Education, 2010 2018 (Qian Tang) Available at: <https://unesdoc.unesco.org/ark:/48223/pf0000252197>

AUTHOR INFORMATION

Ana Paiva, anacastroaiva@gmail.com, Portugal, Universidade do Porto (corresponding author)



Education management PBL and active learning



PERCEPTIONS ABOUT TUTORING PROCESS AND CURRICULUM CONTENTS AMONG PBL GROUPS OF MEDICAL STUDENTS: DOES IT IMPACT ON FINAL GRADES?

Flávio Augusto Naoum, Felipe Pacca & Patrícia Cury

ABSTRACT

Introduction: Student's feedback is essential to assess many aspects that compose the learning process in PBL groups, although its relationship with performance is not always clear. This study sought to evaluate PBL groups perception from the student point of view on curriculum contents and tutorial process, and its relationship with performance.

Methods: An end of module (EOM) form using a five-point Likert scale on eleven questions about module content and tutorial process was filled by medical students from 1st to 4th year PBL groups. Mean scores at EOM form and their correlation with the final grades were analyzed in all PBL groups and also, separately, in basic sciences (1st and 2nd years) and clinical medicine (3rd and 4th years) PBL groups.

Results: 428 medical students from 48 PBL groups completed the EOM form. Scores for questions about tutoring process were higher than those related to module content. In basic sciences PBL groups, scores for curriculum content comprehension and self-study were lower as compared to clinical medicine groups (2.6 vs 3.3, $p < 0,01$ and 3.4 vs 3.7, $P < 0,01$; respectively). Final grades were negatively correlated to faculty resources ($r = -0,314$; $p = 0,036$). Groups with higher scores (Likert scale ≥ 4) for acknowledgement of content relevance and self-study presented better final grades than those reporting lower scores for these questions (7.8 vs 7.5, $p = 0,013$ and 8.1 vs 7.7, $p = 0,025$; respectively).

Conclusion: Medical students had better perceptions on PBL process as compared to curriculum content, although the former was not predictive of performance. Basic science PBL groups had impaired awareness of curriculum relevance on medical education and adequacy of self-study.

KEYWORDS: PBL, PBL groups, Perception, Performance, Questionary

TYPE OF CONTRIBUTION: Full scientific paper

PRESENTATION FORMAT: Interactive paper presentation



INTRODUCTION

Active learning methodologies are highly dependent on feedback, both from faculty members and students (Hendry, Lyon, Prosser, & Sze, 2006). The information gathered from feedback impressions can be used for a variety of purposes, such as continuous curriculum development and improvement of teaching practices and methodology (Harden, 2018)

Also, measuring students perceptions both before and after exposure to increased clinical practice and reasoning, as well as tests and examinations, can allow institutions to compare changes in content and learning environment aspects as students advance in their physician training (Skochelak et al., 2016)

Commonly, questionnaires filled out by medical students are employed to assess the quality of the learning process, but the information gathered relies largely on subjective impressions that can be influenced by personal, emotional, demographic or circumstantial aspects. (Ganguly, Faulkner, & Sendelbach, 2019; Das Carlo, Swadi, & Mpofo, 2003). Evaluating group - rather than individual - impressions can minimize the influence of such aspects. Also, the assessment of the impact of these impressions on student’s performance can provide a glance of which aspects are related to a more effective learning.

The aim of this study was to evaluate PBL groups impressions on module contents and tutoring process from the student perspective, and its impact on performance.

METHODS

At Faceres Medical School, each module comprehends a 6-week period of tutoring sessions on a thematic area, followed by a summative assessment that is put together with formative assessments to build up the final grade. Data regarding student’s impressions on module contents and tutoring process were collected from 428 end of module evaluation (EOM) forms, filled by 1st to 4th year medical students, allocated in 48 PBL groups, using a five-point Likert scale on eleven questions related to module content and tutoring process (**Table 1**).

As the students filled the EOM form anonymously, the analysis could only be performed on a PBL group basis, rather than individually, so that a mean score for the questions at EOM form along with the mean final grades were obtained for each PBL group.

Table 1. End of module evaluation form, composed by eleven questions related to module content and tutoring process.

END OF MODULE EVALUATION					
<i>Module content</i>	Not at all	A little	Rather	Yes	Very much



Q1	Overall, did you enjoy the module?	1	2	3	4	5
Q2	Did you find the module content interesting?	1	2	3	4	5
Q3	Was it easy to understand the module content?	1	2	3	4	5
Q4	Did you realize the importance of the module on your medical education?	1	2	3	4	5
Q5	Overall, do you think you studied adequately for this module?	1	2	3	4	5
Q6	Did the library provided adequate bibliography for this module?	1	2	3	4	5
Tutoring process		No	A little	Rather	Yes	Very much
Q7	Was your tutor punctual?	1	2	3	4	5
Q8	Did your tutor encouraged students to use chart diagrams?	1	2	3	4	5
Q9	Were the learning objectives of the module problems clear to you?	1	2	3	4	5
Q10	Did the tutor let students lead the discussions?	1	2	3	4	5
Q11	Was the mood for teamwork among students good along the module?	1	2	3	4	5
	What was your tutor's name? _____					

Mean scores at EOM form and their correlation with the final grades were analyzed in all PBL groups and also, separately, in basic sciences (1st and 2nd years) and clinical medicine (3rd and 4th years) PBL groups.

The unpaired t-test was used to compare score means at EOM form. Spearman's rank correlation coefficient (r) was used to detect the strength of association between scores at EOM forms and final grades. Two-tailed P values < 0.05 were considered significant. All statistics were performed using SPSS software (version 11.5).

RESULTS

The EOM form was filled by 89% of the first to fourth year students matriculated.

Mean EOM scores among PBL groups

Overall, questions about tutoring process scored better than those related to module content. The lowest scores were observed for Q1, Q3 and Q5 for both basic sciences and clinical medicine groups (**Figure 1**). Mean scores for Q1, Q2, Q3, Q4 and Q5 were higher in clinical medicine as compared to basic science groups (**Table 2**).

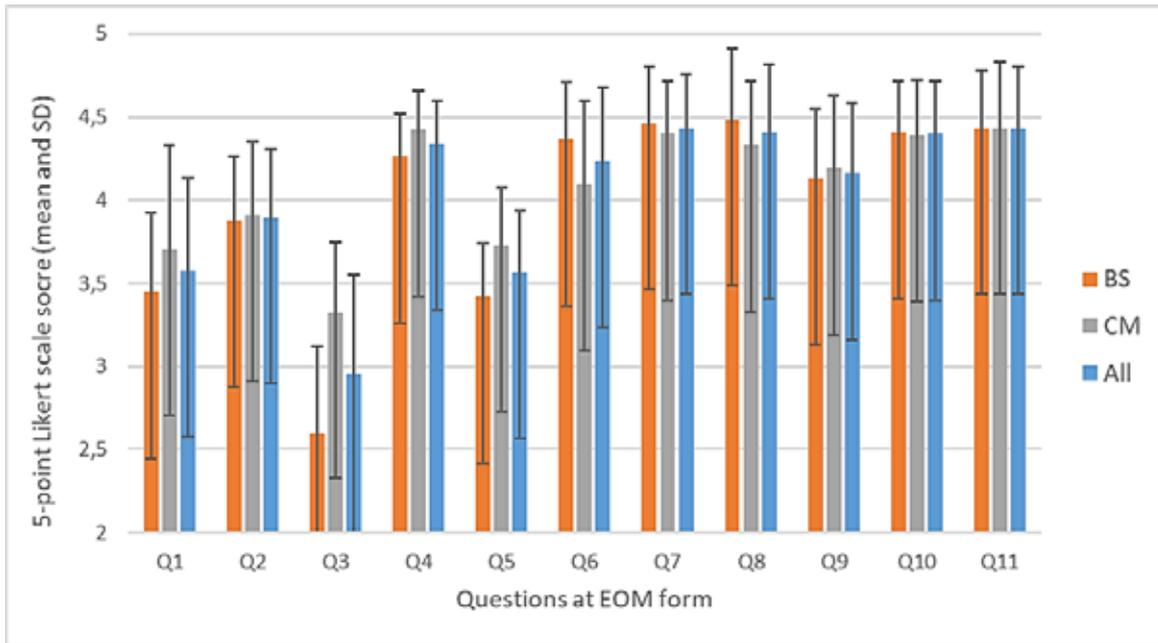


Figure 1. Mean scores and standard deviations of all EOM questions from basic sciences (BS) and clinical medicine (CM) groups.

Table 2. Comparison of scores for EOM questions between basic science (BS) and clinical medicine (CM) PBL groups.

Questions	Likert scale rating – 1=not at all, 2=a little, 3=rather, 4=yes, 5=very much		
	BS groups (mean±SD)	CM groups (mean±SD)	p
1. Overall, did you enjoy the module?	3.44±0.48	3.70±0.62	0,124
2. Did you find the module content interesting?	3.88±0.39	3.91±0.44	0,795
3. Was it easy to understand the module content?	2.60±0.52	3.33±0.42	<0,001
4. Did you realize the importance of the module on your medical education?	4.26±0.26	4.42±0.24	0,34
5. Overall, do you think you studied adequately for this module?	3.42±0.32	3.72±0.35	0,003
6. Did the library provided adequate bibliography for this module?	4.36±0.34	4.09±0.51	0,043

Scores for Q6 were higher in basic sciences groups whereas scores Q3, Q4 and Q5 were higher in clinical medicine groups. (Figure 1)



Correlation between EOM scores and final grades

Final grades (mean \pm standard deviation) for basic science, clinical medicine and all PBL groups were, respectively, 7,5 \pm 0,4, 8,0 \pm 0,2 and 7,7 \pm 0,4.

Considering all PBL groups, final grades were positively correlated with Q4 (tendency; $r=292$ and $p=0.052$) and Q5 (tendency; $r=286$ and $p=0.057$), and negatively correlated with Q6 ($r=-314$; $p=0.036$) and Q8 (tendency; $r=-250$ and $p=0.098$). Groups with increased scores (Likert scale ≥ 4) for Q4 and Q5 presented better final grades than those reporting lower scores for these questions (7.8 vs 7.5, $p=0.013$ and 8.1 vs 7.7, $p=0.025$; respectively); no differences in final grades were observed regarding the other questions.

Evaluating only basic science PBL groups, it was found a negative correlation for Q1, Q2, Q6 (tendency), Q7, Q9 (tendency) and Q10 (tendency) with final grades. Conversely, clinical medicine PBL groups impressions did not correlate with final grades.

DISCUSSION

In this study, we were able to raise important topics about impressions of medical students PBL groups on curriculum content and learning process with the aid of a concise questionnaire. Short questionnaires applied to students to evaluate learning environment have been validated for some aspects, such as tutors effectiveness in PBL, if at least six students responses are available per group. (Dolmans & Ginns, 2005; Singaram, Van Der Vleuten, Van Berkel, & Dolmans, 2010)

With regard to the perception of learning environment by medical students, the relationship with their peers, such as the ability to gather together and assist each other, were distinctly appraised (Skochelak et al., 2016). Similarly, our study showed high scores on teamwork among medical school peers within the PBL groups. Sharon et al. showed that the perception of a meaningful learning environment, which relates to the relevance of the proposed curriculum, a positive emotional climate, and closeness among medical students was associated with better performance (Wayne, Fortner, Kitzes, Timm, & Kalishman, 2013). Accordingly, in our study, group's perception of the relevance of the curriculum in their medical education, as assessed by Q4 and Q5, was also related with better performance.

In this study, impressions from 1st to 2nd year medical groups correlated better with performance than those from 3rd to 4th year groups. Interestingly, better performances of groups of students early in the medical course were related to negative impressions about their affinity with module content, tutor role, some aspects of PBL process and faculty resources. Here, it is important to clarify that, in Brazil, high school learning methodology is purely dedicated to traditional lectures focused on the forthcoming admission tests for college admission (Araujo & Slomski, 2013). Another issue is that the relative lack of clinical experience during



the first years of medical school may impair students' perceptions on the importance and relevance of major topics offered in this period. Hence, students may feel uncomfortable or even confused about curriculum content and PBL process during the first years of the medical course. In fact, the perception of the relationship between basic science and clinical material was among the lowest scores in a comprehensive learning environment survey with first year medical students (Skochelak et al., 2016). Also, medical students tend to lose self-efficacy and move away from deep-strategic learning approaches towards more surface approaches during the first year of study (Papinczak, Young, Groves, & Haynes, 2006). Moreover, performance was not impacted by how first year medical students perceived faculty support and administrative policies (Wayne et al., 2013).

Our results also show that medical students from 3rd to 4th year were more aware of the relevance of the curriculum scientific content and its importance in their medical education as compared to basic science groups. This is expected as students move forward on their clinical training, with better perception of relevant topics. Thus, improving self-regulated learning skills in the early years of medical school, such as planning learning activities and goals before a specific task, may improve performance, as this was shown to be associated to more effective learning through PBL (Hendry et al., 2006; Papinczak et al., 2006; Demirören, Turan, & Öztuna, 2016). As previously stated by Schmidt HG et al., we agree that the extent of learning in PBL results from neither group collaboration only nor individual knowledge acquisition only; both activities contribute equally to learning in PBL (Schmidt, Rotgans, & Yew, 2011).

Our study has some drawbacks, including its single-institution and cross-sectional design. Also, the results were not controlled by gender, ethnicity, previous academic experience, origin and if the students had or not a physician in the family, although these factors were not shown to impact on students' perceptions on learning environment in a collaborative study with 28 medical schools. (Skochelak et al., 2016; Wayne et al., 2013) Another limitation was the voluntary basis of the student's participation that, although with a drop off of only 11%, may have yielded different impressions between respondents and non-respondents.

In conclusion, medical students – as a group – had better perceptions of PBL process as compared to curriculum content, and 3rd and 4th –year medical students were more aware of the relevance of the curriculum on their training. The recognition of the curriculum relevance on medical education along with the perception of adequacy of self-study had an impact on final grades, whereas students' feedback of tutorial process in PBL was not predictive of performance. We believe that a better clarification of the scientific goals and modules' relevance for medical formation, along with learning skills training and more curriculum transparency, can improve students' perceptions of tutoring process and performance in the early years of medical school.

**REFERENCES**

- Araujo, A. M. P., & Slomski, V. G. (2013). Active Learning Methods—An Analysis of Applications and Experiences in Brazilian Accounting Teaching. *Creative Education*, 04(12), 20–27. <https://doi.org/10.4236/ce.2013.412a2004> .
- Das Carlo, M., Swadi, H., & Mpofu, D. (2003). Medical Student Perceptions of Factors Affecting Productivity of Problem-Based Learning Tutorial Groups: Does Culture Influence the Outcome? *Teaching and Learning in Medicine*, 15(1), 59–64. https://doi.org/10.1207/s15328015tlm1501_11
- Demirören, M., Turan, S., & Öztuna, D. (2016). Medical students' self-efficacy in problem-based learning and its relationship with self-regulated learning. *Medical Education Online*, 21(1), 30049. <https://doi.org/10.3402/meo.v21.30049>
- Dolmans, D. H. J. M., & Ginns, P. (2005). A short questionnaire to evaluate the effectiveness of tutors in PBL: validity and reliability. *Medical Teacher*, 27(6), 534–538. <https://doi.org/10.1080/01421590500136477> .
- Ganguly, A., Faulkner, C., & Sendelbach, D. (2019) Association of group composition diversity and performance outcomes in a pre-clerkship team-based learning program. *Medical Teacher*, 41(9), 1060-1064. <https://doi.org/10.1080/0142159X.2019.1616682> .
- Harden, R. M. (2018). Ten key features of the future medical school—not an impossible dream. *Medical Teacher*, 40(10), 1010–1015. <https://doi.org/10.1080/0142159x.2018.1498613>
- Hendry, G. D., Lyon, P. M., Prosser, M., & Sze, D. (2006). Conceptions of problem-based learning: the perspectives of students entering a problem-based medical program. *Medical Teacher*, 28(6), 573–575. <https://doi.org/10.1080/01421590600878150>.
- Papinczak, T., Young, L., Groves, M., & Haynes, M. (2006). Effects of a Metacognitive Intervention on Students' Approaches to Learning and Self-Efficacy in a First Year Medical Course. *Advances in Health Sciences Education*, 13(2), 213–232. <https://doi.org/10.1007/s10459-006-9036-0>
- Schmidt, H. G., Rotgans, J. I., & Yew, E. H. J. (2011). The process of problem-based learning: what works and why. *Medical Education*, 45(8), 792–806. <https://doi.org/10.1111/j.1365-2923.2011.04035.x>
- Singaram, V. S., Van Der Vleuten, C. P. M., Van Berkel, H., & Dolmans, D. H. J. M. (2010). Reliability and validity of a Tutorial Group Effectiveness Instrument. *Medical Teacher*, 32(3), e133–e137. <https://doi.org/10.3109/01421590903480105> .



Skochelak, S. E., Stansfield, R. B., Dunham, L., Dekhtyar, M., Gruppen, L. D., Christianson, C., Filstead, W., & Quirk, M. (2016). Medical Student Perceptions of the Learning Environment at the End of the First Year. *Academic Medicine*, 91(9), 1257–1262. <https://doi.org/10.1097/acm.0000000000001137> .

Wayne, S. J., Fortner, S. A., Kitzes, J. A., Timm, C., & Kalishman, S. (2013). Cause or effect? The relationship between student perception of the medical school learning environment and academic performance on USMLE Step 1. *Medical Teacher*, 35(5), 376–380. <https://doi.org/10.3109/0142159x.2013.769678>

AUTHOR INFORMATION

Flávio Augusto Naoum, drflavio@institutonaoum.com.br, Brazil, Faceres Medical School (corresponding author)

Felipe Pacca, felipepacca@gmail.com, Brazil, Faceres Medical School (corresponding author)

Patrícia Cury, pmcury@hotmail.com, Brazil, Faceres Medical School (corresponding author)



INVESTIGATION ON THE APPLICATION OF PROJECT BASED LEARNING IN AN ENGINEERING FACULTY IN IRAQ

Bayan S. Al-Numan, Thamir M. Ahmed & Barham H. Ali

ABSTRACT

A survey is conducted on the application of project-based learning PBL method in the engineering faculty of Tishk International University in Erbil, Kurdistan region of Iraq. In the survey the faculty members and graduate students of the civil, architectural and computer departments had participated. The outcome is to apply the PBL method, as two-thirds of the students and more than 80% of the academic staff prefer. The academic staff (more than 70%) prefer a hybrid traditional-PBL system in the curriculum.

KEYWORDS: Engineering education, Project based learning, Survey

TYPE OF CONTRIBUTION: Full scientific paper

PRESENTATION FORMAT: Interactive paper presentation

INTRODUCTION

Project-Based Learning (PBL) is a learning approach that focuses on the learner (Hit, 2010). According to Bill (2010), "PBL [project-based learning] is a fundamental strategy for creating independent thinkers and learners." Another element of PBL's success is the "product presented to the public" (Larmer and Mergendoller, 2010). This gives students the opportunity to cherish their work and provide them with the presentation skills they will definitely use in the future. Panasan and Nuanchalerm (2010) conducted a study on the effects of inquiry-based learning (IBL) and PBL on achievement. They concluded that both PBL and IBL were effective and had positive effects on student learning in the science class.

THE AIM AND SCOPE OF THIS INVESTIGATION

The faculty of engineering at Tishk International University TIU/ Erbil, Iraq has 7 departments; the older three on sequence are computer engineering, civil engineering and architectural engineering. Curricula, periodically updated, are based largely on traditional teacher-centered studies. PBL is only partially applied in limited courses. The graduation project course is approximately the only course that is 100% PBL oriented.



The engineering faculty in the TIU is looking for ways to create better conditions for applying the PBL method in its departments.

This investigation surveys the views of graduate students and the academic staff of the said older departments on the possibility of applying the PBL in the engineering faculty of TIU. The questionnaire focuses on how the characteristics of the PBL method are acceptable for both students and academic staff as a better learning approach that would give more benefits to the higher education process, and on the top obstacles to apply the PBL.

The objectives of this special target survey were:

- to identify opinions about whether PBL method is effective in the higher education system.
- to reach out the students' view of acceptance or rejecting the PBL method.
- to reach out academic staff opinions for the strategy of applying of PBL method.
- to identify faculty's plans for - and obstacles to – applying the PBL method

Almost 86 randomly selected graduate students and 28 academic staff members in three engineering departments were interviewed. 13 of the academic staff are Master holders and 15 are PhD holders. 11 of them are with 5 to 10 years of academic experience and 17 are with more than 10 years of experience. The survey was primarily carried out by questionnaire sheets.

STUDENTS STAND, RESULTS AND MAIN FINDINGS

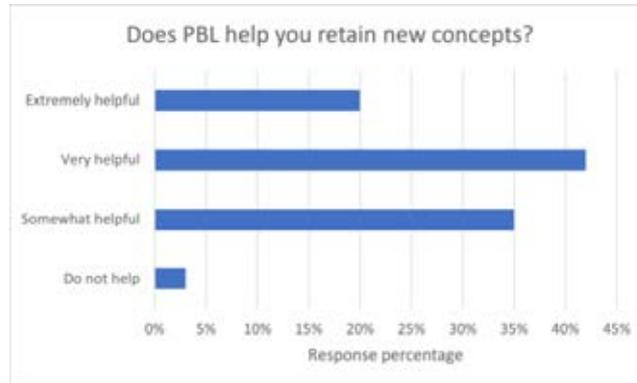
Figures 1 to 7 show the results of students' investigation. Fig. 8 shows the responds altogether. The details are described below.

Q1\ Does PBL help you retain new concepts?

Figure (1) shows more than 60% of graduate students agreed that the PBL is helpful in retaining new concepts; 20% extremely helpful and 42% very helpful. Only 3% of the students see that the PBL is not helpful.



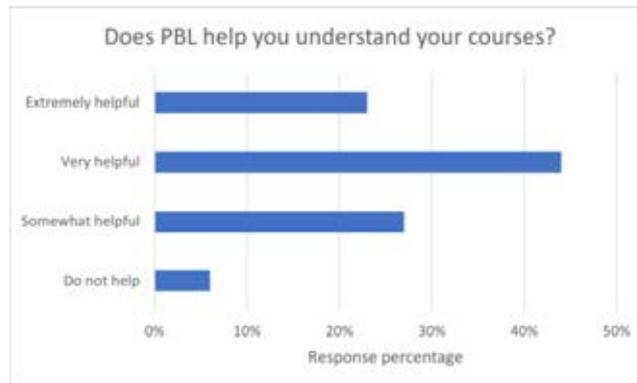
Figure 1: Response of Students to Q1Q2\ Does PBL help you understand your courses?



Q2\ Does PBL help you understand your courses?

Figure (2) shows 67% believed that the PBL is helpful in understanding their courses; 23% extremely helpful and 44% very helpful. Only 6% of the students see that the PBL is not helpful.

Figure 2: Response of Students to Q2

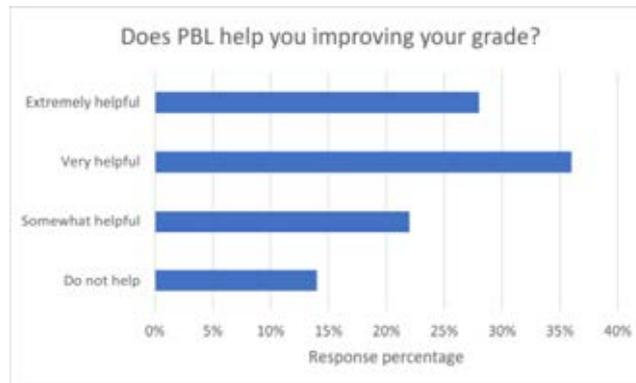


Q3\ Does PBL help you improving your grade?

Figure (3) shows more than 60% agreed that the PBL is helpful in improving their grades; 28% extremely helpful and 36% very helpful. However, 14% of the students see that the PBL is not helpful.



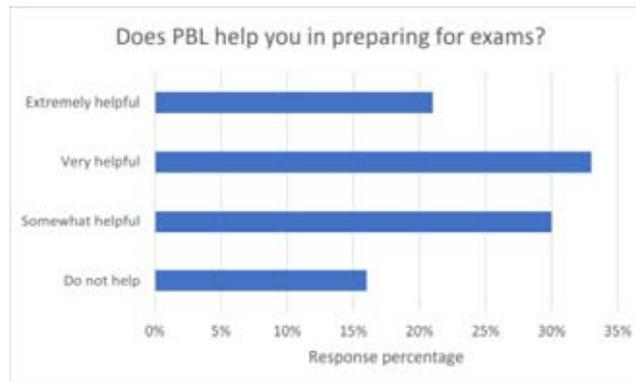
Figure 3: Response of Students to Q3



Q4\ Does PBL help you in preparing for exams?

Figure (4) shows that more than 50% of students agreed that the PBL is helpful in increasing their engagement with course materials; 21% extremely helpful and 33% very helpful. 16% of the students see that the PBL is not helpful.

Figure 4: Response of Students to Q4

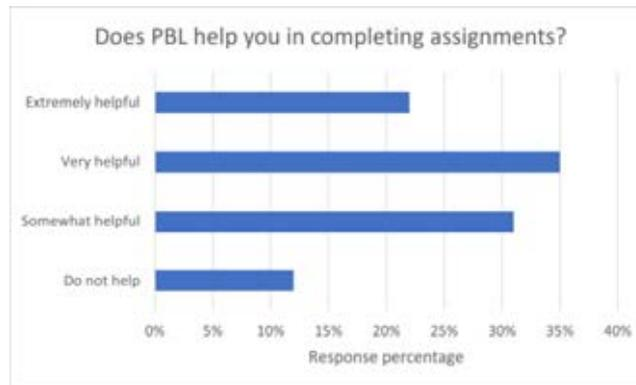


Q5\ Does PBL help you in completing assignments?

Figure (5) shows more than 50% agreed that the PBL is helpful in completing assignment; 22% extremely helpful and 35% very helpful. 12% of the students see that the PBL is not helpful.



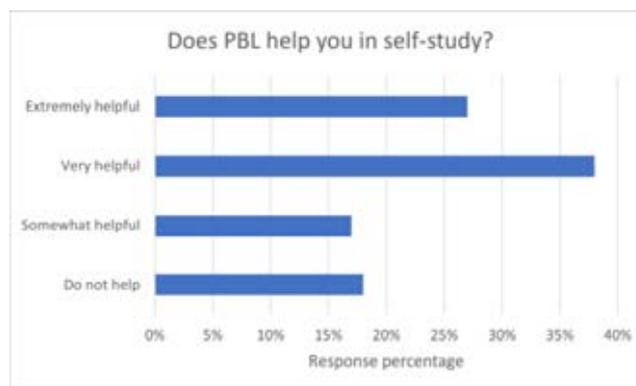
Figure 5: Response of Students to Q5



Q6\ Does PBL help you in self-study?

Figure (6) shows two-thirds of graduate students agreed that the PBL is helpful in self-study; 27% extremely helpful and 38% very helpful. 18% of the students see that the PBL is not helpful

Figure 6: Response of Students to Q6



Q7\ Does PBL help you in exam performance?

Figure (7) shows more than 50% agreed that the PBL is helpful in self-exam performance; 21% extremely helpful and 34% very helpful. 15% of the students see that the PBL is not helpful.



Figure 7: Response of Students to Q7

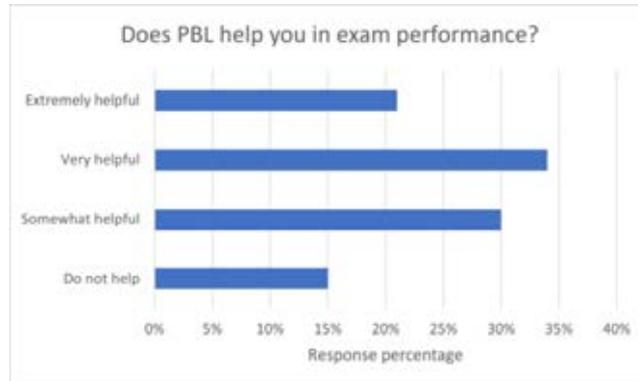
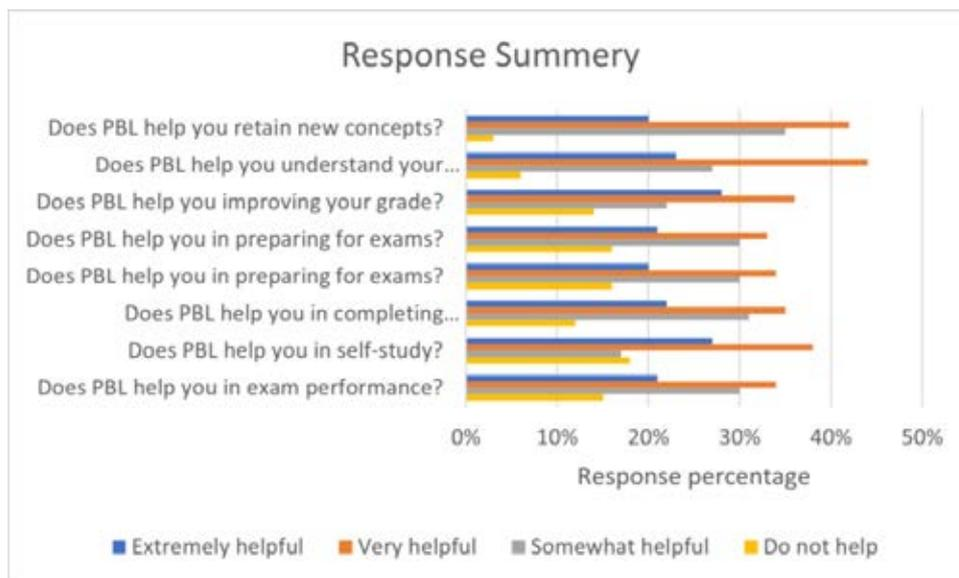


Figure (8) summarizes the students survey. It is clear that an overall acceptance of the graduate students to apply PBL method in their academic activities.

Figure 8: Summary of student’s response of all questions



ACADEMIC STAFF STAND, RESULTS AND MAIN FINDINGS

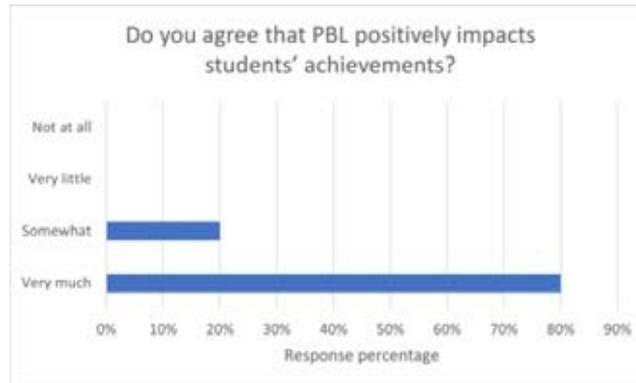
The survey then asked members of the academic staff of the three departments in the engineering faculty the questions shown next. Figs 9 to 13 show the results of academic staff’s investigation. The details are described below.



Q1\ Do you agree that PBL positively impacts students' achievements?

Figure (9) shows 80% of the members of academic staff agreed 'very much' that the PBL is positively impacts students' achievements; 20% see that the PBL is 'somewhat' impacts students' achievements. No one selected 'very little' or 'not at all'.

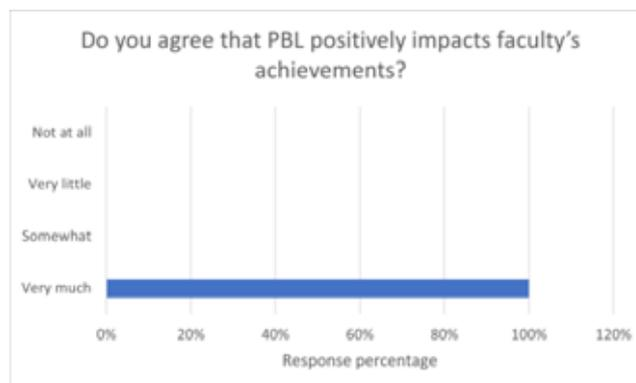
Figure 9: Response of Academic Staff to Q1



Q2\ Do you agree that PBL positively impacts faculty's achievements?

Figure (10) shows 100% agreed 'very much' that the PBL is positively impacts faculty's achievements; No one select 'somewhat', 'very little' or 'not at all'.

Figure 10: Response of Academic Staff to Q2

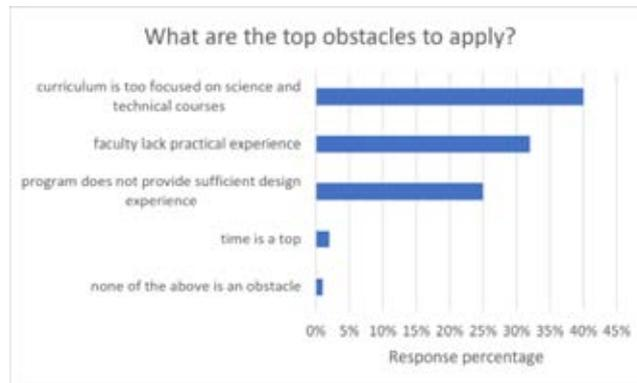


Q3\ What are the top obstacles to apply? You can choose more than one answer.?

Figure (11) shows about 40% agreed that the curriculum is too focused on science and technical courses; 32% considered that faculty lack practical experience; 25% considered that the program does not provide sufficient design experience; and only 2% considered time as a top obstacle. Only 1% of the staff considered that none of the above is an obstacle.



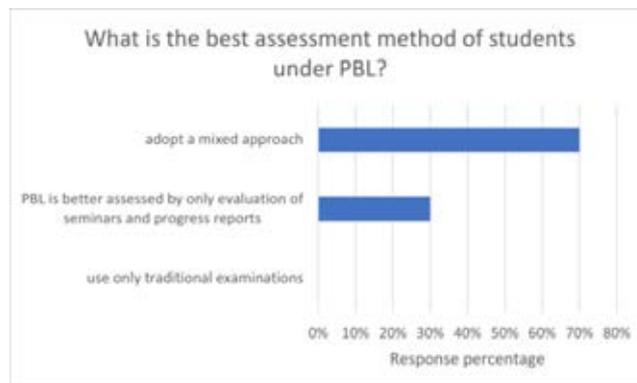
Figure 11: Response of Academic Staff to Q3



Q4\ What is the best assessment method of students under PBL?

Figure (12) shows 70% agreed to adopt a mixed approach; by evaluation of seminars and progress reports and by traditional examinations (midterm and final). 30% agreed that the PBL is better assessed by only evaluation of seminars and progress reports. No one selected to use only traditional examinations.

Figure 12: Response of Academic Staff to Q4

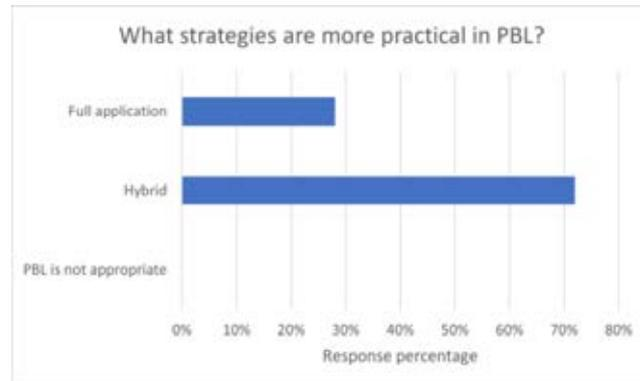


Q5\ What strategies are more practical in PBL?

Figure (13) shows 72% agreed that the more practical strategy of PBL is the hybrid strategy; first two years are for fundamentals by the traditional method and the final two years for PBL method. 28% of the members of academic staff prefer full (100%) application of PBL for the whole 4-year program. No one select that PBL is not appropriate.



Figure 13: Response of Academic Staff to Q5



APPLYING PBL PARTIALLY IN CIVIL ENGINEERING COURSES

Based on the willingness of both academic staff and most of students, PBL method was agreed to be applied to a new elective course of “Ethics in Engineering and Construction” CE450 and announced to graduate students at civil engineering department of Tishk International University TIU, Erbil, Iraq to be within the final 8th semester course load. A high rate of graduate students had registered in the course (29 out of 60); many of them are top students of high GPA, even when they became informed that 40% of the course will be based on a project-based learning PBL method; a student-centered learning method, which is not familiar to our students in Iraq. (Al Numan, 2019)

Case studies from literature were discussed through the course, and further studies were asked to be discussed and presented by groups of students based on a partial PBL method.

During final examination of the groups, their project work and group work, the students were asked by the examining committee about the for/against points of this learning method. It was found that PBL provides to them a state of free thinking and planning, although they acknowledge the importance of effective instructor’s supervision.

CONCLUSIONS

1. The majority of graduate students favored a PBL method; a minority was in no favor of the PBL method (between 3% and 16%).
2. About two third of students agreed that the PBL is ‘extremely’ or ‘very’ helpful in retaining new concepts, in understanding their courses, and in self-study.



3. 80% and 100% of academic staff agreed that the PBL method will positively impact the students' and faculty's achievements, respectively.
4. About 40% of the staff agreed that the curriculum is too focused on science and technical courses;
5. 72% of the staff agreed that the more practical strategy of PBL is the hybrid strategy; first two years are for fundamentals by the traditional method and the final two years for PBL method. 28% of the members of academic staff prefer full (100%) application of PBL for the whole 4-year program. No one selected that PBL is not appropriate.
6. PBL method was applied partially to a course in the 8th semester for graduate students at the civil engineering department of TIU. It was found that PBL provides to them a state of free thinking and planning, although the students acknowledge the importance of effective instructor's supervision.

REFERENCES

- Al Numan, Bayan S. (2019) "Lecturing Engineering Ethics for Graduate Students of Civil Engineering", Current Trends in Civil & Structural Engineering, ISSN: 2643-6876, DOI: 10.33552/CTCSE.2019.02.000543, Volume 2 - Issue 4, 2019
- Bell, S. (2010). Project-Based Learning for the 21st Century: Skills for the Future. *The Clearing House*, 83(1), 39-43.
- Hitt, Joseph (2010), "Problem-Based Learning in Engineering." *Paper presented to the Center for Teaching Excellence, US Military Academy, West Point, NY.*
- Larmer, J. & Mergendoller, J. (2010). 7 Essentials for Project-Based Learning. *Educational Leadership*, September 2010. 34-37.
- Panasan, M. & Nuangchalerm, P. (2010). Learning Outcomes of Project-Based and Inquiry-Based Learning Activities. *Journal of Social Sciences*, 6(2), 252-255.

AUTHOR INFORMATION

Bayan Alnuman, bayan.salim@tiu.edu.iq, Iraq, Tishk International University (corresponding author)

Thamir Ahmed, thamir.ahmed@tiu.edu.iq, Iraq, Tishk International University

Barham Haydar, barham.haydar@tiu.edu.iq, Iraq, Tishk International University



SMALL-SCALE SPIRAL STRUCTURE FOR ORGANIZING PBL CASE SESSIONS IN MEDICAL DOMAINS

Mike S. Astorp, Mathias A. B. Danielsen, Gustav V. B. Sørensen, Diana Stentoft & Stig Andersen

ABSTRACT

Introduction: Vast amounts of knowledge, skills and competencies needs to be taught to the undergraduate medical students. This poses a challenge for faculty given the restrictions, requirements and requests for form and content. Faculty members at the Department of Geriatric Medicine encountered the challenge: how do we efficiently convey a complex area of knowledge within a setting with several requirements, restrictions and requests?

Methods: We propose a template for a problem based learning model paralleling the spiral structure for organising undergraduate medical educational programs and incorporate learning principles known from experiential learning theory resulting in the small-scale spiral structure for medical education (S4ME). We suggest implementation of this model within the context of a learning environment for medical students in clinical clerkship seeing patients regularly.

Discussion: The S4ME supports learning by applying principles from experiential learning theory. Furthermore, the spiral construction revisits topics at increasing levels of complexity by each iteration, thereby adding new learning and supporting retention of what has already been learned. The students are inclined to focus on content rather than structure when learning is based on a familiar structure.

Conclusion: We hypothesise that the use of “small-scale spiral structure for medical education” is a supportive tool for the challenge of teaching vast amounts of knowledge, skills and competencies to the undergraduate medical student given the set restrictions, requirements and requests for form and content.

KEYWORDS: Problem based learning, Spiral structure, Learning theory, Case based learning, Clinical learning, Undergraduate Medical curriculum

TYPE OF CONTRIBUTION: Extended scientific abstract

PRESENTATION FORMAT: Roundtable discussion

BACKGROUND

Medical students are faced with requirements for learning that necessitate the retention of large amounts of information. Furthermore, the curriculum for undergraduate medical students dictates acquiring



knowledge, skills and competencies in several medical and surgical areas and this challenges the organisation of teaching and learning in the clinical settings (Andersen et al., 2019).

Consequently, teaching medical students at the Department of Geriatric Medicine, Aalborg University Hospital, presented us with a difficult task: How do we efficiently convey a complex area of knowledge to medical students in a setting of three teaching sessions within 6 weeks each lasting three hours and conducted by teachers. Problem-based learning (PBL) is the principle used for teaching and learning of undergraduate medical students at Aalborg University Hospital. For their final three years of education, students see patients in the morning and engage in PBL-sessions in the afternoon. The clinical clerkships include several medical specialities rotating approximately every 6 weeks.

This organisation of curriculum poses a challenge because of the immense amount of knowledge educators would like students to engage with within each speciality. To this end, three problems need addressing. First, the limited timeframe available for each medical speciality does not match the vast amount of knowledge, skills and competencies to be learned by the students. Second, the setting of a clinical environment poses challenges for teaching and learning (Spencer, 2003). Third, a line of stakeholders, including politicians, patient organisations, legislators, quality managers and faculty members, request influence upon the content of the undergraduate medical curriculum to ensure suitable coverage of their area of interest (Andersen et al., 2019).

To accommodate all requests, requirements and restrictions is impossible and prioritisation is necessary.

The spiral medical curriculum

Some of the challenges mentioned above have previously been addressed by organising medical education using a spiral curriculum model as proposed by Bruner (Horvath, 1964). The spiral medical curriculum (SMC) is commonly used within a number of medical educations in a variety of versions (Harden & Stamper, 1999). The spiral curriculum is organised accordingly to principles of iterative exposure to topics, subjects and themes throughout medical education. This supports deepening of knowledge and understanding with each encounter. The spiral construction revisits topics at increasing levels of complexity by each iteration, thereby adding new learning on top of previous experiences while also supporting retention of what is already learned (Harden & Stamper, 1999). The literature addressing the use of the spiral structure curriculum within undergraduate medical education focusses on the curriculum itself while little focus has been on the application of these principles on small-scale teaching settings such as within each medical speciality.



The spiral of learning

A spiral of learning is a key principle in experiential learning theory by e.g. Kolb (D. . Kolb, 1984a). This theory defines learning as “the process whereby knowledge is created through the transformation of experience” (D. . Kolb, 1984b). Learning can be portrayed as a spiral that involves experience, reflection, thinking and action. Kolb et al explains that: “*For a learner to engage fully in the learning cycle, a space must be provided to engage fully in the four modes of the cycle – Feeling, reflection, thinking and action. It needs to be a hospitable, welcoming space that is characterised by respect for all. It needs to be safe and supportive but also challenging. It must allow learners to be in charge for their own learning and allow time for repetitive practice that develops expertise*” (A. Kolb & Kolb, 2009). Our ambition and effort to accommodate this is ongoing in the complex area of teaching medicine in the elderly patient.

Solution and aim

Facing challenges and using Kolb’s theory of learning led us to propose a PBL model incorporating spiral learning and learning principles known from experiential learning theory. This resulted in *the small-scale spiral structure for medical education (S4ME)*. We hypothesise this model support teaching of complex areas of knowledge such as medicine for the elderly within a limited timeframe and with a focus on students developing the competencies to recognise key characteristics of the geriatric patient.

SMALL-SCALE SPIRAL STRUCTURE FOR MEDICAL EDUCATION

Within the restrictions, requirements and requests for content and form we suggest use of the *S4ME* for clinical problem-based sessions for enhancing learning.

The *S4ME* concept consists of a limited number of case sessions of a few hours’ duration each. The *S4ME* entails that topics are revisited at increasing level of difficulty to raise the complexity and hence the competences of the students to assess and determine key characteristics of the elderly patient by each case session. The *S4ME* lean upon the principles of the learning spiral: concrete experience, reflective observation and abstract conceptualisation (D. . Kolb, 1984b). The aim is for students not only to retain knowledge but for students to build competencies to bring this knowledge with them in their encounters with elderly patients in the future.

The case sessions involve real clinical cases with sessions revolving around core knowledge, skills and competencies essential to the medical speciality being taught. The students must have time for preparation either as part of the case session itself or beforehand with the aim to secure space for reflection. The sessions must be set in a hospitable, safe, supportive, and yet challenging environment (D. . Kolb, 1984b).



DISCUSSION

The significant amounts of knowledge, skills and competencies to be learnt by undergraduate medical students pose a challenge for faculty given the restrictions, requirements and requests for form and content. The use of spiral structures has been adopted widely in undergraduate medical curriculums and we find this model useful in a small-scale template to support the framework for a challenging setting within specific medical specialities.

The advantages of using the S4ME are likely to match those described when applied to the undergraduate medical curriculum as a whole (Harden & Stamper, 1999). This means knowledge, skills and competencies are reinforced through continual exposure. It allows a stepwise introduction of the students to a complex area of knowledge and increase the complexity with each session. Several areas of knowledge integrate into the sessions and as the students grow more experienced, they will be able to create a deeper understanding and coherence of formerly acquired knowledge. The nature of the S4ME allows for a logical sequence in the introduction of topics in a specific speciality and hence support the student in building up an understanding of the characteristics of a particular patient group. This allows faculty to meet the students at their level of knowledge and experience thereby optimising learning and even support going beyond the intended outcomes.

The problem-based S4ME supports learning in the phases of the learning spiral. Concrete experience is supported by students seeing patients in the morning, cases being anchored in clinical problems and patients in the case sessions. Reflective observation is supported through facilitation of discussion during the sessions creating a space where students reflect on their former experience and by bridging the gap between theory and practice related to the medical speciality. Abstract conceptualisation occurs when the students bring the new knowledge on to subsequent patients leaning on learning from previous sessions. Thus, they draw on former experience and knowledge from a similar but not identical context to form new understanding. Furthermore, the case session provides space for reflection upon their action in the clinic thus supporting reflection on action in addition to reflection in action (Schön, 2017).

CONCLUSION

We hypothesise that the use of “small-scale spiral structure for medical education” could be a relevant tool for the challenge of teaching vast amounts of knowledge, skills and competencies to the undergraduate medical student given the set restrictions, requirements and requests for form and content.

**REFERENCES**

- Andersen, S., Stentoft, D., Emmersen, J., Rasmussen, S., Birkelund, S., & Nøhr, S. (2019). Contention over undergraduate medical curriculum content. *International Journal of Medical Education*, *10*, 230–231. <https://doi.org/10.5116/ijme.5de7.7516>
- Harden, R. M., & Stamper, N. (1999). What is a spiral curriculum? *Medical Teacher*, *21*(2), 141–143. <https://doi.org/10.1080/01421599979752>
- Horvath, W. J. (1964). Jerome S. Bruner. The process of education. Cambridge: Harvard University Press, 1960. *Behavioral Science*, *9*(1), 56–57. <https://doi.org/10.1002/bs.3830090108>
- Kolb, A., & Kolb, D. (2009). The Learning Way. *Simulation & Gaming*, *40*(3), 297–327. <https://doi.org/10.1177/1046878108325713>
- Kolb, D. . (1984a). *Experiential learning: experience as the source of learning and development*. Prentice Hall. <http://www.learningfromexperience.com/images/uploads/process-of-experiential-learning.pdf>
- Kolb, D. . (1984b). *Experiential learning: experience as the source of learning and development*. Prentice Hall.
- Schön, D. A. (2017). *The Reflective Practitioner*. Routledge. <https://doi.org/10.4324/9781315237473>
- Spencer, J. (2003). ABC of learning and teaching in medicine: Learning and teaching in the clinical environment. *British Medical Journal*, *326*(7389), 591–594. <https://doi.org/10.1136/bmj.326.7389.591>

AUTHOR INFORMATION

Mike Sæderup Astorp, m.astorp@rn.dk, Denmark, Department of Geriatric Medicine, Aalborg University Hospital, Aalborg, Denmark (corresponding author)

Mathias Aalkjær Brix Danielsen, maad@rn.dk, Denmark, Department of Geriatric Medicine, Aalborg University Hospital, Aalborg, Denmark

Gustav Valentin Blichfeldt Sørensen, gustav.soerensen@rn.dk, Denmark, Department of Geriatric Medicine, Aalborg University Hospital, Aalborg, Denmark

Diana Stentoft, stentoft@hst.aau.dk, Denmark, Centre for Health Science Education and Problem-Based Learning, Aalborg University, Aalborg, Denmark

Stig Andersen, lasa@rn.dk, Denmark, Department of Geriatric Medicine, Aalborg University Hospital, Aalborg, Denmark



REFLECTION AS ACTION: KEEPING EDUCATIONAL CULTURE ALIVE THROUGH PBL RESEARCH

Stella Wasenitz & Janneke Frambach

ABSTRACT

This practice-based abstract proposes the contribution to a roundtable discussion that addresses evidence-based educational management. Based on a research project at Maastricht University, the abstract presents how research can be designed to be inclusive, critical, and constructive towards maintaining and achieving high educational quality. While does not focus on the results of the research, the outcome showed the need for a more flexible and open discourse about a diversity of PBL approaches through a bottom-up which included exactly such conversation as the focus groups provided. The investigation into and a commitment to high quality education through open and honest communication and research was thus as such a starting point to reignite vibrant educational exchange and foster creativity. The abstract provides some insights into the design of this research and the consequences for the success of the project, along with some insights into educational management. It suggests that it is important to keep educational culture alive through honest internal reflections, communication towards shared visions that requires flexibility and inspiration. This continuous effort of re-defining and adjusting PBL is understood as central to maintaining high educational quality. Importantly, this should take place with respect to the local and temporal conditions, fostering a more flexible PBL definition generally.

KEYWORDS: educational management; PBL definitions; educational culture

TYPE OF CONTRIBUTION: Practice-based abstract

PRESENTATION FORMAT: Roundtable discussion

EDview is a project at Maastricht University (UM) that was initiated to reflect on the current state and future of teaching and learning at UM. After 40 years of formally explaining PBL mostly by means of the so-called “seven-step approach”, this message seemed outdated. The seven steps are a procedural approach to PBL that ought to guide them in the solution of a problem but as this was perceived as restrictive, there was now a need to rethink PBL at UM and develop an educational vision for the future. With the completion of the research phase in October 2018, the project gained a considerable amount of attention and was perceived to be successful, developing some momentum to now put these results to practice.



This abstract does not focus on the results of the research but informs about the development of such research, addressing strengths and weaknesses of the process. We are submitting this abstract to participate in a round-table discussion (or as a workshop in collaboration with other stakeholders from UM and Aalborg). Challenges like the following would be addressed: How can the research be designed to be inclusive and constructive, yet nuanced and critical? How can the diversity of PBL approaches be understood in a coherent message? What does successful communication with the different stakeholders look like, balancing biases and diverging interests? How can progressive education be managed towards an implementation of the results that remains authentic given the PBL context? In answering these questions EDview serves as a case-study with a multitude of positive and constructive insights but also some critical perspectives.

Indeed, the research towards establishing a vision was designed keeping in mind the integrity with the academic nature of the institution just like the collaborative and self-directed nature of the educational method that was researched. In other words, organizational re-design of PBL meant to be developed not through an imposed vision but through thorough and inclusive engagement with the PBL practitioners ranging from students to all levels of teachers to management. Moreover, the authentic nature of the approach was key: Allowing an open-ended discussion that ought to keep or dismiss the PBL label and, if kept, give the term PBL meaning, provided insights into a variety of existing approaches to education that were already based on the principles of collaborative, contextual, constructive, and self-directed learning, leading to a broader understanding and a more truly shared commitment to PBL. Likewise, it allowed for an insight and shared recognition of those aspects of PBL at UM that were deemed undesirable. The conversation as such was part of the process of the new vision: it enabled the communication about and began a conversation on alternative and more flexible educational approaches that was perceived as inspiring and led to a broader definition of PBL on an institutional level – including but far beyond the seven-step approach.

In practice, this shared broader vision and recognition was developed through three main phases of research with around 2000 participants in total (Frambach & Wasenitz, 2018). The first phase was rather expert-based and managerial, in which the state-of-the-art theory and evidence was investigated through focus groups with educational policy makers and researchers and a literature review informed by the participants. Based on this, the research team set up focus groups and interviews with students, teachers, course coordinators and programme directors from all faculties. Simultaneously, an online survey with quantitative and qualitative items was advertised and shared within the university, emphasising the importance of participation reaching a large audience. After the analysis, the final research phase was about feedback and member checking where the preliminary results were presented to and discussed with formal stakeholders



and experts. The final presentation of the results took place in the context of a symposium which all UM students and staff were invited to, that was to set the starting point for the implementation and included a wide array of interactive sessions thinking about the future prospects.

This participatory approach was a unique moment for Maastricht University in that it formally acknowledged and honestly approached the divergent views on PBL. Rethinking PBL in this context did not mean an agreement on a model definition based on an instructed methodology. Instead, the emphasis was on understanding PBL *practice* at UM leaving a formal definition behind in favour of a shared vision that allowed for a wider recognition of good education. Good education is then not the ticking of boxes but the implementation of an educational philosophy aimed at an emancipation of the teachers and students to co-own the practice of PBL. Such an approach to PBL practice makes for a learning organisation in which education is constantly reshaped and refined through the practitioners' experiences. This development of the rejection of a rigid PBL approach at UM can be understood within the broader context of the quest for PBL definitions. While often looked at for PBL expert knowledge, bigger educational institutions like UM cannot, as Frambach, Talaat, Wasenitz and Martimianakis (2019) recognize, dictate a clear PBL definition or the best PBL practice. Based on a diverse set of educational history and developments, it is important to recognize and accept the multitude of PBL definitions and interpretations and take the concept into one's own hands. As suggested in the same paper, we stand behind a shift from dominant discourses in the context of PBL definitions towards a constructive discourse on PBL practice with an open and inclusive approach. Rather than de- and refining the demarcation criteria for PBL, a continued global discussion on educational experiences in the PBL context might go alongside with a more local approach of asking oneself individually and in an institutional context with questions about what makes PBL meaningful in a certain context. This is a continuous effort, rather than an easy fix. But such conversations do already take place, for example at the PAN-PBL association, which, on its website, also refrains from defining PBL globally (PAN-PBL, 2020). Indeed, definition questions might be a distracting occupation on a global scale. Nevertheless, research projects like EDview that allow for an open dialogue on definition questions towards a shared practice on a local level might be one way of making organizational change around PBL meaningful – obviously with respect to the specific cultural environment and without external imposition.

REFERENCES

Frambach, J. M., Talaat, W., Wasenitz, S., & Martimianakis, M. A. T. (2019). The case for plural PBL: an analysis of dominant and marginalized perspectives in the globalization of problem-based learning. *Advances in Health Sciences Education*, 24(5), 931-942.



Frambach, J. M., & Wasenitz, S. (2018). EDview position paper: The full potential of PBL philosophy. Diversifying education at Maastricht University. Retrieved March 7, 2019, from Maastricht University, EDLAB website: https://edlab.nl/wp-content/uploads/2018/10/EDview_Position-Paper.pdf.

PAN-PBL. (2020, February 25). *About*. Retrieved from <http://www.panpbl.org/about/>

AUTHOR INFORMATION

Stella Wasenitz, Stella.wasenitz@maastrichtuniversity.nl, Netherlands, Maastricht University (corresponding author)

Janneke Frambach, j.frambach@maastrichtuniversity.nl, Netherlands, Maastricht University



IFTE CONTINUOUS FEEDBACK MODEL FOR PBL COURSES

Grażyna Budzińska & Dagna Siuda

ABSTRACT

Problem-Based Learning has been steadily gaining popularity in higher education over the last decades. The method is valued for enabling the students to gain skills of independence in research, problem solving and decision making as well as develop self-regulated learning, so much valued in the times of dynamic changes evoked by a variety of factors such as globalization, climate change, mass migration, technological development. Being able to learn and solve problems in an autonomous way seems to be one of the most important assets of an engineer of the future. The paper aims at presenting a PBL model developed over several years at the Lodz university of Technology, Lodz, Poland that is aimed at providing a more independent and creative mode of learning facilitated by continuous formative feedback. The reflective discourse on the model, changing continuously in time is presented, in adherence to both students and teachers as an overall recommendation for the PBL practitioners to consider.

KEYWORDS: problem-based learning, feedback, formative assessment

TYPE OF CONTRIBUTION: Practice-based abstract

PRESENTATION FORMAT: Roundtable discussion

While the general assumptions of PBL have been known for years, many universities seek to establish their own model of PBL-centred courses in order to fully benefit from the potential of the method. At Lodz University of Technology (TUL), Problem-Based Learning oriented programs have been offered since 2006 in a growing scale. Learning from experience gained over those years while continuously exploring students' and mentors' opinions, TUL has developed a specific outline for PBL courses, an outline going through a constant progressive change. The main aim of this paper is to present the IFTE Continuous Feedback Model, concentrating on providing a framework for ongoing feedback-based assessment and support for the students' progress as well as for developmental learning of the tutors.

The above-mentioned scheme was constructed in a continuous dialogue in the group of TUL academics, the process triggered by turbulently changing environment that provides salient challenges to educators and students. The dialogue helped to identify fundamental principles of engineering education that help to link it to the existing turbulent context, values positively verified by experience such as high-quality engineering, and new demands resulting from the 'fluid reality' (Bauman, 2007):



- High quality engineering focusing on crossed-discipline-based knowledge acquisition and holistic engineering (Grasso, Martinelli, 2010) that allows for complex-problem solving.
- Real -life problem solving calling for combining various disciplines in the process of innovation (Clough, 2004).
- Creativity and innovation that will enable competitiveness (Kelly & Kelly, 2013) in a more and more demanding and competitive globalized context.
- Autonomy in a decision-making learning process since only independence in acquiring knowledge and solution seeking can guarantee student empowerment while facing the challenge of unstructured wicked problems-solving, so characteristic for contemporary times.
- Empathetic human-centric approach towards an end-user in solution design development, which can ensure higher competitiveness through increasing the level of product desirability (Mattelmaki, Vaajakallio, & Koskinen, 2014).
- International teamwork and leadership combined with a global mindset that can contribute to creative developments able to compete successfully in a global market.

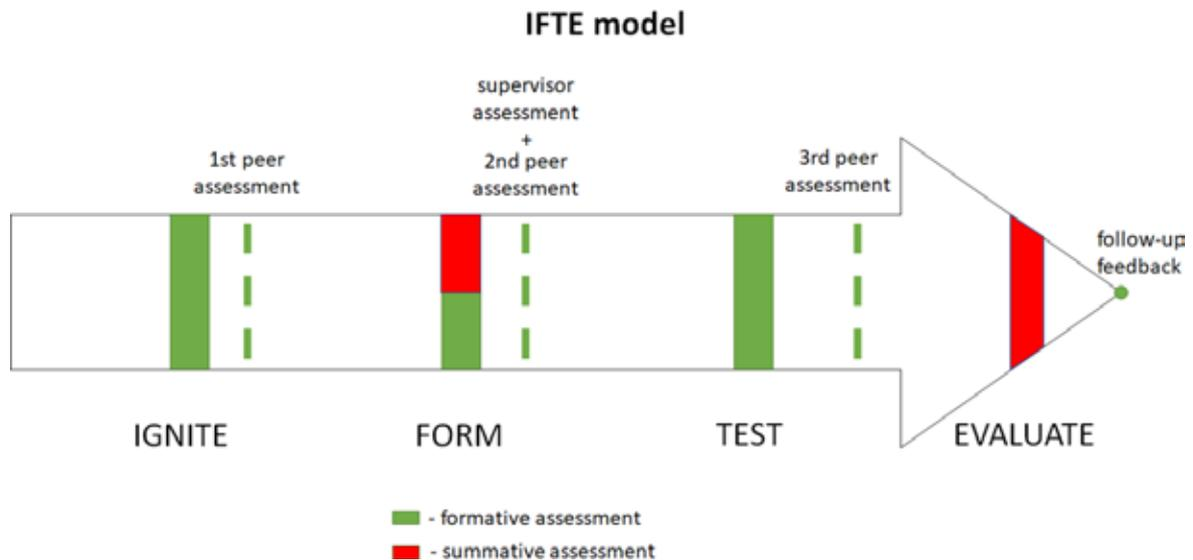
At the moment the principles are implemented at TUL in a variety of forms: project-based induction week called Study Skills, where students are asked to generate fast creative solutions in a few days' time, PBL and Design Thinking forth semester projects offered parallel to other courses, European Project Semester, in which projects are realized in international teams during the whole semester with a strongly accentuated PBL and DT approach, and two week summer schools for Polish and international students. Continuously learning from experience, TUL is planning another paradigm shift and add a more theoretical course introducing the PBL methodology before a human-oriented multidisciplinary project realized at the third semester, which is to be followed by a more challenging one-discipline engineering project in the fourth semester. The new scheme will allow for combining gradual development of the above- mentioned principles and will let the students be engaged in a more autonomous process of learning, test different constructs depending on their preferences and adaptability level.

The IFTE model is based on a continuous provision of feedback to the students and project mentors during the whole PBL project life cycle. The need arose from years of observation practice that proves that the mentors tend to concentrate on the summative assessment while underestimating the crucial role of formative feedback in the self-regulated learning process, autonomous internal feedback used to assess progress towards goals. (Nicol& Macfarlane- Dick, 2006). Polish education system has been traditionally based on evaluation and external motivation, underlining the mistakes without emphasizing good performance strongly enough. Therefore, both students and tutors are used to accentuating mistakes more



than using more constructive formative feedback. Such an approach may lead to students’ lessened creativity, increased dependence on teachers’ guidance in decision-making and lower ability to analyse and defend the ideas.

Figure 1: IFTE model for PBL courses



The proposed model comprises the four main events dedicated to student feedback acquisition, progress assessment and support provision for further work: Ignite, Form, Test and Evaluate offered in addition to weekly project meetings with mentors, during which tutors are supposed to use appropriate facilitation methods, for example dialogue-based facilitation, to provide supplementary response to the group’s performance.

In the proposed framework, the PBL process begins with a clear statement of rules for the students to use and the work evaluation criteria. After a few initial weeks (the time depends on the total length of the project and it might be significantly shorter in case of summer schools), the “Ignite” event is held. It is supposed to be a non-graded seminar during which the groups would describe their first steps in the project and an overall understanding of the challenge to the panel of supervisors and an “opponent group” chosen from other students. They are supposed to introduce the group members and their roles, characterize the problem they are working on and present their plan of future actions. This stage of the PBL process is aimed at facilitating the prompt launch of students’ work, which was observed to be quite problematic, and at providing formative assessment at the very beginning of the course that can potentially help to avoid certain mistakes in the initial phase.



The second major event of the model, “Form”, is the mid-term seminar, during which the teams present the final enhanced problem definition resulting from the performed research. This kind of seminars has been already included in PBL-based courses held at the University in previous years, however in the new formula they would not be graded and devoted more to constructive discussion with the panel and “opponent group”. The idea of opponent groups offers an opportunity of peer feedback which helps to “develop skills needed to make objective judgements against standards” (Nicol & Macfarlane-Dick, 2006). Additionally, the first self and peer assessment and mentor evaluation by the students would be included in this stage.

“Test”, the third event in the model, originates from the DT methodology. At this stage of the project, a speed-geeking meet-up is planned. The students are supposed to prepare a simple prototype of their solutions which will be presented to various groups of stakeholders invited to the meeting, e.g. other students, university staff, experts, business representatives and members of the target group. Once again, this event would be dedicated to gathering feedback, formative in its nature, which gives the students a possibility to test their concepts and obtain suggestions from different stakeholder representing a variety of points of view. As a result, the teams have a great opportunity to make their solution more desirable since they base it on a more empathetic approach.

The final stage of the process “Evaluate”, includes the final presentation of the PBL results. This step is characterized by the most traditional approach as it concerns mostly the summative assessment and grading. Besides the final evaluation and second self and peer assessment, and the next stage of supervisor evaluation are conducted. In this way, the tutors would also gain more comprehensive feedback on their performance as facilitators.

The several year process of PBL program development at TUL lead to important conclusions resulting from experience and supported by a concept of conscious competence model of learning (Broadwell, 1969). These are not only students but also teachers who should be going through its consecutive stages in order to achieve the stage of conscious competence or unconscious competence in facilitation. That is why, it is suggested that parallel to the evolvement of the process mentors should conduct activities that help them to play the role of facilitations rather than instructors. Facilitation is inherently connected with a PBL process, being students-centred in nature, due to the necessity for a teacher to step back with interventions, give away power over the learning process to the project teams in order to allow them to go through the experience of independent management of the learning process and its organization. Mentors are expected to use specific activities (self-reflective diaries, peer observation, self-video recording) in order to learn in a self-regulated way how to achieve a desirable facilitation style, hence only then they can empower students to become autonomous decision-makers and problem-solvers.



REFERENCES

- Bauman, Z. (2007). *Liquid times: Living in an age of uncertainty*. Cambridge: Polity Press. Broadwell, M. M. (1969). Teaching for learning (XVI.) *The Gospel Guardian*, 20 (41), 1-3a.
- Clough, G. W. (2004). *The engineer of 2020: Vision of engineering in the new century*. The National Academies Press.
- Grasso, D., & Martinelli, D. (2010). Holistic Engineering. In D. Grasso, & M. D. Burkins (Eds.), *Holistic engineering education: Beyond technology* (pp.11-15). Springer.
- Kelly, T., & Kelly, D. (2013). *Creative confidence*. Crown Business.
- Mattelmaki, T., Vaajakallio, K., & Koskinen, I. (2014). What happened in emphatic design? *Design Issues*, 30 (1), 67-77.
- Nicol, D. J., & Macfarlane-Dick, D. (2006). Formative assessment and self-regulated learning: A model and seven principles of good feedback practice. *Studies in Higher Education*, 31(2), 199-2018.

AUTHOR INFORMATION

Grazyna Budzinska, grazyna.budzinska@p.lodz.pl, Poland, Lodz University of Technology (corresponding author)

Dagna Siuda, dagna.siuda@p.lodz.pl, Poland, Lodz University of Technology (corresponding author)



DESIGNING PROBLEM-BASED LEARNING FOR BLENDED PROGRAMS: THE COLLABORATION AMONG PRACTITIONERS AND RESEARCHERS

Mario Giampaolo, Loretta Fabbri & Maria Ranieri

ABSTRACT

The background for this contribute is provided by a reform promoted by the Italian Ministry of Education concerning the preparation of educators. In December 2017, indeed, the law 205 established for the first time that educators are required to possess an academic title and invited departments and schools of education to organize mandatory intensive programs to train professionals already working in the national educational system with no bachelor's degree in educational sciences. Different Italian academic institutions tried designing a program potentially meaningful for workers in terms of both topics and teaching approach.

In order to develop the program, researchers in education at University of Siena and University of Florence involved representatives of cooperatives and associations in the field of education as "insiders" of the professional contexts. This collaboration allowed researchers to intercept data that emerged from the experience, especially those situated problems, that academic researchers were not able to collect differently. In this frame the co-design of the program represents the opportunity to share knowledge that is close to the professional problems that educators live (Shani, Guerci, & Cirella, 2014).

The developed core contents have been implemented in a six modules blended program. Each module starts with a face- to-face session, involves participants in online activities and ends with a second face-to-face session. The modules include each two on-line activities designed following a model of Problem Based Learning (PBL) that will be presented in this contribute.

KEYWORDS: problem based learning, blended program, in training educators, collaborative research

TYPE OF CONTRIBUTION: Practice-based abstract

PRESENTATION FORMAT: Experience demonstration

THEORETICAL FRAMEWORK OF THE MODEL

PBL is a learner-centered approach that allows students to apply theories and skills to an authentic problem and develop possible solutions. Since 1980, when this approach was first proposed in the Mc Master Medical School in Canada, different authors described its characteristics (Hmelo-Silver, 2004; Savery, 2006). The



following models of PBL inspired the one presented in this paper. In the authentic Problem Based Learning (aPBL) (Barrows & Wee Keng Neo, 2010). students apply what they already know with the aim to comprehend and solve a problem, while recognizing the information they need. Using a variety of resources from different disciplines, new knowledge related to the problem is acquired through self-directed learning process. New knowledge is structured by problems, facilitating the recall and the application in future problems. A similar approach characterizes the Delisle’s model of PBL (Delisle, 1997). It consists in a logic process that allows students to analyze and solve the problem. Students connect themselves with the problem, analyze it, make a task and evaluate it.

The third model that composes the theoretical framework is called the Dutch model and was developed during the ‘70s of last century at the University of Limburg in Maastricht (Savin-Baden, 2007). The model presents seven steps that begin from the analysis of a problem to arrive at the individuation of contents that need to be studied or that have to be collected. As different models of PBL have been developed for face-to-face learning, so several approaches have been designed for on-line learning. Different models of online PBL are briefly described in the table below (Table 1).

Table 1. Types of online problem-based learning adapted from Savin-Baden, 2007, p. 31.

Type of online PBL	Description
Single module online at distance	This typology is designed as 1-12 week stand-alone modules developed for a specific focus.
Single module blended (campus and distance)	This typology provides flexibility and support, but also develops self-direction in inquiry.
Blended program	This typology is a full degree program with a focus on students’ support during face-to-face seminars.
Content management systems (CMS) for PBL online	This typology is a content management system developed to support PBL

From the theoretical framework reported, different characteristics have been used to design the model presented in this contribute. As in the face-to-face models, students share and apply to the problem their previous knowledge in a discussion forum and then acquire new knowledge in a self-directed process consisting in reading provided learning resources or searching for others autonomously. Moving forward, through the steps of our model, they realize one or more tasks related to the solution of the problem. Finally,

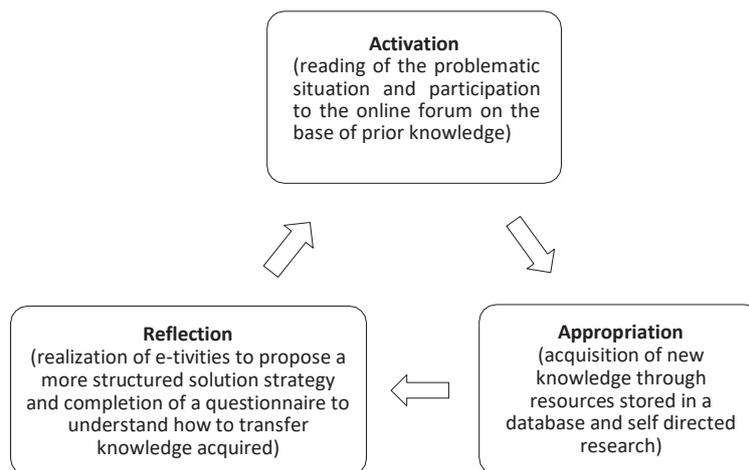


the model has been implemented in a content management system to offer participants a blended experience. In the next paragraph an in deep description of the model and its implementation is offered.

THE PBL MODEL DEVELOPED FOR THE PROGRAM

The PBL model developed for the program consists of three phases (figure 1). The first is called “activation”. Students read a scenario that presents a challenge for the reader or ask for the solution of a problem. In this phase students are invited to use their prior knowledge, discuss the problem and share their understandings. In the second phase called “appropriation”, students engage themselves in a self-directed learning process. They can access the resources provided by the teacher or they can find new material autonomously. The third phase called “reflection” allows the students to return to the initial problem on the basis of the new information gathered. They have to propose more structured solutions of the problem and understand how to transfer what they have learned in their professional context.

Figure 1. The problem-based learning model used in the program.



Researcher applied the model to a Moodle learning content management system using resources and activities of the platform. In the activation phase learners read a scenario using the resource page, then they have the opportunity to share their previous knowledge related to the story with other colleagues using the activity discussion forum. In the forum each participant has to write a brief post and comment at a minimum of two other participants’ posts. In the appropriation phase it is possible to deliver participants files, external links, and videos related to the core contents of the module or to give them the possibility to search academic databases or the web to find other learning resources. In this second case, once found the resources, participants had to explain their significance posting in a second discussion forum. In the reflection phase, the model is implemented through an e-tivity, a form to complete, that gives learners a structure to propose



a possible strategy to challenge the problem and finally the activity feedback to reflect on how to apply what they have learned in their work context.

PROFESSIONALS AS PROBLEM-BASED SCENARIO CREATORS

After having presented the model, it could be interesting to describe one of the on-line learning activities that participants had to achieve during the program. In the activation phase students could read a brief introduction to PBL and its characteristics. At the end of this reading participants receive the task to write an authentic scenario on the base of their professional experiences and of new resources collected in the second phase. To deal with this challenge and to understand better what PBL is, students autonomously search resources to deeply comprehend the elements needed to write a scenario. Once found interesting materials, participants have to link these in a discussion forum and write a post about the significance. After this self-directed research, participants started the third phase in which, reflecting on their work experiences and on the resources found, they could write a scenario.

An elderly mother with cognitive impairment, 3 children, two of whom with psychiatric disease. One of the children had a violent reaction after that the educator explained to him his duties for the umpteenth time...

Marina B.

Marco is a boy who presents psycho-physical problems, hypersensitivity and a strong insecurity in the relationship with his father, a severe and very authoritarian figure...

Francesco B.

At the end of the program, more than 100 scenarios have been submitted by the participants and most of these will be used to realise new PBL activities in the future editions of the program.

REFERENCES

- Shani, A., Guerci, M., & Cirella, S. (2014). Collaborative management research. Teoria, metodi, esperienze. Milano: Raffaello Cortina Editore.
- Savin-Baden, M. (2007). A practical guide to problem-based learning online. New York: Routledge.
- Hmelo-Silver, C. E. (2004). Problem-based learning: What and how do students learn? Educational Psychology Review 16(3), 235-266.
- Savery, J. R. (2006). Overview of Problem-based Learning: Definitions and Distinctions. Interdisciplinary Journal of Problem-based Learning 1(1), 9-20.



Barrows, H. S., & Wee Keng Neo, L. (2010). Principles and practice of aPBL. Springfield: Southern Illinois University School of Medicine.

Delisle, R. (1997). How to use problem-based learning in the classroom. Association for supervision and curriculum developmnet, Alexandria.

AUTHOR INFORMATION

Mario Giampaolo, mario.giampaolo@unisi.it, Italy, University of Siena (corresponding author)

Loretta Fabbri, loretta.fabbri@unisi.it, Italy, University of Siena

Maria Ranieri, maria.ranieri@unifi.it, Italy, University of Florence



PROBLEM BASED LEARNING FOR NURSING TRAINING AT FEDERAL UNIVERSITY OF SERGIPE

Glebson Moura Silva, Simone Yuriko Kameo, Rosemar Barbosa Mendes, Fernanda Gomes de Magalhães Soares Pinheiro, Andreia Freire de Menezes, Allan Dantas dos Santos & Maria do Socorro Claudino Barreiro

ABSTRACT

The health professional training model, especially the nursing one, has undergone changes over time, due to its low effectiveness in preparing qualified professionals and able to respond to society's demands. The objective was to analyze how the pedagogical guidelines influenced the nurse training process at the Federal University of Sergipe (UFS), Campus Lagarto-Sergipe-Brazil. This is documentary research with Analysis of the National Curriculum Guidelines (DCN); Pedagogical Project of the Nursing Course (PPC), UFS, Campus Lagarto, Sergipe, Brazil, complemented by the Activity Plans of the undergraduate cycles through Bardin's content analysis. The UFS Nursing course was created and approved on April 24, 2007, it has 4 teaching activities, Tutorial, Teaching practice in the community, Skills and Attitudes in Health and Internship distributed in 5 years. When considering the profile and objectives for the course, they portray the same concepts, with similarity to the profile of the graduate, evidence from categories associated with the traditional approach of the curriculum such as: Teaching, learning, assessment, methodology and efficiency. The curriculum is concerned with the formation of a skilled and active professional, the need to emphasize methodologies that suit the professional profile, with PBL and problematization playing an important role. We conclude that it is necessary to reflect on the distance between all academic theorizing focused on the curriculum and the reality of health education. It remains the perspective of how to make this "distance" in the undergraduate nursing course shortened and favor the implementation of comprehensive training.

KEYWORDS: Curriculum, Health education, Nurse training, Problematization, Problem based learning.

TYPE OF CONTRIBUTION: Full scientific paper

PRESENTATION FORMAT: Interactive poster presentation

INTRODUCTION

The health professional training model has undergone changes over time, due to its low effectiveness in preparing qualified professionals and able to respond to society's demands. According to each historical period, the university produced knowledge related to socio-political, cultural and economic needs, adjusting the means and teaching methods. (Optiz, 2008).



In nursing, the path followed to comply with these requirements was that of increasing specialization, based on the biomedical paradigm, to train professionals who would respond to the mode of production, with an emphasis on emotional neutrality and technical efficiency. (Silva, 2010).

In this context, an essentially technical and fragmented curriculum was defined, which contributed to the training of nurses who were little prepared to deal with health, as the center of the entire teaching process was diseases. Thus, the historical context of nursing education has been accumulating changes that are always linked to market needs, and historically it has undergone three models: the first of a sanitary nature, focused on public health and the prophylactic needs of the time; the second was essentially hospital-centered, which coincided with the expansion of hospitals in the country, with a focus on curative and procedural actions; and the third model, the integral model, which brought a broad character to the training, which dominates the technique, but focuses on the resoluteness of care, which reflects, understands and understands the context of professional performance, which forms a professional so committed to himself, as with society.

With integrality as a guiding axis, despite the various meanings it assumes in the health area (Mattos, 2008), it can be inferred that it is opposed to fragmentation, and emerges as the new paradigm of the nursing training process, since it favors the articulation between knowledge, the recognition of the subject as a whole and not only as a diagnosis, with the valorization of individual and collective approaches to reorient the teaching process.

As for the pedagogical principles, they are intertwined with the methodological ones, as they present profiles to be adopted by the course, by the teacher and by the student in the same guiding line of the philosophical principles.

However, unlike what happened with the adoption of the biomedical model, in the integrated curriculum, the teacher acts as a facilitator of the teaching process and the student is the conscious protagonist of the learning process. With mandatory use of active teaching methodologies, in this particular case, two were pre-determined: the problematization methodology (PM) and the Problem Based Learning (PBL).

Therefore, the objective was to analyze how the pedagogical guidelines influenced the process of training nurses at the Federal University of Sergipe (UFS), Campus Lagarto- Sergipe-Brazil, and to what extent they have been implemented. The motivation was due to the need to know the nurse's training process at UFS, Lagarto campus, since the authors have been teachers at this institution since the beginning of the construction of the campus in 2012.



METHODOLOGY

This is documentary research with Analysis of the National Curriculum Guidelines (DCN); Pedagogical Project of the Nursing Course (PPC), UFS, Campus Lagarto, complemented by the Activity Plans of the 1st, 2nd, 3rd, 4th and 5th cycle of graduation. They were provided for consultation and copy by the course coordinator, after presentation and clarification of the study objectives. A comparative study of the documents was also carried out, identifying by category their relationship with active teaching methodologies for integral training.

The Nursing course at UFS was created and approved by Resolution no 21/2009/ CONEPE, proposed by the federal government through Presidential Decree no 6.096, of April 24, 2007. It has five years duration, and performs joint activities with the Department Health Education.

According to the Course Pedagogical Project (PPC), the general objective of this course is to ensure a general formation of Bachelor of Nursing, with the necessary knowledge for the exercise of general and specific competences, in line with the profile described in the National Curriculum Guidelines. Having as a guiding principle the defense of life and health as a right.

Considering the nature of the data, content analysis was used, using the thematic analysis technique, which according to Bardin (2011) for the examination of the different subjects involved in the study, it is important to perform the categorization of information, in the search for the description and systematization of the manifest content in communications, for the purpose of interpretation.

RESULTS AND DISCUSSION

Table 1 presents the characteristics of the Nursing course, implemented at the Campus that predominated in the implication or idealization of active methodologies as a way to train nurses.



Table 1: Characteristics of official documents that guide the teaching process in undergraduate nursing

COMPOSITION	DCN	PPC
PROFILE	Art. 3 - Nurse, with generalist, humanistic, critical and reflexive training. Qualified professional for the practice of Nursing, based on scientific and intellectual rigor and guided by ethical principles.	Art. 5 - Nurse, with generalist, humanistic, critical and reflective training. Qualified professional for the practice of Nursing, based on scientific and intellectual rigor and guided by ethical principles.
AIM	Art. 4 - The training of nurses aims to provide the professional with the knowledge required to exercise general and specific skills and abilities.	Art. 4 - To train generalist nurses, with social responsibility, having as a guiding principle the defense of life, health as a right and the relief of suffering in terminality.
SKILLS AND ABILITIES	Art. 4 - health care, decision making, communication, leadership, administration and management, permanent education.	Art. 6 - General: Health care, decision making, communication, leadership, administration and management, permanent education. Specific: The Nurse must also have technical-scientific, ethical-political, contextualized socio-educational skills.
RELATIONSHIP WITH SUS (Unified Health System)	Single paragraph. The training of nurses must meet the social needs of health, with an emphasis on SUS and ensure the integrality of care and the quality and humanization of care.	Art. 3 - The Nursing Undergraduate Course has as justifications: I. the need for comprehensive training of nursing professionals with articulation between teaching, research, extension and assistance, closer to the reality to be found by the new professionals, who will act as critical and modifying agents, with an emphasis on collectivity and the Unified Health System.
CURRICULUM	Art. 6 § 1 - The curricular contents, competences and skills to be assimilated and acquired at the nurse's graduation level must confer terminality and academic and / or professional capacity, considering the prevalent and priority demands and needs of the population. § 2 - This set of competences, contents and abilities should promote the autonomous and permanent capacity for intellectual and professional development in the student and the nurse. Art. 14th V - the implementation of methodology in the teaching process that encourages the student to reflect on social reality and learn to learn; VI - the definition of pedagogical strategies that articulate knowledge; knowing how to do and knowing how to live together, aiming to develop learning to learn, learning to be, learning to do, learning to live together and learning to know, which are indispensable attributes for the training of nurses. Art. 15° § 1° The evaluations of the students must be based on the competences, skills and curricular contents developed. § 2 The Undergraduate Nursing Course must use criteria to monitor and evaluate the teaching-learning process and the course itself.	Art. 7 - The Nursing Undergraduate Course will have as an axis for the curricular structure the use of active teaching / learning methodologies, in particular Problem-Based Learning (PBL) and the Problem-solving Methodology. Annex I - Resolution 18/2012: proposes a comprehensive education, shared with other knowledge and contextualized in the subject in his existence in society. Furthermore, it provides for training to take place from the reflection of reality, with theoretical and practical views in cycles, with a transformative return to this same reality. For this, it values not only the cognitive aspects for the education of the student, but also the attitudinal and psychomotor aspects. To meet the proposed teaching model, the course is guided by competencies and its curriculum divided into annual cycles, totaling five years. The first cycle is developed, in full, with all other courses on Campus, except for special situations, thus constituting the basic cycle of comprehensive health training. This cycle focuses on the practice of primary health care, in which the theoretical contents are contextualized, distributed by the curricular units, which aim, only, to systematize elements for the construction of competences. Thus, from the first moment, it is sought to insert students into health practice, with a particular vision for collective health. The second, third, fourth and fifth cycles are specific to the training of nurses and add to the focus given to primary health care, but still sharing space with it, secondary-level care, outpatient and hospital specialties, from integrated health centers.
TEACHER'S FUNCTION	Article 9 - The Nursing Undergraduate Course must be centered on the student as a subject of learning and supported by the teacher as a facilitator and mediator of the teaching-learning process. The pedagogical project should seek the education of the student through the articulation between teaching, research, extension and assistance.	Art. 16 - It will be the role of the Advisor Teacher: I. to assist the student in obtaining skills and abilities; II. develop educational plans for students to achieve the objectives proposed by the course project; III. monitor and evaluate the student's portfolio; IV. assist in interpreting and resolving doubts related to the PPC and the institution's rules; V. assist in resolving conflicts and doubts, and, VI. assess student progress during their academic life.

Legend: Art. - Article; § - paragraph

When considering the profile and objectives for undergraduate Nursing, in the official documents, it is noticeable that these portray the same concepts, with the similarity of the graduate's profile being notorious - "Nurse, with generalist, humanistic, critical and reflective training" (Brazil, 2001; PPC, 2012) with the objectives of both documents. It is believed that this profile has arisen, mainly, from the concern regarding the tendency towards early specialization and education marked, over the years, by curricular parameters based on the biomedical model, dissociated from the individual's life context, where for each cause there was an objective consequence to be discovered and solved.

Mitre et al (2008) pointed out that this model greatly influenced the training of health professionals with a solid emphasis on basic sciences, in the first years of the course, with thorough organization of assistance in each specialty, valuing teaching centered on the hospital environment focused on curative, individualized and uncausal attention to the disease, eventually producing teaching dissociated from the service and the real needs of the current health system. This is the main urgency for change pointed out, which for Koifman



(2001) is the overcoming of the organicist and reductionist vision, through the inclusion of the social and the psychological, pointing to a differentiated and more comprehensive notion that focused only on organic issues .

Therefore, it requires a new way of teaching, since the biomedical model would no longer handle this need for contextualized training, and the methodology for a liberating education practice in the training of an active professional is proposed. (Mitre et al, 2008; Almeida, 2003; Ceccim & Feuerwerker, 2004). From these assumptions is the principle of integrality that has been constituting itself as a guiding axis of health education, and has provoked countless reflections on how to form a differentiated professional, calling for debate; universities, health councils and services. (Ciuffo & Ribeiro, 2008).

The National Curricular Guidelines for the Nursing Course determine the profession's competences; the ability to develop health prevention, promotion, protection and rehabilitation actions, both on an individual and collective level, in an integrated and continuous way with the other instances of the health system; the rationale for making decisions under the criteria of effectiveness and cost-effectiveness, of the workforce, medicines, equipment, procedures and practices; verbal, non-verbal communication and writing and reading skills; the mastery of at least one foreign language and communication and information technologies and the ability to assume leadership positions (Brazil, 2001).

The analysis of table 1, showed evidence of several categories associated with the traditional approach of the curriculum in the official documents, such as: Teaching, learning, evaluation, methodology and efficiency. Due to the fact that, in most of the writings, the focus of discussion has always been on the content, evaluation and the method that best suits the teaching process. Seen in the following citations: Art. 6 § 1 (DCN, 2001). Art. 7 (PPC, 2012). 15o § 1o. (DCN, 2001).

It is also perceived the concern of the curriculum with the formation of a skilled and active professional, therefore, the need to emphasize methodologies that suit the intended professional profile, which was structured based on indispensable content and evaluations. That is, the direction was given and the curriculum instituted. In this context, there are some opinions that try to abstract or enhance curricular approaches, such as the proposal by Tanji (2011) when he inferred that even proposing curricular changes linked to methodological changes, and, assuming that the old subsidizes the new, all competences formed in the application of traditional teaching methodologies, may come to equip professionals to develop their competences, in this new curricular context.

As seen in the theoretical perspective adopted by the official documents, there are categories that are also associated with the Critical approach to curriculum, such as: social and cultural reproduction, power, social



relations of production, awareness, emancipation and liberation, hidden curriculum. The writings point to these categories when referring to the curriculum linked to a culture to be reproduced in society, with a focus on the production of services and professionals for the labor market, subject autonomy in decision making, as well as considering the influence of the context of life of individuals. Exalted in the following excerpts: Art. 14th V - the implementation of methodology in the teaching-learning process that encourages the student to reflect on the social reality and learn to learn (DCN, 2001).

In this context, the teaching methodologies identified in the activity plans of UFS, Campus Lagarto for undergraduate nursing are presented in table 2.

Table 2: Teaching methodologies identified in the activity plans of the Nursing Course at UFS, Campus

ACTIVITY	METODOLOGY
TUTORIAL	Using the PBL methodology (Problem Based Learning / Problem Based Learning), with a central educational strategy the discussion of problem situations or clinical cases in small groups, called tutorial groups, consisting of about 8 to 12 students and a tutor. For each problem, a coordinator is chosen among the students to direct the session, and a rapporteur (secretary) to record the group's discussions. These functions will obey rotation among students for different problems. The problems will be worked on in 02 sessions, on different days. The first session will be called the analysis session, where the problem will open, and the second known as the resolution session, where the problem will be solved. In order to make meaningful learning possible, concept maps will be constructed during tutorial sessions. Between the two sessions, the student will conduct research on different sources of information on the proposed learning objectives (individual and self-directed study). The discussion of a problem in a tutorial group will follow a standard method - the 8-step method - whose objective is to make students discuss the problem, identify objectives, study and rediscuss the problem. The last step (added to our methodology, modifying the proposition of the "7 steps" of the University of Maastricht), is the formative assessment (where the student will have a note generated by the tutor for each resolution of the problem), the self assessment (made through the reflective learning portfolio) and peer assessment. At the end of each subunit, students will also undergo cognitive assessment.
HEALTH SKILLS AND ATTITUDES	The teaching-learning methodology is Problem Based Learning (PBL), an active methodology focused on the student. The recommended guidelines for education in this century are that all health professionals should be endowed with essential competences (knowledge, skills and attitudes), enabling their participation and multiprofessional performance, benefiting both individuals and the community (PAHO/WHO, 1997). The skills include clinical, communication, critical reasoning and proactivity skills about one's own learning. Attitudes comprise the posture, ethics and values that health professionals assume in contact with patients / family members and with other professionals. With the application of the methodology it is expected that the training of skills, combining theory and practice, will be a basis for all professional life. The skills will be trained and deepened throughout the course. The Teaching of Skills is student-centered, retrieves their previous experiences and is based on the following principles: theory-practice interaction; gradual development of skill complexity; in addition to training with multiple resources such as: anatomical models, videos, films; and several teaching-learning strategies such as: Clinical study, reports, sociodrama, seminars, experiences, workshops, theorization classes and simulation of practical situations, as well as direct assistance to hospitalized patients with some type / degree of dependence. The assessment aims to monitor the evolution of students in an inseparable way during the development of skills and competences, attitudes and cognitive aspects. The evaluation was divided into: Practical Assessment of Health Skills and Attitudes (APHAS); Formative Evaluation; and summative or cognitive assessment.
COMMUNITY TEACHING PRACTICE - PEC	It uses the problematization methodology, based on Paulo Freire's liberating pedagogy. It is based on increasing the student's ability to participate as an agent of social transformation, during the process of detecting real problems and searching for original solutions. It enables the collective construction of knowledge starting from problem situations identified by the experience in service. It was expressed graphically by Charles Magueres as "Method of the Arc" and supposes a conception of the act of knowledge through the direct investigation of reality, in an effort to build an effective understanding of this reality, seeking to intervene to modify it. The following steps can be identified: a) Observation, understanding and collection of reality data; b) Problems encountered and their explanations; c) Theorization; d) Identification of solutions and intervention planning; e) Intervention on reality; f) Monitoring and evaluation of the intervention. The evaluations are: formative, oral, written or cognitive, group report, technical visit report and socialization workshop.
INTERNATO	It uses the problematization methodology, based on Paulo Freire's liberating pedagogy. It is based on increasing the student's ability to participate as an agent of social transformation, during the process of detecting real problems and searching for original solutions. It enables the collective construction of knowledge starting from problem situations identified by the experience in service. It was expressed graphically by Charles Magueres as "Method of the Arc" and supposes a conception of the act of knowledge through the direct investigation of reality, in an effort to build an effective understanding of this reality, seeking to intervene to modify it. The following steps can be identified: a) Observation, understanding and collection of reality data; b) Problems encountered and their explanations; c) Theorization; d) Identification of solutions and intervention planning; e) Intervention on reality; f) Monitoring and evaluation of the intervention. The evaluations are: formative, oral, written or cognitive, group report, technical visit report and socialization workshop.

Note: Lagarto, Sergipe, Brazil.

When considering that the activity plan is the guiding document of the teacher and mainly for the student, as stated by Anastasiou & Alves (2010), one should not disregard the historical and contextual elements,



falling into the practice of the dichotomous content without observing the course as a whole (COUTINHO, 2011). Thus, based on the activity plans, two methodologies adopted in undergraduate nursing were identified, namely: Problem-based Methodology (PM) and Problem-Based Learning (PBL). The MP referred to in the Teaching Practice in the Community (PEC) activity is based on the Arco de Maguerez (Figure 2), which was developed in the 70s of the 20th century, and made public by Bordenave and Pereira (2007) from 1977.

Bordenave and Pereira's book was, for a long time, the only one available in academic circles on the Arco de Maguerez, applied as a problematic education path, inspired by Paulo Freire. Although attractive from the point of view of the proposal, there were no examples showing the applications of Arco as a stimulus for other teachers to use the methodology. With the strengthening of the need for a teaching perspective more focused on the construction of knowledge by the student, this alternative started to be considered in the last decades of the twentieth century, with strong support from the Nursing area (Colombo; Berbel, 2007).

This methodology is based on increasing the student's ability to participate as an agent of social transformation, during the process of detecting real problems and searching for original solutions (Bordenave & Pereira, 2007). Marked by the political dimension of education and society, teaching through problematization seeks to mobilize the social, political and ethical potential of the student, so that he acts as a citizen and professional in training (Cyrino & Toralles-Pereira, 2004). Bordenave and Pereira (2007) used the diagram, called the Arch Method by Charles Maguerez, to represent this methodology, which consists of the following steps: observation of reality, key points, theorizing, hypotheses of solution and application to reality. At UFS, after this last stage, 'monitoring and evaluation of the intervention' was added, since the proposed activity would be essentially practical and produced in the health services and / or registered population, facilitating the constant process of ascertaining the results arising interventional processes.

This shows a perfect alignment of these plans with the DCN and PPC for undergraduate Nursing, but at the same time denotes a limitation to them, since the concern is still focused on the job market and the demands of society, as mentioned in the Plans de PEC: "It enables the collective construction of knowledge starting from problem situations identified by the experience in service. It aims to prepare the student to act as a professional and citizen in a critical, reflective and attuned way with social demands". This was an important characteristic in this context, as this accountability can be favored by the practice of interdisciplinarity since the first periods of professional training.

Which leads us to think about the importance of flexibility that should be allowed by the use of both multidisciplinary and interdisciplinarity, as stated by Albuquerque et al (2009), that is, it is necessary to create an intersection zone between the course activities, otherwise both responsibility and activities will



continue to be reflected in a fragmented and decontextualized way, disconnected from experience, changing only the way of referring to teaching and disciplines. And, what is seen as an effect, is the maintenance of disciplinary boundaries, of objects and, especially, between the subjects of this knowledge, ordering professional practices of different epistemic cuts.

The other methodological approach mentioned by the tutorial activities, skills and attitudes in health and internship was the PBL, which starts from problems or situations that aim to generate doubts, imbalances or intellectual disturbances, with strong practical motivation and intellectual stimulus to evoke the reflections necessary to search for appropriate creative choices and solutions. And, in a very clear and objective way, this method is considered necessary for the development of cognitive competence.

Dewey (2011) explains some of the principles of PBL: the cultivation of the expression of individuality is opposed to top-down imposition; free activity is opposed to external discipline; learning from experience as opposed to learning through texts and teachers; the acquisition of skills and techniques as a means to achieve ends that correspond to the direct and vital needs of the student as opposed to their acquisition through exercise and training; making the most of the opportunities of the present, opposes the preparation for a more or less remote future; the contact with a world in constant process of change in opposition to objectives and static matters.

PBL considers that knowledge must be produced from the intersection between the subject and the world. One of the aspects that most draws attention, concerns the ability of PBL to enable the training of a student able to build his own knowledge and to work in a group in an articulate and fruitful way. Furthermore, the perspective of non- completion of training (expressed in the concept / praxis of continuing education) and the structuring of the formative and continuous assessment process - which, in fact, fade out the differences between university and professional lives - seem to be part of an open system of organization of the teaching-learning process, in which the notion of terminality of training is definitively given up (Mitre et al, 2008). Notion that weighs on all aspects of education, since determining precise ends to the educational process is of fundamental importance to justify the methodological choice.

Dewey was one of the defenders of the idea that the only goal of education was more and more education, however I believe that this was restricted to his time and the need for education of an era. Today, this parameter is constituted as a social and pedagogical crisis, as mentioned by Charlot (2013), currently, with the objective of not committing themselves, some schools adopt educational purposes with which everyone is in agreement, that is, they are so generic that it dazzles the understanding.



In the adoption of any of these methodological instruments, the educational purposes need to be clear, including to challenge the methodological choice itself. The curriculum must be configured in an integrated way and, when dealing with themes and contents in an integral way, the cycle of fragmentation and reductionism is interrupted, while facilitating the teaching-service integration and the interdisciplinary perspective (Feuerwerker, 2003; Ceccim; Feuerwerker, 2004). However, for this integration to take place, it needs to be interwoven in such a way that the service reflects teaching and teaching supports the service.

Thus, when the information presented here is associated with that of the bibliographic research, regarding the strategies of active teaching-learning methodologies, it appears that the categories found in the teaching plans, coincide or are equivalent to those researched and evidenced. In other words, it can be considered that the teaching methods used by the professors of the Nursing course, can be characterized as strategies of active teaching methodologies, going far beyond the provision of disciplines in the departmental model, but as an institutional change, once that there is a mandatory application of these methodologies throughout the health campus and a structural adaptation for them to take effect.

In this perspective, as verified in the menus, the themes of curricular integration, content, interdisciplinarity and professional practice, are well referenced, both in the objectives and in the programmatic contents of the analyzed documents. The teaching strategies adopted reflect the teachers' concern to provide students with a more active, critical and reflective learning, when they propose to diversify the teaching methods of all cycles of the course, in attention to curriculum determination. Facts that are close to the thinking of Silva (2010), when he stated that: "the formulation of new proposals for the training of health professionals, in the critical and interprofessional perspective, that is, the critical-reflective and collaborative training, in the towards the constitution of subjects for social transformation, they are considered as one of the demands for the reorganization of health practices towards a system anchored in SUS principles and guidelines".

And it is in these arguments that it is believed to reside one of the barriers of this education, said to be innovative, since the integrated curriculum is cited exhaustively throughout the plans, while little has been seen around integral training. It is noticed that this integration is seen as follows in the structure of the documents: as an integration of contents and practices, as well as between teaching and service. In other words, training has a lot of cognitive and behavioral appeal in order to mold a professional to the need of the current health system. It is necessary to think about the difficulty of adapting time, tools, resources and physical structure for the application of active methods and the limitations of the fields of practice and the use of health technologies as a tool for curricular activities (Souza, 2012).

Something to be considered, since these criteria can sentence the success or defeat of the teaching processes in this perspective. For example, in all plans there is talk of formative assessment (essential within the



methodological view), but the instruments used for such practice are strongly behavioral, therefore, in disagreement with what is proposed; cognitive assessments, with synonyms such as written or summative assessment, are overestimated on the student's score stratification scales. In addition to this, reports, case studies and practical evaluation appear, which often do not reflect learning by experience, since training is proposed that does not consider the assimilation and training variability, but still as a coercive process of demonstration of essentially technical skills.

Perhaps there is still difficulty for the subjects involved in evaluating learning in the integrated curriculum. Difficulty in developing integrated assessments that overcome the basic and professional split; self-assessment as a possibility to complement and sometimes legitimize the assessment itself; inability and lack of preparation to create an enabling environment to receive and express favorable and unfavorable opinions, as well as to deal with conflicts in the peer review modality; difficulty in applying a system of continuous and systematic feedback with the correction and return of the evaluation activities, as well as the discussion about the performance in practice fields and internship in a time sufficiently adequate for the programming of adequate and guaranteeing activities. learning.

CONCLUSION

It is necessary to reflect on the distance between all academic theorizing focused on the curriculum and the reality of health education. It remains the perspective of how to make this "distance" in the undergraduate nursing course shortened and favor the implementation of comprehensive training. Formation that, in addition to universalizing cultural knowledge, is linked to the understanding of society and the world in the most diverse spaces that compose it. Where doing is not the only guiding thread of educational activities, but intertwines with understanding and reflection as mediators between knowledge, perception and practice for a better life.

It is believed that education, in addition to prioritizing as a goal, meeting the interests of society, should also enable students to achieve purposes, creative processes, pay attention to the soul's desires, the subjectivity that interferes in the way of seeing the world and acting on him, acquiring experiences that can contribute to the advancement of life and this in society. This is based on the principles of a comprehensive education and to achieve it, this appreciation and the search for this balance between environments, interests and needs need to be fostered.

Therefore, an inevitability of systematization or belonging was envisaged, which often does not harmonize with the real need for educational practice. And, by bringing out the tonic of integral training, it is inferred about the importance of non-standardization, the opening of fetters, the valorization of subjectivities,



differences, meaning, representation, perception and, why not, the use of methodologies such as a path to wholeness and not as an end in itself.

REFERENCES

- Albuquerque, V. S., Batista, R. S., Tanji, S., Moço, E. T. M. (2009). Discipline curricula in the health area: an essay on knowledge and power. *Interface - Comunic., Saude, Educ.*, 13 (31), 261-72.
- Almeida, M. (2003). *Diretrizes curriculares para os cursos universitários na área de saúde*. Londrina: Rede Unida.
- Anastasiou, L. G. C., & Alves, L. P. (2010). *Processos de ensinagem na universidade: pressupostos para as estratégias de trabalho em aula*. Joinville: SC: Univille.
- Bordenave, J. D., & Pereira, A. A. (2007). *Estratégias de ensino-aprendizagem*. Rio de Janeiro: Ed. Vozes.
- Brasil. (2001). Ministério da Educação e Cultura. *Resolução CNE/CES no 03 de 07 de novembro de 2001*. Dispõe sobre Diretrizes Curriculares Nacionais do Curso de Graduação em Enfermagem. Brasília: MEC.
- Ceccim, R. B., & Feuerwerker, L. C. M. (2004). Mudança na graduação das profissões de saúde sob o eixo da integralidade. *Cad. Saúde Pública. Rio de Janeiro*, 20 (5), 1400- 1410.
- Ciuffo, R. S., & Ribeiro, V. M. B. (2008). Brazilian Public Health System and medical training: possible dialog? *Interface - Comunic., Saúde, Educ.*, 12 (24), 125-40.
- Colombo, A. A., & Berbel, N. A. N. (2007). A metodologia da problematização com o arco de Magueres e sua relação com os saberes de professores. *Semina: CiSoc/Hum*, 28 (2), 121-146.
- Coutinho, G. C. (2011). Metodologias ativas de ensino na graduação em terapia ocupacional: estratégias que possibilitam a integração das disciplinas no modelo departamental. *Tese de doutorado*, Del Mar, Chile.
- Cyrino, E. G., & Toralles-Pereira, M. L. (2004). Trabalhando com estratégias de ensino- aprendizado por descoberta na área da saúde: a problematização e a aprendizagem baseada em problemas. *Cad. Saúde Pública*, 20 (3), 780-8.
- Dewey, J. (2011). *Experiência e Educação*. Petrópolis, RJ: Editora Vozes.
- Feuerwerker, L. (2003). Educação dos profissionais de Saúde hoje - problemas, desafios, perspectivas e as propostas do Ministério da Saúde. *Revista da Abeno*, 3 (1), 24-27.
- Mattos, R. A. (2008). Os Sentidos da Integralidade: algumas reflexões acerca de valores que merecem ser defendidos. In Campos, G. W. S., Minayo, M. C.S., Akerman, M., Drumond, M, Jr., Carvalho, Y. M. (Orgs.). *Tratado de saúde coletiva* (pp.137-170). Rio de Janeiro: Fiocruz.



Mitre, S. M. et al. (2008). Metodologias ativas de ensino-aprendizagem na formação profissional em saúde: debates atuais. *Ciênc Saúde Coletiva*, 13 (Suppl 2), 2133-44. Opitz, S. P. et al. (2008). O currículo integrado na graduação em enfermagem: entre o ethos tradicional e o de ruptura. *Rev. Gaúcha. Enferm.*, 29 (3), 314-319.

Projeto Político Pedagógico. (2012). *Resolução No 18/2012/Conepe*. Sergipe: Universidade Federal de Sergipe.

Silva, T. T. (2010). *Documentos de Identidade: uma introdução às teorias do currículo*. Belo Horizonte: Ed. Autêntica.

Silva, M. G. et al. (2010). Processo de formação da(o) enfermeira(o) na contemporaneidade: desafios e perspectivas. *Texto Contexto Enfermagem, Florianópolis*, 1 (19), 176-84.

Souza, S. N. D. H. et al. (2012). Currículo integrado: da realidade a novos sonhos. In Kikuchi, E. M., & GUARIENTE, M. H. D. M. (Orgs.). *Currículo integrado: a experiência do curso de enfermagem da Universidade Estadual de Londrina* (pp. 257-276). Londrina: UEL, 2012..

Tanji, S. (2011). As competências do docente tutor no contexto da mudança curricular do curso de graduação em enfermagem do UNIFESO. *Tese de doutorado*, Rio de Janeiro, RJ, Brasil.

AUTHOR INFORMATION

Glebson Moura Silva, glebsonmoura@yahoo.com.br, Brazil, Universidade Federal de Sergipe (corresponding author)

Simone Yuri Kameo, simonekameo@hotmail.com, Brazil, Universidade Federal de Sergipe

Rosemar Barbosa Mendes, rosemarbm@uol.com.br, Brazil, Universidade Federal de Sergipe

Fernanda Gomes De Magalhães Soares Pinheiro, fernandagmsoares@gmail.com, Brazil, Universidade Federal de Sergipe

Andreia Freire De Menezes, deiamenezes1@hotmail.com, Brazil, Universidade Federal de Sergipe

Allan Dantas Dos Santos, allanufs@hotmail.com, Brazil, Universidade Federal de Sergipe

Maria Do Socorro Claudino Barreiro, socorrobarreiro@gmail.com, Brazil, Universidade Federal de Sergipe



LEARNING TO WORK IN A GROUP

Benoit Raucent, Xavier Bollen, Dephine Ducarme, Christine Jacqmot, Elie Milgrom & Sandra Soares Frazao

ABSTRACT

Tutorial sessions, in which students work in small groups in the presence of a tutor, play a central role both in Problem- and in Project-Based Learning. The efficiency of the work done in student groups depends on the degree of positive interdependence between the group members as well as on members recognizing and accepting individual responsibility. However, merely putting students in groups and assigning them a problem to solve does not guarantee that they spontaneously will learn, understand, and adhere to the rules and practices of efficient group work. In order to help incoming high school graduates to work efficiently in groups, the School of Engineering of UCLouvain (EPL - Ecole Polytechnique de Louvain) have designed and implemented a hybrid training session for students who start our engineering curriculum. The communication aims to present this training session and discuss its efficiency.

KEYWORDS: PBL, active learning, training session, tutor training

TYPE OF CONTRIBUTION: Practice based abstract

PRESENTATION FORMAT: Interactive poster presentation

Tutorial sessions, in which students work in small groups in the presence of a tutor, play a central role both in Problem- and in Project-Based Learning. The efficiency of the work done in student groups depends on the degree of positive interdependence between the group members as well as on members recognizing and accepting individual responsibility (Johnson & Johnson 1991). However, merely putting students in groups and assigning them a problem to solve does not guarantee that they spontaneously will learn, understand, and adhere to the rules and practices of efficient group work. The 'natural' tendency of a group will be to decompose the work to be done into a number of tasks and topics and distribute those among individual members, which is probably an efficient strategy if the main goal is to achieve desired results at a minimum cost. This is not at all appropriate in the case of learning-oriented projects (or problems), where every student should reach (more or less) the same set of learning objectives. The division of the work among group members should not be based on the different tasks to be executed, but on similar tasks leading to common learning outcomes. But even in that case, interpersonal problems may interfere with the individual achievement of learning objectives because of unequal or imperfect cooperation by group members (Oakley et al, 2007) and divergence regarding commitment (Wilkerson, 1995; Duek, 2000). Our experience has shown



that a major challenge when implementing learning-based projects or problems is to train students (and teachers/tutors) to acquire the necessary skills to achieve efficient working in groups during the tutorial sessions.

In order to help incoming high school graduates to work efficiently in groups, the School of Engineering of UCLouvain (EPL - Ecole Polytechnique de Louvain) and the Louvain Learning Lab (UCLouvain's Center for teaching development) have designed and implemented a **hybrid training session** for students who start our engineering curriculum, which is strongly based on active learning principles (Frenay et al 2007). The communication aims to present this training session and discuss its efficiency.

THE TRAINING SESSION

During the first week of their first semester, new EPL students participate in a series of preparation and training activities before starting the actual engineering curriculum. Besides being an opportunity to discover the learning environment and the role of the various actors involved in their studies, this week (named APPO after the French-language acronym for PBL) aims to achieve two main goals from the point of view of the students: (1) learn to work efficiently in small groups and (2) carry out reflexive (meta-cognitive) assessments of what they have learned or achieved. To reach these goals, students are required to perform a number of activities involving a sequence of tutored group work and autonomous work/learning. The problems to address concern situations related to their field of studies (engineering); their handling relies mostly on previously acquired scientific knowledge (which may need to be reactivated). The main challenge is therefore the need for an efficient organization of the group, which is composed of students who, at this stage, do not know each other. The timing constraints are rather strict in order to make the need for efficiency quickly apparent.

To help them acquire good team working practices, the tutorial sessions rely on a number of specific **roles**, known to facilitate group effectiveness. During the first tutorial session, each group chooses the roles it deems useful and assigns them to its members. To allow every member of a group – and the tutor – to quickly identify to whom each chosen role has been attributed, we supply each group with a set of “role cards” with the name of the role and an illustration on one side and a brief description on the other side. There are also some blank cards for additional roles chosen and assigned by a group.

For example, the “*Border collie*” ensures that the group achieves its goal, focuses on the objectives and ensures that the group is on time. The “*Moderator*” makes sure everyone is included in the group discussions and ensures that no one person monopolizes the discussions. The “*Scribe*” notes ideas, questions, proposals, tasks to be executed, etc. on the common workspace (the board). The “*Secretary*” synthesizes and communicates the decisions and outcomes of discussions to all the students in the group and to the tutor.



The “*Spokesperson*” synthesizes the group’s point of view and speaks for the group when asked to. Roles are fixed during each tutorial session, but each group is free to reassign roles at the onset of every tutorial.

During the training session, students are invited to tackle a series of activities. At the end of each activity, a reflecting stage questions them on the effectiveness of their group work: the necessity of one or more “new” roles may appear. Role cards are thus introduced gradually based on the group’s experience and self-reflection.

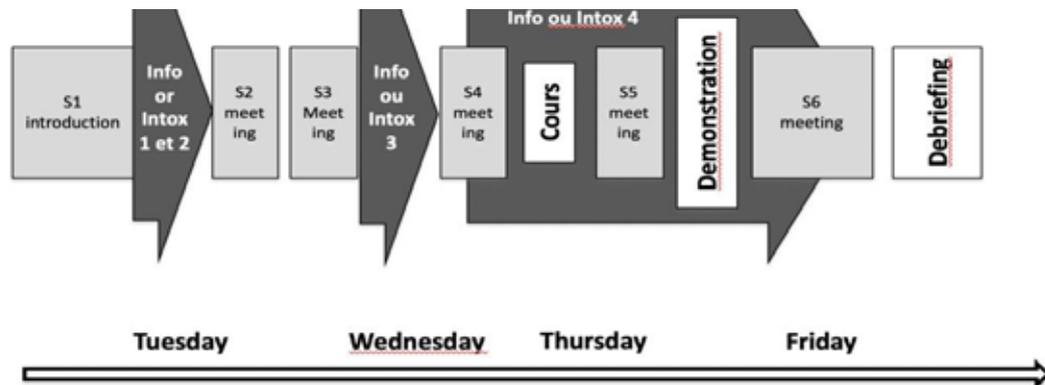
The very first activity in the week is a “kick-off” game, e.g. “*Spaghetti à la Kolb*” (Koefoed 2003) or “*A letter from...*” (adapted from Donckile 1999). In 2019, the kick-off contest consisted in designing a bridge between two tables, solely using sheets of A4 paper and adhesive tape. The winner is the group whose bridge bears the greatest load. This activity makes it easy to highlight the importance of timekeeper and goalkeeper (“Border collie”) roles. The second part of the kick-off consisted in requiring each group to construct a half-bridge, the other half-bridge being built by another group. To ensure a viable connection between the two half-bridges, two students representing each their own group meet for 5 minutes. The groups must thus organize themselves to prepare this meeting. This activity allows to highlight the role of spokesperson.

Next in the week come three problems to be handled according to the usual pattern of a three-stage PBL process: (1) starting tutorial session, (2) autonomous work and (3) closing tutorial session. The first of these three problems involves a duration for each stage of respectively 20-30-20 minutes; the second one increases to 60-120-60 minutes and the third one to 60-300-60 minutes. At the end of each PBL process, the effectiveness of teamwork is assessed by the students themselves. This year, these three problems focused on the theme of quantifying plastic waste in the ocean.

The last activity of the week is a short project, during which the students were asked to design a hydraulic crane and construct a prototype with cardboard and medical syringes. A public demonstration of the prototypes was organized during the last afternoon of the week.



Figure 1



THE SEMESTER PROJECT

After this hybrid training session, first-year students follow a hybrid curriculum containing various kinds of learning activities, including a semester-long project (P1) which is run as an alternation of small group tutorial sessions and autonomous work. The success of this project depends on the efficiency of cooperative group work and the capacity for self-reflection, which were the main goals of the training session.

THE SURVEY

The APP0 training session concerned approximately 400 students. In order to assess its efficiency, i.e. to what degree it reached its stated goals, we have organized a survey both of the students and of the tutors of P1 at the onset of the second semester. It questions (1) about the skills acquired during APP0, (2) those that are considered as the most useful to students for addressing P1 challenges/that were spontaneously deployed from the point of view of P1 tutors; (3) lacking competencies that should be addressed during the training session. The results produced by this survey and their analysis will be presented during the conference.

REFERENCES

Duek, J.E., (2000) Whose group is it, anyway? Equity in Student Discourse in Problem-Based Learning, Chapter 4, Evensen, D.H. and Hmelo, C.E., (eds) (2000) Problem-based learning, a research perspective on learning interactions, Lawrence Erlbaum Associates, p 75-107.

Frenay M., Galand B., Milgrom E., Raucant B. Project- and Problem- Based Learning in the Engineering Curriculum at the University of Louvain, , Management of Change, Implementation of Problem-Based and Project-Based Learning in Engineering, E. de Graaff and A. Kolmos Eds., Sense Publishers Rotterdam/Taipei, 2007, pp93-108.



Johnson, D.W., Johnson, R. (1991) Learning together and alone: Cooperation, competition and individualization (3rd edition), Englewood Cliffs,NJ, Prentice Hall.

Kofoed, L. B. ; Rosenørn, T., (2003), A Game in the Game. In: Experimental Interactive Learning in Industrial Management, Proceedings of the 7th international workshop on experimental learning in industrial management. May 2003,Aalborg : Center for Industrial Production, Aalborg University,

Kolb, D. (1984). Experiential Learning: experience as the source of learning and development. Englewood Cliffs, NJ: Prentice Hall. p. 21

Oakley, B.A. Hanna, D.M., Kuzmyn, Z., Felder, R.M. (2007),Best Practices Involving Teamwork in the Classroom: Results From a Survey of 6435 Engineering Student Respondents, IEEE Transactions on Education; Aug2007, Vol. 50 Issue 3, p266-272

Raucent B., 2004, What kind of project in the basic year of an engineering curriculum, Journal of Engineering Design, vol 15, pp 107-121.

Wikerson, L., (1995) Identification of Skills for the Problem-Based Tutor: Student and Faculty Perspectives, Instructional Science, 23(4), 303-315

AUTHOR INFORMATION

Benoit Raucent, benoit.raucent@uclouvain.be, Belgium, Uclouvain (corresponding author)

Xavier Bollen, xavier.bollen@uclouvain.be Belgium, UCLouvain

Dephine Ducarme, delphine.ducarme@uclouvain.be, Belgium, UCLouvain

Christine Jacqmot, christine.jacqmot@uclouvain.be, Belgium, UCLouvain (corresponding author)

Elie Milgrom, Elie.Milgrom@fa2l.be, Belgium, FA2L

Sandra Soares Frazao, sandra.soares-frazao@uclouvain.be, Belgium, UClouvain



ACTIVE LEARNING (AL) IN SELECTION PROCESSES OF ENGINEERING PROGRAMS

Maria Patricia León Neira, Alejandra Maria Gonzalez Correal, Joan Sebastián Peña Campos & Juan Sebastián Fontalvo García

ABSTRACT

Pontificia Universidad Javeriana, is a high education private institution that operates in Colombia and has as its mission to train professionals in the framework of excellence and service to the country. Colombia is a developing country, which since 2019 is a member of the OCDE and has the goal, in the learning field, to develop an educational reference framework at all levels, that responds to the diversity that characterizes the country and can advance to an equitable and high quality education.

During the admission cycle of the programs of engineering includes the process of measuring the level of abilities and skills, through learning assessment processes that allow the candidate to generate knowledge and develop skills during these activities. Each assessment process is an observatory that allows students to learn, receive motivation and be evaluated.

The admissions challenge is designed to give applicants an experience that demonstrates the skills and abilities they have in a learning space, accompanied by peers, teachers and a teamwork expert. An expert educator observes the interactions of candidates in the process in order to assess the teamwork ability and grade the motivation and interest for study an engineering program. All these assessments are supported by rubrics in which the high and low level of skills is specified among which applicants can be found.

KEYWORDS: Active Learning, Engineering, Selection process, Accompaniment

TYPE OF CONTRIBUTION: Practice-based abstract

PRESENTATION FORMAT: Interactive poster presentation

Pontificia Universidad Javeriana, is a high education private institution that operates in Colombia and has as its mission to train professionals in the framework of excellence and service to the country. Colombia is a developing country, which since 2019 is a member of the OCDE and has the goal, in the learning field, to develop an educational reference framework at all levels, that responds to the diversity that characterizes the country and can advance to an equitable and high quality education. A diagnosis of the educational quality has come realizing by means of the application of the PISA tests. The results of these tests show that the levels in basic competences in reading, sciences and mathematics are below the average of other



countries, thus some of the student skills and abilities for face an engineering program have to be level up in the undergraduate studies.

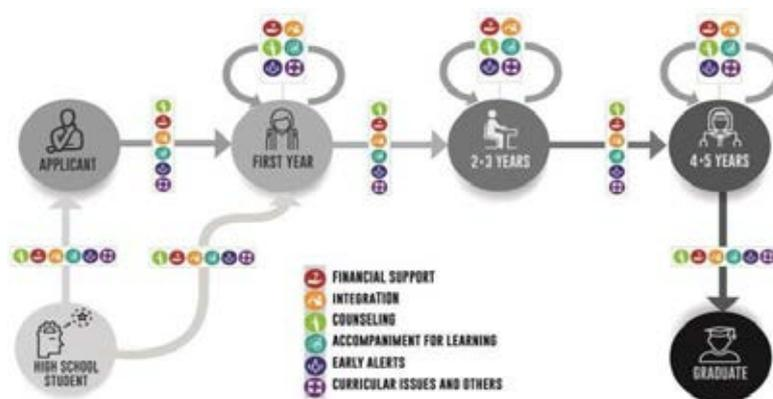
The National Education Office establishes the levels of expected achievement that students should reach during high school training. However, it has been shown that there is a significant gap between the target levels and the abilities required for undertake an undergraduate program. Then, to measure the difference and mitigate it, become a responsibility of the university institutions (Gonzalez, Barrera, Leon, Curiel, & Prieto, 2018).

The university has developed and implemented a model of accompaniment along the college life to support the students in the transitions. The purpose of the transitions model is to identify the accompaniment routes that will allow the student to advance in his formative process. (Gonzalez *et al.*, 2018). [Figure 1](#) shows than the "Potential Applicant" is a state in the cycle of formation. During the selection and admission stage the applicant receives a specific support specifically in the context of accompaniment for learning.

The admission cycle includes the process of measuring the level of abilities and skills, through learning assessment processes that allow the candidate to generate knowledge and develop skills during these activities. Each assessment process is an observatory that allows students to learn, receive motivation and be evaluated.

In addition to being an assessment tool, the admissions process looks forward to give the student an approximation to the work of the engineer and open a space to give sufficient and relevant information that allows the candidate to choose his/her career consciously. The process lead the candidate closer to the philosophy of accompaniment and metacognition of the institution and to some of the pedagogical methodologies used by the program, through which competencies associated with collaborative work, problem solving and communication are developed.

Figure 1. Student Development Model (Jaramillo *et al*, 2018)





The admissions challenge is designed to give applicants an experience that demonstrates the skills and abilities they have in a learning space, accompanied by peers, teachers and a teamwork expert. The problem is set by the faculty and by the CAE+E (Teaching Learning and Evaluation Center) in order to generate an activity where learning is student-centered and the professor acts as a guide to the process.

The activity is carried out in groups of up to 5 applicants who have a time of 150 minutes to solve the problem and propose the solution. The objectives and some basic concepts are presented at the beginning of the activity and it is settle down as a challenge.

Applicants have reference material that can be used in order to explain doubts during the activities. Professors have the function of clarifying doubts, raising conceptual elements during the development of the activity in such a way that the applicants can broaden their vision of the problem and give feedback to their task. Additionally, a previously qualified group of students of undergraduate engineering programs acts like facilitator of the process.

An expert educator observes the interactions of candidates in the process in order to assess the teamwork ability and grade the motivation and interest for study an engineering program. All these assessments are supported by rubrics in which the high and low level of skills is specified among which applicants can be found.

As example, it is described the selection processes of Civil Engineering and Electronics Engineering.

AL IN CIVIL ENGINEERING ADMISSION PROCESSES

A group of applicants must propose the infrastructure solutions for a settlement with context restrictions. The solutions must take into account a sustainable approach, so some concepts are explained at the beginning of the activity. The challenge includes the approach to the transit and transport system, the municipal public services system (water supply, wastewater treatment, solid waste disposal and electric power supply) and the city buildings that includes restrictions on the design and construction of their foundations and structures. The areas of geotechnical engineering, structures, hydraulics, basic sanitation, transportation, management and construction interact in the final solution presented by the applicants. The approach to the engineering solution is represented using a Lego® kit, and it is common that applicants find that putting together the solutions presents interference between the solutions raised individually. During the session the professor and the support students help to solve the doubts that are raised by the students.

AL IN ELECTRONICS ENGINEERING ADMISSION PROCESS

The admission process of the first term of 2020 had three different challenges: one in the area of renewable energies, the other in robotics and the last one in Internet of Things.



The renewable energy challenge seeks to bring applicants to approach alternative solutions to provide energy to schools located in places without electrical interconnection through design using basic math tools. The challenge in IoT, allows applicants an approximation to the concepts of Industry 4.0, gives them a broad view of the use of cutting-edge technology and arouses a social responsibility by putting technology to the use of different populations. Finally, the robotics challenge allows candidates a learning experience through systemic reasoning and teamwork, solving a commodity distribution challenge.

RESULTS

The admission process is developed with tools that allow having a more objective vision than other techniques, such as the interview, about the grade in which an applicant has developed the competences associated to the entrance profiles of the engineering programs. In addition, the information collected during the admission process helps to detect populations at risk, which allows us to accompany the processes of adaptation to the university life of these students.

In order to have a feedback about the process, a survey was applied to collect perceptions about the selection activity, 91 admitted students completed the survey. The results of the survey bring important issues to the admission process as follows, the 100% of the students stated that they agreed or strongly agreed that the activity helps to decide their career. This is consistent with the fact that 95% of the applicants considered that the activity would clarify the object of study of the career. A high percentage of dropouts from the programs are associated with adequate vocational orientation, this type of activity allows the applicant to have an experience close to the work of his or her profession.

Regarding the AL methodology, 60% of the students stated that the professor acted as a facilitator of the process and the result of motivation validates the methodology and encourages learning. This last point is supported by 95% of students who consider that with the activity they learned new technical engineering concepts.

CONCLUSIONS

Including learning processes in the admission activities allows to generate motivation in the candidates and is considered as an opportunity to show the institutional culture and the teaching-learning methodologies of the program, which are alienated with PBL and AL (CDIO).

These types of challenges are tools that allow the characterization of the applicants, in such a way that weaknesses can be detected early on and intervened with the accompaniment strategy of the Faculty when become a freshman.



Additionally, students can take advantage of this activity to strengthen their vocational decision, which is one of the main causes of dropout from engineering programs.

The paradigm of accompaniment that is part of the institutional culture is consistent with admission activities, in which professor act as guides and facilitators of the learning process.

REFERENCES

Gonzalez, A., Barrera, D., Leon, M., Curiel, M., & Prieto, L. (2018). Student Success: On the need for a new standard. Proceedings of the 14th International CDIO Conference. Kanazawa, Japan.

Jaramillo Correa, C., Ordóñez Torres, C., González Correal, M., León Neira, P., Curiel Huérfano, J., Palacios Molina, J., & Barrera Ferro, D. (2018). Formulación Del Programa De Prevención De La Deserción: Articulación De Acciones En Un Programa Transversal De Acompañamiento Para La Pontificia Universidad Javeriana. 2018: Congreso CLABES VIII, Ciudad de Panamá, Panamá. Retrieved from <https://revistas.utp.ac.pa/index.php/clabes/article/view/1978>

AUTHOUR INFORMATION

Maria Patricia León Leon, mpleon@javeriana.edu.co, Colombia, Pontificia Universidad Javeriana (corresponding author)

Alejandra Maria Gonzalez Correal, agonzalez@javeriana.edu.co, Colombia, Pontificia Universidad Javeriana (corresponding author)

Joan Sebastián Peña Campos, pena.johan@javeriana.edu.co, Colombia, Pontificia Universidad Javeriana (corresponding author)

Juan Sebastian Fontalvo Garcia, fontalvoj@javeriana.edu.co, Colombia, Pontificia Universidad Javeriana (corresponding author)



PBL FROM AN ADMINISTRATOR POINT OF VIEW

Angélica Burbano

ABSTRACT

Efforts for PBL implementation should be done not just at the course level, the consideration of the school and institution guidelines should facilitate its implementation. Administrators (department heads, program directors and deans) should also participate in faculty development programs such as PBL workshops in order to understand the implications of a PBL implementation in order to make the necessary changes at the required levels (program, school or institution) and to provide the resources eg. Time and workspaces to make an environment for PBL. A group of faculty members working together could learn from each other but also provide a test bed for PBL implementation efforts. This paper presents the reflection of PBL practices and faculty development efforts from the perspective of a department head at the school of engineering in a south American institution. This institution is a private one, with about 6000 students out of which the school of engineering represents 16% of total student population.

KEYWORDS: PBL, engineering, faculty development

TYPE OF CONTRIBUTION: Practice based abstract

PRESENTATION FORMAT: Interactive poster presentation

The author has chosen not to have their full paper published in the conference proceedings. We encourage you to look for existing or future publications by this author in other outlets.

AUTHOR INFORMATION

Angelica Burbano, aburbano@icesi.edu.co, Colombia, Universidad Icesi



THE PROCESS OF LEARNING AND GROWING OF PEER SUPPORTERS THROUGH PLACE MANAGEMENT: FOR CURRICULUM AND CO-CURRICULUM HYBRIDIZATION

Hironori Yamaguchi, Kanae Murayama, Keiko Kitade, Chika Tohyama & Yuko Yasuda

ABSTRACT

In Japan, environments that stimulate proactive learning of students outside the classroom are called "learning commons" and are now actively introduced in universities' more significant part. In that space, not all students are good at online communication, so student facilitation as peer support activity is essential to supplement faculty supervision. This qualitative study analyzed students' learning outcomes (five students were selected) who engaged in peer support in the learning commons on campus using a PBL framework. In other words, the study examined whether exemplary citizenship maturity was brought about through learning facilitation by students who designed the space and created dynamic communication. All five interviewees had experience as management staff of "the Beyond Borders Plaza" (BBP) Ritsumeikan University, which was opened for international exchange and language at all campuses in 2018. One of the characteristics is that most of them were altruistically motivated to continue their activities, not necessarily to see continuity as a virtue, but sincerely trying to fulfill their roles. In short, it is crucial to generate and share beliefs that allow people to believe in their successes, wait for their actions, and forgive their failures as individual concrete experiences are abstracted through mutual communication. For this reason, the supervision of teachers as mediators and interlocutors is inherent to support these peer supporters.

KEYWORDS: learning commons, internationalization, service-learning, co-curricular, PBL step

TYPE OF CONTRIBUTION: Practice-based abstract

PRESENTATION FORMAT: Interactive poster presentation

INTRODUCTION

Students learn not only on campus but also in local businesses, community societies, and many other places. In Aalborg University, which has a long history of PBL, there are many small spaces in the corridors and libraries for students to discuss their work. In Japan, such "environments that stimulate proactive learning of students outside the classroom" (Yamada, 2015) are called "learning commons" and are now actively introduced in the more significant part of universities. On the other hand, with the lockdown of campuses under COVID-19, such learning commons are no longer in physical spaces but online communication



platforms. In this case, not all students are good at online communication, so student facilitation is essential to supplement faculty supervision.

Peer support by student facilitators, especially in small group discussions, can "highlight the issue of participation in real decision-making" (Cowie & Patti, 2000). Furthermore, as Buckley & Lee (2018) stated, "identifying a wide range of additionalities to the student experience," such active learning can be found in class and extra-curricular activities, and in co-curricular learning.

PURPOSE AND METHOD

This qualitative study analyzed students' learning outcomes (five students were selected) who engaged in peer support in the learning commons on campus using a PBL framework. In other words, the study examined whether exemplary citizenship maturity was brought about through learning facilitation by students who designed the space and created dynamic communication, focusing it as an opportunity for "exercising responsibilities and initiatives" (Click, 1998).

Specifically, we position our cases in Ritsumeikan University as collaborative practices of the innovative and learner-centered approach in the Dimensions of PBL curriculum elements by Kolmos et al. (2009). In doing so, we apply the PBL step ladder model constructed by Mogens Jensen (Jensen, 1991; Yamaguchi et al., 2018, see Figure 1) to discuss the pattern of project development.

Figure 1. PBL Stepladder Model (Jensen, 1992)

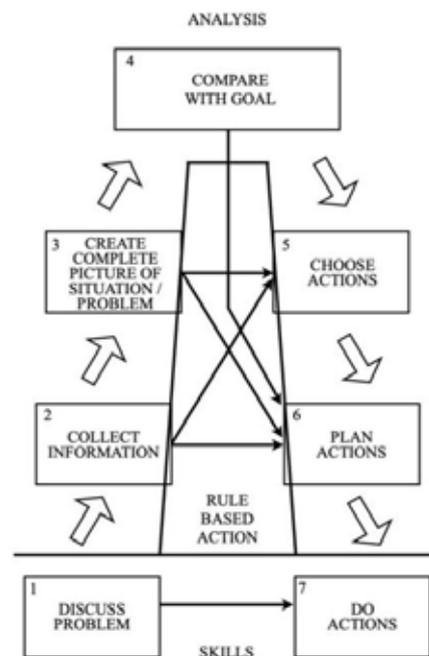


Figure 1. PBL Stepladder Model (Jensen, 1992)



Ritsumeikan University has three campuses (Kyoto, Shiga, and Osaka) in the West Japan area, established learning commons "the Beyond Borders Plaza" (BBP), which was opened for international exchange and language at all campuses in 2018. This is the result of a democratic action of Ritsumeikan University students from 2016 to promote the internationalization of Ritsumeikan University under the vision of "Beyond Borders".

Reflecting the fact that the educational philosophy of Ritsumeikan University is "Peace and Democracy," students proposed that language learning, international exchange, and support for studying abroad were imperative to be concrete in the globalization and sustainable society. For this reason, students, staff, and teachers started to collaborate on managing places by learning from precedent examples of Ritsumeikan University's service-learning centers that support volunteer activities in local communities since 2008.

RESULTS

All five interviewees had experience as management staff of BBP. As already mentioned, Ritsumeikan University considers the BBP to be a critically important learning commons for promoting internationalization, so students applying for BBP management staff must submit an essay (free format to fit onto one A4 page) in which they describe their reasons, along with a self-evaluation on a 5-point scale in the following eight areas: Leadership, Cooperative, Sense of Responsibility, Communication Skills, Problem-Solving Skills, Proactive, Time Management, and Language Skills. Therefore, what all five students had in common was that they were committed to peer support with a deep understanding of the necessity and importance of promoting language learning, learning experiences exchange, internationalization and democratization. However, each student's focus was different, whether improving their language skills, promoting multicultural understanding, or providing counseling on study abroad and exchange experiences after their study abroad.



Table 1. Results of interviews with five peer supporters of the Ritsumeikan Beyond Borders Plaza

	nationality	Study abroad experience at the time of application	reason for applying	reward	role	relationship	COVID-19 reaction	pattern
A	Japan	not yet (Thailand)	improve English skills for preparing a study in Thailand and encourage students who have no desire to study abroad		coordination of international exchange	support followers	quitted, due to study abroad	Selfish motivation, but altruistic contribution in the other circle
B	Japan	yes (Germany)	have the opportunity to maintain and develop language skills gained through studying in Germany, and promote about studying in Germany		coordination of international exchange	If anything, indemet	continue	Selfish motivation, but altruistic contribution
C	China		improve Japanese language skills through supporting communications between international and Japanese students		coordination of international exchange	support a new leader	continue	Selfish motivation, but altruistic contribution
D	Japan	not yet (Canada)	promote the use of the learning commons as a former user and plan some events based on own interests	postive	planning events	encourage colleagues	continue	Selfish motivation, but altruistic contribution
E	China		plan events that make use of own unique skills and hobbies because of loving international exchange	postive	planning events	support followers	quit, accomplish a mission	altruistic contribution, but could not find selfish meaning

We interviewed each of the three times and summarized the results are as Table 1. One of the characteristics is that most of them were altruistically motivated to continue their activities, not necessarily to see continuity as a virtue, but sincerely trying to fulfill their roles.

DISCUSSION

The fact that peer supporters in BBP were able to reflect critically on their roles without making a virtue of continuity is since they did not shortcut the steps of the PBL step ladder model (especially the process from "3. Create Complete Picture of Situation/Problem" to "5. Choose Actions" via "4. Compare with Goal"). That result is consistent with the theory for building an altruistic relationship by Ash & Clayton (2009) that personal, civic, and academic growth occurs through reflection.

In short, it is crucial to generate and share beliefs that allow people to believe in their successes, wait for their actions, and forgive their failures as individual concrete experiences are abstracted through mutual communication. For this reason, the supervision of teachers as mediators and interlocutors is inherent to support these peer supporters.



REFERENCES

Ash, S. L., & Clayton, P. H. (2009). Generating, deepening, and documenting learning: The power of critical reflection in applied learning. *Journal of Applied Learning in Higher Education*, 1(1), 25-48. <http://hdl.handle.net/1805/4579>

Buckley, P. & Lee, P. (2018). *The impact of extra-curricular activity on the student experience. Active Learning in Higher Education*, 1, 1-12. <https://doi.org/10.1177/1469787418808988>

Cowie, H. & Patti, W. (2000). *Peer Support in Action: From Bystanding to Standing* by. SAGE.

Crick, B. (1998). *Education for Citizenship and the Teaching of Democracy in Schools: Final report of the advisory group on citizenship*. Qualifications and Curriculum Authority.

Kolmos, A., de Graaff, E., & Du, X. (2009). Diversity of PBL: PBL learning principles and models. In X. Du, E. de Graaff, & A. Kolmos (Eds.), *Research on PBL practice in engineering education* (pp. 9–21). Sense.

Yamaguchi, H., Jensen, M. & Feilberg, C. (2018). Discussion on methodology to go up and down learning stepladder properly: from a comparative study of supervision in PBL and relationship building in service learning. In Conference Proceedings PBL2018 INTERNATIONAL CONFERENCE (2018) *PBL for the Next Generation Blending active learning, technology, and social justice*. February 16-19, 2018, Santa Clara, California, USA (pp. 1-12). PANPBL.

Jensen, M. (1991). *Kollegial Supervision: En kortfattet introduktion*. Unpublished manuscript.

Yamada R. (2015) Student Learning through Active Learning: How Learning Commons Support Students' Independent Learning. In D.E. Neubauer, K. Ghazali (Eds.), *Technology and Workplace Skills for the Twenty-First Century. International and Development Education* (pp. 77-93). Palgrave Macmillan. https://doi.org/10.1057/9781137491923_7

AUTHOR INFORMATION

Hironori Yamaguchi, gucci@fc.ritsumei.ac.jp, Japan, Ritsumeikan University (corresponding author)

Kanae Murayama, kanaem@fc.ritsumei.ac.jp, Japan, Ritsumeikan University (corresponding author)

Keiko Kitade, kitade@lt.ritsumei.ac.jp, Japan, Ritsumeikan University

Chika Tohyama, tohyama@law.ritsumei.ac.jp, Japan, Ritsumeikan University

Yuko Yasuda, yvr10067@fc.ritsumei.ac.jp, Japan, Ritsumeikan University



**Professional development/staff development
for PBL and active learning**



USE OF PROJECT-BASED LEARNING IN PREPARATION OF EDUCATION MANAGERS: CASE OF POST-SOVIET AZERBAIJAN

Lala Mammadova

ABSTRACT

This qualitative study explored the level of implementation of Project-Based Learning (PBL) in Master of Education Management Program in Azerbaijan. Two universities that offer this program, were chosen as a sample for the research. The aim of the analysis was to find out how the sample universities integrate projects into their program and whether there was a sign of systematic PBL model in any of the universities. Face-to-face interviews with the academic staff and administration of the programs were conducted as the main methodological tool. Additionally, the curricular of programs in both universities were scrutinized to find the consistency in the offered subjects. Although the courses offered in both programs are quite suitable for PBL integration, only in one of the sample universities, there is a sign of extensive use of projects, yet mainly in a single assignment level. The overall results allow us to claim that Azerbaijani universities still need to develop a well-structured PBL model adapted to the local context and opportunities to be able to produce marketable educational managers. The results of the interviews emphasize the crucial role of PBL in learning of employable skills and competences in education management. Major perceived limitations in the process of PBL implementation are articulated to be the lack of awareness about PBL, inadequate organizational support in the form of staff trainings, provided facilities, and negotiations with stakeholders.

KEYWORDS: Project-based learning, higher education in Azerbaijan, Master of Education Management, teaching approach, teacher perspectives.

TYPE OF CONTRIBUTION: Full scientific paper

PRESENTATION FORMAT: Interactive paper

The author has chosen not to have their full paper published in the conference proceedings. We encourage you to look for existing or future publications by this author in other outlets.

AUTHOR INFORMATION

Lala Mammadova, lmammadova@ada.edu.az, Azerbaijan, ADA University (corresponding author)



PBL BEGINNINGS AT BRAZILIAN SCHOOL

Eli Borochovicius & Elvira Cristina Martins Tassoni

ABSTRACT

Problem-Based Learning (PBL) is a teaching and learning method that seeks to develop conceptual, procedural and attitudinal content with collaborative work. Although it was created in a medical school and spread around the world with its use mainly in Higher Education, there are reports of its application also in Elementary Education, but no research was found with its use in Brazilian schools. The text brings the result of an experience of a qualitative research of the collaborative type, with the objective of identifying the changes in the teaching and learning relationship with the application of PBL in a discipline of Elementary Education of a public school in the interior of São Paulo. The results showed that PBL allows the teacher to get closer to the students, enhancing learning.

KEYWORDS: PBL, Middle School, Secondary School, Teacher Training

TYPE OF CONTRIBUTION: Full scientific paper

PRESENTATION FORMAT: Interactive paper presentation

INTRODUCTION

The Programme for International Student Assessment (PISA) presents indicators that can be used by governments as a working tool in the definition and improvement of educational policies, making the training of young people more effective. Brazil has presented results below the average of the countries of the Organization for Economic Cooperation and Development (OECD) when comparing the grades of students enrolled in the seventh grade of Secondary School (from 12 to 13 years old).

Table 1: Brazilian results on PISA. Fount: By the authors, based on data of PISA.

	2000	2003	2006	2009	2012	2015
Brazil Avarage	368	383	384	401	402	401
OCDE Avarage	496	498	493	496	494	493
Ratio of Avarages	34,78%	30,03%	28,39%	23,69%	22,89%	22,94%



Although Brazil has a low score, the country has been comparatively improving its results with each edition and reducing the difference in scores. It is inferred, therefore, that despite presenting unsatisfactory results, there is a movement for continuous improvement.

Spending on Brazilian students represents 42% of the average spending on students from OECD countries, but other countries in Latin America achieved better results compared to Brazil and lower average cost per student, therefore, unsatisfactory results in PISA cannot be attributed exclusively to low investments in education.

According to Hatie (2009), several countries have undergone reforms, including new curricula, teacher training, literary works, management and teaching resources. School failures have already been attributed to managers, teachers, parents, students, resources and even methods. Listing all the problems and all the proposed solutions would be unfeasible, as well as comparing the evidence from the most diverse studies on what works and what does not for the presentation of better teaching and learning results.

The student's academic performance is the result of different factors that act at various levels of social insertion: the socioeconomic conditions of the family, the socio-cultural environment of the school, the relations and didactic practices in the classroom, among others. The school's infrastructure and equipment have a strong impact on the school's performance, as well as the characteristics associated with the teacher and his interaction with students, the student's motivation to learn and conversations at home about what happens at school. To reduce the disparity in educational opportunities and the consequent reduction in social and economic inequality, substantial improvements in Brazilian public education are needed (Barbosa, M., Fernandes, C., 2001).

Teaching conditions in Brazil are often perverse, with many students in the classroom, inadequate teaching materials, poor libraries, low teacher salaries, and poor physical spaces (Luckesi, C. C. (2011)).

Godoy, AS, (2000) understands that Brazilian schools often use lectures focused on the transmission of knowledge and the content to be learned is presented by teachers to students in its final form, depriving them of the exercise of more complex activities. intellectual skills such as application, analysis, synthesis and judgment.

Considering that teacher-student interaction as well as classroom instruction are relevant issues to ensure good quality education, could PBL be part of an appropriate solution to help students in Brazilian schools better internalize knowledge.



The discussion of teaching and learning methods should not be protagonist in the roles of education and school, but the more active, critical and reflective the subject in the teaching and learning process, the greater the chances of producing positive changes in education and learning society (Snyders, G. (1988)).

According to Ribeiro, L. R. C. (2008), the PBL emerges as an alternative for the construction of knowledge, as it is a teaching and learning methodology in which a problem is used as the beginning of discussion of a concept or content, with direction of teacher of what is produced by students in small groups, motivating them to research.

It is understood that the PBL is a method that allows a great variety of teaching and learning strategies, not suppressing the possibilities of the teacher to develop also lectures and dialogues. Interaction and rapprochement with the student in collaborative work, however, can enhance the teacher's findings regarding the needs of students, usually not verbalized, and promote the overcoming of issues that may compromise learning.

In fact, no one agrees with a single definition of PBL. Different schools have adopted their own model and define the PBL according to their way of working (Azer, S. (2008)).

There are several ways to characterize PBL, but the essence, according to Handgraft, R., Prpic, J. (1999), is given by five elements: 1. The problem is the guiding learning; 2. Many concepts are integrated and various skills are required; 3. The work is in group; 4. Must be procedural; 5. There must be commitment to self-learning.

The higher incidence of PBL studies is with predominantly adult students in Higher Education, possibly due to the fact that the method was created for professional use, but Ribeiro, L. R. C., (2008) considers that its principles enable its use in other areas of knowledge and its use is also viable for schools.

Barrel, J. (1998) points out that many teachers in the United States have challenged their students to experiment with PBL-based teaching and learning strategies, such as Bradford Elementary School, Solomon Schecter School, Dumont High School, Jefferson Township High School and James Caldwell High School.

A literature review was performed at Scientific Electronic Library Online - Brazil, the main base of scientific journals in Brazil, as well as at Brazilian Digital Library of Theses and Dissertations, and no studies were found using the PBL in Brazilian Secondary School, a gap that could be filled with an innovative study.

Based on the assumption that the PBL can be a methodological resource for teaching practices in the teaching stages prior to graduation and that the method enhances classroom relationships, as well as, considering that the interaction of the teacher with the student and didactics in the classroom are relevant issues for



good educational performance, was formulated the question: Can the PBL, applied in an Secondary School discipline of a public school, to create possibilities for the teacher to get closer to students, offering opportunities to enhance teaching and learning?

In order to answer the question outlined, this article is based on an original and unprecedented investigation carried out in 2018 with students of the 7th grade (students between 12 and 13 years old) History subject of a Brazilian public school, whose general objective was to analyze the potential use of the PBL method in building relationships in the classroom that can promote changes in the teaching and learning processes.

THE RESEARCH

The interest was to develop the research in a Brazilian public school, with poor performance in government evaluations and that was close to the city where the researcher lives, given the need for routine monitoring required by the research.

Brazil has its own indicators of educational assessment, such as the Basic Education Development Index, created by the Anísio Teixeira National Institute for Educational Studies and Research in 2007, whose initiative is to measure the quality of education considering the following variables: school flow and performance averages.

The Basic Education Development Index result of the chosen school presented almost one point below the average of the all other schools in the city. The projections of the indexes for future years were challenging and the application of a method that allowed the teacher to be closer to the students could favor the teaching-learning relationship and help the school to achieve this goal. The research did not aim to measure the improvement in the results of the index, nor was it committed to analyzing the changes that occurred, but the index allowed to select a school in a more challenging context for the application of the method, analyzing its potentialities for the process of teaching and learning.

The school is located in the most populous region of the city, has 22 classrooms, only three of them with digital board. It has a library with few textbooks, atlases and magazines. The school also has a covered sports court, used in Physical Education classes, and the other spaces are intended for administrative activities, such as boardroom, support, secretary and warehouse.

The school serves a large number of remote neighborhoods where basic infrastructure is absent, there are family disorders, nutritional deficiency, illiteracy, domestic and urban violence, violence against women, drug trafficking and use, abuse and intolerance.



There are no open and harmonious living spaces that promote the socialization of teachers, staff and students, in a pleasant environment for discussion, reading or study. There are no outdoor environments and recreational areas. During lunch, students stand in the small space of the cafeteria. The feeling is one of permanent confinement and there are rare moments when students are removed from their classrooms.

The library is very small and the number of books to research is extremely limited, making the activity of research hard, an important step in the method. Books can be loaned to students, who usually do not return them, making the library with fewer books available for consultation. There are no fines, remembering that is a public school, usually used by poor communities.

The school also does not offer a computer lab, indispensable for accessing a digital bibliographic collection, consulting web sites and with the possibility of writing reports and visual material for presentation. The scarcity of technological resources reduces the possibilities of research and considerably reduces the conditions for the proper development of the method, but does not make it impossible since students have textbooks available.

There are no technological equipment in most classrooms, such as a projector and a speaker, that allow the teacher and students to use, the rooms are hot and in some of them there is no door or the state of conservation is precarious, making acoustics difficult and impairing student's attention that is often interrupted by external occurrences.

Issues related to administrative processes also influence school routines. Throughout the year of research development, the school changed the principal four times. Frequent change in leadership can cause insecurity in school staff and teachers, making it difficult to develop ongoing projects.

The teacher absences during the school year is regular. There is no substitute teacher, so if a teacher doesn't come, students are left without class. The frequent absence of teachers and activity has a euphoric effect on children, making it difficult for the next classes to progress smoothly.

For the research, a teacher of the discipline of History volunteered, who chose to use the method with his four classes of 7th grade. The volunteer teacher has a bachelor's degree (2009) in History. During graduation, he started to work in an activity unrelated to the area of Education. Although adapted to the job, he was interested in developing a professional activity that was closer to his area of training. His interest in research led him to abandon the employment and join a graduate program. His master's dissertation was defended in 2013. With the expansion of the federal technical education network, the professor envisioned the possibility of entering the teaching career. In search of teaching experience, he held competitions for municipal schools and began his teaching career in 2015. The following year, he was transferred to the school where the



investigation was carried out. Although the teacher's initial intention was to gain experience in the classroom to plead for the federal teaching profession, he felt instigated by elementary education, especially regarding didactic and pedagogical approaches aimed at the adolescent public. From his initial experiences, the teacher has been developing reflection on formal education in this teaching stage, which led him to show interest in this research and to volunteer as a participating subject.

The teacher, who had never worked with PBL, participated in 2017 as an observer of three classes of the researcher, who works since 2009 with the use of the method in Higher Education. The main objective was to provide the teacher with reflections on the possibilities of PBL with Secondary School students. Also in 2017, the volunteer teacher and the researcher met several times in order to create the problem situations and other documents that would be used in 2018 and that were the object of analysis. Throughout 2018, the professor forwarded his reflections, concerns, joys and sufferings, written spontaneously and without directing the researcher, which culminated in 134 pages of text, reduced to 39 pages when all texts that were not directly related to events in the classroom were excluded. There was no pre-established periodicity for the teacher to forward his narratives, they were written when he felt the need to express his feelings, to report events or to discuss with the researcher any subject related to the method. Three interviews were carried out with the volunteer teacher, one before starting the work, to get to know his expectations with the method, something new for him, another interview at the end of the first semester to know the initial results and the needs for changes and an interview at the end of the school year to identify the changes that the PBL promoted in the teacher's perspective. The researcher also made several observations throughout 2018 and at the end a questionnaire was conducted with the students to find out, in general, what they thought about the PBL, after having experienced it and tried it over a year school.

The research did not focus on presenting comparisons with the model currently used at school, but on presenting an alternative to live the teaching and learning experience, without the need for investment in infrastructure and technology, expansion of teachers, curricular changes or discard materials already used by the public education system. Any initiative that requires more investment would be difficult to implement. The object of study was centered on the teacher, who used PBL to create a closer relationship with his students, better understand his weaknesses and encourage them to overcome the deficiencies of collaborative work, improving learning.

This article presents the results of the questionnaires that were applied to students at the end of the investigation. Excluding dropout, transfer and relocation students, there were 116 participating students, distributed in four 7th grade classes, 26 students in class One, 34 students in class Two, 29 in class Three and 27 in class Four. Of the 116 students belonging to the four classes, only 68 brought their parents'



authorization and accepted to participate voluntarily in the research. Thus, results based on the responses of these students are presented.

Aiming to know the profile of the students, the teacher applied, at the beginning of the school year, a socioeconomic and cultural questionnaire. Most of these students are at the correct grade, live in their own home and belong to the low-income family. 96% of students have Internet access in their houses, so they are able to do researches at home. Reading for a survey is paramount and 63% of students report that they have a habit of reading. 44% of students come to school because of friends, 38% enjoy learning and 19% report other reasons, such as teacher, lunch and Physical Education. When not in school, they enjoy surfing the Internet, chatting on social networks and watching television. Many say they also play with friends, enjoy video games, play sports and stay out, but have not reported studying or reading books.

The questionnaire contained eleven multiple-choice questions with only three alternatives each. The objective of reducing the number of alternatives was to make the questionnaire more appropriate to the age of the respondents, reducing the possibility of misinterpretation and minimizing the possibility of returning the material without completing it completely. In addition to the questions, a space was made available for the student to make any comments regarding the PBL method. The results are presented below.

FINDINGS

The classroom is a definite space for cognitive and social interactions. The interdependence of individuals is a preponderant feature, requiring collaboration from all group members and emphasizing individual responsibility and reciprocity (D'Avila, C. M., 2003).

Students are accustomed to a teaching environment in which the teacher conveys knowledge from a reproductive perspective of knowledge and tend to be shocked as they develop problem-based work. In this environment, several cultural changes occur and the first one manifests when the student faces a collaborative environment (Munhoz, A. (2015)).

In the analysis of the questionnaire applied to students, it was identified that 49% of the 68 students said they liked working with the method, 31% had no opinion and only 19% reported not liking to participate in classes with the use of PBL. Of this universe, 30% stated that they would like to choose their team members. It seems that the school invests little in collaborative work, so it is clear the resentment of students with work group.

The analysis of the questionnaire allowed us to identify that 35% of the students were more comfortable expressing their doubts, but it also showed that 29% were more embarrassed, ashamed to take their doubts close to their colleagues. It was expected that students would like to develop work with their closest



colleagues, but the literature shows that heterogeneity creates possibilities for discussions that favor reflection, critical thinking and contribute to human formation. Anyway, 44% of the students said they enjoyed working with their colleagues, 25% did not like it and 31% said they prefer to learn individually.

The analysis of the questionnaire allowed us to identify that 35% of the students were more comfortable expressing their doubts, but it also showed that 29% were more embarrassed, ashamed to clear their doubts when close to their colleagues.

In the investigated school, it was possible to observe that the classrooms were organized with students' desks in rows and columns, facing forward and a small table in the center of the room, generally used to support the teacher's material. It is an environment in which the student remains quiet, focused on the teacher's speech, which uses the blackboard and chalk as pedagogical support for the exposure of the contents. It was noticed the scarcity of spaces for debates, in which the student elaborates arguments and develops activities with the sharing of information. The PBL breaks this classroom organization, allowing students to work towards each other, stimulating group debate and the teacher being able to move freely throughout the classroom. This new organization allowed the teacher to get closer to the students, identifying their needs. It is a paradigm break that requires time for students to understand that it is a space for the promotion of knowledge and to feel belonging to it.

The inexistence or insufficiency of collaborative and oral works in the past, may have contributed to such a rejection of group work with the new PBL proposal.

Incredible 72% of the students admitted that the feedback of the work was essential for the understanding of the mistakes that were being made by them. Only 16% of students assumed that they did not even bother to observe the feedback.

It is interesting to point out that 43% of students claimed to have felt more motivated to study, a percentage much higher than the 18% who felt unmotivated. The study also revealed that 43% of students perceived greater proximity to the teacher. One of the PBL's differentials is precisely the intensity of evaluations and feedback from the evaluations performed, allowing students to deepen their studies where they present greater conceptual weakness.

When asked about the study for the tests, 43% of students said they did not study, 38% said they studied and were easier, and 19% considered the tests more difficult.

Regarding the final results, 40% of the students said they had learned more with the use of PBL, and 39% felt no difference. Final grades improved in the perception of 44% of students. The impact on grades does not



occur in a direct relationship, immediately, because learning takes time. In addition, it is common for the student to tie the result of the sum of the sum test to his performance, disregarding the works and evaluations that were carried out throughout the process. In total, 28% of students felt that their grades had worsened.

Promoted students are those with an arithmetic grade average of six or more, across all subjects. For students who had one or two averages grade below six, they were promoted by the board and students with a grade below six in three or more subjects were considered retained. 67.24% of the students were promoted and 32.76% were retained.

The results of these students with retention were analyzed and it was observed that, in class one, 100% of the students were better in the History subject, with PBL, when the grade is compared with the average grade of the Portuguese Language, Mathematics, Geography and Science. In class two, only one of 13 students had a lower average, but it is noteworthy that the highest grade average was three (of ten) in Science. In third grade, one student of nine failed students also scored lower in History than the others. It was the worst grade (3.5 of 10), but the highest was in Portuguese Language (5.0), not enough to be promoted. In class four, one of seven students also had a lower average of history than the other disciplines, but for this student in particular, retention was also given by Science and Geography. The student achieved an average of six in the subjects of Portuguese Language and Mathematics. Thus, as a general result, 35 out of a total of 38 retained students had History average above the average of other subjects, equivalent to 92.11%. It can be inferred, therefore, that for the vast majority of retained students, the History discipline, using the PBL method, was not primarily responsible for the unsatisfactory results.

The students promoted by the council were also verified and of the 20 students, 18 (90%) presented in the History discipline a final average of six or more. Only one student in class Three and one student in class Four scored 5.5, very close to the minimum grade (6.0) to be promoted.

When analyzing the final grades of the 28 students who scored less than six in History, only four students (14.29%) had grade average six in any other disciplines (Portuguese, Math, Geography and Science).

The control record of the final result of school performance showed that History scores were generally good and, for retained students, did not differ from other disciplines. Of the 38 students retained, 12 (31.58%) had low attendance, represented by more than 25% of absences in the school year.

Since PBL is a procedural method, low frequency can also hinder student development. Of the 116 students, 41 (35.34%) had more than 10% of unexcused absences, which can be considered a high rate of low frequency.



Students were asked if they would like the PBL method to be adopted in other subjects and the answers were very balanced: 44% said they would and 44% did not. The remaining 12% were indifferent.

CONCLUSION

The application of PBL allows for several changes in the way content is taught and learned. Although the method was originally created in an interdisciplinary and self-directed learning structure, it can be used with modifications without losing its essence: group activities organized based on a problematic situation that generates the development of reflective thinking, research and knowledge exchange and experiences between people.

The PBL contributed to a better approach to the content, allowing students' misunderstandings to be addressed during the process. The teacher was able to identify the students' difficulties in reading and understanding the text, which the evaluations did not show, creating strategies to meet their needs.

The teacher thought that was an amazing experience, but a year was not enough to make the most of the possibilities PBL provides, although it was enough to realize the limitations within the classroom and adapt the tools for the better directing students in order to appropriate the contents.

The insertion of the PBL method changed the way students learn, requiring reading, text comprehension and oral activities that were not common to their school routines, as well as demanding maturity for the development of collaborative works, suggesting conflict resolution.

The data demonstrated the participation, involvement and perception of better performance of students, although resistance to the formation of work groups was evident. Perhaps it is important, because it is a teenage audience, the teacher creates strategies for group formation to occur collectively. This can increase everyone's commitment to teamwork. Likewise, highlighting the advantages of teamwork can help students reflect and become aware of attitude advances.

It was also possible to confirm the recognition by most students that they learned more and performed better. Consider that this is the result of closer proximity to the teacher, allowing students to feel more comfortable exporting their doubts, as well as to the teacher, to correct misunderstandings in understanding concepts more effectively, promoting processes deeper reflective ones.

Changing the teaching and learning method is hard and generates anxiety, fear and insecurity, but it also opens opportunities to overcome the challenges posed by the ever-changing society.



The method alone is not sufficient to ensure better teaching and learning, but it does allow the teacher to get closer to his students, enhancing the discoveries of difficulties that arise throughout the process and allowing them to be met.

The teacher does not lose his role, but all other participants who democratically present their contributions to the building of knowledge of each student are added to it.

The teacher's role is emphasized in formulating student questions to lead them to deeper reflection on the content involved, enhancing learning. The data showed that students' feelings about grades were good, inferring that there was more relevant learning and that they were able to learn.

Some obstacles were encountered in the development of work, many due to extra-class difficulties, such as the constant lack of teachers, which in the absence of tasks the students are idle, agitated, increase conflicts and anxiety to go home, reducing the level of concentration in class. The constant lack of students also hinders the development of the method, as it is procedural. The fact that parents disregard the relevance of school in their children's educational process and do not privilege their studies gives them the false sense of losing the main role of intellectual development in their lives. The lack of administrative, pedagogical orientation, the lack of computer labs to carry out research and work, as well as a library without appropriate space and limited books, made the practice of PBL difficult. Domestic violence against women, police, drug trafficking, hunger, exploitation, abuse and intolerance are common to student's daily lives, further impairing their cognitive abilities.

REFERENCES

Azer, S. (2008). *Navigating Problem Based Learning*. Australia: Elsevier.

Bandeira, H. M. M. (2016). *Pesquisa Colaborativa: unidade pesquisa-formação*. In. *Pesquisa Colaborativa: multireferenciais e práticas convergentes*. Teresina: EDUFPI.

Barbosa, M., & Fernandes, C. (2001). *A escola brasileira faz diferença? Uma investigação dos efeitos da escola na proficiência em Matemática dos alunos da 4ª série*. In: FRANCO, C. (Org.). *Promoção, ciclos e avaliação educacional*. Curitiba: ArtMed.

Barrel, J. (1998). *PBL: an inquiry approach*. SkyLight.

D'Avila, C. M. (2003, july-december). *Pedagogia Cooperativa e Educação a Distância: Uma aliança possível*. *Educação & Contemporaneidade*, 12(20), 273 – 297.

Duch, B. J., Groh, S. E., & Allen, D. E. (2001). *The power of problem-based learning*. Stylus.



Godoy, A. S. (2000). Revendo a aula expositiva. In: MOREIRA, D. A. (Org.). Didática do ensino superior: técnicas e tendências. São Paulo: Pioneira.

Handgraft, R., & Prpic, J. (1999). The key dimensions of Problem-Based Learning. In 11th annual conference and convention. (pp. 127 – 132). Adelaide.

Hattie J. (2009). Visible Learning: a synthesis of over 800 meta-analyses relating to achievement. London: Routledge.

Ibiapina, I. M. L. M. (2016). Reflexões sobre a produção do campo teórico-metodológico das pesquisas colaborativas: gênese e expansão. In. Pesquisa Colaborativa: multirreferenciais e práticas convergentes. Teresina: EDUFPI.

Luckesi, C. C. (2011). Avaliação de aprendizagem - componente do ato pedagógico. São Paulo: Cortez.

Munhoz, A. (2015). ABP – Aprendizagem Baseada em Problemas em ambientes virtuais de aprendizagem: Ferramenta de apoio ao docente no processo de ensino e aprendizagem. São Paulo: Cengage.

Ribeiro, L. R. C. (2008). Aprendizado Baseado em Problemas. São Carlos: UFSCAR – Fundação de Apoio Institucional.

Savin-Baden, M., & Major, C. H. (2004). Foundations of Problem-Based Learning. Maidenhead: Open University Press.

Snyders, G. (1988). A Alegria na escola. São Paulo: Manole.

AUTHOR INFORMATION

Eli BorochoVICIUS, boro@boro.com.br, Brazil, PUC-Campinas (corresponding author)

Elvira Cristina Martins Tassoni, cristinatassoni@puc-campinas.edu.br, Brazil, PUC-Campinas



ENHANCING THE LEARNING OF CLINICAL REASONING FOR BEGINNING STUDENT PHYSIOTHERAPISTS USING SIMULATION-BASED PBL

Chin Pei Tan, Anthony Goff & Edwina Rigby

ABSTRACT

This study explored how students can be better prepared for clinical education placement in terms of clinical reasoning by examining the explicit teaching of tutors facilitating lessons using senior students as standardized patients (SSSPs). The tutors are physiotherapists in practice with substantial prior work experience including clinical teaching and hold advanced degrees in the profession. Six sessions of two-hour tutorial lesson conducted by four tutors and four SSSPs were audio recorded and transcribed. A preliminary analysis of four transcripts identified seven categories. These describe key aspects of performing the clinical process that students need to grasp when they are in the role of the student therapists interacting and collaborating with the patients through history taking, physical examination and treatment phases. They would demonstrate the ability to gather relevant information in a relatively systematic manner, perform appropriate tests in a reasonable sequence, think on their feet to make appropriate decisions in the clinical reasoning process and prescribe treatment that target their diagnosis and profile of their client for exercise compliance. Student therapists would have come up with their own way of note taking, be more sensitive to time constraints and have an inkling how clinical reasoning quality can be improved. The findings contribute to understanding how having SSSPs can facilitate learning clinical reasoning, and hence how approaches without such involvement can be enhanced to incorporate these aspects to bridge the gap in preparing students for their clinical educational placement.

KEYWORDS: Seniors as standardised patients, clinical reasoning, beginning student therapists

TYPE OF CONTRIBUTION: Full scientific paper

PRESENTATION FORMAT: Interactive paper presentation

The authors have chosen not to have their full paper published in the conference proceedings. We encourage you to look for existing or future publications by this author in other outlets.

AUTHOR INFORMATION

Chin Pei Tan, chinpei.tan@singaporetech.edu.sg, Singapore, Singapore Institute of Technology (corresponding author)



Anthony James Goff, anthony.goff@singaporetech.edu.sg, Singapore, Singapore Institute of Technology

Edwina Jane Rigby, edwina.rigby@singaporetech.edu.sg, Singapore, Singapore Institute of Technology



WHAT IS MY ROLE? ABOUT THE SERVICE LEARNING LECTURER ROLE FROM THE PROBLEM-BASED LEARNING PERSPECTIVE

Meike Bredendiek & Emilia Dr. Kmiotek-Meier

ABSTRACT

The program Service Learning (SL) has been established at the University of Cologne UoC in 2010. This concept offers HEI students the chance to socially engage via temporary collaboration with a regional non-profit-organisation and links civic engagement (Service) and the acquisition of academic knowledge (Learning). SL's theoretical underpinning is rooted in Experiential Learning (Dewey 1916, 1938; Kolb 1984) and, hence, intertwines with definitions of Problem-Based Learning (PBL) as both methods aim at empowering students to integrate theory and practice in developing real-world problem's solutions. However, in case of SL at the UoC students gain the theory they need in accompanying classes held by experienced lecturers. The implementation is faculty-independent and therefore open to students of all disciplines – different from many other SL programs in German HEI. This mix of unidisciplinary SL projects but multidisciplinary participants has consequences for students and lecturers. Even though both, PBL and SL, are student-centred concepts, the lecturer plays an essential role in SL's concept. This paper focuses on the lecturer's role in SL from a PBL perspective: What is the role of a lecturer within the Service Learning program at the University of Cologne given both its parallels and differences to Problem-Based Learning? A particular focus will be paid to the digital dimension of SL. The research question has been approached using problem-centered interviews with SL-lecturers. A pilot interview has shed light at the unique constellation of actors involved, the influence of interdisciplinary teams and the lecturer's self-reflection regarding her/his conflicting roles within SL.

KEYWORDS: Service Learning, Lecturer's Role, Multidisciplinary Students, PBL Perspective, Problem-Centered Interviews

TYPE OF CONTRIBUTION: Extended scientific abstract

PRESENTATION FORMAT: Roundtable discussion

INTRODUCTION

Whilst being conceptually founded in the USA in the 1960s (Reinders, 2016, p. 22), Service Learning (SL) has spread to many countries and institutions, schools as well as HEI, ever since. SL offers students the chance to socially engage via temporary collaboration with a regional non-profit-organisation. Even though there is no



coherent concept for SL, they all link civic engagement (Service) and the acquisition of academic knowledge (Learning). *Alliance for SL in Education Reform* defines SL as a method of teaching by which young people learn and develop through active participation in thoughtfully organized service experiences that meet actual community needs ...; that is integrated into the young person's academic curriculum or provides structured time ... to think, talk, or write about what he/she did and saw during the actual service activity; that provides young people with opportunities to use newly acquired academic skills ... in real-life situations [and therefore extends] student learning beyond the classroom and into the community (AfSiER, 1993, p. 71).

SL's theoretical underpinning is rooted in John Dewey's and David A. Kolb's approaches of Experiential Learning: Dewey (1916, 1938) claims personally made experiences to represent the most important basis for learning processes; educational institutions can only enable students to participate democratically through active participation in social processes: "If education is good for anything, Dewey is saying, it must be for making our lives better – individually and collectively" (Waks, 2017, p. 15). Kolb followed this approach and promoted the notion of the interplay between theory and practice linked by means of systematic reflection. He suggests "the idea that learning is by its very nature a tension- and conflict-filled process" (Kolb, 1984, p. 30), that learners must "involve themselves ... in new experiences ..., reflect on and observe [those] from many perspectives [and eventually use] theories to make decisions and solve problems" (ibid).

Following the definition of Problem-Based Learning (PBL) being "a very engaging, motivating and involving form of experiential learning" (Savery, 2006, p. 14), overlapping between SL and PBL becomes visible. SL as well as PBL is an "approach that empowers learners to ... integrate theory and practice, and apply knowledge and skills to develop a viable solution to a defined problem" (ibid, p. 12). Thus, our paper draws on PBL characteristics as formulated in Savery (2006) to analyse SL. Before introducing our research question and preliminary findings, we turn to a description of SL at the University of Cologne (UoC), as this is crucial to our analysis.

SERVICE LEARNING AT THE UNIVERSITY OF COLOGNE

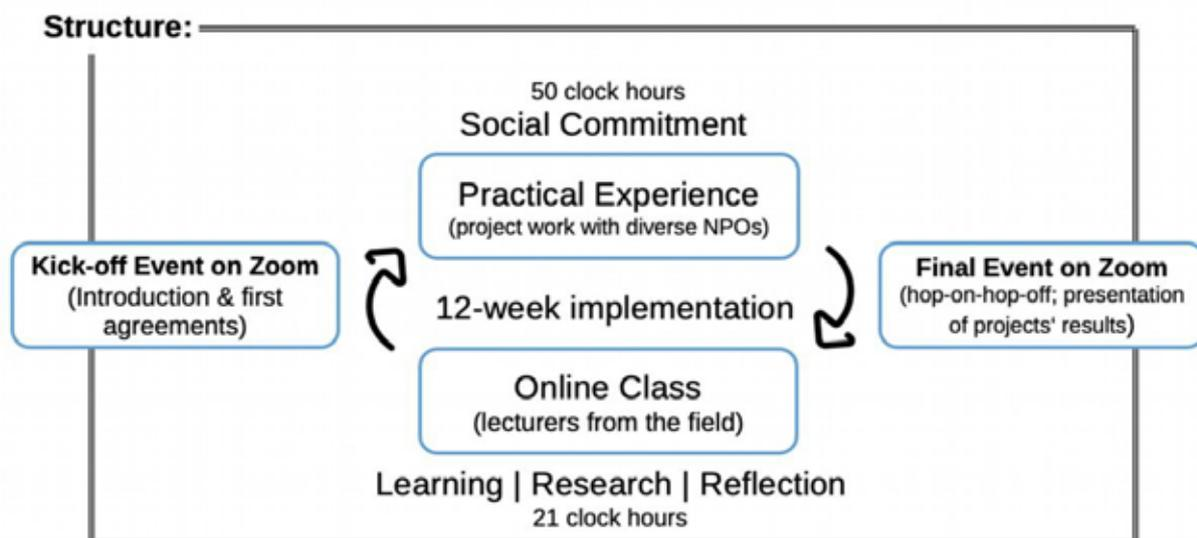
As there is no "right" definition of SL, all SL projects are marked by some unique features, which is also true in case of SL at the UoC. SL has been established at the UoC in 2010; from the beginning, it has been centrally organized and is therefore faculty-independent. Every term between 8 – 16 new interdisciplinary projects are offered to the students, such as "Local fundraising campaign: Cologne helps!" in cooperation with Sea-Eye e.V.. The participants' number varies between 30 and 85 every term, with max. seven students per project. The project work is accompanied by a relating class (e.g. related to the example given above: "Global, Local, Fair: Mobilizing humans") held by a lecturer with relevant professional experience; In a total of 21 hours, the class shall ensure that students gain knowledge and skills to carry out their projects.



To successfully complete the participation a SL student must attend class *and* project work (no final assessment required), while interconnecting theoretical and practical elements *and* reflecting newly made experiences. SL involves four different stakeholders: students, lecturers, NPO’s representatives and the SL coordination. It is important to consider their individual impact, expectations and responsibilities as their interplay is crucial.

Last spring, the COVID-19 pandemic forced SL’s coordination at UoC to shift the program into the digital world. As it was more important than ever to stay socially engaged, the program’s cancellation was not an alternative. Figure 1 depicts the SL digital edition’s structure: *Service Learning Digital – Social Commitment despite Social Distance*.

Figure 1: Structure of SL at UoC in digital edition



Due to its institutional embeddedness (faculty-independence), SL is offered to the student body within the so called “Studium Integrale” – an area of free-choice courses to complement the disciplinary education. SL courses, SL included¹, can be attended by students of all disciplines and assume little or no previous knowledge in the course subject. Thus, the student composition of SL courses is multidisciplinary – different from many other SL programs in German HEI.

RESEARCH QUESTION

This mix of unidisciplinary SL projects but multidisciplinary participants has consequences for the students and the lecturer. While some students are already familiar with the theories and methods needed to pursue

¹ The participation in a SL course is rewarded with 3 Credit Points.



the project, the project topic will be new territory for others. The lecturer has to provide classes in a way appealing to both, expert- and lay students, and, moreover, is in charge to pay attention to uneven project participation within the group. Therefore, the classes – and consequently the lecturers – play an essential part in the concept of SL (at the UoC). Furthermore, the lecturer is confronted with expectations from and obligations towards the SL coordination, less so in regard to NPO organization. Considering the SL constellation, the lecturer is situated in a multipolar field of expectations, including his/her self-understanding of the lecturer role gained through previous teaching experience.

So far, the role of the “teaching person” has been given only little attention in SL-related research. This paper therefore wants to focus on the lecturer’s role in SL, taken from a PBL perspective: *What is the role of a lecturer within the Service Learning program at the University of Cologne given both its parallels and differences to Problem-Based Learning?* A particular focus will be paid to the digital dimension.

METHODS

The analysis is based on problem-centered interviews (Witzel & Reiter, 2012) with the SL-lecturers (winter term 2020/2021) at the UoC. We use semi-structured interviews oscillating around aspects characterizing PBL named by Savery (2006), such as the student’s responsibility in the learning and project process, the project’s structure and nature, the collaboration among actors involved, the role of multidisciplinary, the closing analysis or the student’s self-assessment. The PBL characteristics were translated into matching aspects of a SL lecturer’s responsibility – hence, the questionnaire was expanded by questions focusing directly on the lecturer’s role – giving narration freedom to the interviewees and ensuring that all interviews cover aspects in focus. We will analyze our data using structured content analysis, while remaining open for topics emerging from the empirical material. The field work was finished in February 2021; all interviews took place via zoom calls, were recorded and transcribed.

PRELIMINARY FINDINGS & DISCUSSION

A pilot interview with one of the winter term’s lecturer has provided first answers to the research question. They have to be treated with caution as more empirical material is needed to achieve empirical saturation.

The interview sheds light at the unique constellation of actors involved in SL at the UoC: (1) students (learners), (2) lecturer(s), (3) the NPO’s representative as well as (4) the SL coordination. Those four actors are interconnected, but not every connection has the same strength. The understanding of the role as lecturer is relational, as it is always defined through a connection with the other actors. The lecturer serves as (1) expert sharing knowledge needed for the problem. The definition of the needed knowledge is made independently, giving him/her strong position within SL. At the same time, it is the lecturers’ responsibility to balance differing prior knowledge among the students. Simultaneously, the lecturer is “only” (2) a coach



regarding project advancement and (self-)reflexion units, as the students and the organisation have the last saying in the project and are therefore in charge of the actual project's process. Those two roles can lead to conflict of one's own position within SL, also resulting from the expectations of the other actors involved. Thus, the lecturer has to externally and internally negotiate the own role. In a further step it has to be reflected if this understanding is a shared one among SL lecturers at the UoC. Possible influences of a given disciplinary habitus (have to be taken into account).

Regarding the digital implementation of SL, the very first findings show that the mode of SL has only little influence on the perception of own role as lecturer. However, it has been stated that the face-to-face version would be more beneficial for all actors especially for the student-organisation relationship.

REFERENCES

- Alliance for Service Learning in Education Reform (1993). Standards of Quality for School-Based Service Learning" *Service Learning, General. Paper 4*.
http://digitalcommons.unomaha.edu/slceslgen/4?utm_source=digitalcommons.unomaha.edu%2Fslceslgen%2F4&utm_medium=PDF&utm_campaign=PDFCoverPages
- Barrows, H.S. & Tamblyn, R.M. (1980). *Problem-Based Learning. An Approach to Medical Education*. Springer Publishing Company.
- Dewey, J. (1916). *Democracy and Education. An Introduction to the Philosophy of Education*. Macmillan.
- Dewey, J. (1938). *Experience and Education*. Macmillan.
- Kolb, D. A. (1984). *Experiential Learning. Experience as the source of learning and development*. Prentice Hall.
- Reinders, H. (2016). *Service Learning – Theoretische Überlegungen und empirische Studien zu Lernen durch Engagement*. Beltz Juventa.
- Savery, J. R. (2006). Overview of Problem-based Learning: Definitions and Distinctions. *Interdisciplinary Journal of Problem-Based Learning*, 1 (1), 9 -20. <https://doi.org/10.7771/1541-5015.1002>
- Waks, L.J. (2017). Learning by Doing and Communication. *John Dewey's Democracy and Education. A Centennial Handbook* (pp. 15 – 22). Cambridge University Press. <https://doi.org/10.1017/9781316492765>
- Witzel, A., & Reiter, H. (2012). *The problem-centred interview: Principles and practice*. Sage.

AUTHOR INFORMATION

Meike Bredendiek, Meike.bredendiek@uni-koeln.de, Germany, University of Cologne (corresponding author)



Emilia Dr. Kmiotek-Meier, emilia.kmiotek-meier@uni-koeln.de, Germany, University of Cologne
(corresponding author)



TEACHING PHYSICAL COMPUTING WITH ACTIVITY CARDS AND ONLINE SIMULATORS

João Freitas, Marisa Cavalcante, Marcia Sacay & Elio Molisani

ABSTRACT

The lack of appropriate training, resources and materials discourage primary education teachers from adopting problem-based learning and active learning methodologies in their lesson planning. Even though a problem-based approach would work seamlessly to learn physical computing, it is common to see teachers placing increased focus on the theory, and harming the hands-on experience, which becomes typically poorly designed. Activity cards have been used successfully as a resource to engage students in their learning by proposing challenges with brief orientations. This article shares the results reached by the authors of this practice by using their own designed activity cards centered on physical computing, with an open-ended problem-based approach holding different complexity tracks and relatively simple challenges.

KEYWORDS: Activity cards, physical computing, online simulators, Problem-based Learning

TYPE OF CONTRIBUTION: Practice-based abstract

PRESENTATION FORMAT: Roundtable discussion

INTRODUCTION

Problem-based Learning (PBL) and active learning methodologies have been used in higher education in different fields for quite some time. However, it is not largely used in primary education, which tends to be traditional while sustaining the lecture teaching style in many places. The lack of appropriate training, resources and materials are some of the reasons for teacher's demotivation from adopting their lesson plans.

The authors of this practice have been using active learning methodologies in professional development courses in the past few years, providing additional tools for teachers to use with their students. We designed these courses with a hands-on approach, aiming to narrow the gap between theory and practice by bringing problems related to real-life situations and mixing them with the curriculum. The Covid-19 pandemic has increased the opportunities to adapt our practices to a new reality, where the hybrid learning environment and digital tools is placed in the forefront.

Physical computing covers the creation of interfaces, by software or hardware, that can be sensitized or responded to interactions between humans and the physical environment. Physical computing projects



usually have a hands-on approach, with several cycles, ranging from structural constructions to accommodate the components that are part of the system, to the establishment of the rules for its operation.

The components and tools necessary to work with physical computing are usually available in a lab or Makerspace, but in an online modality, we cannot expect students to have access to a similar environment. In this scenario, the use of simulators and online tools has been necessary to overcome the lack of resources. Tinkercad (Tinkercad, 2021) is mostly known for its 3D modeling software, but it also has a circuit simulator with essential tools and components to start in electronics and microcontrollers, in addition to a gallery with tons of projects published by the community, covering from LED and batteries to smart cities prototypes.

Even though a problem-based approach would work seamlessly to learn physical computing, it is common to see teachers placing increased focus on the theory, harming the hands-on experience, which becomes typically poorly designed. The learners have to follow instructions step by step to build a project documented by someone else, which in general is not meaningful for them neither related to their interests.

Activity cards have been used successfully as a resource to engage students in their learning as it places challenging tasks with brief orientations. Each author designed their cards in different formats using a set of features.

The Lifelong Kindergarten Group of the MIT Media Lab designed the Scratch Cards (Scratch Cards, 2021), which can be used to help children to learn Scratch, as a reference for the Scratch visual programming blocks or as inspiration for new projects. The Scratch Card collection can be used in any order and covers the most relevant programming blocks necessary to create interactive stories, animations and games.

The CoderDojo Foundation, part of the Raspberry Pi Foundation, has also developed their own version of activity cards (CoderDojo Sushi Card, 2021) as a guidance for kids of their clubs. The Sushi Cards (Sushi Card Concept, 2021) have one concept per card, communicated in an easy to digest double-side laminated A4 sheet, and works greatly in an environment of different knowledge, maturity, interests and concentration spans.

METHODS

The authors of this practice designed their own activity cards focused on physical computing, with an open-ended problem-based approach, with different complexity tracks and relatively simple challenges. The learners choose cards according to their interests and knowledge, and develop their own solution. The time of each student is respected in this process.



Our activity cards (Figure 1) always start with a Tinkercad shared project as a reference. Sometimes we provide a complete circuit with some missing programming parts. On other occasions, we suggest a list of components without any connection. In both cases, the students have to complete the program and check the circuit connections. It is important to notice that we will have different solution paths for the same initial challenge, and each student will add their own features according to their personal interests.

Figure 1: Two different activity cards (in Portuguese) showing the main idea and its structure.



RESULTS AND DISCUSSION

The results show that as soon as learners complete the initial challenge, they feel comfortable to solve the additional extra ones. Learners interaction with the cards is neither linear nor unique. The exploration is free but the pedagogical goals are well outlined.

The engagement of participants is difficult to be measured, but we found evidence that it was higher in the problem-based approach than in other traditional ones. At the end of each class, we passed an anonymous evaluation form and the most common complaint was the time being too short to complete the activity during class time, which indicates their interest in the topic and their level of motivation with this approach.



Another indicative of engagement is, although these cards are used as a support for their learning process and are not part of their grade, that participants usually remain in contact with us between classes to ask for help, to discuss some issues they encountered, and sometimes just to show off their solution.

As a final project, we ask participants to prototype a solution using physical computing for a problem related to their neighborhood, education, social inequality, special needs or the 17 SDGs. The results show they are able to mix different activity cards and extrapolate them to propose solutions for problems that were not discussed during classes.

CONCLUSION

Even with all the uncertainty on how education will resemble in the next few years, based on the results we have found so far, teacher's professional development courses taught by the authors from this practice, will be mostly held in a hybrid or online formats, using problem based and active learning methodologies, and digital tools with resources adapted to this new reality.

ACKNOWLEDGEMENT

The authors gratefully acknowledge Gedutec Tecnologia Educacional for their support for this work.

REFERENCES

Authors' Activity Cards (2021, January 30). Arduino Cards. Retrieved from <https://drive.google.com/drive/u/0/folders/1AyWzXT3LnipX0Z7RyowQIp9-6Fa3yd6J>

CoderDojo Sushi Card (2021, January 30). Make a zoo website. Retrieved from https://github.com/CoderDojo/kata-archive/blob/master/files/Mini_Sushi_HTML_v2.pdf

Scratch Cards (2021, January 30). The Entire Collection of Coding Cards. Retrieved from <https://resources.scratch.mit.edu/www/cards/en/scratch-cards-all.pdf>

Sushi Card Concept (2021, January 30). Making Sushi Cards! Retrieved from https://github.com/CoderDojo/kata-archive/blob/master/pages/Making_Sushi_Cards.md

Tinkercad (2021, January 30). Learn how to use Tinkercad. Retrieved from <https://www.tinkercad.com/learn/circuits>

AUTHOR INFORMATION

João Freitas, jaafreitas@gmail.com, Brazil, Estúdio Hacker, <https://www.linkedin.com/in/jaafreitas> (corresponding author)



Marisa Cavalcante, marisacavalcante1@gmail.com, Brazil, Universidade Federal do Amazonas, <https://labduino.blogspot.com/> (corresponding author)

Marcia Sacay, sacaymarcia@gmail.com, Brazil, Pioneiro Education Center, <https://marciasacay.wixsite.com/imaginacaoemovimento> (corresponding author)

Elio Molisani, eliomolisani@ufam.edu.br, Brazil, Universidade Federal do Amazonas, <https://www.linkedin.com/in/elio-molisani-036ba5158/> (corresponding author)



I'M (NOT) AN ACADEMIC - GET ME OUT OF HERE: PROMOTING ACADEMIC READING THROUGH ACTIVE LEARNING

Paul Stevens & Roy Hanney

ABSTRACT

Yes, you are an academic — you just don't know it yet. That's the premise for a workshop activity promoting high-quality academic reading through active learning with the aim of addressing student resistance to reading and developing familiarity with the style, structure and form of academic texts. The problem is that students aren't reading. Research tells us that 27 per cent of expectations is a high estimate (St Clair-Thompson et al, 2018, 285) and they're afraid to engage with some of the reading we recommend. That's a problem because: we want our students to become good at writing; critical thinking emerges through academic writing; and before writing comes reading. So, this workshop aims to offer an active learning approach to getting students reading high-quality academic sources, understanding their structure, and helping them with comprehension, interpretation, paraphrasing, and synthesis.

KEYWORDS: Active, Academic, Reading, Learning, Writing, Modelling

TYPE OF CONTRIBUTION: Practice-based abstract

PRESENTATION FORMAT: Experience demonstration

INTRODUCTION

Yes, you are an academic — you just don't know it yet. That's the premise for a workshop activity promoting high-quality academic reading through active learning with the aim of addressing student resistance to reading and developing familiarity with the style, structure and form of academic texts.

WORKSHOP OUTLINE

The problem is that students aren't reading. Research tells us that 27 per cent of expectations is a high estimate (St Clair-Thompson et al, 2018, 285)—and they're afraid to engage with some of the reading we recommend. That's a problem because: we want our students to become good at writing; critical thinking emerges through academic writing; and before writing comes reading. So, this workshop aims to offer an active learning approach to getting students reading high-quality academic sources, understanding their structure, and helping them with comprehension, interpretation, paraphrasing, and synthesis. The session doesn't require anything other than highlighters, a white board and copies of a relevant published article. The workshop employs an active learning approach to demonstrate a method for the collective reading,



interpretation and synthesis of a complex academic work. The approach is highly flexible and can be adapted to a range of other contexts including books, book chapters, etc. In this instance the workshop focuses on getting students to engage with, and make use of, a peer-reviewed journal article. The workshop models reading as a practice – this is how students will learn to write academically, critically, in depth, and from an informed viewpoint. It significantly contributes to conquering the fears students have of engaging with what they think of as material too complex for them to comprehend. But, through this group-based, active learning; approach students discover that they *can* understand, and apply, that which they thought they couldn't.

WORKSHOP REQUIREMENTS

The workshop requires a flexible classroom which can facilitate group working and requires as a minimum a white board, A0 flip charts, marker pens and blue tac. If a computer screen with access to the internet is available there is a version of the workshop which uses interactive online technology to undertake the final stages of the activity. The workshop needs at a very minimum an hour to demonstrate the process but would benefit from being longer as when it is run as a staff development session it's usually for two hours. This enables the facilitators to briefly frame the workshop activity theoretically and offers an opportunity for discussion at the workshop's conclusion.

RATIONALE

The workshop emerged as a response to perceptions by staff on a media practice programme at an English university, that the students had an inbuilt resistance to reading academic texts. Teaching on the media practice programme takes the form of the kind of Problem-based Learning (PBL) that Savin-Baden (2007) refers to as Project-led Problem-based Learning (PjPBL). According to Savin-Baden, the focus for this particular manifestation of PBL is on the acquisition of skills for practice where project management is used as a framework for structuring a series of problem encounters that may vary in domain, degree and variety throughout the lifecycle of the project. At the heart of this method is a defining problem encounter that is intended to stimulate learning “where some subject-specific knowledge and skills may be delineated by the tutor, but in general, learning is derived from utilising opportunities, resources and experience through the ‘doing’ of the project and is led by the participating students” (Hanney & Savin-Baden, 2013, 13). PjPBL is complex, comprises multiple constantly-changing elements, and is less outcome-focused than more traditional PBL, reflecting as it does the ways in which experiential learning is traditionally delivered in media practice education.



Where PjPBL is utilised in media practice education it's also common to employ reflective writing as an assessment tool as, in and of itself, the output of a project doesn't necessarily evidence learning and/or critical thinking (Hanney, 2013). By its very nature the output of a project is a complex intertangling of actions, intentions, problem encounters, risk strategies and group dynamics. That is to say, while a project output may be of a high quality, the reason for this can often be as much down to luck and good timing as it can be down to high-quality critical thinking. The value of reflective writing for assessment is then very clear, as it adds an individual component to the assessment of group projects. A useful academic imperative is at play here since group-working can also serve to mask effort, contribution and participation by individual students working as part of a project team. Consequently, and despite creative media students' resistance to it, critically reflective writing is seen as an important element of educational practice on many media practice programmes.

If, following Dewey (1938), it is the case that reflection and in particular reflective writing is a manifestation of critical thinking, then the promotion of this skillset would seem an appropriate strategy, since the process of writing itself, the revising, re-writing and re-drafting of texts engenders further "discovery, development and modification of ideas" (Bean, 2011, 33). Writing is iterative, recursive and requires the writer to revisit their words, promoting meta-cognition and syntheses. However, in order to write in an academic context, the students first have to read. Reading not only provides students with access to key information, ideas and debates, it also models for students high-quality academic writing. The researching and writing of a critical reflection underpins the integration of theory and practice for learners, while the reading of set texts, as in most courses, aims to ensure their critical reflection is located within an appropriate theoretical framework.

The challenge here is that research suggests students do not value reading as much as other forms of learning activity, such as lectures or seminars, and struggle to see the connection between reading and academic success (St Clair-Thompson et al, 2018, 285). Reading comprehension, motivation and lack of confidence, along with pressures on students' time, all contribute to a low engagement with set reading activities. Students may be reading less than 27% of what is expected of them, and we are told that 72% of students rarely, if ever, complete reading assignments (St Clair-Thompson et al, 2018, 285). The active learning exercises presented in this workshop aim to address this issue directly through direct intervention and the promotion of in-class reading activities.

FUTURE WORK

The workshop facilitators have developed two reproducible models for the delivery of an in-class active learning exercise. The first draws on a single text that is taken from a single academic journal. The second draws on multiple texts from a single academic journal which would typically take the form of a guest edited



or themed edition. Having previously developed the model for use in the classroom and trialed it with students. The workshop facilitators have now also repurposed the exercise as a staff development activity. While for students, the exercise is presented as a normal part of their everyday classroom learning, for staff, the exercise is framed as a learning and teaching activity that includes theoretical contextualisation and opportunity to engage in a discussion at the conclusion of the workshop. In this latter instance the purpose of the workshop is not to develop reading skills per se but to promote an engagement with active learning techniques and effect change within the culture of learning and teaching at the workshop facilitators' home university. Ongoing evaluation through surveys, interviewing and other forms of qualitative data gathering reveals a high level of engagement among students who have participated in the activity. This work will continue, and it is expected that a publication outlining the results of this research will be forthcoming in the near future.

REFERENCES

Bean, J. C., & Weimer, M. (2011). *Engaging ideas the professor's guide to integrating writing, critical thinking, and active learning in the classroom* (2nd ed.). San Francisco: Jossey-Bass.

Dewey, J. (1938). *Experience and education*. New York: MacMillan.

Hanney, R. (2013). Towards a situated media practice: Reflections on the implementation of project-led problem-based learning. *Journal of Media Practice* 14(1), 43-59.

Hanney, R., & Savin-Baden, M. (2013). The problem of projects: understanding the theoretical underpinnings of project-led PBL. *London Review of Education*, 11(1), 7.

Savin-Baden, M. (2007). *A practical guide to problem-based learning online*. London: Routledge.

St Clair-Thompson, H., Graham, A., & Marsham, S. (2018). Exploring the Reading Practices of Undergraduate Students. *Education Inquiry*, 9(3), 284–298.

AUTHOR INFORMATION

Paul Stevens, Paul.Stevens@solent.ac.uk, United Kingdom, Southampton Solent University (corresponding author)

Roy Hanney, Roy.Hanney@solent.ac.uk, United Kingdom, Southampton Solent University



THE DEVELOPMENT OF COLLABORATIVE PROJECTS FOR HYBRID LEARNING DURING CONTINUING TEACHER TRAINING

Elio Molisani, Macia Nobue Sacay, Marisa Cavalcante & João Freitas

ABSTRACT

Discussions about using digital technologies to support a teaching practice based on active learning methodologies are increasing. Especially at this time, due to the effects of the COVID-19 pandemic, classrooms in most schools worldwide needed to quickly adapt to the hybrid learning model. To this end, support for teachers also had to be reinforced. The present work describes an activity planned during a teacher training course to promote learning based on problems and projects by creating artifacts collaboratively while maintaining social distancing. The activity was conducted in two classrooms with 50 K-8 teachers from the municipal school system in São Paulo (Brazil), was operated by the Microsoft Teams platform, and the produced work was recorded on virtual murals in the Padlet application. The produced work and the teacher's responses from the evaluation questionnaire served as a basis for a qualitative analysis of the educational potential in the performed practice. Even with the activity's shortened time and the teacher's difficulty in the digital platform's operation, the activity promoted the integration of workgroups, production of artifacts, and the construction of a thematic proposal for the development of a collective project, serving as a reference and inspiration for viable proposals for classroom application.

KEYWORDS: Online Teacher Training, Hybrid Learning, Educational Technology

TYPE OF CONTRIBUTION: Practice-based abstract

PRESENTATION FORMAT: Experience demonstration

INTRODUCTION

Teacher training for using digital technologies (Moran, 2000) and active methodologies (Moran, 2017; Santos et al., 2019), as strategies to update and improve the education system is not a new issue. In 2020, the world was surprised by the Covid-19 pandemic, which forced the adoption of distance learning in many countries. In Brazil, this format has been adopted completely by the educational network.

At the same time new models of online teaching emerge and technology advances while bringing great educational benefits, for example, learning management systems that facilitate interaction between users and is more integrated with modern applications and software, on the other hand, many challenges still remain, such as problems with internet connection, equipment quickly becoming obsolete or incompatible



with computer programs, difficulty of operation by users, high costs, or evasion among others (Bates, 2019). These challenges are even more significant in large education networks, such as the Municipal Education Secretariat of São Paulo (thereafter SME-SP), who employs around 60 thousand teachers working in Basic Education (Municipal Education Secretariat of São Paulo, 2020).

With such a structure and continually seeking to improve teaching quality, SME-SP offers several continuing education courses for its teachers.

In 2020, this article's authors offered courses called Creation, Inventiveness, and Learning in the Laboratory of Digital Education. Due to the COVID-19 pandemic, the training initiative initially designed to be in-person needed to be adapted to the online format.

The course in question was offered to two classes of 50 elementary school teachers with 20 hours of activities, 8 hours of synchronous training meetings, 4 hours of attendance on-duty shifts, and 8 hours dedicated to studying the execution of asynchronous activities. The course was offered through the Microsoft Teams, a platform officially adopted by SME-SP which allows creating classes, video conferencing meetings, chat resources, file sharing and storage, task control, schedule, and other applications (Microsoft Teams, 2021).

The online practices presented here refers only to one of the activities applied during the second and third training days. To increase interactivity between the teachers and to enable collective registration of productions we used the Padlet software, which works as a digital wall to allocate texts, images, videos, hyperlinks, and other file formats (Padlet, 2021).

The adopted strategy is discussed as an alternative proposal to apply the Project- or Problem-Based Learning (thereafter PPBL) at a distance, synchronous, collaborative, and active participation of course participants.

METHODS

The practice described below was planned to be executed in 105 minutes and had as main objectives:

- Work collaboratively, synchronously and interactively using technological resources;
- Develop interdisciplinary projects based on different themes;
- Prototyping artifacts from a distance with alternative materials;
- Share reflections on the importance of the student's role in school activities.

Description of the activity developed, with the duration of each stage.



10 minutes - Reception and explanation of the activity.

- (1) Theme: Creative Cities.
- (2) Questions to trigger the activity: What is this place where we live? What changes has it undergone? What new and old characteristics are maintained, and what do they tell us?
- (3) Challenging Proposition: Build collaboratively an artifact with movement that would contribute to making our living space a more Creative City in the hands-on rooms.
- (4) Requirements: (a) Carrying out the activity in groups, (b) defining a common theme regarding the creative city to direct the constructions of the artifacts, (c) the need for some kind of movement to the artifacts produced, (d) connection of the created artifacts context and (e) posting the final product in Padlet (Figure 1).
- (5) Participants were randomly divided into smaller groups.
- (6) Explanation of the functionality of the rooms on the Microsoft Teams platform and the Padlet application. Link sharing to join the room's video calls and to the Padlet's wall.
- (7) Moving from the main room to the thematic rooms: Entrepreneurial City, Imaginative City, Innovative City, Inventive City, Revolutionary City, Sustainable City, and Transforming City.
- (8) Record production of groups in the Padlet application.

Figure 1: Mural made in Padlet during activity in the thematic room Sustainable City. It was proposed to build a trash can with a sensor to identify recyclable materials.



**45 minutes - Activity in the thematic rooms.**

- (9) Provision of a link and guidance on activity in Padlet.
- (10) Personalized service to answer questions, check possible technical flaws, and engage and monitor the working groups' work.
- (11) Closing and posting products in Padlet.
- (12) Provision of links on the murals with the activities carried out in Padlet for everyone to observe colleagues' work with more time throughout the week, add comments, and even complement the proposals.
- (13) Information about the presentation format for papers in the next class.

35 minutes - Groups' presentation.

- (14) Presentation time: 4 minutes/group.

At the end of each presentation, the trainers made brief comments about their work as a form of encouragement to teachers and invite them to reflect on the pedagogical objectives that can be achieved with such practice. The other teachers' considerations and questions were carried out with great intensity through the chat, ensuring the participants' good interaction.

The Catalog (in Portuguese) link lists all activities carried out, it also provides access to the murals created in Padlet, where each project proposal can be seen in detail, videos can be watched, and comments can be left.

https://drive.google.com/file/d/1Y_oC_9eler-mFXQem-Lh0yz7U54Rbqe_/view?usp=sharing

RESULTS AND DISCUSSION***Padlet results***

Figure 2 presents the results from 14 activities produced and the 6 thematic identified categories: accessibility, art, leisure, health, sustainability, and transport.



Figure 2: Activity themes produced in Padlet.

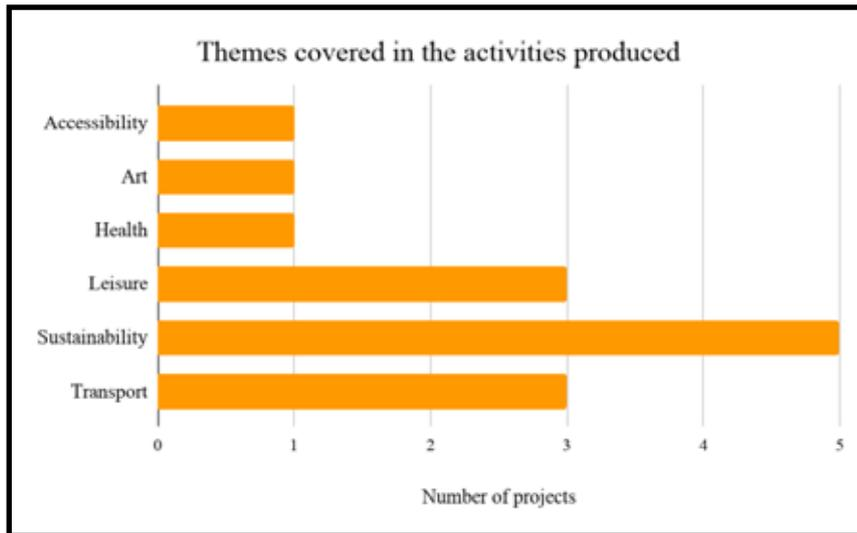
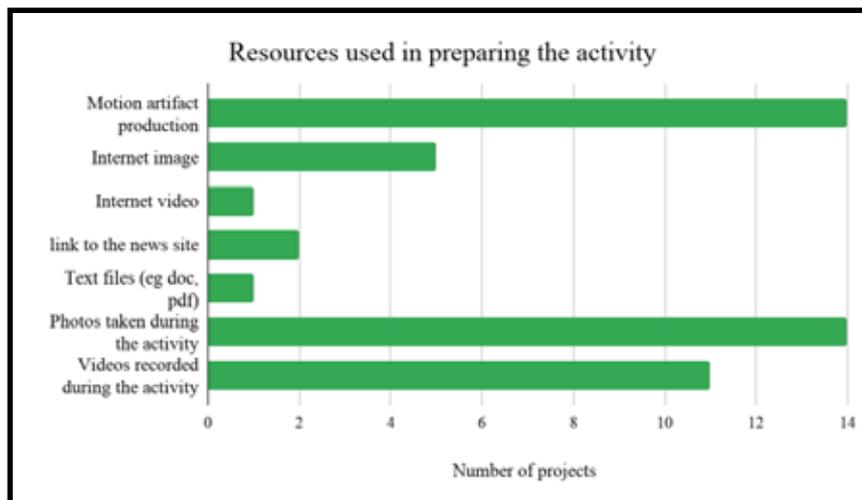


Figure 3 lists resources explored in Padlet by teachers, highlighting the videos, photos, and results from motion artifact production, as indicators of engagement with the activity.

Figure 3: List of resources used in activities produced in Padlet.



EVALUATION QUESTIONNAIRE

At the end of each meeting, teachers were asked to answer a voluntary course evaluation questionnaire. Table 1 presents the data obtained from 66 responses related to the use of digital technological resources.



Table 1 - Evaluation of digital technological resources from 66 responses.

Answers	Total responses (%)
Didn't know Padlet	25 (37.9%)
Didn't know about Microsoft Teams features, like room sharing	19 (28.8%)

About PPBL and elaboration of a guiding or triggering question for projects, 25 participants (31.3%) out of 80 answered the questionnaire, declaring that they learned the subject during the course and that using digital tools favored their remote deployment.

The main information collected is listed below:

- Difficulty handling applications when moving between thematic and main rooms.
Recommendation: Have a support team to assist these teachers
- Technical and structural problems: equipment with low capacity, Internet connection failures, and others. Suggestion: communicate in advance any equipment needs and study the environment to avoid demotivation.
- Willingness to participate in other courses in a similar format with the same trainers, and co-authors of this article.
- Increasing the duration of the course using PPBL involving the active participation.
- improve their knowledge regarding the use of digital technologies, development of the prototypes, and creative potential in the process of learning, involving partnerships.
- Institutional support for offering free courses is relevant to encourage the participation of teachers.

CONCLUSION

The variety of technological resources for educational use is rapidly increasing, requiring teacher's time and effort to keep up-to-date. Just as it is essential to support continuing teacher training on educational institutions, it is also necessary to increase the number of materials that serve as a reference, as innovative teaching practices to mix analog and digital technologies, privileging the student's protagonism through PPBL.



During a time when the world opened up to massive online education, which has been accelerated by the COVID-19 pandemic, we cannot lose sight of the importance of hands-on activities, which must be well explored from the construction of relevant and engaging artifacts for those who make them.

We hope that this work will serve as an example to show that it is possible to innovate teacher's training through online courses, to contribute in discussions and research on the topic, and finally, to inspire other educators to create and implement activities that motivate students also in remote classes.

ACKNOWLEDGEMENT

The authors gratefully acknowledge Gedutec Tecnologia Educacional and the Municipal Education Secretariat of São Paulo for the support of this work.

REFERENCES

Bates, A. W. (2019). *Teaching in a Digital Age – Second Edition*. Vancouver, B.C.: Tony Bates Associates Ltd. Retrieved from <https://pressbooks.bccampus.ca/teachinginadigitalagev2/>

Microsoft Teams (2021, January 30). Online meetings, chat, and cloud storage, all in one place, for free. That's right, free. Retrieved from <https://www.microsoft.com/en-us/microsoft-teams/free>

Moran, J. M. (2000). Ensino e aprendizagem inovadores com tecnologias. *Informática na educação: teoria & prática*, 3(1).

Moran, J. M. (2017). Como transformar nossas escolas. *Educação*, 3, 63-87.

Municipal Education Secretariat of São Paulo (2020, November 30). Metade dos professores da Rede Municipal de São Paulo é pós-graduada, com título de especialista, mestre ou doutor. *SME Portal Institucional*. Retrieved from <https://educacao.sme.prefeitura.sp.gov.br/metade-dos-professores-da-rede-municipal-de-sao-paulo-e-pos-graduada-com-titulo-de-especialista-mestre-ou-doutor/1151/>

Padlet (2021, January 30). Everything you need, nothing you don't. Retrieved from <https://Padlet.com/features>

Santos, E. M. F. et al. (2019, December 01-03). *Aprendizagem ativa como principal estratégia para atendimento das novas diretrizes curriculares nacionais em engenharia* [Paper presentation]. XLVIII Congresso Brasileiro de Ensino de Engenharia, Brasil. DOI: [10.37702/COBENGE.2020.3260](https://doi.org/10.37702/COBENGE.2020.3260)

AUTHOR INFORMATION

Elio Molisani, eliomolisani@ufam.edu.br, Brazil, Universidade Federal do Amazonas (corresponding author)

Macia Nobue Sacay, sacaymarcia@gmail.com, Brazil, Centro Educacional Pioneiro (corresponding author)



Marisa Cavalcante, marisacavalcante1@gmail.com, Brazil, Universidade Federal do Amazonas (corresponding author)

João Freitas, jaafreitas@gmail.com, Brazil, Estúdio Hacker (corresponding author)



STEMSS STRATEGIES PROFESSIONAL DEVELOPMENT TO SUPPORT ACADEMIC LANGUAGE DEVELOPMENT USING PBL

Karen Guerrero & Margarita Jimenez-Silva

ABSTRACT

The STEMSS (STEM + Social Studies) project developed and conducted professional development (PD) for teachers of language learners (TLLs) that centered around teaching content and language in tandem using PBL. The PD intervention was informed by Shulman's (2013) Knowledge Growth in Teaching framework; looking at the three types of knowledge: content, pedagogical, and curricular knowledge. The PD intervention was also informed by Lucas and Villegas' (2013) Linguistically Responsive Teacher Education model. This research emphasized the need to move from conversational English skill development to academic language skill development through hands-on, real-world, engaging lessons that teach content while supporting language acquisition. This work appraises the need to specifically teach strategies to develop academic vocabulary, model strategies that are effective in supporting language acquisition during the content PBL experiences, and to have teachers transfer this knowledge by developing lessons using these strategies to bring them back to their classroom. To ensure teachers gained knowledge in meeting the needs of English Learners (ELs), understanding of how to do this effectively through classroom instruction, and confidence in doing so as teachers change their pedagogical methods, this mixed-methods study details the implications of the PD on the TLLs' teaching practices.

In addition to providing research findings, this session will:

- Expose participants to innovative STEMSS PBL activities that engages teachers, ELs, and their families in language-rich experiences,
- Engage participants in a hands-on PBL activity that integrates STEMSS content and academic language, and
- Excite educators through a collaboration to share resources and PBL best-practices

KEYWORDS: STEMSS, STEM, Professional Development, Teacher Training, Cross-Curricular, Strategies, ELs, PBL

TYPE OF CONTRIBUTION: Practice-based abstract

PRESENTATION FORMAT: Experience demonstration



INTRODUCTION

The science, technology, engineering, math, and social studies (STEMSS) integrated curriculum project designed a hybrid professional development (PD) that infused PBL and academic vocabulary strategies to educate, support and empower teachers of English Learners (ELs) teach content and language in tandem. To do this, Arizona State University partnered with the Arizona Geographic Alliance and local schools that have large EL populations. Through prior research with a National Geographic grant and U.S. Department of Education grant, a need for highly qualified teachers who have access and knowledge in how to teach integrated content while supporting ELs' language acquisition was crucial. The teachers involved participated in the STEMSS PD through a hybrid model and then developed and piloted a lesson that integrated PBL into their content lesson plan for diverse learners. The PD effectiveness, strategy implementation and content knowledge development were documented and analyzed through this mixed-methods study.

Currently, Arizona's public schools serve an estimated 85,000 English learners (ELs; Arizona Department of Education, 2018). This high number of ELs has brought about the necessity to ensure the educational experiences of these students, both linguistically and academically are of high quality and are effective. Research by Vaughn, et al. (2009), and Hinde, et al. (2011) all demonstrate the impact in English language development through content instruction. The intent of this project is to further the research in EL support through STEMSS (science, technology, engineering, math, and social studies) instruction by teachers who work with diverse populations utilizing a series of strategies that target academic language development through scaffolded content instruction.

EL students are continuing to fall further behind their counterparts in both language and content instruction (Jimenez-Silva, Gomez, & Cisneros, 2014). de Jong, Arias, & Sanchez, (2010) reported that teacher preparation to support ELs in Arizona has been significantly reduced since the establishment of restrictive policies at the K-12 level in the state. De Jong and colleagues (2010) explain that the effects of new teacher preparation practices established after Proposition 203 include the reduction of curricular requirements. This new number accounts for less than 10% of the preparation needed to effectively serve ELs (de Jong, et al. 2010). Because of these reduced requirements, professional development offered by local colleges, districts, and organizations are often provided to support TLLs as they navigate planning, instructing, and evaluating this population of students with whom they work. The STEMSS PD addresses this need with research and documentation on the effectiveness of the PBL training.



The PD intervention was informed by Shulman’s (2013) Knowledge Growth in Teaching framework; looking at the three types of knowledge: content, pedagogical, and curricular knowledge. The PD intervention was also informed by Lucas and Villegas’ (2013) Linguistically Responsive Teacher Education model. This research emphasized the need to move from conversational English skill development to academic language skill development through purposeful lessons that teach content and language in tandem. This work informs the need to specifically teach strategies to develop academic vocabulary, model strategies that are effective in supporting language acquisition during the content experiences, and to have teachers transfer this knowledge by developing lessons using these strategies to bring them to their classroom. Lucas and Villegas’ (2013) work also informed the measurement and analysis of the innovation’s effectiveness. To ensure teachers gained knowledge in meeting the needs of ELs, understanding of how to do this effectively through classroom instruction using PBL, and confidence in doing so as teachers change their pedagogical methods, three types of assessments were conducted. Beginning and end-of-year observations, pre, post, and maintenance surveys, and a focus group was conducted to gain quantitative and qualitative details about the application and implications of the PD on the TLLs’ teaching practices. These three data sources were analyzed for knowledge, understanding, and self-efficacy in teaching ELs and findings will be presented.

METHODOLOGY

K-12 teachers from across the United States were invited to participate in the STEMSS Institute. Due to Covid restrictions and changing modalities in teaching during the 2020-21 school year, the PD was conducted in a hybrid format with both synchronous and asynchronous opportunities. Both of these formats included PBL as part of the exploration of concepts, modeling effective PBL methodologies, as well as PBL examples provided so that teachers could immediately use in their classroom (both of which will be shared in the conference demonstration session). Teachers working with large numbers of ELs were strongly encouraged to apply and were given priority. Fifteen participants applied and were accepted as part of the STEMSS project.

Prior to the STEMSS PD, a core team with content and EL expertise designed and vetted the PD to ensure content, EL strategies, PBL practices, and leadership skills were integrated into an effective PD that included online modules, experts in the field, and integrated field trips. The culminating activity for the STEMSS Institute was a lesson plan that participants create, present, and disseminate through AZGA (<http://geoalliance.asu.edu/lessons/geomath>). After lesson plans are submitted and presented at the end of the PD, teachers are asked to pilot the lesson plan in their own classrooms. These lessons, once completed, were analyzed for use of strategies to teach the content.



A KUSE (knowledge, use, and self-efficacy survey adapted from Thibault, 2017) survey was administered before and after the PD. Following the completion of the PD, a pre-observation was collected using a language observation tool, OPAL (observing protocol for academic literacies) that was developed and tested for validity and reliability through the Loyola Marymount University Center for Equity for English Learners (2013). At the end of the school year, a post observation was conducted as well as a maintenance or follow-up survey to compare knowledge, use of strategies, and efficacy in supporting ELs in their classroom. This was done to compare knowledge gained after teachers implemented skills gained from the PD across the school year. In addition, a focus group was conducted to assess the effectiveness of the PD and change in pedagogical practices in the classroom over the course of the school year. This data along with the lesson plan analysis and snapshot surveys informed the interview discussions in learning what worked, why it worked, and how it worked. By better understanding the benefits of the PD and the realistic application of the learning to the classroom, the program will be refined for future TLL participants.

PRELIMINARY RESULTS

The quantitative data was collected to answer the quantitative research question: To what extent do teachers apply and describe the impact of the PD on their knowledge, skills, and self-reported efficacy. A T-Test was conducted using a comparison of T1 (pre KUSE) and T2 (post KUSE) to compare change as a result of the PD, T1 and T3 (maintenance KUSE) to compare change from the beginning of the research project to the end, and T2 and T3 to compare change after the PD with time to implement the PD into their teaching across the school year. As shown in Table 1, There was a significant difference in the knowledge gained from the pre and post KUSE ($M=.91$, $SD=.51$); $t(14)= 6.93$, $p=.000$, and pre KUSE and the maintenance or end-of-year KUSE ($M=.97$, $SD=.4$); $t(14)=9.45$, $p= .000$ (with significance being $p<.05$). There was a significant difference in the use (understanding of how to use the strategies to support ELs academic vocabulary) from the pre and post KUSE ($M=.56$, $SD=.49$); $t(13)= 4.52$, $p=.001$, between the post and maintenance KUSE ($M=.22$, $SD=.27$); $t(13)=3.05$, $p=.009$, and pre KUSE and the maintenance KUSE ($M=.86$, $SD=.48$); $t(14)=6.96$, $p= .000$. And finally, there was a significant difference in the self-efficacy between the pre KUSE and the maintenance KUSE ($M=.51$, $SD=.61$); $t(14)=3.28$, $p= .005$.



Table 1. T-Test of KUSE results between pre-post, post-maintenance, and pre-maintenance KUSE.

T-Test		<i>P</i>
PreKUSE - PostKUSE		
	Knowledge	0
	Use	0.001
	Self-Efficacy	0.212
PostKUSE - Maintenance KUSE		
	Knowledge	0.469
	Use	0.009
	Self-Efficacy	0.102
PreKUSE - Maintenance KUSE		
	Knowledge	0
	Use	0
	Self-Efficacy	0.005

The qualitative data was collected through pre and post observations, lesson plan analysis, and focus groups. These methods were used to answer the qualitative question: In what ways do teachers apply the 10 strategies that were taught in the PD throughout the school year? Graphic 1 shows the documented usage of each of the strategies emphasized, documents, and shared during focus groups; emphasizing usage by size.



Graph 1. The documented usage of each of the strategies emphasized, documents, and shared during focus groups; emphasizing usage by size.



CONCLUSION

In conclusion, the STEMSS identified an opportunity for TLLs to be supported in their work with the ELs in their classrooms through a PD that focuses on increasing teachers knowledge and skills in both content and language knowledge to linguistically diverse students using strategies in PBL activities. The results have identified successful methods in implementing EL supports into PBL content lessons to ensure teachers feel confident in teaching all students in their classrooms. The results have also identified suggested changes to better adapt the PD using hybrid formats to meet the needs TLLs in our local, national, and potentially international community.

REFERENCES

- Cobb, P., diSessa, A., Lehrer, R., & Schauble, L. Design Experiments in Educational Research, *Education Research*, 32(1), 9-13. 2003.
- Collier, V.P., & Thomas, W.P. *Educating English Learners For a Transformed World*. Fuente Press, New Mexico. 2009.
- Collier, V.P., & Thomas, W.P. *Creating Dual Language Schools for a Transformed World: Administrators Speak*. Fuente Press, New Mexico. 2014.



De Jong, E., Arias, M.B. & Sanchez, M.T. Undermining teacher competencies: Another look at the impact of restrictive language policies. In P. Gandara & M. Hopkins *Forbidden languages: English learners and restrictive language policies*. New York: Teachers College Press. 2010.

Echevarria, J. *Making Content Comprehensible for English Learners: The SIOP Model, 4th Edition*. Boston: Pearson. 2014.

Jimenez-Silva, M., Gomez L., & Cisneros, J. Examining Arizona's Policy Response Post Flores v. Arizona in Educating K-12 English Language Learners. *Journal of Latinos & Education*, 13(3), 181-195. 2014.

King, F. Teacher professional development to support teacher professional learning: Systemic factors from Irish case studies. *Teacher Development*, 20(4), 574-594. 2016.

Lee, J.; Su, F.; Chan, C.; Shan, H. "ELearning for teachers on water environment education," *Information Technology: Research and Education. ITRE 2005. 3rd. International Conference*, vol., no., pp.50,54, 27-30 June 2005.

Lucas, T. & Greenberg, J. Responding to the linguistic reality of mainstream classrooms: Preparing all teachers to teach English language learners. In Mochran-Smith,

S. Freiman-Nemer, D.J. McIntyre, (Eds.). *Handbook of research on teacher education: Enduring questions in changing contexts* (pp 606-636). New York: Routledge. 2008.

National Clearinghouse for English Language Acquisition. The growing number of English learner students 2009 –2010. Washington, DC: Author. Retrieved from http://www.ncela.us/files/uploads/9/growing_EL_0910.pdf 2011.

Shin, H. B., & Kominski, R. A. (2010). Language use in the United States: Retrieved from <http://www.census.gov/prod/2010pubs/acs-12.pdf>. 2017.

Thomas, W.P., & Collier, V.P. The Multiple Benefits of Dual Language. *Educational Leadership*, 61(2), 61-64. 2003.

Thomas, W.P., & Collier, V.P. *Dual Language Education for a Transformed World*. Fuente Press, New Mexico. 2012.



AUTHOR INFORMATION

Karen Guerrero, klinsle@asu.edu, United States, Arizona State University and STEMSS US DoE NPD Grant, (corresponding author)

Margarita Jimenez-Silva, mjimenezsilva@ucdavis.edu, United States, UC Davis (corresponding author)



THE PERCEPTION OF THE TEACHER IN THE ACTIVE TEACHING AND LEARNING PROCESS

Bárbara de Caldas Melo, Fábio Ferreira Amorim, Marina Dia Pereira & Geisa Santana

ABSTRACT

The challenge of current teaching is to use new pedagogical methodologies that enable the formation of a critical-reflective, ethical, transformative and humanized subject, and the transformations in education must be guided by teachers with a broader perception of scientific, social, cultural and academic methods (1). The use of active methodologies in the field of health, make it possible to build knowledge from the context of problems, development of skills and interaction in groups (2,3). The teaching and learning process of the Escola Superior de Ciências da Saúde undergraduate nursing course is centered on PBL, and the teacher is the learning facilitator and mediator. The research aimed to analyze the strengths and weaknesses of the teaching and learning process that involve the teaching-research-service integration based on the teachers' experience. This is an exploratory study with a qualitative approach. Data collection was performed by semi-structured interview. The data were analyzed using the IRAMUTEQ software, for analysis of the interviews. The 45 participating teachers showed adaptation to PBL, recognizing the importance of the teacher as a mediator and facilitator of the construction of the student's knowledge, with PBL being a stronghold for student learning. As a weakness, it was listed the low valuation of research within the institution. We evaluated the perception of the professors of the Nursing course, who positively perceived the teaching and learning processes as trainers of the critical-reflective student.

KEYWORDS: Problem-based learning, research, teaching, nursing

TYPE OF CONTRIBUTION: Practice-based abstract

PRESENTATION FORMAT: Interactive poster presentation

REFERENCES

- BULGRAEN, V.C. (2010). O papel do professor e sua mediação nos processos de elaboração do conhecimento. *Revista Conteúdo, Capavari*, v.1;n.4, ago/dez.
- CRISP, N.I; CHEN, L. (2014). Global supply of Health professionals. *The New England Journal of Medicine*. 370: 950-957.



MESQUITA, S.K.C.; MENESES, R.M.V.; RAMOS, D.K.R. (2016). Metodologias Ativas de Ensino/Aprendizagem: dificuldades de docentes de um curso de enfermagem. Trab. Educ. Saúde, Rio de Janeiro, v. 14 n. 2, p. 473-486, maio/ago.

AUTHOR INFORMATION

Bárbara de Caldas Melo, enf.barbaramelo@gmail.com, Brazil, UDF (corresponding author)

Fábio Ferreira Amorim, ffamorim@gmail.com, Brazil, ESCS

Marina Dia Pereira, marinadyas@gmail.com, Brazil, ESCS

Geisa Santana, geisa.santana0@gmail.com, Brazil, ESCS



TRAINING SCIENCE TEACHERS IN BRAZIL: BNCC, PBL, CHALLENGES AND SOLUTIONS

Herbert G Silva

ABSTRACT

In 2018, Brazil initiated a change in the teaching of Natural Sciences with the approval of the National Common Curricular Base - BNCC. With great theoretical and practical strength, the document became a reference in the construction of Science Curriculum for public schools. This requires teacher training that dominates teaching by research, a proposition that in the country, methodologically, is like Problem-Based Learning. In this article, we will report and analyze a training for science teachers from the years started in a PBL proposal for the development of the necessary skills for science teaching. Through a focus group, a methodology was carried out that is conducted as activities so that teachers experience PBL in their training and, therefore, can understand its use in an interdisciplinary way in the classroom with few didactic resources, a scenario that occurs in Brazilian schools.

KEYWORDS: Teacher training, PBL, Natural Sciences, Science Curriculum, Interdisciplinarity, Research teaching.

TYPE OF CONTRIBUTION: Practice-based abstract

PRESENTATION FORMAT: Interactive poster presentation

INTRODUCTION

Training Brazilian public school teachers is a great historic challenge. It faces the continental dimensions and cultural diversity of Brazil, which require that the regional aspects to be considered for this to occur. As of 2018, the implementation of the National Common Curricular Base - BNCC (BRAZIL, 2018) was initiated for the entire stage of Early Childhood Education and Elementary Education. For science education, the challenges involve modifying the conceptions and methodologies by which teachers develop activities with their students.

According to BNCC, science teaching, should give priority to scientific research, seeking to know its stages. Teachers can conduct its activities in two distinct ways from that principle. The first, scripting activities in a pre-established way: raising a problem issue, presenting hypotheses, demonstrating experiments (common practice in traditional teaching), comparing results already observed in history, systematizing proven results. The second way, which we attribute greater results the challenges, can be carried out from the questioning



of a situation or personal experience of students involved in their daily lives, to seek the development of a methodology. In this case, the teacher's role is to mediate and put the student as the protagonist in their learning processes, leaving explore and investigate without providing prior information related to the problem. We believe that the second option, genuinely is based on Problem Based Learning - PBL, is closer to the kind of science education provided by BNCC.

THEORETICAL FOUNDATION

The PBL is an interdisciplinary methodological approach that relates to teaching science for its epistemological study of natural phenomena using biology, chemistry, physics, astronomy and others. Its methodology places the student at the center of learning, through research, integrating theory and practice, requiring them to develop skills for viable way to solve a problem (Savery, 2006).

In this case, PBL was chosen because it is more effective in developing skills and abilities in long-term teaching experiences (Strobel & van Barneveld; 2009). The development of these are the fundamental structure of Sciences BNCC for primary education.

In Brazil, Infante-Malachias & Santos (2008) define that PBL is aligned with the perspective of problematization defined by Paulo Freire (1997). Thus, this approach used to train teachers there is a different perspective of traditional PBL. According to the authors, the alignment with a Freirian perspective, establishes a relational space among teachers without a tutelary hierarchy, but constituted in a relationship of equality of decision, with dialogue, devoid of a discourse of authority. Thus, teachers share knowledge and learning, learning mutually.

METHODOLOGY

Teacher training took place over two days, in an 8-hour workshop, in the State of Bahia, Brazil. For this constituted a group of 13 teachers, teachers of elementary school from 1 to 5 years - a period in which there is a demand among interdisciplinary curriculum components.

The training took place in four distinct steps. In step 1 (for 1 hour), teachers were encouraged to discuss the teaching of science and the challenges of teaching by research, presenting problems, concepts and arguments from their daily lives with students. In step 2 (1/2 hours) they were encouraged to choose a problem to be worked on collectively between them. In step 3 (5 hours) should work together in the solution of the problem identified in the final stage (1 hour and a half), to present and discuss the results found in this route.



Allowed the use smartphones and computers connected to the Internet to support served throughout the training process, given that the environment where the workshop took place also had chalk, blackboard, desks, books, generally the only resources of brazilian schools.

RESULTS

In steps teachers recorded their ideas, so that would use in the construction of didactic sequences - SD (Chart 1).

Chart 1: Registration of teachers in different stages.

Step s	Synthesis of the problematization	Records
I	Science teaching	Hypotheses; Experiences; Knowledge with meaning; Discoveries; Nature's phenomena; Search; Scientific advances; Nature; Environment; Biodiversity; Curiosity; Scientific knowledge; Job; Living beings; Responsibility; Health; Reflection; Pollution; Food; Processes; Learn.
II	Questioning	Propose alternatives; Respect for you and the other; Use different languages and technologies; Reliable information; Disseminate information; Political construction; Empowerment; Human enterprise; Ask questions; Search for answers; Socio-environmental; Argue based on data; Value diversity; Critical Thinking; Autonomy.
III	SD construction	Researchers; Knowledge as a foundation; Discoveries; Technology; welfare; experiences; self-control; search; Transformation of meanings; Human Construction; Significant learning, demonstration and investigative experiences; Logic; Consciousness; Social development.



Steps	Synthesis of the problematization	Records
Final	SD construction	<p>Opportunities: Contextualization; Questioning; Discoveries about Science; Advances; Possibilities; Enterprise; Meaningful Learning; Construction of knowledge; Investigation.</p> <p>Challenges: Mediate the concepts and / or answers brought to the problematization; Detach yourself from the mediating concept with the active PBL methodology; Associate the hypotheses with problematization; start problematization to didactic sequence; Abandon old practices; to Change the teaching method; Structure the SD.</p> <p>Easy things: Easy things: Registration of the process; Consolidation; Student at the center of the process; Understand what is to be protagonist and investigator; Child as a learning axis; use of reality and everyday life; Develop activities based on students' questions.</p>

In step 1, the teachers discussed concepts important to the teaching of science that should be encouraged, as use of data and evidence in the argument. Through problematization they related these concepts to the difficulties found in the classroom, such as:

- Inadequate textbooks to context and the local reality;
- Insufficient appropriate resources and spaces;
- Questions problems and Sciences disconnected from the reality of students;
- Lack of knowledge about teaching by research.

In step 2, they concluded that they should develop didactic sequences that would promote Teaching by Research through PBL and divided into two groups to share results and constructions according to two main themes:



- How to clean hands without the school had a sink?
- How to choose actions on a daily basis that conserve nature?

Figure 1. Picture of the discussions in steps 1 and 2.



In step 3, they built SDs based on their teaching experiences. This process reached the following results:

- Problem issues must start from the student's daily experience;
- The teacher should mediate the students to engage in dialogue, encouraging the construction of methodologies and solutions;
- Encourage the collection of evidence to obtain reliable results;
- Errors must be valued as opportunities for evaluation and re-planning;
- Pay attention to the difficulty of using the applied mode technology.

In the final stage, the teachers presented the results. In order to build the SDs, they simulated reality through the questions of step 2, the situations that could occur and what type of activity would lead the learning process. As a result of all the steps, they indicated the main opportunities when working with PBL and what difficulties they encountered (Chart 1).

FINAL CONSIDERATIONS

The methodology proved to be an effective strategy in the valuation of group work and in the methodological awareness of how to place the student at the center of learning, as a protagonist who develops his skills for the development of his autonomy. Teachers identified in PBL a methodology for building activities that value the context, teaching by research, interdisciplinary work and as a means of facilitating the implementation of BNCC. However, there are still great challenges to be overcome, such as more hours of training, modify



the common methods of teachers, resist the traditional perspective and exploration of other topics that arise from your reality and BNCC.

REFERENCES

BACICH, L. & MORAN, José. (2018) Metodologias ativas para uma educação inovadora.

Porto Alegre: Penso.

BRASIL (2018). Ministério da Educação. Base Nacional Comum Curricular. Brasília: MEC. FREIRE, P. (1997) Pedagogia da Autonomia. São Paulo: Paz e Terra.

MALACHIAS, M. E. I. & SANTOS, S. (2008) Interdisciplinaridade e resolução de problemas: algumas questões para quem forma futuros professores de ciências. Educ. Soc., campinas, vol. 29, n. 103, p. 557 – 559. Disponível em <http://www.cedes.unicamp.br>.

SAVERY, J. R. (2006). Overview of Problem-based Learning: Definitions and Distinctions. Interdisciplinary Journal of Problem-based Learning, 1(1). Indiana: Purbue University.

STROBEL, J., & VAN BARNEVELD, A (2009). When is PBL More Effective? A Meta- synthesis of Meta-analyses Comparing PBL to Conventional Classrooms. Interdisciplinary Journal of Problem-based Learning, 3(1). Indiana: Purbue University.

AUTHOR INFORMATION

Herbert G Silva, herbert.gomes@ufba.br, Brazil, Federal University of Bahia (corresponding author)



PROCESS OF DEVELOPING AN INTERNATIONAL PBL-BASED STUDY PROGRAM

Siska Simon, Marisa Hammer & David Fasani

ABSTRACT

Icam, a private University with engineering courses most of their campuses in France but also with campuses in different countries, was planning to set up a new open study program based on Problem-based Learning called “parcours ouvert”.

The Centre of Teaching and Learning (ZLL) of the Hamburg University of Technology has experts on Problem- (Marisa Hammer) and Project-based Learning (Siska Simon), who have experienced the learning settings in Twente, Aalborg and Maastricht.

The poster shows each step of the process that has been designed to establish and evaluate the first year of “parcours ouvert” and to answer the following questions:

- How can we make sure that all campuses share the same understanding of the methodology principles?
- How can we build up a blended PBL structure to connect students and teachers from different countries?
- How can we involve students in this process?

The programme started successful and we would like to share our experiences during the consultancy process.

KEYWORDS: development of a study programme, Problem- and Project-based learning, PBL in an international context, Interdisciplinary team, Blended learning, consultancy on a competency-based approach, PBL - cross countries

TYPE OF CONTRIBUTION: Practice-based abstract

PRESENTATION FORMAT: Interactive poster presentation

Icam, a private University with engineering courses most of their campuses in France (Lille, Sénart, Nantes, Vannes, La Roche-sur-Yon, Toulouse) but also with campuses in different countries (Cameroon, Democratic Republic of Congo, Brazil), was planning to set up a new open study program called “parcours ouvert”. Icam



wanted to implement Problem-based Learning (PBL) and a project as the core learning methodology as a competency-based approach.

Although there are universities having PBL and Project-based Learning implemented (for example University of Twente, Maastricht and Aalborg) of which can be learned from, Icam was confronted with other unique challenges and asked for external consultation.

- How can we make sure that all campuses share the same understanding of the methodology principles?
- How can we build up a blended PBL structure to connect students and teachers from different countries?
- How can we involve students in this process?

The Centre of Teaching and Learning (ZLL) of the Hamburg University of Technology has experts on Problem- (Marisa Hammer) and Project-based Learning (Siska, Simon), who have experienced the learning settings in Twente, Aalborg and Maastricht. The poster shows each step of the process that has been designed to establish and evaluate the first year of “parcours ouvert”.

AUTHOR INFORMATION

Siska Simon, siska.simon@tuhh.de, Germany, Hamburg University of Technology, (corresponding author)

Marisa Hammer, marisa.hammer@tuhh.de, Germany, Hamburg University of Technology, (corresponding author)

David Fasani, david.fasani@icam.fr, France, Icam, (corresponding author)