



Aalborg Universitet

AALBORG UNIVERSITY  
DENMARK

## Distributed Finite-Time Fault-Tolerant Control of Isolated AC Microgrids Considering Input Constraints

Jamali, Mahmood ; Reza Baghaee, Hamid; Sadabadi, Mahdih S.; B. Gharehpetian, Gevork; Anvari-Moghaddam, Amjad; Blaabjerg, Frede

*Published in:*  
I E E Transactions on Smart Grid

*DOI (link to publication from Publisher):*  
[10.1109/TSG.2022.3188199](https://doi.org/10.1109/TSG.2022.3188199)

*Publication date:*  
2022

*Document Version*  
Accepted author manuscript, peer reviewed version

[Link to publication from Aalborg University](#)

*Citation for published version (APA):*

Jamali, M., Reza Baghaee, H., Sadabadi, M. S., B. Gharehpetian, G., Anvari-Moghaddam, A., & Blaabjerg, F. (2022). Distributed Finite-Time Fault-Tolerant Control of Isolated AC Microgrids Considering Input Constraints. / *I E E Transactions on Smart Grid*, 13(6), 4525-4537. Article 9814863. <https://doi.org/10.1109/TSG.2022.3188199>

### General rights

Copyright and moral rights for the publications made accessible in the public portal are retained by the authors and/or other copyright owners and it is a condition of accessing publications that users recognise and abide by the legal requirements associated with these rights.

- Users may download and print one copy of any publication from the public portal for the purpose of private study or research.
- You may not further distribute the material or use it for any profit-making activity or commercial gain
- You may freely distribute the URL identifying the publication in the public portal -

### Take down policy

If you believe that this document breaches copyright please contact us at [vbn@aub.aau.dk](mailto:vbn@aub.aau.dk) providing details, and we will remove access to the work immediately and investigate your claim.

# Distributed Finite-time Fault-Tolerant Control of Isolated AC Microgrids Considering Input Constraints

Mahmood Jamali, Hamid Reza Baghaee, *Member, IEEE*, Mahdiah S. Sadabadi, *Senior Member, IEEE*, Gevork B. Gharehpetian, *Senior Member, IEEE*, Amjad Anvari-Moghaddam, *Senior Member, IEEE* and, Frede Blaabjerg *Fellow, IEEE*

**Abstract**—This paper presents a distributed fault-tolerant finite-time control scheme for the secondary voltage and frequency restoration of islanded inverter-based Alternating Current (AC) Microgrids (MGs) considering input saturation and faults. Most existing distributed methods commonly design the secondary control layer based on ideal conditions of the control input channels of the MG without any faults and disturbances. At the same time, MGs are exposed to actuator faults that can significantly impact the control of MGs, and lead the MG in unstable situations. One of the other typical practical constraints in multi-agent systems such as MGs is saturation. The other novel idea is that a consensus-based scheme synchronizes the islanded MG's voltage and frequency to their nominal values for all DGs within finite time, irrespective of saturation and multiple faults, including partial loss of effectiveness and stuck faults simultaneously. Finally, the performance of the proposed control schemes are verified by performing an offline digital time-domain simulation on a test MG system through a couple of scenarios in MATLAB/Simulink environment. The effectiveness and accuracy of the proposed control schemes for islanded AC MGs are compared to previous studies, illustrating the privilege of that.

**Index Terms**—Actuator faults, distributed control, finite-time, microgrids, saturation, voltage and frequency synchronization.

## NOMENCLATURE

### A. DG Parameters

$i, j$	Indices for DG units
$v_i^{nom}, w_i^{nom}$	Voltage and frequency reference values
$v_{oi}^{d,q}$	Direct and quadrature components of the output voltage
$P_i, Q_i, m_i^P, n_i^Q$	Active power, reactive power and their corresponding droop constants
$m_i^P, n_i^Q$	Active and reactive power droop constants

M. Jamali is with the Department of Automatic Control and Systems Engineering, University of Sheffield, Sheffield S1 3JD, United Kingdom (e-mail: mahmood.jamali@sheffield.ac.uk).

H.R. Baghaee and G. B. Gharehpetian are with the Department of Electrical Engineering, Amirkabir University of Technology, Tehran, Iran (e-mails: hrbaghaee@aut.ac.ir and grptian@aut.ac.ir).

M. S. Sadabadi is with the School of Electronic Engineering and Computer Science, Queen Mary University of London, London, United Kingdom (e-mail: m.sadabadi@qmul.ac.uk).

A. Anvari-Moghaddam and F. Blaabjerg are with the Department of Energy, Aalborg University, Aalborg 9220, Denmark (e-mails: aam@energy.aau.dk and fbl@energy.aau.dk).

$u_i^v, u_i^\omega, u_i^p$	Auxiliary voltage, frequency, and active power-sharing inputs.
----------------------------	--

### B. Fault Parameters

$\theta_i^v(t)$	Unknown time-varying multiplicative faults
$\underline{\theta}_i^v(t), \bar{\theta}_i^v(t)$	Lower and upper bounds of multiplicative actuator faults
$v_i^{fv}, \bar{u}_{i\omega}, \bar{u}_{iP}$	Faulty voltage and frequency control signals
$v_i^{vs}(t), \varphi_i^v(t)$	Unknown time-varying stuck faults, occurrence of the stuck fault
$v_M^v$	Limitation of the actuator

### C. Control Parameters

$\alpha_{i1,2}^v, \alpha_{i1,2}^\omega, \alpha_{i1,2}^p$	Positive adaptive parameters
$\sigma_{ij}^v, \sigma_{ij}^\omega, \sigma_{ij}^p$	Positive constants
$Q(\gamma), P(\gamma)$	Positive feedback matrix, positive definite design matrix

## I. INTRODUCTION

**I**N Alternating Current (AC) Microgrids (MGs), the main control challenges are voltage and frequency synchronization subject to active and reactive power-sharing of Distributed Generations (DGs). For providing global stability in MGs, a hierarchical control structure consisting of primary, secondary, and tertiary control layers has been widely proposed to standardize their operation and functionalities [1]. The primary and secondary control levels and the local control loops generally interact with each other by a cascaded structure [2]. The tertiary control layer usually deals with optimal power flow and economic dispatch independent of primary and secondary controllers. The steady-state errors of frequency and voltage resulting from the primary control layer are compensated by the secondary control layer [3]. Conventionally, a centralized controller was used to receive the necessary information and optimize the power flow problems. However, when the number of DGs in an MG increases, the centralized control approach needs higher bandwidth communication [4]. Also, this approach suffers from single-point failures, poor Plug and Play (PnP) capability, and low fault tolerance performance [5]. In contrast, distributed control approach is more appropriate for the secondary control of MGs. Many various aspects of distributed control of MGs

have been investigated in literature for time-delay [6], [7], noise-resiliency [8], attack-resiliency [9], [10], and finite-time consensus [11]–[13]. The consensus-based distributed control has also been widely proposed in MGs for synchronization of voltage, and frequency to their nominal values [14]–[17]. Indeed, the main challenges of isolated operations in these papers are voltage and frequency restoration by considering small and large signal disturbances. In this way, the MG is considered as a multi-agent system where each DG is an agent. The communication among local DERs allows the coordination of individual DGs, including frequency/voltage restoration, active/reactive power-sharing, and smooth switching operations. Authors in [18], based on the feedback linearization technique, have proposed a secondary controller for islanded MGs. In this approach, ideal conditions for the control inputs and communication channels have been considered. However, in practical applications, the communication networks possess different limitations and restrictive conditions.

Considering the non-ideal conditions, problems such as fault-tolerant controls have been investigated [1], [19], [20]. Actuator faults can deteriorate the performance of the system as a large control signal is always required to mitigate the impacts of faults. In general, electrical devices are prone to various faults caused by changes in environmental conditions such as humidity and temperature, faults caused by EMC problems, contact problems, and packaging failures [21]. In addition, semiconductors are vulnerable to different faults like metallization failures, and electrical overstress [22]. According to the findings in [23], semiconductor switch failures can appear in the output signals of the power converter, which can be considered as a fault in the system. The other important problem for the implementation of control algorithms is the input saturation, which is a usual type of nonlinearity in the control system, especially in actuators caused by impossibilities in applying unlimited control signals [17], [24]. Due to the limits on the duty cycles and nonidealities in the components, and some software/hardware limits, the power converters are inherently nonlinear systems [25]. Also, saturation is common in the current controllers for overcurrent protection [26]. The mentioned nonlinearities can affect the performance of the power converters and even the stability of the closed-loop system. It is known that high-gain feedback can be employed to handle any input disturbances [27]. However, when the partial loss of effectiveness faults exists in the control system, this method cannot provide a desirable performance against saturation and faults. Therefore, it is clear that the previously reported works cannot achieve the consensus in the presence of the above input constraints. Discarding the limitations conduces to controller wind up, leading to poor transients such as large settling time and large rise time in the response. In addition, transient performance and convergence time to a steady-state value are the crucial performance indexes that can easily be affected by actuator faults. Worth to be noted that in classical LTI control systems, the states of the closed-loop systems asymptotically converge to equilibrium point provided that the closed-loop system is asymptotically stable. These methods can only

guarantee the convergence at the steady-state, i.e., as  $t \rightarrow \infty$ . However, they cannot guarantee this convergence will happen in finite time. In contrast, the finite-time control methods ensure that the convergence will happen in finite-time. In multi-agent systems, inspired by the natural synchronization phenomena [28], the finite-time control schemes have been proposed based on the information measurements among the neighboring agents (e.g., [29], [30]). These control schemes are robust against perturbations and measurement errors and are faster than the conventional distributed control algorithm [31], [32]. From a practical perspective, sensitive loads in MGs require operation at the nominal voltage and frequency. Besides a finite mitigating time, the finite-time control provides robust performance, higher accuracy, and disturbance rejection properties [33]. Hence, it is desirable to accelerate the synchronization process and achieve the consensus in a finite time. Several existing works such as [33]–[36] have investigated some types of finite-time secondary control of MGs to speed up the synchronization process of both voltage and frequency. In particular, a finite-time control protocol has been proposed in [36] to synchronize the frequency and regulate the voltage for islanded MGs. This paper shows that the contrary the conventional distributed method, the finite-time controller can even maintain finite time convergence in frequency synchronization and voltage regulation under changing the communication topology.

This paper proposes a novel finite-time consensus secondary voltage and frequency control strategy for islanded AC MGs subject to input saturation and actuator faults. To this end, a distributed adaptive technique into the secondary control layer is suggested to restore voltage and frequency. Note that, similar to several recent studies such as [19], we consider the nonlinear dynamic of DGs. The disadvantage of using linear dynamics is that it cannot be effectively used for MGs simulation, especially when there are large-signal disturbances. To the best of our knowledge, this is the first paper investigating the problem of secondary voltage and frequency regulation in the presence of input saturation under faults in AC MGs. Motivated by the problems mentioned above, the main contributions of this paper can be summarized as follows:

- A novel fault-tolerant finite-time control scheme in the presence of saturation in the control inputs is proposed for islanded AC MGs based on a distributed algorithm in the secondary control layer of MGs, which can restore the voltage and frequency, and realize active/reactive power-sharing. The presented method is based on a nonlinear adaptive law that guarantees finite-time semi-global stability of the closed-loop control system, considering input limitations and faults.
- Unlike the existing works on the problem of distributed secondary control with faults [1], and [19], we consider time-varying faults in the multiplicative term where the upper and lower bounds of fault factors are unknown, which is close to practical situations. Besides, our method can tackle stuck faults differently from the low gain approaches.
- From a practical point of view, loads in MGs require

to operate at the reference value of voltage and frequency. Hence, it is desirable to accelerate the synchronization and guarantee consensus in a finite time. Additionally, the finite-time control approaches provide robust performance, stability, and disturbance rejection. In this paper, finite-time semi-global stability can be achieved despite faults and saturation. It is worth mentioning that by using the proposed scheme, there is no need to have quantitative information of the fault such as amplitude, frequency, and type of signals. We need to make sure that the fault signals are bounded. This assumption is common in the design of robust control systems [37].

It should be highlighted that in control problems, different kinds of software and hardware damage to the input controller that might affect the control commands can be considered as input constraints such as fault and saturation [33]. Faults can have devastating effects on the performances and cause the information security in the MG to be vulnerable. Fault-tolerant controllers help MGs ride through software and hardware damages. The authors in [38] and [39] classify the faults according to eight basic points of view that can lead to some classes of faults by objectives, system limits, phenomenological causes, stage of creation, or occurrence. These unwanted phenomena can be unveiled through different modes of faults in the control system. In MGs, inverters are considered as real actuators [40]. Therefore, any failure or fault in these actuators might cause faulty signals in the control loop, which can affect the whole performance and stability. It should be noted that a type of fading channel also has the same effect on the control systems [41].

The rest of the paper is organized as follows: preliminaries of the problem, including a model of communication between DGs, model of faults, and dynamic model of the MG are introduced in Section II. The proposed distributed fault-tolerant scheme for voltage regulation and frequency synchronization are provided in Sections III and IV, respectively. The performance of the control schemes based on offline digital time-domain simulations and the comparison with other works are presented in Section V. Finally, conclusions are stated in Section VI.

## II. PRELIMINARIES

### A. Notation

$\|\cdot\|$  represents the Euclidian norm of vectors or matrices.  $I$  denotes the identity matrix with appropriate dimensions.  $\text{diag}\{d_1, d_2, \dots, d_n\}$  stands a block-diagonal matrix with  $d_1, d_2, \dots, d_n$ , on its diagonal. For any symmetric matrix  $Q(\gamma) \in \mathbb{R}^{n \times n}$ ,  $\lambda_i$  is the  $i$ -th eigenvalue of  $Q(\gamma)$  and,  $\lambda_{\max}$  and  $\lambda_{\min}$  show the maximum and minimum eigenvalues of  $Q(\gamma)$ , respectively.  $\text{Re}\{\lambda_i(Q(\gamma))\}$  means the real part of  $\lambda_i(Q(\gamma))$ .  $Q(\gamma) > 0$  denotes  $Q(\gamma)$  is a real symmetric and positive definite matrix.

### B. Communication Graph model

In an AC MG consisting of  $N$  DGs, the communication network among DGs can be described by an undirected graph

$\mathcal{G} = (\mathcal{V}, \mathcal{E}, \mathcal{A})$ , where  $\mathcal{V} = \{\nu_i : i \in \mathbb{N}\}$  is a set of nodes, representing each DG in the MG, and  $\mathcal{E} \subseteq \mathcal{V} \times \mathcal{V}$  is a set of edges. If the node  $\nu_i$  can communicate with the other node  $\nu_j$ , there exists an edge  $(\nu_i, \nu_j) \in \mathcal{E}$  between them.  $\mathcal{A} \in \mathbb{R}^{N \times N}$  is defined as the adjacency matrix, where  $a_{ij} = a_{ji}$ ,  $a_{ii} = 0$ .  $a_{ij} > 0$  if the  $i$ -th DG receives (transmits) the information from (to) the  $j$ -th DG and, otherwise,  $a_{ij} = 0$ . The set of neighbors of DG  $i$  is defined as  $N_i = \{\nu_j \in \mathcal{V} : (\nu_j, \nu_i) \in \mathcal{E}\}$ . The Laplacian matrix of the graph associated with  $\mathcal{A}$  is defined as  $\mathcal{L} = [l_{ij}] \in \mathbb{R}^{N \times N}$ , where  $l_{ii} = \sum_{j \neq i} a_{ij}$ , when  $i = j$ . In communication network of MGs, the nominal values for voltage and frequency are only accessible for a leader node that can be connected to a few DGs.  $\bar{\mathcal{G}} = \text{diag}[a_{i0}]$  is defined as a diagonal pinning matrix, where  $a_{i0} > 0$  if the  $i$ -th DG ( $\nu_i$ ) can directly receive information of the leader, otherwise  $a_{i0} = 0$ . Also, we define  $\beta = \mathcal{L} + \bar{\mathcal{G}}$ .

### C. Inverter-based MG modeling

This section presents the state space formulation of MG proposed in [14]. The physical layer of inverter-based MGs includes a DC energy source, a voltage source inverter, the primary and the secondary control layer, the series LCL filter, and the output connector (demonstrated in Fig. 1). As mentioned before, the communication layer among DGs is modeled by a graph through which each DG is considered as an agent. In the primary control layer, the control loops use PI controllers to regulate the output voltage and frequency of inverters. It should be noted that each DG's nonlinear large-signal model is presented in its rotating d-q (direct-quadrature) reference frame concerning a selected DER as a common reference frame. Since some deviation in voltage and frequency generated by the primary control layer, the main aim of the secondary control is to restore them to their desired values. To come up a proper secondary controller, we use the following droop equations for the  $i$ -th DG [42]:

$$\omega_i = \omega_i^{\text{nom}} - m_i^P P_i \quad (1)$$

$$\begin{cases} v_{odi} = v_i^{\text{nom}} - n_i^Q Q_i \\ v_{oqi} = 0 \end{cases} \quad (2)$$

As previously mentioned, DG units are nonlinear and heterogeneous systems. Additionally, due to the differences between DG's parameters, the dynamic of units are heterogeneous and non-identical. Some previous studies in the literature only considered the simplified linear dynamics of DG units and ignored the nonlinear model of these units. According to the findings in [43], linear dynamics are only proper and valid for the analysis and controller design around the equilibrium points of the system. They cannot be extended for the analysis and simulations of the system in different conditions. In the feedback linearization technique, we do not discard the nonlinear terms in the model; we cancel them using feedback terms. Thus, input-output feedback linearization is required to transform the nonlinear dynamic of DGs to a linear one. Once the input-output feedback linearization technique is used, the secondary control is converted to a multi-agent tracking problem. To design any control scheme into the secondary control layer, by utilizing the feedback linearization

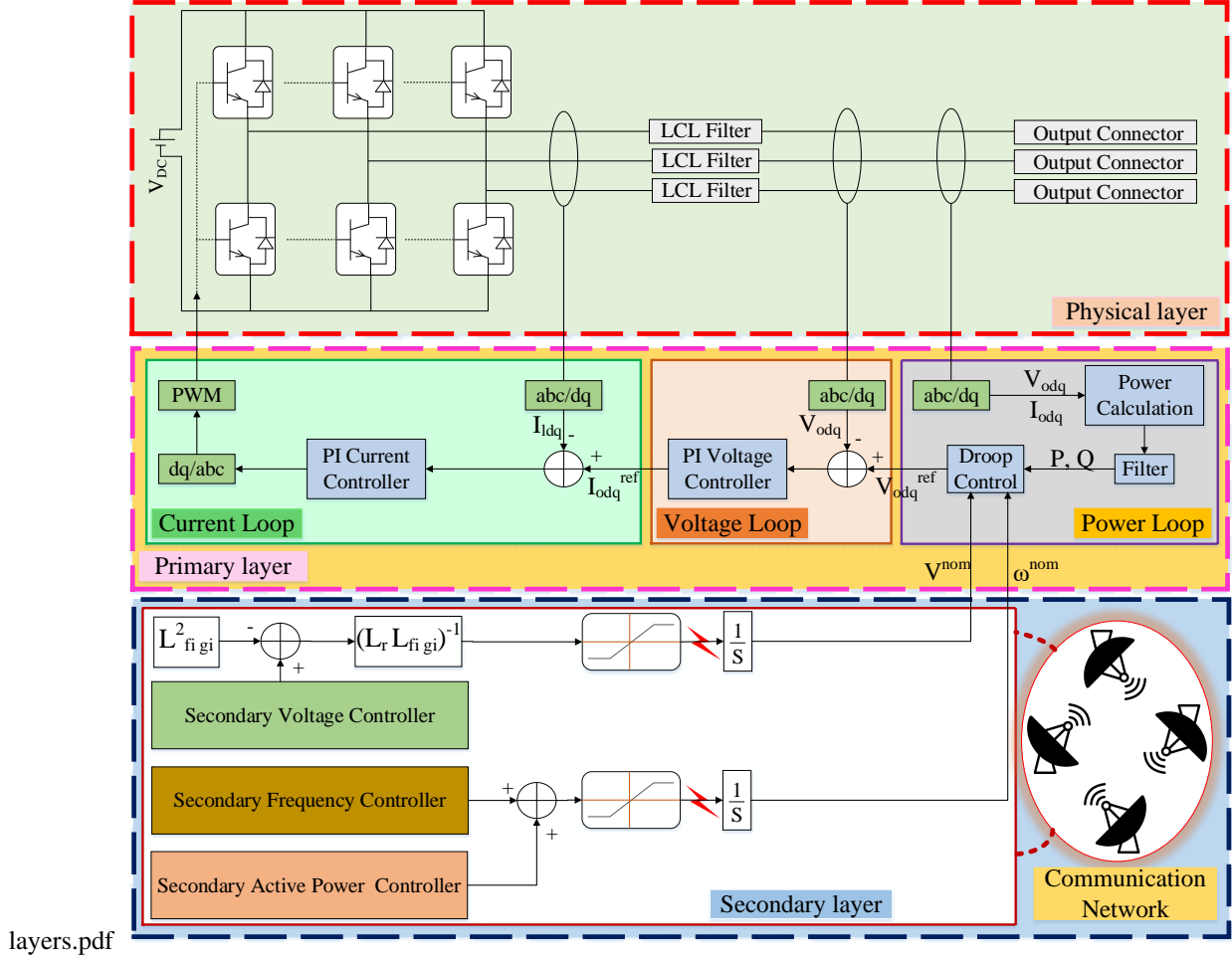

Fig. 1: The MG's control layers.

technique and combining dynamic models of the control loops and filters, the dynamics of each DG in MGs can be described as follows [19]:

$$\begin{cases}
 \dot{\delta}_i = \omega_i^{nom} - m_i^P P_i - \omega_{com} \\
 \dot{P}_i = \omega_{ci} (v_{odi} i_{odi} + v_{oqi} i_{oqi} - P_i) \\
 \dot{Q}_i = \omega_{ci} (v_{odi} i_{oqi} - v_{oqi} i_{odi} - Q_i) \\
 \dot{i}_{ldi} = \frac{-R_{fi}}{L_{fi}} i_{ldi} + \omega_{com} i_{lqi} + \frac{v_i^{nom} - n_i^Q Q_i - v_{odi}}{L_{fi}} \\
 \dot{i}_{lqi} = \frac{-R_{fi}}{L_{fi}} i_{lqi} - \omega_{com} i_{ldi} - \frac{v_{oqi}}{L_{fi}} \\
 \dot{v}_{odi} = \omega_{com} v_{oqi} + \frac{i_{ldi} - i_{odi}}{C_{fi}} \\
 \dot{v}_{oqi} = -\omega_{com} v_{odi} + \frac{i_{lqi} - i_{oqi}}{C_{fi}} \\
 \dot{i}_{odi} = \frac{-R_{ci}}{L_{ci}} i_{odi} + \omega_{com} i_{oqi} + \frac{v_{odi} - v_{bdi}}{L_{ci}} \\
 \dot{i}_{oqi} = \frac{-R_{ci}}{L_{ci}} i_{oqi} - \omega_{com} i_{odi} + \frac{v_{oqi} - v_{bqi}}{L_{ci}}
 \end{cases} \quad (3)$$

The impact form of the above equation can be written as:

$$\begin{cases}
 \dot{x}_i = f_i(x_i) + W_i(x_i)H_i + r_{i1}(x_i)u_{i1} + r_{i2}(x_i)u_{i2} \\
 y_{i1} = g_{i1}(x_i) \\
 y_{i2} = g_{i2}(x_i) + h_i u_{i2}
 \end{cases} \quad (4)$$

where  $H_i = [\omega_{com} v_{bdi} v_{bqi}]^T$  is considered as a known disturbance, the state vector is  $x_i =$

$[\delta_i \ P_i \ Q_i \ \phi_{di} \ \phi_{qi} \ \gamma_{di} \ \gamma_{qi} \ i_{Ldi} \ i_{Lqi} \ v_{odi} \ v_{oqi} \ i_{odi} \ i_{oqi}]^T$ ,  $u_i = [u_{i1} \ u_{i2}]^T$  is the input vector and  $y_i = [y_{i1} \ y_{i2}]^T$  is the output vector, accordingly. The detailed descriptions of the functions  $f_i(\cdot)$ ,  $W_i(\cdot)$ ,  $r_i(\cdot)$ , and  $g_i(\cdot)$  can be obtained from the state-space equations in 3.

For the secondary voltage control of MGs, we define  $F_i(x_i) = f_i(x_i) + W_i(x_i)H_i$ , then the voltage dynamics of each DG are obtained as follows:

$$\begin{cases}
 \dot{y}_{i1} = \dot{v}_{odi} \\
 \dot{y}_{i2} = \ddot{v}_{odi} = L_{F_i g_{i1}}^2 + L_{r_{i1}} L_{F_{i1} g_{i1}} u_{i1}
 \end{cases} \quad (5)$$

where  $L_{F_i g_i} = [\partial g_i / \partial x_i] F_i(x_i)$  and  $L_{F_{i1} g_{i1}}^2 = [\partial L_{F_{i1} g_{i1}} / \partial x_i] F_i(x_i)$  denotes Lie Derivative [43] of  $g_{i1}$  with  $F_i$ . So, one can write (5) as:

$$\dot{y}_i = A y_i + B v_i^v(t) + D^v d_i^v \quad (6)$$

where  $v_i^v = L_{F_i g_{i1}}^2 + L_{r_{i1}} L_{F_{i1} g_{i1}} u_{i1}$  is the virtual input,  $y_i = [v_{odi} \ \dot{v}_{odi}]^T = [y_{i1} \ y_{i2}]^T$ ,  $A = \begin{bmatrix} 0 & 1 \\ 0 & 0 \end{bmatrix}$ ,  $B = [0 \ 1]^T$ ,  $D^v = [1 \ 0]^T$  and  $d_i^v$  denotes the external disturbance or can be considered as the modeling error. Hence, the control input can be defined as  $u_{i1} = \frac{(-L_{F_i g_{i1}}^2 + v_i)}{(L_{r_{i1}} L_{F_{i1} g_{i1}})}$ . As

explained in some previous related papers (e.g., [44]–[46]), input-output feedback linearization is utilized to facilitate the distributed secondary controller design without linearizing the DG dynamics. It should be mentioned that the feedback linearization can only use for the modeling purpose and not the control design. In fact, the proposed secondary control approach in this paper is linear (see (11)). Also, from the dynamic model in (3), derived from the LCL filters and the output connectors, it can be figured out that the variables in  $L_{F_i g_{i1}}^2$  and  $L_{r_{i1}} L_{F_i g_{i1}}$  include measurable variables and DG's filters parameters. Therefore, the compensator block, corresponding to the feedback linearization technique, can be implemented into the secondary control layer. To increase the accuracy of the linearization, the effect of measurement noise or parameter inaccuracy can be overcome by employing some methods discussed in the literature such as [5] and [17], which are out of the scope of this paper. The block diagram of distributed secondary voltage control is shown in Fig. 1. Based on the state-space model in 6, now, the aim of the secondary control level is to find an appropriate voltage control  $v_i$  as  $y_{i1}$  converges to  $v_{ref}$  in order to reach a consensus considering the constraints in the control input.

#### D. Fault Model

In general, from modeling point of view, faults can be in the form of additive or multiplicative. Multiplicative faults appear as a product of the fault signal in one or multiple variables, which can be considered intermittent faults like pulse and sine functions. In this paper, we consider the time-varying multiplicative (partial loss of effectiveness) faults, which are common in practical applications and have been used in several studies, [1], [19], [41]:

$$v_i^{fv} = \theta_i^v(t) \text{sat}(v_i^v(t)) + \varphi_i^v(t) v_i^{vs}(t) \quad (7)$$

$$\text{sat}(v_{ij}^v(t)) = \begin{cases} v_M^v & v_{ij}^v \geq v_M^v \\ v_{ij}^v & -v_M^v < v_{ij}^v < v_M^v \\ -v_M^v & v_{ij}^v \leq -v_M^v \end{cases} \quad (8)$$

where  $\theta_i^v(t)$  satisfies  $0 \leq \theta_i^v(t) \leq \bar{\theta}_i^v(t) \leq 1$ .  $\varphi_{ij}^v(t) \in \{0, 1\}$  is used to determine the occurrence of the stuck fault.  $v_i^{vs}(t)$  will be a constant as long as the stuck fault exists. It is obvious that when  $\theta_i^v(t) = 1$  and  $\varphi_i^v(t) = 0$ , there is no fault in the MG and whenever  $\varphi_i^v(t) = 1$  stuck faults occur in actuators.

**Assumption 1.** The graph considered as a communication topology for MGs is undirected and connected.

**Assumption 2.** The bounds of faults and disturbances considered in this paper satisfy  $[\lambda_{\max}(B_2 B_2^T) \bar{\delta}_i] / [\lambda_{\min}(B_2 \theta_i B_2^T)] (v_M^v - s_t)$ , where  $i \in \mathcal{V}$ ,  $\bar{\delta}_i$  is the upper bound of  $\delta_i^v(t) = \varphi_i^v(t) v_i^{vs} + d_i^v(t)$ ,  $s_t$  is a constant with  $0 < s_t < v_M^v$  and  $B_2$  is given by a full-rank decomposition  $B = B_1 B_2$  [47].

**Lemma 1.** [27] Consider a dynamical system described by  $\dot{y} = f(y)$  and let  $V(y)$  be a differentiable function with  $V(y) \geq$

0. The origin of the system is finite-time stable if there are positive scalars  $z_a > 0$ ,  $c_a > 0$  and  $0 < \eta < \infty$  such that:

$$\dot{V}(y) \leq -z_a V(y) + \eta \quad (9)$$

For any  $0 < c_a < 1$ , the trajectory of  $y$  will be limited to the relict set  $\Lambda = \left\{ y \mid V(y) \leq \frac{\eta}{z_a(1-c_a)} \right\}$  and the upper bound of the settling time  $t_s$  is estimated as follows:

$$t_s \leq \frac{1}{z_a c_a} \ln \frac{(1-c_a)V(y(0))}{\eta} \quad (10)$$

### III. DISTRIBUTED FINITE-TIME FAULT-TOLERANT VOLTAGE CONTROLLER

This section aims to design a distributed finite-time leader-following consensus of voltage regulation subjected to faults with input saturation in the control input channels. Then, the stability and semi-global consensus of the closed-loop control system are analyzed. Moreover, the steady-state error and the settling time are proposed in analytic forms. Note that this approach, in comparison to the traditional low-and-high gain methods which can only use for additive disturbances, can alleviate the effects of faults. In addition, by using the parametric form of the Riccati equation, this design provides a parametric stable solution.

Let  $e_i^v(t)$  stands for the collection of local information for DG  $i$ , which can be represented by:

$$e_i^v(t) = \sum_{j=1}^N a_{ij}(y_i(t) - y_j(t)) + a_{i0}(y_i(t) - y^{ref}) \quad (11)$$

where  $a_{ij}(y_i(t) - y_j(t))$  can denote the weighted exchanged information between  $i$ -th and  $j$ -th DGs. Considering the properties of the Kronecker product, one can write:

$$e^v(t) = (\beta \otimes I)y(t) \quad (12)$$

where  $e^v(t) = \text{col}\{e_1^v(t), e_2^v(t), \dots, e_N^v(t)\}$ . The distributed finite-time scheme in the secondary control layer for each DG is designed as follows:

$$\begin{cases} \dot{v}_i^v(t) = -\alpha_{i1}^v(t) q_i^v(t) - b_{ij}^v(\gamma, t) \\ b_{ij}^v(\gamma, t) = \frac{\alpha_{i2}^{v2}(t) q_{ij}^v(\gamma, t)}{\alpha_{i2}^v(t) \|q_{ij}^v(\gamma, t)\| + \varepsilon(\gamma) \Upsilon(t)} \end{cases} \quad (13)$$

where  $i \in \mathcal{V}_i$ ,  $q_i^v = B^T P(\gamma) e_i^v(t)$ ,  $\alpha_{i1}^v$ ,  $q_{ij}^v(\gamma, t)$  and  $b_{ij}^v(\gamma, t)$  are the  $j$ -th elements of  $q_i^v(\gamma, t)$  and  $b_i^v(\gamma, t)$ , respectively.  $P(\gamma)$  will be introduced in the rest of the paper. The adaptation law of the mentioned parameters is described as follows:

$$\begin{cases} \dot{\alpha}_{i1}^v = v_M^v (-\sigma_{i1}^v \alpha_{i1}^v(t) + \|q_i^v(t)\|^2) \\ \dot{\alpha}_{i2}^v = v_M^v (-\sigma_{i2}^v \alpha_{i2}^v(t) + \|q_i^v(t)\|) \end{cases} \quad (14)$$

where  $\varepsilon^v(\gamma) = (\lambda_{\min}(Q(\gamma)) / \lambda_{\max}(P(\gamma)))$ .

**Remark 1.** Following the low-and-high gain feedback principle, the first term in (13) is designed as the low-gain part with  $v_M^v$  in its adaption law which is adjusted based on the saturation level. In contrast, the second term is the

high-gain part that mitigates the impact of multiplicative faults.

**Theorem 1.** *Let Assumption 1 and 2 holds. Employing the proposed adaption law (14), there exists  $\gamma > 0$  such that the consensus problem of finite-time semi-global voltage regulation of each DG in the MG considering input saturation under partial loss of effectiveness faults can be solved by (13). In addition, the steady-state error will be limited to the following residual set:*

$$\left\{ \bar{y} \mid \|\bar{y}\| \leq \sqrt{\frac{\varrho^v}{\lambda_1 \lambda_{\min}(P(\gamma))(1-\xi)}} \right\} \quad (15)$$

where  $0 < \xi < 1$ ,  $\varrho^v = \sum_{i=1}^N \sum_{j=1}^2 \kappa_i \sigma_{ij}^v \alpha_{ij}^v + 2 \sum_{i=1}^N \kappa_i \Upsilon(t)$  and  $\lambda_1$  is the minimum eigenvalue of  $\beta$ . The settling time is restricted by:

$$t_s \leq \frac{1}{\varepsilon(\gamma)\xi} \ln \frac{(1-\xi)V(\bar{y}(0))}{\varrho} \quad (16)$$

*Proof.*  $V(\bar{y})$  is the Lyapunov candidate which is selected for the system (5) as follows:

$$V(\bar{y}) = \bar{y}^T (\beta \otimes P(\gamma)) \bar{y} \quad (17)$$

where  $P(\gamma)$  is the parametric matrix and the unique solution of the following Riccati equation for any  $\gamma > 0$ :

$$A^T P(\gamma) + P(\gamma)A - P(\gamma)BB^T P(\gamma) + Q(\gamma) = 0 \quad (18)$$

According to (12) and (7), the dynamics of the global tracking error with input saturation are described as follows:

$$\dot{y}(t) = (I \otimes A)y(t) + (I \otimes B)\theta(t) \text{sat}(v^v(t)) + (I \otimes B)\delta_i^v(t) \quad (19)$$

$\text{sat}(v_i^v(t)) = [\text{sat}(v_{i1}^v(t)), \dots, v_{i2}^v(t)]$ . By differentiating of  $V(\bar{y})$ , we have:

$$\dot{V}(\bar{y}) = 2\bar{y}^T (\beta \otimes P(\gamma)) \dot{\bar{y}} \quad (20)$$

By applying (12) into (20), we can obtain that

$$\begin{aligned} \dot{V}(\bar{y}) &= 2\bar{y}^T (\beta \otimes P(\gamma)A) \dot{\bar{y}} + 2\bar{y}^T (\beta \otimes P(\gamma)B) \\ &\quad \times \theta \text{sat}(v^v) + 2\bar{y}^T (\beta \otimes P(\gamma)B) \delta \\ &= V_1 + V_2 \end{aligned} \quad (21)$$

where we define  $V_1$  and  $V_2$  as follows:

$$\begin{aligned} V_1 &= 2\bar{y}^T (\beta \otimes P(\gamma)A) \bar{y} - 2 \sum_{i=1}^N \alpha_{i1}^v q_i^v{}^T(\gamma, t) \theta_i q_i^v(\gamma, t) \\ &\quad - 2 \sum_{i=1}^N \frac{\bar{\delta}_i}{\kappa_i} \frac{q_i^v{}^T(\gamma, t) \theta_i q_i^v(\gamma, t)}{\|q_i^v(\gamma, t)\|} + 2\bar{y}^T (\beta \otimes P(\gamma)B) \delta \end{aligned} \quad (22)$$

$$\begin{aligned} V_2 &= 2\bar{y}^T (\beta \otimes P(\gamma)B) \text{sat}(v^v) + 2 \sum_{i=1}^N \alpha_{i1}^v q_i^v{}^T(\gamma, t) \theta_i \\ &\quad \times q_i^v(\gamma, t) + 2 \sum_{i=1}^N \frac{\bar{\delta}_i}{\kappa_i} \frac{q_i^v{}^T(\gamma, t) \theta_i q_i^v(\gamma, t)}{\|q_i^v(\gamma, t)\|} \end{aligned} \quad (23)$$

By considering the above-mentioned definitions, we can obtain:

$$\begin{aligned} V_1 &\leq 2\bar{y}^T (\beta \otimes P(\gamma)A) \bar{y} - 2 \sum_{i=1}^N \kappa_i \alpha_{i1}^v q_i^v{}^T(\gamma, t) \theta_i q_i^v(\gamma, t) \\ &\quad - 2 \sum_{i=1}^N \frac{\bar{\delta}_i}{\kappa_i} \|q_i^v(\gamma, t)\| + 2 \sum_{i=1}^N q_i^v{}^T(\gamma, t) \delta_i \end{aligned} \quad (24)$$

Note that  $2\kappa_i \alpha_{i1}^v \geq (1/\lambda_1)$ ,  $i \in \mathcal{V}$ , where  $\lambda_1$  is the minimum eigenvalue of  $\beta$  and  $\bar{\delta}_i$  is the bound of  $\|\delta_i(t)\|$  which satisfies  $\|\delta_i(t)\| \leq \bar{\delta}_i$ . Substituting (14) into (24), we can get that:

$$\begin{aligned} V_1 &\leq \bar{y}^T (\beta \otimes P(\gamma)A + \beta \otimes A^T P(\gamma) - \frac{1}{\lambda_1} \beta^2 \otimes P(\gamma) \\ &\quad \times BB^T P(\gamma)) \bar{y} \end{aligned} \quad (25)$$

Based on Assumption 1, there will be an orthogonal matrix  $\psi$  such that  $\psi^T \beta \psi = F$  with  $F = \text{diag}\{\lambda_1, \dots, \lambda_N\}$ ,  $0 < \lambda_1 \leq \lambda_2 \leq \dots \leq \lambda_N$ . If we define  $\tilde{y} = (\psi^T \otimes I) \bar{y}$ , then we have:

$$\begin{aligned} V_1 &\leq \tilde{y}^T (F \otimes P(\gamma)A + F \otimes A^T P(\gamma) - \frac{1}{\lambda_1} F^2 \otimes P(\gamma) \\ &\quad \times BB^T P(\gamma)) \tilde{y} \leq \tilde{y}^T (F \otimes Q(\gamma)) \tilde{y} \end{aligned} \quad (26)$$

and then, we obtain:

$$V_1 \leq -\frac{\lambda_{\min}(Q(\gamma))}{\lambda_{\max}(P(\gamma))} \tilde{y}^T (\beta \otimes P(\gamma)) \tilde{y} = -\varepsilon(\gamma) V_1 \quad (27)$$

Now, we try to take a similar step for another Lyapunov function  $V_2$ . Considering (7), one can write:

$$\begin{aligned} V_2 &= 2 \sum_{i=1}^N q_i^v{}^T(\gamma, t) \theta_i [\text{sat}(v_i^v) + \alpha_{i1}^v q_i^v{}^T(\gamma, t) + \frac{\bar{\delta}_i}{\kappa_i} \\ &\quad \times \frac{q_i^v(\gamma, t)}{\|q_i^v(\gamma, t)\|}] \end{aligned} \quad (28)$$

Let define  $\zeta = -2q_{ij}^v{}^T(\gamma) \theta_i [\text{sat}(v_i^v) + \alpha_{i1}^v q_i^v{}^T(\gamma) + \frac{\bar{\delta}_i}{\kappa_i} \frac{q_i^v(\gamma, t)}{\|q_i^v(\gamma, t)\|}]$  and  $r_i^v(\gamma, t) = (\bar{\delta}_i / \kappa_i) (\frac{q_i^v(\gamma, t)}{\|q_i^v(\gamma, t)\|})$ . It should be mentioned that  $q_{ij}^v(\gamma, t)$  and  $r_i^v(\gamma, t)$  stand for the  $j$ -th components of  $q_i^v(\gamma, t)$  and  $r_i^v(\gamma, t)$ , respectively. As  $\theta_i$  has a diagonal form,  $\zeta_i(\gamma, t)$  can be written as follows:

$$\begin{aligned} \zeta_i(\gamma, t) &= \sum_{i=1}^N -2q_i^v{}^T(\gamma, t) \theta_i [-\text{sat}(v_i^v) - \alpha_{i1}^v q_i^v{}^T(\gamma, t) \\ &\quad - r_{ij}^v(\gamma, t)] = \sum_{j=1}^n \chi_{ij}(\gamma) \end{aligned} \quad (29)$$

By substituting (13) into (29), it yields that:

$$\begin{aligned} \chi_{ij}(\gamma) &= -2q_{ij}^v(\gamma, t) \theta_{ij} [\text{sat}(-\alpha_{i1}^v q_{ij}^v(\gamma, t) - b_{ij}(\gamma)) \\ &\quad - \alpha_{i1}^v q_{ij}^v(\gamma, t) - r_{ij}^v(\gamma, t)] \end{aligned} \quad (30)$$

Considering Assumption 2, we have  $|\alpha_{i1}^v q_{ij}^v(\gamma, t)| \leq s_t$  and  $|r_{ij}^v(\gamma, t)| \leq v_M^v - s_t$ . If  $|b_{ij}(\gamma)| \geq |r_{ij}^v(\gamma, t)|$ , then  $\zeta_{ij}(\gamma) \leq 0$ , otherwise by using (13), one can get:

$$\chi_{ij}(\gamma) \leq 2 \theta_{ij}^v \left[ \frac{\alpha_{i2}^{v2}(t) q_{ij}^v(\gamma, t)}{\alpha_{i2}^v(t) \|q_{ij}^v(\gamma, t)\| + \varepsilon(\gamma) \Upsilon(0)} + \frac{\bar{\delta}_i}{\kappa_i} \frac{q_i^v(\gamma, t)}{\|q_i^v(\gamma, t)\|} \right] \leq 2\bar{\theta}_{ij}^v \varepsilon(\gamma) \Upsilon(0) \quad (31)$$

where we considered the fact that  $\frac{\bar{\delta}_i}{\kappa_i} \leq v_M^v$ . Hence, one can reach:

$$V_2 \leq \sum_{i=1}^N \sum_{j=1}^n \chi_{ij}(\gamma) \leq \sum_{i=1}^N \sum_{j=1}^n 2\bar{\theta}_{ij}^v \varepsilon(\gamma) \Upsilon(0) \quad (32)$$

Combining (27) and (32), we obtain that:

$$\dot{V}(\bar{y}) \leq \varepsilon(\gamma) V(\bar{y}) + \sum_{i=1}^N \sum_{j=1}^n 2\bar{\theta}_{ij}^v \varepsilon(\gamma) \Upsilon(0) \quad (33)$$

Therefore, based on Lemma 1, the proof is completed.

#### IV. DESIGN OF FINITE-TIME FAULT-TOLERANT CONTROL SCHEME FOR FREQUENCY REGULATION

In this part, a distributed finite-time frequency and active power sharing algorithms are put forward to reach frequency restoration such that  $\omega \rightarrow \omega_{ref}$ , concerning the occurrence of faults and input saturation similar to the previous section. Moreover, the proposed algorithm should be able to realize active power-sharing. Based on the droop characteristic in (1), the frequency synchronization problem can be dealt with as a tracking problem of first-order multi-agent systems. To achieve frequency restoration and active power sharing simultaneously, two separate controllers are considered such that  $m_1^p P_1 = m_2^p P_2 = \dots = m_N^p P_N$ . According to (1), one can write:

$$\begin{cases} \dot{\omega}_i = u_i^\omega \\ m_i^p \dot{P}_i = u_i^p \end{cases} \quad (34)$$

Here, it is needed to design a secondary frequency controller by using the differential equation in (34) to reach the frequency regulation and active power-sharing. In this regard, considering the mentioned constraints in control input, the following control schemes are defined:

$$\begin{cases} \dot{\omega}_i = \tilde{u}_i^\omega = \theta_i^\omega(t) \text{sat}(u_i^\omega(t)) + \varphi_i^\omega(t) u_i^{\omega s}(t) + d_i^\omega \\ m_i^p \dot{P}_i = \tilde{u}_i^p = \theta_i^p(t) \text{sat}(u_i^p(t)) + \varphi_i^p(t) u_i^{ps}(t) + d_i^p \end{cases} \quad (35)$$

Considering the given dynamics, we can allocate two finite-time control schemes to guarantee frequency synchronization and proportional active power-sharing under faults and saturation. Next, to achieve the control purposes, the following controllers are presented:

$$\begin{cases} u_i^\omega(t) = -\alpha_{i1}^\omega(t) q_i^\omega(t) - b_{ij}^\omega(\gamma, t) \\ b_{ij}^\omega(\gamma, t) = \frac{\alpha_{i2}^{\omega 2}(t) q_{ij}^\omega(\gamma, t)}{\alpha_{i2}^\omega(t) \|q_{ij}^\omega(\gamma, t)\| + \varepsilon^\omega(\gamma) \Upsilon(t)} \end{cases} \quad (36)$$

$$\begin{cases} u_i^p(t) = -\alpha_{i1}^p(t) q_i^p(t) - b_{ij}^p(\gamma, t) \\ b_{ij}^p(\gamma, t) = \frac{\alpha_{i2}^{p 2}(t) q_{ij}^p(\gamma, t)}{\alpha_{i2}^p(t) \|q_{ij}^p(\gamma, t)\| + \varepsilon^p(\gamma) \Upsilon(t)} \end{cases} \quad (37)$$

where  $q_i^\omega = B^T P(\gamma) e_i^\omega(t)$ ,  $q_i^p = B^T P(\gamma) e_i^p(t)$ . The weighted tracking errors between frequency and active power sharing of  $i$ -th and  $j$ -th DGs in (36) and (37) are  $e_i^\omega(t) = \sum_{j=1}^N a_{ij}(\omega_i(t) - \omega_j(t)) + a_{i0}(\omega_i(t) - \omega^{ref})$  and  $e_i^p(t) = \sum_{j=1}^N a_{ij}(m_i^p P_i(t) - m_j^p P_j(t))$ , respectively. The adaptation law of the mentioned adaptive gains are given as follows:

$$\begin{cases} \dot{\alpha}_{i1}^\omega = u_M^\omega (-\sigma_{i1}^\omega \alpha_{i1}^\omega(t) + \|q_i^\omega(t)\|^2) \\ \dot{\alpha}_{i2}^\omega = u_M^\omega (-\sigma_{i2}^\omega \alpha_{i2}^\omega(t) + \|q_i^\omega(t)\|) \end{cases} \quad (38)$$

$$\begin{cases} \dot{\alpha}_{i1}^p = u_M^p (-\sigma_{i1}^p \alpha_{i1}^p(t) + \|q_i^p(t)\|^2) \\ \dot{\alpha}_{i2}^p = u_M^p (-\sigma_{i2}^p \alpha_{i2}^p(t) + \|q_i^p(t)\|) \end{cases} \quad (39)$$

Therefore, according to the above protocols, the distributed secondary control scheme for the frequency synchronization and active power-sharing is proposed as:

$$\omega_i^n = \int (\tilde{u}_i^\omega + \tilde{u}_i^p) d\tau \quad (40)$$

**Theorem 2.** *If Assumptions 1 and 2 hold, then by using the proposed control schemes (36) and (37), the synchronization of frequency and active power sharing for MGs by considering input saturation and multiplicative faults can be obtained.*

*Proof.* With some mild modifications and taking some steps similar to the previous theorem, this theorem can be proved.

**Remark 2.** The steady-state tracking error of the proposed frequency and active power-sharing schemes and the limitation of settling time can be obtained in the same fashion as Theorem 1.

#### V. CASE STUDY

In this section, the performance of the proposed method is verified through several simulation results of an off-grid multi-DGs MG shown in Fig. 2, conducted in MATLAB/Simulink software environment, which can demonstrate the effectiveness of the proposed methods under external disturbance, faults, and input saturation. The single line diagram of the MG is based on the parameters presented in Table I. The bus lines are represented by series resistance and inductance (RL) branches. The DGs can communicate through the undirected communication network as shown in Fig. 3, and only DG #1 can access the reference signal values. The simulations are performed under a couple of scenarios, which can verify the accuracy and effectiveness of the proposed scheme in encountering small- and large-signal disturbances such as load change and PnP functionality of DERs. Here, we just focus on the secondary voltage and frequency control. To make our protocols suitable for implementation on real-time simulators and controllers, the switching frequency of converters is selected as  $f_{sw} = 8kHz$ . In this regard, the sampling time of the control algorithms is selected to be  $T_s = 0.00002s$ . Also, a time-delay is applied to the generated PWM signals, before being imposed to the converters. Moreover, we compare our results with some previously reported works. It is worth



note that due to the impedance effect of transmission lines, both accurate reactive power sharing and voltage regulation cannot be achieved simultaneously, except under a symmetric configuration [7]. Nevertheless, it can be seen that our proposed controller scheme does not deteriorate the reactive power-sharing before applying the secondary control. It should be mentioned that the proposed control algorithm does not solve the Riccati equation during the operation of the control system (online), which means that it is required to solve that once before applying the secondary control algorithm.

TABLE I: The MG Parameters

Descriptions	DG#1&#2&#3	DG#4&#5
$m^P$	$12.5 \times 10^{-5}$	$9.4 \times 10^{-5}$
$n^Q$	$1.5 \times 10^{-3}$	$1.3 \times 10^{-3}$
$K_{PV}$	0.05	0.1
$K_{IV}$	390	420
$K_{PC}$	10.5	15
$K_{IC}$	16000	20000
LC Filters	$R_f = 0.3 \Omega, L_f = 1.5 \text{ mH}, C_f = 47 \mu\text{F}$	
Output connectors	$R_c = 0.05 \Omega, L_c = 0.35 \text{ mH}$	
Lines	Lines 2&3&4	Lines 1&5
	$0.12 + 0.1 \Omega$	$0.175 + 0.58 \Omega$

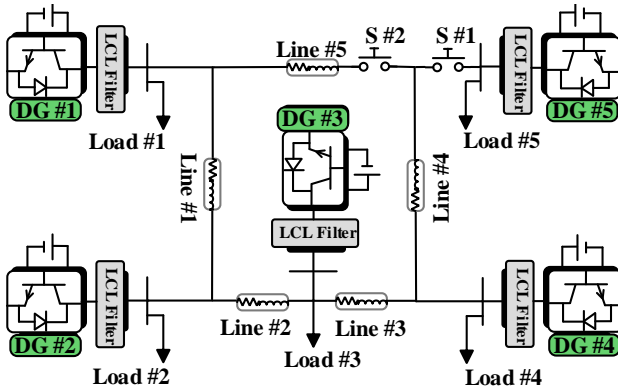

Fig. 2: Single line diagram of the test off-grid MG.

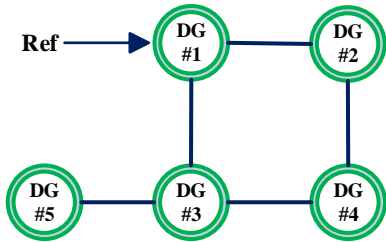
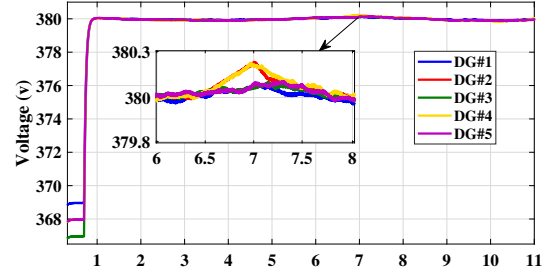

Fig. 3: Communication topology network among DGs.

#### A. Performance evaluation and numerical results

Here, the performance of the finite-time algorithm in synchronization of voltage, frequency, active power-sharing in the presence of faults, and saturation is assessed. The performance of the closed-loop system is evaluated with the assumption that the communication links are ideal and there exist no failures for them. According to the Riccati



(a)

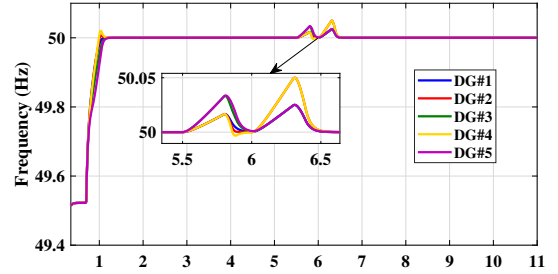

(b)

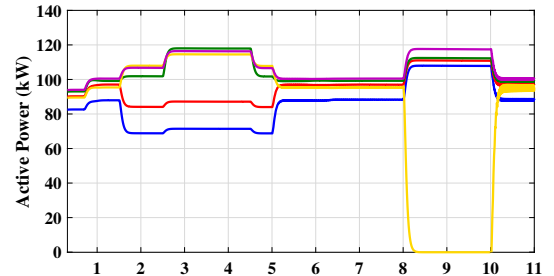

(c)

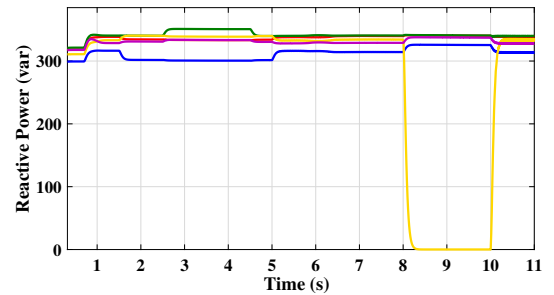

(d)

Fig. 4: Performance of the proposed scheme for DGs: (a) Voltage, (b) Frequency, (c) Active power, and (d) Reactive powers.

equation (18),  $Q(\gamma)$  must be a symmetric positive-definite matrix. Based on that, to have a feasible solution and an acceptable performance, we select the design matrices and parameters as  $Q(\gamma) = \begin{bmatrix} 1 & 0 \\ 0 & 1 \end{bmatrix}$  for the voltage controller,  $Q(\gamma) = 0.81$  for the frequency and active power controllers,  $\Upsilon^v(t) = 0.05 e^{-2t}$ ,  $\Upsilon^\omega(t) = 0.2 e^{-3t}$ ,  $\sigma_{i1}^v = 0.5$ ,  $\sigma_{i2}^v = 0.2$ ,  $\sigma_{i1}^\omega = \sigma_{i1}^p = 0.02$ ,  $\sigma_{i2}^\omega = \sigma_{i2}^p = 0.04$ ,  $v_M^v = 30$  and  $v_M^\omega = 12$ . Also, the fault parameters for voltage, frequency

and active power control inputs are considered as  $\theta_i^v = 0.6 + (0.5 + (0.7 - 0.5) \times \text{rand}(1)) \times \sin(3t)$  and  $\theta_i^{\omega,p} = 0.5 + (0.4 + (0.9 - 0.4) \times \text{rand}(1)) \times \sin(4t)$ . The second terms of faults range from 50-70% and 40-90%, respectively. The external disturbances are assumed to be  $d_i^v = \cos(0.5t)$  and  $d_i^p = d_i^\omega = \cos(t)$ . The simulations scenarios are carried out as:

- 1) At  $t = 0\text{s}$ , the MG (Fig. 2) operates in the islanded mode;
- 2) At  $t = 0.7\text{s}$ , the proposed secondary control scheme is activated;
- 3) At  $t = 1.5\text{s}$ , S #2 is closed;
- 4) At  $t = 5.5\text{-}6\text{s}$ , the DG #1 and DG #5 are under a stuck faults, which means that their control input only sends a constant as control command signals;
- 5) At  $t = 2.5\text{s}$ , load #3 is increased (200%) and then decreased to the initial value at  $t = 4.5\text{s}$ ;
- 6) At  $t = 5\text{s}$ , the S #2 is opened;
- 7) At  $t = 6.2\text{-}6.5\text{s}$  and  $t = 6.5\text{-}7\text{s}$ , the DG #2 and DG #4 are under a stuck fault for frequency and voltage controller, respectively;
- 8) At  $t = 8\text{s}$ , for PnP scenario, S #1 is opened, and DG #5 is plugged out and then plugged in at  $t = 10\text{s}$  by closing S #1, respectively;

First, the primary controller is only activated, and all DGs have to supply the loads. The operation of this layer makes some deviations in the voltage and frequency from the nominal values. Therefore, the proposed finite-time fault-tolerant controllers in (13), (36) and (37) are applied at  $t = 0.7\text{s}$  to restore the voltage and frequency of each DG to their reference values in the presence of saturation and faults. As can be observed from Fig. 4, by enforcing the secondary control layer, the deviations are restored to their prescribed values, and accurate active power-sharing is also provided. Then, to investigate the performance of the proposed control schemes against load changes, the switch S #1 is closed at  $t = 1.5\text{s}$  to change the MG topology. Also, in two periods, we consider the situations in which the controllers of DG #2 and DG #3 cannot generate proper command signals. However, the designed controllers show an acceptable performance even though some deviations from the voltage and frequency reference values. Even after occurring the faults, the proposed controllers can maintain the stability of the closed-loop system, with minimal fluctuations. Afterward, the load change scenario is examined by increasing load #3 (200%) at  $t = 2.5\text{s}$ , and then, the load change scenario gets over by decreasing load #3 to its initial value. At  $t = 5\text{s}$ , the S #1 is opened to transfer the MG topology to its initial one. At the end of the simulation, to show the robust performance of the proposed control scheme under PnP functionality, DG #5 is disconnected from the MG and then reconnected at  $t = 8\text{s}$  and  $t = 10\text{s}$ , respectively. At this stage, we can see some oscillations in the active and reactive power of DG #5 during the PnP scenario while the other DGs increase their output powers to compensate for the power shortage caused by the outage DER units. All scenarios have happened in the presence of saturation and faults. One can see that by employing the proposed control schemes, the closed-loop system responds well to different small- and large-signal

disturbances and the voltage and frequency of units are kept to their prescribed values regardless of the input constraints.

### B. Changing fault parameters

In this part of the evaluation, the performance of the MG with the proposed controllers is illustrated for different values of faults. The fault parameters on voltage, frequency and active power controllers are considered as  $\theta_i^v = 0.8 + 4 \times \sin(8t)$  and  $\theta_i^{\omega,p} = 1 + 5 \times \sin(10t)$ . The simulation scenarios are the same as the previous subsection. The results in Fig. 5 show that although changes in fault parameters affect the response of voltage and frequency in some moments and cause diversions from the nominal values, the MG remains stable despite severe faulty conditions.

### C. Changing type of fault

To make the evaluation of our suggested controllers more comprehensive, the fault signals are considered as a function of states. Therefore, the fault signals are chosen as:  $\theta_i^v = 0.1 + 0.2 \times \sin(2v_i)$  and  $\theta_i^{\omega,p} = 0.2 + 0.2 \times \sin(3\omega_i)$ . The results shown in Fig. 6 demonstrate that the performance of the proposed control schemes has enough robustness against the state-dependent faults and, the controllers do not need information about the type of the occurred faults.

### D. Comparison with previous studies

To verify the effectiveness of the proposed control algorithm for the regulation problem of the DGs under multiplicative faults and saturation, we compare our results with some previously reported distributed secondary control methods. The selected fault parameters are similar to Subsection V-A. Simulation results presented in Fig. 7 show the voltage, frequency, and active power signals of DG #2 for each method. The following cases have been selected for the comparison:

- Firstly, the conventional algorithm proposed in [14] is considered, which employs the standard linear consensus cooperative protocol for the voltage and frequency regulation according to the error signals and an ideal communication network.
- The next algorithm is based on distributed sliding mode algorithm in [11], which guarantees synchronization of the voltage and frequency at the secondary layer in the presence of uncertainties. By using the input dynamic extension technique, the chattering is reduced.
- The next scheme is the cooperative fault-tolerant control introduced in [19], which considered multiplicative and bias faults. The design procedure consists of distributed observer and an adaptive fault-tolerant algorithm to regulate the voltage and frequency in MGs.
- The last method is based on a distributed robust finite-time control algorithm presented in [33]. This algorithm is reached from a super-twisting sliding-mode control approach. The proposed protocols in this study are synthesized by considering the unmodelled dynamics and unknown disturbances.

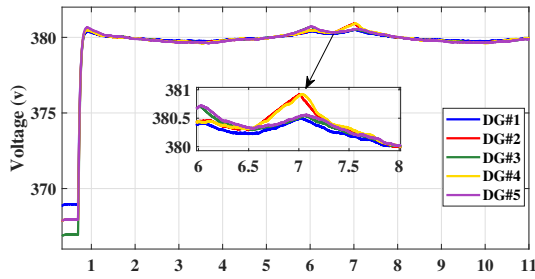

(a)

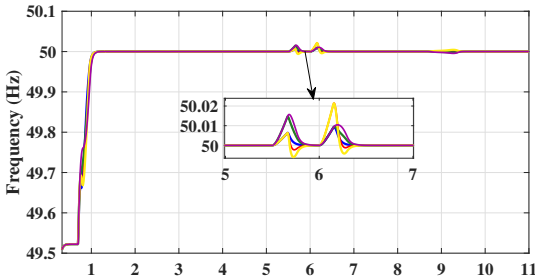

(b)

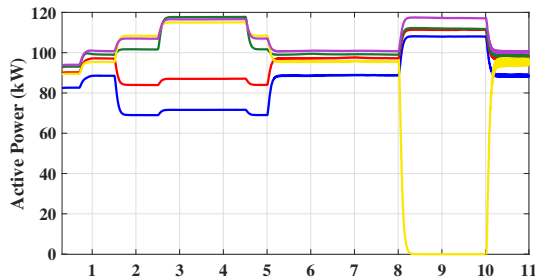

(c)

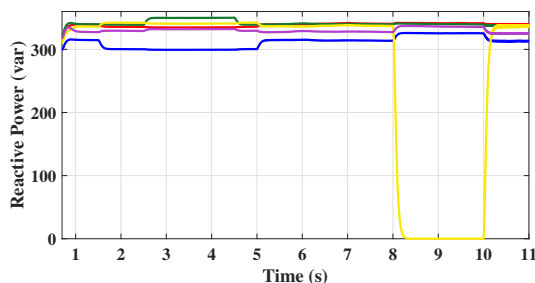

(d)

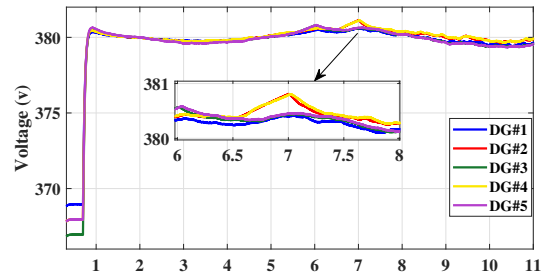

(a)

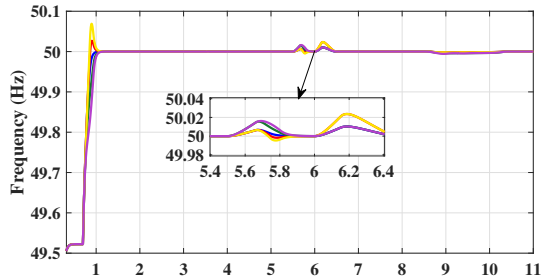

(b)

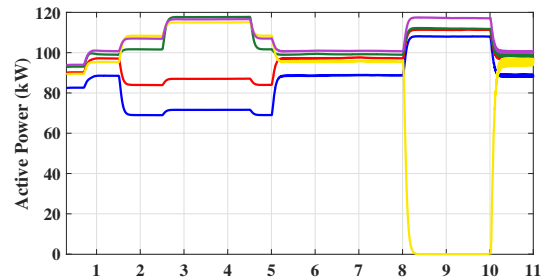

(c)

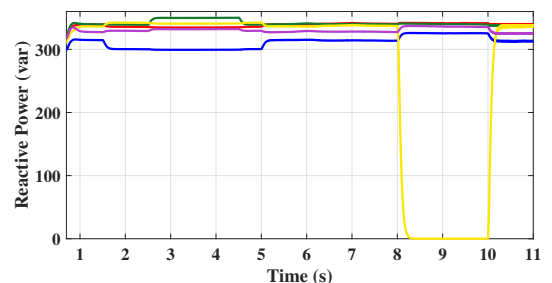

(d)

Fig. 5: Performance of the proposed scheme for DGs: (a) Voltage, (b) Frequency, (c) Active power, and (d) Reactive powers.

Fig. 6: Performance of the proposed scheme for DGs: (a) Voltage, (b) Frequency, (c) Active power, and (d) Reactive powers.

In the beginning, the performance of the MG based on the mentioned previous reported methods and our proposed algorithm is discussed in faulty condition with input saturation. As shown in Fig. 7, the simulation results demonstrate that the conventional method in [14] does not have good performance in comparison with the other selected algorithms, and it can be unstable under severe faults. Also, convergence is not achieved due to a limitation on the control signals. It can also be clearly understood that the response of sliding mode

control algorithms of [11] is not proper and, there are some oscillations as the consequence of faults. Unlike conventional distributed controllers, this method quickly reaches consensus and exhibits a more accurate robust performance as it uses a sliding mode controller. The fault-tolerant method presented in [19] illustrates a relatively desirable performance against actuator faults. Still, due to the existence of saturation, it is not able to provide a desired transient performance. In general, all mentioned previously published methods cannot

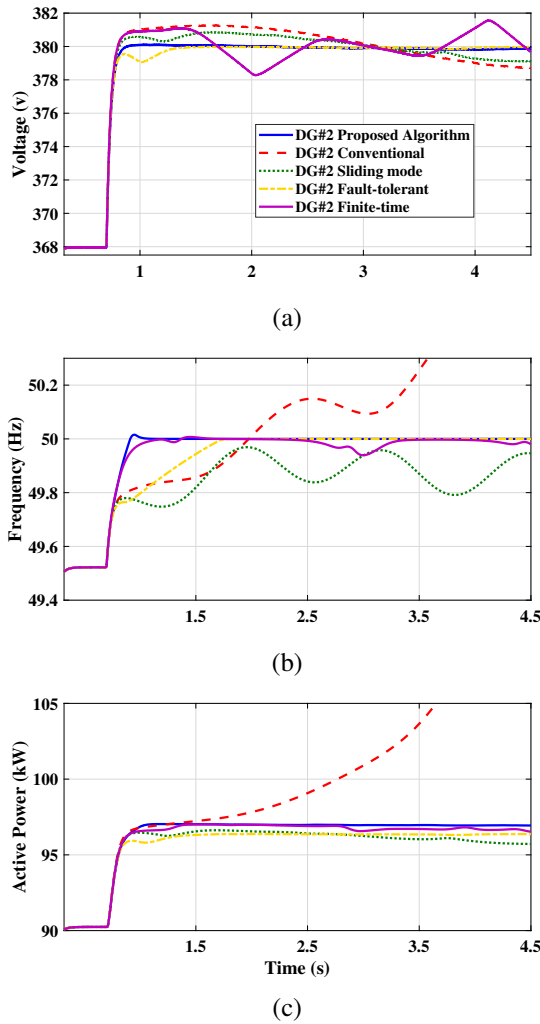

Fig. 7: Comparison of the proposed scheme with previously reported studies in [14], [11], [19] and, [33]. (a) Voltage, (b) Frequency and (c) Active power of DG #2.

display an acceptable and robust performance against faults and saturation. As a result, there are some oscillations in the voltage and frequency responses using the previously proposed control schemes. Furthermore, the secondary controller does not react well when the MG faces input constraints, and as can be seen, the outputs of voltage and frequency take a fairly long time to rise. Also, the selected methods' control efforts (Euclidean norm) of the voltage and frequency controllers are compared as shown in Fig. 8. Note that these signals illustrate the total energy related to each controller output. As can be seen, the control efforts of other methods are relatively more than the proposed algorithm. Note that by using the proposed distributed control scheme, the convergence speed and fault-tolerance of the voltage and frequency are desirable. Moreover, it shows a better performance in terms of voltage regulation and frequency synchronization in the presence of time-varying multiplicative faults and saturation.

## VI. CONCLUSION

In this work, a novel finite-time fault-tolerant secondary control is proposed for voltage and frequency restoration

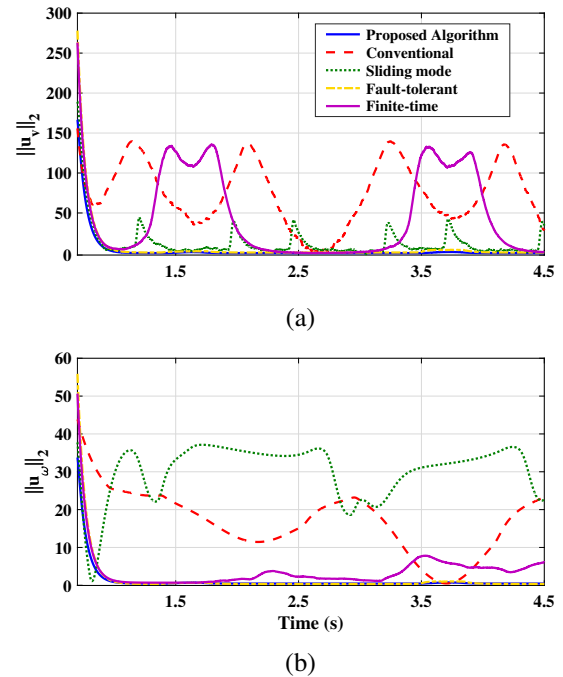

Fig. 8: Comparison of the control efforts of the proposed method with previously reported studies in [14], [11], [19] and, [33]: (a) Voltage and (b) Frequency.

considering actuator faults in the presence of input saturation. In this regard, an adaptive fault-tolerant controller is devised for each DG to guarantee the semi-global stabilization of the voltage and frequency of isolated AC MGs. It is proven that finite-time stability could be achieved, and both the steady-state consensus error and the settling time are well formulated. Eventually, MATLAB/Simulink simulations verifies the validity of the proposed fault-tolerant control method. In addition, compared to the previously effective methods, both the theoretical and simulation outcomes reveal that the presented control scheme has better and desirable performance under input limits, including partial loss of effectiveness and constraints in actuators such as saturation. Our future study investigates the effect of attacks in communication networks of MGs in the secondary control layer in the presence of faults and input constraints.

## REFERENCES

- [1] M. A. Shahab, B. Mozafari, S. Soleymani, N. M. Dehkordi, H. M. Shourkaei, and J. M. Guerrero, "Distributed consensus-based fault tolerant control of islanded microgrids," *IEEE Transactions on Smart Grid*, vol. 11, no. 1, pp. 37–47, 2019.
- [2] X. Li, Q. Xu, and F. Blaabjerg, "Adaptive resilient secondary control for islanded AC microgrids with sensor faults," *IEEE Journal of Emerging and Selected Topics in Power Electronics*, vol. 9, no. 5, pp. 5239–5248, 2020.
- [3] R. Heydari, T. Dragicevic, and F. Blaabjerg, "High-bandwidth secondary voltage and frequency control of VSC-based AC microgrid," *IEEE Transactions on Power Electronics*, vol. 34, no. 11, pp. 11 320–11 331, 2019.
- [4] M. Yazdani and A. Mehrizi-Sani, "Distributed control techniques in microgrids," *IEEE Transactions on Smart Grid*, vol. 5, no. 6, pp. 2901–2909, 2014.

- [5] P. Ge, Y. Zhu, T. Green, and F. Teng, "Resilient secondary voltage control of islanded microgrids: An eskbf-based distributed fast terminal sliding mode control approach," *IEEE Transactions on Power Systems*, 2020.
- [6] J. Lai, H. Zhou, X. Lu, X. Yu, and W. Hu, "Droop-based distributed cooperative control for microgrids with time-varying delays," *IEEE Transactions on Smart Grid*, vol. 7, no. 4, pp. 1775–1789, 2016.
- [7] M. Raeispour, H. Atrianfar, H. R. Baghaee, and G. B. Gharehpetian, "Distributed lmi-based control of heterogeneous microgrids considering fixed time-delays and switching topologies," *IET Renewable Power Generation*, vol. 14, no. 12, pp. 2068–2078, 2020.
- [8] S. Abhinav, I. D. Schizas, F. L. Lewis, and A. Davoudi, "Distributed noise-resilient networked synchrony of active distribution systems," *IEEE Transactions on Smart Grid*, vol. 9, no. 2, pp. 836–846, 2016.
- [9] M. R. Khalghani, J. Solanki, S. K. Solanki, M. H. Khooban, and A. Sargolzaei, "Resilient frequency control design for microgrids under false data injection," *IEEE Transactions on Industrial Electronics*, vol. 68, no. 3, pp. 2151–2162, 2020.
- [10] A. Afshari, M. Karrari, H. R. Baghaee, and G. B. Gharehpetian, "Resilient cooperative control of AC microgrids considering relative state-dependent noises and communication time-delays," *IET Renewable Power Generation*, vol. 14, no. 8, pp. 1321–1331, 2020.
- [11] A. Pilloni, A. Pisano, and E. Usai, "Robust finite-time frequency and voltage restoration of inverter-based microgrids via sliding-mode cooperative control," *IEEE Transactions on Industrial Electronics*, vol. 65, no. 1, pp. 907–917, 2017.
- [12] Y. Xu and H. Sun, "Distributed finite-time convergence control of an islanded low-voltage AC microgrid," *IEEE Transactions on Power Systems*, vol. 33, no. 3, pp. 2339–2348, 2017.
- [13] S. Deng, L. Chen, X. Lu, T. Zheng, and S. Mei, "Distributed finite-time secondary frequency control of islanded microgrids with enhanced operational flexibility," *IEEE Transactions on Energy Conversion*, 2021.
- [14] A. Bidram, A. Davoudi, F. L. Lewis, and Z. Qu, "Secondary control of microgrids based on distributed cooperative control of multi-agent systems," *IET Generation, Transmission & Distribution*, vol. 7, no. 8, pp. 822–831, 2013.
- [15] Q. Shafiee, V. Nasirian, J. C. Vasquez, J. M. Guerrero, and A. Davoudi, "A multi-functional fully distributed control framework for AC microgrids," *IEEE Transactions on Smart Grid*, vol. 9, no. 4, pp. 3247–3258, 2016.
- [16] N. M. Dehkordi, N. Sadati, and M. Hamzeh, "Fully distributed cooperative secondary frequency and voltage control of islanded microgrids," *IEEE Transactions on Energy Conversion*, vol. 32, no. 2, pp. 675–685, 2016.
- [17] A. Afshari, M. Karrari, H. R. Baghaee, G. B. Gharehpetian, and J. M. Guerrero, "Robust cooperative control of isolated AC microgrids subject to unreliable communications: A low-gain feedback approach," *IEEE Systems Journal*, pp. 1–12, 2021.
- [18] A. Bidram, A. Davoudi, F. L. Lewis, and J. M. Guerrero, "Distributed cooperative secondary control of microgrids using feedback linearization," *IEEE Transactions on Power Systems*, vol. 28, no. 3, pp. 3462–3470, 2013.
- [19] A. Afshari, M. Karrari, H. R. Baghaee, G. Gharehpetian, and S. Karrari, "Cooperative fault-tolerant control of microgrids under switching communication topology," *IEEE Transactions on Smart Grid*, vol. 11, no. 3, pp. 1866–1879, 2019.
- [20] A. Afshari, M. Karrari, H. R. Baghaee, and G. B. Gharehpetian, "Distributed fault-tolerant voltage/frequency synchronization in autonomous AC microgrids," *IEEE Transactions on Power Systems*, vol. 35, no. 5, pp. 3774–3789, 2020.
- [21] R. Isermann, *An introduction from fault detection to fault tolerance*. Springer, 2006.
- [22] S. Yang, A. Bryant, P. Mawby, D. Xiang, L. Ran, and P. Tavner, "An industry-based survey of reliability in power electronic converters," *IEEE Transactions on Industry Applications*, vol. 47, no. 3, pp. 1441–1451, 2011.
- [23] B. Mirafzal, "Survey of fault-tolerance techniques for three-phase voltage source inverters," *IEEE Transactions on Industrial Electronics*, vol. 61, no. 10, pp. 5192–5202, 2014.
- [24] B. Wang, W. Chen, and B. Zhang, "Semi-global robust tracking consensus for multi-agent uncertain systems with input saturation via metamorphic low-gain feedback," *Automatica*, vol. 103, pp. 363–373, 2019.
- [25] T. Hu, "A nonlinear-system approach to analysis and design of power-electronic converters with saturation and bilinear terms," *IEEE Transactions on Power Electronics*, vol. 26, no. 2, pp. 399–410, 2010.
- [26] R. Ottersten and J. Svensson, "Vector current controlled voltage source converter-deadbeat control and saturation strategies," *IEEE Transactions on Power Electronics*, vol. 17, no. 2, pp. 279–285, 2002.
- [27] Y. Yin, F. Wang, Z. Liu, and Z. Chen, "Finite-time leader-following consensus of multiagent systems with actuator faults and input saturation," *IEEE Transactions on Systems, Man, and Cybernetics: Systems*, 2021.
- [28] G. Chen, F. L. Lewis, and L. Xie, "Finite-time distributed consensus via binary control protocols," *Automatica*, vol. 47, no. 9, pp. 1962–1968, 2011.
- [29] Z.-H. Guan, F.-L. Sun, Y.-W. Wang, and T. Li, "Finite-time consensus for leader-following second-order multi-agent networks," *IEEE Transactions on Circuits and Systems I: Regular Papers*, vol. 59, no. 11, pp. 2646–2654, 2012.
- [30] S. Yu and X. Long, "Finite-time consensus for second-order multi-agent systems with disturbances by integral sliding mode," *Automatica*, vol. 54, pp. 158–165, 2015.
- [31] J. Zhou and Q. Wang, "Convergence speed in distributed consensus over dynamically switching random networks," *Automatica*, vol. 45, no. 6, pp. 1455–1461, 2009.
- [32] D. Meng and Y. Jia, "Finite-time consensus for multi-agent systems via terminal feedback iterative learning," *IET Control Theory & Applications*, vol. 5, no. 18, pp. 2098–2110, 2011.
- [33] N. M. Dehkordi, N. Sadati, and M. Hamzeh, "Distributed robust finite-time secondary voltage and frequency control of islanded microgrids," *IEEE Transactions on Power Systems*, vol. 32, no. 5, pp. 3648–3659, 2016.
- [34] A. Bidram, A. Davoudi, and F. L. Lewis, "Finite-time frequency synchronization in microgrids," in *2014 IEEE Energy Conversion Congress and Exposition (ECCE)*. IEEE, 2014, pp. 2648–2654.
- [35] S. T. Cady, A. D. Domínguez-García, and C. N. Hadjicostis, "Finite-time approximate consensus and its application to distributed frequency regulation in islanded AC microgrids," in *2015 48th Hawaii International Conference on System Sciences*. IEEE, 2015, pp. 2664–2670.
- [36] Z. Deng, Y. Xu, H. Sun, and X. Shen, "Distributed, bounded and finite-time convergence secondary frequency control in an autonomous microgrid," *IEEE Transactions on Smart Grid*, vol. 10, no. 3, pp. 2776–2788, 2018.
- [37] H. Fawzi, P. Tabuada, and S. Diggavi, "Secure estimation and control for cyber-physical systems under adversarial attacks," *IEEE Transactions on Automatic Control*, vol. 59, no. 6, pp. 1454–1467, 2014.
- [38] A. Avizienis, J.-C. Laprie, B. Randell, and C. Landwehr, "Basic concepts and taxonomy of dependable and secure computing," *IEEE Transactions on Dependable and Secure Computing*, vol. 1, no. 1, pp. 11–33, 2004.
- [39] L. Ortiz, J. W. González, L. B. Gutierrez, and O. Llanes-Santiago, "A review on control and fault-tolerant control systems of uppercase AC/DC microgrids," *Heliyon*, vol. 6, no. 8, p. e04799, 2020.
- [40] N. Joshi and A. Mehta, "Fault-tolerant secondary second-order sliding mode consensus protocol for dc microgrid," *Transactions of the Indian National Academy of Engineering*, pp. 1–19, 2021.
- [41] X. Li, C. Wen, C. Chen, and Q. Xu, "Adaptive resilient secondary control for microgrids with communication faults," *IEEE Transactions on Cybernetics*, vol. Early Access, pp. 1–11, 2021.
- [42] X. Sun, Y. Hao, Q. Wu, X. Guo, and B. Wang, "A multifunctional and wireless droop control for distributed energy storage units in islanded AC microgrid applications," *IEEE Transactions on Power Electronics*, vol. 32, no. 1, pp. 736–751, 2016.
- [43] H. K. Khalil and J. W. Grizzle, *Nonlinear systems*. Prentice hall Upper Saddle River, NJ, 2002, vol. 3.
- [44] G. Lou, W. Gu, W. Sheng, X. Song, and F. Gao, "Distributed model predictive secondary voltage control of islanded microgrids with feedback linearization," *IEEE Access*, vol. 6, pp. 50 169–50 178, 2018.
- [45] M. A. Mahmud, M. Hossain, H. Pota, and A. Oo, "Robust nonlinear distributed controller design for active and reactive power sharing in islanded microgrids," *IEEE Transactions on Energy Conversion*, vol. 29, no. 4, pp. 893–903, 2014.
- [46] A. Bidram, F. L. Lewis, and A. Davoudi, "Distributed control systems for small-scale power networks: Using multiagent cooperative control theory," *IEEE Control Systems Magazine*, vol. 34, no. 6, pp. 56–77, 2014.
- [47] L.-B. Wu, G.-H. Yang, and D. Ye, "Robust adaptive fault-tolerant control for linear systems with actuator failures and mismatched parameter uncertainties," *IET Control Theory & Applications*, vol. 8, no. 6, pp. 441–449, 2014.



**Mahmood Jamali** received the B.Sc. degree in Control-Electrical Engineering from the Ferdowsi University of Mashhad, Mashhad, Iran, and the M.Sc. degree in Control Engineering from the Amir Kabir University of Technology (Tehran Polytechnic), Tehran, Iran, in 2017 and 2020, respectively. He is currently working toward the Ph.D. degree in Automatic Control and System Engineering from the University of Sheffield, Sheffield, United Kingdom. His research interests include control of power grids and microgrid

systems.



**Hamid Reza Baghaee** (SM' 2008, M' 2017) received his Ph.D. degree in Electrical Engineering from Amirkabir University Technology (AUT) in 2017. He is the author of two books, three published book chapters, 80 ISI-ranked journal papers, 55 conference papers, and the owner of a registered patent. In November 2021, his book entitled "Microgrids and Methods of Analysis" was selected by the Technical Committee of the Iran Ministry of Energy (MOE) as the "Best Book of the year in Power and Energy Industry." He has

many HOT and HIGHLY-CITED papers among his journal papers, based on SciVal and Web of Science statistics. His special fields of interest are micro and smart grids, cyber-physical systems, application of power electronics in power systems, distributed generation and renewable energy resources, FACTS CUSTOM Power devices and HVDC systems, power system operation and control, real-time simulation of power systems, microgrids, and power electronic converters, and application of artificial intelligence in power systems.

Dr. Baghaee is also the winner of four national and international prizes, as the best dissertation award, from the Iranian scientific organization of smart grids (ISOSG) in December 2017, Iranian energy association (IEA) in February 2018, AUT in December 2018, and IEEE Iran Section in May 2019 for his Ph.D. dissertation. In August 2019, he joined AUT as an associate research professor in the department of electrical engineering. He is the project coordinator of the AUT Pilot Microgrid Project as one of the sub-projects of the Iran Grand (National) Smart Grid Project. He has been a co-supervisor of more than Ph.D. and M.Sc. students since 2017. He was a short-term scientist with CERN and ABB, Switzerland. He was selected as the top 1% reviewer of engineering in September 2018 and the top 1% reviewer of engineering and cross-field in September 2019. Dr. Baghaee is a member and secretary chair at the IEEE Iran Section communication committee and a member of IEEE, IEEE Smart Grid Community, IEEE Internet of Things Technical Community, IEEE Big Data Community, and IEEE Sensors Council. Since August 2021, he has been elected as a member of the board and chairman of the committee on publications and conferences at the Iran Scientific Organization of Smart Grids (ISOSG) and a member of the IEEE PES Transmission Subcommittee. He is also the reviewer of several IEEE and IET journals and guest editor of several special issues in IEEE, IET, Elsevier, MDPI, and scientific program committees of several IEEE conferences. Since December 2020, he has served as an associate editor of the IET Journal of engineering. He has also been selected as the best and most outstanding review in several journals, such as IEEE Transactions on Power System (Top 0.66% of reviewers, in 2020), Elsevier Control Engineering Practice (in 2018, 2019, and 2020), and Wiley International Transaction on Electrical Energy Systems in 2020, and the Pablon best reviewer in Engineering (in 2018), and both engineering and cross-field (in 2019). He has been selected as the Star Reviewer of IEEE JESTPE and IEEE Power Electronics Society in 2020, commemorated, and presented during the IEEE ECCE 2021 conference in October in Vancouver, Canada. He has also been listed in the 2020 edition of the top 2% scientists in the field of ENERGY according to the "Science Wide Author Databases of Standardized Citation Indicators Science Wide Author Databases of Standardized Citation Indicatorsb."



**Mahdiah S. Sadabadi** (SM'21) is currently an Assistant Professor at the School of Electronic Engineering and Computer Science at the Queen Mary University of London, United Kingdom. Prior to that, she was an Assistant Professor with the Department of Automatic Control and Systems Engineering, University of Sheffield, United Kingdom. In 2017-2018, she was a Postdoctoral Research Associate at the Department of Engineering, the University of Cambridge, and affiliated with Trinity College in Cambridge. She

was a Postdoctoral Fellow in the Division of Automatic Control at the Department of Electrical Engineering, Linköping University in Sweden. She received her Ph.D. in Control Systems from the Swiss Federal Institute of Technology in Lausanne (EPFL), Switzerland in February 2016. She was a Visiting Scholar at Polytechnique Montreal, LAAS-CNRS in Toulouse, France, and HHMI Janelia Research Campus in Ashburn, VA, USA. Her research interests are generally centered on robust fixed-structure control of large-scale uncertain systems and resilient control systems with applications in power grids, microgrids, and power electronics converters.



**Gevork B. Gharehpetian** (M'00–SM'08) received his BS, MS and PhD degrees in electrical engineering in 1987, 1989 and 1996 from Tabriz University, Tabriz, Iran and Amirkabir University of Technology (AUT), Tehran, Iran and Tehran University, Tehran, Iran, respectively, graduating all with First Class Honors. As a PhD student, he has received scholarship from DAAD (German Academic Exchange Service) from 1993 to 1996 and he was with High Voltage Institute of RWTH Aachen, Aachen, Germany. He has been holding the

Assistant Professor position at AUT from 1997 to 2003, the position of Associate Professor from 2004 to 2007 and has been Professor since 2007. He was selected by the MSRT (Ministry of Science Research and Technology) as the distinguished professor of Iran, by IAEEE (Iranian Association of Electrical and Electronics Engineers) as the distinguished researcher of Iran, by Iran Energy Association (IEA) as the best researcher of Iran in the field of energy, by the MSRT as the distinguished researcher of Iran, by the Academy of Science of the Islamic Republic of Iran as the distinguished professor of electrical engineering, by National Elites Foundation as the laureates of Alameh Tabatabaei Award and was awarded the National Prize in 2008, 2010, 2018, 2018, 2019 and 2019, respectively. Based on the Web of Science database (2005-2019), he is among world's top 1% elite scientists according to ESI (Essential Science Indicators) ranking system. Prof. Gharehpetian is distinguished, senior and distinguished member of CIGRE, IEEE and IAEEE, respectively. Since 2004, he has been the Editor-in-Chief of the Journal of IAEEE. He is the author of more than 1300 journal and conference papers. His teaching and research interests include Smart Grid, Microgrids, FACTS and HVDC Systems, Monitoring of Power Transformers and its Transients.



**Amjad Anvari-Moghaddam** (S'10–M'14–SM'17) is an Associate Professor and Leader of Intelligent Energy Systems and Flexible Markets (iGRIDS) Research Group at the Department of Energy (AAU Energy), Aalborg University where he is also acting as the Vice-Leader of Power Electronic Control, Reliability and System Optimization (PESYS) and the coordinator of Integrated Energy Systems Laboratory (IES-Lab). He made a Guest Professor stay with Technische Universität München, Germany during November/December of 2021. His research

interests include planning, control and operation management of microgrids, renewable/hybrid power systems and integrated energy systems with appropriate market mechanisms. He has (co)authored more than 270 technical articles, 7 books and 17 book chapters in the field. Dr. Anvari-Moghaddam serves as the Associate Editor of the IEEE TRANSACTIONS ON POWER SYSTEMS, IEEE Access, IEEE Systems Journal, IEEE Open Access Journal of Power and Energy, and IEEE Power Engineering Letters. He is the Vice-Chair of IEEE Denmark Section and serves as a Technical Committee Member of several IEEE PES/IES/PELS and CIGRE working groups. He was the recipient of 2020 DUO – India Fellowship Award, DANIDA Research Fellowship grants from the Ministry of Foreign Affairs of Denmark in 2018 and 2021, IEEE-CS Outstanding Leadership Award 2018 (Halifax, Nova Scotia, Canada), and the 2017 IEEE-CS Outstanding Service Award (Exeter-UK).



**Frede Blaabjerg** (S'86–M'88–SM'97–F'03) was with ABB-Scandia, Randers, Denmark, from 1987 to 1988. From 1988 to 1992, he got the PhD degree in Electrical Engineering at Aalborg University in 1995. He became an Assistant Professor in 1992, an Associate Professor in 1996, and a Full Professor of power electronics and drives in 1998 at AAU Energy. From 2017 he became a Villum Investigator. He is honoris causa at University Politehnica Timisoara (UPT), Romania in 2017 and Tallinn Technical University (TTU), Estonia in 2018. His current

research interests include power electronics and its applications such as in wind turbines, PV systems, reliability, harmonics and adjustable speed drives. He has published more than 600 journal papers in the fields of power electronics and its applications. He is the co-author of four monographs and editor of ten books in power electronics and its applications.

He has received 33 IEEE Prize Paper Awards, the IEEE PELS Distinguished Service Award in 2009, the EPE-PEMC Council Award in 2010, the IEEE William E. Newell Power Electronics Award 2014, the Villum Kann Rasmussen Research Award 2014, the Global Energy Prize in 2019 and the 2020 IEEE Edison Medal. He was the Editor-in-Chief of the IEEE TRANSACTIONS ON POWER ELECTRONICS from 2006 to 2012. He has been Distinguished Lecturer for the IEEE Power Electronics Society from 2005 to 2007 and for the IEEE Industry Applications Society from 2010 to 2011 as well as 2017 to 2018. In 2019-2020 he served as a President of IEEE Power Electronics Society. He has been Vice-President of the Danish Academy of Technical Sciences. He is nominated in 2014-2020 by Thomson Reuters to be between the most 250 cited researchers in Engineering in the world.