



AALBORG UNIVERSITY
DENMARK

Aalborg Universitet

Detailed measurement on a HESCO diffuser

Jensen, Rasmus Lund; Holm, Dorte; Nielsen, Peter V.

Published in:
Proceedings of Roomvent 2007

Publication date:
2007

Document Version
Publisher's PDF, also known as Version of record

[Link to publication from Aalborg University](#)

Citation for published version (APA):
Jensen, R. L., Holm, D., & Nielsen, P. V. (2007). Detailed measurement on a HESCO diffuser. In O. Seppänen, & J. Säteri (Eds.), *Proceedings of Roomvent 2007: Helsinki 13-15 June 2007* FINVAC ry.

General rights

Copyright and moral rights for the publications made accessible in the public portal are retained by the authors and/or other copyright owners and it is a condition of accessing publications that users recognise and abide by the legal requirements associated with these rights.

- ? Users may download and print one copy of any publication from the public portal for the purpose of private study or research.
- ? You may not further distribute the material or use it for any profit-making activity or commercial gain
- ? You may freely distribute the URL identifying the publication in the public portal ?

Take down policy

If you believe that this document breaches copyright please contact us at vbn@aub.aau.dk providing details, and we will remove access to the work immediately and investigate your claim.

Detailed measurement on a HESCO diffuser

Rasmus L. Jensen¹, Dorte Holm² and Peter V. Nielsen¹

¹ Aalborg University, Department of Civil Engineering

² Herning Kommune, Teknik og Miljø

Corresponding email: rlj@civil.aau.dk

SUMMARY

This paper focuses on measuring the inlet velocity from a HESCO diffuser used in the IEA Annex 20 work as a function of the volume flow it provides. The aim of the present work is to establish a relation between the inlet velocity, the effective area and the airflow. This is important because the inlet velocity is a very important boundary condition both in CFD calculation and general flow measurements. If only the volume flow and the geometrical area are used, a relatively large error in the inlet velocity may result. From the detailed measurements it was possible to establish an expression between the inlet velocity and the effective area.

INTRODUCTION

Over the last 30 years the prediction of airflow and temperature distribution in rooms by use of Computational Fluid Dynamics (CFD) has developed from crude calculations of very simple setups to very detailed calculations of complicated setups.

During the same time CFD has evolved from being a tool used mainly in research to a widespread use of CFD by consulting engineers. This development calls for ways to insure the quality of the simulations. One way of insuring this is to use detailed measurements performed in a controlled environment to test both the model and the boundary conditions.

This paper focuses on measuring the inlet velocity from a HESCO diffuser as a function of the volume flow it provides. The diffuser is of the same type as was used in the IEA Annex 20 work and therefore, a lot of knowledge exists both on modeling the diffuser and on the airflow in a room caused by the diffuser. The large amount of results is still being used to develop and improve CFD simulations, e.g. [1, 2]

The aim of the present work is to establish a relation between the inlet velocity, the effective inlet area and the airflow. This is important because the inlet velocity is a very important boundary condition and if only the volume flow and the geometrical area are used, a relatively large error in the inlet velocity may result.

The inlet velocity was measured under isothermal conditions using a Laser Doppler Anemometer (LDA). The inlet velocity was measured for eight different volume flows.

The measurements show a nice relation between the effective inlet area and the inlet velocity. The effective inlet area increases with the inlet velocity and approaches a constant value below the geometrical inlet area.

METHODS

Test room

In this work full-scale measurements were conducted in a climate chamber suiting the specification of IEA Annex 20, figure 1. The HESCO inlet diffuser contains 84 individually adjustable nozzles placed in four rows. All nozzles are adjusted to an upward angle of 40° , figure 2. The nozzles have a diameter of 12 mm corresponding to an area of approximately 113 mm^2 each.

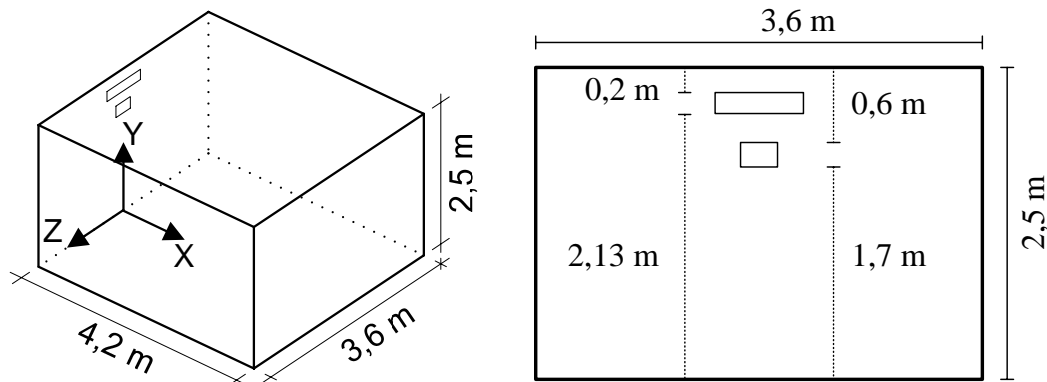

Figure 1. a) Test room specifications, b) Location of inlet and outlet

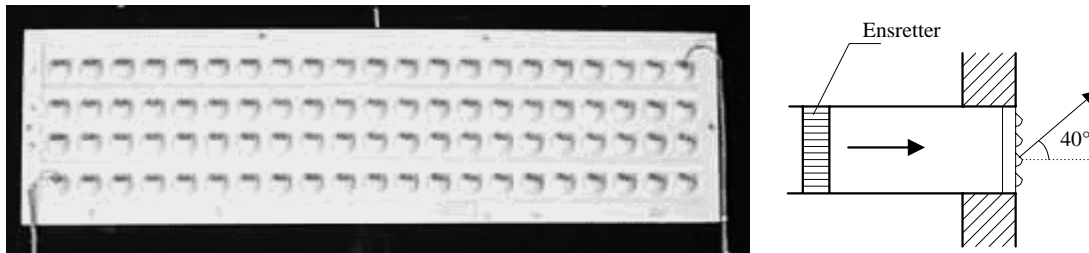

Figure 2. a) The HESCO diffuser, b) Nozzle adjustment

Measuring equipment

Two types of measuring equipment were used to measure the inlet velocity. A Hot Cylinder Anemometer (HCA) was used as in [3, 4, 5] and a Laser Doppler Anemometer (LDA) as in [6]. The HCA used had a metal shield making it difficult to place it exactly above the centre of the nozzles. In addition the temperature compensating cylinder could not be placed within the airflow of the nozzle. On the other hand the LDA makes it possible to measure very close to the centre of the nozzle's muzzle without disturbing the flow. The setup of both instruments is shown on figure 3. Both instruments were mounted on a stand.

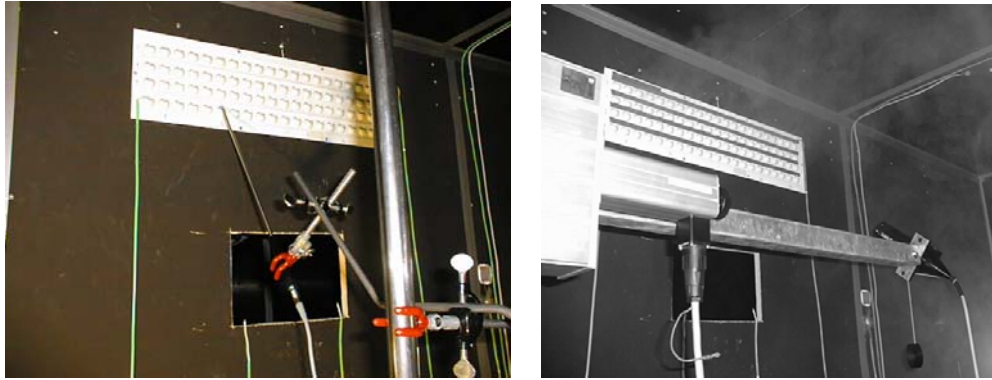

Figure 3. a) HCA setup, b) LDA setup

Measurements performed

The inlet velocity was measured three times for two different air changes (2,9 & 5,8 h⁻¹) using the HCA. The velocity was measured at 10 nuzzles as suggested in [4], see figure 4.

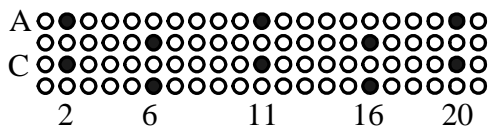

Figure 4. The 10 different nuzzles where the velocity was measured

With the LDA it was possible to measure the velocity profile across a nozzle. This was done for two air change rates (1,5 & 4,7 h⁻¹) in order to test the assumption that the profile was squared.

In order to establish a relationship between the air change rate and the effective inlet area the centre velocity was measure at all 84 nuzzles at eight different air change rates (0,5; 1; 1,5; 2; 3; 4; 5 & 6 h⁻¹).

RESULTS

The effective inlet area is extremely sensitive to the measured inlet velocity. Therefore even small fluctuations from one measurement to another, results in large differences in the calculated effective area.

Hot Cylinder Anemometer

The results from using the HCA were not satisfactory. Both comparisons to results in [4] but more importantly the two measurements done at an air change of 2,9 h⁻¹ resulted in an effective area of $8,034e^{-3}$ and $8,8261e^{-3}$ - a difference of 10%.

Laser Doppler Anemometer

At figure 5 the velocity profile across a nozzle can be seen for two different air change rates. The figure clearly shows that a square velocity profile is a fair assumption.

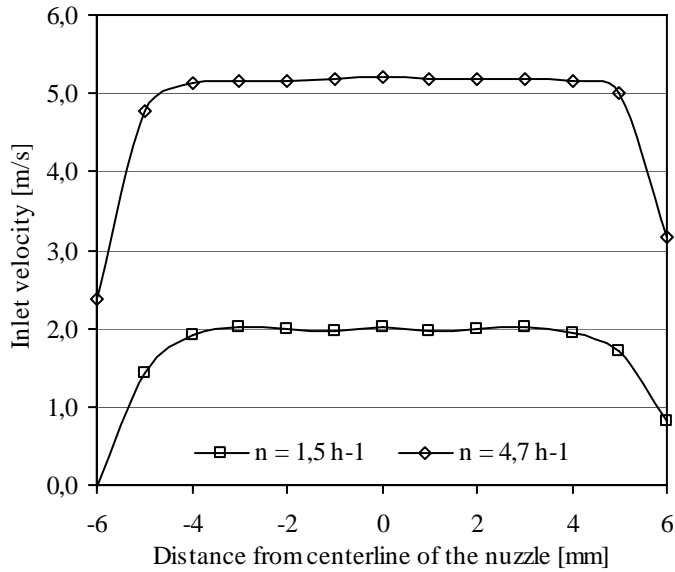

Figure 5. Velocity profile across a nozzle

The mean velocity at the eight different air changes is shown in table 1. In figure 6 the results are plotted forming a linear relation between the air change rate and inlet velocity. The results of the HCA measurements are also plotted showing fairly good agreement with the results of the LDA.

Table 1. Inlet velocity at the different air change rates

Air change rate [h ⁻¹]	0,5	1,0	1,5	2,0	3,0	4,0	5,0	6,0
Inlet velocity [m/s]	0,76	1,37	1,96	2,61	3,78	4,96	6,25	7,36

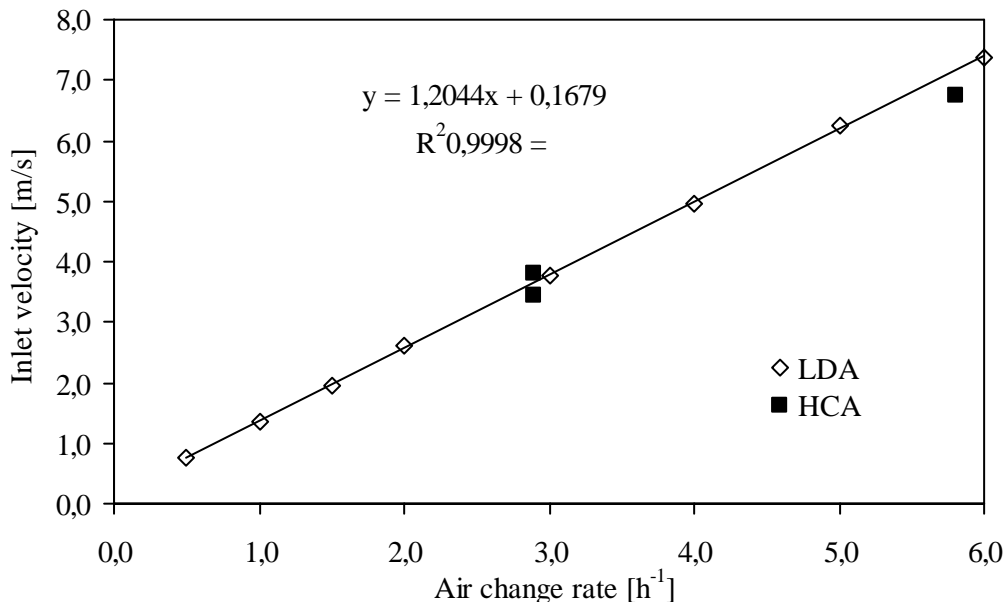

Figure 6. Inlet velocity as a function of air change rate

Even though there is a clear relation between the average velocity and the air change there is a large difference between the different nozzles. This is illustrated on figure 7 where the inlet velocity of all the nozzles at an air change of 3 h⁻¹ is shown. From this it is clear that one

should be very careful about only measuring at a few nozzles. However in this case there is a good agreement between the inlet mean velocity of all the nuzzles and the 10 nuzzles shown on figure 4. See figure 8.

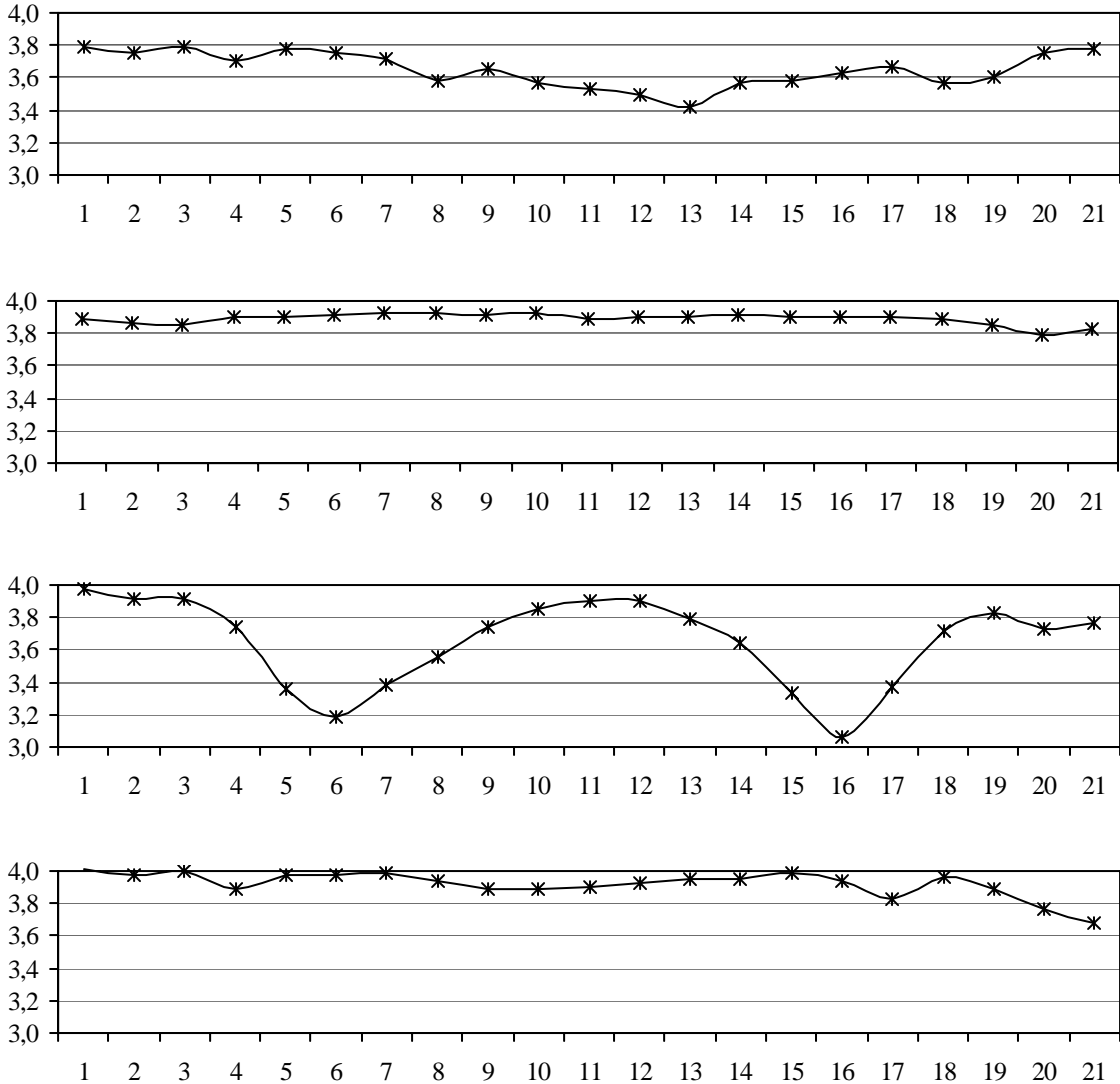

Figure 7. Inlet velocity at the 84 nuzzles at an air change of 3 h⁻¹

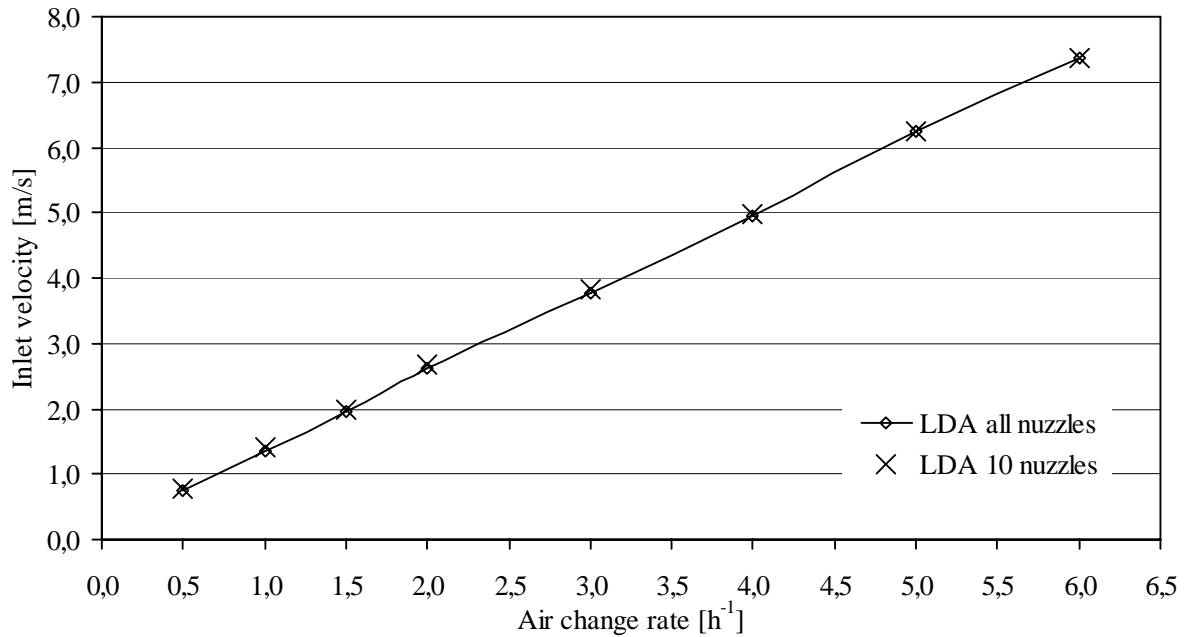

Figure 8. Mean inlet velocity as a function of air change rate

Effective inlet area

In figure 9 the effective inlet area is shown as a function of the air change rate. From this it is clear that the HCA measurement deviates too much from that of the LDA. It is also possible to see that the effective inlet area approaches a constant value as the air change increases and thus the local Reynolds Number. Connected values of air change, inlet velocity, inlet area and local Reynolds Number are given in table 2. The derived expression for the effective inlet area is given in (1). As shown in (2) the inlet area approaches 0,0872 as the air change rate goes to infinity.

$$a_0 = \frac{1}{114,7 + 15,99 \cdot n^{-1}}, \quad (1)$$

$$a_0 \rightarrow 0,0872 \text{ for } n \rightarrow \infty, \quad (2)$$

where a_0 is the effective inlet area and n is the air change rate.

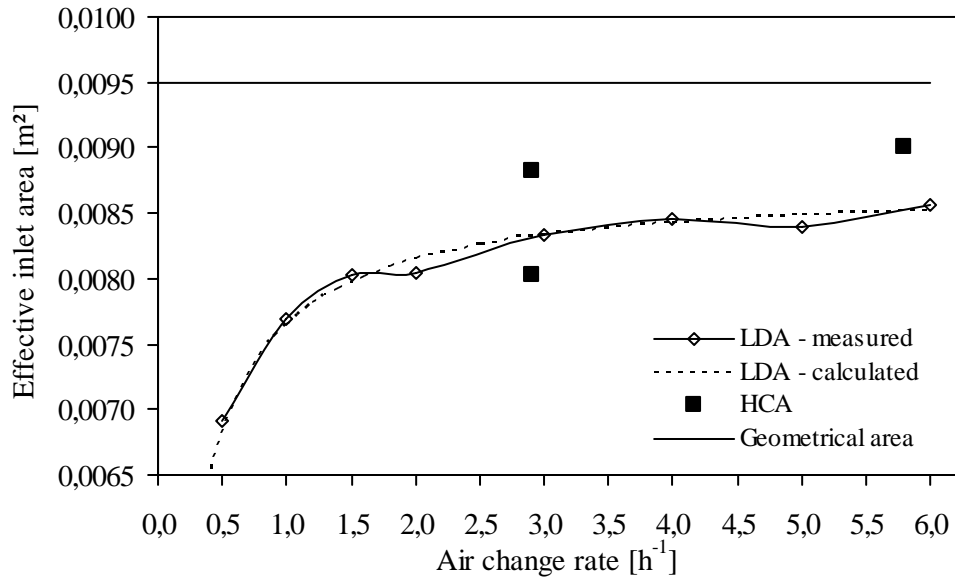

Figure 9. Effective inlet area as a function of air change rate

Table 2. Connected values of air change rate, inlet velocity, effective inlet area and local Reynolds Number

n [h ⁻¹]	u ₀ [m/s]	a ₀ [m ²]	Re [-]
0,5	0,76	0,00691	686
1,0	1,37	0,00769	1232
1,5	1,96	0,00803	1770
2,0	2,61	0,00804	2357
3,0	3,78	0,00834	3408
4,0	4,96	0,00846	4477
5,0	6,25	0,00840	5638
6,0	7,36	0,00857	6637

Comparison to previously results

In figure 10 the results from the present work is compared to the results from [3 and 4]. From the figure it is clear that there is a large difference between the previous results and the present ones. The previous shows large unexplained variations and also effective inlet areas larger than the geometrical area, which is not possible. The large deviation is most likely due to the fact that the previous results where obtained using the HCA and not the LDA.

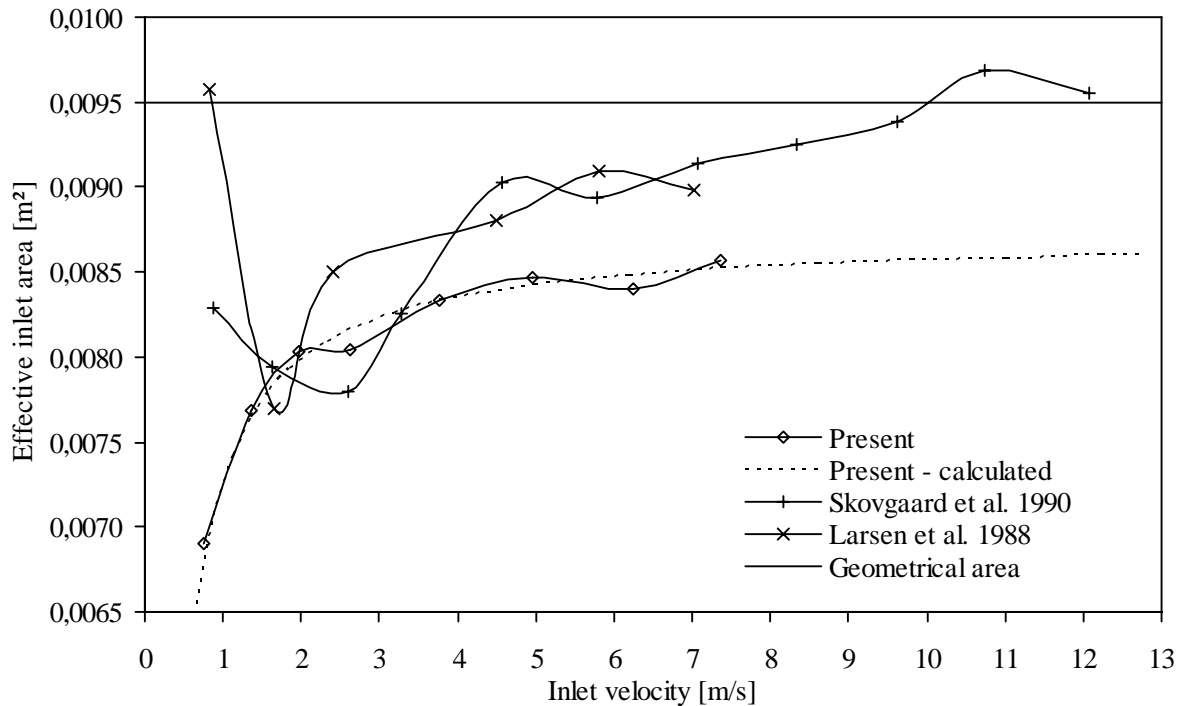

Figure 10. Comparison with previous results.

In [5] Skovgaard et al. suggests an effective inlet area for three different air change rates that lies within the variation of the measurements in [3 and 4] and fits the present ones much better, see table 3. However there is still a difference of up to approximately 5% in the inlet area and inlet velocity. It can also be seen from the table that the derived expression shown in (1) only results in small deviations (below 0,5%) compared to the measured values.

The results of the measurements correspond well with the results given in [6]. They measured the velocity at every other nozzle at all four rows (44 nozzles in total) at an air change rate of 3 h^{-1} resulting in an mean inlet velocity of scarcely 3,8 m/s. This corresponds very well with the results of this work where the inlet velocity at an air change of 3 h^{-1} was measured to 3,78 m/s

Table 3. Comparison of results to previous results

Effective inlet area [m ²]				Difference [%]	
n	Present - measured	Present - calculated	[5]	Present - calculated	[5]
1	0,00769	0,00765	0,00800	0,5	-4,1
3	0,00834	0,00833	0,00855	0,1	-2,5
6	0,00857	0,00852	0,00900	0,5	-5,1

Inlet velocity [m/s]				Difference [%]	
n	Present - measured	Present - calculated	[5]	Present - calculated	[5]
1	1,37	1,37	1,31	-0,5	3,9
3	3,78	3,78	3,68	-0,1	2,5
6	7,36	7,39	7,00	-0,5	4,8

DISCUSSION

The comparison between the two different measuring instrument clearly shows that a HCA is a poor choice when measuring the inlet velocity from a diffuser. The LDA however provides fine results and should therefore always be used.

When determining the effective inlet area it is important to verify that assumption regarding e.g. the velocity profile across the nozzles holds. Also one should be careful to measure in a limited number of points since there can be large variations between in this case the different nozzles.

Based on the measurements an expression for the effective inlet area given as a function of the air change rate is derived. The agreement between the expression and the measurements are excellent and therefore the expression should be used when determining boundary conditions for CFD simulations based on the Annex 20 room geometry.

REFERENCES

1. Luo, S. and Roux, B. 2004. Modeling of the HESCO nozzle diffuser used in IEA Annex-20 experiment test room. *Building and Environment* 39 (2004) pp 367 - 384
2. Luo, S., Heikkinen, J. and Roux, B. 2004. Simulation of air flow in the IEA Annex 20 test room - validation of a simplified model for the nozzle diffuser in isothermal test cases. *Building and Environment* 39 (2004) pp 1403 - 1415
3. Larsen, J. H., Kjelgaard, E. W. and Agesen, L. 1988. Private communication. Aalborg University
4. Skovgaard, M., Hyldgaard, C. E. and Nielsen, P. V. 1990. High and Low Reynolds Number Measurements in a Room with an Impinging Isothermal Jet, *Proceedings of Roomvent 1990*, Oslo
5. Skovgaard, M. and Nielsen, P. V. 1991. Modelling Complex Inlet Geometries in CFD - Applied to Air Flow in Ventilated Rooms. *Proceedings of the 12th AIVC Conference*, Ottawa, Canada.
6. Ewert, M. and Zeller, M. 1991. Turbulence Parameters at Supply Opening (measurements). 1991. IEA Annex 20, Subtask 1: Room Air and Contaminant Flow. Lehrstuhl für Wärmeübertragung und Klimatechnik, Eilfschornsteinstrasse 18, D-5100 Aachen, Germany