



**AALBORG UNIVERSITY**  
DENMARK

**Aalborg Universitet**

## **Specific Guidelines for Stenlose Syd**

Citterio, Marco; Mørck, Ove; Thomsen, Kirsten Engelund

*Publication date:*  
2008

*Document Version*  
Publisher's PDF, also known as Version of record

[Link to publication from Aalborg University](#)

*Citation for published version (APA):*

Citterio, M., Mørck, O., & Thomsen, K. E. (2008). *Specific Guidelines for Stenlose Syd*. Concerto, Class 1, Cost-effective Low-energy Advanced Sustainable So1utions, EU project.

### **General rights**

Copyright and moral rights for the publications made accessible in the public portal are retained by the authors and/or other copyright owners and it is a condition of accessing publications that users recognise and abide by the legal requirements associated with these rights.

- ? Users may download and print one copy of any publication from the public portal for the purpose of private study or research.
- ? You may not further distribute the material or use it for any profit-making activity or commercial gain
- ? You may freely distribute the URL identifying the publication in the public portal ?

### **Take down policy**

If you believe that this document breaches copyright please contact us at [vbn@aub.aau.dk](mailto:vbn@aub.aau.dk) providing details, and we will remove access to the work immediately and investigate your claim.



Project Acronym: Class 1  
REF EC: 038572  
REF (project coordinator org.):  
DOCUMENT: Del. 21  
REF.:

Project Coordinator:  
Bruno Andersen  
Project coordination org.: Municipality of  
Egedal  
Date: October 10, 2008  
Revision: 1

## Specific Design Guidelines for Stenlose Syd

### CONCERTO INITIATIVE Class 1

### Cost-effective Low-energy Advanced Sustainable So1utions

Instrument: Integrated Project  
Thematic Priority: Energy 2005

Period covered:  
1.11.07- 30.09. 08  
Start date of project:  
November 1, 2007

Date of preparation:  
October 10, 2008

Duration: 5 years



CONCERTO is co-funded by the European Commission

## *Specific Design Guidelines for Stenlose Syd*



Editors:

Marco Citterio (Enea - IT)  
Ove Christen Morck (Cenergia - DK)  
Kirsten Engelund Thomsen (SBI - DK)

## Indhold

<b>1.</b>	<b><i>Preface: the class 1 project</i></b> .....	<b>1</b>
<b>2.</b>	<b><i>Introduction - what is low energy houses and what is low-energy class 1</i></b> .....	<b>2</b>
<b>2.1.</b>	<b>Low energy houses</b> .....	<b>2</b>
2.1.1.	Standard requirements in the Danish Building regulations .....	2
2.1.2.	Low energy house definitions according to the Danish BR .....	3
2.1.3.	Other low energy house definitions.....	3
<b>3.</b>	<b><i>The thermal envelope - guidelines concerning low energy buildings</i></b> <b>5</b>	
<b>3.1.</b>	<b>Planning and designing phases</b> .....	<b>5</b>
3.1.1.	Building.....	5
3.1.2.	Ventilation with heat recovery .....	7
<b>3.2.</b>	<b>General</b> .....	<b>7</b>
<b>3.3.</b>	<b>The work in progress</b> .....	<b>7</b>
<b>4.</b>	<b><i>Guidelines concerning airtightness</i></b> .....	<b>9</b>
<b>4.1.</b>	<b>Why design airtight buildings?</b> .....	<b>9</b>
<b>4.2.</b>	<b>The rules in the Danish Building Regulations</b> .....	<b>9</b>
<b>4.3.</b>	<b>Checklist – demands to thermal envelope and workmanship</b> .....	<b>9</b>
<b>4.4.</b>	<b>Measuring of airtightness</b> .....	<b>10</b>
<b>5.</b>	<b><i>The heating systems</i></b> .....	<b>11</b>
<b>5.1.</b>	<b>Heating systems for gas boilers</b> .....	<b>11</b>
5.1.1.	planning and design phase.....	11
5.1.2.	Execution .....	12
<b>6.</b>	<b><i>Indoor environmental quality</i></b> .....	<b>13</b>
<b>6.1.</b>	<b>Overview</b> .....	<b>13</b>
<b>6.2.</b>	<b>Good and poor indoor climate</b> .....	<b>13</b>
<b>6.3.</b>	<b>Guidelines for good indoor climate</b> .....	<b>13</b>
6.3.1.	Positioning of the building and exterior influence .....	13
6.3.2.	Building design and arrangement.....	13
6.3.3.	Building construction and materials.....	14
6.3.4.	Ventilation systems .....	14
6.3.5.	Heating systems .....	14
6.3.6.	Apparatus .....	14
6.3.7.	Operation and maintenance.....	15
6.3.8.	Indoor climate problems.....	15
6.3.9.	The building and the plot .....	15
<b>7.</b>	<b><i>Guideline for Thermal comfort in residential houses</i></b> ....	<b>19</b>
<b>7.1.</b>	<b>Fundamentals</b> .....	<b>19</b>
<b>7.2.</b>	<b>Design and planning</b> .....	<b>20</b>

7.3.	Example of calculation on a reference building in Stenlose.....	21
8.	<i>Guidelines for Daylighting and Visual Comfort in residential houses</i> .....	23
8.1.	Overview.....	23
8.2.	Benefit of daylighting.....	23
8.3.	Basic Daylighting Principles .....	23
9.	<i>User influence</i> .....	28
9.1.	Guidelines for the users.....	28
9.2.	Introduction.....	28
9.3.	Understanding the building .....	28
9.4.	Use of the BEMS system.....	28
9.5.	Suggested list of content of the user guide .....	29
10.	<i>Appendix</i> .....	30
10.1.	Dynamic simulation on house type Lind og RISØR - AVR165.....	30
10.1.1.	Description of simulation model .....	30
10.1.2.	Results: Energy .....	32
10.1.3.	Results: Thermal Comfort.....	32
10.2.	COMPARISON of results from Trnsys simulations and calculations with Be06 .....	36

## 1. PREFACE: THE CLASS 1 PROJECT

The idea of the project CLASS 1 is to use the strengthening of the energy requirements to boost and drive the technological developments and to prove the economical and environmental benefits of ultra-low energy buildings (50% below the new requirements in the Danish building regulations) integrated with biomass- and solar heating based renewable energy supply.

In this context the Scientific & Technical objectives are to:

1. Optimise the integration of low-energy building technologies with supply (renewable and conventional) and distribution (heating and electricity) technologies.
2. Advance selected technologies within the 3 areas: low-energy building, renewable energy supply and distribution
3. Improve the design, checking and verification procedures (this relates directly to the implementation of the building energy performance directive -EPBD).
4. Integrate the European ecolabel in the building projects (houses and components)
5. Demonstrate large scale implementation at close to market technical and economical conditions.

The Class 1 project is focused on the optimisation of sustainable energy systems in local communities, through an innovative integration of RE technologies with ultra low-energy buildings.

The bio-mass CHP system produces electricity and heat that are distributed directly to the use for heating in an innovative local district heating system for the dense, low-rise houses, and through the electricity network to heat the single family houses by heat pumps. Solar heating systems integrated in the network - and individual systems on the single family houses will be supplementing the CHP and taking over the in summer months when it is shut down. An advanced Building Energy Management System will control the energy supply, the thermal storages (for solar and for heating energy pulses from the CHP plant).

The Class 1 project has been designed to demonstrate that sustainable energy solutions in which integrated energy efficiency and renewable energy sources are economically viable, and technically and aesthetically acceptable.

The project also has special focus on the Indoor Environmental Quality (IEQ) to make sure that the energy savings are met without reducing the IEQ standards set out in the design specification phase. The IEQ focus is one of the areas in which the Class 1 project involves partners from other EU countries who are experts in respectively lighting and thermal comfort issues. Also trans-national cooperation is introduced for the socio-economic research part of the project, which deals with the user point of view (priorities, etc.) in the participating countries.

The Class 1 project demonstrates improvements to 6 individual technologies (windows, slab and foundation insulation systems, bio-mass gasification, local district heating distribution networks, ventilation heat recovery combined with heat-pumps and BEMS) and an innovative integration of these technologies (with solar heating) which lead to improved cost effectiveness.

## 2. INTRODUCTION - WHAT IS LOW ENERGY HOUSES AND WHAT IS LOW-ENERGY CLASS 1

The Municipality of Egedal has decided to strengthen the energy requirements for a new settlement to be erected in the municipality. In the years 2007-2008 a total of 442 dwellings will be designed and constructed with a heating demand corresponding to the new Danish low-energy standard referred to as "low-energy class 1" in a new settlement called Stenlose Syd. This requirement means that the energy consumption will be 50% below the new energy regulations introduced with the implementation of the EPBD (Energy Performance of Buildings Directive) in Denmark in 2006 (which are app. 25% lower than the previous regulations). Another 69 dwellings will be designed and constructed as so-called "passive house" buildings with a yearly heating demand of 15 kWh/m<sup>2</sup>.

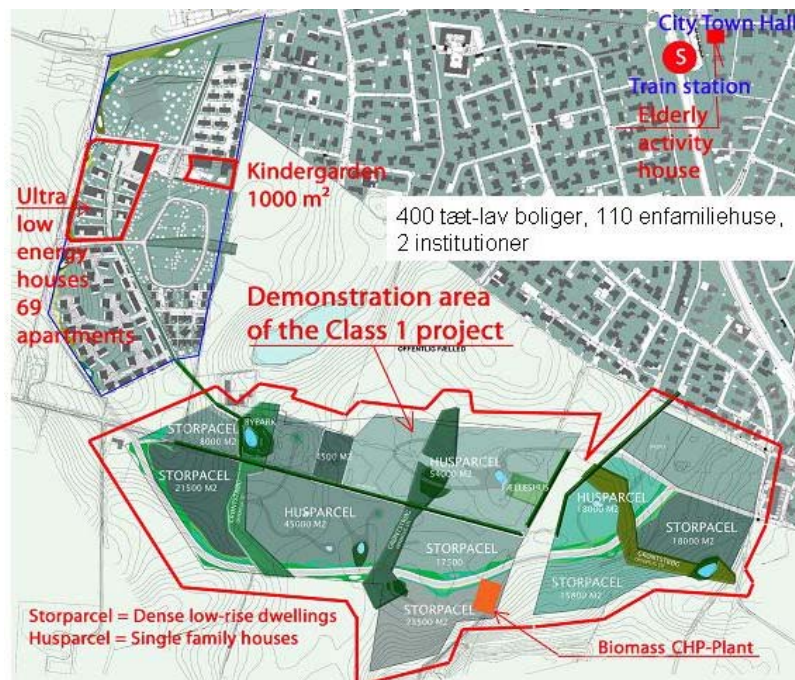

*Survey of the area and the buildings which are included by CLASS1 project.*

### 2.1. LOW ENERGY HOUSES

The definition of low energy houses is bound to be dependent on the country and climate which it concerns. These guidelines have been developed for the Danish conditions and it should be noted that appropriate measures have to be taken if they are transferred to other countries. Generally, a low energy house is a house that uses considerably less energy to maintain comfort conditions than a house built according to the standard that is current practice at the location in question. Below four low energy house definitions, which are currently in use in Denmark, are presented.

#### 2.1.1. STANDARD REQUIREMENTS IN THE DANISH BUILDING REGULATIONS

The Danish Building Regulation (BR) defines a building's energy consumption in relation to a so-called energy frame. For dwellings the energy frame includes heating, hot water and electricity used for pumps and ventilators, which are part of the heating and ventilation system and for institution and offices also electricity for lighting is included. If the calculation shows a cooling need this will be added as well, even if there is no cooling system installed. In the energy frame may be included production of

heat and electricity with solar energy - solar thermal and solar cells. The calculation of the energy frame of a building is conducted according to "SBI-anvisning 213" from the Danish Building research institute. The calculation takes into account the sun, personal production of heat and the buildings heat accumulative properties. Calculation is done using the tool Be06 (or other tools with the same kernel). It is a method based on monthly energy balances using monthly averaged weather data.

A dwelling which meets the energy requirements must be shown by the Be06 calculations to meet the building requirements expressed in the following formula:

Energy frame(std) =  $70 + 2200/A$  kWh/m<sup>2</sup>/year, where A is the heated floor area.

### 2.1.2. LOW ENERGY HOUSE DEFINITIONS ACCORDING TO THE DANISH BR

Within the Danish Building regulation two low energy classes have been defined. The definitions refer to the energy frame definition. The two classes are called low energy class 2 and low energy class 1, respectively. Where low energy class 1 refers to the strongest requirements.

#### *Low energy class2*

A dwelling can be classified as a low energy class 2 house if the needed energy for heating, ventilation, "cooling" and hot water use (as defined in the energy frame) does not exceed  $50 + 1600/A$  kWh/m<sup>2</sup>/year where A is the heated floor area.

#### *Low energy class1*

A dwelling can be classified as a low energy class 1 house if the needed energy for heating, ventilation, "cooling" and hot water use (as defined in the energy frame) does not exceed  $35 + 1100/A$  kWh/m<sup>2</sup>/year where A is the heated floor area.

### 2.1.3. OTHER LOW ENERGY HOUSE DEFINITIONS

#### *Passive house*

The so-called "Passive house" - concept has achieved widespread use in several countries in Europe. The term passive refers to the overall idea that the houses do not need a conventional heating system. The complete definition and much more about passive houses can be found at <http://www.passivhus.dk/>.

The key technical requirements are:

- Net space heating demand: Below 15 kWh per year per m<sup>2</sup> net area
- Total primary energy: Below 120 kWh per year per m<sup>2</sup> net area
- Infiltration: Air change rate below 0.60 h<sup>-1</sup> by pressure test with 50 Pa.

An alternative definition worth mentioning is "Självopvärmada hus" (self heating houses), where the idea is the same, namely that it is not necessary to install a conventional heating system and thus saved in installation costs can be used to make the house more energy efficiently. This definition doesn't require a special certificate from as the Passive House does Read the following link:

<http://www.landskronahem.se/index.php/content/view/198/155/>

#### *"Bolig+ huse"*

The Danish term "Bolig+ huse" can be translated to "Dwelling+ houses". In the years 2009-2011 a number of this type of houses will be designed, constructed, monitored and evaluated following a design competition. According to project website: <http://www.boligplus.org/> "Bolig+huse" are characterized by:



- Being energy neutral on a yearly basis (allowing for example for surplus electricity production in the summer sent to the grid and used in winter)
- The energy frame should be below that of Lowenergy class 1 (see above)
- Intelligent and service friendly housing
- Flexible in use over time
- Healthy indoor environment
- Housing fitted well in the local context

### 3. THE THERMAL ENVELOPE - GUIDELINES CONCERNING LOW ENERGY BUILDINGS

#### 3.1. PLANNING AND DESIGNING PHASES

##### 3.1.1. BUILDING

- Involve both architect and engineer from the start of the project
- Use a compact and simple building shape (e.g. without dormers)

Concentrate rooms with technical installations

- Remember space for ventilation ducts
- Prevent thermal bridging in constructions by using airtight constructions
- Plan to use solar thermal heating for domestic hot water and for space heating, if possible
- Decide insulation level so that the demand for heating and ventilation is the lowest possible
- Calculate an energy frame and check it for compliance with the building regulations
- Optimise the window constructions taking into consideration type, size, frame and shadowed areas
- Large window areas should face south as a main rule
- Calculate the dimensioning transmission loss and check it for compliance with the building regulations
- Use the shortest possible pipe lengths (for both cold and hot water and drain) and effective insulation of installations e.g. pipes, hot-water tank plus boiler

Examples of good thermal technology solutions - foundation.

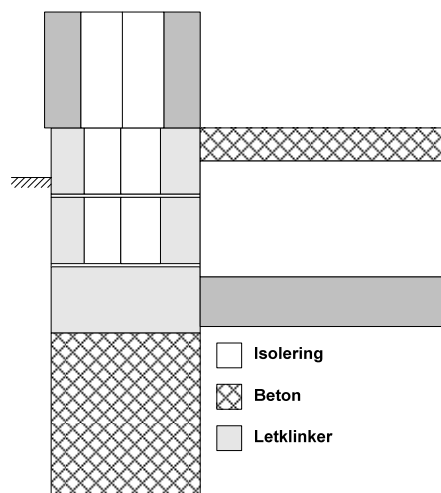

On this figure is shown a section of a joint between the outer wall/foundation/slab-on-ground. The insulation in the outer wall continues into the foundation.

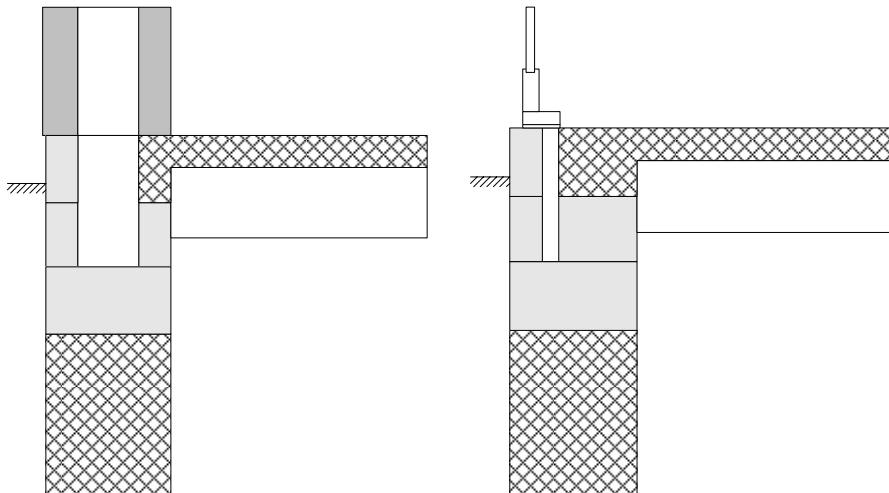

On these figures are shown sections of a joint between the outer wall/foundation/slab-on-ground respectively door/foundation/slab-on-ground. The insulation in the outer wall continues into the foundation.

Both solutions are in terms of thermal technology good as the thermal bridges are reduced heavily because of the big insulation in the foundation. The contractors have paid much attention to minimizing the thermal bridges in the foundations.

Examples of unnecessary insulation

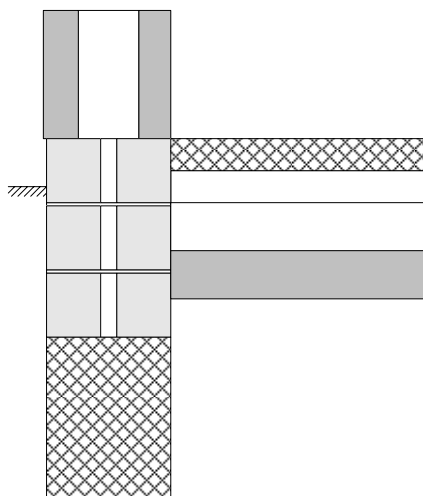

On this figure is shown a section of a joint between the outer wall/foundation/slab-on-ground with three insulated lightweight concrete blocks in the foundation.

Detailed analyses of different foundation have shown that it has no meaning to use an insulated third course and this can be replaced by a cheaper massive block.

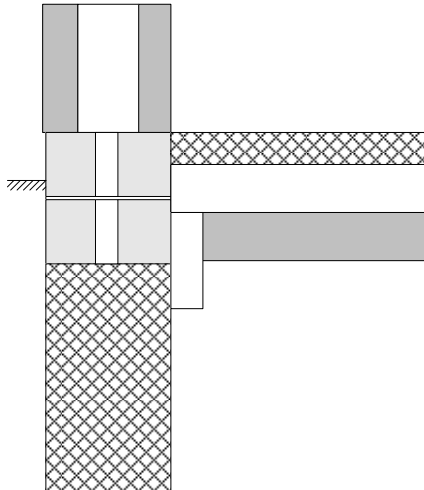

On this figure is shown a section of a joint between the outer wall/foundation/slab-on-ground with vertical insulation inside of the foundation.

Detailed analyses have shown that on well insulated foundations the inside vertical insulation has a very small influence on the linear loss coefficient.

### **3.1.2. VENTILATION WITH HEAT RECOVERY**

- Use the shortest possible ventilation channels, smooth internal surfaces, soft bending and air velocities not exceeding 3-4 m/s. Include possibilities for measurement and adjustments. Take precautions against fire and sound generation. Make sure there is good access for cleaning
- Place the ventilation aggregate plus the heat exchanger at the thermal envelope and heating surface inside the thermal envelope. Actual efficiency of the heat recovery should exceed 70%. The cabinet of the aggregate should be insulated (thermally and acoustically). The aggregate as well as components and ducts should be airtight. Openings for air supply and extraction should be placed so that short circuits are avoided. The electrical efficiency (SEL) should comply with the energy requirements in the Danish Building Regulations
- Provide fans with possibility for regulation and consider further possibilities in kitchen and bathroom
- Provide cooker hoods with high-efficiency suction. Cooker hoods should be provided with an effective filter

### **3.2. GENERAL**

- Make sure that electrical and sanitary pipes ductways in the thermal envelope are airtight and insulated
- Use energy efficient appliances and equipment

### **3.3. THE WORK IN PROGRESS**

- Schedule inspections in the course of the building process
- Check construction details, while it is possible e.g. that the insulation is placed continuously and thermal bridging prevented
- Check that ductways (through the vapour barrier) are correctly installed and sealed

- Get a Blower- Door test done to ensure airtightness of the building
- Make sure that the regulation of the ventilation is done, adjust the air supply and extraction and measure the electricity consumption
- Check that the pipes are insulated

In the region of Stenlose Syd the use material made of PVC is not permitted.

## 4. GUIDELINES CONCERNING AIRTIGHTNESS

### 4.1. WHY DESIGN AIRTIGHT BUILDINGS?

There is a direct connection between the airtightness of a building and the energy consumption. Furthermore the airtightness has a big effect on the indoor climate. There should be a certain ventilation rate in a building, but it is crucial to be able to control, where the air enters and where it exits. When the air leaks through openings e.g. at windows and assemblies, it can create a draught, which lowers the indoor air comfort level. At the same time moisture begins to form in the construction when cold and warm air meet. Condensation in the construction constitutes a risk of mould growth and results in poor indoor climate.

Experience shows that leaks are often found at installations, assemblies and transitions between outer walls, floors, roofs, windows and doors. Problems often occur when there is a change of construction material or change from one building part to another.

If the building has to be airtight, it is necessary incorporate airtightness right from the start of the project. A well organised design of the location of the vapour barrier and the principle for its unbroken continuity should be decided at the planning stage and should be clearly and unambiguously stated in the design material.

The advantages of building airtight can be summarised as follows:

- Energy saving
- Prevention of moisture damage
- Improved indoor climate (no draught/draught along the floor)
- Improved air quality (control of ventilation etc.)
- Improved sound insulation as direct airborne sound is discontinued

### 4.2. THE RULES IN THE DANISH BUILDING REGULATIONS

New buildings should be airtight. Under normal conditions the demand for air change per hour for dwellings is  $0.5 \text{ h}^{-1}$  corresponding to  $0.33 \text{ l/s m}^2$  with a room height of 2.4 m.

In normal buildings, the demand for air change through openings in the thermal envelope should not exceed  $1.5 \text{ l/s m}^2$  heated floor area at a pressure test of 50 Pa (average excess pressure and depression of the building). This corresponds to an infiltration rate of  $0.13 \text{ l/s m}^2$  at normal pressure. The local authorities can demand that a Blower-Door test should be made before issuing a permit to use the building.

In a conventional building, it is permitted that approximately 1/3 of the air change takes place through infiltration.

### 4.3. CHECKLIST – DEMANDS TO THERMAL ENVELOPE AND WORKMANSHIP

- The thermal envelope should be airtight
- The airtight layer can serve as vapour barrier
- The airtight layer should follow the thermal envelope and be placed continuously, including all assemblies and installation ductways. The vapour barrier should be placed no more than 1/3 inside the insulation material measured from the internal side, as non-compliance would increase the risk of condensation
- If the airtight layer also serves as a vapour barrier, it should be placed on the warm side of the insulation material
- Check construction details, while it is possible e.g. that the insulation material is placed continuously and thermal bridging is prevented

- Check that ductways (through the vapour barrier) is correctly installed and sealed
- Prevent thermal bridges in the constructions by using airtight constructions
- Make sure that electrical and pipe ductways in the thermal envelope are airtight and insulated
- A high degree of prefabrication can improve the airtightness, but also incorporate airtightness in the assembly method
- Overlapping of vapour barriers should be taped very carefully
- The materials used for airtightening should have the right properties - durability and it should not disintegrate over time
- A layer of crossed laths provides room for electrical cables etc. without destroying the vapour barrier
- If the vapour barrier is placed no more than 1/3 inside the construction, it is protected against perforation, as the electrical installations can be placed behind the covering.
- Make sure that the airtightening of joints around windows and doors is carefully carried out
- Remove the excess mortar from the bricklaying of the outer wall so no thermal bridge will develop
- Prevent thermal bridges at columns/beams by insulating these
- Test the airtightness e.g. by means of a Blower-Door test

#### **4.4. MEASURING OF AIRTIGHTNESS**

The airtightness of the thermal envelope is measured by establishing excess pressure in the building and then registering the amount of air necessary to maintain the air pressure. There are several different methods for establishing pressure difference over the thermal envelope. One method is to use a so-called Blower-Door test

The measurement is often carried out, when the thermal envelope is built and finished.

While the test is running, it is possible to trace the air leaks with an anemometer or with thermography.

## 5. THE HEATING SYSTEMS

### 5.1. HEATING SYSTEMS FOR GAS BOILERS

#### 5.1.1. PLANNING AND DESIGN PHASE

##### 5.1.1.1. Gas boiler and hot-water tank

- Involve a building services engineer from the start of the project
- Plan the placement of the meter and the pipes from meter to gas boiler
- Place the boiler inside the thermal envelope, e.g. in a utility room, if possible
- Include plans for any future outdoor and indoor natural gas pipes for other gas consuming appliances than the gas boiler e.g. gas oven, gas fireplaces, gas grill etc.
- Consider using solar heat as a supplement to the gas boiler
- Choose a gas boiler with the correct boiler efficiency

Note that:

- The minimum performance of a boiler should be smaller than the dimensioning heat loss of the house
  - The maximum performance of the boiler should be higher than the dimensioning heat loss of the house and together with the hot-water tank, it should cover the need for hot water
  - The boiler should have hot-water priority
  - The use of solar heat affects boiler efficiency
  - Make sure that the boiler efficiency meets the building regulation requirements - in Denmark 96% at full load and 104% at 30% partial load. A-labelled boilers fulfil these demands
- Check whether a climate control is installed (not necessary at floor heating)
  - Make sure that the size of the hot-water tank fits the demand for hot water
  - Make sure that the expansion tank has the proper size for the heating system

##### 5.1.1.2. Heating pipes and domestic water pipes

- Place the pipes inside the thermal envelope
- Make sure that the pipes have the proper size
- Determine the minimum insulation thicknesses
- Both architect and engineer should earmark space for the pipes and insulation

##### 5.1.1.3. Heating system: floor heating

- Floor heating gives the best utilization of energy in interaction with a condensation gas boiler
- Make sure that the floor heating is laid out with a floor heating circle in each room and also with individual control in each room
- Remember that floors with floor heating should have extra insulation in comparison with an ordinary floor (at least 260 mm insulation material in slab on floor to fulfil the minimum insulation requirement in the new Danish Building Regulations BR08)
- The control should be user-friendly for optimal utilization of the system



#### 5.1.1.4. Heating system: radiators

- The heating system should be a two-pipe installation
- Remember that the radiators should have a proper size in accordance with the building requirements concerning an average temperature of 55 °C (at outdoor temperature of -12 °C) and cooling of 15 °C
- A heating system with radiators should be adjusted to the condensing gas boiler
- Remember climate control

#### 5.1.1.5. Heating system: combination of radiators and floor heating

- See bullet points for floor heating and radiators
- For floor heating and radiators in combination there has to be climate control and shunt
- Consider supplementing floor heating with radiators in rooms where floor heating is embedded in concrete floors in order to utilize heat gains from solar radiation and occupants. Floor heating can be adjusted to keep a room temperature of 17-18 °C and the radiators can handle the rest

#### 5.1.2. EXECUTION

- Check while it is still possible that there is room for a vertically balanced vent
- Check while it is still possible that there is an outlet to the condensate from the boiler
- Remember to use materials for the condensate outlet that are resistant to a sour condensate
- Check while it is still possible that the gas pipes for other gas-using appliances are embedded in the floor and that there is space for gas sockets
- Check that heating pipes and domestic hot water pipes are insulated along the whole distance from the boiler to the floor heating pipes/tapping place
- Floor heating - make sure that the pipes from the distribution device to each loop are insulated correctly and all of them individually
- Floor heating - remember while it is still possible to check that there is correct edge insulation to prevent thermal bridges between the façade and the concrete floor (at least 30 mm and more)
- Remember room thermostats for regulating the temperature
- Make sure that the boiler and the floor heating system are adjusted

## **6. INDOOR ENVIRONMENTAL QUALITY**

### **6.1. OVERVIEW**

A range of guides are available that deal with noise, lighting, ventilation etc. These books are very specific about construction methods. SBI Direction 196: The Indoor Climate Guide gives an overview and precise guidelines for planning buildings with respect to the indoor climate on a holistic basis. It is therefore a tool for consulting architects and engineers in their daily work and may also be useful for construction firms, clients and authorities as well as parties in the building process. The guide has 34 chapters, which can be read independently of each other.

The chapters are grouped in seven parts as follows:

- Indoor climate
- Requirements and guidance
- Planning, design, construction and operation
- Design tools
- Impact of the outdoor environment
- Functional requirements for thermal envelope and layout
- Construction elements and components

### **6.2. GOOD AND POOR INDOOR CLIMATE**

The indoor air quality has a big influence as we spend most of our life indoors, at home and at work. The indoor climate should therefore be of such a character that it not only reduces the risk of discomfort, illness or symptoms, but also ensure pleasant conditions. A good indoor climate affects the concentration and working capacity positively.

In the Danish "The Indoor Climate Guide" the indoor climate is defined as:

- thermal conditions determined by air temperature, radiant temperature, air velocity and humidity in the air
- air quality described by the content of pollution as dust, humidity in the air, gasses and steam and therefore also smell
- static electricity described by the charging the people
- light conditions described by the light intensity, colour, contrasts and reflections
- sound conditions described by volume and frequency
- ion radiation described by radon concentration

### **6.3. GUIDELINES FOR GOOD INDOOR CLIMATE**

#### **6.3.1. POSITIONING OF THE BUILDING AND EXTERIOR INFLUENCE**

- proper positioning in relation to traffic (noise and pollution)
- plot without pollution or secure tightening against the ground
- special consideration to traffic noise (sound-proof windows, noise-proof outdoor valves, baffles)
- draining of the plot and safe removal of rainwater
- no garage or heavily polluting industry in the building

#### **6.3.2. BUILDING DESIGN AND ARRANGEMENT**

- Big room height and volume for each person
- 1-to-3-person rooms in office buildings
- effective sound proofing between rooms
- proper reverberant field
- pollution processes in separate rooms

- separate smoking areas
- windows that that can and may be opened
- sufficient daylight for all working areas
- effective and easy-to-use solar shading
- individual and adjustable lighting
- anti-glare and anti-reflective lighting, adjusted to computer screen work
- non down-hanging ceilings (gather dust)
- few open shelves and stores for paper
- leave space for cleaning
- leave space for technical installations

#### **6.3.3. BUILDING CONSTRUCTION AND MATERIALS**

- dry materials and cleaning of the building under construction
- big eaves with gutters
- proper ventilation of the constructions (roof, basement etc.)
- big thermal capacity
- durable and hard-wearing materials with low emission and without smell
- indoor climate labelled materials
- few hairy materials
- cleaning-friendly materials
- antistatic floor materials
- flooring adjusted the load for use
- hard-wearing flooring in educational establishment and day-care centres
- surface treated insulation materials

#### **6.3.4. VENTILATION SYSTEMS**

- natural ventilation (with a number of conditions)
- mechanical ventilation
- sufficient ventilation at least corresponding to the requirements in the Danish Building Regulations
- individual control of temperature and air quality
- low background noise
- clean ventilation components with low emission
- ventilation systems that are easy to use and adjust by the operating staff
- point extraction of processes e.g. (photo)copying and cooker hood in kitchens
- the valves for the intake air should be placed so the intake air is clean and with no contact with the return air
- no recirculation of air from other rooms
- valves for the intake air should provide a good blend of the air

#### **6.3.5. HEATING SYSTEMS**

- individual regulation of temperature
- radiators or convectors should be placed so that downdraught is prevented
- radiators or convectors should be easy to clean

#### **6.3.6. APPARATUS**

laser printers in frequent use should be placed outside rooms for occupancy extraction at the photocopying machine  
no combustion without vent to the outdoors

no water evaporation

### **6.3.7. OPERATION AND MAINTENANCE**

quick reaction and follow-up on complaints of the building and the indoor air quality

quick and effective repair of water damages

maintenance of the thermal envelope (particularly roof, gutters and downpipe)

training of operating staff in using the building and its systems

maintenance plan for ventilation systems with emphasis on cleaning

operational strategy for ventilation adjusted to the actual use of the building

forced ventilation after building to use and under and after renovation

efficient cleaning programme with periodic thorough cleanings

### **6.3.8. INDOOR CLIMATE PROBLEMS**

#### *Discomfort caused by the indoor climate*

Many human beings are often bothered by draught, cold, high temperatures and noise in their workplace. A study of dwellings showed that about 25% of the occupants in multi-storey buildings were bothered by noise from neighbours, about 20% by noise from the street. No studies are available that demonstrate hazardous effects on human beings at the intensities of the audible sound that normally occurs in dwellings and other rooms for occupancy. On the other hand even weak sounds may cause discomfort; the important are: difficulty in hearing and perceiving what is going on, disturbed sleep, affected concentration capacity and mood.

#### *Indoor climate risk factors*

With regard to symptoms there are many unresolved questions for example of how they develop, what occurs in the body, and what exposures can give rise to what symptoms. Even in buildings, where many persons present symptoms, the reason is rarely that the measured exposures are above what requirements and norms stipulate. The symptoms must therefore be caused by the combined action of a number of minor exposures.

This emphasises the importance of reducing the individual undesired exposures as much as possible. The identified exposures are associated with building-related conditions, such as the choice and the layout of the building, building materials and furniture, how buildings are operated and maintained as well as what activities take place in the building. At the same time it has been demonstrated that also psychological conditions affect whether symptoms arise and how often they occur.

### **6.3.9. THE BUILDING AND THE PLOT**

#### 6.3.9.1. The positioning and orientation of the building

The layout and location of the plot as well as the building's positioning on the plot may affect the climate in the immediate vicinity of the building and thus the indoor climate within the building. When the plot is chosen and the building positioned, the following must also be considered: soil and wind conditions, insolation, potential view, noise problems etc.

Check list

Consider the

- Position and layout of the building based on wind conditions
- Wind impact on smoke discomfort and supply/exhaust from ventilation systems
- Position of gate and entrance in relation to wind effect
- Building as a noise shield
- Solar radiation and insolation on the façade depending on its orientation and time of day and year

- Layout of surrounding outdoor areas, including shelter from wind, noise etc.
- Planting that should take allergic persons into consideration
- Entrance and entrance area

#### *The effect of building layout on the indoor climate*

Already at the planning stage of the building, many questions of great importance for the indoor climate are decided. The building layout affects the heating demand and should be seen in relation to the energy frame of the Danish Building Regulations. Moreover the building's geometry, orientation and heat accumulation, window area, construction and type of glazing as well as unheated conservatories should also be included. The building layout is therefore a significant basis for indoor climate considerations.

#### *Housing*

The following aspects of housing are important for the indoor climate:

- Orientation of the rooms in relations to access road, view and recreational areas
- Orientation of rooms for occupancy that provides the possibility of sun

#### *Daylight and view*

The possibility of achieving good daylight conditions is largely determined by the ratio between the glass area and the room area. At a normal room height of 2.3-2.5 m, a room depth of about 4 m would be reasonable in a room illuminated from one side only. Daylight in the room further depends on the daylight transmittance of the glazing and the reflectance from the room surfaces

#### *Orientation of rooms for occupancy*

The building layout should allow the sun to heat the room during cold periods and facilitate sun shading and airing of excess heat during warm periods. Windows oriented towards southeast/south/southwest are well-suited to absorb passive solar heat during the part of the year that requires heating. In summer when the sun is low in the sky, the same positioning of windows can be shaded by various means like fixed or mobile solar shadings such as porch roofs and over-hangs or awning and venetian blinds

#### *Glass extensions*

New types of glazing with increased transmittance are continuously being developed

#### 6.3.9.2. Outer walls

##### *The outer walls as thermal envelope*

The outer wall is composed of several layers with different functions and characteristics. When talking about the indoor air quality, it is primarily sound and heat insulation, heat capacity and the moisture properties that are relevant. The interior surfaces should be able to withstand cleaning agents well, easy to maintain, facilitate the assembly of furniture and equipment and resistant to the mechanical impact of blows and bumps.

#### *Guideline*

- reproduction of sound
- noise insulation
- heat insulation
- cold wave and radiation
- heat capacity
- valves for airing
- tightening at doors and windows

#### 6.3.9.3. Windows and solar shading

- Requirements of the authorities
- daylight admittance
- free passage at the rescue window
- heat insulation
- sound insulation, if noise exceeds 55 dB
- fresh air through windows that can be opened
- view through windows
- good materials and technically good workmanship
- water and moisture conditions

#### *Guidelines*

##### Windows

- cold wave and draught
- radiation
- insolation
- airing
- ventilation
- daylight admittance
- transmittance
- light distribution
- glare
- view
- noise from outside
- tightness
- cleaning
- maintenance

##### Solar shading

- shading factor
- insolation
- indoors/outdoors
- individual/automatic regulation
- daylight factor
- maintenance

#### 6.3.9.4. Guideline for Heating Systems

- design principle: radiators, convectors, floor heating, ceiling heat, radiation heat
- dust, cleaning, conditions for heating
- asymmetrical radiation
- noise
- regulation, understandable, simple
- lowering the temperature in the weekend can cause low operational temperature

#### 6.3.9.5. Guideline for Ventilation Systems

##### *Choice of systems*

- ventilation system and performance
- simple and easy- to-use functions
- point extraction at different places with point pollution areas

##### *Draught*

- furnishing

- supply air temperature and velocity
- balance between supply and exhaust air
- outdoor air valves: design and placement
- outdoor air valves: regulation
- supply air valves: design and placement
- downdraught

#### *Indoor air quality*

- the amount of air adjusted to pollution from materials, furniture and equipment, persons and other activities
- positioning of the supply/exhaust air valves
- filtration of the outdoor air
- infiltration of pollution from the ground (e.g. radon, organic gasses etc,)

#### *Mikroorganism*

- air inlet position in relation to the ground and sources for Legionnaires' bacteria
- water and condensate on filter
- cold surface, condensate and microbial growth
- stirring up of dust from the floor
- humidify the air without risk
- clean-out door
- sound-proofing materials and fibre liberations
- filters and smell

#### *Noise*

- street noise and supply air valve design
- noise reduction in the system
- low frequency noise
- supply air valve design with reduction of noise

#### *Performance*

- cleaning of channels and components during the building process
- removal of protective measures on channels and components
- tightness

#### *Operation*

- operational strategy
- report at delivery
- maintenance report
- user manual
- control and maintenance
- smelling filters
- adjustment of the regulating system.

## 7. GUIDELINE FOR THERMAL COMFORT IN RESIDENTIAL HOUSES

### 7.1. FUNDAMENTALS

Human body continuously tries to achieve the thermal equilibrium with the environment by means of behavioural and physiological mechanisms. The terms of balance equation can be expressed by means of a certain number of variables, related to:

#### *subject behaviour*

- M: activity level;
- $I_{cl}$ : Thermal resistance of clothing
- the microclimate -
- $t_a$ : air temperature;
- $p_a$ : partial pressure of water vapour (humidity of the air);
- $v_a$ : air velocity;
- $t_r$ : mean radiant temperature, defined as the weighted average of surface temperatures of internal surfaces (walls, floor, ceiling and windows) of the room. Weights are represented by the view factors of surfaces in respect of the position of the person. A good approximation (in most of the situation in dwellings) can be achieved calculating each weight as the ratio between the area of the single element (wall or window) and the sum of areas of all surfaces surrounding the room.

#### *the subject physiology, depending by the human body thermo regulating systems*

- $t_s$ : skin temperature;
- $Q_{ev}$  energy losses due to evaporation through the skin

#### *Remarks*

- Activity level (M) and dress code ( $I_{cl}$ ) are the boundary conditions for designing thermal comfort conditions.
- Normal values for dwellings can be considered as:
- $M = 1 - 1,5$  Met (58 - 87 W/m<sup>2</sup>);
- $I_{cl} = 0,7 - 1$  Clo (0,105 - 0,155 m<sup>2</sup>°C/W)
- Designers can only act on 4 out of 8 variables of thermal comfort: users' behaviour and/or their physiology can strongly affect the success of the designers' job both in terms of user satisfaction and in terms of building energy efficiency.
- Physiological variables can seldom cause user dissatisfaction even in well designed buildings: the risk that this happens is statistically evaluated around 5% (Fanger's theory).

#### *Consequences: User/Systems interaction*

- The impossibility of influencing the local climate conditions is often one of the reasons of complaint by the occupants: that is perceived as a personal limitation, strongly affecting the user acceptance.
- Users are more tolerant of deviations in indoor climate if it can be controlled by themselves.
- Control systems connected with visualisation systems play a very important role in giving the users the objective measure of building environment conditions.
- Simplicity and transparency of the user/system interface is of great importance, and one of the main requests is that the control system



responds to user needs and allows changing a condition if it is perceived as unsatisfactory, with rapid feedback.

## 7.2. DESIGN AND PLANNING

Rigorous evaluation of thermal comfort in buildings requires the evaluation of indexes as PMV (Predicted Mean Vote) and PPD (Predicted Percentage of Dissatisfied) defined by Fanger's theory. The evaluation method is defined in ISO 7730 by means of tables and graphs that correlate the environmental parameters with PMV and PPD.

Thumb rules can be definitely adopted in designing houses. According to these rules, acceptable values of environmental parameters are:

- o  $t_a$  (air temperature): 20 - 22°C in winter; 24 - 26 °C in summer
- o RH (relative humidity): 40 - 50% in winter; 50 - 60% in summer
- o  $v_a$  (air velocity): 0,10 - 0.15 m/s in winter; 0.25 m/s in summer
- o  $t_r$ : mean radiant temperature in winter is in general lower than  $t_a$ . It shouldn't be lower than ( $t_a - 3$ ) °C.

Looking at thermal comfort, designers should than take care of the following issues:

- Glazed surfaces represent a critical element from the thermal comfort point of view because of their lower thermal resistance. During winter the surface temperature of these elements are lower than surface temperature of opaque elements.
- Glazed surfaces affect thermal comfort in following way (see table 1):
  - o mean radiant temperature is reduced in winter, increased during summer
  - o radiative thermal exchanges between surface and occupants are increased
  - o convective (descending) air movements are inducted by lower surface temperatures, strongly affecting thermal comfort conditions close windows during winter
  - o radiant asymmetry and localized discomfort conditions are generated: close to a window reached by direct solar radiation, PMV can increase up to 2.2 point in respect to a undisturbed conditions. This value can decrease to 0.6 point if high performance (Low Emissivity) glasses are adopted.
- The local temperature control i.e. by means of thermostatic valves on radiators can improve thermal comfort and not only energy saving.
- Solar shading is important not only for thermal but for visual comfort as well. External structure, as overhang, can provide necessary shading factor during summer on south facades. Other facades need vertical shading. Internal semi transparent shading (curtains, venetians, and so on) can be useful if they can provide a consistent reflecting factor (>0.5).
- Ventilation is key factor for Indoor Air Quality but for thermal comfort in summer as well. Especially in well insulated buildings, as they are those to be realized in Stenlose, overheating conditions can easily occur even in mid seasons. Provide necessary ventilation (mechanical or natural) during summer and even during sunny days in mid season in order to contrast overheating. Ventilation rate for this purpose, in Stenlose, should vary between 0.5 and 1 ach/h.

Table 1: Contributions due to above mentioned factors during a sunny winter day for a person placed at 1 meter from window with a typical winter cloth.

Glass type	$\Delta$ PPV Radiant asymmetry	$\Delta$ PPV Direct radiation	$\Delta$ PPV Convection	$\Delta$ PPV Total
Clear 3 mm	+35	-30	+8	+13
Clear 3 mm + Air 13 mm + Clear 3 mm	+28	-25	+6	+9
Clear 3 mm + Argon 13 mm + LoE 3 mm	+8	-7	-	+1
Selective 3 mm + Argon 13 mm + Clear 3 mm	+12	-5	-	+7

Table2: Summary of interaction between building systems and thermal comfort

System	Component	Feature	Affected parameter	Influence on other comforts involved
Heating	Heating production	power, efficiency	$t_a, t_r$	
	Heating distribution	type, efficiency, placement	$t_a, t_r, RH, v_a$	
Ventilation	Vents, fans	flow rate, placement,	$t_a, RH, v_a$	High on IAQ
	Heat recovery	efficiency	$t_a$	High on IAQ
Envelope	Walls, floor, ceilings	Uvalue	$t_a, t_r$	
	Windows	Uvalue Gvalue Orientation	$t_a, t_r$ Radiant Asymmetry	High on Visual
	Windows	Air tightness	$t_a, v_a$	Moderate on IAQ
	Shading	shape, placement	$t_a, t_r$ Radiant Asymmetry	High on Visual

### 7.3. EXAMPLE OF CALCULATION ON A REFERENCE BUILDING IN STENLOSE

The influence of some building system components, as shading and ventilation systems on thermal comfort, has been calculated on a reference building in Stenlose by mean of dynamic simulation performed with TRNSYS code. Detailed report on this task can be found in the appendix of these Guidelines.

Results show that the reference building present good winter thermal comfort conditions and a moderate risk of overheating ( $T_i > 27.5$  °C) during summer: 11% in Living Room and 13% in the Kitchen. Improving the ventilation rate from the foreseen 0.53 ach/h to 2.0 ach/h and the solar shading to 80% when the indoor temperature exceed 24°C allow to reduce these risk to respectively 0.6% and 3.6%.

Following table shows the distribution of windows on different orientations of reference building:

Orientation	Total Area (m <sup>2</sup> )	Windows Area (m <sup>2</sup> )	% windows
SW	39.8	12.65	31.8
NW	42.4	6.77	16.0
NE	39.5	6.71	17.0
SE	39.5	7.41	18.7
Total	161.3	33.5	20.8

## 8. GUIDELINES FOR DAYLIGHTING AND VISUAL COMFORT IN RESIDENTIAL HOUSES

### 8.1. OVERVIEW

In residential buildings daylight can be provided mainly via windows and glazed doors, as well as (less commonly) via skylights and other forms of toplighting. These glazed openings are collectively referred to as "fenestration." The placement, design, and selection of materials for fenestration are extremely important and can tip the balance between a high performance and low performance building. Fenestration impacts building energy efficiency by affecting cooling loads, heating loads, and lighting loads. Visual comfort is strongly affected by the window location, shading, and glazing materials. Well-designed windows can be a visual delight. But poorly designed windows can create a major source of glare. Thermal comfort can also be compromised by poor fenestration design.

Poorly insulated windows add to a winter chill or summer sweat, while windows with low U-values keep glass surface temperatures closer to the interior air temperature, improving thermal comfort. In addition, east-west windows and unshaded south windows can cause excessive cooling loads. And although windows and skylights provide opportunities for natural ventilation, they must be designed to ensure a safe, secure, and easily maintained facility.

### 8.2. BENEFIT OF DAYLIGHTING

#### ***Energy Savings***

Daylighting can save energy and reduce peak electricity demand if electric lights are turned off or dimmed when daylight is abundant. Daylighting per se, however, saves no energy unless the electric lighting system is appropriately controlled. To be effective, daylighting must be thoughtfully designed, avoiding glare and overheating.

#### ***Better Light***

Daylight provides the highest quality light source for visual tasks. It enhances the color and visual appearance of objects, and helps to see small details better.

#### ***Connection to Nature***

Daylight provides a connection to the natural world by supplying information on time of day, season, and weather conditions.

#### ***Improved Health***

Views provided by windows contribute to eye health by providing frequent changes in focal distance, which helps to relax eye muscles. Daylight, whether associated with a view or not, may also reduce stress.

### 8.3. BASIC DAYLIGHTING PRINCIPLES

The following six principles, described in more detail below, provide fundamental guidance in designing daylight.

1. Prevent direct sunlight penetration into glare-sensitive activities spaces.
2. Provide gentle, uniform light throughout space.
3. Avoid creating sources of glare.
4. Allow users to control the daylight with operable louvers or blinds.
5. Design the electric lighting system to complement the daylighting design, and inform users about maximum energy savings through the use of lighting controls.
6. Plan the layout of interior spaces to take advantage of daylight conditions.

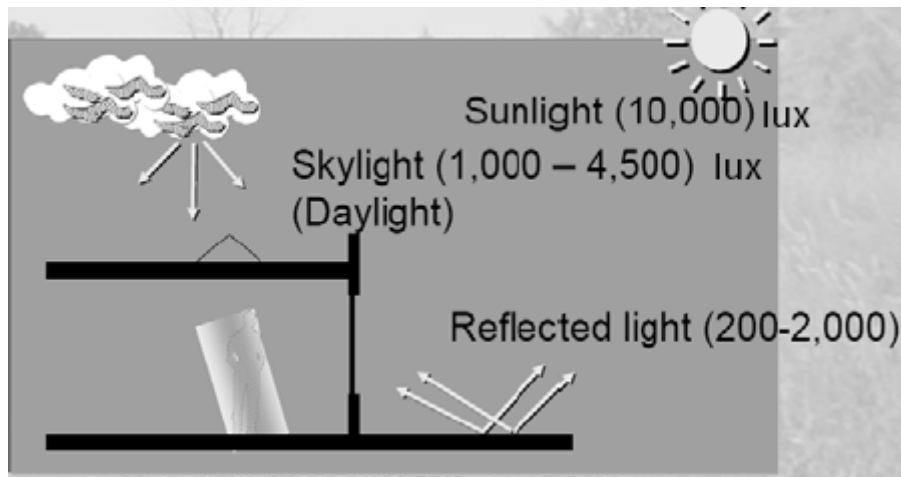

### 1. Prevent Direct Sunlight Penetration

Direct beam sunlight is an extremely strong source of light, providing up to 10,000 lux of illumination. It is so bright, and so hot, that it can create great visual and thermal discomfort.

Good daylighting design typically relies on maximizing the use of gentle, diffuse daylight, coming from the blue sky, from clouds, or from diffused or reflected sunlight, and minimizing the penetration of direct beam sunlight.

The best daylighting designs are initiated early in the design process of new buildings. The first step in good daylighting design is the thoughtful orientation of the buildings on the site and orientation of the fenestration openings.

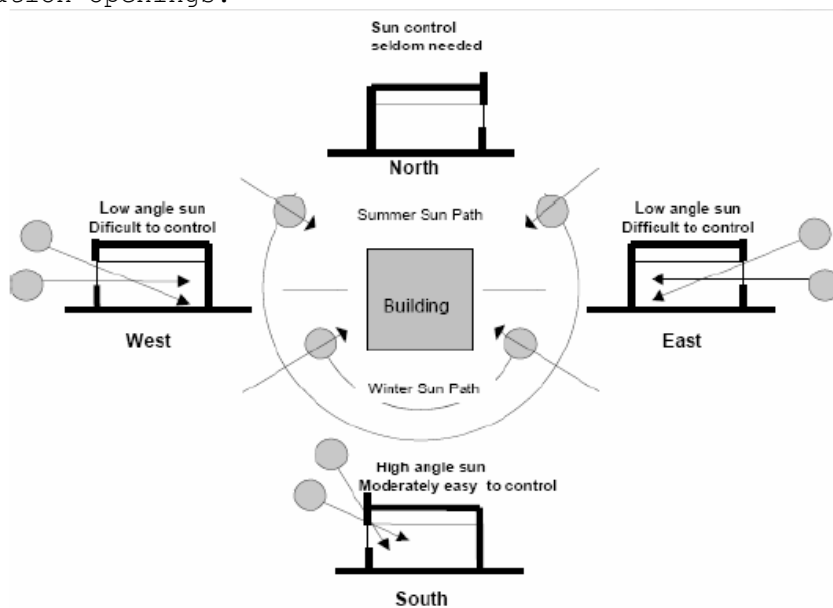

It is easiest to provide excellent daylight conditions using north-facing windows, since the sun only strikes a north-facing window in early morning and late evening during midsummer.

South-facing windows are the next best option because the high angle of the south sun can be easily shaded with a horizontal overhang.

East- and west-facing windows are more problematic because when the sun is low in the sky, overhangs or other fixed shading devices are of limited utility.

Any window orientation more than 15° off of true north or south requires careful assessment to avoid unwanted sun penetration.

## **2. Provide Gentle, Uniform Illumination**

Daylight is most successful when it provides gentle, even illumination throughout a space. Evenly diffused daylight will provide the most energy savings and the best visual quality.

The best approach is to provide daylight from two sides of a space.

The most challenging condition is a room with windows on only one side.

There, daylight illumination levels will be very high right next to the window and drop off quickly.

Daylight can most easily be used to provide a base level of illumination throughout a space, referred to as the ambient illumination, which is often on the order of 200 to 300 lux.

Individual work areas can then be highlighted with electric task lights to bring the illumination levels in specific areas to higher task level requirements, such as 500 or 750 lux.

Alternatively, if the daylighting fenestration area is increased to provide the higher task illumination for most of the day, the electric lighting energy savings will be maximized while heating costs may increase, moreover some problem of overheating during summer could appear. The best daylighting designs balance these energy costs with the desired lighting quality.

### ***Walls, Ceilings, And Other Reflective Surfaces***

- The arrangement of reflective surfaces that help to distribute the light are just as important as the arrangement of daylight openings for providing gentle, uniform illumination. Whenever possible, place daylight apertures next to a sloped or perpendicular surface so the daylight washes either a ceiling or a wall plane, and is reflected deeper into the space.
- Walls and ceilings are part of the daylighting design. For greatest efficiency and visual comfort, they should be painted white, or a very light color. Even pastel-colored paint absorbs 50% of the light that strikes it, correspondingly reducing daylight levels. Saturated colors should be used only in small areas, for accents or special effects.
- Advanced daylighting designs take advantage of additional exterior and interior reflecting surfaces to shape the distribution of daylight in the space. Light-colored walkways and overhangs can help reflect daylight.

## **3. Avoid Glare**

Excessively high contrast causes glare. Direct glare is the presence of a bright surface relative to the surroundings (for example, a bright diffusing glazing or direct view of the sun) in the field of view that causes discomfort or loss in visual performance. Eliminate glare by obscuring the view of bright sources and surfaces with blinds, louvers, overhangs, reflectors, and similar devices.

Placing daylight apertures next to reflective surfaces reduces glare and distributes the daylight more evenly. It brightens interior surfaces to reduce their contrast with the bright glazing surface.

Blinds or drapes can also reduce contrast by controlling the amount of brightness at the windows, and diffusing the light.

Punched windows (simple holes in the middle of a wall) represent the worst scenario for glare and are not recommended.

#### **4. Provide Control of Daylight**

Daylight is highly variable throughout the day and the year, requiring careful design to provide adequate illumination for the maximum number of hours while contributing the least amount possible to the cooling load. The ideal daylighting design would have variable apertures that respond to changes in the availability of daylight. The apertures would become smaller when daylighting is abundant and larger on cloudy days or at times when daylight is less available. The principal means of control is through the use of shades or blinds located inside or outside the window.

##### *Interior Shading Strategies*

- Interior shading devices for windows reduce solar heat gain somewhat (by reflecting solar gain back out through the glazing) but are most effective at controlling glare.
- The most common interior glare control devices are horizontal mini-blinds, vertical blinds, shade screens, and curtains.

##### *Landscaping*

- Daylight is also affected by obstructions on the site, such as trees and other buildings.
- Landscaping can serve an important shading and sun control function if it is strategically placed or incorporated into a trellis device. Deciduous trees and vines positioned to the south of a window are extremely useful for providing shade during overheated summer months while admitting more sun in areas with cold or overcast winters.

#### **5. Integrate with Electric Lighting Design**

The daylight and the electric light systems must be designed together so they complement each other to create high quality lighting and produce energy savings. This requires an understanding of how both systems deliver light to the space.

##### *Color*

- Daylight is a "bluer" light source than most electric lighting. Fluorescent lights that are designed to match the color of incandescent light will appear yellow in comparison with daylight.
- The color temperature of a light source is a number that describes its relative blueness or yellowness. When mixing daylight and electric light, most designers choose fluorescent lamps in the blues range, with a color temperature of 3500K to 4100K or even higher.

##### *Controls*

- The electric lighting should be circuited and controlled to coincide with the patterns of daylight in the space, so that the lights can be turned off in areas where daylight is abundant and left on where it is deficient.

#### **6. Plan the Layout of Interior Spaces**

Successful daylighting designs must include careful consideration of interior space planning. Since daylighting illuminance can vary considerably within the space, especially with sidelighting, it is important to locate work areas where appropriate daylighting exists. Perhaps more importantly, visual tasks should be located to reduce the probability of discomfort or disabling glare. In general, work areas should be oriented so that daylighting is available from the side or from above.

- Facing a window may introduce direct glare into the visual field, while facing away from a window may produce shadows or reflected glare.

- The basic sidelighting pattern provides windows on one or more walls of the space.
- The depth of daylighting penetration from vertical windows is largely dependent on the height of the window head (that is, the top of the window). For a simple sidelighting scheme, a rough rule of thumb is that useable daylight will be available about  $1.5 \div 2$  times the window head height.



## **9. USER INFLUENCE**

### **9.1. GUIDELINES FOR THE USERS**

#### **9.2. INTRODUCTION**

It has been often verified that the user influence on the energy performance of buildings (low-energy or standard) has a significant impact. For identical houses this can lead to a factor 3 in energy consumption. This means that, even for a low-energy dwelling, such as the one you are currently designing, the users has the ultimate influence on what energy consumption (heating and electricity) they will have to pay for. An energy efficient behaviour also tends to influence the water consumption and as the price of water is significant this is another motivation for the user to adopt the most energy efficient behaviour.

It is therefore as important to write specific user guidelines for energy efficient user behaviour as it is to design a low-energy dwelling correctly.

#### **9.3. UNDERSTANDING THE BUILDING**

The user guidelines should include a description of the dwelling covering the overall energy saving concept and the implemented technologies (windows, insulation, air-tightness and ventilation system, solar heating system, heat pump, controls,...). The users need to understand how their home is supposed to work ideally to allow them to act correctly to make this happen. Simple diagrams should be used to present the concept and technologies.

Some basic issues should be covered:

- temperature levels (rooms and hot water)
- ventilation (how to live in a home with mechanical ventilation)

Correct behaviour should be presented in bullet form - preferably in a separate "textbox" that can be cut out and placed in a visible location in the home as a constant reminder.

#### **9.4. USE OF THE BEMS SYSTEM**

The Building Energy Management System allows the user to keep an overview of electricity and heating energy consumption and to set up schedules for lowering set-point temperatures and for switching on and off electrical equipment and lamps. The selected BEMS system will be accompanied by its own user guide, but this will mainly focus on setting it up correctly and making it work. A short easy to use guideline for the users on how to use the BEMS system for energy efficient automatic/intelligent control of their home is therefore needed

The BEMS system will allow for remote metering of all energy flows in the system and energy use in the individual buildings. All the BEMS systems used in Stenlose Syd will automatically upload the monitored data to Elsparefondens website "Min Bolig" which will be a useful tool for the users to follow the energy consumption of their own houses and to react to excessive energy consumption immediately.

The user guidelines shall include a paragraph on how to interpret the monitored data and how to respond to these, if necessary.

#### **9.5. SUGGESTED LIST OF CONTENT OF THE USER GUIDE**

To cover the above issues the list of contents could include these headlines:

- Introduction - on the importance of energy efficient behaviour
- Your energy efficient home - concept and technologies
- How to run your house
- Use the BEMS system for energy intelligent automatic control of your home.

## 10. APPENDIX

### 10.1. DYNAMIC SIMULATION ON HOUSE TYPE LIND OG RISØR - AVR165

#### 10.1.1. DESCRIPTION OF SIMULATION MODEL

Dynamic simulation were performed by means of TRNSYS code. TRNSYS allows to describe building in detail on:

- Building orientation and shape
- Thermal characteristics of building envelope (walls, windows)
- Envelope characteristics in terms of: infiltrations, solar gains
- Features of plants (Heating, ventilation, cooling)
- User profiles (presence of persons, use of lights and appliances)

Simulations have been realized on hourly basis for the duration of one year.

Building was divided into 6 zones according to the following figure.

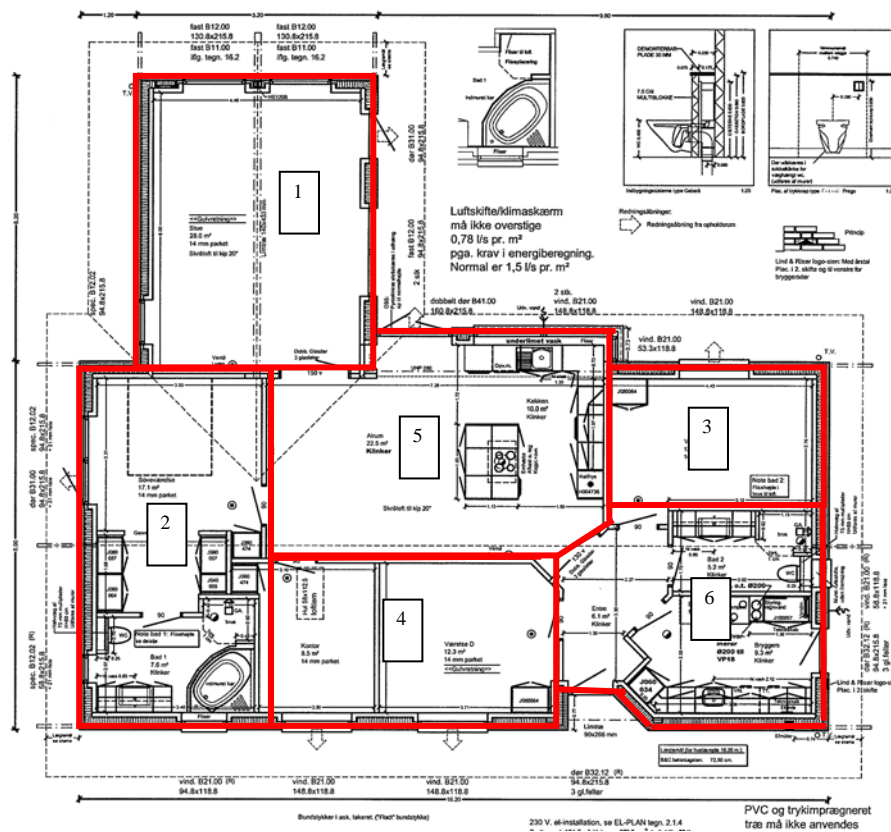

1. Living
2. Bedroom 1
3. Bedroom 2
4. Studio
5. Kitchen
6. Facilities

Here the main characteristics of building envelope

External wall	132.3 m <sup>2</sup> 0.19 W/m <sup>2</sup> K
External through attic	14.5 m <sup>2</sup> / 0.12 W/m <sup>2</sup> K
Floor (inside dimension)	142.3 m <sup>2</sup> / 0.09 W/m <sup>2</sup> K
Roof (horizontal ceiling)	99.8 m <sup>2</sup> / 0.1 W/m <sup>2</sup> K
Roof (slope ceiling)	68.3 m <sup>2</sup> / 0.1 W/m <sup>2</sup> K

Windows characteristics are described in following table.

	Vinduer og yderdøre	Antal	Orient	Hældn.	Areal (m <sup>2</sup> )	U (W/m <sup>2</sup> K)	b	Ht (W/K)	FF (-)	g (-)
		23			41.52		CtrlClick	37.8615		
1	Hoveddør 95x216 (Listral K) *	1	N	90	2.1	1.14	1.00	2.394	0.51	0.58
2	Vindue 149x119 * (vær. D + kontor)	2	N	90	1.83	0.88	1.00	3.2208	0.7	0.6
3	Vindue 95x119 (Listral K) * (bad 1)	1	N	90	1.17	0.96	1.00	1.1232	0.63	0.58
4	Speciel 59x216, opl.(Listral K) * (bad 1)	1	Ø	90	1.32	1.02	1.00	1.3464	0.62	0.58
5	Terrassedør 95x216 * (sovev.)	1	Ø	90	2.1	1.01	1.00	2.121	0.6	0.6
6	Speciel 95x216, opl. * (sovev.)	1	Ø	90	2.1	0.93	1.00	1.953	0.7	0.6
7	Speciel 95x216, opl. * (stue)	1	Ø	90	2.1	0.93	1.00	1.953	0.7	0.6
8	Højsparti 131x216. * (stue)	2	S	90	2.88	0.68	1.00	3.9168	0.86	0.6
9	Skråvinduer 131x??cm * (stue)	2	S	90	0.86	0.83	1.00	1.4276	0.74	0.6
10	Terrassedør 95x216 * (stue)	1	V	90	2.1	1.01	1.00	2.121	0.6	0.6
11	Højparti 95x216 * (stue)	2	V	90	2.1	0.72	1.00	3.024	0.83	0.6
12	Terrassedør 161x216 * (alrum)	1	S	90	3.54	1.12	1.00	3.9648	0.58	0.6
13	Vindue 149x119 * (køkken)	2	S	90	1.83	0.88	1.00	3.2208	0.7	0.6
14	Vindue 53x119 * (køkken)	1	V	90	0.67	1.13	1.00	0.7571	0.49	0.6
15	Vindue 149x119 * (vær. E)	1	S	90	1.83	0.88	1.00	1.6104	0.7	0.6
16	Vindue 59x119 (Listral K) * (bad 2)	1	V	90	0.74	1.09	1.00	0.8066	0.52	0.58
17	Bryggersdør 95x216 (Listral K) *	1	V	90	2.1	1.14	1.00	2.394	0.51	0.58
18	Loftlem	1	0	0	0.65	0.78	1.00	0.507	0	0
-19										

Here the main characteristics of ventilation and infiltration

Ventilation:	
air flow	0.36 l/s m <sup>2</sup>
heat recovery efficiency	90%
energy for air movement (fan)	0.8 kJ/ m <sup>3</sup>
Infiltration	
air leakage	0.09 l/s m <sup>2</sup>
Internal heat gain	
persons	1.5 W/m <sup>2</sup>
appliances	3.5 W/m <sup>2</sup>

### 10.1.2. RESULTS: ENERGY

Following table reports the results of simulation in terms of energy consumption of the all building and of single zone.

	Total	1	2	3	4	5	6
Heating demand (kWh/y)	4260	1572	917	338	525	451	458
Heating demand (kWh/m <sup>2</sup> y)	25.9	34.9	31.1	22.5	21.9	16.1	19.7

Heating Pump COP: 3

Here the results of Energy demand for DHW and fans

Energy demand for DHW (kWh/y)	2157
Energy demand for DHW (kWh/m <sup>2</sup> y)	13.10
Energy demand for fans (kWh/y)	354.4

The simulation of Solar Collectors plant for production of DHW (2 m<sup>2</sup>) showed a solar fraction of 0.39.

Here the calculation of the Overall Primary Energy of the analyzed building:

	(kWh/y)	(kWh/m <sup>2</sup> y)
Primary Energy Heating	3552	21.6
Primary energy DHW	1656	10.1
Primary energy for fans	886	5.4
Total Primary Energy	6093	37.0

### 10.1.3. RESULTS: THERMAL COMFORT

The results of Thermal comfort analysis on the building are reported in the following graphs:

The monthly maximum temperature was reported for 3 rooms: Living, Bedroom1 and Kitchen.

The graph shows as during July and August the maximum temperature exceed 30 degree in Living Room and Kitchen.

Following graphs present a quantitative evaluation of this summer discomfort risk, by means of Cumulative Frequency Curves: in the kitchen the temperature exceeds 27.5°C during the 13% of the time; in the Living it happens for the 11%.

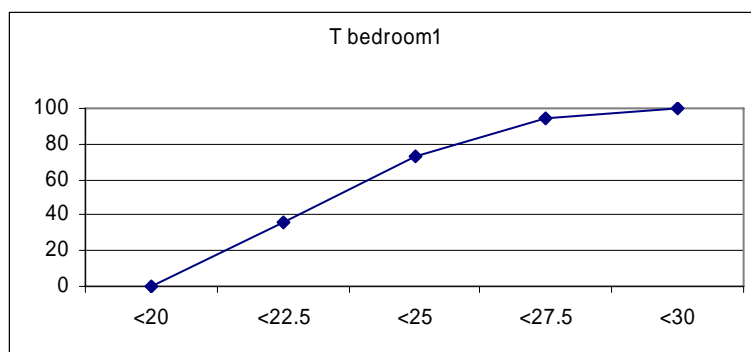
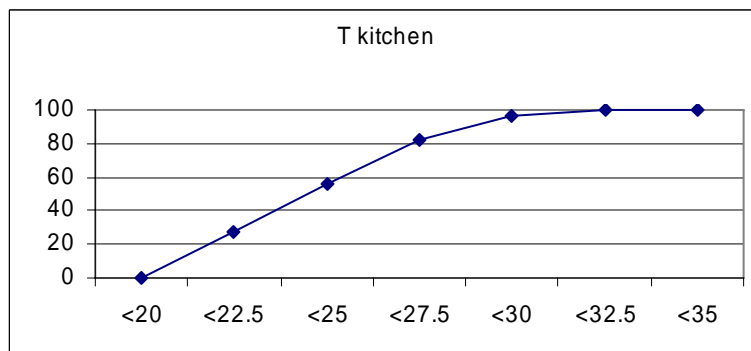
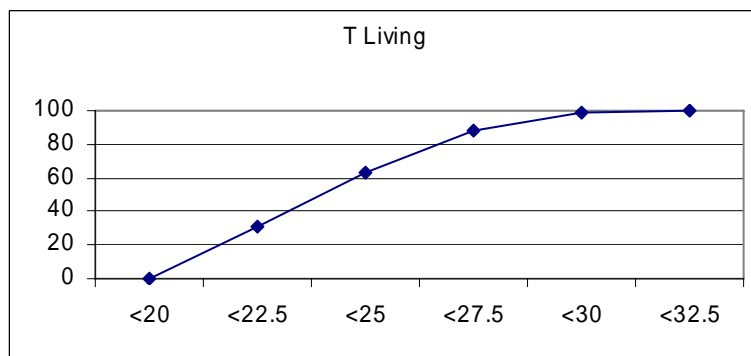
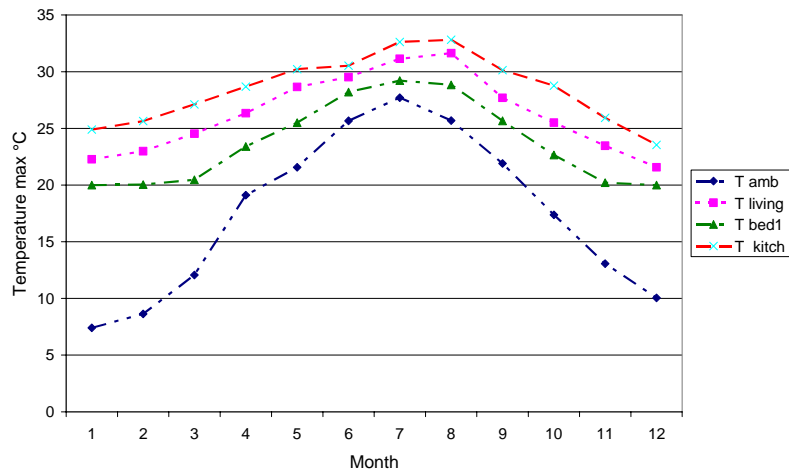

In order to check the possibility of overtaking this risk, a simulation with a ventilation rate of 2 Ach and a solar shading of 80% if the indoor average temperature exceed 24°C was performed. Results are presented in following graphs.

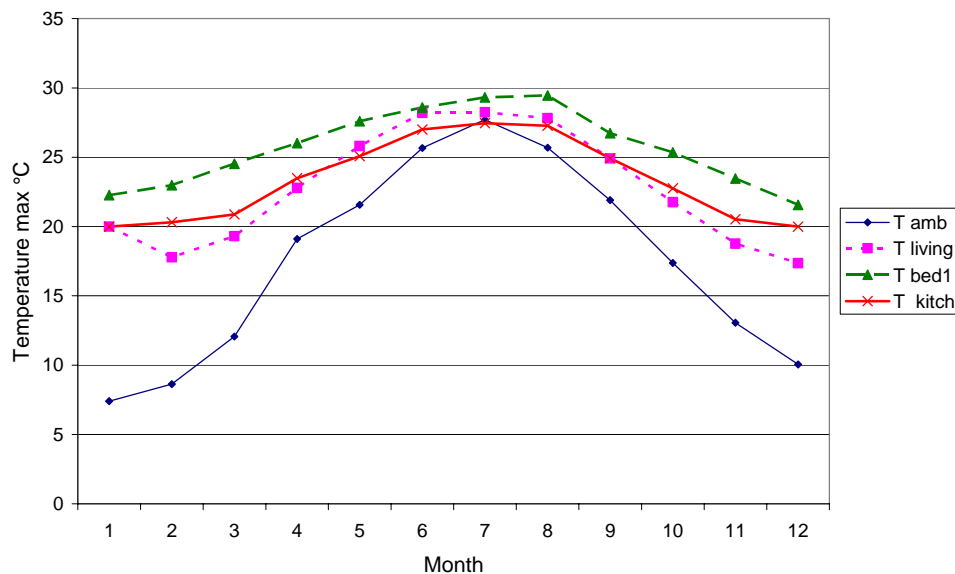

The graphs shows as the maximum temperatures in Living and Kitchen do not exceed anymore 30°C.

Here the comparison of Cumulative Frequency Curves between the two configurations.

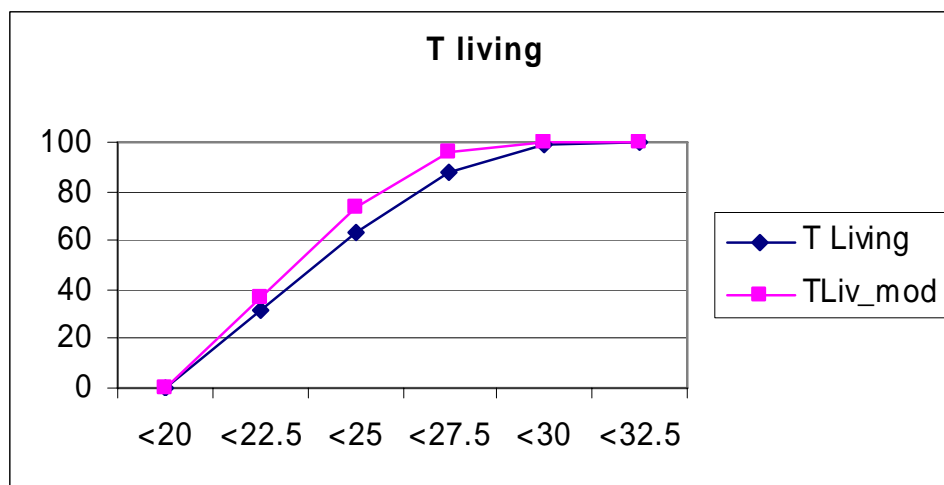

The ventilation and solar shading strategy allows to substantially eliminate the risk of overheating.

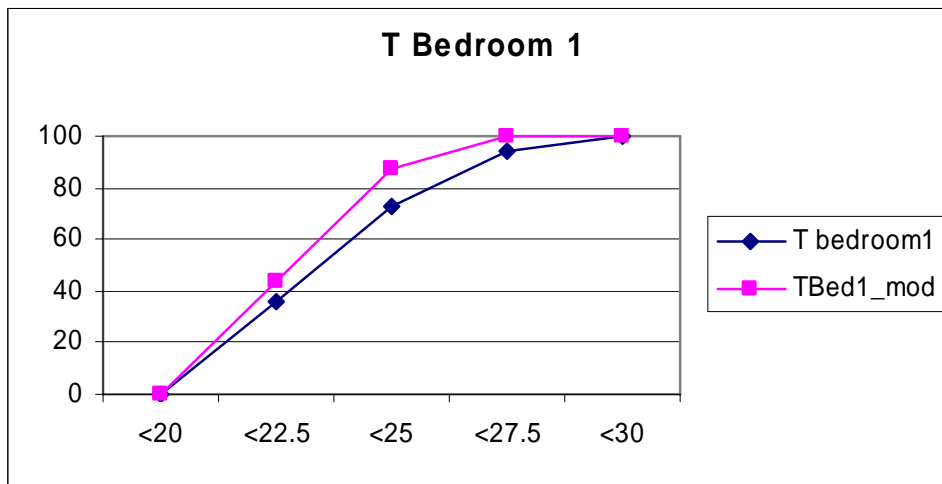
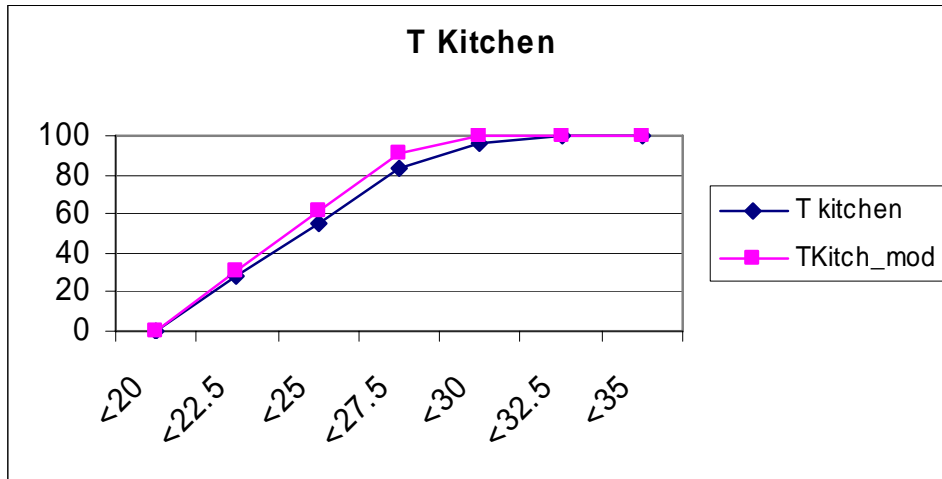



### 10.2. COMPARISON OF RESULTS FROM TRNSYS SIMULATIONS AND CALCULATIONS WITH BE06

The energy load for space heating has been calculated for the Lind&Risør house by a detailed simulation program – TRNSYS and compared to the results obtained by a calculation using the standard program for building energy calculations in Denmark - Be06. The Be06 calculation has been done by Lind & Risør.

The results are shown in the figure below.

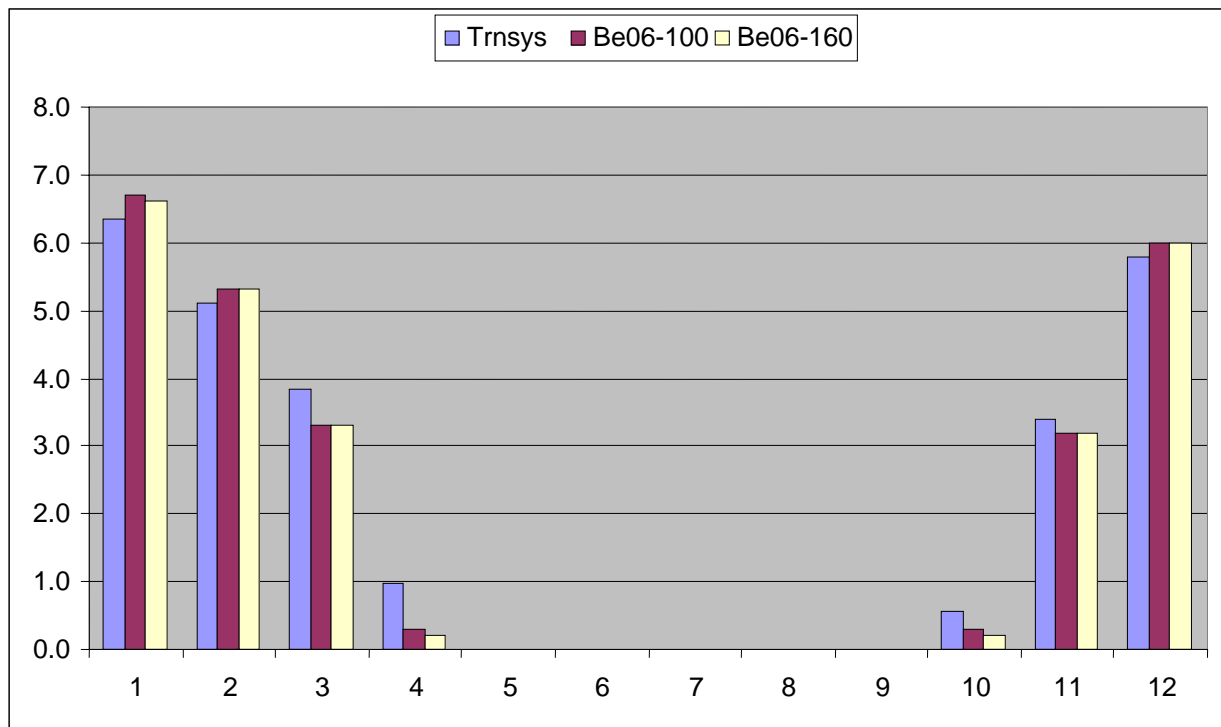

The yearly energy need for space heating has been calculated to 26,0 kWh/m<sup>2</sup> and 25,2 kWh/m<sup>2</sup> by the two programs, respectively TRNSYS and Be06, which means that the agreement is quite close.

When the results are compared on a monthly basis it is seen from the figure that there is some difference between the two programs. TRNSYS calculates a somewhat lesser energy demand during the winter months and somewhat larger in the spring months. The Be06 calculation has been done with two different heat capacities 100 and 160 Wh/Km<sup>2</sup>, but it only changes the results very little. The difference might be caused by the difference in treating the heat loss towards the ground where Be06 uses what is referred to as the b-factor method – a b-factor is multiplied to the heat loss calculated towards the ambient temperature and TRNSYS is simulating losses towards the ground. Since the ground has an almost constant temperature over the year this will cause the observed differences for the monthly calculations.