

## **Draught risk index tool for building energy simulations**

Vorre, Mette Havgaard; Jensen, Rasmus Lund; Nielsen, Peter V.

*Published in:*  
CIB Proceedings

*Publication date:*  
2014

*Document Version*  
Accepted author manuscript, peer reviewed version

[Link to publication from Aalborg University](#)

*Citation for published version (APA):*  
Vorre, M. H., Jensen, R. L., & Nielsen, P. V. (2014). Draught risk index tool for building energy simulations. *CIB Proceedings*, 1-7.

### **General rights**

Copyright and moral rights for the publications made accessible in the public portal are retained by the authors and/or other copyright owners and it is a condition of accessing publications that users recognise and abide by the legal requirements associated with these rights.

- Users may download and print one copy of any publication from the public portal for the purpose of private study or research.
- You may not further distribute the material or use it for any profit-making activity or commercial gain
- You may freely distribute the URL identifying the publication in the public portal -

### **Take down policy**

If you believe that this document breaches copyright please contact us at [vbn@aub.aau.dk](mailto:vbn@aub.aau.dk) providing details, and we will remove access to the work immediately and investigate your claim.

# Draught risk index tool for building energy simulations





## **Draught risk index tool for building energy simulations**

Mette H VORRE<sup>1,\*</sup>, Rasmus L JENSEN<sup>2</sup>, Peter V NIELSEN<sup>2</sup>

<sup>1</sup>Department of Energy and Environment, Danish Building Research Institute, Aalborg University, Copenhagen, Denmark

<sup>2</sup>Department of Civil Engineering, Aalborg University, Aalborg, Denmark

**Abstract:** *Flow elements combined with a building energy simulation tool can be used to indicate areas and periods when there is a risk of draught in a room. The study tests this concept by making a tool for post-processing of data from building energy simulations. The objective is to show indications of draught risk during a whole year, giving building designers a tool for the design stage of a building.*

*The tool uses simple one-at-a-time calculations of flow elements and assesses the uncertainty of the result by counting the number of overlapping flow elements. The calculation time is low, making it usable in the early design stage to optimise the building layout. The tool provides an overview of the general draught pattern over a period, e.g. a whole year, and of how often there is a draught risk.*

***Flow elements, thermal comfort, environment, design phase***

### **Introduction**

Draught is one of the main causes of complaints about the indoor environment in buildings (1). When people experience draught, they take action to avoid it. This may lead to higher energy consumption, e.g. by turning up the heat to compensate. By predicting the draught risk in the early design stage, the building design can be optimised for both low energy use and low draught risk. In naturally ventilated buildings, this is especially important, as the ventilation is integrated in the building envelope and is closely linked to the current outdoor climate.

Draught risk can be simulated by CFD, but this is time consuming and therefore not used. On the other hand, building energy simulation tools are available that are faster but lack information on airflows. The two tools have been linked (2) to supplement each other for thermal comfort simulation, but the CFD is slowing the process down.

Another way of estimating draught risk is to use flow elements. Flow elements describe the airflow in a room by equations for velocity distribution and flow patterns. Flow elements are derived for a number of standard situations and can be divided into categories depending on e.g. isothermal / nonisothermal, 2D plane flow / 3D flow, flow close to a wall or ceiling / free flow. Flow elements also describe flow by a cold down draught from a cold wall like a fully glassed wall (3,4).



By using flow elements, velocities can be calculated in any affected point in the room and the accuracy in each point is not dependent on a grid or grid density. Using flow elements combined with building energy simulation tools, the draught in the room can be estimated for

a whole year for each time step. This makes it possible to evaluate not only worst-case scenarios, but also any other situation, giving an overview of the draught risk and a picture of how robust the chosen building design is against draught e.g. under different weather conditions.

### Flow elements for inlets

Equations for calculating air velocity decays and flow patterns by flow elements constituted the basis of the method. Inputs were needed on room geometry, air temperature, and furthermore the inlet geometry, location, air velocity, air temperature outside and/or surface temperature (depending on the type of flow) were needed for each flow to be evaluated. These data are typically available from building energy simulation tools.

For some typical inlets, the velocity in the centre of a jet at a given distance  $x$  can be calculated by:

	3D jet		Plane flow (2D)	
 Free jet	$u_x = \frac{K_a}{\sqrt{2}} \cdot \frac{\sqrt{a_0}}{x + x_0} \cdot u_0$	1	$u_x = \frac{K_p}{\sqrt{2}} \cdot \sqrt{\frac{h_0}{x + x_0}} \cdot u_0$	2
 Wall jet	$u_x = K_a \cdot \frac{\sqrt{a_0}}{x + x_0} \cdot u_0$	3	$u_x = K_p \cdot \sqrt{\frac{h_0}{x + x_0}} \cdot u_0$	4

Where  $u_x$  is the velocity in the center of the jet,  $a_0$  is the area and  $h_0$  is the height of the opening,  $x_0$  is the distance to the virtual origin of the flow at the opening;  $K_a$  and  $K_p$  are constants depending on the inlet opening.

The velocities outside the centre of the jet are calculated from the universal velocity profiles shown in Figure 1.

The flow pattern of a jet mainly depends on the Archimedes number and the location of the inlet. The air will be accelerated downward by gravitational forces if the supply air is cool. Koestel (5) found that a free horizontal jet follows a trajectory given by:

$$y = 0.6 \cdot \frac{Ar}{K_a} \cdot \left( \frac{x}{\sqrt{a_0}} \right)^3 \cdot \sqrt{a_0} \quad 5$$

Where  $y$  is the vertical displacement of the flow at distance  $x$ ,  $Ar$  is the Archimedes number.

If the inlet is close to the ceiling (wall jet), the coanda effect will prevent the air jet from following the trajectory in Equation 5. Instead the jet will be attracted to the nearby ceiling until gravitational forces become greater than the pressure forces from the coanda effect. The distance from the inlet to this point is called the penetration length and (7–9) derived the equations for the calculation of the penetration length:

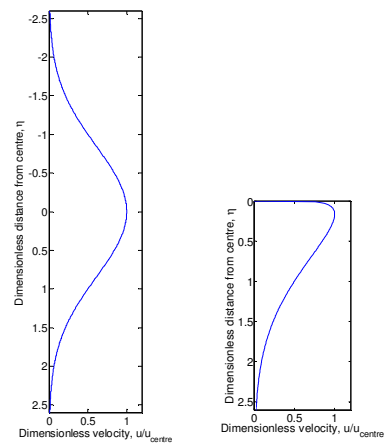

Figure 1 Universal velocity profiles for a free jet and a wall jet, the latter found by Verhoff (6).

3D jet: 
$$x_s = 0.19 \cdot K_{sa} \cdot K_a^2 \cdot Ar^{-0.5} \cdot \sqrt{a_0} - x_0 \quad 6$$

Plane flow (2D): 
$$x_s = 0.1 \cdot K_{sp} \cdot K_p^2 \cdot Ar^{-0.7} \cdot h_0 - x_0 \quad 7$$

Where  $x_s$  is the penetration length,  $K_{sa}$  and  $K_{sp}$  are constants depending on the room and heating distribution.

When the jet detaches from the ceiling, it will not follow the trajectory given for a free jet (Equation 5). The results in (10) show that the flow can be approximated with a straight line at an angle of 45° to the ceiling. However, the air will fall directly down if the inlet temperature is so low that the jet is not attracted to the ceiling.

The four trajectories that a wall jet can follow depending on the penetration length are shown in Figure 2.

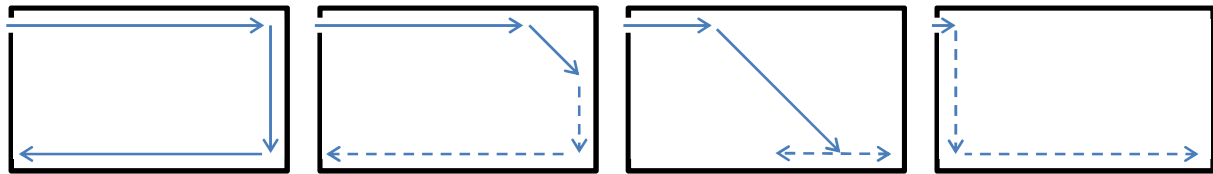

Figure 2 A wall jet coming into a room is assumed to follow one of four trajectories, depending on the penetration length. The dashed lines represent the parts of the flow that still need to be implemented in the draught risk index tool.

### Flow elements for a glassed wall

A fully glassed wall can induce a cold down draught that will continue at the floor similar to displacement ventilation. The velocity at the floor depends on the distance to the wall and the height of the wall (11):

$$u_x = \begin{cases} 0.055 \cdot \sqrt{H \cdot (T_{oc} - T_{window})} & \text{for } x < 0.4 \text{ m} \\ 0.095 \cdot \frac{\sqrt{H \cdot (T_{oc} - T_{window})}}{x + 1.32} & \text{for } 0.4 \text{ m} \leq x \leq 2 \text{ m} \\ 0.028 \cdot \sqrt{H \cdot (T_{oc} - T_{window})} & \text{for } 2 \text{ m} < x \end{cases} \quad 8$$

Where  $H$  is the height of the cold wall,  $T_{oc}$  is the air temperature in the occupied zone,  $T_{window}$  is the inside surface temperature of the window and  $x$  is the distance to the wall.

### Draught risk index tool

A tool for calculating the draught risk was made for post-processing of data from a building simulation tool.

By using flow elements, velocities can be calculated in any affected point in the room and the accuracy in each point is not dependent on a grid or grid density. To get a picture of the velocity distribution in the room, a grid was used and velocities were calculated in each node.

If more flow elements were present in the room, each flow was calculated individually, not taking into consideration the effect of the other flows in the room. The velocities in each node were compared and the highest used to estimate the draught risk. In each node, the number of

flow elements was counted, if the velocities were above a certain threshold limit. This was used as a measure of the uncertainty of the calculations.

### Presentation of the results

For each time step, the results can be visualised as a plot on the floor plan. At each node on the floor, the maximum velocity was found in the column from the floor to the top of the occupied zone; the principle is shown in Figure 3. Depending on the maximum velocity, the draught risk in each area was ranked as no (white), low (green), medium (yellow) or high (red).

The same was done for the number of flow elements meeting where the maximum number of flow elements in a node was shown on a floor plot. The more flows that meet, the more uncertain both the calculated risk of draught and the areas in the room, where the flows causes risk of draught.

For longer periods, the results were summed showing the draught risk index and number of meeting flow elements as percentages of the floor area. These plots can be used to point out periods of interest.

### Example: Office with natural ventilation

An office with natural ventilation was modelled in the building energy simulation tool BSim (12) using a Danish weather datafile. The room is shown in Figure 4 together with a brief description.

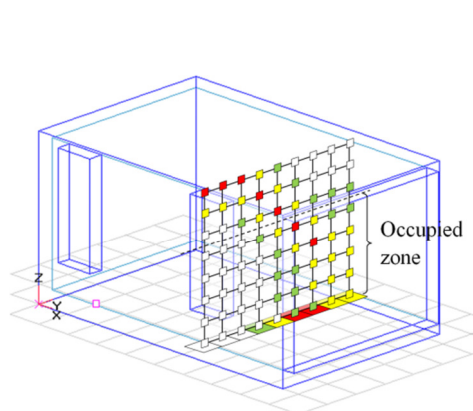

Figure 3 Draught risk is estimated in the nodes of a grid structure and the highest value in each column is plotted on the floor plan.

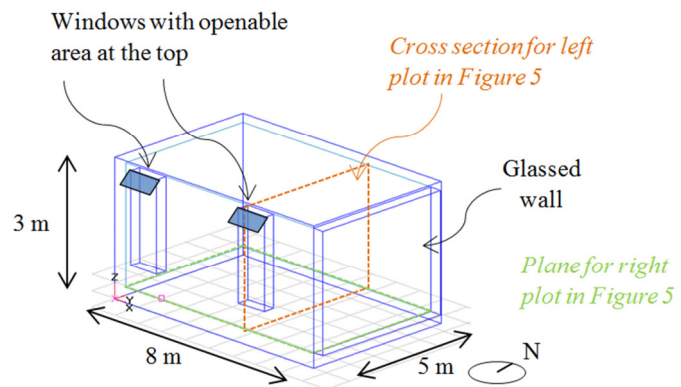

Figure 4 The room as simulated in BSim. Inside dimensions of room: height 3 m, length 8 m, width 5 m. There are two openable windows, each with a controlled opening area at the top of up to 0.33 m<sup>2</sup>. The end wall is fully glassed.

From BSim, data were extracted for the draught-risk index tool. These were: indoor and outdoor air temperatures, interior window surface temperatures, airflow velocities through the window openings and opening area of the windows, all extracted for each time step. For the openable windows  $K_a$  was set to 5 (Equations 3, 5, 6) corresponding to a poor inlet device for mixing ventilation.  $K_{sa}$  was set to 1.5 (Equation 6), which corresponds to heat release in the floor area. The height of the occupied zone is set to 1.8 m.

For an hour in May the following parameters were found by BSim:  $t_{in} = 21.4^{\circ}\text{C}$ ,  $t_{out} = 11.8^{\circ}\text{C}$ ,  $u_0 = 0.28 \text{ m/s}$ ,  $a_0 = 0.073 \text{ m}^2$ ,  $t_{window} = 19.7^{\circ}\text{C}$ .

The velocity distribution generated by each of the openable windows was calculated by the flow element of a 3D wall jet. In Figure 5 velocities in a vertical cross-section through a window are shown together with the maximum velocity in the occupied zone projected onto the floor plane. Velocities below 0.05 m/s are plotted with white colour (no risk), velocities of 0.05 – 0.1 m/s are shown in green (low risk), velocities of 0.1 – 0.2 m/s are shown in yellow (medium risk) and velocities above 0.2 m/s are shown in red (high risk). The flow from the other openable window is identical.

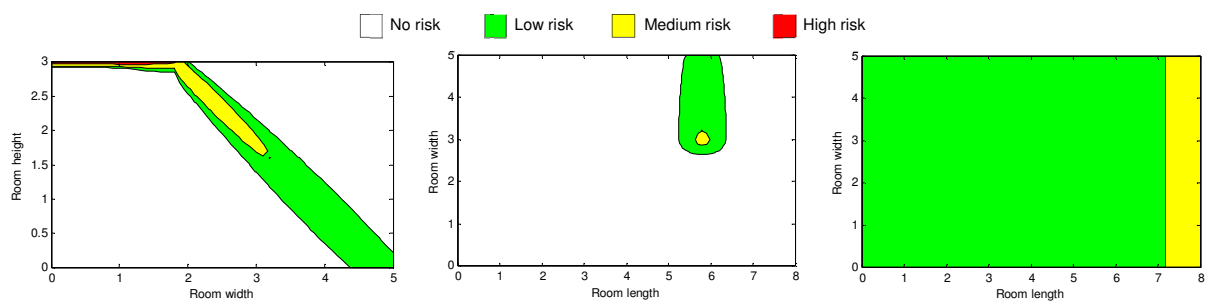

Figure 5 The left figure shows the velocity distribution calculated in the central plane of one of the openable windows. The flow enters in the top corner of the room and attaches to the ceiling for approximately 2 meters before it drops into the occupied zone. The middle figure shows the room seen from above with a marking of maximum velocities in the occupied zone of the flow element from one of the openable windows. The right figure shows the velocity distribution in the room created by down draught from the glassed wall, projected down onto the floor plan.

The incoming airflows from the windows create velocities in the occupied zone resulting in medium risk of draught in two small areas of the room and low risk in areas that are slightly larger.

In Figure 5 on the right, the draught risk created by the cold glassed wall is shown. The glassed wall creates a down draught due to temperature difference, and the flow continues at floor level, with the highest velocities closest to the wall.

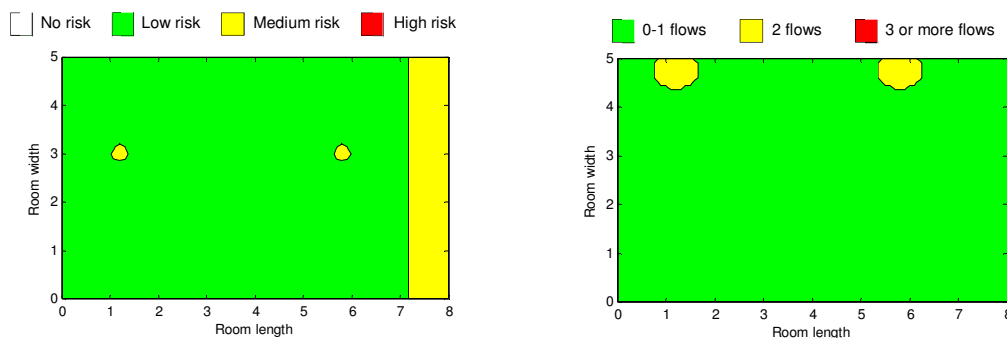

Figure 6 The left shows the maximum velocities in the occupied zone from all of the three flow elements, projected down onto the floor plan. The right shows the number of flow elements meeting in each area.

The results for all three flows were given in one plot, Figure 6 left. This plot shows the maximum risk of draught in each area, as calculated by flow elements one at a time. There is a low risk in most of the room and a medium risk close to the glassed wall and in two areas inside the room caused by airflows from the windows.

The estimated uncertainty of the flow element calculations was evaluated by counting the number of velocities above a threshold of 0.05 m/s in each node, and for each column the maximum number is projected down onto the floor, Figure 6 right.

In the two small areas of the room, shown in yellow in the right plot of Figure 6, both the openable windows and the glassed wall generates risk of draught in the same nodes. This is because the flow from the windows reaches the floor in these areas. Actually the areas could be bigger, as the tool at the moment does not handle how the flow from the windows continues after it reaches the floor.

As a summary of the draught risk over a longer period, the areas of the risk intervals (Figure 6 left) were found for each time step and can be shown, e.g. over a week in May as seen in Figure 7. The same is done for the uncertainties as seen in the right part of Figure 7.

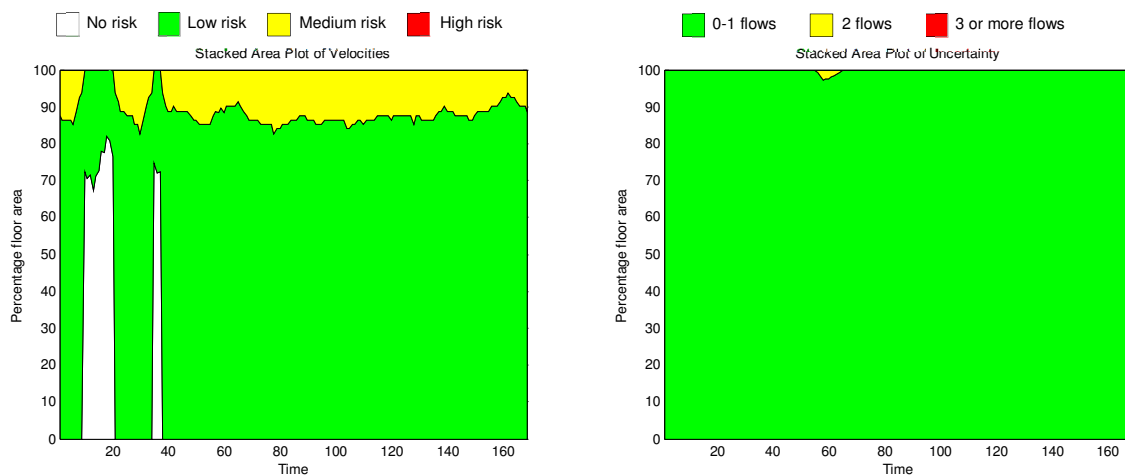

Figure 7 Summary of the draught risk over a longer period of the velocity distribution (left) and meeting flow elements (right) in the room. The room areas divided into risk intervals in each time step, here one hour.

During this week in May, most of the time there was a low risk of draught in about 90% of the room area and medium risk in the remaining area of the simulated room. Only in a short period does more flow elements meet.

### Discussion and conclusion

The developed tool uses inputs generated by building energy simulation software to give an overview of how often and where there is a risk of draught in a room. The tool is simple in the sense that it handles one flow element at a time and when flow elements meet, and the one generating the highest velocity is used to estimate the draught risk.





Flow elements are developed for simple geometries and when using them on more complex inlets and room geometries, the calculated velocities and flow patterns will only be estimates, even with just one element present. If flow elements are oppositely directed or have co-flow, there is no description of what occurs and the uncertainty is therefore higher. In the tool, this is handled by plotting the number of meeting flow elements, so that the user can realise that the calculations are uncertain. The idea of the tool is not to make highly precise estimates for any time step, but to give an overview of when and where draught may be a problem.

From the plots produced by the tool, it should be possible to conclude one of three: (Green) There is a low risk of draught and the uncertainty is low – the design is acceptable, (Red) There is a high risk of draught – the design should be changed, or (Yellow) There is a risk of draught or the uncertainty is high – either change the design or make further investigation e.g. by CFD.

Further work needs to be put into the tool to cover more flow elements and for calculating the parts of the flow market with dashed lines in Figure 2.

### **Acknowledgement**

This PhD study is financially supported by the Danish energy research and development programme ELFORSK, VELUX A/S and WindowMaster A/S.

### **References**

1. Fanger, P., Melikov, A., Hanzawa, H. & Ring, J. Air turbulence and sensation of draught. *Energy Build.* **12**, 21–39 (1988).
2. Beausoleil-Morrison, I. The adaptive conflation of computational fluid dynamics with whole-building thermal simulation. *Energy Build.* **34**, 857–871 (2002).
3. Nielsen, P. V. Air Distribution in Rooms - Research and Design Methods. in *Int. Proc. ROOMVENT '94. Cracow, Poland.* (1994).
4. Nielsen, P. V. *Luftströmung und Luftverteilung in Räumen.* 87 (1995).
5. Koestel, A. Paths of horizontally projected heated and chilled air jets. *ASHVE Trans.* (1955).
6. Verhoff, A. *The two-dimensional, turbulent wall jet with and without an external free stream.* 126 (1963).
7. Grititlin, M. Zuluftverteilung in Räumen. *Luft- und Kältetechnik* **5**, (1970).
8. Nielsen, P. V. & Möller, Å. T. A. Measurements on Buoyant Wall Jet Flows in Air Conditioned Rooms. in *ROOMVENT '87, Int. Conf. Air Distrib. Vent. Spaces* (1987).
9. Nielsen, P. V. & Möller, Å. T. A. Measurements on Buoyant Jet Flows from Ceiling-Mounted Slot Diffuser. in *Proc. 3rd Semin. "Application Fluid Mech. Environ. Prot. - 88"* (1988).
10. Jacobsen, T. S., Mathiesen, E., Nielsen, P. V., Hansen, R. & Topp, C. Thermal Comfort in a Mixing Ventilated Room with High Velocities Near the Occupied Zone. *ASHRAE Trans.* **108**, (2002).
11. Heiselberg, P. K. Draught Risk From Cold Vertical Surfaces. *Build. Environ.* **29**, 297–301 (1994).
12. Wittchen, K. B., Johnsen, K. & Grau, K. *Bsim User's Guide.* (2013).