



Aalborg Universitet

AALBORG UNIVERSITY
DENMARK

Exploiting Power-to-Heat Assets in District Heating Networks to Regulate Electric Power Network

Khatibi, Mahmood; Bendtsen, Jan Dimon; Stoustrup, Jakob; Mølbak, Tommy

Published in:

IEEE Transactions on Smart Grid

DOI (link to publication from Publisher):

[10.1109/TSG.2020.3044348](https://doi.org/10.1109/TSG.2020.3044348)

Publication date:

2021

Document Version

Accepted author manuscript, peer reviewed version

[Link to publication from Aalborg University](#)

Citation for published version (APA):

Khatibi, M., Bendtsen, J. D., Stoustrup, J., & Mølbak, T. (2021). Exploiting Power-to-Heat Assets in District Heating Networks to Regulate Electric Power Network. *IEEE Transactions on Smart Grid*, 12(3), 2048-2059. Article 9292988. <https://doi.org/10.1109/TSG.2020.3044348>

General rights

Copyright and moral rights for the publications made accessible in the public portal are retained by the authors and/or other copyright owners and it is a condition of accessing publications that users recognise and abide by the legal requirements associated with these rights.

- Users may download and print one copy of any publication from the public portal for the purpose of private study or research.
- You may not further distribute the material or use it for any profit-making activity or commercial gain
- You may freely distribute the URL identifying the publication in the public portal -

Take down policy

If you believe that this document breaches copyright please contact us at vbn@aub.aau.dk providing details, and we will remove access to the work immediately and investigate your claim.

Exploiting Power-to-Heat Assets in District Heating Networks to Regulate Electric Power Network

Mahmood Khatibi, Jan Dimon Bendtsen, *Member, IEEE*, Jakob Stoustrup, *Senior Member, IEEE*, Tommy Mølbak

Abstract-- New green energy policies are encouraging district heating (DH) companies to exploit heat production by power-to-heat (P2H) assets e.g. heat pumps (HPs) and electric boilers (EBs). Therefore, they are shifting to exploit these assets in their distribution network besides the traditional central combined heat and power (CHP) units in their production chain. It will lead to an increasingly complex interaction between DH networks and electricity markets. This paper proposes an economic model predictive control (EMPC) framework to investigate how DH companies can manage this extra complexity and if they can contribute in an efficient way towards balancing the production and consumption of electric power in smart grids through playing in the reserve capacity markets. The framework is applied to a real world case study and the results are discussed. The results show the new paradigm increases operation costs. However, reserving a part of the capacity for playing in reserve capacity market will not only make up for the extra costs to some extent, but also improve the capability of providing regulating power.

Index Terms-- district heating systems, EMPC, optimization, power regulation, power-to-heat assets.

NOMENCLATURE

A. Abbreviations

CHP	Combined Heat and Power
COP	Coefficient of Performance (for a HP)
CP	Commitment Period
DH	District Heating
EB	Electric Boiler
EMPC	Economic Model Predictive Control
EP	Electric Power
EPH	Extra Prediction Horizon
HP	Heat Pump
M&O	Maintenance and Operation
P2H	Power to heat
PH	Prediction Horizon
RES	Renewable Energy Source

B. Symbols

C	Production Cost
dis	distribution
E	Energy stored in tanks

L	Length
p	Electric power
q	Heat flow
S	Storage
tar	Electricity transmission tariff
tax	Tax rate for heat production by EP
tra	transmission
v	Value (price)
ε	a very small number near machine zero
C. Notations	
$[\]^T$	Vector Transpose
b	Binary variable
*	Any variable
$*_k$	The value of variable * during the k^{th} hour (resulted from day-ahead planning)
$*_{\Delta t_-}$	The value of variable * during the elapsed time of the current hour
$*_{\text{old},0}$	The old value of variable * during the remaining time of the current hour according to former plan.
$*_{\text{new},0}$	The new value of variable * during the remaining time of the current hour according to new plan
$*_{\text{old},i}$	The old value of variable * during the i^{th} upcoming hour according to former plan
$*_{\text{new},i}$	The new value of variable * during the i^{th} upcoming hour according to new plan
ΔC_0	Changes in production cost of the current hour, due to a deviation from former plan
ΔC_i	Changes in production cost of the i^{th} upcoming hour, due to a deviation from former plan
$\tilde{*}$	A temporary value of variable *
$*_{\text{Category}}$	Denotes the variable * is belong to a certain category, e.g. q^{HP} denotes the q (heat flow) of HP
$\bar{*}$	Maximum value of variable *
$\underline{*}$	Minimum value of variable *

I. INTRODUCTION

District heating (DH) networks play an essential role in providing hot water for space heating as well as domestic

This paper was sponsored in part by EU DP project “Local Heating Concepts for Power Balancing” (Project No. 12539).

M. Khatibi is with the Department of Electronic Systems, Aalborg University (e-mail: mak@es.aau.dk).

J. D. Bendtsen is with the Department of Electronic Systems, Aalborg University (e-mail: dimon@es.aau.dk).

J. Stoustrup is with the Department of Electronic Systems, Aalborg University (e-mail: jakob@es.aau.dk).

T. Mølbak is with Added Values Company, Vejle (e-mail: tmo@addedvalues.eu).

use in many regions throughout the world, especially in the Scandinavian countries [1]. DH networks are centralized by their nature and consist of several hierarchical chains including production, transmission, distribution and consumption layers (Fig. 1). Each layer involves different infrastructure elements such as pipe networks, pumps and heat exchangers. During the last decade, centralized production by combined heat and power (CHP) units has been the dominant paradigm [2]. The CHP plants are typically either owned by the DH companies and managed directly according to their needs and market situation; or they are not owned by the DH companies, instead selling heat to the DH companies according to contracts. Either way, the CHP units are connected to both DH and electric power (EP) networks, which results in an interaction and interdependence between the two networks. Coordinated operation of the EP and DH networks is an effective way to deal with the uncertainties resulted from exploiting renewable energy sources (RES) and can provide the EP system with reserve capacity and flexibility [3]. A considerable amount of researches has gone into investigating this interaction and exploiting it to balance supply and demand in EP smart grids [3]-[5]. Interested readers can find a recent review of modeling and solution methods for optimal operation of integrated electricity and heat systems in [6].

Nevertheless, new green energy policies are beginning to challenge the conventional paradigm. For instance, new Danish energy policies are set to eliminate such requirements as production commitments in the form of CHP plant or the fuel commitment to natural gas for small district heating areas. The base subsidy for electricity produced by CHP plants will be removed. On the other hand, it reduces the electricity heating tax from 307 DKK/MWh to 155 DKK/MWh to incentivize people as well as DH companies to choose green solutions such as heat pumps (HPs) [7]. Similar policies are being pursued in other countries such as Germany [8]. In [9], it is shown that such policies are essential to encourage DH companies to exploit power-to-heat (P2H) technologies such as electric boilers (EBs) and HPs. It is therefore not surprising that many DH companies are looking into introducing HPs and EBs into their distribution networks to support the increased heat demand in newly developed urban areas rather than committing themselves to substantial investments in new transmission lines, pipes and other infrastructure elements. Fig. 2 illustrates this new paradigm.

The new DH network paradigm has been studied from a long-term economic viewpoint in several works. In [10], the authors study the operation cost when the share of HP production is increased in DH systems. In [11], the capital as well as operational costs of incorporating HPs and EBs in distribution network level are discussed within a one-year prediction horizon, and the results are compared with a conventional centralized approach. The impacts of incorporating storage tanks is also discussed. In [12], the authors investigate how a sizable increase in large HPs in DH networks may affect the whole electricity market within a one year prediction horizon. However, the impact of storage tanks is neglected. In [13], it is shown that “connecting heat pumps to distribution networks

results in a significantly higher heat production, than if connected to the transmission network.”

While there is considerable research focusing on long-term impacts of incorporating P2H assets in DH networks, much less attention has been paid to short-term and real-time interaction of DH companies with a dynamic EP market within the new paradigm. Incorporating large-scale HPs and EBs is bound to increase the complexity of DH networks, and DH companies will need to take this extra complexity properly into account in order to participate effectively in the EP markets.

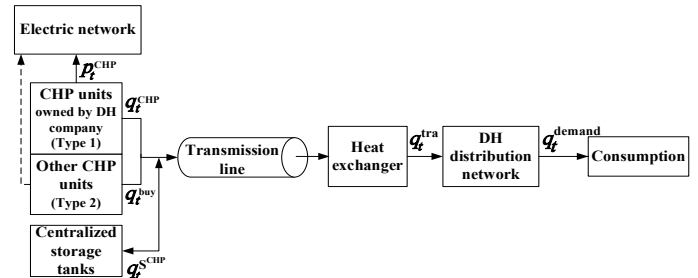

Fig. 1. Conventional DH System paradigm

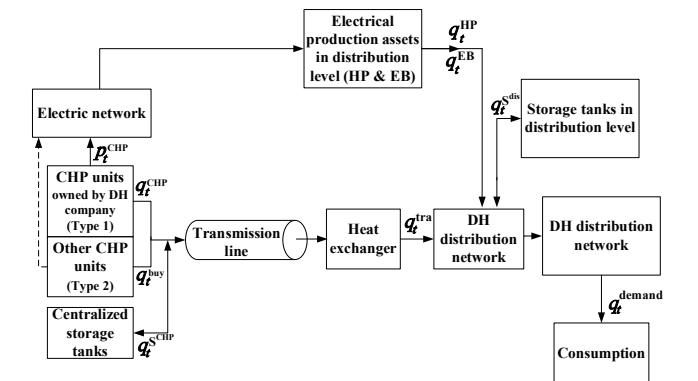

Fig. 2. New paradigm for DH systems

A few papers have studied the challenges of incorporating large scale HPs and EBs in DH networks for balancing EP network from a technical point of view [14], while others investigated the problem from a more market-oriented viewpoint. For example, the authors in [15] extend the locational marginal price concept to DH networks and form a heat-power spot market. The market equilibrium condition is formulated as a mixed-integer linear program. In [16],[17] an energy hub was considered instead of a heat-power market, and the authors discuss strategic bidding through it. In this scheme, the heat market and power market are not connected to each other directly and an upper level energy hub offers prices and quantities to both of them. More recently, multi-period operation of interconnected power distribution networks and DH networks is studied in [18]. In the proposed framework, there is not a real heat market and the interaction between power market and heat companies is modeled as a simultaneous Nash-type game.

Nevertheless, it is apparent that there is no standard model for the heat market concept, and it is modeled in completely different ways within recent studies. This is because, in contrast to power market concept which has been successfully developed for decades throughout the world, the heat market

concept is still in its initial stages and there are few examples of real-world heat markets. As a result, there is a gap in analyzing the short-term and real-time interaction of DH companies with a dynamic EP market in real world.

This paper investigates how DH companies can manage the extra complexity resulting from the new paradigm and if they can contribute in an efficient way towards balancing the production and consumption in EP smart grids through playing in the reserve capacity markets. The main contributions of this paper may be summarized as follows:

- Operation costs of the new and conventional paradigms are compared within a real-world framework.
- It is investigated how DH companies should participate in day-ahead heat and electricity markets within the new paradigm and minimize their operation costs by proposing a multi-step optimization procedure.
- Unlike [15]-[18], which use a conceptual heat market, here a real-world heat market known as Varmelast is used as a model case. It has been active in Copenhagen since 2008 [19].
- An economic model predictive control (EMPC) framework for effective participation of DH companies in the reserve capacity power market within the new paradigm is proposed.
- The economic revenue generated by participating in the reserve capacity power market is analyzed.

Fig. 3 illustrates the two-stage optimization strategy proposed in this paper.

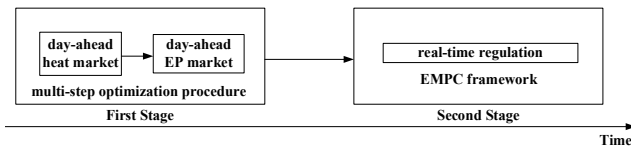

Fig. 3. The two-stage optimization strategy

The rest of this paper is organized as follows. Sections II and III review the mechanism of power and heat markets, respectively. Section IV is dedicated to day-ahead planning and its corresponding multi-step optimization. Section V discusses real-time operation and participation in reserve capacity power markets. Section VI describes our case study specifications and then the results of applying the proposed strategy to the use case are presented and discussed. Section VII concludes the paper.

II. REVIEW OF EP MARKET MECHANISM

Electricity markets around the world have relatively similar architectures. In this study, we consider the Nordic electricity market, which consists of Norway, Sweden, Finland and Denmark. These countries deregulated and integrated their own electricity markets during the 1990s. The Nordic short-term electricity market consist of three submarkets with different deadlines for offering the bids. They are the day-ahead market (Elspot or SPOT), the intraday market (Elbas) and the reserve capacity market. The reserve capacity market is consist of three submarkets with different technical characteristics including FCR (Frequency Containment Reserves), aFRR (Automatic Frequency Restoration Reserves) and mFRR (Manual

Frequency Restoration Reserves). Fig. 4 shows the deadlines for these submarkets [20].

The day-ahead market (Nord Pool Spot or Elspot) is the central Nordic energy market where a daily competitive auction reveals a price for each hour of the next day. All participants' bids are received before gate closure at 12:00 and then the system price and the area prices are calculated and declared. Since the day-ahead market is closed 12-36 hours ahead of the actual operation hour, there will inevitably be some deviations from the day-ahead plans. In order to mitigate such deviations during the operational day, electricity can be traded from the closure time of Elspot until 45 minutes before the operating hour through hourly contracts in the intraday market.

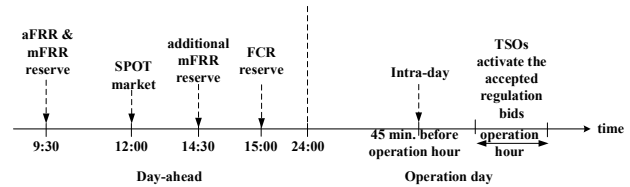

Fig. 4. The mechanism of Nordic electricity market

During the hour of operation, transmission system operators (TSOs) maintain the network balance by using their reserved capacities as well as activating some of the regulation bids. Accepted regulation bids should be fully activated within 15 minutes, but the duration can vary. There are two different possibilities for regulating power: up-regulation and down-regulation. Fig. 5 illustrates these two possibilities.

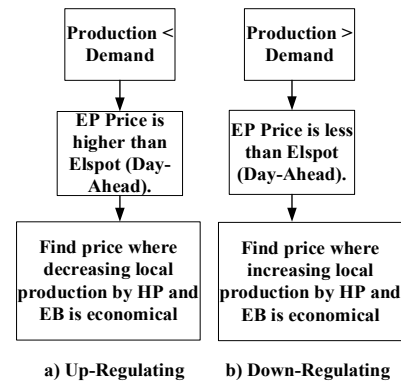

Fig. 5. Regulating power

III. REVIEW OF HEAT MARKET MECHANISM

The Danish power market was influenced by liberalization in the year 2000. Before that, deciding which units were to supply the heat load was up to the CHP producers and they organized the heat and power production of their plants. After the liberalization, the complex competition between the players on the EP market made it unrealistic for the CHP producers to optimize their load distribution economically.

In order to arrange the daily production of the CHP units (as well as heat-only plants) according to a global economic optimization, the heat producers and the DH companies in the Copenhagen metropolitan area approved to have a common load distribution. It resulted in the establishment of Varmelast in 2008 which is responsible for preparing the daily heat planning. For this purpose, Varmelast forecasts the heat

demand of DH companies and then prepares a heat plan considering the hydraulic bottlenecks in the transmission network along with fuel prices, operation and maintenance (O & M) costs, etc.

Fig. 6 and Fig. 7 show the outline of time scheduling for preparing the heat plan in more details.

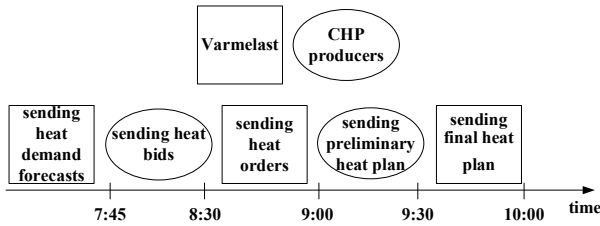

Fig. 6. Day-ahead plan in the heat market

The procedure of heat planning for the next 24 hours starts before 8:00 AM when Varmelast sends the hourly heat demand forecasts of the next 24 hours to the CHP producers. Subsequently, the CHP producers send their bidding ranges to Varmelast and it determines the most economic hourly plan to supply the heat requirements. Successively, Varmelast sends the orders of required amount of steam and hot water to each heat producer.

Afterwards, the most economical way to supply Varmelast's hourly heat orders is calculated by the heat producers considering the EP production, fuel prices, CO2 quotas and energy taxes. For example, the tax structure prioritizes biomass fuels before fossil ones.

As soon as Varmelast receives the preliminary heat plans from the producers, it revises them to check if the hydraulic limitations in the district heating network are satisfied regarding the optimum exploitation of the heat accumulators. As a last point, the final hourly heating plan is issued for each producer that illustrates the exact commitment of its individual blocks within the next 24 hours.

Heat plans must be finalized before 10:30 AM, so that the CHP producers know how much heat they are supposed to produce and thus how much power they can offer for sale at Nord Pool.

Nevertheless, forecasts are not precise and real time situation is somewhat different due to many factors such as the published spot price of EP market or unforeseen events at the CHP plants. To deal with such real time deviations, the heat plans are revised five times a day to reflect the actual DH requirements according to Fig. 7.

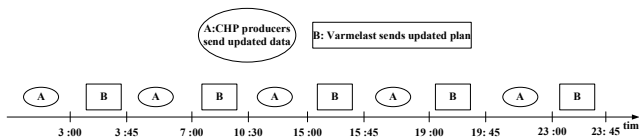

Fig. 7. Intraday plan in the heat market

IV. PARTICIPATION IN DAY-AHEAD MARKETS

In an up-regulation situation, the EP demand is higher than current production. Consequently, the power price is increased compared to the day-ahead prices. In this condition, DH companies may potentially reduce the heat production of their

P2H assets from the scheduled amount and sell the surplus EP at a higher price. Although the DH companies make profit by this trade, they would need to compensate for the reduced heat production by exploiting other sources such as centralized production assets (CHP units) or storage tanks. Therefore, their production cost increases compared to the scheduled value as they do not run the optimal plan. The question in this condition is "at which up-regulation price, the profit from selling the surplus EP would be higher than the extra production cost?"

In down-regulation, the EP demand is less than current production. Thus, the power price is decreased from the day-ahead prices. In this condition, DH companies may increase the heat production of their P2H assets from the scheduled amount. Obviously, this will affect the production plan by increasing the accumulated heat in the storage tanks and/or reducing the heat production of the centralized production assets (CHP units). The question in this case is, at which down-regulation price the new production cost becomes less than the scheduled one.

Fig. 2 shows the structure of DH network within the new paradigm. As mentioned previously, we consider two different types of CHP plants. The first type CHP plants are owned and managed by DH companies. On the other hand, DH companies do not own the CHP plants of the second type and they buy heat from them according to a contract.

For the sake of simplicity, we assume there is only one unit of each asset in our model. However, the generalization of the results to the cases where the number of asset increased is completely straightforward. We denote the expected overall operation cost during the k^{th} hour by C_k . It is the overall expected cost of individual assets and is defined as follows.

$$C_k = C_k^{\text{CHP}} + C_k^{\text{buy}} + C_k^{\text{HP}} + C_k^{\text{EB}} + C_k^{\text{S}^{\text{CHP}}} + C_k^{\text{S}^{\text{dis}}} \quad (1)$$

In the following subsections, each term in (1) will be defined and described in detail.

A. CHP hourly costs

We use C_k^{CHP} notation to indicate the expected heat production cost of the first-type CHP unit during the k^{th} hour. It is equal to the total fixed and variable costs minus the expected revenue from power sales as below.

$$C_k^{\text{CHP}} = \underbrace{C^{\text{fixed}^{\text{CHP}}}}_{\text{fixed cost}} + \underbrace{\alpha^{\text{M\&O}^{\text{CHP}}} (p_k^{\text{CHP}} + q_k^{\text{CHP}})}_{\text{M\&O cost}} + \underbrace{\alpha^{\text{fuel}^{\text{CHP}}} f_k^{\text{CHP}}}_{\text{fuel cost}} - \underbrace{p_k^{\text{CHP}} v_k^{\text{EP}}}_{\text{expected revenue from power sales}} \quad (2)$$

In (2), v_k^{EP} denotes for EP price during the k^{th} hour and should be substituted by day-ahead price (or its best estimation). $C^{\text{fixed}^{\text{CHP}}}$ is the fixed cost of CHP operation during one hour and f_k^{CHP} is the heating value of the total fuel consumed by the CHP unit during the k^{th} hour. The relation between f_k^{CHP} with p_k^{CHP} and q_k^{CHP} is depended on the operation mode of the CHP unit. In this study, we investigate only backpressure CHP units. However, the results can easily be generalized to the extraction CHP units. For backpressure CHP units, the relation is captured by efficiency factors which are defined as follows.

$$\eta^{\text{total}} = \frac{p_k^{\text{CHP}} + p_k^{\text{bypass}} + q_k^{\text{CHP}}}{f_k^{\text{CHP}}} \quad (3)$$

$$\eta^{\text{ele}} = \frac{p_k^{\text{bp}}}{p_k^{\text{CHP}} + p_k^{\text{bypass}}} \quad (4)$$

In the above relations, p_k^{bp} and q_k^{bp} denote the initial EP and heat produced in backpressure mode, respectively. p_k^{bypass} is a non-negative variable corresponding to the part of p_k^{bp} that is converted to heat by turbine-bypassing procedure.

Using (3), f_k^{CHP} can be written as follows

$$f_k^{\text{CHP}} = \frac{p_k^{\text{CHP}}}{\eta^{\text{total}}} + \frac{q_k^{\text{CHP}}}{\eta^{\text{total}}} \quad (5)$$

Using (5), we can rewrite (2) as

$$C_k^{\text{CHP}} = C_{\text{fixed}}^{\text{CHP}} + \mathbf{a}_k^{\text{CHP}T} \cdot \mathbf{x}_k^{\text{CHP}} \quad (6)$$

where $\mathbf{a}_k^{\text{CHP}}$ is a vector determined by the CHP characteristics and v_k^{EP} while $\mathbf{x}_k^{\text{CHP}}$ is a vector defined as $\mathbf{x}_k^{\text{CHP}} = [p_k^{\text{CHP}} \quad q_k^{\text{CHP}}]^T$.

Also by using (5), (4) could be rewritten as

$$p_k^{\text{bypass}} = \boldsymbol{\gamma}_k^{\text{CHP}T} \cdot \mathbf{x}_k^{\text{CHP}} \quad (7)$$

where $\boldsymbol{\gamma}_k^{\text{CHP}}$ is a vector determined by the CHP characteristics. All associated variables and their rates should be bounded by their maximum and minimum values, according to technical constraints, e.g.

$$-\Delta f^{\text{CHP}} \leq f_k^{\text{CHP}} - f_{k-1}^{\text{CHP}} \leq \overline{\Delta f}^{\text{CHP}} \quad (8)$$

Now, we consider the second type CHP units that are not owned by the DH company. It is assumed that the heat company buys heat from a second-type CHP unit according to a contract as follows.

$$C_k^{\text{buy}} = C^{\text{fixed buy}} + \alpha^{\text{buy}} q_k^{\text{buy}} - \beta^{\text{buy}} q_k^{\text{buy}} v_k^{\text{EP}} \quad (9)$$

C_k^{buy} can be rewritten in a compact vector form as

$$C_k^{\text{buy}} = C^{\text{fixed buy}} + \mathbf{a}_k^{\text{buy}} q_k^{\text{buy}} \quad (10)$$

where $\mathbf{a}_k^{\text{buy}}$ is a variable determined by the contract specifications as well as v_k^{EP} .

In general, q_k^{buy} should be bounded according to the contract.

B. HP and EB hourly costs

We denote the heat production cost of an HP unit during the k^{th} hour by C_k^{HP} and is defined as below.

$$C_k^{\text{HP}} = C^{\text{fixed HP}} + \alpha^{\text{M\&O HP}} q_k^{\text{HP}} + (p_k^{\text{total HP}})(v_k^{\text{EP}} + \text{tar}) + (p_k^{\text{HP}})\text{tax} + b_k^{\text{start HP}} C^{\text{start HP}} \quad (11)$$

In above, $p_k^{\text{total HP}}$ denotes the total EP demand of HP system including losses in transmission line as well as the demand of its ancillary subsystems such as pumps while p_k^{HP} denotes the consumed portion in the compressor of the HP unit. It is assumed that

$$p_k^{\text{HP total}} = \sigma^{\text{HP}} p_k^{\text{HP}} \quad (12)$$

where $\sigma^{\text{HP}} \geq 1$ is a constant factor. Also, $C^{\text{start HP}}$ is the start cost of the HP unit and $b_k^{\text{start HP}}$ is a binary variable which is set only when the HP unit is started. In order to define it, we first define the auxiliary binary variable $b_k^{\text{on HP}}$ as follows.

$$\varepsilon b_k^{\text{on HP}} \leq q_k^{\text{HP}} \leq \overline{q}^{\text{HP}} b_k^{\text{on HP}} \quad (13)$$

where ε is a very small number near machine zero, beyond which the constraint is regarded as violated. Now, using the methods described in [21], $b_k^{\text{start HP}}$ can be defined by incorporating the following constraint.

$$\varepsilon (1 - b_k^{\text{start HP}}) \leq 1 - (b_k^{\text{on HP}} - b_{k-1}^{\text{on HP}}) \leq 2(1 - b_k^{\text{start HP}}) \quad (14)$$

It is easy to show that (14) is equivalent with the following conditional clause.

$$b_k^{\text{start HP}} == 1 \Leftrightarrow b_k^{\text{on HP}} - b_{k-1}^{\text{on HP}} == 1 \quad (15)$$

In addition, the following constraint should be satisfied due to technical issues.

$$\gamma_{\text{min}}^{\text{HP}} \overline{q}^{\text{HP}} b_k^{\text{on HP}} \leq q_k^{\text{HP}} \leq \overline{q}^{\text{HP}} \quad (16)$$

where $\gamma_{\text{min}}^{\text{HP}}$ is a constant factor usually between 0.1 to 0.3 and shows that the HP unit is not allowed to work below a certain percentage of its maximum power.

The relation between p_k^{HP} and q_k^{HP} is expressed as

$$q_k^{\text{HP}} = p_k^{\text{HP}} \text{COP}_k \quad (17)$$

where COP_k is the HP Coefficient Of Performance during the k^{th} hour.

Using (12) and (17), (11) can be rewritten in a compact form as

$$C_k^{\text{HP}} = C_{\text{fixed}}^{\text{HP}} + \mathbf{a}_k^{\text{HP}} q_k^{\text{HP}} + b_k^{\text{start HP}} C^{\text{start HP}} \quad (18)$$

where \mathbf{a}_k^{HP} is a variable determined by the HP characteristics including COP_k , σ^{HP} as well as v_k^{EP} , tax and tariff rates.

We denote the heat production cost of an EB unit during the k^{th} hour by C_k^{EB} and is calculated in a similar way except that COP_k is replaced with the efficiency factor of the EB (η^{EB}).

C. Storage hourly costs

The stored energy at the end of the k^{th} hour inside the heat accumulator tank in the production level is denoted by $E_k^{\text{S CHP}}$ and its fluctuations is modeled as

$$E_k^{\text{S CHP}} = (1 - \gamma^{\text{S CHP}}) E_{k-1}^{\text{S CHP}} + q_k^{\text{S CHP}} \quad (19)$$

where $q_k^{\text{S CHP}}$ shows the heat flow through the tank during the k^{th} hour and $\gamma^{\text{S CHP}}$ is the lost factor. According to the above model, a positive $q_k^{\text{S CHP}}$ corresponds to charging and a negative $q_k^{\text{S CHP}}$ corresponds to discharging.

Similarly, the energy stored in the heat accumulator tank at the distribution level at the end of the k^{th} hour is denoted by $E_k^{\text{S dis}}$ and its fluctuation is modeled in a same way.

All associated variables and their rates should be bounded by their maximum and minimum values, according to technical constraints.

For safety reasons, we impose the following constraint to guarantee the heat supply in the presence of unforeseen technical issues for production assets.

$$(1 - \gamma^{\text{S}^{\text{CHP}}}) E_k^{\text{S}^{\text{CHP}}} + (1 - \gamma^{\text{S}^{\text{dis}}}) E_k^{\text{S}^{\text{dis}}} \geq q_{k+1}^{\text{demand}} \quad (20)$$

The cost of storage during the k^{th} hour is modeled as

$$C_k^{\text{S}^{\text{CHP}}} = C^{\text{fixed}^{\text{S}^{\text{CHP}}}} + a^{\text{S}^{\text{CHP}}} |q_k^{\text{S}^{\text{CHP}}}| \quad (21)$$

$$C_k^{\text{S}^{\text{dis}}} = C^{\text{fixed}^{\text{S}^{\text{dis}}}} + a^{\text{S}^{\text{dis}}} |q_k^{\text{S}^{\text{dis}}}| \quad (22)$$

In order to write the two above constraints in a linear form, we should define two auxiliary variables $\check{q}_k^{\text{S}^{\text{CHP}}}$ and $\check{q}_k^{\text{S}^{\text{dis}}}$. If $q_k^{\text{S}^{\text{CHP}}}$ and $q_k^{\text{S}^{\text{dis}}}$ are positive these two auxiliary variables are equal to zero otherwise they are equal to $q_k^{\text{S}^{\text{CHP}}}$ and $q_k^{\text{S}^{\text{dis}}}$, respectively. Using the described techniques in [21], these two auxiliary variables can be defined by incorporating the below mixed integer linear constraint.

$$\varepsilon - (\underline{q}^{\text{S}^{\text{CHP}}} + \varepsilon) b_k^{\text{S}^{\text{CHP}}} \leq q_k^{\text{S}^{\text{CHP}}} \leq \bar{q}^{\text{S}^{\text{CHP}}} (1 - b_k^{\text{S}^{\text{CHP}}}) \quad (23)$$

$$\varepsilon - (\underline{q}^{\text{S}^{\text{dis}}} + \varepsilon) b_k^{\text{S}^{\text{dis}}} \leq q_k^{\text{S}^{\text{dis}}} \leq \bar{q}^{\text{S}^{\text{dis}}} (1 - b_k^{\text{S}^{\text{dis}}}) \quad (24)$$

$$-b_k^{\text{S}^{\text{CHP}}} \underline{q}^{\text{S}^{\text{CHP}}} \leq \check{q}_k^{\text{S}^{\text{CHP}}} \leq b_k^{\text{S}^{\text{CHP}}} \bar{q}^{\text{S}^{\text{CHP}}} \quad (25)$$

$$-(1 - b_k^{\text{S}^{\text{CHP}}}) \underline{q}^{\text{S}^{\text{CHP}}} \leq q_k^{\text{S}^{\text{CHP}}} - \check{q}_k^{\text{S}^{\text{CHP}}} \leq (1 - b_k^{\text{S}^{\text{CHP}}}) \bar{q}^{\text{S}^{\text{CHP}}} \quad (26)$$

$$-b_k^{\text{S}^{\text{dis}}} \underline{q}^{\text{S}^{\text{dis}}} \leq \check{q}_k^{\text{S}^{\text{dis}}} \leq b_k^{\text{S}^{\text{dis}}} \bar{q}^{\text{S}^{\text{dis}}} \quad (27)$$

$$-(1 - b_k^{\text{S}^{\text{dis}}}) \underline{q}^{\text{S}^{\text{dis}}} \leq q_k^{\text{S}^{\text{dis}}} - \check{q}_k^{\text{S}^{\text{dis}}} \leq (1 - b_k^{\text{S}^{\text{dis}}}) \bar{q}^{\text{S}^{\text{dis}}} \quad (28)$$

Now, (21) and (22) could be replaced by two linear relations as

$$C_k^{\text{S}^{\text{CHP}}} = C^{\text{fixed}^{\text{S}^{\text{CHP}}}} + (a^{\text{S}^{\text{CHP}}} q_k^{\text{S}^{\text{CHP}}}) - 2a^{\text{S}^{\text{CHP}}} \check{q}_k^{\text{S}^{\text{CHP}}} \quad (29)$$

$$C_k^{\text{S}^{\text{dis}}} = C^{\text{fixed}^{\text{S}^{\text{dis}}}} + (a^{\text{S}^{\text{dis}}} q_k^{\text{S}^{\text{dis}}}) - 2a^{\text{S}^{\text{dis}}} \check{q}_k^{\text{S}^{\text{dis}}} \quad (30)$$

D. Production-demand balance

First, define

$$q_k^{\text{tra}} = (q_k^{\text{CHP}} + q_k^{\text{buy}} - q_k^{\text{S}^{\text{CHP}}}) (1 - \gamma^{\text{tra}}) \quad (31)$$

$$q_k^{\text{dis}} = q_k^{\text{HP}} + q_k^{\text{EB}} \quad (32)$$

The following constraint should be satisfied in order to maintain the balance between production and demand.

$$q_k^{\text{demand}} = q_k^{\text{tra}} + q_k^{\text{dis}} - q_k^{\text{S}^{\text{dis}}} \quad (33)$$

According to our model, q_k^{tra} can be positive or negative. However, there are two technical constraints that should be satisfied in practical applications. The first is dealing with the volume of the transmitted heat, expressed as follows.

$$\gamma_{\min}^{\text{tra}} \bar{q}^{\text{tra}} \leq |q_k^{\text{tra}}| \leq \bar{q}^{\text{tra}} \text{ or } q_k^{\text{tra}} = 0 \quad (34)$$

Here, $\gamma_{\min}^{\text{tra}}$ is a constant factor about 0.1 determining the heat flow through the transmission line should not be less than a percentage of its maximum value.

The second constraint is dealing with the direction of the transmitted heat and expresses that the sign of q^{tra} should be same at least for a specific time span to avoid ‘‘cold plugs’’ phenomena.

$$\text{sign}(q_k^{\text{tra}}) \cdot \text{sign}(q_{k-l}^{\text{tra}}) \geq 0 \quad l = \underbrace{1, 2, \dots, L^{\text{sign}}}_{\text{specific time span}} \quad (35)$$

Fortunately, both constraints could be expressed as mixed integer linear constraints by using the described techniques in [21]. The details, could be found in [22].

E. Combined day-ahead planning of EP and heat markets

This section introduces a multi-step optimization for combined day-ahead planning of EP and heat markets. At first, future hourly heat demands (q_k^{demand}) and EP prices are estimated within the 24 hours day-ahead as well as an extra prediction horizon (EPH), according to our best knowledge. The extra prediction horizon is not necessary but it will increase our precision at the cost of more computation load. In addition, a certain percentage of HP and EB should be reserved for aFRR and mFRR biddings and the remaining capacity is exploited in day-ahead Elspot planning. Then an optimization program is run to minimize the sum of operation costs (Fig. 8).

$$\min_{q_k^{\text{CHP}}, p_k^{\text{CHP}}, q_k^{\text{buy}}, q_k^{\text{HP}}, q_k^{\text{EB}}, q_k^{\text{S}^{\text{CHP}}}, q_k^{\text{S}^{\text{dis}}}} \sum_{k=1}^{\text{PH}} C_k \quad (36)$$

s.t. associated constraints.

According to the previous section, we can write

$$C_k = C^{\text{fixed}} + \mathbf{a}_k \mathbf{x}_k + \mathbf{b}_k^{\text{start}} \mathbf{c}^{\text{start}}$$

$$\mathbf{b}_k^{\text{start}} = [b_k^{\text{start}^{\text{HP}}} \quad b_k^{\text{start}^{\text{EB}}}]$$

$$\mathbf{c}^{\text{start}} = [c^{\text{start}^{\text{HP}}} \quad c^{\text{start}^{\text{EB}}}]^T$$

where

$$\mathbf{a}_k = [\mathbf{a}_k^{\text{CHP}} \quad a_k^{\text{buy}} \quad a_k^{\text{HP}} \quad a_k^{\text{EB}} \quad a^{\text{S}^{\text{CHP}}} \quad a^{\text{S}^{\text{dis}}} \quad -2a^{\text{S}^{\text{CHP}}} \quad -2a^{\text{S}^{\text{dis}}}]$$

$$\mathbf{x}_k = [x_k^{\text{CHP}} \quad q_k^{\text{buy}} \quad q_k^{\text{HP}} \quad q_k^{\text{EB}} \quad q_k^{\text{S}^{\text{CHP}}} \quad q_k^{\text{S}^{\text{dis}}} \quad \check{q}_k^{\text{S}^{\text{CHP}}} \quad \check{q}_k^{\text{S}^{\text{dis}}}]^T$$

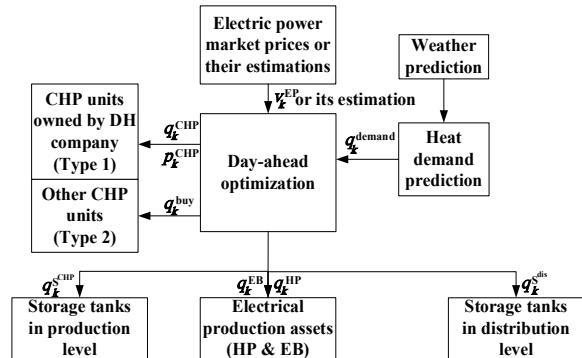

Fig. 8. Optimization problem

Considering the markets mechanism described in former sections, the optimization program (36) could not be run at one step but should be run iteratively several times to determine the optimum plan. The below algorithm describes the procedure. The accent \sim in the following algorithm denotes temporary values.

1. Run the optimization program (36) with the best estimate for q_k^{demand} and v_k^{EP} . Denote the results by

$$\tilde{q}_k^{\text{CHP}}, \tilde{p}_k^{\text{CHP}}, \tilde{q}_k^{\text{buy}}, \tilde{q}_k^{\text{HP}}, \tilde{q}_k^{\text{EB}}, \tilde{q}_k^{\text{S}^{\text{CHP}}}, \tilde{q}_k^{\text{S}^{\text{dis}}}, \quad k = 1, 2, \dots, 24, \underbrace{25, \dots, \text{PH}}_{\text{EPH}}$$

2. Bid in the heat market for $\tilde{q}_k^{\text{buy}}, k = 1, 2, \dots, 24$ resulted from step 1. Denote the accepted amounts by $q_k^{\text{buy}}, k = 1, 2, \dots, 24$.

3. Run the optimization program (36) again while q_k^{buy} has been fixed for $k = 1, 2, \dots, 24$. Again, use the best estimation for day-ahead prices v_k^{EP} and q_k^{demand} . Denote the results by

$$\tilde{q}_k^{\text{CHP}}, \tilde{p}_k^{\text{CHP}}, \tilde{q}_k^{\text{HP}}, \tilde{q}_k^{\text{EB}}, \tilde{q}_k^{\text{S}^{\text{CHP}}}, \tilde{q}_k^{\text{S}^{\text{dis}}}, \quad k = 1, 2, \dots, \text{PH}$$

$$\tilde{q}_k^{\text{buy}}, \quad k = 25, 26, \dots, \text{PH}$$

4. Using \tilde{q}_k^{HP} and \tilde{q}_k^{EB} resulted in step 3, compute the estimated hourly EP demand as follows.

$$\tilde{p}_k^{\text{demand}} = \frac{\tilde{q}_k^{\text{HP}}}{COP_k} (\sigma^{\text{HP}}) + \frac{\tilde{q}_k^{\text{EB}}}{\eta^{\text{EB}}} (\sigma^{\text{EB}})$$

Here, COP_k is the best estimate of HP coefficient of performance.

5. Bid in Elspot for the \tilde{p}_k^{CHP} as well as $\tilde{p}_k^{\text{demand}}$ for $k = 1, 2, \dots, 24$ according to the results of the step 4. Denote the accepted values by p_k^{CHP} and p_k^{demand} for $k = 1, 2, \dots, 24$.

6. After the clearance of day-ahead prices at 12:00, another optimization should be done with real prices and commitments to determine the final day-ahead plan. In this step, there is no uncertainty about day-ahead prices as well as the commitments. So, run the optimization program (36) again with the exact day-ahead prices (v_k^{EP}), q_k^{buy} , p_k^{CHP} for $k = 1, 2, \dots, 24$ as well as the following constraint.

$$p_k^{\text{demand}} = \frac{q_k^{\text{HP}}}{COP_k} (\sigma^{\text{HP}}) + \frac{q_k^{\text{EB}}}{\eta^{\text{EB}}} (\sigma^{\text{EB}}), k = 1, 2, \dots, 24$$

It will result in the final day ahead plan. Fig. 9 shows the day-ahead planning steps as a flowchart.

Remark 1. Step 4 could be done several times with different estimations of day-ahead prices v_k^{EP} to produce some Price-Demand profiles like Fig. 10. These profiles will help to determine an optimum cap on the day-ahead bid.

V. PARTICIPATION IN EP RESERVE CAPACITY MARKET

According to the former section, day-ahead planning determines the following parameters for upcoming hours.

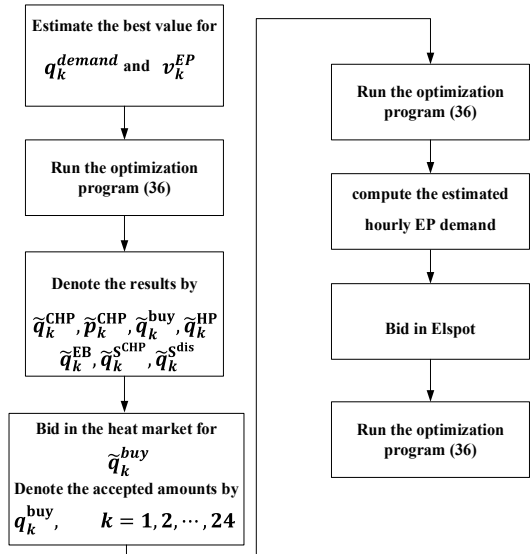

Fig. 9. Day-ahead planning as a flowchart

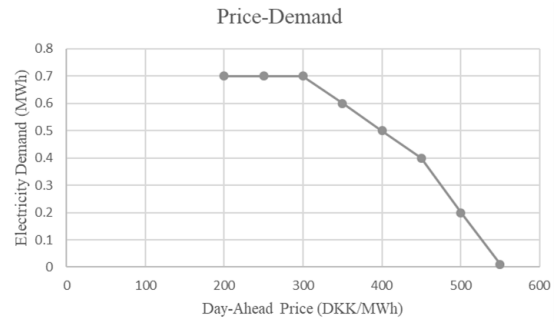

Fig. 10. Price-Demand profile

$$p_k^{\text{CHP}}, q_k^{\text{CHP}}, q_k^{\text{buy}}, q_k^{\text{HP}}, q_k^{\text{EB}}, q_k^{\text{S}^{\text{CHP}}}, q_k^{\text{S}^{\text{dis}}}$$

Now, assume at the moment t , which might be the beginning of current hour or within it, the DH company decides (or is forced) to deviate from its former plan. It might be due to several reasons including making up for the incorrect predictions such as demands or COP, responding to the received signals from TSOs due to participating in EP reserve markets and unforeseen technical problems. By the way, it will affect the production costs. In this case, four different time spans should be distinguished as follows.

- Δt_- : If it is the beginning of the current hour, Δt_- is set to the last hour, otherwise it is set to the elapsed time of the current hour. We denote the value of variable $*$ in this time span by $*_{\Delta t_-}$.
- Δt_+ : The remaining time of the current hour is denoted by Δt_+ . We use notation $*_{\text{old},0}$ to denote the scheduled value of variable $*$ within this time span according to the former plan. Similarly, $*_{\text{new},0}$ denotes the new value of variable $*$ within this time span according to the revised plan.
- Commitment Period (CP): The commitment period is the set of all upcoming hours that the DH company has commitment to the EP market.
- Upcoming hours that do not belong to the commitment period (EPH): This extra prediction horizon is strictly speaking not necessary, but it will increase our precision at

the cost of a greater computation load.

We denote the scheduled value of variable $*$ within the i^{th} upcoming hour according to the former plan by $*_{old,i}$ and its new value due to a deviation from the former plan by $*_{new,i}$. Also, to simplify our notations, $*_{new,-1}$ is equivalent to $*_{\Delta t_-}$. Define

$$\Delta C_i = C_{new,i} - C_{old,i}, \quad i = \underbrace{0}_{\Delta t_+}, \underbrace{1, 2, \dots, L^{\text{CP}}}_{\text{CP}}, \underbrace{L^{\text{CP}} + 1, \dots}_{\text{EPH}} \quad (37)$$

ΔC_i can be expressed as

$$\Delta C_i = \Delta C_i^{\text{CHP}} + \Delta C_i^{\text{buy}} + \Delta C_i^{\text{HP}} + \Delta C_i^{\text{EB}} + \Delta C_i^{\text{S}^{\text{CHP}}} + \Delta C_i^{\text{S}^{\text{dis}}}$$

In the following subsection, we will discuss each term in detail.

A. Real-time changes in CHP production costs

We use notation ΔC_i^{CHP} for $i \geq 0$ to indicate the changes in the production cost of the first-type CHP unit during time span Δt_+ as well as upcoming hours. It is calculated as follows.

$$\Delta C_0^{\text{CHP}} = \alpha^{\text{M\&O}^{\text{CHP}}} \left((p_{new,0}^{\text{CHP}} - p_{old,0}^{\text{CHP}}) + (q_{new,0}^{\text{CHP}} - q_{old,0}^{\text{CHP}}) \right) + \alpha^{\text{fuel}^{\text{CHP}}} (f_{new,0}^{\text{CHP}} - f_{old,0}^{\text{CHP}}) - (p_{new,0}^{\text{CHP}} - p_{old,0}^{\text{CHP}}) v_{new,0}^{\text{EP}} \quad (38)$$

$$\Delta C_i^{\text{CHP}} = \alpha^{\text{M\&O}^{\text{CHP}}} \left((p_{new,i}^{\text{CHP}} - p_{old,i}^{\text{CHP}}) + (q_{new,i}^{\text{CHP}} - q_{old,i}^{\text{CHP}}) \right) + \alpha^{\text{fuel}^{\text{CHP}}} (f_{new,i}^{\text{CHP}} - f_{old,i}^{\text{CHP}}), \quad i \in \text{CP} \quad (39)$$

$$\Delta C_i^{\text{CHP}} = \alpha^{\text{M\&O}^{\text{CHP}}} \left((p_{new,i}^{\text{CHP}} - p_{old,i}^{\text{CHP}}) + (q_{new,i}^{\text{CHP}} - q_{old,i}^{\text{CHP}}) \right) + \alpha^{\text{fuel}^{\text{CHP}}} (f_{new,i}^{\text{CHP}} - f_{old,i}^{\text{CHP}}) - (p_{new,i}^{\text{CHP}} v_{new,i}^{\text{EP}} - p_{old,i}^{\text{CHP}} v_{old,i}^{\text{EP}}), \quad i \in \text{EPH} \quad (40)$$

All three above relations can be rewritten in a general form as follows by using (5).

$$\Delta C_i^{\text{CHP}} = \Delta C_{\text{fixed},i}^{\text{CHP}} + \mathbf{a}_{new,i}^{\text{CHP}} \cdot \mathbf{x}_{new,i}^{\text{CHP}}, \quad i \geq 0 \quad (41)$$

where $\mathbf{a}_{new,i}^{\text{CHP}}$ is a vector determined by the CHP characteristics as well as $v_{new,i}^{\text{EP}}$ and data about the former plan while $\mathbf{x}_{new,i}^{\text{CHP}}$ is a vector defined as $\mathbf{x}_{new,i}^{\text{CHP}} = [p_{new,i}^{\text{CHP}} \quad q_{new,i}^{\text{CHP}}]^T$. Again, all associated variables and their rates should be bounded by their maximum and minimum values, according to technical constraints.

In addition, if the i^{th} upcoming hour belongs to CP, considering the commitment to day-ahead market, the DH company should compensate for the changes in its plan during this hour by exploiting its HP and EB. So, the DH company should satisfy the following constraint, internally.

$$p_{new,i}^{\text{CHP}} - p_{old,i}^{\text{CHP}} = (p_{new,i}^{\text{HP}} - p_{old,i}^{\text{HP}})(\delta_{\text{total}}^{\text{HP}}) + (p_{new,i}^{\text{EB}} - p_{old,i}^{\text{EB}})(\delta_{\text{total}}^{\text{EB}}), \quad i \in \text{CP} \quad (42)$$

We use notation ΔC_i^{buy} for $i \geq 0$ to indicate the changes in the heat-buying cost from the second-type CHP unit during time span Δt_+ as well as upcoming hours. It is calculated as follows.

$$\Delta C_0^{\text{buy}} = \alpha^{\text{buy}} (q_{new,0}^{\text{buy}} - q_{old,0}^{\text{buy}}) - \beta^{\text{buy}} (q_{new,0}^{\text{buy}} - q_{old,0}^{\text{buy}}) v_{new,0}^{\text{EP}} \quad (43)$$

$$\Delta C_i^{\text{buy}} = \alpha^{\text{buy}} (q_{new,i}^{\text{buy}} - q_{old,i}^{\text{buy}}) - \beta^{\text{buy}} (q_{new,i}^{\text{buy}} v_{new,i}^{\text{EP}} - q_{old,i}^{\text{buy}} v_{old,i}^{\text{EP}}), \quad i > 0 \quad (44)$$

Again, the both above relations could be written in a compact form as follows.

$$\Delta C_i^{\text{buy}} = \Delta C_i^{\text{fixed}^{\text{buy}}} + a_{new,i}^{\text{buy}} q_{new,i}^{\text{buy}}, \quad i \geq 0 \quad (45)$$

In general, $q_{new,i}^{\text{buy}}$ should be bounded according to the contract:

B. Real-time changes in HP and EB production costs

We denote the changes in the production cost of the HP unit during time span Δt_+ as well as upcoming hours by ΔC_i^{HP} , which is defined as below.

$$\Delta C_0^{\text{HP}} = \alpha^{\text{M\&O}^{\text{HP}}} (q_{new,0}^{\text{HP}} - q_{old,0}^{\text{HP}}) + (p_{new,0}^{\text{HP}} - p_{old,0}^{\text{HP}})(\sigma^{\text{HP}}(v_{new,0}^{\text{EP}} + \text{tar}) + \text{tax}) + (b_{new,0}^{\text{start}^{\text{HP}}} - b_{old,0}^{\text{start}^{\text{HP}}}) C^{\text{start}^{\text{HP}}} \quad (46)$$

$$\Delta C_i^{\text{HP}} = \alpha^{\text{M\&O}^{\text{HP}}} (q_{new,i}^{\text{HP}} - q_{old,i}^{\text{HP}}) + (p_{new,i}^{\text{HP}} - p_{old,i}^{\text{HP}})(\sigma^{\text{HP}} \text{tar} + \text{tax}) + (b_{new,i}^{\text{start}^{\text{HP}}} - b_{old,i}^{\text{start}^{\text{HP}}}) C^{\text{start}^{\text{HP}}}, \quad i \in \text{CP} \quad (47)$$

$$\Delta C_i^{\text{HP}} = \alpha^{\text{M\&O}^{\text{HP}}} (q_{new,i}^{\text{HP}} - q_{old,i}^{\text{HP}}) + (p_{new,i}^{\text{HP}} - p_{old,i}^{\text{HP}})(\sigma^{\text{HP}} \text{tar} + \text{tax}) + \sigma^{\text{HP}} (p_{new,i}^{\text{HP}} v_{new,i}^{\text{EP}} - p_{old,i}^{\text{HP}} v_{old,i}^{\text{EP}}) + (b_{new,i}^{\text{start}^{\text{HP}}} - b_{old,i}^{\text{start}^{\text{HP}}}) C^{\text{start}^{\text{HP}}}, \quad i \in \text{EPH} \quad (48)$$

Again, all above three relations can be written in a general compact form as follows

$$\Delta C_i^{\text{HP}} = \Delta C_i^{\text{fixed}^{\text{HP}}} + a_{new,i}^{\text{HP}} q_{new,i}^{\text{HP}} + b_{new,i}^{\text{start}^{\text{HP}}} C^{\text{start}^{\text{HP}}}, \quad i \geq 0 \quad (49)$$

where $a_{new,i}^{\text{HP}}$ is a variable determined by the HP characteristics including $COP_{new,i}$ and σ^{HP} as well as $v_{new,i}^{\text{EP}}$, tax and tariff rates. In the above relations, $b_{old,i}^{\text{start}^{\text{HP}}}$ is a binary variable which is set if the HP unit is turned on according to the old plan. Similarly, $b_{new,i}^{\text{start}^{\text{HP}}}$ is a binary variable which is set if the HP unit is turned on according to the new plan. In order to define it, first we define an auxiliary binary variable $b_{new,i}^{\text{on}^{\text{HP}}}$ as follows.

$$\varepsilon b_{new,i}^{\text{on}^{\text{HP}}} \leq q_{new,i}^{\text{HP}} \leq \bar{q}^{\text{HP}} b_{new,i}^{\text{on}^{\text{HP}}}, \quad i \geq 0 \quad (50)$$

Now, $b_{new,i}^{\text{start}^{\text{HP}}}$ can be defined as

$$\varepsilon (1 - b_{new,i}^{\text{start}^{\text{HP}}}) \leq 1 + b_{new,i-1}^{\text{on}^{\text{HP}}} - b_{new,i}^{\text{on}^{\text{HP}}} \leq 2 (1 - b_{new,i}^{\text{start}^{\text{HP}}}), \quad i \geq 0. \quad (51)$$

In addition, the following constraint should be satisfied due to technical issues.

$$\gamma_{\min}^{\text{HP}} \bar{q}^{\text{HP}} b_{new,i}^{\text{on}^{\text{HP}}} \leq \frac{q_{new,0}^{\text{HP}}}{\Delta t_+} \leq \bar{q}^{\text{HP}} \quad (52)$$

$$\gamma_{\min}^{\text{HP}} \bar{q}^{\text{HP}} b_{new,i}^{\text{on}^{\text{HP}}} \leq q_{new,i}^{\text{HP}} \leq \bar{q}^{\text{HP}}, \quad i \geq 1 \quad (53)$$

We denote the changes in the production cost of the EB unit during time span Δt_+ as well as upcoming hours by ΔC_i^{EB} ,

which could be calculated in a similar way.

C. Real-time changes in storage costs

The energy stored in the heat accumulator tank at the end of the current hour at the production level is denoted by $E_{new,0}^{S^{CHP}}$. It is computed as follows.

$$E_{new,0}^{S^{CHP}} = (\Delta t_+) (1 - \gamma^{S^{CHP}}) E_{\Delta t_-}^{S^{CHP}} + q_{new,0}^{S^{CHP}} \quad (54)$$

where $E_{\Delta t_-}^{S^{CHP}}$ is the stored energy in the tanks right before the moment t .

The energy stored in the heat accumulator tank at the end of the i^{th} upcoming hour in the production level is denoted by $E_{new,i}^{S^{CHP}}$ and is computed as follows.

$$E_{new,i}^{S^{CHP}} = (1 - \gamma^{S^{CHP}}) E_{new,i-1}^{S^{CHP}} + q_{new,i}^{S^{CHP}}, \quad i \geq 1 \quad (55)$$

Similarly, $E_{new,0}^{S^{dis}}$ and $E_{new,i}^{S^{dis}}$ denote the energy stored in the heat accumulator tank at the distribution level and are computed in a similar way.

As before, all associated variables and their rates should be bounded by their maximum and minimum values, according to technical constraints.

For safety reasons, we impose the following constraint to guarantee the heat supply in the case of unforeseen technical issues for production assets.

$$(1 - \gamma^{S^{CHP}}) E_{new,i}^{S^{CHP}} + (1 - \gamma^{S^{dis}}) E_{new,i}^{S^{dis}} \geq q_{new,i+1}^{demand}, \quad i \geq 0 \quad (56)$$

We denote the changes in the storage cost in production and distribution levels during time span Δt_+ as well as upcoming hours by $\Delta C_i^{S^{CHP}}$ and $\Delta C_i^{S^{dis}}$, which are defined as

$$\Delta C_i^{S^{CHP}} = a^{S^{CHP}} (|q_{new,i}^{S^{CHP}}| - |q_{old,i}^{S^{CHP}}|) + v_{new,i}^{S^{CHP}} (q_{old,i}^{S^{CHP}} - q_{new,i}^{S^{CHP}}), \quad i \geq 0 \quad (57)$$

$$\Delta C_i^{S^{dis}} = a^{S^{dis}} (|q_{new,i}^{S^{dis}}| - |q_{old,i}^{S^{dis}}|) + v_{new,i}^{S^{dis}} (q_{old,i}^{S^{dis}} - q_{new,i}^{S^{dis}}), \quad i \geq 0 \quad (58)$$

where $v_{new,j}^{S^{CHP}}$ and $v_{new,j}^{S^{dis}}$ are two parameters introduced to prevent the optimization problem from depleting the accumulated heat in the storage tanks. They can be regarded as tuning parameters.

Again, the constraints (57) and (58) could be substituted by mixed integer linear constraints using similar techniques as before.

D. Production-Demand balance

The following production-demand balance constraint should be satisfied.

$$q_{new,i}^{demand} = q_{new,i}^{tra} + q_{new,i}^{dis} - q_{new,i}^{distribution}, \quad i \geq 0 \quad (59)$$

where

$$q_{new,i}^{tra} = q_{new,i}^{CHP} + q_{new,i}^{buy} - q_{new,i}^{S^{CHP}} - q_{new,i}^{Lost}, \quad i \geq 0 \quad (60)$$

$$q_{new,i}^{dis} = q_{new,i}^{HP} + q_{new,i}^{EB}, \quad i \geq 0 \quad (61)$$

Again, the following technical constraints should be

satisfied for the volume and direction of the transmitted heat.

$$\gamma_{min}^{tra} \bar{q}^{tra} \leq |q_{new,i}^{tra}| \leq \bar{q}^{tra} \text{ or } q_{new,i}^{tra} = 0, \quad i \geq 0 \quad (62)$$

$$\text{sign}(q_{new,i}^{tra}) \cdot \text{sign}(q_{new,i-l}^{tra}) \geq 0, \quad l = 1, 2, \dots, L^{sign}, \quad i \geq 0 \quad (63)$$

E. Real-time EMPC

Now, the following optimization program should be solved iteratively in a receding horizon manner to minimize the costs (or equivalently maximize the gains) as well as to cope with uncertainties in real-time. The idea has been shown in Fig. 11.

$$\begin{aligned} \min & \quad \left(\Delta C_0 + \sum_{i \in CP} \Delta C_i + \right. \\ & \quad \left. \sum_{i \notin CP, i \neq 0} \Delta C_i \right) \quad (64) \\ \text{s.t.} & \quad \text{associated constraints.} \end{aligned}$$

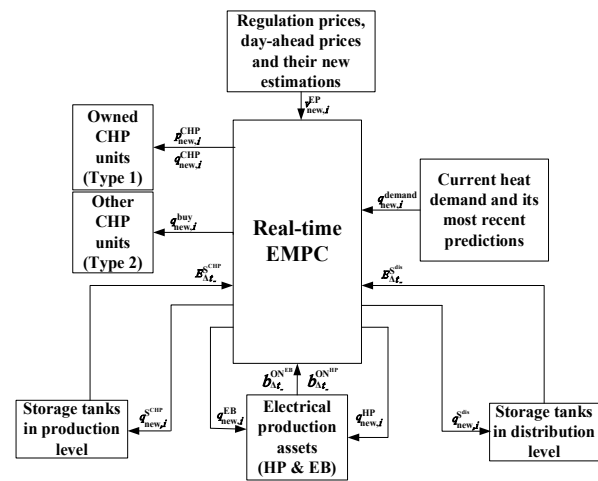

Fig. 11. Real-time EMPC

Remark 2. At the first iteration, use the day-ahead values as old values for all variables. At the next iterations, use the obtained values from the former iteration as old values of the variables.

Remark 3. $v_{new,0}^{EP}$ will be equal to the regulation prices in EP network within the current hour while $v_{old,0}^{EP}$ represent the day-ahead prices in EP network within the current hour.

Remark 4. For $i \in CP$, $v_{new,i}^{EP} = v_{old,i}^{EP}$ and both of them are equal to day-ahead prices in EP market.

Remark 5. For $i \in EPH$, $v_{new,i}^{EP}$ is equal to the new estimation of day-ahead prices in the EP market and $v_{old,i}^{EP}$ is equal to the old estimation of day-ahead prices in the EP market

Remark 6. The heat market is completely different from the EP market in many aspect. So, if the optimization results in $q_{new,j}^{buy} \neq q_{old,j}^{buy}$, it must be confirmed with the CHP authorities. If it is not confirmed by them, the optimization should be solved again while imposing the constraint $q_{new,j}^{buy} = q_{old,j}^{buy}$.

Remark 7. The optimization could also be exploited offline after finalizing of day-ahead Elspot planning to determine the optimal bidding on additional mFRR reserves.

VI. CASE STUDY SPECIFICATIONS, SIMULATION RESULTS AND DISCUSSION

The case study is a small suburban area in the south-western part of Aarhus, Denmark. It has largely merged with neighboring suburbs in recent years.

As of today, there is a 26 MW heat exchanger to provide the area with heat from the main pipeline, which is supplied by CHP units. Because of new residential and industrial developments, the demand for heat is increasing in this area and it is expected to reach a peak demand of 50 MW in the near future. The DH company intends to exploit HP, EB and storage tank in its distribution level to supply the new demand according to Fig. 2. In the following, we adapt our developed model in previous sections to this situation. The required parameters have been provided in TABLE I in Appendix. Also, We used the Carnot formula to approximate COP_k .

Three different scenarios were analyzed in this study.

- Scenario 0: Conventional paradigm without exploiting HP and EB (CHP units provide all heat demand).
- Scenario 1: New paradigm, exploiting the full capacity of HP and EB in day-ahead planning.
- Scenario 2: New paradigm, exploiting 80% capacity of HP and EB in day-ahead planning and reserving 20% of their capacity for playing in reserve capacity market

In Scenario 0, the capacity of transmission line was set to 50 MW while in the two other scenarios it was set to 26 MW. Assuming a perfect power price prediction, day-ahead planning was done according to the described procedure in Section IV for the following four time spans in 2018: 1-14 January, 1-14 April, 1-14 July and 1-14 October

The prediction horizon was set to 14 days. The proposed EMPC approach in Section V was applied to the case study using MATLAB R2018b and its associated optimization toolbox. To take the advantage of regulation prices by participating in mFRR reserve market, an hourly base, i.e. $\Delta t_+ = 1$ was implemented. For the sake of fairness and clarity, $v_{new,i}^{S_{CHP}}$ and $v_{new,i}^{S_{dis}}$ were set to 0 and instead, the optimization problem was forced to keep the same level of accumulated heat in storage tanks as it was scheduled in the day-ahead plan at the end of each day within the prediction horizon.

Fig. 12 shows the total amount of regulating power contributed by the DH company in the reserve capacity market according to the proposed algorithm. As can be seen, the conventional paradigm is more effective in providing regulating power when the heat demand is high, e.g. in January. However, the new paradigm is as capable as the conventional one (or even better) at other times. In addition, it is observed that reserving a percentage of the EB and HP capacity for playing in reserve capacity market (Scenario 2), will improve the capability of providing regulating power, significantly.

Fig. 13 shows the economical revenue from participation in reserve capacity market as well as the operation costs. As seen, reserving a percentage of the EB and HP capacity for playing in reserve capacity market (Scenario 2) will not increase the operation cost significantly. However, it increases the economical revenue from mFRR considerably, which will

make up for the extra operation costs of the new paradigm to some extent.

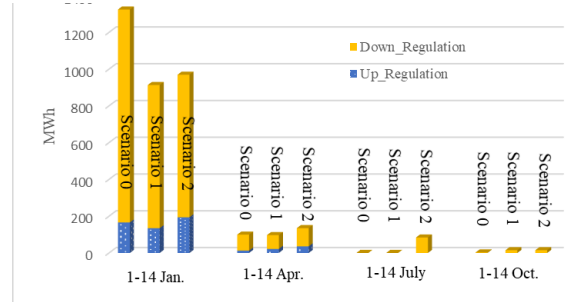

Fig. 12. Regulating power contributed by the DH company

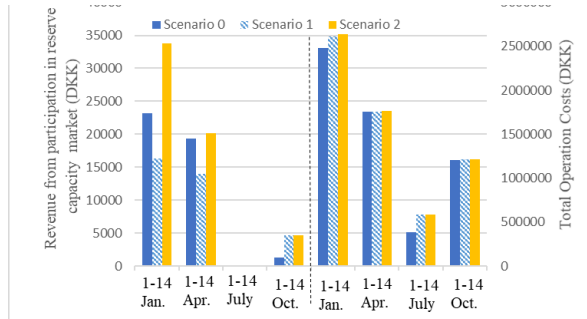

Fig. 13. Economic revenue from mFRR and total operation costs

Remark 8. On the July 1-14 period, the heat consumption is at its minimum level. As a result, HPs and EBs do not work within this period and are mostly off. Therefore, there are not such flexibility for DH companies to participate in the reserve markets. Consequently, it is logical to have no revenue in this period.

Remark 9. A few other scenarios were simulated in this study. However, the results are mostly similar to the ones shown here and omitted for considerations of space.

VII. CONCLUSION

District heating (DH) companies are being encouraged by new green energy policies to exploit HPs and EBs in their distribution network level besides the traditional central CHP units. Accordingly, the interaction and interdependence between district heating networks and electricity markets will be intensified. This study examines how DH companies can manage this extra complexity and whether or not they can contribute towards balancing the production and consumption in electric power (EP) network in an efficient way through playing in the reserve capacity markets. The framework is applied to a real world case study and the results are discussed. It is seen that although the new paradigm increases operation costs, reserving a part of the capacity for playing in reserve capacity market, will make up for the extra costs to some extent and also improve the capability of providing regulating power. It should be noted that this paper only considers the mFRR reserve market. Participation in other reserve markets, especially FCR, is left for future work.

VIII. APPENDIX

TABLE I
Case study parameters

Parameter	Value	Unit	Parameter	Value	Unit
η^{total}	1.03	-	$\gamma^{\text{S}^{\text{CHP}}}$	0.00008	MW/MWh
η^{ele}	0.33	-	$\alpha^{\text{S}^{\text{CHP}}}$	4	DKK/MWh _Q
\bar{f}^{CHP}	110	MW	\bar{q}^{buy}	100	MW
$\underline{f}^{\text{CHP}}$	0	MW	$\underline{q}^{\text{buy}}$	10	MW
$\overline{\Delta f}^{\text{CHP}}$	55	MW/h	$\alpha^{\text{M\&O}^{\text{HP}}}$	13.5	DKK/MWh _Q
$\underline{\Delta f}^{\text{CHP}}$	55	MW/h	$C^{\text{start}^{\text{HP}}}$	500	DKK/Start
\bar{p}^{bp}	37	MW	σ^{HP}	1.1	-
$\underline{p}^{\text{bp}}$	0	MW	\bar{q}^{HP}	10	MW
\bar{p}^{bypass}	37	MW	$\gamma_{\text{min}}^{\text{HP}}$	0.1	-
\bar{q}^{bp}	77	MW	η^{HP}	0.4	-
$\underline{q}^{\text{bp}}$	0	MW	σ^{EB}	1	-
$\alpha^{\text{M\&O}^{\text{CHP}}}$	40	DKK/MWh	\bar{q}^{EB}	2	MW
$\alpha^{\text{fuel}^{\text{CHP}}}$	180	DKK/MWh	η^{EB}	0.99	-
α^{buy}	300	DKK/MWh _Q	$C^{\text{start}^{\text{EB}}}$	500	DKK/Start
β^{buy}	0	MWh _E /MWh	$\alpha^{\text{M\&O}^{\text{EB}}}$	6	DKK/MWh _Q
α_k^{buy}	300	DKK/MWh _Q	$\bar{E}^{\text{S}^{\text{dis}}}$	400	MWh _Q
tar	178.9	DKK/MWh _E	$\bar{q}^{\text{S}^{\text{dis}}}$	16	MW
tax	150	DKK/MWh _E	$\underline{q}^{\text{S}^{\text{dis}}}$	16	MW
$\bar{E}^{\text{S}^{\text{CHP}}}$	400	MWh _Q	$\gamma^{\text{S}^{\text{dis}}}$	0.00008	MW/MWh
$\bar{q}^{\text{S}^{\text{CHP}}}$	16	MW	$\alpha^{\text{S}^{\text{dis}}}$	4	DKK/MWh _Q
$\underline{q}^{\text{S}^{\text{CHP}}}$	16	MW	\bar{q}^{tra}	26	MW
			$\gamma_{\text{min}}^{\text{tra}}$	0.1	-

IX. ACKNOWLEDGMENT

Authors would like to thank Affald Varme Aarhus (AVA) for providing us with consumption and other technical data regarding the case study region.

X. REFERENCES

[1] A. R. Mazhar, S. Liu, and A. Shukla, "A state of art review on the district heating systems," *Renewable and Sustainable Energy Reviews*, vol. 96, pp. 420-439, 2018.

[2] U. Persson and S. Werner, "Heat distribution and the future competitiveness of district heating," *Applied Energy*, vol. 88, no. 3, pp. 568-576, 2011.

[3] Y. Zhou, M. Shahidehpour, Z. Wei, Z. Li, G. Sun and S. Chen, "Distributionally Robust Unit Commitment in Coordinated Electricity and District Heating Networks," *IEEE Transactions on Power Systems*, vol. 35, no. 3, pp. 2155-2166, May 2020, doi: 10.1109/TPWRS.2019.2950987.

[4] J. Wang, S. You, Y. Zong, H. Cai, C. Træholt, and Z. Y. Dong, "Investigation of real-time flexibility of combined heat and power plants in district heating applications," *Applied energy*, vol. 237, pp.196-209, 2019.

[5] J. Tan, Q. Wu, Q. Hu, W. Wei, and F. Liu, "Adaptive robust energy and reserve co-optimization of integrated electricity and heating system considering wind uncertainty," *Applied Energy*, vol. 260, p.114230, February 2020, doi: 10.1016/j.apenergy.2019.114230.

[6] M. Zhang, Q. Wu, J. Wen, Z. Lin, F. Fang, and Q. Chen, "Optimal operation of integrated electricity and heat system: A review of modeling

and solution methods," *Renewable and Sustainable Energy Reviews*, vol. 135, p.110098, 2021.

[7] Agreement between the government (the Liberal Party of Denmark, Liberal Alliance and the Conservative People's Party), Social Democracy, the Danish People's Party, the Red-Green Alliance, the Alternative, the Social Liberal Party and the Socialist People's Party. Energy Agreement of 29 June 2018. Available from: <https://en.efkm.dk/media/12307/energy-agreement-2018.pdf>

[8] M. Laura, V. Christian, B. Katharina, L. Moritz, and M. Dirk, "Economic assessment of air-to-water heat pumps in the German building stock considering heating system design and dynamic operation," Proceedings of ECOS 2019 - the 32ND International Conference on Efficiency, Cost, Optimization, Simulation and Environmental Impact of Energy Systems, June 23-28, 2019, WROCLAW, POLAND.

[9] P. Ivanova, A. Sauhats, and O. Linkevics, "District Heating Technologies: Is it Chance for CHP Plants in Variable and Competitive Operation Conditions?," *IEEE Transactions on Industry Applications*, vol. 55, no. 1, pp. 35-42, Jan.-Feb. 2019, doi: 10.1109/TIA.2018.2866475.

[10] K. Kontu, S. Rinne, and S. Junnila, "Introducing modern heat pumps to existing district heating systems—Global lessons from viable decarbonizing of district heating in Finland," *Energy*, vol. 166, pp.862-870, 2019.

[11] M. Khatibi, J. D. Bendtsen, J. Stoustrup and J. Tougaard, "Local heating concepts for upgrading district heating networks, a real world case study," Proceedings of ECOS 2019 - the 32ND International Conference on Efficiency, Cost, Optimization, Simulation and Environmental Impact of Energy Systems, June 23-28, 2019, WROCLAW, POLAND.

[12] K. Helin, S. Syri, and B. Zakeri, "Improving district heat sustainability and competitiveness with heat pumps in the future Nordic energy system," *Energy Procedia*, vol. 149, pp.455-464, 2018.

[13] B. Bach, J. Werling, T. Ommen, M. Münster, J. M. Morales, and B. Elmegaard, "Integration of large-scale heat pumps in the district heating systems of Greater Copenhagen," *Energy*, vol. 107, pp.321-334, 2016.

[14] F. Iov, M. Khatibi, and J.D. Bendtsen, "On the Participation of Power-To-Heat Assets in Frequency Regulation Markets—A Danish Case Study," *Energies*, vol. 13, no. 18, p.4608, 2020.

[15] Y. Chen, W. Wei, F. Liu, E. E. Sauma, and S. Mei, "Energy Trading and Market Equilibrium in Integrated Heat-Power Distribution Systems," *IEEE Transactions on Smart Grid*, vol. 10, no. 4, pp. 4080-4094, July 2019, doi: 10.1109/TSG.2018.2849227.

[16] R. Li, W. Wei, S. Mei, Q. Hu, and Q. Wu, "Participation of an Energy Hub in Electricity and Heat Distribution Markets: An MPEC Approach," *IEEE Transactions on Smart Grid*, vol. 10, no. 4, pp. 3641-3653, July 2019, doi: 10.1109/TSG.2018.2833279.

[17] J. Bai, L. Chen, F. Liu, and S. Mei, "Interdependence of electricity and heat distribution systems coupled by an AA-CAES-based energy hub," *IET Renewable Power Generation*, vol. 14, no.3, pp.399-407, 2019.

[18] Y. Cao, W. Wei, L. Wu, S. Mei, M. Shahidehpour, and Z. Li, "Decentralized Operation of Interdependent Power Distribution Network and District Heating Network: A Market-Driven Approach," *IEEE Transactions on Smart Grid*, vol. 10, no. 5, pp. 5374-5385, Sept. 2019, doi: 10.1109/TSG.2018.2880909.

[19] "Daily heat production plans." [varmelast.dk](https://www.varmelast.dk). <https://www.varmelast.dk/lastfordeling/varmeplaner> (accessed Oct. 14, 2020).

[20] "Ancillary services to be delivered in Denmark Tender conditions," Technical report, Energinet, Fredericia, 2012.

[21] A. Bemporad and M. Morari, "Control of systems integrating logic, dynamics, and constraints," *Automatica*, vol. 35, no. 3, pp.407-427, 1999.

[22] S. Rahnama, T. Green, C. H. Lyhne, and J. D. Bendtsen, "Industrial Demand Management Providing Ancillary Services to the Distribution Grid: Experimental Verification," *IEEE Transactions on Control Systems Technology*, vol. 25, no. 2, pp. 485-495, March 2017, doi: 10.1109/TCST.2016.2563385.

XI. BIOGRAPHIES



Mahmood Khatibi received B.S. degree in electronics engineering and M.S. degree in control engineering with honor from the Ferdowsi University of Mashhad, Mashhad, Iran, in 2005 and 2007 respectively. He was a lecturer in Imam Reza International University during 2008-2012. Then, he was with Sharif University of Technology, Tehran, Iran, where he got the Ph.D. degree in control engineering in 2017.

Since 2018, he has been with the Department of Electronic Systems, Aalborg University, Denmark, as a postdoc researcher. His research interests include predictive control, optimization and nonlinear dynamics.



Jan Dimon Bendtsen (M'11) was born in Denmark in 1972. He received the M.Sc. and Ph.D. degrees from the Department of Control Engineering, Aalborg University, Aalborg, Denmark, in 1996 and 1999, respectively. He has been an Associate Professor with the Department of Electronic Systems, Aalborg University, since 2003. In 2005, he was a Visiting Researcher with Australian National University, Canberra, ACT, Australia. Since 2006, he has been involved in the management of several

national and international research projects, and organizing international conferences. From 2012 to 2013, he was a Visiting Researcher with the University of California at San Diego, La Jolla, CA, USA. His current research interests include adaptive control of nonlinear systems, closed loop system identification, control of energy systems, and infinite-dimensional systems. Dr. Bendtsen was a co-recipient of the Best Technical Paper Award at the American Institute of Aeronautics and Astronautics Guidance, Navigation, and Control Conference in 2009.



Jakob Stoustrup (M'87, SM'99) has received an M.Sc. degree (EE, 1987) and a Ph.D. degree (Applied Mathematics, 1991), both from the Technical University of Denmark. From 1991-1996, Dr. Stoustrup held several positions at the Department of Mathematics, Technical University of Denmark. From 2006-2013 he acted as Head of Research for Department of Electronic Systems, Aalborg University. From 2014-2016, Stoustrup was Chief Scientist at Pacific Northwest National Laboratory, USA, leading

the Control of Complex Systems Initiative. From 1997-2013 and since 2016, Stoustrup has acted as Professor at Automation & Control, Aalborg University, Denmark. In 2017 Stoustrup was appointed as Vice Dean at the Technical Faculty of IT and Design, Aalborg University.

Dr. Stoustrup has acted as an Associate Editor, a Guest Editor, and an Editorial Board Member of several international journals. He has acted as General Chair or Program Chair for several international conferences. He has authored more than 300 peer-reviewed papers with more than 100 co-authors from across the world. He has carried out industrial cooperation with more than 100 private companies. His current research interests include robust control, fault-tolerant control, and plug-and-play control.



Tommy Mølbak is co-owner of Added Values, a specialist consultancy company within green energy. Focus is on optimization of future production and supply set-ups, and on operational optimization of existing production and supply assets. He has more than 25 years of experience within R&D and optimization of energy systems and assets.

He received the M.Sc. degree in electrical engineering from the Department of Control Engineering, Aalborg University, Denmark in 1987. He received his industrial PhD degree in control of CHP plants from the same department in 1991. He is now affiliated Professor at the same department.

Since master graduation he has been working in industry with control and optimization of energy production, initially at DONG Energy (now Ørsted), and

since 2013 as a co-owner of Added Values. In addition, he has continuously been focused on R&D within these fields, including cooperation with university research institutions