



**AALBORG UNIVERSITY**  
DENMARK

**Aalborg Universitet**

## **Modeling hybrid energy systems for marine applications**

*Hybrid electric ships*

Vahabzad, Neda ; Mohammadiivatloo, Behnam; Anvari-Moghaddam, Amjad

*Published in:*  
Hybrid Technologies for Power Generation

*DOI (link to publication from Publisher):*  
[10.1016/B978-0-12-823793-9.00012-7](https://doi.org/10.1016/B978-0-12-823793-9.00012-7)

*Publication date:*  
2022

*Document Version*  
Accepted author manuscript, peer reviewed version

[Link to publication from Aalborg University](#)

*Citation for published version (APA):*  
Vahabzad, N., Mohammadiivatloo, B., & Anvari-Moghaddam, A. (2022). Modeling hybrid energy systems for marine applications: Hybrid electric ships. In M. Lo Faro, O. Barbera, & G. Giacoppo (Eds.), *Hybrid Technologies for Power Generation* (pp. 419-437). Elsevier. <https://doi.org/10.1016/B978-0-12-823793-9.00012-7>

### **General rights**

Copyright and moral rights for the publications made accessible in the public portal are retained by the authors and/or other copyright owners and it is a condition of accessing publications that users recognise and abide by the legal requirements associated with these rights.

- Users may download and print one copy of any publication from the public portal for the purpose of private study or research.
- You may not further distribute the material or use it for any profit-making activity or commercial gain
- You may freely distribute the URL identifying the publication in the public portal -

### **Take down policy**

If you believe that this document breaches copyright please contact us at [vbn@aub.aau.dk](mailto:vbn@aub.aau.dk) providing details, and we will remove access to the work immediately and investigate your claim.

# Modeling Hybrid Energy Systems for Marine Applications: Hybrid Electric Ships

N. Vahabzad<sup>1</sup>, B. Mohammadi-Ivatloo<sup>1,2</sup>, A. Anvari-Moghaddam<sup>2</sup>

<sup>1</sup>Faculty of Electrical and Computer Engineering, University of Tabriz, Tabriz, Iran

<sup>2</sup>Department of Energy (AAU Energy), Aalborg University, Aalborg, Denmark

## Abstract

Nowadays, hybrid energy technologies are widely used for power generation in various transportation systems to reduce greenhouse gas emissions and global warming. In maritime transportation, due to the distance from the shore power system, there is a need for a stand-alone hybrid power system to meet the power demand and satisfy the environmental constraints of some ports. The aim of this study is to model a hybrid shipboard power system (HSPS), which includes a diesel generator, renewable energy system (RES), energy storage system, electrical heat pump (EHP), and electrical boiler (EB) system to supply electrical and thermal demands of a cruise ship, simultaneously. It is noteworthy that the applied RES is composed of photovoltaic (PV) panels and a wind turbine (WT). In addition, the energy storage system includes both electrical and thermal storage to enhance the performance of the system. On the other hand, the connection facilities are also considered to connect the ship to the local power system during the stopping hours of the ship at the port to reduce the fuel consumption and emission arising from using diesel generators. Finally, the proposed HSPS has been implemented on a real ship to prove the effectiveness of the proposed structure in reducing fuel consumption, emission, and costs compared to other suggested structures.

**Keywords:** Marine hybrid power systems, optimal shipboard operation, renewable energies, electrical energy storage, thermal energy storage, emission reduction

## 1. Introduction and literature review

Off-grid hybrid power generation systems are widely used in various applications. In particular, RES-based stand-alone power systems can be used to supply offshore load demands, river lighthouses and other remote applications [1]. The use of RESs has many environmental and economic benefits over other energy sources, especially for the reduction of marine pollution as described in [2]. PV panels and WT are of the most applicable RESs, which are available in almost all parts of the globe. They mainly depend on solar irradiation and wind speed. Therefore, they have many challenges since they are intermittent and unpredictable [3]. In most previous studies, only the WT [4] or only the PV panels [5] have been utilized as a RES in the hybrid generation system. The amount of PV panels' generation is proportional to the solar radiation [5], and the amount of WT's power is related to the wind speed [6]. On a windy day with high wind speeds, the solar radiation is often low and vice versa. Therefore, using only the WT or PV panels is able to meet the load demand only on certain days of the year when the wind speed or solar radiation is high [7]. Thus, there is a significant complementarity between

PV and WT generation potential [8]. A hybrid PV-WT system is presented in [9], that can be used to supply the given load demand.

On the other hand, due to the alternating nature of power provided by the RESs, a backup source of energy like an energy storage system is usually needed to save the surplus energy during sunny or windy weather conditions and supply the demand during gloomy or windless times [10]. In addition, the use of a diesel generator system is also essential for reliable operation [11], despite its high fuel consumption and cost terms. In particular, in marine applications, there is no connection between the power system of the watercraft and the main power grid while the facility is on seafaring. Therefore, the autonomous and reliable operation of the marine power system is a vital principle. There are many studies that have been performed on providing a reliable and stand-alone marine hybrid power system with different energy sources [12]. In this regard, a hybrid structure composed of solar PV, PEM fuel cell/diesel generator is designed in [13] to supply the electric load of a large ship. In addition, the authors in [14] proposed a configuration based on fuel cells, batteries, and cold-ironing service to have an emission-free ship. Cold-ironing service refers to the connection facilities between the ship and the shore power system, which is available by stopping the ship at the port where there is a local grid to provide power to the ship's power system.

Moreover, if the considered ship has some occupants or passengers, there is a need for some thermal equipment to meet the thermal demands of the passengers in addition to electric demand arising from propulsion and service loads. Accordingly, a hybrid power system composed of different energy sources can be a suitable structure to supply both the electrical and thermal demands [15]. A thermo-economic analysis has been performed in [16] for providing hotel and service loads related to a cruise ship without focusing on detailed modeling of the system structure. A combination of the diesel generators and electrical storage system (ESS) with some thermal equipment has been presented in [17] for cruise ships, in which the provided thermal unit consumes natural gas to provide both thermal and electrical energy. For more electrification and less dependence on different types of fuels, the application of EHP and EB system on a real cruise ship has been investigated in [18] to supply the thermal demands through electrical energy input. However, the utilization of a thermal storage system (TSS) alongside EB and EHP systems has not been considered, which could contribute to supplying thermal demand more efficiently.

This study proposed a comprehensive hybrid structure for power generation in a marine power system in order to supply the various types of load demands of a cruise ship, including propulsion, electrical and thermal demands. The proposed hybrid structure is composed of five main energy generation units, whether electrical or thermal. Each unit consisting of one or more facilities, which cooperate with each other for supplying the whole demand of the marine power system without the need for any other equipment. The various energy generation systems proposed in the HSPS include diesel generator, RES consisting of PV panels and WT, energy storage systems including both ESS and TSS, a thermal generation unit based on EHP and EB systems and a Cold-ironing service for connecting the ship to the shore power system during the stopping times of the ship at the port.

The RES and storage systems do not consume any types of fuel. In addition, thermal equipment of the proposed HSPS are chosen from electrical types, which use electrical power as input energy instead of fuel. Thus, only the diesel generator system consumes fuel for power

generation among the whole mentioned energy generation units. Therefore, the proposed HSPS can be considered as an all-electric ship. This study aims at minimizing the use of the diesel generator system in order to reduce the fuel consumption of the mentioned HSPS. However, this goal could not be achieved unless all the components of the HSPS cooperate with each other in an optimal manner. This optimal cooperation leads to a huge reduction in the total cost of the HSPS, fuel consumption, and emission.

## 2. Modeling and problem formulation

### 2.1. Modeling

The five main electrical or thermal energy generation units of the proposed HSPS, including diesel generator system, RES, energy storage systems, cold-ironing service, and thermal generation unit, are depicted in Fig. 1. Some of these generation systems are composed of two subsystems. PV and WT, which are two types of most applicable RESs on-board, are provided in the shipboard RES system. In addition, both ESS and TSS are placed in the considered power system to increase the efficiency of both thermal and electrical generation systems. On the other hand, EHP and EB systems are applied in the thermal generation unit, which has electrical input energy. These energy generation systems and subsystems are utilized in the proposed HSPS for the aim of supplying the electrical and thermal demands with high efficiency and low cost.

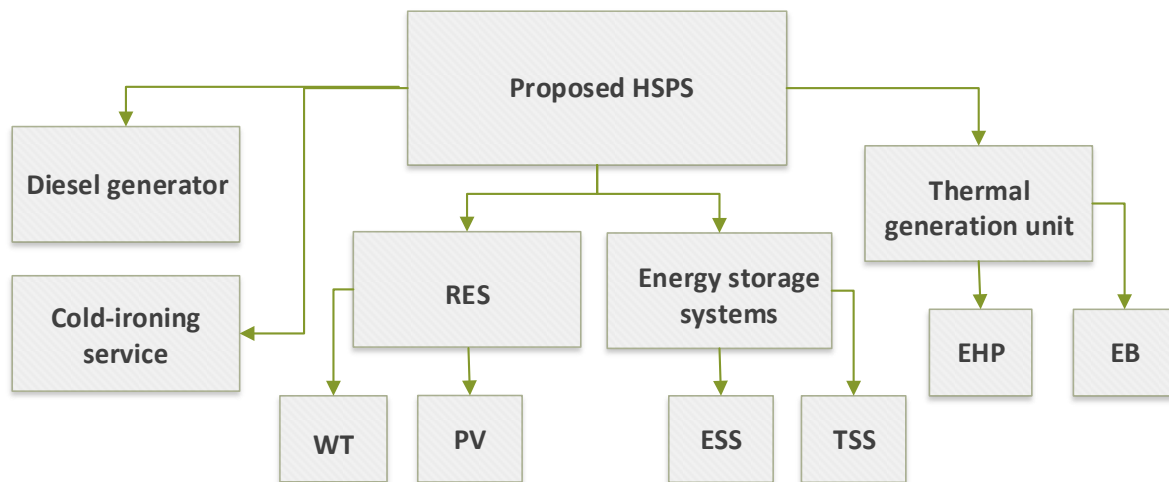

**Fig. 1.** Structure of the proposed HSPS

The cooperation of the mentioned energy generation units has provided an all-electric structure for the considered ship, where a part of electrical power generated by a diesel generator, RES, ESS, and cold-ironing service is given to EHP and EB to generate the required thermal energy in addition to the part which used for meeting the electrical demand. Fig. 2 illustrates thermal and electrical power flows between the different components and load demands of the proposed all-electric ship.

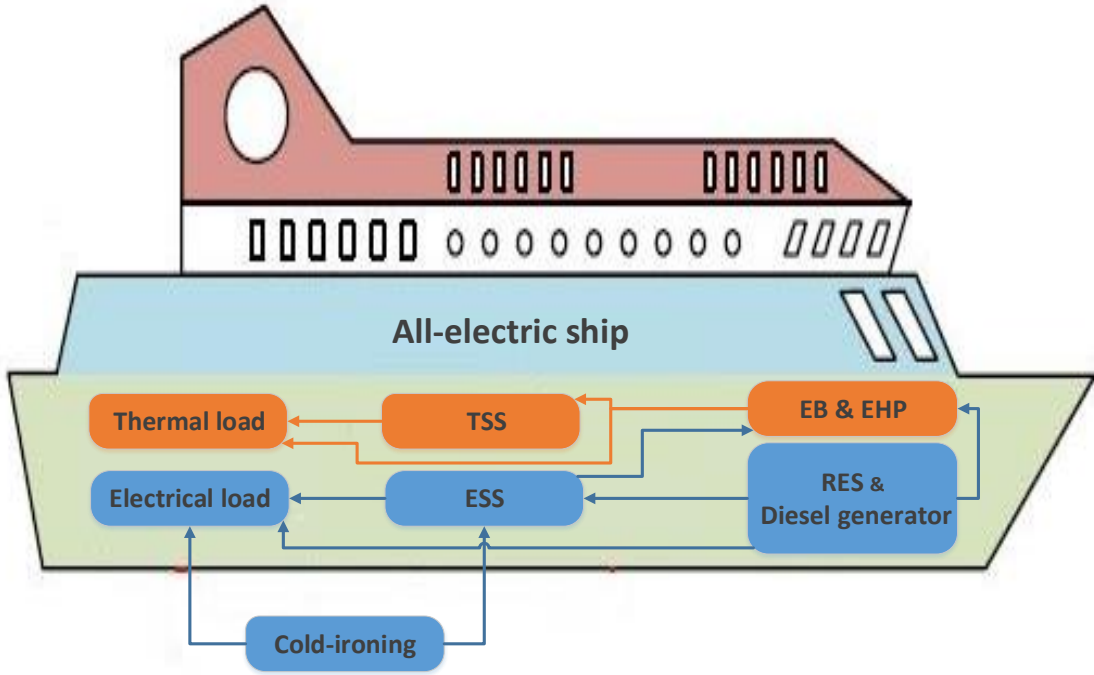

**Fig. 2.** Thermal and electrical power flows of the proposed all-electric ship (thermal power flows marked by orange-electrical power flows marked by blue)

## 2.2. Problem formulation

The power generation of each energy unit, the relations between their input and output energies and their related parameters, as well as the constraints and limitations are modeled to formulate the optimal operation problem of the proposed HSPS. In addition, the cost terms related to the operation of the systems which purchase power or fuel from out of the ship are provided. Finally, an objective function is proposed to minimize the total cost subject to emission constraints and some other constraints arising from the specifications of each generation system.

### 2.2.1. Diesel generator

Diesel generator system uses an input of fuel for generating electric power. Hence, the fuel consumption of the diesel generator system  $FC_{DG}(t)$  must be first calculated using (1), which is dependent on the generated power  $P_{DG}^{out}(t)$  at each time interval and the rated power  $P_{DG}^{ref}$  [19]:

$$FC_{DG}(t) = m \times P_{DG}^{out}(t) + n \times P_{DG}^{ref} \quad (1)$$

where,  $m$  and  $n$  are the diesel generator fuel consumption curve coefficients.

Diesel generator's output power at each time interval has to be limited to the minimum and maximum output ranges of that diesel generator:

$$P_{DG}^{\min} \leq P_{DG}^{out}(t) \leq P_{DG}^{\max} \quad (2)$$

where,  $P_{DG}^{\max}$  is the rated power and  $P_{DG}^{\min}$  is the minimum required level of the output power, which is one of the diesel generator characteristics.

Considering the formulated fuel consumption, the cost related to the hourly fuel consumption of the diesel generator system is stated in the following [20]:

$$C_{DG}^{fuel}(t) = PF \times (FC_{DG}(t)) \quad (3)$$

Furthermore, the other cost terms of the diesel generator also depend on its fuel consumption. Thus, they can be calculated as below [20]:

$$C_{DG}^{emission}(t) = PE \times (FC_{DG}(t)) \quad (4)$$

$$C_{DG}^{maintenance}(t) = PM \times (FC_{DG}(t)) \quad (5)$$

where,  $C_{DG}^{emission}(t)$  indicates the hourly emission cost and  $C_{DG}^{maintenance}(t)$  refers to the hourly maintenance cost. In addition, the diesel generator fuel price, emission and maintenance coefficients are represented by  $PF$ ,  $PE$  and  $PM$ , respectively [5].

The total cost related to the operation of the diesel generator system at time interval  $t$ , including fuel, emission, and maintenance costs, can be represented by (6), which causes a large portion of the total cost of the HSPS.

$$C_{DG}^{total}(t) = C_{DG}^{fuel}(t) + C_{DG}^{emission}(t) + C_{DG}^{maintenance}(t) \quad (6)$$

## 2.2.2. RES

In order to use all the potentials of the surrounding nature for providing clean and free energy, the provided RES system of this study includes both PV panels and WT. The amount of generated power of the mentioned renewable-based power generation systems is dependent on several environmental and technical parameters, which are discussed in the following.

### 2.2.2.1. PV panels

The output power of PV panels in time interval  $t$  depends on the solar radiation density per hour  $G(t)$ , solar panels temperature  $T^C$  and some other factors including solar panels temperature coefficient  $\tau$  and solar panels reference temperature, which are taken  $0.048 T^{C,ref}$  and  $25^\circ C$ , respectively. Equation (7) represents the relation between the output power of PV panels and its related parameters [2]:

$$P_{PV}(t) = K \times [1 - \tau(T^C - T^{C,ref})] \times G(t) \quad (7)$$

where,  $K$  consists of multiplying several factors according to the following equation:

$$K = \lambda^{PV,ref} \times \lambda^T \times S^{PV} \quad (8)$$

In this factor,  $\lambda^{PV,ref}$  states the reference efficiency of the PV panels,  $S^{PV}$  is the surface covered by the PV panels and  $\lambda^T$  denotes the tracker efficiency, which is assumed to be 1. In addition, solar panels temperature  $T^C$  is modelled by (9):

$$T^C = T^a + \left[ \frac{(NOCT - 20)}{800} \right] G(t) \quad (9)$$

Accordingly, solar panels temperature  $T^C$  related to ambient temperature  $T^a$  and normal operating cells' temperature  $NOCT$ , which are considered  $25^\circ C$  and  $45^\circ C$ , respectively. The

hourly solar radiation density  $G(t)$  can be obtained through some mathematical formulation from daily solar radiation that can be found in [5], or its value at each hour can be obtained from the historical radiation data of the considered region [21].

### 2.2.2.2. WT

The total power generated by the WT system,  $P_{WT}$  varies with the wind speed  $V$  at each time interval  $t$  [22]:

$$P_{WT}(t) = \begin{cases} 0 & 0 \leq V(t) \leq V^{cut-in} \\ (K_1 + K_2 V(t) + K_3 V(t)^2) P_{w_{rated}} & V^{cut-in} \leq V(t) \leq V^{rated} \\ P_{WT}^{rated} & V^{rated} \leq V(t) \leq V^{cut-out} \\ 0 & V^{cut-out} \leq V(t) \end{cases} \quad (10)$$

where, the parameters  $K_1$ ,  $K_2$  and  $K_3$  are obtained from the empirical data and assumed to be -0.1311, 0.00149 and 0.00568, respectively. In addition,  $P_{w_{rated}}$  is the rated output power of the WT system, which is considered 400 kW. The values of the cut-in speed,  $V^{cut-in}$ , the rated speed  $V^{rated}$  and the cut-out speed  $V^{cut-out}$ , are considered to be 4.7, 14 and 20  $m/s$ , respectively [22].

### 2.2.3 Thermal generation unit

As mentioned earlier, EHP and EB systems that have electrical input energy are applied in the thermal generation unit to meet the thermal load demand of the HSPS arising from several services of the passengers. The equation of turning the electrical input energy to the thermal output energy in these thermal systems along with the related constraints are stated below.

#### 2.2.3.1. EHP and EB systems

Thermal output of the EHP and EB systems can be obtained from (11) based on the electrical input power. In this equation,  $\lambda_{EB}$  is the efficiency of EB system and  $\lambda_{EHP}$  is the coefficient of performance of the EHP. In addition, the thermal output limitation of EB and EHP systems are stated by (12) [18].

$$H_{EB(EHP)}(t) = \lambda_{EB(EHP)} \times P_{EB(EHP)}^{in}(t) \quad (11)$$

$$H_{EB(EHP)}^{Min} \leq H_{EB(EHP)}(t) \leq H_{EB(EHP)}^{Max} \quad (12)$$

where,  $H_{boiler(EHP)}^{Min}$  and  $H_{boiler(EHP)}^{Max}$  are the maximum and minimum output bounds of the EB (EHP) system.

### 2.2.4. Cold-Ironing Service

Connecting the ship to the shore power system called cold-ironing service is only available when the ship is at the port and is allowed to purchase a limited power ( $P_{CI}^{Max}$ ) from the grid so as not to disturb the power balance constraint of the local power grid. This limitation states by (13), and a binary variable  $\psi(t)$  is defined in (14) to distinguish the sailing hours from the time intervals that the ship stops at the port [5].

$$P_{CI}(t) \leq \psi(t) \times P_{CI}^{Max} \quad (13)$$

$$\psi(t) = 0, \quad t \in t_{sailing} \quad (14)$$

The cost of the cold-ironing service  $C_{CI}(t)$  is paid only when the ship purchases power from the shore power grid. This cost is dependent on the electricity price  $\kappa_{CI}(t)$  and the amount of purchased power at each time interval  $P_{CI}(t)$ , according to (15).

$$C_{CI}(t) = \kappa_{CI}(t) \times P_{CI}(t) \quad (15)$$

It is necessary to emphasize that the electricity price is not a constant value and it can be changed considering the amount of power supply and demand of the grid over time. In addition, when the ship is sailing, there is no connection between the ship and the local grid. Therefore, there is no purchased power from the cold-ironing service and the related cost term will be zero.

### 2.2.5. Energy storage systems

Due to the intermittent nature of renewable energies, the power generated by the RES varies at different hours of a day. The power produced by RES may be high when demand is low and vice versa. Therefore, there is a need for a storage system to balance between energy generation and consumption during different times of the day. In addition, if the electricity price of the shore power grid is reasonable, the ship's operator could be able to purchase power more than the need of the ship at berthing hours and store it in the storage for further consumption. As the input energy of the thermal generation unit is electrical, therefore the electricity price and RES output power are also affected the thermal section. Thus, in this study, ESS and TSS are provided to contribute in providing electrical and thermal demands more efficiently.

#### 2.2.5.1. ESS

Equation (15) expresses the relation between the stored energy in the ESS at a given time  $E_{ESS}(t)$  and the stored energy at the next time interval  $E_{ESS}(t+1)$ . In addition, the energy stored in the ESS at each time interval is restricted by (16) [23].

$$E_{ESS}(t+1) = (E_{ESS}(t) \times \lambda_{SE}) + (E_{ESS}^{ch}(t) \times \lambda_{ESS}^{ch}) - \left( \frac{E_{ESS}^{disch}(t)}{\lambda_{ESS}^{disch}} \right) \quad (15)$$

$$E_{ESS}^{Min} \leq E_{ESS}(t) \leq E_{ESS}^{Max} \quad (16)$$

where,  $\lambda_{SE}$ ,  $\lambda_{ESS}^{ch}$ ,  $\lambda_{ESS}^{disch}$ ,  $E_{ESS}^{ch}(t)$  and  $E_{ESS}^{disch}(t)$ , are the standby efficiency of the ESS, the charge and discharge efficiencies, and the charge and discharge energies of the ESS at the time interval  $t$ , respectively. Moreover,  $E_{ESS}^{Max/Min}$  is the maximum/minimum bound of the stored energy in the ESS. The charging and discharging energies of the ESS at each time interval  $t$  is limited by (17) and (18), respectively.

$$E_{ESS}^{ch}(t) \leq \zeta_{ESS}^{ch}(t) \times E_{ESS}^{Max, ch} \quad (17)$$

$$E_{ESS}^{disch}(t) \leq \zeta_{ESS}^{disch}(t) \times E_{ESS}^{Max, disch} \quad (18)$$

$$\zeta_{ESS}^{disch}(t) + \zeta_{ESS}^{ch}(t) \leq 1 \quad (19)$$

The binary variables  $\zeta_{ESS}^{ch}(t)$  and  $\zeta_{ESS}^{disch}(t)$  are defined for the charge and discharge states,



and it is considered that the ESS is not able to charge and discharge at the same time, as expressed by (19).

### 2.2.5.2. TSS

The constraints of the TSS are similar to the constraints of the ESS system that are expressed in the following equations [24]:

$$TH_{TSS}(t+1) = (TH_{TSS}(t) \times \lambda_{TS}) + (TH_{TSS}^{ch}(t) \times \lambda_{TSS}^{ch}) - \left( \frac{TH_{TSS}^{disch}(t)}{\lambda_{TSS}^{disch}} \right) \quad (20)$$

$$TH_{TSS}^{Min} \leq TH_{TSS}(t) \leq TH_{TSS}^{Max} \quad (21)$$

$$TH_{TSS}^{ch}(t) \leq \zeta_{TSS}^{ch}(t) \times TH_{TSS}^{Max, ch} \quad (22)$$

$$TH_{TSS}^{disch}(t) \leq \zeta_{TSS}^{disch}(t) \times TH_{TSS}^{Max, disch} \quad (23)$$

$$\zeta_{TSS}^{disch}(t) + \zeta_{TSS}^{ch}(t) \leq 1 \quad (24)$$

where,  $\lambda_{TS}$ ,  $\lambda_{TSS}^{ch}$ ,  $\lambda_{TSS}^{disch}$ ,  $TH_{TSS}^{ch}(t)$  and  $TH_{TSS}^{disch}(t)$ , are the standby efficiency of the TSS, the charge and discharge efficiencies, and the charge and discharge energies of the TSS at the time interval  $t$ , respectively. In addition,  $TH_{TSS}^{Max/Min}$  is the maximum/minimum range of the stored energy in the TSS at each time interval. Moreover,  $TH_{TSS}^{Max, ch/disch}$  indicates the maximum charging and discharging energies of the TSS and  $\zeta_{TSS}^{ch/disch}(t)$  is the defined binary variable for charge and discharge states.

### 2.2.6. Objective function

The objective function of the optimal operation problem is defined in (25) as minimizing the total operation cost of the proposed HSPS with the specified energy generation units and various energy demands. By solving the problem, the optimal output power of each energy unit is obtained for each hour of a daily trip.

$$Min \sum_{t=1}^{24} \{C_{DG}^{total}(t) + C_{CI}(t)\} \quad (25)$$

According to (25), the total cost of the diesel generator system  $C_{DG}^{total}(t)$  plus the cost to be paid for using cold-ironing service  $C_{CI}(t)$  must be minimized as the objective function of the proposed optimization problem. It is noteworthy that the cost of the diesel generator system itself depends on the fuel, emission, and maintenance costs described by (3-5).

### 2.2.7. Constraints:

The stated objective function is subjected to some technical and environmental constraints, in addition to the equations (1-24). These constraints are expressed in the following.

#### 2.2.7.1. Electrical and thermal energy balance constraints:

Due to the aim of the study which is optimally supplying the electrical and thermal loads arising from propulsion and service demands, the sum of all provided power by different generation units must be equal to the whole energy demands. The electrical and thermal energy balance of the HSPS can be satisfied by (26) and (27).

$$P_{DG}^{out}(t) + P_{PV}(t) + P_{WT}(t) + P_{CI}(t) + E_{ESS}^{disch}(t) - E_{ESS}^{ch}(t) - P_{EB}^{in}(t) - P_{EHP}^{in}(t) - P_{load}(t) = 0 \quad (26)$$

$$H_{EHP}(t) + H_{EB}(t) + TH_{TSS}^{disch}(t) - H_{load}(t) - TH_{TSS}^{ch}(t) = 0 \quad (27)$$

where,  $P_{load}(t)$  and  $H_{load}(t)$  are the electrical and thermal load demands of the considered ship at each time interval, respectively.

### 2.2.7.2. Emissions Constraint:

It is desirable to adjust the fuel consumption of the diesel generator system in a way that the emission caused by the ship does not exceed a critical value. [25]. In this regard, the Energy Efficiency Operational Indicator (EEOI) must be limited to  $EEOI_{max}$  via satisfying the following equation.

$$\frac{\sum_i c_i \times FC_{DG}(t)}{LF \times Vc(t)} \leq EEOI_{max} \quad (28)$$

where,  $c_i$  is a conversion coefficient used for calculating the math of the emitted  $CO_2$  from the consumed fuel by the  $i$  th diesel generator within the time interval  $t$ .  $Vc(t)$  is the ship average velocity and  $LF$  is the ship loading factor estimates based on the type of the examined ship [25].

## 3. Results

The proposed optimization problem has been simulated in the GAMS environment, based on the specifications of a cruise ship traveling on daily tours [26]. By analyzing the obtained results, the effect of each electrical or thermal equipment in supplying different load demands of the ship and reducing the costs related to the diesel generator is determined. In addition, the obtained values for EEOI and fuel consumption are also investigated.

### 3.1. Problem assumptions

The various energy demands including propulsion, electrical and thermal service loads of the considered HSPS for a typical daily tour are presented in Fig. 3 [26].

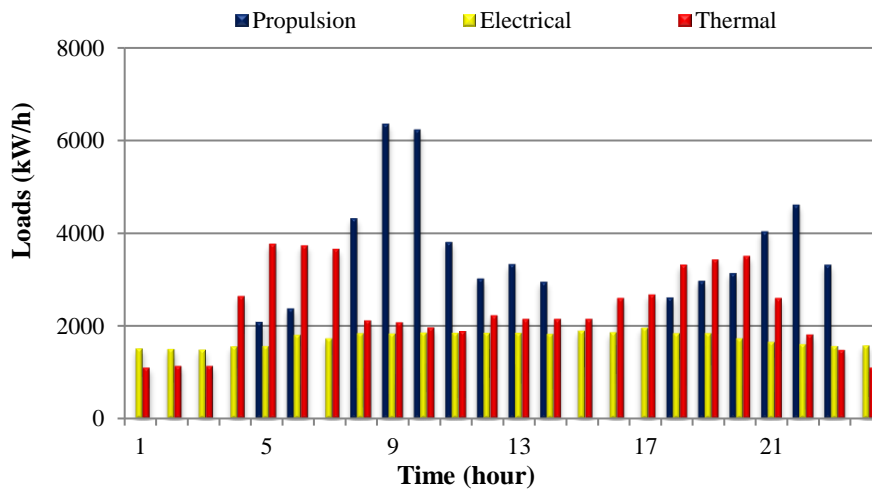

**Fig. 3** Various loads of HSPS for a typical daily tour

**Table 1.** Specifications of the ESS and TSS

Storage type	Maximum energy (kWh)	Maximum charging/ discharging range (kW)	Standby efficiency (%)	Charge & discharge efficiency (%)
ESS	10368	1296	98	85
TSS	1000	300	95	90

**Table 2.** Characteristics of the EHP and EB systems

EHP	Coefficient of performance	Maximum capacity (kWh)	Minimum capacity (kWh)
	2.5	1500	0
E-boiler	Efficiency (%)	Maximum capacity (kWh)	Minimum capacity (kWh)
	94	2500	0

**Table 3.** Features of different conditions

Condition	Month	Cold-ironing price (\$/kW)	Stop hours at the port
I	July	0.089	3-5 PM
II	January	0.225	7-9 AM

The coefficients of maintenance, consumption curve and emission dependent on the diesel generator system exist in [27]. In addition, the total capacity of the diesel generators is considered 8500 kW put together. The maximum surface covered by the PV panels is assumed to be  $1500 m^2$  and the efficiency of them is considered 20%. The hourly solar radiation can be taken from existing data [21]. In addition, the hourly wind speed data are available in [9]. The specifications and energy limitations of the ESS and TSS are given by Table 1 [24]. On the other hand, Table 2 defined the characteristics of the EHP and EB systems [18].

The maximum provided power by the cold ironing service is estimated to be 6000 kW [28]. The ship is able to use cold ironing service for connecting to the shore power system at a port, where the ship stops three hours a day. As mentioned earlier, the electricity price of the cold ironing service varies at different time intervals of a day. Therefore, to have a more accurate estimation, two different conditions are considered in this study, based on the climatic characteristics of two different months of the year and various electricity prices. Table 3 summarizes these two conditions. Moreover, the data of wind speed [9] and solar radiation [21] in a day of January and July are depicted in Fig.4 and Fig.5.

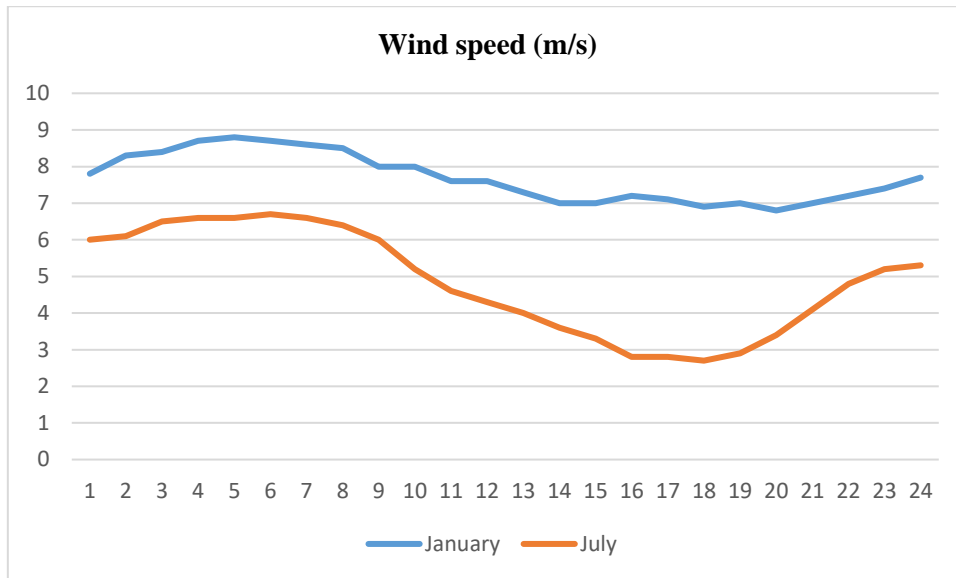

**Fig. 4** Hourly wind speed in a day of two different months

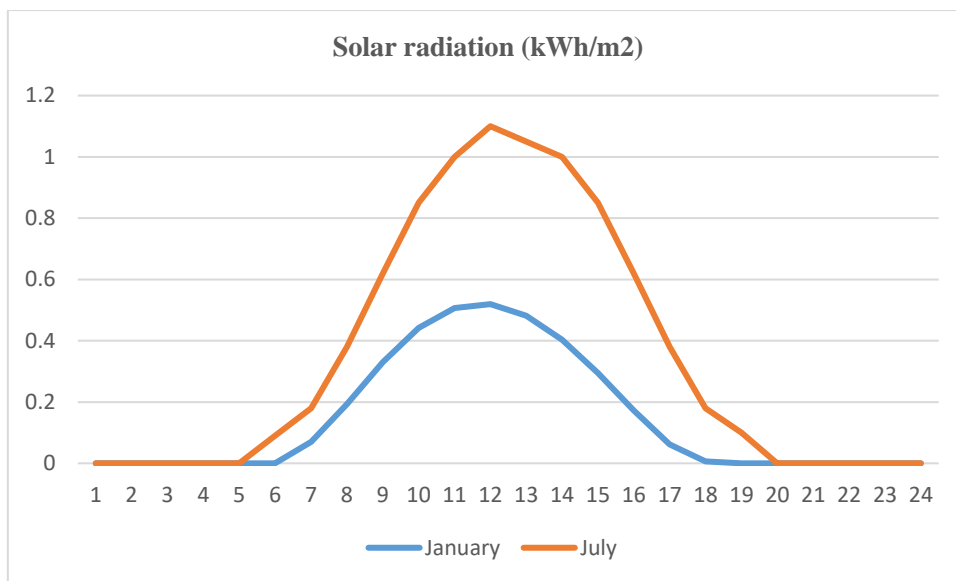

**Fig. 5** Hourly solar radiation in a day of two different months

### 3.2. Numerical results and discussions:

In this section, different structures for a marine power system are defined to investigate the effect of each component on achieving the aim of reducing fuel consumption, emission and costs. This comprehensive analysis helps to select the best configuration of hybrid power systems for marine applications. The suggested hybrid structures are as follows:

1. Diesel generator +EHP+EB
2. Diesel generator+RES + EHP+EB
3. Diesel generator +RES +ESS+TSS+ EHP+EB

#### 4. Diesel generator +RES +ESS+TSS+ EHP+EB +Cold ironing service

The daily costs of the four mentioned structures of a marine power system consisting of several costs including fuel, emission and maintenance costs of the diesel generators and the paid cost for purchasing power from the shore power system are expressed in Table 4 and Fig. 6 for conditions (I) and condition II, respectively.

Regarding Table.4, by adding the RES to structure 1, the total cost of the ship in a day has been decreased to about 2,324\$ (2%). In addition, this reduction is also obvious in the fuel, maintenance and emission costs. As the mentioned marine hybrid power system has been equipped via ESS and TSS, the daily costs of the ship have been additionally reduced. Furthermore, a significant cost reduction by about 12% is obtained for the fourth structure in which all of the equipment, as well as cold-ironing service, are utilized to have an optimal and cost-effective operation with the minimum obtainable cost. The cooperation of the suggested components altogether caused this large amount of cost reduction, which is not obtainable without each of the investigated facilities.

The results of electrical power generation of different components are illustrated in Fig. 7 and Fig. 8 (condition I and II, respectively) for the most hybridization of the marine power system in the fourth structure.

**Table 4** Daily costs of the suggested structures (condition I)

Structure	Total cost (\$)	Fuel cost (\$)	Maintenance cost (\$)	Emission cost (\$)	Purchasing cost (\$)
1	106,718.07	22865.85	6450.17	77402.05	-
2	104,393.57	22367.79	6309.67	75716.09	-
3	104246.08	22336.19	6300.76	75609.12	-
4	94209.55	19900.74	5613.74	67364.99	1,330.07

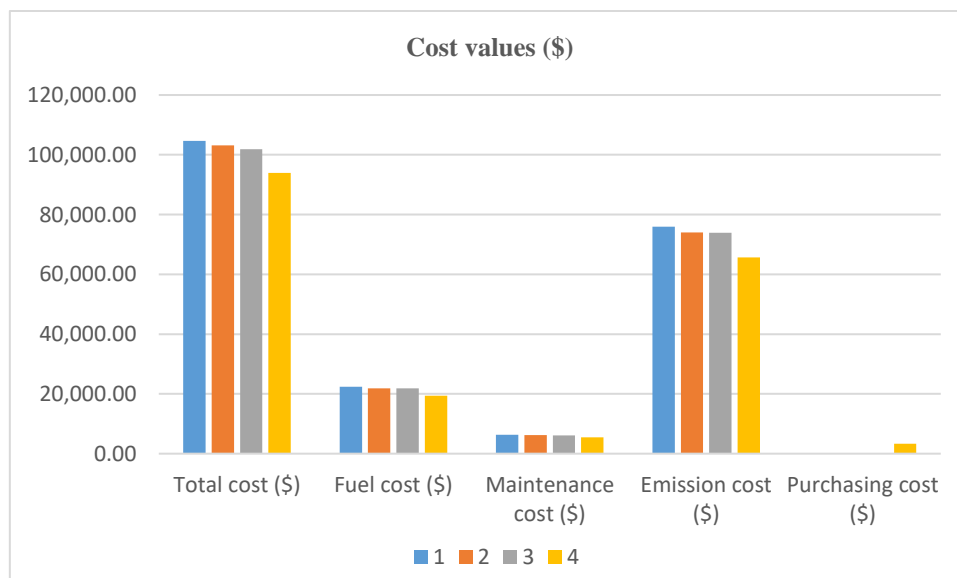

**Fig. 6.** Daily costs of the suggested structures (condition II)

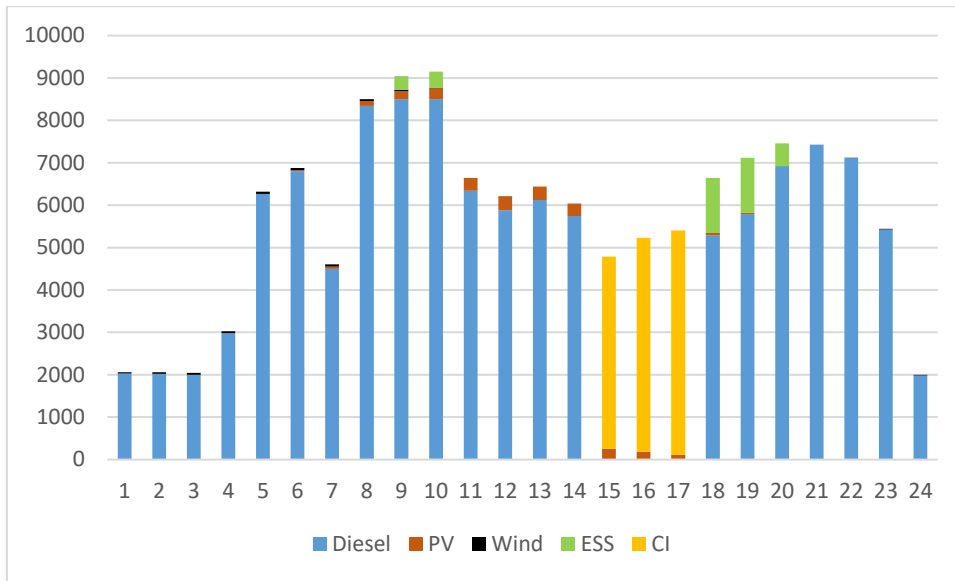

**Fig. 7.** Hourly electrical power generation of different components (condition I)

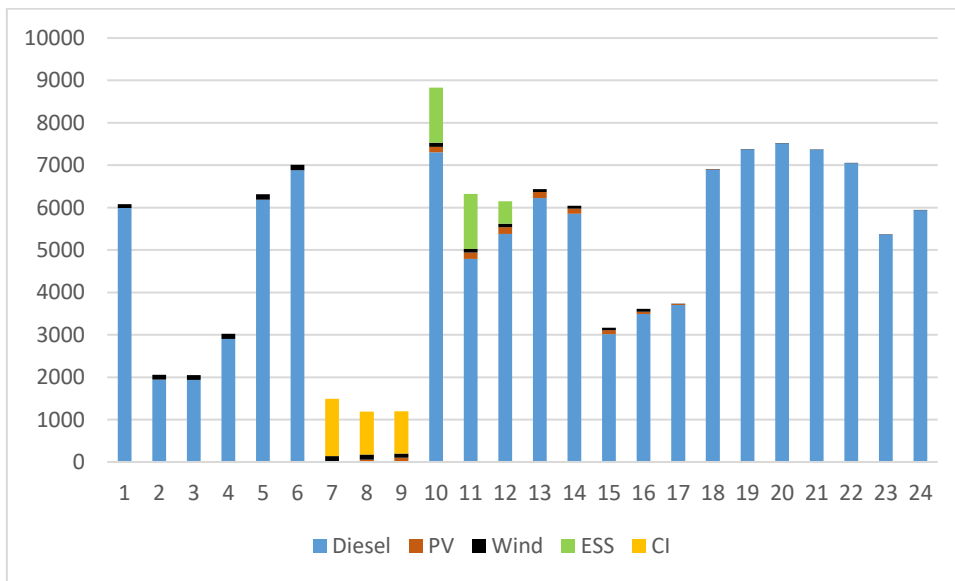

**Fig. 8.** Hourly electrical power generation of different components (condition II)

By comparing the two above-mentioned figures, it can be found that the amount of generated power by the WT system in condition II is higher than this power in condition I. Because condition II investigates the HSPS operation on a winter day, the wind speed is often high, unlike condition I, which is performed on a summer day. Hence, the amount of generated power via the PV panels in condition I is higher than this amount in condition II. This proves the complementarity of WT and PV panels in increasing the whole generated power of the considered RES in different weather conditions.

Furthermore, it is obvious that the amount of purchased power from the cold ironing service in condition I is much higher than condition II. Because electricity price in condition I is lower than condition II. Therefore in condition I, the HSPS operator purchased a large amount of

electric power from the shore power grid, which is not only enough to completely meet the load demand of the three stopping hours but also can be stored in the ESS in order to supply the load demand of the further hours. In addition, purchasing power from the cold-ironing connection leads to more frequent discharging of the ESS, which in turn results in less usage of diesel generators and consequently lower costs and emissions. It is noteworthy that the use of ESS also depends on the amount of load demand per hour. As in condition I, the ESS is also discharged during hours 9-10 to supply the high load demand since it charged during previous time intervals with fewer load demands.

Fig. 9 demonstrates the hourly thermal power produced by different thermal types of equipment. As it is clear from this figure, the use of EHP and EB systems are reduced in the hours which TSS contributes to supplying thermal demand.

The obtained results for fuel consumption and EEOI in four different structures of both conditions are given in Table 5 and Fig. 10, respectively. By comparing the amount of fuel consumption resulted from the defined structures, it can be found that by more hybridization of the power generation system, the amount of consumed fuel has been decreased. As in case 4, which presents the most hybridization in the marine power system, the fuel consumption is in the lowest case in both conditions. In addition, this reduction is obvious in Fig. 10 for the EEOI values as it depends on the amount of fuel consumption. It can be concluded that structure 4, which is composed of all the investigated energy units, including diesel generator, PV, WT, ESS, TSS, EHP, EB and cold-ironing service, causes the least amount of fuel consumption and emission. Regarding the obtained results given by Table 4, utilizing the fourth structure also leads to the maximum amount of cost savings. Thus, structure 4, which refers to the proposed HSPS has been selected as the optimal structure in supplying the electrical and thermal demands of the considered cruise ship in terms of cost, fuel consumption and emission.

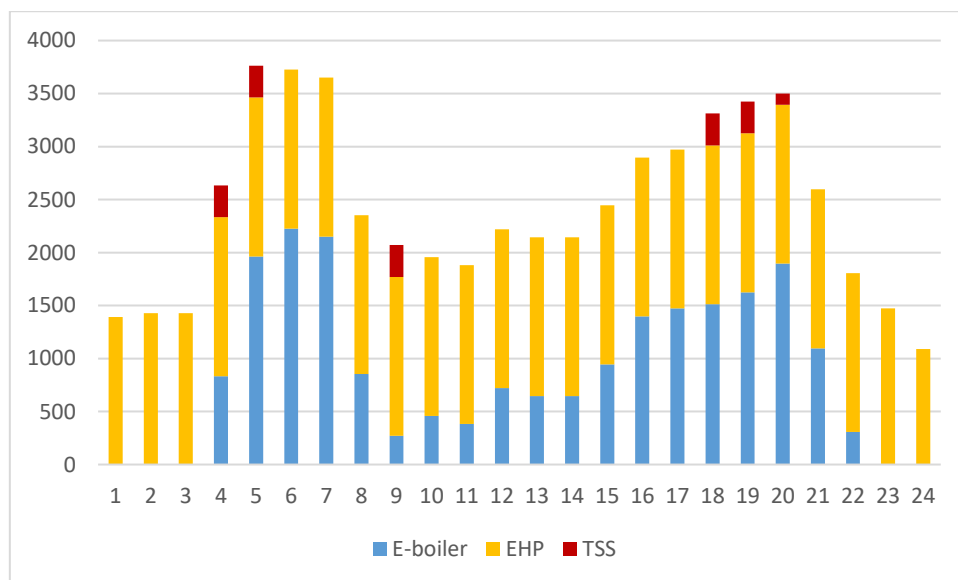

**Fig. 9** Hourly thermal power generation of different components (condition I)

**Table 5** Fuel consumption for different structures (condition I and II)

Structure	1	2	3	4
Fuel consumption I	32250.85	31548.37	31503.8	28127.55
Fuel consumption II	31621.17	30860	30783.96	27376.74

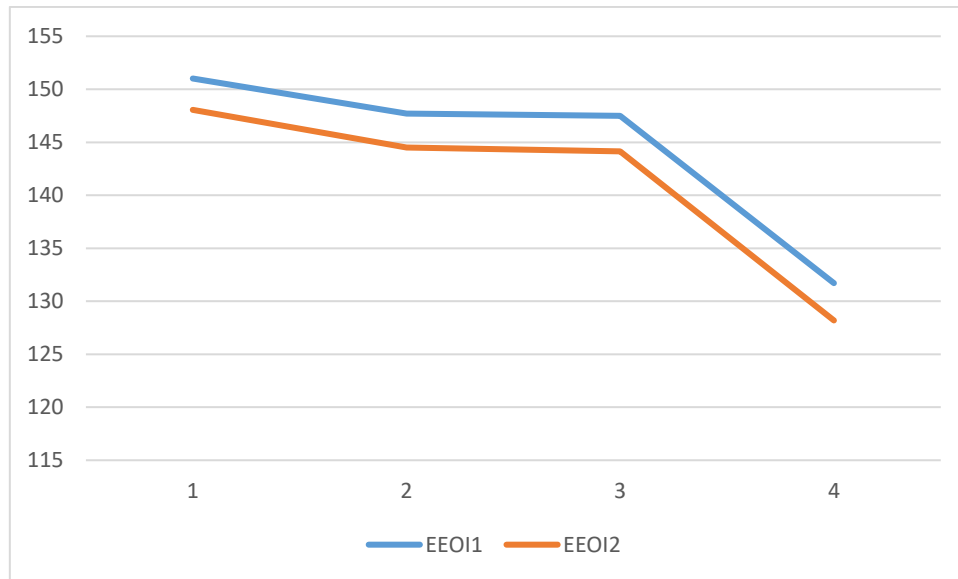

**Fig. 10** EEOI values for different structures (condition I and II)

#### 4. Conclusion

In this study, the optimal operation of a hybrid shipboard power system was evaluated by investigating four different suggested structures for the hybridization of the power generation system. The suggested structures were compared from the cost, fuel consumption and EEOI point of view. Finally, the fourth structure was selected as the optimal hybrid generation system, which was the complete one equipped with a diesel generator, solar panels, wind turbine, electrical heat pump and electrical boiler along with both electrical and thermal storage systems in addition to a cold-ironing service. This structure provided the perfect combination since the output power of the solar panels and wind turbines complement each other in different weather conditions. In addition, utilizing both electrical and thermal storage systems increased the efficiency of the system in both electrical and thermal sections. Furthermore, applying an electrical heat pump and electric boiler systems for supplying the thermal load demands created an all-electric structure for the ship with the least fuel consumption. The numerical results, which are obtained from applying the proposed optimal hybrid power generation system in a real cruise ship, were proved that the mentioned structure is efficient in reducing fuel consumption, emission, and costs. Because, a cost reduction by about 12% was resulted by utilizing the selected optimal hybrid shipboard power system, compared to the first suggested structure, which included only the conventional diesel generator system for supplying the electrical load demand.



## References

- [1] A. S. Grigoriev, V. V. Skorlygin, S. A. Grigoriev, D. A. Melnik, and M. N. Filimonov, "A hybrid power plant based on renewables and electrochemical energy storage and generation systems for decentralized electricity supply of the northern territories," *Int. J. Electrochem. Sci.*, vol. 13, no. 2, pp. 1822–1830, 2018.
- [2] V. Kumar, R. L. Shrivastava, and S. P. Untawale, "Solar Energy: Review of Potential Green & Clean Energy for Coastal and Offshore Applications," *Aquat. Procedia*, vol. 4, no. Icwrcoc, pp. 473–480, 2015.
- [3] M. Sharafi and T. Y. ELMekkawy, "Multi-objective optimal design of hybrid renewable energy systems using PSO-simulation based approach," *Renew. Energy*, vol. 68, pp. 67–79, 2014.
- [4] A. Dolatabadi, M. Jadidbonab, and B. Mohammadi-Ivatloo, "Short-Term Scheduling Strategy for Wind-Based Energy Hub: A Hybrid Stochastic/IGDT Approach," *IEEE Trans. Sustain. Energy*, vol. 10, no. 1, pp. 438–448, 2019.
- [5] N. Vahabzad, B. Mohammadi-Ivatloo, and A. Anvari-Moghaddam, "Optimal energy scheduling of a solar-based hybrid ship considering cold-ironing facilities," *IET Renew. Power Gener.*, no. September 2020, pp. 1–16, 2021.
- [6] K. C. Chou and R. B. Corotis, "Simulation of hourly wind speed and array wind power," *Sol. Energy*, vol. 26, no. 3, pp. 199–212, 1981.
- [7] A. S. Aziz, M. F. N. Bin Tajuddin, and M. R. Bin Adzman, "Feasibility analysis of PV/Wind/Battery hybrid power generation: A case study," *Int. J. Renew. Energy Res.*, vol. 8, no. 2, pp. 661–671, 2018.
- [8] R. A. Campos, L. R. D. Nascimento, M. Braga, G. Simões, and R. Rütther, "Performance Assessment of PV Technologies and Complementarity of Utility-Scale PV and Wind Power Plants in Brazil," *2018 IEEE 7th World Conf. Photovolt. Energy Conversion, WCPEC 2018 - A Jt. Conf. 45th IEEE PVSC, 28th PVSEC 34th EU PVSEC*, pp. 1173–1178, 2018.
- [9] M. A. Habib, S. A. M. Said, M. A. El-Hadidy, and I. Al-Zaharna, "Optimization procedure of a hybrid photovoltaic wind energy system," *Energy*, vol. 24, no. 11, pp. 919–929, 1999.
- [10] A. S. O. Ogunjuyigbe, T. R. Ayodele, and O. A. Akinola, "Optimal allocation and sizing of PV/Wind/Split-diesel/Battery hybrid energy system for minimizing life cycle cost, carbon emission and dump energy of remote residential building," *Appl. Energy*, vol. 171, pp. 153–171, 2016.
- [11] A. Dolatabadi and B. Mohammadi-Ivatloo, "Stochastic risk-constrained optimal sizing for hybrid power system of merchant marine vessels," *IEEE Trans. Ind. Informatics*, vol. 14, no. 12, pp. 5509–5517, 2018.
- [12] M. Jaurola, A. Hedin, S. Tikkanen, and K. Huhtala, "Optimising design and power management in energy-efficient marine vessel power systems : a literature review," vol. 4177, 2018.
- [13] C. Ghenai, M. Bettayeb, B. Brdjanin, and A. K. Hamid, "Hybrid solar PV/PEM fuel Cell/Diesel Generator power system for cruise ship: A case study in Stockholm, Sweden," 2019.

- [14] A. Letafat, M. Ra, M. Sheikh, M. Afshari-igder, and M. Banaei, "Simultaneous energy management and optimal components sizing of a zero- emission ferry boat," vol. 28, no. December 2019, 2020.
- [15] M. Taghizadeh, S. Bahramara, F. Adabi, and S. Nojavan, "Optimal thermal and electrical operation of the hybrid energy system using interval optimization approach," *Appl. Therm. Eng.*, vol. 169, no. December 2019, p. 114993, 2020.
- [16] M. Rivarolo, D. Rattazzi, and L. Magistri, "ScienceDirect Best operative strategy for energy management of a cruise ship employing different distributed generation technologies," *Int. J. Hydrogen Energy*, no. xxxx, 2018.
- [17] L. Zhengmao, S. Member, X. Yan, S. Member, F. Sidun, and W. Yu, "Multi-objective Coordinated Energy Dispatch and Voyage Scheduling for a Multi-energy Cruising Ship," *2019 IEEE/IAS 55th Ind. Commer. Power Syst. Tech. Conf.*, pp. 1–8, 2019.
- [18] N. Vahabzad, M. Jadidbonab, B. Mohammadi-Ivatloo, S. Tohidi, and A. Anvari-Moghaddam, "Energy management strategy for a short-route hybrid cruise ship: an IGDT-based approach," *IET Renew. Power Gener.*, vol. 14, no. 10, pp. 1755–1763, 2020.
- [19] A. Maleki and A. Askarzadeh, "Optimal sizing of a PV/wind/diesel system with battery storage for electrification to an off-grid remote region: A case study of Rafsanjan, Iran," *Sustain. Energy Technol. Assessments*, vol. 7, pp. 147–153, 2014.
- [20] Z. Wu and X. Xia, "Tariff-driven demand side management of green ship," *Sol. Energy*, vol. 170, no. May, pp. 991–1000, 2018.
- [21] <https://solargis.com/docs/methodology/solar-radiation-modeling/>.
- [22] A. Loukatou, S. Howell, P. Johnson, and P. Duck, "Stochastic wind speed modelling for estimation of expected wind power output," *Appl. Energy*, vol. 228, no. June, pp. 1328–1340, 2018.
- [23] A. Dolatabadi, B. Mohammadi-Ivatloo, M. Abapour, and S. Tohidi, "Optimal Stochastic Design of Wind Integrated Energy Hub," *IEEE Trans. Ind. Informatics*, vol. 13, no. 5, pp. 2379–2388, 2017.
- [24] A. Dolatabadi, S. Member, M. Jadidbonab, S. Member, and E. L. M. Max, "Short - term Scheduling Strategy for Wind - based Energy Hub : A Hybrid Stochastic / IGDT Approach," vol. 3029, no. c, 2017.
- [25] F. D. Kanellos, J. M. Prousalidis, and G. J. Tsekouras, "Control system for fuel consumption minimization-gas emission limitation of full electric propulsion ship power systems," *Proc. Inst. Mech. Eng. Part M J. Eng. Marit. Environ.*, vol. 228, no. 1, pp. 17–28, 2014.
- [26] F. Baldi, F. Ahlgren, T. Van Nguyen, M. Thern, and K. Andersson, "Energy and exergy analysis of a cruise ship," *Energies*, vol. 11, no. 10, pp. 1–41, 2018.
- [27] H. Lan, S. Wen, Y. Hong, D. C. Yu, and L. Zhang, "Optimal sizing of hybrid PV / diesel / battery in ship power system q," *Appl. Energy*, vol. 158, pp. 26–34, 2015.
- [28] G. Bai and R. Schmidhalter, "Shore to Ship Converter System for Energy Saving and Emission Reduction," pp. 2081–2086, 2011.