



Aalborg Universitet

AALBORG UNIVERSITY
DENMARK

Power Semiconductors for An Energy-Wise Society

Idaka, Shiori ; Kondo, Harufusa; Majumdar, Gourab ; Miyoshi, Atsushi (Jack) ; Trifunovich, Dragi ; Akagi, Hirofumi ; Alemu, Solomon ; Antoniazzi, Antonello; Anvari-Moghaddam, Amjad; Bakran, Mark-Matthias ; Behet, Markus ; Blaabjerg, Frede; Brüniger, Roland ; Butler, Stephanie Watts; Buttay, Cyril ; Carrol, Eric ; Chow, Paul ; Dietrich, Peter ; Dujic, Drazen; Drhorhi, Ismail ; Eckel, Hans-Günter; El-Barbari, Said ; Friedrichs, Peter; Grossner, Ulrike ; Guo, Wendi; Hiller, Marc ; Hilt, Oliver ; Chao Hu, Yun ; Huber, Jonas ; Ichiro, Omura ; Itoh, Junichi ; Jansen, Uwe; Kaminski, Nando ; Kimoto, Tsunenobu ; Kolar, Johann; Laska, Bernd ; Lendenmann, Heinz; Leroy, Sandrine ; Li, Xinqiang; Lindemann, Andreas ; Lorenz, Leo ; Makoschitz, Markus ; Minamisawa, Renato ; Narendran, Ashitha ; Nishizawa, Shin-ichi ; Ohta, Fumihiko ; Rajashekara, Kaushik; Rigbers, Klaus; Saito, Wataru ; Senftleben, Oliver ; Shima, Akio ; Stroe, Daniel-Ioan; Suga, Kenichi ; Takahashi, Hiroshi ; Thoben, Markus ; Veliadis, Victor ; Vobecky, Jan ; Volke, Andreas ; Xue, Ming

Publication date:
2023

Document Version
Publisher's PDF, also known as Version of record

[Link to publication from Aalborg University](#)

Citation for published version (APA):

Idaka, S., Kondo, H., Majumdar, G., Miyoshi, A., Trifunovich, D., Akagi, H., Alemu, S., Antoniazzi, A., Anvari-Moghaddam, A., Bakran, M.-M., Behet, M., Blaabjerg, F., Brüniger, R., Butler, S. W., Buttay, C., Carrol, E., Chow, P., Dietrich, P., Dujic, D., ... Xue, M. (2023). *Power Semiconductors for An Energy-Wise Society*. International Electrotechnical Commission (IEC).



We support the Sustainable Development Goals

White Paper

Power semiconductors for an energy-wise society

Executive summary

A commitment to an energy-wise society must be synonymous with a commitment to power semiconductors and their applications

The purpose of this white paper is to facilitate greater awareness as well as practical insights concerning the market-oriented, market-driven and market-focused roles that power semiconductors perform over a very broad spectrum of industries and in society as a whole. Annual revenues from power semiconductor devices are expected to more than double through 2030. This comes as no surprise, as these high-tech electronic components constitute THE key enablers to tackling major challenges on the path to an energy-wise society, namely decarbonization and digitization. Similar to the role played by semiconductor integrated circuits (ICs) in computers, data storage and communication applications, an extensive use of power semiconductors lies at the heart of modern power electronics. This includes renewable power generation and transmission, electromobility, automated factories, energy-efficient data centres, smart cities and smart homes, to mention just a few applications.

Strategic opportunities for power semiconductors in an energy-wise society

Advancing the utilization of power semiconductors constitutes the only means of successfully implementing national policies for achieving carbon neutrality by the middle of this century. Many required emerging applications for carbon neutrality can only be enabled by power electronics and power semiconductors. Improved power

semiconductor device technologies and products are being continuously developed with more suitable electrical and reliability properties. Today, such technologies are experiencing a significant leap in performance with the introduction of wide bandgap materials, which will play an important part in increasing the energy efficiency of many established and emerging power electronic applications.

The challenges to be addressed for power semiconductors to meet the needs of an energy-wise society

From chips to packages to power electronics, power semiconductor developments are becoming tightly interrelated across the value chain. A robust supply chain must be ensured, as power semiconductors require specific materials within a cost structure and the availability of materials required for large scale manufacturing. Some of these materials could constitute a potential bottleneck in the future. For example, during the coronavirus pandemic, in many parts of the world supply-chain problems in the semiconductor industry had massive ripple effects throughout the economy. In the future, special attention will need to be paid to the entire power semiconductor industry value chain to avoid similar situations, so as not to jeopardize global decarbonization efforts.

A more focused commitment on the part of governments concerning policies and targets for advancing power semiconductor devices and integration technologies, as well as ensuring the availability of adequate funds and resources, is needed to achieve the shift to an energy-wise society. Some initial steps in the right direction include the various “chip acts” announced by a

number of countries, which, in the words of the European Commission, aim to “develop a thriving semiconductor ecosystem and resilient supply chain”. A stronger recognition of the critical role played by power semiconductors is still needed in such initiatives.

Furthermore, the increasing shortage of human resources required for the multi-disciplinary engineering skills necessary to reach the critical milestones for decarbonization also represents an acute concern. To successfully mitigate this problem, strategic actions will be required at policy-making levels.

Standards for power semiconductors

This white paper focuses on the strategic role of power semiconductors for an energy-wise society in order to aid in establishing guidelines within standardization bodies and to bring power semiconductors to the forefront of impending standardization proposals. Standards play a key role in the growth of any industry, including that of power semiconductors, by enabling accelerated market acceptance and faster worldwide deployment of applications, thus removing significant technical risks, increasing product quality, and ensuring fair competition practices. This white paper also delivers implementable recommendations to IEC stakeholders aimed at enhancing the collaborative structures among such parties and accelerating the development and the adoption of needed standards.

To address the complex topics described above, the white paper is structured as follows:

- Section 1 introduces the concept of an energy-wise society, the role and operating principles of power semiconductors, and the impact of such devices on the UN Sustainable Development Goals and on the IEC Strategic Plan.
- Section 2 presents the most important power electronic applications relevant to an energy-wise society and considers the forces that are driving the current and future development of power semiconductors.
- Section 3 reviews major developments affecting power semiconductor devices as key components in power electronic applications, from different perspectives. These developments are discussed in relation to the industry value chain (chip and module). Sustainability and life cycle assessment topics leading to a circular economy are also included for the first time in such a white paper.
- Section 4 considers state-of-the-art standards as well as new standards requirements that are arising in response to new challenges introduced by the development and emerging applications of power semiconductors.
- Section 5 provides conclusions and some key recommendations. It considers what the changes discussed in the previous sections mean for the IEC, its stakeholders and future standards work.

Call to action

Power semiconductors no longer constitute an inaccessible technology. However, increased efforts are needed to ensure that the unique role to be played by power semiconductors in the transition to an energy-wise society is well understood and appreciated by all participants. The required acceleration in deploying power electronics with included power semiconductors is presenting novel challenges which could have major implications for all IEC stakeholders – from power electronics end-users to power electronics equipment manufacturers and power semiconductor manufacturers. For example, transitioning the power semiconductor devices and power electronics industries from “linear economies” to “circular economies” characterized

by a constant flow of resources that are returned to the product cycle at the end of use will require formidable changes, especially given the range of different situations among industry actors and their differing capacities to make the necessary changes.

Understanding the changes detailed in this white paper, including the new technologies and standards requirements involved, will guarantee that the IEC remains at the forefront of power semiconductors and power electronics developments. The IEC can continue to take a leading role in ensuring that international and

national standardization bodies work more closely with one another, and with industry, aligning their methodologies and processes for standards introduced concerning power semiconductors and power electronics.

An important part of the IEC community includes the Young Professionals (YP) Programme, and the authors of this white paper aim to inspire the YPs by presenting them with a dedicated message urging them to take up the challenge of power semiconductors and power electronics to change the world for the better.

Message to young professionals

In a first for the IEC Market Strategy Board's White Paper series, a special, brief section is included in this white paper dedicated to the audience of the IEC Young Professionals (YP) Programme, as well as to young professionals in other standardization organizations and industry in general.

The authors and contributors to the present white paper strongly believe in an electrified future for our energy-wise society. Power semiconductors are the critical technology, the cornerstone of an all-electric and connected society that will feature ever lighter, tougher, more reliable and more energy-efficient power electronics applications. Power semiconductor devices and power electronics thus represent a unique opportunity for YPs who are motivated to make a meaningful and quantifiable impact towards the electrification/decarbonization of our world. Furthermore, this thriving industry fuels a vibrant ecosystem of innovation, and YPs will find themselves working with leading edge technologies, whether in chip/module/power converter design or manufacturing.

This white paper aims to inspire innovation that never stops and calls on YPs to rise to the challenge, because an energy-wise society will need improved and even ground-breaking power semiconductors. The YPs of today – the leaders of tomorrow – can drive the development and commercialization of many new generations of power semiconductors and power electronics.

.....

Acknowledgments

This white paper has been prepared by a project team of 61 members representing a variety of organizations, working under the IEC Market Strategy Board. The project team included representatives from semiconductor network businesses, academia, equipment vendors from around the world, and IEC Young Professionals. The project sponsor was Dr Kazuhiko Tsutsumi, from the Mitsubishi Electric Corporation and Chair of the IEC Market Strategy Board. Project coordination was by Peter Lanctot, Secretary of the IEC Market Strategy Board. Coordinating authors and project partner were Dr Munaf Rahimo and Dr Iulian Nistor of MTAL GmbH.

The management team members were (in alphabetical order):

Dr Shiori Idaka, Mitsubishi Electric Corporation

Dr Harufusa Kondo, Mitsubishi Electric Corporation

Dr Gourab Majumdar, Mitsubishi Electric Corporation

Dr Atsushi (Jack) Miyoshi, Mitsubishi Electric Corporation

Mr Dragi Trifunovich, Daihyo LLC

The project team members were (in alphabetical order):

Prof Hirofumi Akagi, Tokyo Institute of Technology, Member

Mr Solomon Alemu, Goldwin Science and Technology Company, Ltd, YP Member

Mr Antonello Antoniazzi, ABB, Member

Prof Amjad Anvari-Moghaddam, Aalborg University, Member

Prof Mark-Matthias Bakran, Bayreuth University, Member

Dr Markus Behet, SICCC, Member

Prof Frede Blaabjerg, Aalborg University, Member

Dr Roland Brüniger, R. Brüniger AG, Member

Dr Stephanie Watts Butler, WattsButler LLC, Member

Prof Cyril Buttay, INSA Lyon, Member

Mr Eric Carrol, EIC Consultancy, Member

Prof Paul Chow, Rensselaer Polytechnic Institute, Member

Mr Peter Dietrich, Richardson RFPD, Member

Prof Drazen Dujic, EPFL, Member

Dr Ismail Drhorhi, ONEE-BE, YP Member

Prof Hans-Günter Eckel, Rostock University, Member

Dr Said El-Barbari, BMW Group, Member

Dr Peter Friedrichs, Infineon, Member

Prof Ulrike Grossner, ETH Zurich, Member

Prof Wendi Guo, Aalborg University, Member

Prof Marc Hiller, Karlsruhe Institute of Technology, Member

Dr Oliver Hilt, Infineon, Member

Mr Yun Chao Hu, Huawei, Member

Prof Jonas Huber, ETH Zurich, Member

Prof Omura Ichiro, Kyushu Institute of Technology, Member

Prof Junichi Itoh, Nagaoka University of Technology, Member

Mr Uwe Jansen, Infineon, Member

Prof Nando Kaminski, University of Bremen, Member

Prof Tsunenobu Kimoto, Kyoto University, Member

Prof Johann Kolar, ETH Zurich, Member

Dr Bernd Laska, Siemens, Member

Executive summary

- Dr Heinz Lendenmann, ABB, Member
- Ms Sandrine Leroy, Yole Group, Member
- Mr Xinqiang Li, Shanghai Electrical Apparatus Research Institute, Member
- Prof Andreas Lindemann, Otto von Guericke University Magdeburg, Member
- Dr Leo Lorenz, ECPE, Member
- Dr Markus Makoschitz, Austrian Institute of Technology, Member
- Prof Renato Minamisawa, Fachhochschule Nordwestschweiz Member
- Ms Ashitha Narendran, Central Power Research Institute, YP Member
- Prof Shin-ichi Nishizawa, Kyushu University, Member
- Dr Fumihiko Ohta, Tokyo Electric Power Company, Member
- Dr Kaushik Rajashekara, University of Houston, Member
- Dr Klaus Rigbers, SMA, Member
- Prof Wataru Saito, Kyushu University, Member
- Dr Oliver Senftleben, BMW Group, Member
- Dr Akio Shima, Hitachi, Member
- Prof Daniel-Ioan Stroe, Aalborg University, Member
- Dr Kenichi Suga, Mitsubishi Electric Corporation
- Mr Hiroshi Takahashi, Fuji Electric, Member
- Prof Markus Thoben, Fachhochschule Dortmund, Member
- Prof Victor Veliadis, North Carolina State University, Member
- Dr Jan Vobecky, Hitachi Energy, Member
- Dr Andreas Volke, Power Integrations, Member
- Mr Ming Xue, Infineon, Member

.....

Executive summary	3
List of abbreviations	11
Glossary	17
Section 1 Towards an energy-wise society	19
1.1 Introduction and background	19
1.1.1 Power semiconductors as a key towards an energy-wise society	21
1.1.2 Objectives of the white paper	23
1.2 Scope and structure of the white paper	24
1.2.1 Market considerations for power semiconductor devices, modules, and applications	24
1.2.2 Power semiconductor devices, modules, and applications	25
1.2.3 Challenges for the transition to an energy-wise society	26
Section 2 Power electronics trends and future perspectives	28
2.1 Electricity generation and distribution application – Energy sector introduction	28
2.1.1 Conventional electricity systems	28
2.1.2 Power distribution and grid (AC, DC)	29
2.1.3 Photovoltaic generation	31
2.1.4 Wind generation	32
2.1.5 Green hydrogen generation	33
2.1.6 Solid state transformers and solid-state circuit breakers	34
2.1.7 Mobility infrastructures	36
2.1.8 Energy storage for grid stabilization	37
2.2 Electrification application – User sector introduction	39
2.2.1 Electrified mobility	40
2.2.2 Automotive	40
2.2.3 Railway	42
2.2.4 Electrified aircraft	44
2.2.5 Electrified ships	45
2.2.6 Factory automation, industrial motors, and inverters	46

2.2.7	Heavy industries and highpower converters	47
2.2.8	Other industry applications	48
2.2.9	Heating and cooling, home appliances	49
2.3	Data centres and telecom information technologies – IT sector	51

Section 3 Power semiconductor devices trends and future perspectives 53

3.1	Introduction and background	53
3.2	Power semiconductor chip technologies	53
3.3	Silicon chip technologies, history, and future trends	54
3.3.1	Thyristor	56
3.3.2	GTO and GCT	56
3.3.3	IGBT and freewheeling diode	59
3.4	WBG chip technologies, history, and future trends	59
3.4.1	SiC semiconductor chip technologies	60
3.4.2	GaN semiconductor chip technologies	62
3.4.3	Future wide band gap materials	63
3.5	Power module technologies	64
3.5.1	Typical outline of generalpurpose industrial power modules	65
3.5.2	IPM and application-specific power modules	66
3.5.3	WBG power modules	68
3.6	Supply chains that support power semiconductors	69
3.6.1	Silicon power wafers supply	69
3.6.2	SiC power wafers supply	71
3.6.3	GaN power wafers supply	72
3.6.4	Power module materials and parts supply	72
3.7	Gate drivers	74
3.8	Life cycle assessment of power semiconductors and power electronics	75

Section 4 Standards needs for power semiconductors for an energy-wise society 77

4.1	The present state of affairs	78
4.2	Future standards needs	79
4.3	Filling the void of power module standards	79
4.4	Standards required for WBG materials	81
4.5	Standards for meeting future, user-driven changes	81

Section 5	Conclusions and recommendations	84
5.1	Recommendations addressed to policy makers and regulators	84
5.2	Recommendations addressed to the industry	85
5.3	Recommendations addressed to the IEC and other standards developing organizations (SDOs)	86
Annex A		88
Annex B		89
Bibliography		91

List of abbreviations

Technical and scientific terms

2DEG	two-dimensional electron gas
2L-PWM-VCS	two-level pulse width modulated voltage source convertor
AC	alternating current
AEA	all-electric aircraft
AECS	all-electric and connected society
AFE	active front end
AI	artificial intelligence
AlGaN	aluminium gallium nitride
AlN	aluminium nitride
Al₂O₃	aluminium oxide
AlSiC	aluminium-SiC composite
APF	annual performance factor
AQG	Automotive Qualification Guideline (ECPE)
BEV	battery electric vehicle
BJT	bipolar junction transistor
BCT	bi-directional control thyristor
BMS	battery management system
BPD	basal plane dislocation
CA	conformity assessment
CAGR	compound annual growth rate
CapEx	capital expenditure
CMC	cascaded multicell
COP	coefficient of performance
CRM	Critical Raw Material (EU regulatory list)
c-Si	crystalline silicon
CSTBT	carrier stored trench bipolar transistor
CT	computer tomography
CTE	coefficient of thermal expansion

CVD	chemical vapor deposition
DC	direct current
DCB	direct copper bonding
DCFC	direct current fast charger
DFIG	doubly fed induction generator
EMC	electromagnetic compatibility
EMI	electromagnetic interference
epi	epitaxial
ESS	energy storage system
ETT	electrically triggered thyristors
EV	electric vehicle
FACTS	flexible AC transmission system
FCEV	fuel cell electric vehicle
FCV	fuel cell vehicle
FP	fine pattern
FS	field stop
FZ	floating zone
FWD	free-wheeling diode
Ga₂O₃	gallium oxide
GaN	gallium nitride
GCT	gate commutated thyristor
GHG	greenhouse gas ¹
Gt	gigaton
GTO	gate turn-off thyristor
H₂	hydrogen
H³TRB	high humidity, high temperature and reverse bias
HV-H³TRB	high humidity, high temperature and reverse bias with high voltage applied
HEA	hybrid electric aircraft

¹ Such as carbon dioxide CO₂, methane CH₄, or sulfur hexafluoride SF₆.

HEV	hybrid electric vehicle
HEMT	high electron mobility transistor
HF	high frequency
HiGT	high conductivity insulated gate bipolar transistor
HVDC	high voltage direct current
HSI	hardware/software interface
IBR	inverter-based resource
IC	integrated circuit
ICT	information and communications technology
IDM	integrated device manufacturer
IeGT	injection enhanced gate transistor
IGBT	insulated gate bipolar transistor
IGCT	integrated gate commutated thyristor
INV	inverter
IoT	Internet of Things
IPM	intelligent power module
IT	information technology
JFET	junction field-effect transistor
kW	kilowatt
LCA	life cycle assessment, also known as life cycle analysis
LCC	load commutated converter
LIDAR	light detection and ranging
LTT	light-triggered thyristors
LV	low voltage
LVDC	low voltage direct current
MCU	microcontroller unit
MCZ	magnetic-field applied Czochralski
MEA	more-electric aircraft
MEF	market evaluation form (IEC)
MMC	modular multilevel converter
MOS	metal oxide semiconductor
MOSFET	metal-oxide-semiconductor field-effect transistor

MP	micropipe
MRI	magnetic resonance image
MV	medium voltage
MVAC	medium voltage alternating current
MVD	medium voltage drive
MW	megawatt
NPC	neutral-point-clamped
NTD	neutron transmutation doping
NZE	Net Zero Emissions by 2050 Scenario (IEA)
OBC	on-board charger
OpEx	operational expenditure
PAM	pulse amplitude modulation
PCB	printed circuit board
PCT	phase control thyristor
PE	power electronics
PET	positron emission tomography
PFC	power factor correction
PHS	pumped hydro storage
PtX	power-to-X
PUE	power usage effectiveness
PV	photovoltaic
PVT	physical vapor transport
PWM	pulse width modulation
RAC	residential inverter air conditioner
R&D	research and development
RB	reverse-blocking
RC	reverse-conducting
RC-IGBT	reverse-conducting insulated gate bipolar transistor
REACH	Registration, Evaluation, Authorisation and Restriction of Chemicals (EU Regulation)
RF	radio frequency

RoHS	Restriction of Hazardous Substances in Electrical and Electronic Equipment (EU Directive)
SBD	Schottky barrier diode
SC	subcommittee (IEC)
SCR	silicon-controlled rectifier
SDG	Sustainable Development Goal (UN)
SDO	standards developing organization
SEER	seasonal energy efficiency ratio
SG	strategic group (IEC)
SiC	silicon carbide
SiC MOFSET	silicon carbide metal-oxide-semiconductor field-effect transistor
Si₃N₄	silicon nitride
SJ	super junction
SOA	safe operating area
SOC	state of charge
SPT	soft punch through
SSCB	solid-state circuit breaker
SST	solid-state transformer
STATCOM	static synchronous compensator
T&D	transmission and distribution
TC	technical committee (IEC)
TED	threading edge dislocation
TFS	trench field stop
TO	transistor outline
TSD	threading screw dislocation
TSEP	temperature sensitive electrical parameter
UHV	ultra high voltage
UPS	uninterruptible power supply
UV	ultraviolet
UWBG	ultrawide bandgap

VRE	variable renewable energy (e.g. solar, wind)
VSC	voltage source converter
VSD	variable speed drive
WBG	wide bandgap
WG	working group (IEC)
YP	young professional

.....

**Organizations,
institutions and
companies**

AEC	Automotive Electronics Council
ANSI	American National Standards Institute
CAB	IEC Conformity Assessment Board
CENELEC	European Committee for Electrotechnical Standardization
ECPE	European Center for Power Electronics
EU	European Union
IEA	International Energy Agency
IEC	International Electrotechnical Commission
IEEE	Institute of Electrical and Electronics Engineers
ISO	International Organization for Standardization
JEDEC	JEDEC Solid State Technology Association, located in the US with worldwide membership and accredited by ANSI
JEITA	Japan Electronics and Information Technology Industries Association
MSB	IEC Market Strategy Board
PECTA	Power Conversion Technology Annex Platform (of the IEA)
SEMI	Semiconductor Equipment and Materials Institute
SMB	IEC Standardization Management Board
UL	Underwriters Laboratories

Glossary

intelligent power module

power module that additionally includes integrated circuitry dedicated to controlling, protecting, and gate-driving the internal power devices to enhance performance, reliability and easy-to-use features in its applications

inverterization

use of a power inverter between an energy source and user equipment (for example between the power grid and a motor in an electrical fan or HVAC unit), rather than connecting the user equipment directly to the grid

power converter/inverter

electrical device that processes and controls the flow of electrical energy by supplying voltages and currents in a form that is optimally suited for user loads

NOTE 1 Converters convert the voltage from alternating current (AC) to direct current (DC). Inverters convert the voltage from DC to AC.

NOTE 2 Modern power converters and inverters rely on power semiconductors as active switches and on capacitors, inductances (and mutual inductances or transformers) as passive (reactive) components used for intermediate energy storage and voltage/current filtering. A large part of power converter design is the optimization of its energy efficiency and its power density [1]².

power electronics

electronic circuits technology for the control of electric power in all its phases during generation, transmission, distribution and conversion, using power semiconductor devices

NOTE Power electronics enable a wide range of uses of electricity in applications covering millivolts/milliwatts to hundreds of thousands of volts/gigawatts [2].

power module

isolated power semiconductor device consisting of an assembly of at least two power semiconductor chips (which can be of different types/materials) in a single package/housing, providing insulation of the internal semiconductors through an integral electrical insulator between the cooling surface or base plate and any isolated circuit elements

NOTE Power modules may contain sensing circuits such as thermistors (in line with IEC 60747-15 and UL1557).

power semiconductor (chip/bare die)

gate- or base-controlled electronic device or diode whose current ratings are generally above 1 A

NOTE Excluded from the devices described by this term are photodiodes, microwave devices and semiconductor sensors.

reliability

fundamental attribute for the safe operation of any modern technological system including power semiconductors and power electronics [3]

NOTE A fundamental aspect of the reliability theory is that the probability of failure function displays a “bathtub shape” [4]. The curve represents the idea that the operation of a population of power semiconductor devices for example can be viewed as comprised of three distinct periods:

- an “early failure” (burn-in) period, where the probability of failure decreases over time;
- a “random failure” (useful life) period, where the probability of failure is constant over time;
- a “wear-out” period, where the probability of failure increases over time.

² Numbers in square brackets refer to the Bibliography.

semiconductor material

material defined by its ability to conduct electricity and whose conductivity can be adjusted under specific conditions to act either as a pure conductor or a pure insulator

NOTE After specific processing is performed on them, semiconductor materials can control the direction of the flow of electrical charges (i.e. current), which is a unique property, because pure conductors allow electrical current to flow in both directions.

semiconductor wafer

thin slice of semiconductor material, such as a crystalline silicon (c-Si) or silicon carbide (SiC), used for the fabrication of integrated circuits, power semiconductor chips, etc.

Section 1

Towards an energy-wise society

1.1 Introduction and background

The role of power semiconductors in advancing the electrical and electronic foundations of industries and society in general has long been a comparatively quiet and unheralded one even though power semiconductors (including power management integrated circuits (IC) which are shipped more than any other type of IC device according to IC Insights [5]) and power semiconductors occupy a respectable but not massive economic market share amounting to approximately 10% of the entire ecosystem of semiconductors [6] [7] [8]. Yet, the critical role power semiconductors play is not readily recognized by, or visible to, those not immediately involved in the industry. Furthermore, only a limited number of experts could identify the purpose and role of power semiconductors in each application. Power semiconductors are also not easily visible from the perspective of consumers and other end-users, who need not, or dare not, “look under the hood”. Yet, power semiconductors hold the key to improved energy efficiency, along with the development of power supply systems based on renewable energies that must operate under increasingly demanding conditions. The accelerating shift towards a green and decarbonized society has made the unique role of power semiconductors, especially high power semiconductors, particularly worthy of prompt attention by industry and standards developing organizations (SDOs).

The large-scale deployment of clean energy sources, particularly renewables, coupled with high levels of electrification will be the key to reducing emissions of greenhouse gases (GHG). The energy

shift from fossil fuel to electricity together with economic growth will bring an enormous increase of electricity usage. Taking “source-to-end-user” energy losses into consideration, efficiency in transferring and utilizing electricity is extremely important. There exist myriad types of power electronics (PE) applications used in this context, and power semiconductors are the key electronic devices that enable these PE applications.

Recently, there has been a stir concerning the shortage of semiconductors, and in this respect power semiconductors are no exception. It is strongly evident that forward-looking developments need to take market growth into account.

From the standpoint of standards, the need for power semiconductor device – and in particular wide bandgap (WBG) device – standards has been recently recognized. Since power modules are used in a myriad of applications, power semiconductors must comply not only with semiconductor standards but also with application-specific standards that change and evolve daily.

An example of current efforts is the noteworthy work being performed by IEC Technical Committee 47: Semiconductor devices / Working Group 8: Wide bandgap technologies – Power electronic conversion. However, the continuing conundrum that standardization organizations face is that industrial and global needs for power semiconductors are outpacing the development of adequate international standards and conformity assessment (CA) systems.

As envisioned for standardization communities, the ultimate goal of the white paper is to foster greater awareness beyond the present level of technical

committees and to bring power semiconductors to the forefront of standardization initiatives. A much-needed alignment of industry growth with standards development would play a significant part in creating awareness of the key role and importance of power semiconductors.

A concurrent aim of the white paper, reflecting the role of the IEC Market Strategy Board (MSB), is to fulfil the IEC Strategic Plan (see Figure 1-1), which encompasses nine goals that the IEC aims to realize through its work [9]. The white paper focuses on six of those nine goals centered on

helping create all-electric, clean and innovative societies.

Power semiconductors deliver economic, environmental and social value as key electronic components exercising a direct impact on achieving the United Nations Sustainable Development Goals (SDG). They contribute to creating the foundation for shaping worldwide economic progress in harmony with society and the environment. Thus, power semiconductors need to be more widely recognized for their contributions towards multiple UN SDGs as outlined in Table 1-1.

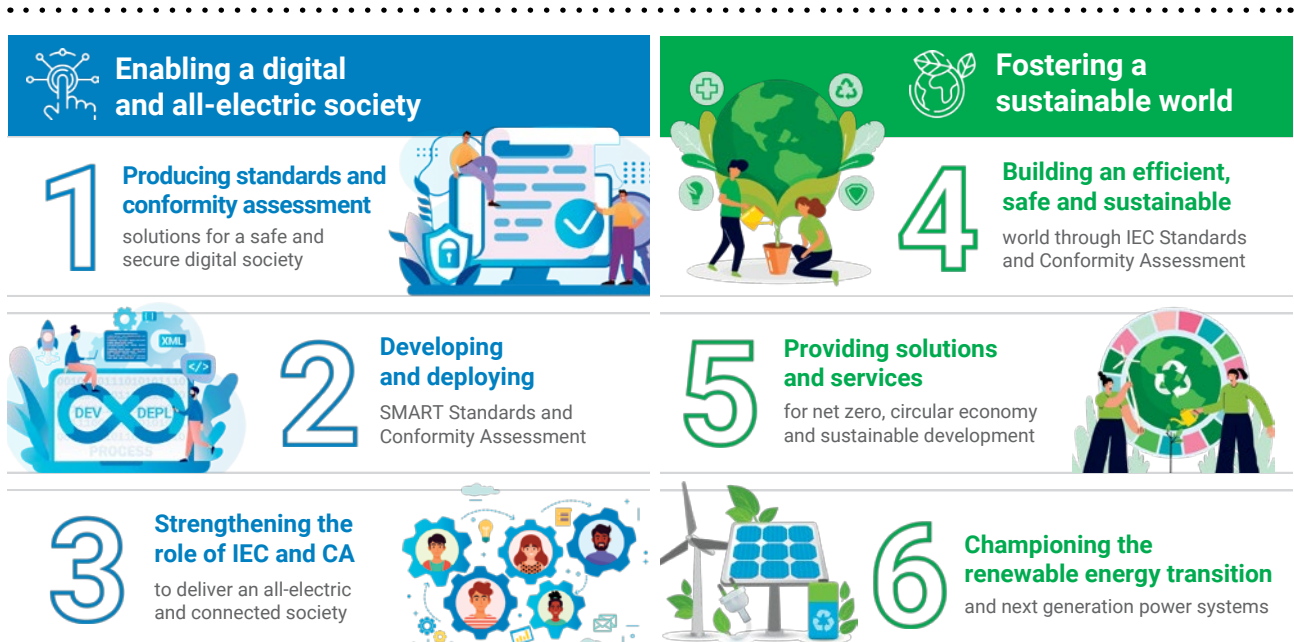

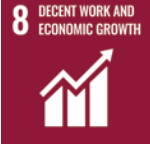



Figure 1-1 | IEC Strategic Plan goals aligned with the white paper [9]

Table 1-1 | Impact of power semiconductors on the UN SDGs

UN SDG	Impact of power semiconductor
	<ul style="list-style-type: none"> ▪ Convert renewable energy sources (solar, wind, hydro) to electrical energy ▪ Transport and distribution of renewable energy to consumers, sometimes over large distances ▪ Ensure high energy efficiency
	<ul style="list-style-type: none"> ▪ Renewable energy installations represent a growing market for companies directly involved in the supply chain, but also for adjacent businesses (service/maintenance, etc.) ▪ New industries and business models enabled by emerging power electronics with power semiconductors (green hydrogen, electric vehicle (EV) fast charging networks, etc.)
	<ul style="list-style-type: none"> ▪ Clean and environmentally friendly technologies that address societal demands, foster innovation and build sustainable industry and infrastructure (e.g. motor drives and robotics to increase efficiency in industrial factories)
	<ul style="list-style-type: none"> ▪ Renewables, electrical vehicles and green hydrogen reduce dependence on fossil fuels in transportation and various industrial processes ▪ Increased energy efficiency means fewer resources are needed

1.1.1 Power semiconductors as a key towards an energy-wise society

The expression “energy-wise society” may appear synonymous with the terms “carbon neutrality” and “sustainability”. However, with power semiconductor devices representing the key enablers of this powerful option, the vision for an energy-wise society is that industry and consumers will achieve “a society that uses energy wisely” in which electricity is available and affordable to them and can be used at their own discretion.

Topics such as new circuit topology, new power semiconductor device technology, and other new findings that enable greater system-level energy efficiencies represent key elements in developments towards an energy-wise society, as presented in the white paper. Figure 1-2 illustrates

some of the major market segments in which power semiconductor applications fit into the concept of an energy-wise society.

An energy-wise society will be shaped by major driving forces, megatrends and market and societal needs that will significantly impact the development and use of power semiconductors, which in turn shall address a variety of challenges:

- Climate change – requires significant reductions of CO₂ emissions as well as other problematic chemicals with high impact on the environment (GHG). Replacing natural gas with green hydrogen (H₂) in many industrial and transportation applications requires large-scale deployment of electrolyzers with lower electrical losses and advanced grid integration

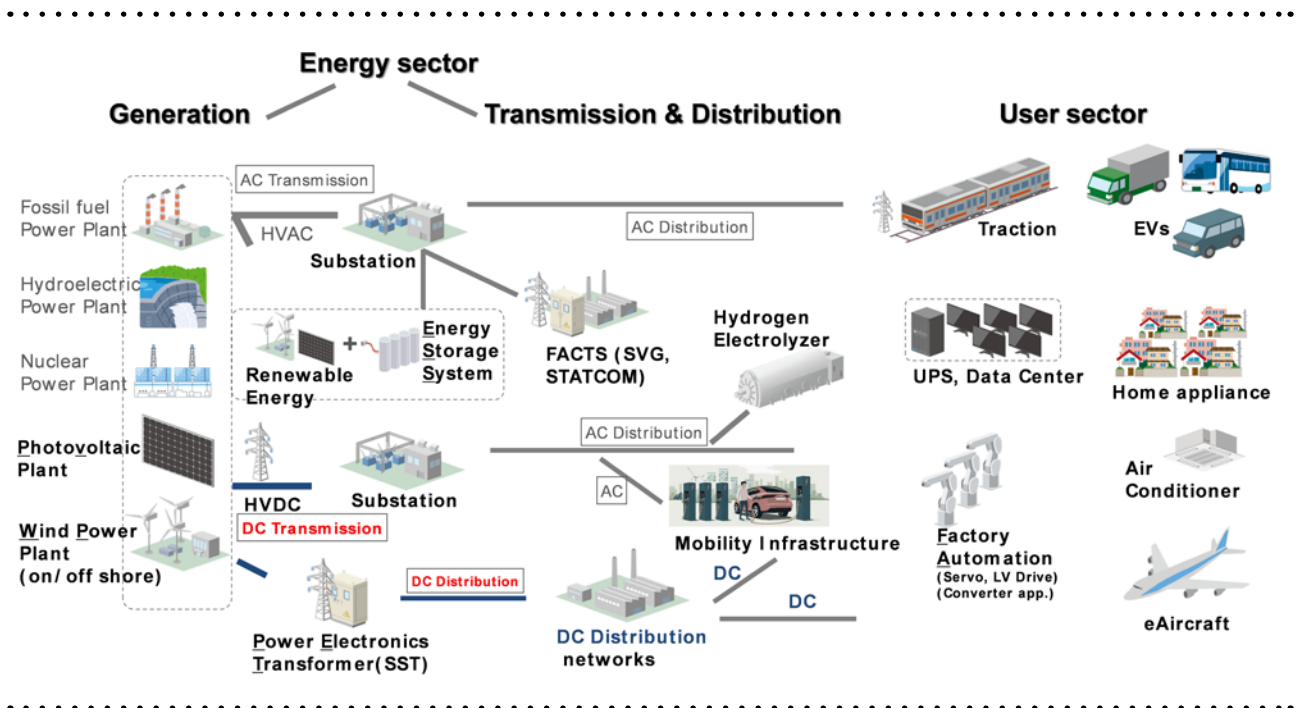

Figure 1-2 | Power semiconductors and their applications for an energy-wise society³

capabilities. According to a recent International Energy Agency (IEA) report [10] and as depicted in Figure 1-3, more than 36,3 Gt of equivalent CO₂ emissions were generated in conjunction with energy-related sectors in 2021.

- Achieving net zero or even zero carbon – requires significant capacity increases for renewable energy installations (photovoltaic (PV), wind), sometimes in regions far removed from the major energy usage areas. New loads will also appear in the power system to dramatically increase demand [11]. Achieving net zero means also a decarbonized transportation system based on emissions-free vehicles (e.g. EVs).

- Information and communications technologies (ICT) – leads to increased data processing and transmission capabilities (data centres, 5G communications, etc.) requiring additional energy use and large-scale backup facilities for stable power supply.
- Total cost of ownership – leads to considering system cost reductions across the lifetime of a power electronic system via energy efficiency, smaller system size and reliability. A better understanding of the relationships between power – efficiency – reliability – capital costs – life cycle costs is also required for achieving a more energy-wise society.

3 Source: Mitsubishi Electric

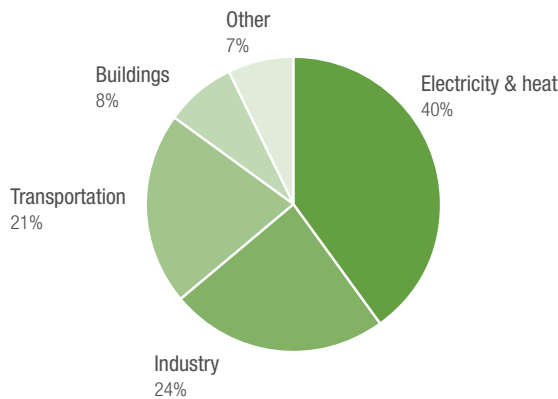

Figure 1-3 | Distribution of 36,3 gigatons (Gt) of equivalent CO₂ emissions generated in conjunction with energy-related sectors in 2021

The authors and contributors to the white paper share the vision of an energy-wise society that can only be achieved by the large-scale deployment of power semiconductors in power electronic systems that control the electrical energy generation/conversion/storage/distribution from renewable energy sources and through the power grid. In turn this will drive the electrification of transportation and industry sectors, and digitalization of the society in general.

1.1.2 Objectives of the white paper

The white paper naturally touches on a wide variety of power semiconductor technologies from the past, present and not-so-distant future (until 2030), ranging from the well-known to the cutting-edge and also the contentious. Sponsored by the IEC MSB, the white paper's purpose is also an effort to bring a better, more comprehensive "market needs" approach to the wide scope of power semiconductor technologies that are currently available, as well as those technologies in the development pipeline.

The white paper is therefore meant to bring greater awareness to the IEC community concerning market-oriented, market-driven, and market-

focused roles that power semiconductors perform over a very broad spectrum of industries and in the wider society as a whole.

The white paper also illustrates the need and opportunity for the IEC to place itself in the position of driving the change to better, more efficient, smaller, lighter, more robust and cost-effective power semiconductors. In other words, the IEC is primed to position itself at the forefront of enabling technology solutions for our energy-wise society.

To summarize, the main objectives of the white paper include:

- to identify the picture and trends of how power semiconductors contribute, or are expected to contribute, to demanding applications for an energy-wise society;
- to examine the readiness of – as well as potential markets for – WBG devices based on application-specific developments;
- to evaluate at a high level the impact on energy, technologies, supply chains, policies and relevant standards;
- to provide an outline of how future standardization could be conducted, for example, in collaboration between power semiconductor device manufacturers and power electronics industry members.

The project team included more than 60 experts from academia and industry, whose know-how and expertise were focused to ensure that the white paper meets and exceeds the above-mentioned goals. But even more importantly, that the white paper will help bring power semiconductors to the forefront of the IEC community's attention.

1.2 Scope and structure of the white paper

The white paper discusses power semiconductor devices mainly used in power electronics for the energy sector and for the user-side sector that are relevant to an energy-wise society. Figure 1-4 summarizes the major applications involved and the typical nominal voltage of power semiconductor devices used in these applications.

For clarity, the following voltage categories are defined and used throughout the white paper:

- Low voltage includes power semiconductor devices with a blocking voltage capability of up to 600 V per device.
- Medium voltage includes power semiconductor devices with a blocking voltage capability between 600 V and 1 700 V per device.
- High voltage includes power semiconductor devices with a blocking capability between 1 700 V and above 10 kV per device.

In addition, the authors offer insights on various power semiconductors, power modules and key applications for an energy-wise society. Examples of these include: high voltage direct current (HVDC) for transmission grids, direct current fast chargers (DCFC), uninterruptible power supplies (UPS) for

data centres, medium voltage drives (MVD) for motors, rail transport, electrical vehicle (EV) drives, renewable energies, home appliances, and heating and cooling systems.

As shown in Figure 1-2, many of the energy-wise society applications being discussed in the white paper are focused at higher power levels. While the emphasis of the white paper is on higher power level applications, the role of power semiconductors for energy efficiency and smart energy usage is much broader. Many of the conclusions and recommendations of the white paper are valid across the broader power semiconductor space, including the range of low-medium voltage power semiconductors.

1.2.1 Market considerations for power semiconductor devices, modules, and applications

Power semiconductors have been dominant for decades in the form of silicon-based power devices. In recent years, alternative materials to silicon have become commercially available in the form of silicon carbide (SiC) and gallium nitride (GaN), enabling additional improvements in electrical energy conversion efficiency, reduced heat losses and reduced operating costs for power electronic systems.

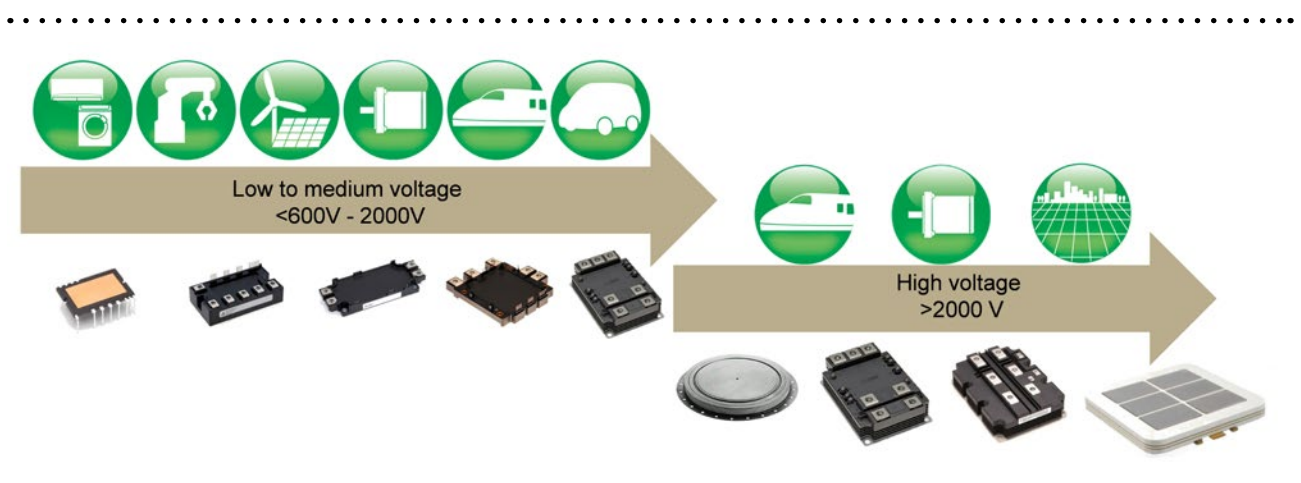

Figure 1-4 | Voltage classes of power semiconductor devices for an energy-wise society (for the purposes of this white paper)

The market for power semiconductors is expected to grow at a sustained pace over the next decade, with the compound annual growth rate (CAGR) varying between a few percentages and up to 10% between 2022 and 2030, reaching a total market value of more than USD 45 billion by 2030 (comprising all types of power semiconductor devices but excluding power management ICs) [6]. The market for WBG power semiconductor devices is expected to grow at an accelerated pace over the next few years with a CAGR of more than 30% between 2022 and 2027, reaching a market value of more than USD 6 billion by 2027 [12].

It is expected that the power semiconductor market will continue to grow due to increasing shares of renewable energy which will need to be converted and connected to the existing and future power grids. It is also expected that the market will grow due to existing applications such as home appliances, and due also to new applications that are just beginning to gain commercial significance, for example, fast chargers for electrical vehicles, electrolyzers for green H₂ generation, and battery-based energy storage systems (ESS). An energy grid powered by converters with power semiconductors would be able to transmit large amounts of energy across large distances with minimal losses. Building an independent and stable power grid with secure access to low-cost, sustainable and green energy is a key strategic focus for many economies around the world. But numerous power semiconductor devices are also sold in industrial markets, so any slowdown of the global economy will partially be reflected in the lower growth rates of the overall market.

However, the high economic impact of the power semiconductor devices is further compounded when considering the market of power electronic systems in which they are applied. For example, it is estimated that by 2031, the market for automotive inverters alone will surpass USD 59 billion at a CAGR of 17% [13], for HVDC converters USD 17 billion at a CAGR of 15,5% [14], and for PV inverters USD 52 billion at a CAGR of 15,7% [15].

When considering the general dynamic of the market and of the industry, it must be mentioned that silicon-based power semiconductor devices are mature technologies with decades-long experience in the field. Fewer start-up companies are focusing on silicon, and most of the established integrated device manufacturer (IDM) companies are investing to expand their production capacities and internal R&D evolutionary efforts. The field of WBG power semiconductor devices is currently a very dynamic area of development with many private-sector investments and numerous new enterprises being founded based on research, thus clearly recognizing the potential for market growth and large-scale deployment. Both established and new IDM companies are investing in the development and commercialization of WBG technology, sometimes through new business models that were not common in the silicon power semiconductor business (e.g. strategic long term partnerships along the entire supply chain).

1.2.2 Power semiconductor devices, modules, and applications

Power semiconductor devices are complex electronic components used to switch on/off or to amplify electrical currents. The control of these devices is effected using low amplitude gate voltages or base currents, while the devices exhibit electrical current ratings above 1 A. The focus of the white paper is on power semiconductor devices applied for current switching functionality. Simply described, in an electrical circuit these components act in a similar manner to mechanical switches by controlling the flow of an electrical current through the electrical circuit depending on the voltage levels and control signals, with the major difference being that the switching operation of power semiconductors is done entirely electronically and without moving parts, at extremely high speeds and within extremely short timeframes, (as short as microseconds). Furthermore, if ICs are considered to be the key enablers for the flow of information and processing

of digital data, then power semiconductor devices pave the way for the flow of electrical energy and processing of electrical power.

Power semiconductor devices are constructed entirely from crystal-like material structures of very high quality in order to ensure high performance and to be capable of operating at high voltages of up to thousands of volts. Typical materials are silicon, silicon carbide, and gallium nitride. In order to protect power devices against various electrical and other external factors (such as environmental humidity, pollution, etc.), power modules and discrete packages / housings have been developed that integrate two or more power devices in either a single component with larger electrical current rating, or in a specific subcircuit topology. The power modules together with many other auxiliary components required for their proper operation are subsequently incorporated in larger electrical circuits enabling a wide range of power electronic applications, for example solar inverters, wind converters, and rail traction inverters. The performance of power devices in applications is normally assessed in terms of the system level energy efficiency, cost, reliability and power density (or system size). A noted trend is for efficiency requirements to continue to increase, power density targets also to increase, and system costs expected to decrease.

The white paper also reviews the state of the art and upcoming commercial developments of silicon, as well as WBG power semiconductor devices. WBG power devices will be key for reaching higher electrical efficiencies beyond the limits offered by silicon technology. Thanks to their properties, WBG power devices can enable the creation of smaller power electronics systems, hence reducing the amount of various required materials in such equipment.

While silicon power semiconductors are ubiquitous in all modern power electronic applications, their WBG counterparts are gradually being introduced in select applications. This trend is explored in

the white paper by considering the likelihood of commercial scale adoption of WBG power semiconductors versus the impact of their adoption over the next 5-10 years. The WBG technology is foreseen to enable simpler circuit topologies, smaller cooling systems and more cost-effective power electronic systems. More suitable power electronic solutions will become available to support electrification, which will become a key driving force of an energy-wise society. The WBG technologies will enable new applications and the solutions required by an energy-wise society for bi-directional and fast charging of EVs, energy storage and harvesting of renewable energies.

1.2.3 Challenges for the transition to an energy-wise society

The challenges associated with the transition to an energy-wise society are multiple and require cross-domain and international collaboration. Their impact spans from the supply chains of various industries to the electrical power grid.

For example, expectations for installing renewable energy capacity in a net zero 2050 scenario require significant amounts of power semiconductors and power electronics which may be above the production capacities of various suppliers in the short to medium term. Ensuring a smooth transition from silicon to WBG power semiconductors in select applications also constitutes a challenge, while the ecosystem of suppliers and manufacturers is still developing, and demand for power semiconductors and power converters surpasses the existing supply.

Furthermore, a power system suitable for an energy-wise society will have more dynamic and distributed generation and load profiles, with significant swings from very low consumption to high consumption both during the course of a single day as well as seasonally [11]. This would require rethinking the design of power systems, and introducing new technologies uniquely enabled

by power semiconductors and power electronics for the purposes of energy storage, power flow control, and voltage stabilization in the grid.

To support the accelerated rollout of power converters in an increasing number of applications, market-driven standardization efforts are required in aligning the triad of power semiconductor chip development, module level packaging and power electronic applications, to prevent a development-level disconnect between these areas.

In consideration of the rapidly increasing number of power converters across various applications, sustainability aspects need to be more intensively considered from the very beginning in the development cycle of power semiconductors as well as power converters.

Section 2 links some of these challenges at the system level to overall and individual trends and future perspectives of key power electronic applications. The purpose of reviewing such applications is also to provide the background in which specific power semiconductor technologies discussed in Section 3, such as WBG, could assume their newfound or growing role, in an energy-wise society.

Section 2

Power electronics trends and future perspectives

2.1 Electricity generation and distribution application – Energy sector introduction

The global energy sector has begun its transition from fossil-based to zero-carbon sources with the aim of mitigating climate change and restricting global temperature to within 1,5 °C of pre-industrial levels. To accelerate such a green transition, urgent actions are needed on both the national and international scales and within different industry sectors. However, there exists no one-size-fits-all solution for achieving a fully decarbonized energy sector. Smart electrification exploiting variable renewable energies (VRE), and improvement of energy efficiency and conservation through emerging technologies, are key drivers, while cross-sectoral integration backed with carbon removal measures for a cost-effective, efficient, and sustainable energy-wise society is a must.

As the energy sector shifts towards a vision of (net) zero carbon, this will bring profound implications for the electrical power system of any country/region [11]. On one hand, there will be a large share of distributed energy sources, with much more dynamic generation profiles. On the other hand, in the presence of more informed and active prosumers, massive electrification of transport and heat, and cross-sectoral integration through power-to-X (PtX) technologies, the demand on the power system will dramatically increase. Power electronics and power semiconductor technologies provide solutions for issues in the energy sector, for example, for handling increased grid instability. For power electronics used in these applications,

the lifetime requirements, and often the reliability requirements, exceed the levels currently expected for consumer, automotive and most industrial applications. The use of highly efficient power semiconductor devices and interfaces for integrating renewable sources in power generation, transmission and distribution, together with advanced grid control solutions, can pave the way towards future power grids. Such power grids must remain reliable (typically defined as a power system's ability to avoid outages) and resilient (defined as a power system's ability to withstand disruptive events and come back online after a major outage) and become more data driven. In addition, power system operators and power utilities must be ready to respond to uncertainties that exist at the supply and demand sides or risk facing unpredicted issues across the power grid. This will necessitate delivering increased flexibility and grid storage capabilities, thus enabling higher degrees of observability for the grid's operational parameters, including consumer demand and prosumer exports, and for grid-connected assets. Such additional functionalities can only be realized through the use of power semiconductors and power electronics as described in more detail in the following subsections.

2.1.1 Conventional electricity systems

Electricity generated using fossil fuels (coal, petroleum, natural gas) or other carbon-based fuels (biogas, wood) utilizes thermal generation processes that are inherently and extremely inefficient, as the majority of the fuel energy is lost to the environment as waste heat. Additional losses

come from the energy used to operate the power plant itself as well as from the power transmission and distribution grids. As a consequence, from the generation point to the consumer, almost two-thirds of the initial fuel energy will be lost. Various impacts due to mining and processing the fuels, GHG emissions, discharge of particulates from burning the fuels, and other forms of pollution must also be accounted for in addition to the energy losses. Figure 2-1 illustrates the energy losses in a conventional electricity system.

In a conventional electricity system, power semiconductors are encountered in relatively few but key applications. For example, thyristors are used in large exciter systems that provide direct current (DC) to the rotors of synchronous generators. Thyristors and, more recently, insulated gate bipolar transistors (IGBT) also form the core of flexible alternating current (AC) transmission systems (FACTS), which are used to optimize the capacity of existing power grids. However, this situation is about to change drastically in favour of power semiconductors.

Driven by the societal trend of achieving carbon neutrality, power generation is shifting away from conventional methods such as fossil fuels. Renewable energy sources are regarded as the future of electricity systems because they are considered to be carbon-free and generate much less waste heat than conventional methods, though smaller amounts of CO₂ may be generated during the manufacturing and installation of renewable energy components such as solar panels, wind turbines and associated power electronics.

Nevertheless, most of the losses encountered in the case of renewable energy sources are due to the power semiconductors in the power electronics controlling the flow of electricity from the energy sources to the power grid, as well as additional losses from the transformers and cables. These losses currently amount to below 5-10% of the input energy. It is thus essential, as part of transitioning to an energy-wise society, to reduce the energy losses to consumers from generation by accelerating the switch from conventional energy generation to renewable energy sources, as well as inverterization of final user equipment (motors, lights, etc.).

Furthermore, the conventional electricity system is almost entirely based on AC transmission lines linked to a few large centralized power generation centres. With the increased rollout of renewable energy sources, the power generation centres are becoming smaller, more distributed and located further away from consumers, which means the future electricity system will include an increasing mix of DC transmission lines and grids.

2.1.2 Power distribution and grid (AC, DC)

Globally, the electricity sector is accelerating its transition to become more sustainable, and the most important change involved is the increasing share of VRE in global electricity generation. In the IEA Net Zero Emissions by 2050 Scenario (NZE), this share is expected to increase from 29% in 2020 to 60% in 2030, mainly driven by the growth of solar and wind energy capacity installations [16].

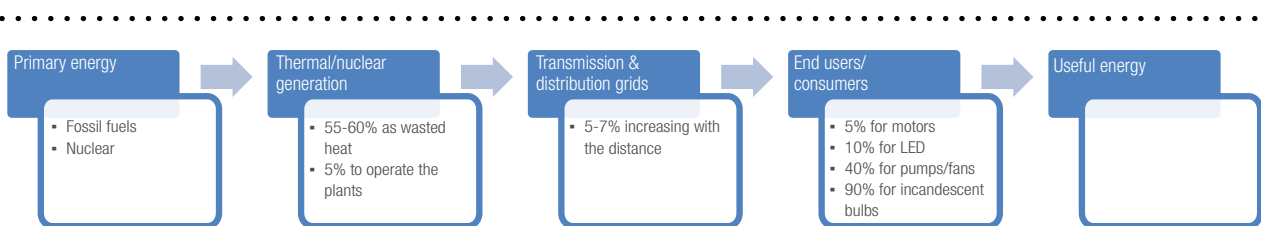

Figure 2-1 | Losses in the conventional electricity system based on fossil fuels

This market development trend has multiple consequences. On one hand, the VRE has to be transmitted from the decentralized production sites to the large user sites across large distances and with as low electrical energy losses as possible. This is the case, for example, of offshore wind installations or large solar installations in the desert. On the other hand, power systems are experiencing large-scale inverter-based resource (IBR) integration, which involves fundamental changes in their design and operation principles. With an increasing share of electrical energy flowing through power converters, the grid inertia constant is lower and there are faster deviation rates of frequency. The conventional grid stabilization achieved from conventional generators now becomes a requirement for the IBRs which are increasingly required to support the power system operation and improve its reliability and resiliency. FACTS are also used in power grids to improve their efficiency, reliability, and flexibility through controlling power flows and voltage levels. By doing so, they help to optimize the use of the grid infrastructure and reduce the need for costly upgrades. FACTS can also improve the stability of the grid by damping out voltage and current oscillations, thereby reducing the risk of power outages and blackouts. Additionally, FACTS can help to facilitate the integration of renewable energy sources into the grid by smoothing out fluctuations in power output and improving the quality of the power supplied to consumers.

When connecting VRE (e.g. offshore wind farms) to the grid, the distance to the nearest strong grid connection point, can be more than 100-150 km away from the generation site. Additionally, the energy then has to be transmitted to highly populated/industrialized areas which can be located thousands of kilometres away from the first grid connection point. The alternative of transporting VRE as DC current becomes competitive – both from an investment and operational cost perspective – with increasing

power rating and transmission distance. The HVDC technology is a highly efficient alternative to AC for transmitting large amounts of electricity with greater stability and lower electrical losses. It enables secure and stable interconnection of power networks that operate on different voltages and frequencies (i.e. are asynchronous) or are otherwise incompatible. It also provides instant and precise control of the power flow and can increase the AC grid capacity with its stabilizing features. The most straightforward HVDC configuration is a point-to-point connection of a converter installed close to the VRE generation point, and a converter located close to the nearest grid connection point. So far, most of the HVDC connections in operation are of this type. Some recent projects also include multiple, parallel point-to-point HVDC links or a multiterminal HVDC system.

For many decades, thyristor-based load commutated converter (LCC) systems have been used for feeding electric power from large hydropower stations in remote locations to urban areas far away via a DC overhead line. Interconnecting grids in different areas or at different frequencies have been another application. With the market introduction of voltage source converter (VSC)-based HVDC systems, new applications became possible, for example the HVDC connection of offshore windfarms, as, contrary to LCC, VSC systems offer black start and islanding operation (i.e. grid forming) capabilities without the need for directly connected synchronous generators. Currently, both LCC-HVDC and VSC-HVDC provide transmission losses lower than 0,75% of their power rating. LCC-HVDC systems operate at 800 kV and up to 1 100 kV for a maximum power rating up to 12 GW, and VSC-HVDC systems operate at moderate voltages of up to 320 kV for a maximum power rating of up to 4 GW. Companies involved in the HVDC market were among the first to consider life cycle assessment (LCA) as an integral part of the design, production and marketing value proposition. For

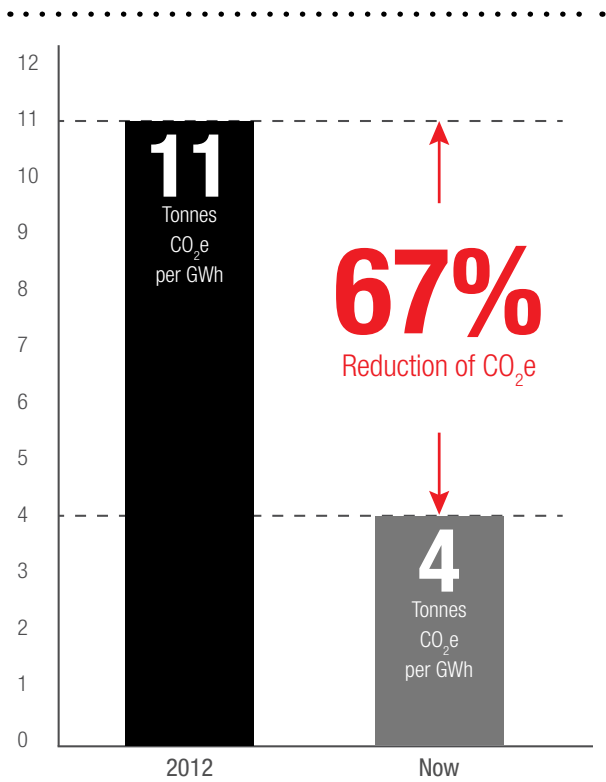

Figure 2-2 | LCA analysis of two different generations of HVDC system, using a standard silicon IGBT, and an advanced silicon IGBT concept

example, it was calculated that energy losses generate more than 95% CO₂ equivalent emissions during the HVDC lifetime, and even different generations of VSC-HVDC systems with different power semiconductor devices can be reliably compared in terms of total carbon footprint per GWh as in Figure 2-2 [17].

The HVDC market has grown consistently at a CAGR of about 11%, reaching 200 GW cumulative installed capacity by 2020 [18]. Driven by grid integration of VRE and grid stabilization applications, the market for HVDC systems could reach more than 50 GW of annual installed capacity by 2030. It is also expected that more than 35 GW of new VSC-HVDC capacity will have been installed between 2020 and 2028 [19].

HVDC systems are designed for an operating time of at least 20 years. Thus, dedicated protection concepts that limit the effect of power semiconductor device failures to individual components, while avoiding end of life failures, were required to enable the implementation of VSC inverters with specially designed silicon IGBT modules or with IGBT modules as used in industrial medium voltage drives (MVD) and traction converters. However, due to long operating lifetimes, it is expected that silicon thyristors and IGBTs will remain the dominant power semiconductor devices in HVDC applications in the medium term (5-10 years). Furthermore, recent innovations in these power semiconductor devices combining IGBT and free-wheeling diode (FWD) functionality into the same semiconductor die, have enabled a significant step in the performance of VSC-HVDC systems, which are expected to account for the bulk of worldwide HVDC installations by 2030.

2.1.3 Photovoltaic generation

Photovoltaic (PV) generation is a clean, safe and sustainable power generation method and thus holds the potential for becoming one of the main pillars of energy generation in an energy-wise society. It has been estimated that an earth surface of 500 000 to 1 000 000 km² fully covered by PV cells (under ideal illumination conditions) would secure the entire global energy consumption in 2030 (for comparison, this surface would equal the area of a medium-sized country). The global energy crisis is driving an accelerated growth of solar PV capacity, and the IEA estimates that more than 4 200 GW of cumulative PV capacity must be added under the Net Zero Emissions by 2030 Scenario, thus surpassing generation from coal, natural gas and hydropower sources. In 2022, about 268 GW of PV installed capacity was reported, up from 150 GW in 2021 [20] [21].

The DC generated by a solar PV panel requires a PV inverter for transformation to sinusoidal AC at a specific frequency in order to drive an AC load or to connect to the power grid. Alternatively, it would be possible to use the DC current to charge a battery system for energy storage. Power semiconductors constitute the key components of a PV inverter, and their performance plays an important role in power conversion efficiency and in ensuring the overall reliability of a PV inverter. In the inverter circuit, the DC to AC conversion is realized by commanding each power semiconductor to turn on and off in a specific sequence.

In order to achieve higher energy efficiency in a cost-sensitive application, PV inverters with two- or three-level inverter stages, with or without employment of an additional frontend boost converter, became the industry standard in residential, commercial roof top and large PV plant installations, with power ratings ranging from several kilowatts (kW) to several megawatts (MW). Silicon IGBTs are used in many PV inverter designs. To fulfil the requirements for grid-code harmonics, a sine filter must be placed between the PV inverter and the grid. Wide bandgap semiconductors, such as silicon carbide metal-oxide-semiconductor field-effect transistors (SiC MOSFET), allow the switching frequencies to be further increased compared with silicon IGBTs, which results in smaller filter sizes while providing even higher efficiencies.

PV inverters achieve up to 99% peak energy efficiency and provide a high reliability and lifetime of 20 years, when the relevant physics of failures and mission profiles are considered in the inverter design. Developments are underway towards increasing the operating voltages for very large PV installations to above 1 500 V, in order to reduce electrical current levels and thus the size and cost of electrical cables. In this case, power semiconductors with increased blocking voltage ratings of 2 000 V or higher might be beneficial.

A proper framework of standards on power semiconductors must ensure that the high levels of lifetime and reliability can be maintained in spite of increased power density and cost pressure trends. Presently, to achieve this high level of reliability, tests additional to those in existing standards need to be developed and performed individually by power semiconductor device and PV inverter manufacturers, thus increasing the development costs and the time to market.

2.1.4 Wind generation

On and off-shore wind turbines represent one of the most promising categories of VRE generators as envisioned by an energy-wise society. Power electronics are essential for grid connection of all state-of-the-art variable speed wind turbines. Reliable, durable and cost-effective power semiconductors are therefore the key to a reliable and cost-effective wind electricity generation.

According to the IEA NZE the annual wind generation capacity additions will need to be increased from approximately 75 GW in 2022 to 350 GW in 2030 at a significant CAGR of almost 20% [22].

The wind turbine technologies can be based either on doubly fed induction generators (DFIG) with a back-to-back converter at the rotor of the generator machine or can be directly driven with any kind of three-phase AC generator machine and a back-to-back converter connected to the stator of the generator. In DFIG turbines usually just a portion of the output power of the generator is handled by the wind converter. In directly driven turbines a fully rated wind converter is needed to handle all the output power of the generator, and thus energy efficiency becomes a key performance parameter.

Lower voltage IGBT-based solutions are used in today's multi-megawatt wind converters, which in most cases involve low voltage two-level voltage source topologies with an AC output voltage between 400 V and 1 000 V. With modular or

multi-level power electronics solutions, this voltage level can be further increased to reduce the current requirements. For very high current and high voltage/low frequency wind converters with ratings of above 12 MW, silicon integrated gate commutated thyristor (IGCT) devices are considered as alternative power semiconductors.

The power rating output voltages of newer generations of wind turbines are continuously being increased to surpass 15 MW. In such converters, the high power combined with relatively low voltage levels leads to large electrical currents and thereby large conductor cross sections and thermal problems within the converter. To achieve even higher power density, power semiconductors with increased blocking voltage or modular power electronic solutions are needed. Using the limits of the standards for low voltage inverters is attractive. 1 000 V AC is an attractive voltage class, leading to 1 500 V nominal and up to 1 800 V maximum DC voltage. Power semiconductors for this voltage level are rare, as the blocking voltage should be in the range of 2 300 V to 2 500 V. To increase the power density of the generator side inverters, the temperature ripple due to low fundamental frequency or the sensitivity to temperature swings must be reduced. Different promising technologies exist for reaching this goal. Reverse conducting silicon IGBTs use the same semiconductor chip in the IGBT- and the diode-modes, which leads to a significantly better transient thermal impedance and thereby to a significant reduction of the temperature ripple. Special double-sided cooled modules with silicon IGBTs offer a high thermal capacitance with a good thermal coupling to the semiconductor chips and a high robustness, if the semiconductor chips are sintered.

To fulfil the grid code requirements for harmonics, a filter must be placed between the wind converter and the low frequency transformer required for grid connection. This filter is the heaviest component of a wind converter. To reduce the size of this filter, the switching frequency of the power

semiconductors in the wind converter must be increased or multilevel circuit topologies must be utilized. This would represent a motivation for using SiC MOSFETs in such applications in the long term. If sustainability and life cycle aspects would be more consistently considered at the converter design stage, it is estimated that WBG power semiconductors could provide an overall lower CO₂ footprint (e.g. reduced filter size means also that less materials are required for manufacturing). The transportation of a smaller wind converter and filter system would also generate less CO₂ under current means of transportation.

Wind turbines are designed for an operating lifetime of at least 20 years, i.e. end of life failures should not occur before 20 years. Spare parts have to be available 20 years after commissioning the last turbine of a series – which might be 25 to 30 years after converter development. Recent improvements in power module assembly and interconnection technology (joining technologies such as sintering and copper bond wires) address the challenge of power cycling present in DFIG turbines and directly driven full converter designs and contribute to increased operating lifetimes. Because such applications traditionally have longer design cycles and operating lifetime requirements, newer power semiconductor technologies could have a reduced commercial impact in the medium term (next 5-10 years) compared to the more established technologies.

2.1.5 Green hydrogen generation

Green hydrogen could play a key role in the green energy chain, and according to the IEA NZE, the equivalent of more than 550 GW of electrolyzers would have to be installed by 2030, up from the 1 GW installed base at the end of 2022 [23]. Due to the amount of power and energy required in marine and off-highway applications, hydrogen is seen as an alternative to classical batteries in these sectors. In addition, green hydrogen has the potential to help with the intermittent nature of solar

and wind generators, while replacing natural gas in industrial chemical processes (decarbonizing heavy industries such as steel and fertilizers). The large-scale electrolyzers will need to be integrated into the power grids in the multi-GW range via power converters. In addition, they would have to be powered entirely by VRE and, contrary to classical electrolyzers, would need to be able to adapt to the variability in available energy. Furthermore, the efficiency of green H₂ electrolyzers is still low, and traditionally they have been built in small volumes for niche markets leading to high prices.

Power quality, efficiency, cost and reliability are several of the electrolyser system's critical performance metrics, which can be significantly affected by the selection of power semiconductors and of the circuit topology of power electronic converters. Thyristor-based AC/DC converters have been dominating solutions in high-power applications due to their high robustness, high efficiency, and low cost. A commercial thyristor-based converter can supply 1,5-10 kA DC current with a DC voltage of 1 000 V, delivering a maximum of 10 MW power per unit. Hybrid solutions also exist combining an AC/DC converter with thyristor and an DC/DC converter based on silicon IGBTs in order to address the expectation that electrolyzers connected to renewable energy sources will run 45% of the time at only 12,5% of the full load [24].

Energy efficiency improvements in the converter (from >94% to >98%) will continue to be key for reducing the cost of systems by using high current densities, achieving higher energy efficiency across the entire range of operating conditions, and minimising voltage degradation over time. This would also lead to a significant reduction in size and cost savings of the converter's cooling system. Current distortion and fundamental power factor are other critical parameters, requiring the use of additional equipment, more complex circuit topologies or even a change to an active front end (AFE) rectifier with silicon IGBTs or SiC MOSFETs [25].

2.1.6 Solid state transformers and solid-state circuit breakers

Implementing the vision of an energy-wise society will require massive development of electrical generation, transmission and distribution infrastructures. Such developments are driven by the increased share of VREs in the total electricity generation capacity and by increased demand for electricity in buildings and industries, due to economic growth and the phasing-out of fossil fuels. With this development comes an increased demand for reliable and secure electrical distribution systems, and DC power grids (i.e. DC distribution networks) could help address such challenges and reduce the needed investments. The market for DC power grids is conservatively projected to grow to more than 5 680 MW installed by 2030, with a CAGR of 14% between 2021 and 2030. Corresponding spending is expected to reach almost USD 24 billion annually by the end of this decade [26]. Power semiconductors and power electronics constitute key technologies enabling the realization of DC power grids.

For example, local/on-site low-voltage DC (LVDC) power grids are considered a promising approach for efficient on-site power distribution, and for integration of energy storage (for providing certain auxiliary and/or peak load buffering), fuel cells or renewable energy such as solar photovoltaics. Due to the power levels required (ranging from hundreds of kilowatts to several megawatts), these on-site LVDC grids require interfaces to medium-voltage (MV) power distribution grids, i.e. to AC or DC collector grids of PV large power plants or to medium voltage alternating current (MVAC) distribution systems. In the mid- to long-term, solid-state transformer (SST) concepts, involving power electronics connected to the MV grid using a compact, high-frequency (HF) isolation/transformer, could be better suited in such applications compared to traditional power transformers operating at low frequency/line frequency. The emphasis in such SSTs is on the development of MV-side power electronics

and on the advanced protection thereof. The key challenges affecting SST revolve around the topics of protection, robustness and cost benefits (capital expenditures (CapEx) and operational expenditures (OpEx)), especially at increasing power and voltage levels. Competing with low frequency transformers becomes challenging at power levels in the megawatt range and above, as traditional transformers scale in cost, weight, size and losses differently than SSTs, which are modular systems. However, the introduction of SSTs is not to be regarded as a one-by-one replacement of the conventional transformer, involving the limited additional functionality of stepping up/down the voltage between the primary and secondary sides. Instead, SSTs will allow high penetration of VRE, integration of energy storage in the electric distribution grid, and electrification of transport and heating [27] [28].

Another area of application in which power semiconductors are gradually being applied on a commercial scale involves solid-state circuit breakers (SSCB) [29]. The first SSCB products using silicon IGBTs and certified according to the IEC 60947-2 standard were introduced to the market recently. Electromechanical circuit breakers have been used traditionally to protect electrical installations and ensure their safety in fault conditions (for example during short circuits). A faulty part of an electrical distribution system can be disconnected while keeping the rest of the grid active. Complete electrical distribution system shutdowns can be avoided, thus maximizing uptime, and minimizing revenue losses. The electromechanical breakers rely on current interruption during the zero-crossing phase of the AC waveform. Electromechanical breakers can also protect DC grids (e.g. large PV plant installations, batteries in EVs, and energy storage systems in power grids, etc.) albeit at the cost of increased internal complexity.

SSCBs could constitute an enabling technology for the growth of DC power grids because they offer ultrafast protection capability and potentially

fault-selectivity. In a SSCB, the moving contacts of traditional electromechanical circuit breakers are replaced with controllable power semiconductors. By using power semiconductors, the flow of electrical current can be better controlled and interrupted under fault conditions. Because they contain no moving parts, SSCBs are much faster than electromechanical circuit breakers which take longer than milliseconds to react to a fault in the electrical distribution system (from the moment the fault condition has been detected). A simpler electromechanical part may still be used in order to ensure galvanic isolation, in conformity with most electrical codes. In addition, a SSCB interrupts the current without generating an electrical arc and, in theory, could have lower maintenance costs compared to electromechanical breakers, although an insufficient amount of field data exists to confirm such a beneficial trend.

Both silicon-based and silicon carbide-based power semiconductors can play a determining role in SSCBs, as the voltage and current ratings of SSCBs are continuously being expanded to match the requirements of both low power (i.e. battery protection in battery management systems (BMS)) as well as high power applications (i.e. HVDC grids). Newer concepts have been proposed using both technologies simultaneously in a cost-effective hybrid configuration. Such a configuration allows achieving the lowest conduction losses under nominal operating currents, while maintaining the highest resilience and reliability under high fault currents. Decreasing the conduction losses of SSCBs by using improved power semiconductors would enable further energy savings over the lifetime of the applications and would also result in lower costs and reduction of the footprint, as the additional cooling system would be smaller. Moreover, new power semiconductor module standards might be required in connection with SSCBs, because the majority of power modules have been specified and designed in connection with converter applications.

2.1.7 Mobility infrastructures

Three standard charging levels are used to charge electric vehicles. All EVs can be charged with either Level 1 or Level 2 chargers working with AC current/voltage. Such chargers can be found at homes or public locations and can charge an EV for a range of 200 km in about 5-20 hours. Level 3 chargers working with DC current/voltage – also called direct current fast chargers (DCFC) or fast charging stations (when multiple units are installed) – can charge an EV for a range of 200 km in less than 30 minutes. A typical Level 2 home charger or a DCFC operates within a range of approximately 83-96% of peak energy efficiency, when considering the conversion losses from grid to battery. Commercial DCFCs rated 300-350 kW already support battery charging voltages between 150 V and 1 000 V and currents of up to 1 000 A across DC outputs. Various stakeholders employ set charging power above 1 MW in order to maintain reasonable charging times (“ultra-fast” chargers) [30] [31]. The chargers function most of the time in standby mode with no vehicle connected (approximately 85% of the time), so a requirement exists to use less energy in standby mode.

In order to support the rollout of EVs at the significant scale required for an energy-wise society, public charging infrastructures must be deployed at an accelerated pace. It is estimated that 16,9 million charging stations would have to be installed worldwide by 2030 [32], up from an installed base of 2,7 million units in 2022 [33]. Most DCFCs are expected to be installed along highways to offer fast battery charging for long-distance drives. Multiple DCFCs installed in the same location constitute a fast-charging station, which can have a total power capacity of several MW. For such installations, the direct connection to the medium-voltage (MV) grid is preferred to avoid overloading of the low-voltage (LV) grid, while each DCFC is connected to an internal LV distribution network. Several approaches were proposed

for direct connection to the MV grid using a low frequency transformer, while the LV distribution network inside the station can be either AC or DC as shown in Figure 2-3 [34]. The AC distribution network is mature and, having been adopted by most state-of-the-art installations, will remain in the near future the mainstream solution. Nevertheless, the DC network configuration may prove more advantageous, having fewer conversion stages and simpler integration of chargers. Considering the larger batteries involved and the higher power charging intended for larger heavy-duty vehicles, the charging infrastructure represents a larger stress to the power grid. For these reasons, such charging stations will most likely include on-site energy storage elements and generation in order to reduce the power usage peaks and also perform other ancillary grid services [35] [36]. However, connecting power electronics to the MV grid also introduces a number of issues in terms of safety and protection that need careful mitigation [37].

An alternative development in this market involves high-power wireless power transfer systems that use a ground primary coil and a vehicle secondary coil to convert the alternating current from the grid into a magnetic field that transfers power over the air gap between the two coils. This power transfer is effected under high frequency magnetic resonance conditions (around 85 kHz) with specially designed low-loss resonators. By featuring a contactless power transfer, wireless chargers are in principle safer with respect to potential electric shock risks compared to cable-based solutions and may even allow dynamic charging while the vehicle is moving. However, this technology needs further improvements in terms of charging power ratings (currently limited to about 50 kW per pair of coils for a passenger EV) and energy efficiency (for typical commercial systems around 90-92% source to vehicle battery) to compete with well-established cable based DCFC, especially at MW power levels [38].

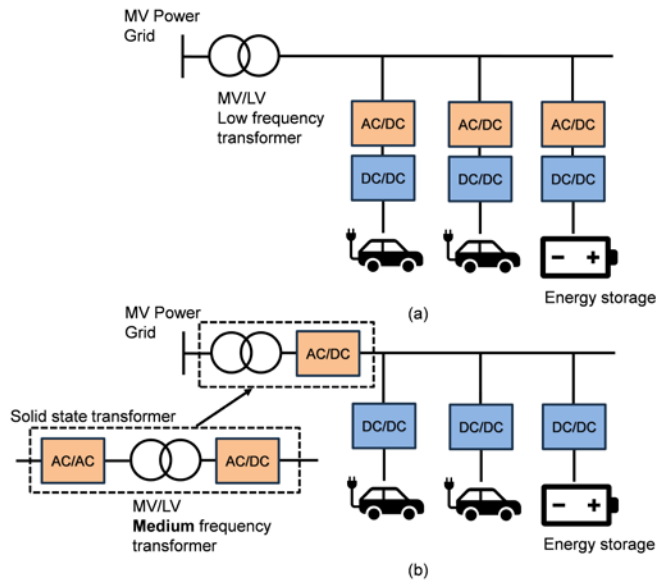

Figure 2-3 | Typical configurations for DC charging stations –
(a) Fast charging station with low frequency transformer and AC distribution network
(b) SST-enabled fast charging station with DC distribution network





SiC power semiconductors are expected to play a key role in vehicle charger applications, leading to better energy efficiency, higher operating frequency and high-power density. Taking as a reference a DCFC system rated at 22 kW, the AC/DC stage is implemented as an active front end (AFE) circuit topology, with six silicon IGBTs switching at 20 kHz, and can achieve a peak energy efficiency of 97,2% and a power density of about 3,5 kW/L. If SiC MOSFETs are used to replace the silicon IGBTs, the switching frequency can be increased to 45 kHz, the peak energy efficiency to 98,5% and the power density to >4,6 kW/L. The magnetic components in the DCFC can be made smaller, and it is possible to have bi-directional power flow capability (i.e. from the EV to the grid and from the grid to the EV). The impact of SiC MOSFETs is even more pronounced in the DC/DC stage, also rated at 22 kW, where the circuit topology is based on resonant switching. Silicon-based power semiconductors operate in this case at around 100 kHz and can achieve a peak energy efficiency of 97,5% and a power density of

3,5 kW/L. By using SiC MOSFETs, the switching frequency can be increased to 250 kHz, the peak energy efficiency to 98,5% and the power density at 8 kW/L [39].

2.1.8 Energy storage for grid stabilization

Energy storage systems (ESS) deliver a wide range of services that cover all segments of the energy value stream, ranging from conventional and renewable generation, transmission and distribution up to the final customer. Table 2-1 shows a classification of the main envisioned applications for grid scale battery energy storage. Power electronics is the key technology in ESS for providing power flow control, conditioning, and acting as the interface for increasingly intelligent and complex energy and transport systems. The initial scope of grid-connected ESSs was to address the challenge of intermittency of VRE, balance supply and demand issues, and effectively take surplus energy for later use. Today, the power

Table 2-1 | Envisioned power grid applications of ESS in an energy-wise society

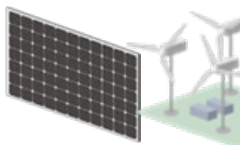
				
<p>Conventional/ Bulk generation</p> <p>Arbitrage</p> <p>Peak shaving</p> <p>Load levelling</p> <p>Generator bridging</p> <p>Generator ramping and load following</p> <p>Black-start</p>	<p>Transmission</p> <p>Frequency control</p> <p>Angular stability</p> <p>Voltage support</p> <p>Investment deferral</p>	<p>Distribution</p> <p>Capacity support and investment deferral</p> <p>Contingency grid</p> <p>Voltage control</p> <p>Reactive power compensation</p>	<p>Customer-side</p> <p>End-user peak shaving</p> <p>Energy cost management</p> <p>Power quality</p> <p>Energy back-up</p> <p>Reactive power compensation</p>	<p>Renewable generation</p> <p>Curtailment minimization</p> <p>Capacity firming</p> <p>Ancillary services support</p>

electronics community is called upon to help address several challenges related to ESS such as: 1) increasingly stringent grid requirements; 2) the need to integrate high-power semiconductor devices; 3) the drive for lower-cost energy with high efficiency and reliability. In the IEA NZE, a cumulative 970 GW of battery energy storage would have to be installed by 2030, up from an installed capacity of 28 GW at the end of 2022 [40].

In the power grid of an energy-wise society that relies on VRE, the ESS serves through converter interfaces at the transmission level, at the distribution level and at the customer/end-user side in large-scale (GW-levels, voltages between 69 kV to 765 kV), medium-scale (MW-levels, voltages between 4 kV to 46 kV) or micro-scale (kW-levels, voltages <1 000 V). A general architecture connecting the energy storage units to grids includes buck/boost DC/DC converters, DC/AC inverters, filters and transformers. For direct connection to the medium-voltage AC grid, there also are transformer-less solutions in two topologies: an arrangement based on the

series connection of semiconductors such as silicon IGBTs and the other based on the series connection of submodules, using cascaded modular converters. For low- and medium-power applications, the traditional voltage source converter with two-level pulse width modulated (2L-PWM-VSC) requiring six pulse bridge-controlled silicon IGBTs is the most widely used circuit topology so far. For medium- to high-voltage power systems, multilevel converters with diode-clamped (neutral-point-clamped (NPC)), capacitor-clamped (flying capacitors), cascaded multicell (CMC) with separate DC sources, and modular multilevel converters (MMC or M2C) are alternative circuit topologies.

The application of WBG power semiconductors in ESS can help to increase power density and reduce energy losses that need to be removed through cooling. Higher switching frequencies result in more compact solutions that are lighter, easier to install, and occupy less space. In ESS, power converters typically operate under a wide range of conditions with the most common being

around 25% of full load rating [41]. Under such conditions, WBG semiconductors such as SiC offer lower conduction and switching energy losses over traditional silicon-based devices. They also support significantly higher switching frequencies. The transition from silicon IGBTs and silicon MOSFETs to WBG solutions has shown that around 5 kHz switching frequency, the energy efficiency can be improved by approximately 1%, the volume of thermal management can be reduced, and energy losses can be lowered by up to 70% [42]. Silicon IGBTs require larger thermal management systems, leading to increased system size and weight. Similar to SiC MOSFETs, GaN high electron mobility transistors (HEMTs) also offer several benefits over their silicon-based counterparts, including significantly lower output charge and on-resistance, resulting in greatly reduced losses during switching.

Higher voltage applications like grid connected stationary systems would require power semiconductors with blocking voltage >3 300 V. Higher dynamic temperature variations are expected during operation, and careful consideration must be given to thermal cycling and to changes in power semiconductor parameters with temperature. It is important to determine the appropriate failure threshold parameter settings to maintain the reliability and safety of the ESS.

Standard requirements related to frequency and voltage support have been proposed to support grid-integrated ESS during transient and contingency events. For example, the converter needs to consume a certain amount of reactive power to help lower the voltage range at the grid connection point [43]. Different standards define frequency droop characteristics at different levels [44]. When the frequency returns to the rated range, the inverter should maintain its maximum power output for a given period of time before returning to charging mode to reduce the risk of unstable operation. During the recovery time, the ESS inverter needs to follow the power ramp rate specified in the corresponding standard (16% of

the rated power per minute, as stipulated by the local regulations). These standard specifications for ESS define important application specific requirements that have a direct impact on the power semiconductor devices used in ESS. Therefore, they should find their way into new standards for power semiconductor devices in the form of relevant test methods or reliability procedures.

2.2 Electrification application – User sector introduction

Applications in the user sector are expanding at a faster rate than ever before, driven by regulations aiming at 2030 and 2050, and by public interest. The key concepts of electrification in a broad sense target zero CO₂ emission across the entire value chain, increased energy savings, comfortable living and working environments, and/or flexible and reliable systems for transportation. The electric power required for the user sector should be generated from VRE sources including PV panels, wind turbines, hydro and geothermal/wave/tide generators.

Transitioning the user sector towards an energy-wise society requires a strong interdisciplinary approach. Electrical engineering fields including power electronics and power semiconductors, electrical motors and power systems must involve closer aspects of mechanical engineering, control engineering, civil engineering, and the latest information and communications technologies. For example, as the number of inverterized applications will continue to increase in factory automation and home appliances, the impact of the power electronics on voltage regulation and stability, as well as harmonic and electromagnetic interference (EMI) issues, will have to be better understood and managed. At the same time, advanced thermal and heat-transfer engineering combined with power semiconductor devices offering lower losses could boost the uptake of power electronic applications in electrified mobility.

2.2.1 Electrified mobility

Today the major share of transportation of persons as well as of materials is performed using combustion engines powered by fossil fuels. Although technically possible, the replacement of fossil fuels by e-fuels manufactured using renewable energy will be commercially attractive only in some specific instances such as intercontinental transportation by aircraft or ship or heavy-duty trucks on long-haul routes. For all other areas of mobility, electrification will be the more efficient and more economical choice. It should be considered that electrification may go beyond converting the established internal combustion engine to EVs, to instead modifying the very way persons and materials are transported. Electrification is more easily implemented in larger units than in individual transport, and track-based systems can be electrified more easily than road vehicles. Electrification may also include a partial shift from individual transport in passenger cars/trucks and from short and medium distance flights to public transportation by electrified solutions such as railway and bus networks.

2.2.2 Automotive

Various vehicle manufacturers are targeting to reduce CO₂ emissions over the entire vehicle life cycle up to 2030 by more than 50% [45] [46]. The IEA NZE would require an electric vehicle fleet of over 250 million units in 2030 and EVs accounting for 67% of new car sales up from 14% in 2022 [32]. Assuming clean electricity is used for charging, a major part of CO₂ emissions will then be created during the production of the vehicle. From a life cycle perspective, the battery production is associated with more than 40% of the CO₂ emissions during vehicle production compared to less than few percentages for all electronics components [47] [48].

Power electronics is an enabling technology for the advancement of environmentally friendly and fuel-efficient vehicles such as battery electric (BEV),

hybrid electric (HEV), and fuel cell (FCV) vehicles. For EVs, the use of power semiconductors is mainly reflected in the on-board charger (OBC) system, battery management system (BMS), high-voltage load, high-voltage to low-voltage DC-DC converter, main drive inverter, etc. The cost of the power semiconductor content per vehicle is currently higher than USD 330, an order of magnitude comparatively larger than that of an internal combustion engine vehicle, and this will further increase for more complex vehicle architectures and higher kW ratings per vehicle with higher WBG semiconductor content [49].

Power semiconductors constitute the key components for reaching high energy efficiency, or for extending the range of EVs. The superior performance of SiC power semiconductors can improve efficiency and power density, which are particularly important for automotive applications. The high maximum operating junction temperature capability of the SiC power semiconductors reduces the cooling requirements for OBC and DC/DC converters to air cooling from liquid cooling. The high control bandwidth of SiC power semiconductors can enhance the stability and power quality and reduce the design margin and filter needed in the system, which can directly translate into weight reduction in BEVs [50].

On average, the range of EVs has increased by 12% annually in recent years driven mainly by improved battery technology. 1 200 V SiC MOSFET power modules are used for main drive inverters with very high output power in BEVs with long range, fast charging capability and high battery voltages. In order to understand the benefits of a SiC MOSFET, the concept of a “mission profile” must be introduced. During most of its operating time, the BEV’s main drive inverter must handle electrical currents below 30% of its maximum ratings. This is the case for example when the BEV is cruising on a highway, which is referred to as “partial load” operation. When the BEV accelerates, the electrical current through the BEV’s main drive

inverter increases and approaches the maximum ratings. This is referred to as “full load” operation. Under partial load operation, SiC MOSFET-based inverters offer higher energy efficiency (i.e. lower electrical losses) than their silicon IGBT counterparts [51]. This is clearly illustrated in Figure 2-4, where the energy efficiency of a SiC MOSFET-based main drive inverter (blue line) is larger than the energy efficiency of a silicon IGBT-based inverter (red line), in particular under partial load conditions [52] [53]. Consequently, the range of the vehicle can be improved by more than 5% compared to using silicon devices [54], or the size of the batteries can be reduced to maintain the same vehicle range while reducing CO₂ emissions during the production of the vehicle. Therefore, automotive applications are expected to use 79% of the worldwide SiC power semiconductors capacity by 2027 [12], and the overall SiC market size will depend on the SiC implementation in the main drive inverters of the market-leading vehicle manufacturers.

To reduce to less than 20 minutes the time required for charging large batteries from 10% to 80% of their state of charge (SOC), it is expected

that battery voltages will be increased from currently used values of 800~850 V to 1 000 V DC. The reason for this is that higher-voltage inverters enable higher power capability while maintaining the same current levels. This results in copper conductors and other components being smaller, lighter and less expensive. SiC is already established in main drive inverters for long range electric vehicles and in the boost converter for a fuel cell electric vehicle (FCEV). Due to the trend of increased battery voltage, 1 200 V SiC MOSFETs are being considered for use in OBCs and DC/DC converters for EVs approximately by 2025 and also for HEVs and plug-in HEVs. GaN HEMT devices are currently available for low voltage applications, e.g. light detection and ranging (LIDAR), and GaN HEMT high voltage devices are expected to be introduced for DC/DC converters and OBC later. For main inverter applications, more complex multilevel topologies would be needed and are being evaluated.

To further increase the power density in automotive applications, it is also necessary to advance the development of integrated power electronics. Because of the benefits of WBG

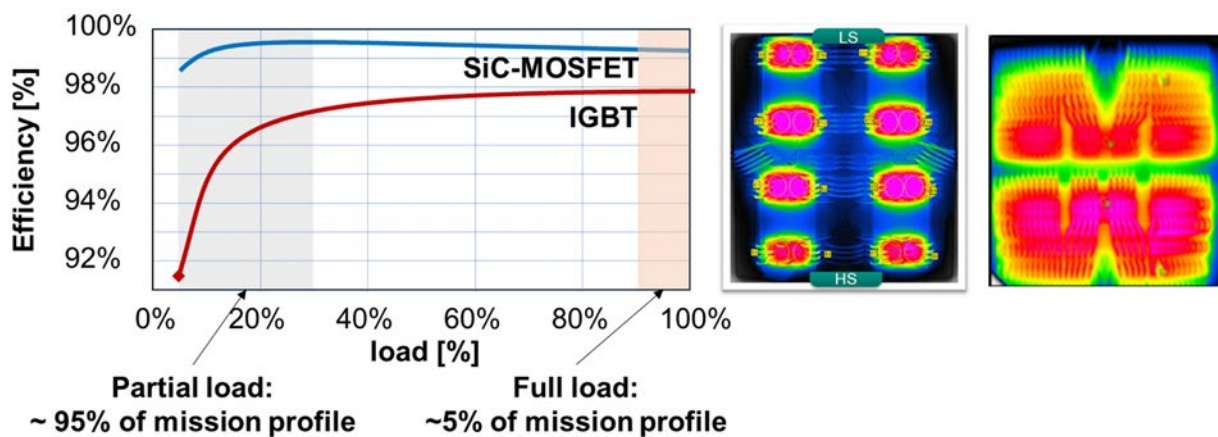

Figure 2-4 | Energy efficiency of SiC-MOSFET vs Silicon IGBT based main drive inverters as a function of the electrical current through the inverter (“load”)

NOTE: Only the energy losses in the semiconductors are considered.

power semiconductors, such as high temperature operating capability, high switching frequency and current density, such semiconductors are best suited for integrated applications.

In addition to the area of passenger cars, which represents the largest volume in units, applications in commercial and off-road heavy-duty vehicles, used for example in agriculture, mining and construction, have also to be considered. Contrary to passenger cars, in such automotive applications different requirements need to be considered, such as wider range of power ratings, longer lifetime requirements and in some instances more severe environments.

New functions, (e.g. bidirectional charging), will result in extended hours of operation of power electronics and therefore increased requirements concerning quality reliability and qualification efforts. In order to serve the elevated needs for quality and reliability, improved qualification guidelines were developed (e.g. JEDEC, AQC 324) with new failure mechanisms for WBG devices. The dynamic growth and development of technology on the one hand and standardization on the other hand require a continuous alignment over the entire supply chain and the involved organizations. Adapted guidelines are needed to support a sustainable growth of the market to enable the targeted CO₂ savings. For heavy-duty vehicles, guidelines and standards from industrial and railway traction applications might also be relevant.

2.2.3 Railway

Railway rolling stock with its traction and auxiliary power supply systems is a strong and steadily growing power semiconductor market. An energy-wise society is expected to boost an ever-larger share of transportation from individual to mass transit, and the same is expected for freight transportation, where rail competes with the road. Furthermore, climate change is fostering

the introduction of batteries or hydrogen as an alternative source for diesel powered vehicles. More customers are placing a higher weighting on energy consumption and demand products with minimized costs over the entire life cycle. The introduction of alternative energy sources will increase the pressure on energy efficiency.

Rolling stock is currently seeing the transition from Si-IGBT to SiC technology, driven by energy efficiency requirements and size/weight constraints. The transition speed can be expected to increase with the current energy situation. An acceleration can also be expected with new power converter concepts (e.g. the direct connection to the overhead line voltage), fast chargers or DC-DC converters for battery supplied trains.

As a standard, all rail vehicles use an inverter (INV) for the main traction drive and if applicable an active rectifier on the line side. In addition, power electronic function also has to cover braking (BC), sometimes buck/boost functions (DC-Inv) to adjust to different line voltages and generation of auxiliary voltages (AUX) for internal supply and customer comfort (see Figure 2-5). This results in a large spectrum of semiconductor voltage classes from 1 200 V to 6 500 V and a power range from a few 10 kW to multiple MW (see Figure 2-6). Common requirements in traction applications include wide temperature operating range, high load and power cycling requirements combined with expected high reliability and a lifetime of more than 30 years. This must be fulfilled through restrictions on space and weight, delivering at the same time best-in-class energy efficiency.

While for the main inverter and active rectifier, the standard two-level circuit topology is predominant, several other structures can be found in other converters. Converters for auxiliary power supply use resonant-switching and multi-level circuit topologies. With the high requirements on voltage quality, passive filters are also required. In addition, multiple DC-DC circuit topologies are used, with hard-switching and interleaved-switching. All

converter systems operate for a large proportion of time under partial load. The weighed efficiency together with the efficiency in recuperation determines the overall energy consumption.

Since the start of this century the workhorse in traction has been the silicon-based IGBT power converter, with a wide range of used voltage classes and current capability. Recent

years have seen the gradual introduction of SiC-based semiconductors. Few solutions use hybrid technology (silicon IGBT together with SiC Schottky barrier diodes (SiC-SBD)). The majority use the SiC based MOSFET. Applications can be found in the main inverter with 3 300 V as well as for light rail at 1 700 V or auxiliary systems with 1 200 V SiC-MOSFET.

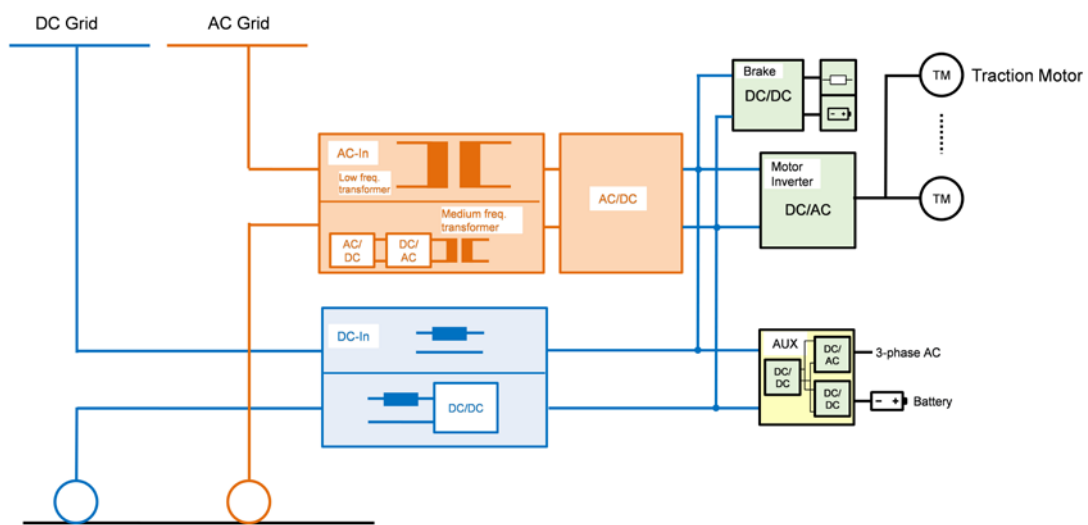

Figure 2-5 | Generic architecture of the traction and auxiliary power supply system

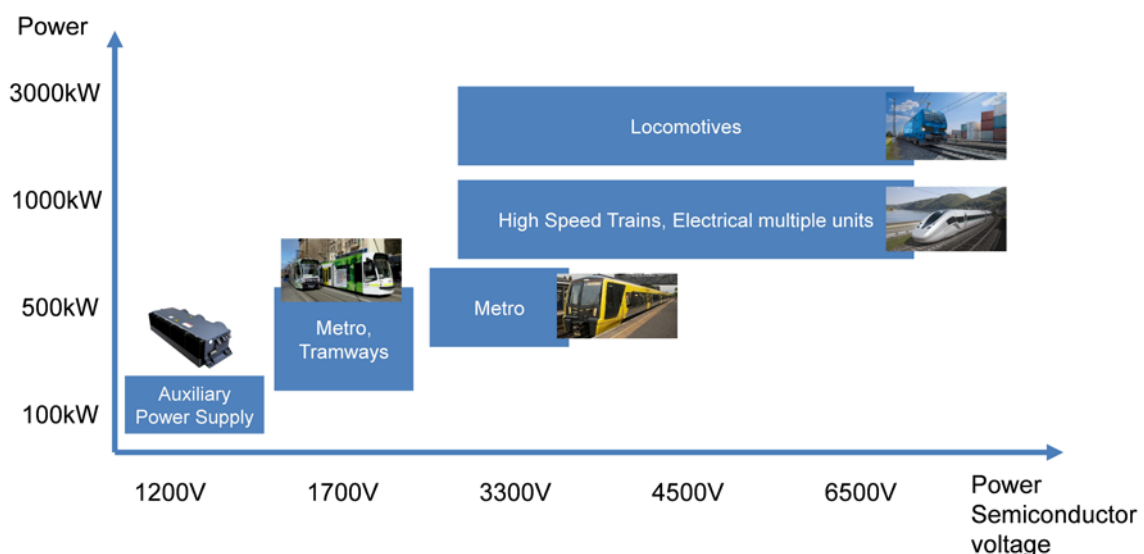

Figure 2-6 | Typical railway stock applications and required power semiconductor voltages

The transition to SiC is expected to accelerate in the near future (<5 years), though of course traction with very long project lifetimes is always overall a slow candidate for transitioning to new technologies. The medium future (5-10 years) will see more semiconductors with high switching frequencies, as converters for battery powered trains gain in market share. In this period the introduction of converters directly operated at the catenary voltage of 15 kV or 25 kV is also expected, as this is one of the key elements for increased energy efficiency under condition of less weight. The other always-present driving force will be cost optimization, with an increasing significance of life cycle cost, which is mainly driven by energy consumption. This will therefore necessitate power semiconductor technology with less volume and high load cycle capability, reliability and good performance at partial load.

Expected technology trends with respect to power semiconductors in railways include:

- Improvement by power semiconductors (chip technology)

Improved semiconductor switching and conduction losses will foster the transition to new generations of semiconductors and be essential to reaching overall energy efficiency goals. Chip technologies with higher blocking voltage (for SiC >3 300 V) are expected to facilitate the full transition. Higher blocking voltages are also needed to deliver cost-effective solutions to replace the main line frequency transformer by a power electronics-based solution.

- Improvement by power semiconductors (module technology)

Today's semiconductor performance in traction is still limited by the load and power cycling capability of the packaging technology. New technologies also forced by automotive applications are expected to

improve performance and lead to a better cost situation, especially for SiC-based semiconductors, where chip area is a large cost factor. Railways are often confronted with high humidity conditions: more reliable packaging solutions are expected.

- Extended application of power semiconductors in new solution-fields in railways

Innovative solutions in the form of motor integrated inverters for self-operating bogies require a significant increase in power density. Omission of traditional bulky filter concepts requires significantly higher switching frequencies in active filtered solutions.

- Technology base for the power semiconductor

With the introduction of new materials, the base material plays a larger role regarding reliability and high performance of the semiconductors than with silicon. Improving this base will foster the introduction of more energy-efficient solutions.

2.2.4 Electrified aircraft

Aviation is a significant contributor to GHG emissions in the transportation sector. To reduce pollution and maintenance, and ensure cheaper and more convenient flights, industry and academia have directed their efforts toward aircraft electrification. Aircraft electrification can start from simple subsystem electrification to thrust generation, and several categories have been proposed [55]:

- More-electric aircraft (MEA): propulsion is generated by a conventional jet engine, however, all secondary systems (hydraulic, pneumatic and actuation) are electrified [56].
- Hybrid electric aircraft (HEA): electric motors can provide propulsion with the electric power supplied by the conventional engine.

- All-electric aircraft (AEA): electric motors can provide propulsion with the electric power supplied by energy storage and there is no combustion engine onboard. This enables zero CO₂ emissions during flight, and permits a safer, more reliable and more comfortable flight (reducing both acoustic noise and mechanical vibration).

The envisioned power/voltage levels for different aircraft classes span from 100 kW/115 V DC for an all-electric air taxi, to >3 MW and 3 to 5 kV for HEA concepts, as shown in Figure 2-7 [57]. In the short term, air taxis and developments in general aviation can lead to the emergence of AEA. Power semiconductors, power electronics and electrical machines will play a key role in this scenario in which electric power must be efficiently generated, distributed, and consumed to satisfy extremely high requirements of aviation safety. One of the key development trends is the increase in the power processing capability with the same weight/volume at the power electronics stage. Of particular interest in this area is the adoption of WBG power semiconductor devices, which enable increased operating frequency (reduction in the size/weight of

passive components). WBG power semiconductor devices reduce losses compared with their silicon counterparts and have higher maximum junction operating temperatures (allowing the flow of higher current). In this framework, integration and advanced cooling concepts are enablers to extending the limits of WBG power semiconductor devices.

2.2.5 Electrified ships

Today all ships use electric power to power auxiliary equipment. Electric power is supplied either by a generator on the main shaft connecting the diesel engine to the propeller or by an auxiliary generator. On long distance routes it is expected that fossil fuel will be replaced by synthetic fuel manufactured using renewable energy or biomass. Battery operated ships may be considered as an option for shorter routes such as ferries.

However, if the prime movers are expected to remain based on combustion engines, there are a number of applications in which more electrification provides operational benefits and energy savings. Electric drives used in azimuth

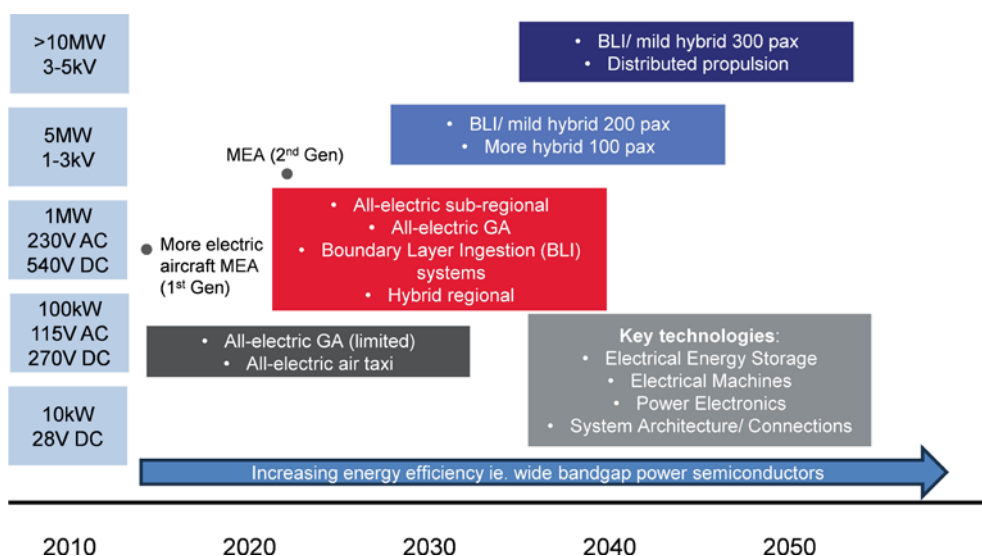

Figure 2-7 | Power requirements for the next generations of aircraft, where the top value in the grey boxes denotes the electric power demand and the bottom value(s) the voltage

thruster or transversal thrusters provide better manoeuvrability. Furthermore, electric drivers in general enable shifting of available power between propulsion and auxiliary functions.

Besides efficient operation during the journey, another important topic needs to be considered. Today, the auxiliary systems of most ships are powered by auxiliary generators on board. Providing electric power from the quay allows to replace this power by energy from the local grid. Systems for providing shore power usually employ power electronics to interface the ship's electrical system with the local power grid.

As the electric system on board a ship constitutes a system on its own and is designed at the same time as the ship, the onboard distribution system is often more easily built as a DC-grid, while power distribution systems on land are more frequently of the AC type. In this case, the ship's system could benefit from savings in space and weight by replacing line frequency transformers by solid-state transformers which use power electronics and operate at higher frequencies, thus rendering the system less bulky.

2.2.6 Factory automation, industrial motors, and inverters

Electrical motors constitute the largest individual source of energy use, accounting for nearly 50% of the world's electricity consumption, and over half of this energy demand originates from motors used in pumps and compressors, among many other industrial processes. In industrial applications, almost 70% of the electricity applied is used to operate electrical motors, and users increasingly deploy power electronics to realize motor drives/variable speed drives (VSD) to control the operation of these motors. VSDs offer tremendous energy savings during the operation of the motors and improve the profitability and competitiveness of the applications. Combined with advanced factory automation, diagnostic

methods, novel industrial electrical system layouts and smart plant supervision, this use of VSDs enables implementation of various concepts of digitalization (Industry 4.0) that enhance operational performances and reduce CO₂ emissions. Being at the heart of every power electronics converter, power semiconductors have a direct and measurable impact.

It has been estimated that the market for LV AC motor drives will be more than USD 25,5 billion by 2030 at a CAGR of 4% [58]. Approximately 25 million units of LV motor drives are expected to be installed in 2027, driven by the trend of inverterization of pumps, fans and compressors due to high-efficiency system requirements along with substantial energy savings [59].

Developments in power semiconductors have enabled continuous improvements in conversion efficiency (reduction of switching and conduction losses), while enabling high-frequency operation, which positively impacts the power density of inverters. This is mainly due to the positive effect that switching frequency has on the size of magnetic components (inductors and transformers), which are essential elements of every inverter. Higher switching frequency makes it possible simultaneously to increase the control bandwidth of the inverters and improve the performance of controllers.

Integrated solutions combining a motor and a low voltage inverter in a compact package have also been introduced to the market, with projected sales of USD 1,3 billion in 2030. Such solutions improve efficiency, reliability and electromagnetic compatibility compared to separated motor-inverter arrangements. The inverter can be better matched with the electrical characteristics of the motor, and the amount of wiring cables and interfaces is significantly reduced. Recent developments in WBG semiconductors (in particular SiC MOSFETs/GaN HEMTs) are redefining norms in converter designs. With reduced power losses and cooling requirements of WBG semiconductors, it will

become more feasible in the medium-term (5-10 years) to integrate the low voltage inverter with the electrical motor in a compact solution.

In terms of the projected transition to an energy-wise society, improvements alone in the efficiency of every inverter are not enough, and a more holistic approach is needed. A good example of ongoing and continuing efforts in this direction are DC industrial networks for industrial processes with a large number of variable speed drives (DC Industry). By implementing local DC distribution with many inverters fed directly from the same DC bus, and knowing the load cycles of industrial processes, a great deal of braking energy can be reused within the factory, reducing the need for energy from the utility network.

2.2.7 Heavy industries and high-power converters

The applications of electric industrial drives range from low-voltage drives with a maximum rated motor voltage of 1 000 V AC and an output of a few kW to medium-voltage drives up to max. 13,8 kV AC and outputs that can easily reach 100 MW. In the context of efforts to decarbonize industry, the efficient use of energy is of particular importance. Variable-speed drives with power electronic converters enable efficiency optimization in many applications where fixed-speed drives, in some cases with soft starters, have been used until now. For this reason, a rapidly growing market for low and medium voltage drives has developed over the last two decades. Especially for applications in the process industry, not only the efficiency of the power converters but also their reliability and availability play a very decisive role. Drives in the multi-megawatt range are therefore also becoming smart and are being supplemented by additional features such as condition monitoring and predictive maintenance. Drivers of this development are no longer solely special applications such as rolling mills and LNG compressors, but also standard applications such as fans and pumps.

Due to the significant increase in energy costs, which are expected to continue to rise, any improvement in energy efficiency will not only lead to more sustainable solutions, but also to economically attractive ones. In addition to the drive components (i.e. motors and inverters) themselves, the focus is increasingly on the holistic optimization of industrial processes. This is the only way to successfully exploit the full energy-saving potential. This development is also increasingly reflected in standardization and the definition of energy efficiency standards contained therein.

A key enabler for the increasing use of power electronics in industrial applications is the rapid development of silicon and silicon carbide-based power semiconductors. Thyristor-based solutions are increasingly being replaced by self-commutated voltage source inverters.

In the future, the development of power converters in high-power applications will be significantly influenced by the electrification of entire industries on the way to an energy-wise society. The power grids of the future will differ significantly from today's grid structures. In contrast to the current state of application, the power grid of the future will be characterized by decentralized power generation, greater distances between generators and loads, and distributed power generation that is decoupled from the load. This accelerating decentralization of power generation will require increasingly coupled and meshed grids, in which the generation, conversion and storage of electrical energy is integrated directly into the low-, medium- and high-voltage grids via power electronics. In addition to grid stability, the converters used must ensure reliable and cost-effective operation of the grids. For the converters, this results in new requirements with regard to frequency and voltage control, black-start capability, other grid services, and, above all, voltage and current harmonics at the respective grid connection point. The power converters will be expected to be installed and to operate in completely new environments, for example to collect the offshore wind or power

generated from ocean waves and tides. In such offshore installations power transformers are a necessary component for efficiently transmitting the generated electricity to the shore. At remote locations and large ocean depths, constructing platforms for high voltage power infrastructure is problematic. An alternative approach is to install the equipment directly on the sea floor. Recently, a subsea high voltage power transformer and a power converter (i.e. variable speed drive) rated 12 MW were installed directly on the sea floor [60]. In such subsea applications thermal aspects are very different than those in industrial environments and need new interpretation of standards and acceptance test methodology. Silicon power semiconductor devices were especially adapted for the high-pressure environment and natural liquid cooling conditions in subsea applications using innovative module approaches suitable for voltages of 4 500 V.

For converters, all the aspects mentioned above result in a number of challenges that will be the focus of increased attention in the future. The trend towards ever higher voltage levels will continue. This requires increasingly complex circuit topologies and design concepts for power electronics. However, the constantly increasing switching frequencies and higher system voltages mean that important resources can be conserved

due to the reduced expenditure on passive components and copper or aluminium cable cross-sections.

2.2.8 Other industry applications

Welding and medical applications are other major equipment considered in the white paper. This subsection introduces the requirements for power semiconductor devices in terms of each application as summarized in Figure 2-8.

It is predicted that the market size of arc welding applications will grow with a CAGR of 6% from 2022 to 2028, reaching approximately USD 6,4 billion in 2028 [61]. Arc welders are used in the welding process to join metallic parts. The electrical current creates heat to melt the metals, thus creating a bond between the parts as the molten metal cools. Demand for arc welding equipment is driven by the growth of industries such as machinery manufacturing, oil and gas. In welding applications, the power semiconductors require high current and low voltage ratings at the converter output side, in order to obtain a stable arc phenomenon. In addition, a high current control response is needed to avoid spatters. Highly efficient circuit topologies of isolated AC-DC converters are expected. For example, the use of interleaving technology enables connecting

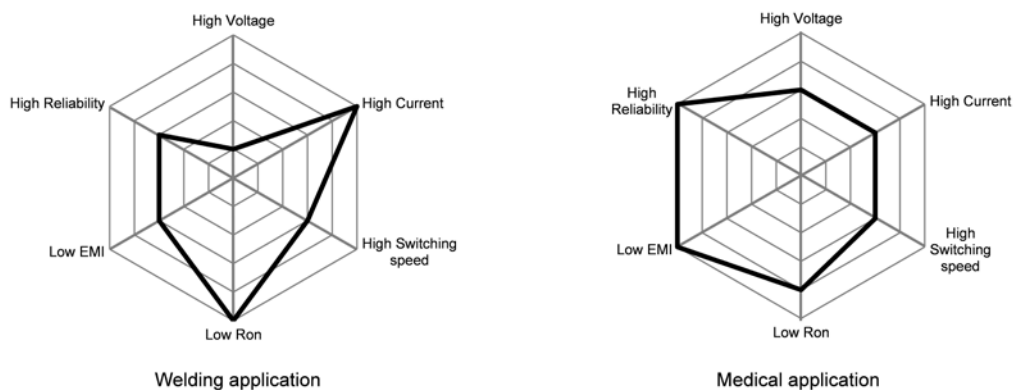

Figure 2-8 | Requirements for power semiconductors in welding and medical applications

multiple power converters with phase-shifted outputs in parallel and is applied to improve the current control response. Low-voltage GaN power semiconductors could be good candidates for such power converters in the future.

The market for medical power supplies is expected to grow with a CAGR of 6,5% from 2022 to 2027 and will reach approximately USD 1,9 billion in 2027 [62]. Medical power supplies must meet certain criteria for medical use in hospitals and homes. High electromagnetic compatibility (EMC) is required due to higher safety standards and requirements for less electromagnetic interference (EMI), for example in the case of sensitive patient implants. Furthermore, the power supply form factor should be flexible in order to maintain compatibility. Medical power supplies are used in many applications including haematology analyzers, X-rays, magnetic resonance images (MRI), patient monitoring, robotic surgical instruments, dental equipment, computer tomography (CT) and positron emission tomography (PET) scanners, etc.

Medical power supplies require high reliability, low noise, low leakage currents, low voltage ripple, and flexible form factors. Reliability has first priority, and thus low power losses and low dv/dt , di/dt are required from power semiconductors to suppress rising temperature and EMI. A switching strategy (pulse width modulation (PWM) technique), circuit topology and advanced gate drive units that can control dv/dt and di/dt are key to achieving low EMI and low power losses. Hybrid silicon IGBTs with SiC Schottky diodes, as well as SiC-MOSFETs with an appropriate adjustment of a gate resistance value, could be good candidates for such power converters in the future.

2.2.9 Heating and cooling, home appliances

Heating and cooling, namely room air conditioning, constitutes one of the markets that expand as the economic level of countries increases. This

technology improves the quality of people's lives especially with the growth of population and urban areas in warmer climates. According to IEA, space cooling accounts for 20% of total electricity used in buildings and is recognized as one of the “blind spots” of top drivers of global electricity demand [63]. Heat pump technology is the enabler of electrification in this field and is rapidly gaining attention due to the recent rise in fossil fuel prices and the commitment to reducing CO₂ emissions. When used for heating, high temperatures can be obtained without burning fossil fuels. Since an increase in electricity consumption is expected as the heating and cooling market expands, higher energy efficiency will be required and the energy intensity of air conditioning, for example, will have to be reduced from 3 000 kWh/unit/year in 2021 to 2 000 kWh/unit/year in 2030 [64]. To increase energy efficiency and reduce losses, all components of a heat pump – circulation pump, fan and compressor – are operated by motor drives with power semiconductors. Among home appliances, refrigerators also use this technology. Government policy will play an important role in promoting the widespread use of high-efficiency/inverter-type air conditioners and refrigerators, especially in fast growing developing economies.

Almost 650 million air conditioners are expected to be added from now until 2030, with many expected to be of the inverter-type [16]. More than 250 million home appliances (e.g. washing machines, refrigerators) are expected to be installed worldwide in 2030 alone, and many of these units are also likely to be inverter-type in order to satisfy energy efficiency regulations and sophisticated controls, such as vibration reduction in washing machines (when there is an uneven distribution of clothes). Manufacturing such volumes of home appliances will require a significant amount of power semiconductor devices.

In air conditioners, power semiconductors are used roughly in three circuits: 1) AC to DC conversion with power factor correction (PFC) to meet electromagnetic interference regulations and

sometimes to generate boosted voltages for pulse amplitude modulation (PAM) control, 2) for driving compressors, and 3) for driving external fans. Power semiconductors, mainly represented by silicon IGBTs integrated with diodes, gate drivers, boot-strapped high-side voltage generation and protection circuits, have supported the progress of inverter-type air conditioners. Higher energy efficiency, better reliability, a reduced number of components and the miniaturization of printed circuit boards (PCB) (from three boards to one) have been achieved compared to traditional on/off motor controls. This improvement has expanded the application of intelligent power modules (IPM) not only to air conditioners but also to other home appliances such as refrigerators and inverter-type washing machines. Looking ahead to the next 5-10 years, it is expected that more inverter-type units will be installed in order to address the electricity reduction coming from increased energy efficiency of heating, cooling and home appliances, as shown in Figure 2-9 [16].

Initially, the coefficient of performance (COP) was used to define the performance of heating and cooling at a given temperature for every kW of

electricity consumption. Since temperatures differ by season and by region, more realistic indexes are now widely in use, for example, the annual performance factor (APF) or the seasonal energy efficiency ratio (SEER). Use of such indexes reveals that the average operating condition for power semiconductors in these applications is at partial load, i.e. at a fraction of their full current ratings. Thus, deployment of power semiconductors having lower losses, especially at low current/partial load, is desirable. Here the possibility exists of using SiC MOSFETs and later on other WBG semiconductors instead of silicon IGBTs, which are widely used now.

To meet the increased demand for power semiconductors toward 2030 in this application, more silicon wafers would be needed in the market, or the manufacturing of semiconductors would have to be expanded from a wafer diameter of 8 inches to 12 inches. A technology combining a silicon IGBT and a FWD in the same semiconductor chip has been developed and has begun to be used in IPMs for air conditioners.

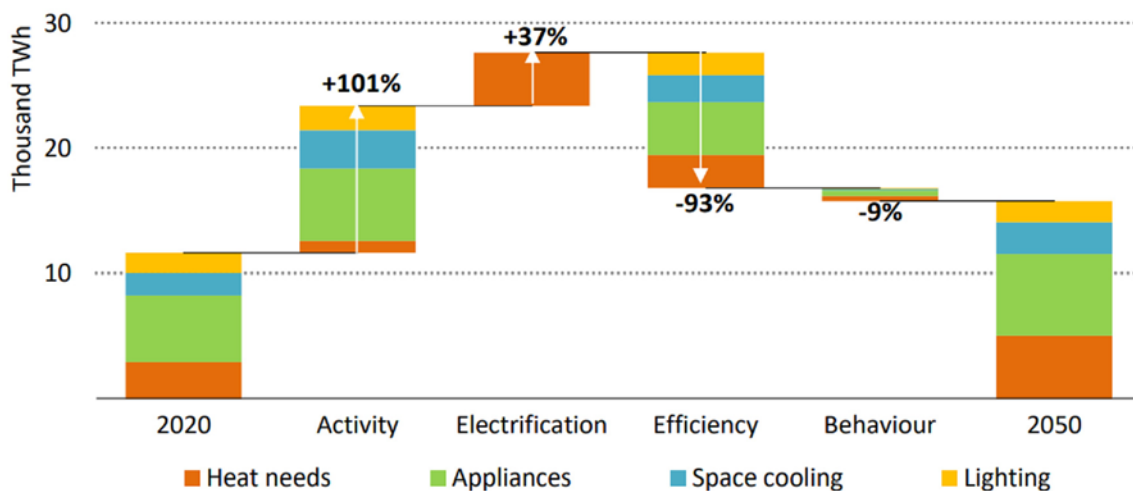

Figure 2-9 | Global change in electricity demand by end-use in the buildings sector

2.3 Data centres and telecom information technologies – IT sector

Digital and intelligent transformation together with green and low-carbon developments are the two megatrends driving the information technology (IT) sector forward. An energy-wise society is increasingly data-driven, with many new trends such as the emerging Internet of Things (IoT) and its ubiquitous big data analytic, data-intensive analytic activities such as video streaming and social networking, smart city projects, artificial intelligence (AI), cloud computing and cryptocurrency applications revolving around data and information and communication technologies (ICT). Power semiconductors play an essential role in the IT sector by enabling power electronics solutions with high power density and less waste heat generation.

Data centres are becoming an increasingly critical part of the infrastructure driving digitalization. A data centre is a facility dedicated to the operation of equipment providing data processing and storage. It typically consists of servers, storage devices and communication networks, together with ancillary equipment required for cooling and power supply. The data centre industry is heterogenous in many ways. In terms of scale, the power ratings per data centre vary between a few kilowatts up to tens or even hundreds of megawatts. In the last two decades or so, the world's data centre fleet has grown from encompassing a few enterprise computing centrals to constituting an important feature in modern infrastructure. Power semiconductors are encountered in power supply units that deliver secure power to data centres and servers, including back-up power. They are also used in motor drives as components of pumps/fans in the complex cooling systems of a data centre.

In 2021, approximately 7,4 million data centres existed worldwide, of which 8000 were ranked as large data centres [65] [66]. These numbers

testify to the direct and indirect effects digital technologies exercise on energy use and GHG emissions and the enormous potential they hold to help (or hinder) the global clean energy transition (including the digitalization of the energy sector). It was estimated that worldwide data centres and cryptocurrency mining consumed 350-450 TWh electricity in 2022, corresponding to 1,4-1,7% of the total global electricity demand [67]. It was also estimated that the data centres and data transmission networks that underpin digitalization accounted for around 330 Mt CO₂-equivalent in 2020 representing 0,9% of energy-related GHG emissions (or 0,6% of total GHG emissions). Since 2010, emissions have grown only modestly despite a rapidly growing demand for digital services (approximately a twentyfold increase), thanks to energy efficiency improvements, renewable energy purchases by ICT companies and broader decarbonisation of electricity grids in many regions. However, to get on track for the IEA NZE, emissions must be halved by 2030 [67].

Data centres will face the challenge of reducing power consumption while providing an expected forty times greater amount of data per use, with the demanded computing power being ten times larger and generated data increasing by a factor of more than twenty. For data centre operators, this includes following energy efficiency best practices, locating new data centres in areas with suitable climates and low water stress, and adopting the most energy-efficient servers and storage, network and cooling equipment. Innovative technical solutions are needed, and their development is leveraging the advantages of power electronics and multi-stack product portfolios to help enterprises build more efficient, greener and more reliable data centres.

Examination of the average distribution of power consumption in a data centre indicates that 30% to 50% of the total electricity consumed in a data centre is used for cooling, about 15% each by the server power supplies and processors, and 10% by the power distribution system (incl. medium

voltage transformer and uninterruptible power supply (UPS) systems) [68]. The most widespread efficiency indicator in data centres is the power usage effectiveness (PUE) metric, which measures the ratio between the power used in the entire data centre and the power used by the IT equipment. Larger data centres have a PUE close to 1,1, while the average self-reported PUE in the industry has remained stable since 2013 at around 1,58 [69].

Data centres are normally equipped with central UPS units to ensure continuous and high power quality, and for handling grid power failures. The UPS units are mostly based on silicon power semiconductor devices and have the capacity to power the data centre at its maximum power requirement for 5 min-30 min at a peak efficiency in double conversion mode of up to 97-98%. However, at partial loads the peak efficiency will decrease, which is why many modern UPS systems offer an ECO mode bypassing the power electronics converter.

With the introduction of SiC MOSFET devices, the peak energy efficiency values were able to be increased by more than 0,5% and the output power by more than 25% in double conversion mode, with the efficiency remaining above 98% for load usage percentages higher than 30%. In other developments, UPS systems with ultra-high power density can now be integrated in medium voltage power distribution cabinets, thereby reducing the physical footprint of the electrical equipment by 30% and allowing more server racks to be installed.

Interest is growing in the more active use of UPS units for peak shaving and frequency regulation in power systems with increasing shares of variable renewable power generation [70]. Future data centres will be highly integrated into power systems by routinely utilizing capacity that was formerly perceived as backup emergency power. Several data centre operators are aiming at 100% renewable electricity combined with emerging electricity storage options [71].

Section 3

Power semiconductor devices trends and future perspectives

3.1 Introduction and background

The power electronics revolution has opened-up a wide range of possibilities in terms of controlling the way electrical energy is sourced, transmitted, stored, and consumed. At the core of this revolution lies the power semiconductor device which has the main task of modulating the electrical energy flow to suit the demands of the load for a given application. The beginnings of power semiconductor use occurred in fact less than a decade after the invention of the solid-state bipolar transistor in 1947, when the first silicon-controlled rectifier (SCR) was demonstrated [72]. The foundations of power semiconductors were established at broadly the same time with integrated circuit (IC) semiconductors in the 1950s, as both devices played the key role in the power and data processing revolutions respectively. Deployed in countless applications, these technologies have had a profound impact on society in terms of the way the modern world is functioning and communicating. While the main development trend for ICs has been to increase the speed and capacity of data processing, for power devices it was the power handling capability. Power semiconductors are today present in all parts of the energy chain, beginning with the low power applications segment, such as in computers and mobile phone chargers, and increasing to the very high-power range, such as in transmission and distribution (T&D) systems.

Power semiconductors have always benefited from advanced materials and processes developed for the much larger and well-funded IC technologies

by scaling and optimizing them to enable the components to withstand higher voltages and currents. This led to the development of a wide range of silicon-based power devices for an ever-increasing number of power electronics applications [73]. With the development of wide bandgap (WBG) semiconductor materials [74], another leap in device performance is expected in the coming years. Such developments are vital with regard to the recent energy-related social, economic, and environmental concerns. Therefore, as society moves to a more electric footing, involving ever larger amounts of electricity to be conditioned and utilized, efficient conversion is becoming essential.

The global market of power transistors, including both silicon and silicon carbide (SiC) semiconductors, amounted to USD 29 billion in 2022 [6]. The multi-source availability of semiconductor devices is a crucial factor for the success of power electronics. With the strong market growth registered in this sector, particularly concerning applications in renewable energies and electromobility, the availability and supply of semiconductor devices tends to constitute the more limiting factor. Thus, the near future will see more large-scale investments along the value chain of power semiconductor devices.

3.2 Power semiconductor chip technologies

Power semiconductors are diversified into several technology families to serve a wide range of application needs [75]. One such family is based

solely on semiconductor junctions between oppositely doped material (p-n junctions). These devices consist mainly of diode and thyristor-like structures manufactured as single wafer devices in hermetic housings. Today the thyristors are reaching the highest power levels, with ratings beyond 10 kV and several kiloamperes per device. Another family is based on the metal oxide semiconductor (MOS) interface and ranges from the unipolar low voltage MOS field effect transistor (MOSFET) to the electron-hole plasma flooded medium to the high voltage insulated gate bipolar transistor (IGBT) [76]. These components are emerging in the form of semiconductor chips packaged as discrete devices or integrated into larger modules using multiple paralleled chips. Modules sometimes include parts of the power circuitry or even the control electronics. Discrete packages and power modules using silicon power semiconductors are the workhorse of power electronics and, depending on the application, will remain in this role for the foreseeable future.

In general terms, as silicon-based technologies approach certain performance limits, device structures become more sophisticated and costly for further improvements. While silicon originally represented a significant step forward from germanium, WBG semiconductors with a substantially wider energy bandgap such as SiC and gallium nitride (GaN) can lead to much improved performance levels. This led to the research and development of such materials over the past few decades. SiC became the primary choice for high voltage and high current requiring vertical current conducting structures, predominately using MOSFET technology. The transistors are complemented by diodes of a third technology family, based on the metal semiconductor or Schottky junction. The other WBG candidate, GaN, profits mainly from its progress in optoelectronics and radio frequency (RF) devices, and usually uses a fourth technology family based on the high electron mobility transistor (HEMT) device concept.

The next generation of materials, possessing an even wider energy bandgap such as gallium oxide (Ga_2O_3) or diamond, is already on the way. However, it is unclear which materials will prevail, because wafer production and processing such as doping and forming ohmic contacts tend to become more challenging with the increasing bandgap energies.

In addition, to accommodate continuous developments at the chip level, significant progress on the packaging technology front is required to fully exploit the benefits offered especially by the WBG devices. Power semiconductors are employed in a very wide range of applications, so environments in which power semiconductor components are operating are becoming accordingly more demanding. Consequently, the reliability of the power semiconductor has constituted a field of relentless effort for both chip and package designs, manufacturing processes and test procedures to ensure the highest performance and quality levels in the field [77].

3.3 Silicon chip technologies, history, and future trends

Silicon-based power semiconductors have contributed to high efficiency power conversion in a wide range of power electronics applications. This was achieved by continuous improvements in device electrical and reliability performance. The first switching power semiconductor devices to emerge were rectifier diodes and thyristors having non-controllable turn-on characteristics to achieve device conduction (i.e. the device cannot be turned off via a gate signal). Power MOSFETs and bipolar junction transistors (BJT) dominated the low to medium power range. The voltage-controlled MOSFET provided high switching speeds and the ability to parallel or scale devices without the risk of current crowding or thermal runaway. However, the voltage ratings of power MOSFETs are typically limited to less than 1 000 V, because the conduction losses increase with the

blocking voltage to the power of 2,5. The current controlled BJT offered higher voltage ratings with lower losses thanks to the electron-hole plasma (i.e. bipolar conductivity modulation) provided during conduction. However, the device suffered major drawbacks and performance-limiting failure modes. High conversion power requires high blocking voltage levels, low power losses and, in many converter topologies, turn-off capability. In the 1970s, a gate turn-off thyristor (GTO) was developed that combined the low conduction losses of a thyristor with the switching properties of a BJT under soft switching conditions. These device concepts dominated the high-power market covering industrial applications, traction converters and grid systems. In the 1980s, the IGBT was developed to provide a power MOSFET-bipolar transistor integration concept combining the benefit of both device functionalities by offering improved controllability, lower losses and higher voltage ratings. In addition, the GTO evolved into the gate commutated thyristor (GCT) in the

1990s, offering very low conduction losses and hard switching turn-off capability. These device concepts dominated the high-power market covering industrial applications, traction converters and grid systems (see Figure 3-1).

Although high switching frequency operation can lead to system downsizing due to small passive components, the switching losses of power devices will increase. Therefore, a trade-off relationship between conversion power and switching frequency is prominent in silicon devices, and further limitations are presented by the maximum operating junction temperature due to the high off-stage (i.e. voltage blocking) leakage current levels. Accordingly, different silicon chip performance levels are facing certain theoretical limits, and the gap between these solutions and those provided by WBG devices with respect to an economic parameter such as “cost/power” is narrowing. However, silicon and WBG-based power semiconductors will continue to coexist due to advanced silicon designs and processes that

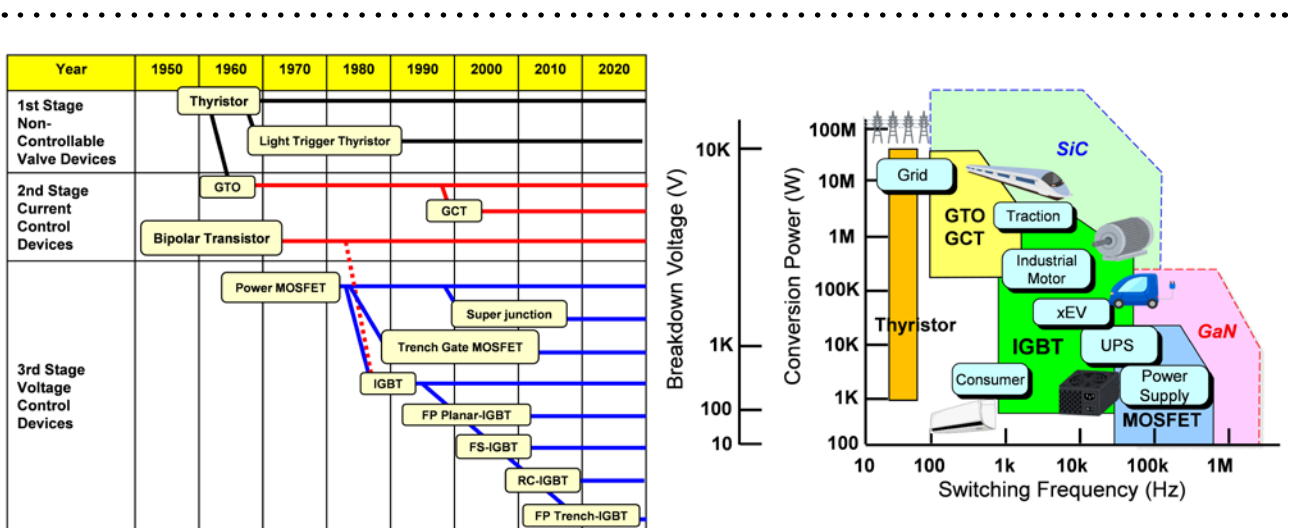

Figure 3-1 | Genealogy and applications map of power semiconductor devices⁴

NOTE: Diodes are not included, as they are required in all applications along with different switch concepts.

4 Silicon IGBT includes different commercial product classes such as carrier stored trench bipolar transistors (CSTBT), injection enhanced gate transistors (IeGT), high conductivity insulated gate bipolar transistors (HiGT), soft punch through (SPT) technology and trench field stop (TFS) technology from various manufacturers.

are continuously being developed with improved performance and the potential to manufacture such devices on 300 mm wafer production facilities. This enhances high mass productivity with high quality control due to automated product lines with high through-put capacity. After more than 60 years of successful innovation in silicon power semiconductor device technology platforms, the development roadmap continues to evolve with further steps for increasing power densities and efficiency in progress.

3.3.1 Thyristor

A thyristor is a switch-on current power semiconductor device concept containing no switch-off current capability. Thyristors constitute a key component in load commutated converters (LCC) of HVDC valves for bulk energy transmission, control of transmitted power quality via flexible alternate current transmission systems (FACTS), efficient motor control and other industrial applications. A wide range of thyristor products and power ratings exists, including the phase control thyristor (PCT) 50/60 Hz, the bi-directional control thyristor (BCT) 50/60 Hz, the bypass/crowbar thyristor and the fast turn-on thyristor up to 1 kHz. In terms of trigger mechanisms, there exist electrically triggered thyristors (ETT) and light-triggered thyristors (LTT). High-power PCTs are available in hermetic ceramic press-pack housings (capsules) suitable for high-voltage stacks. Medium-power PCTs are also available in non-hermetic bipolar power modules with different configurations, while some low-power PCTs can be found in discrete packages. Voltage ratings can range from 600 V up to 9 500 V (up to 13 kV have been demonstrated) while current ratings can reach up to 6 000 A. As the device with the lowest on-state losses from all available switching concepts, thyristors are continuously being pushed into new applications while at the same time expanding the power rating of their original applications. Today, they continue their contribution to massive energy

savings as one of the main enablers of the “green economy” via renewables (wind converters of wind turbines), supply converters for production of green hydrogen (electrolyzers), medium voltage drives and transmission and distribution of electrical energy (HVDC, FACTS), such as for ultra high voltage UHVDC systems with power levels exceeding 10 GW. It is foreseen that thyristors will endure by providing cost efficiency in energy-saving technologies of high societal impact. IEC Standards for mainstream use of thyristors are already available. Some additions with respect to new topologies such as modular multilevel converters (MMC), new functionalities (bypass thyristors for MMC, etc.), new overload conditions (multi-pulse short circuits), etc. will be useful for assuring the interoperability reliability and resilience of emerging complex technologies such as grid forming of the future meshed electrical grid [78].

3.3.2 GTO and GCT

The arrival of devices with inherent turn-off capability enabled a new era of power electronics topologies based on voltage source converters (VSC). Therefore, thyristor structures with turn-off capability, such as the GTO, have played a key role in enabling these types of topologies in the high-power range. They were widely employed in railway traction until the GTO faced strong competition from the emerging high voltage silicon IGBT, which eventually replaced the GTO in such applications. Nevertheless, the GTO evolved into the more advanced GCT, with hard-switching turn-off capability. The GCT utilizes a semiconductor wafer design relatively similar to that of the GTO but with a special hermetic ceramic press-pack with low inductance design and an integrated gate unit that when combined with the GCT, is referred to as the integrated gate commutated thyristor (IGCT) (see Figure 3-2). The IGCT can be designed to be asymmetrical, reverse-conducting (RC) and reverse-blocking (RB), which makes it suitable for a wide range of power electronics applications.

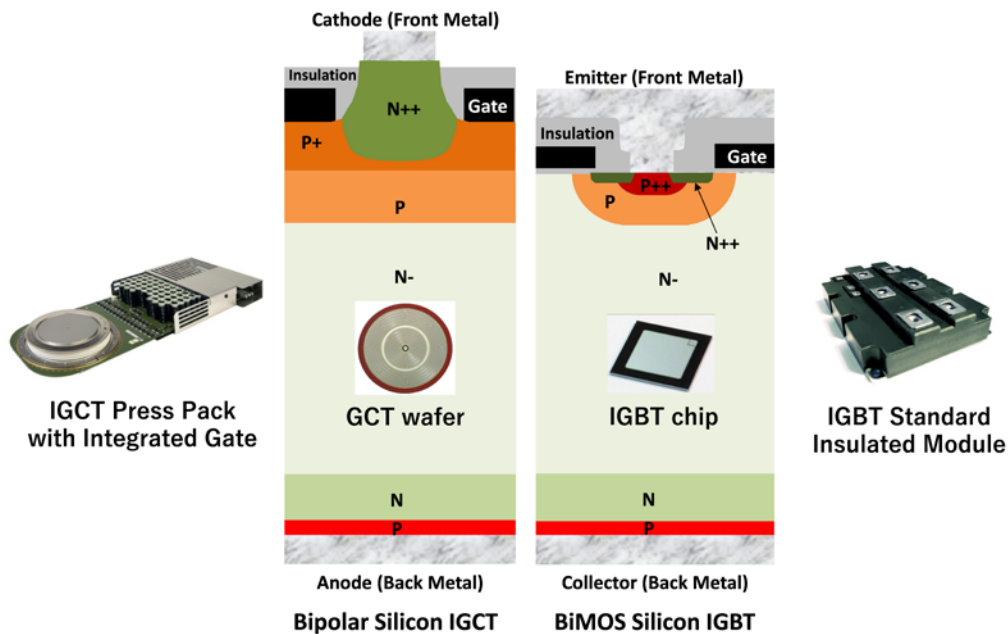

Figure 3-2 | IGBT and GCT cross sections along with device and package shapes⁵

NOTE: The P/N areas represent semiconductor regions doped with different chemical elements.

Voltage ratings can range from 2 500 V up to 10 000 V with current turn-off capabilities in the thousands of amperes. If not integrated on the same GCT wafer (e.g. RC-IGCT), the asymmetrical IGCT requires fast recovery diodes for snubber and freewheeling functionalities. The IGCT's low conduction losses and high robustness led to high power and high efficiency converters being realized for industrial applications such as in medium voltage drives (MVD) (e.g. rolling mill drives). Currently, the IGCT is the key component in MMC converter cells for rail-inertias (3-phase, 25 kV/50 Hz), static synchronous compensators (STATCOM), pumped hydro storage (PHS) drives, and off-shore wind generation converters. For example, the small footprint and scalability of wind power converters with IGCTs will provide 20 MW of peak power per unit for offshore wind farms by 2030. It is also foreseen that some VSC HVDC systems covering the higher power range

>3 GW will be based on IGCTs [79]. For example, a 0,1% energy efficiency improvement in a 3 GW rated, two-terminal HVDC system, operating at full power for 30 years would allow a USD 150 million operating-cost reduction at an electricity rate of USD 0,10/kWh. This corresponds, for this one example, to a significant GHG emission reduction. The IGCT market is normally less than 5% of the total high power semiconductor market, with a CAGR of 7,4% bringing this market to about USD 100 million by 2030. This estimate does not include future HVDC applications, which are only now starting and which could easily double the 2030 IGCT market size to USD 200 million. Thus, there has been an increase in the number of IGCT manufacturers which will impact the device development and offering in the next ten years. Therefore, standardization is important but reasonably easy with IGCTs because of industry-standard wafers and housings (press-packs).

⁵ Source: Hitachi Energy

Since standards already exist for thyristors and IGBTs, specific rating, evaluation and qualification tests for IGBTs can easily be derived.

3.3.3 IGBT and freewheeling diode

The silicon IGBT was first employed in low power discrete products in the 1980s having demonstrated, compared to BJT and thyristors, superior characteristics which were very desirable for power electronics system designers. While the first commercially available silicon IGBTs did not exceed blocking voltage capabilities above 600 V with current ratings of a few amperes, development efforts continued for increasing the power handling capability, resulting in high voltage IGBTs with ratings up to 6 500 V and thousands of amperes. The silicon IGBT has been deployed along with optimized freewheeling bipolar (pin) diodes in different package platforms including discrete components and modules, and has become the most widely used power semiconductor device for power electronics applications in the medium to high power levels (few kW to GW). These include a wide range of applications such as consumer appliances, railway traction, automotive, renewable converters, industrial drives, grid systems and other emerging solid-state applications such as DC breakers.

It is difficult to accurately estimate or quantify the impact of silicon IGBT-based applications in terms of energy efficiency and related cost savings, but it is safe to say that they amount to tens of trillions of dollars. Furthermore, these efficient applications have also led to remarkable reductions in GHG emissions amounting to hundreds of trillions of kilograms worldwide. Hence, such applications constitute the foundation for driving the electrification megatrend by providing efficient, sustainable, and reliable energy for the urban, industrial and transportation sectors. Even though the silicon IGBT is being challenged today by emerging SiC-based MOSFETs in many applications, it remains well placed to continue its

dominant role for many years to come, involving further technology advancements and a wide manufacturing base and resources for processing silicon IGBTs on larger wafer diameters. Consequently, the market size for silicon IGBTs is projected to reach USD 13,2 billion by 2028, growing at a CAGR of 9,25% from 2021 to 2028 [80].

The traditional development trend for silicon IGBTs [81] aims at achieving higher power densities by means of reducing losses. Therefore, recent technology improvements have focused on thinner structures based on field stop (FS) technology combined with improved MOS cell designs based on fine pattern (FP) trench gate concepts. The most advanced designs have only been implemented in low to medium voltage silicon IGBTs and are yet to be implemented in the higher voltage range. Other technology development trends include functionality integration such as reverse-conducting insulated gate bipolar transistors (RC-IGBT) combining the switch and diode in a single semiconductor chip [82] [83], high operating junction temperatures, improved switching controllability and long-term device stability. It is important to note that similar development targets are also being pursued for the companion freewheeling fast recovery diode to complement the silicon IGBT performance. Another development trend is related to the customization of power semiconductors to suit the specific needs of different power electronics applications. Many high-power market segments prefer multiple sources for their power semiconductor components which have led to both package standards and similar performance specifications from different device manufacturers. Nevertheless, non-standard custom solutions have been developed over the years for offering improved and/or modified designs with finely tailored performance levels, especially for high power applications such as grid and industrial drives. With the wide and expanding range of applications, this development

trend is set to continue, as customized products will be in high demand, with variants ranging from relatively simple modifications to more complex and specialized concepts.

Today, international standards for silicon IGBT testing and performance are well-established. However, future advancement in device technology, performance and package outlines will require re-visiting some elements in the established standards. For example, the introduction of RC-IGBTs into mainstream applications requires advanced gate control methods which are not included in the established standards.

3.4 WBG chip technologies, history, and future trends

WBG semiconductors have received increasing attention as promising materials for high-voltage, low-loss and fast switching power devices. Among the WBG semiconductors, SiC, GaN, Ga₂O₃, aluminium nitride (AlN) and diamond are considered to be potential materials for the next generations of power semiconductors, as shown in Figure 3-3. In recent years, both SiC and GaN have experienced remarkable advancements in material quality, advanced device designs and process capabilities leading to a wide range of technology demonstrators and commercial offerings available in the market [84]. By having an approximately ten times higher critical electric field strength compared to silicon, a WBG power semiconductor with the same voltage rating can be designed with nearly a ten times thinner drift layer and a hundred times higher dopant density. This will result in more than three hundred times lower specific on-resistance compared to silicon (considering the unipolar devices). Owing to the much lower drift resistance, WBG unipolar devices such as the junction field-effect transistor (JFET), MOSFET and Schottky barrier diode (SBD) can outperform silicon power devices in the blocking-voltage range from 300 V to 6 500 V or even higher. SiC power devices are

vertical structures, because 150 mm-diameter epitaxial wafers are readily available. In contrast, GaN HEMTs are designed as lateral structures fabricated on GaN epitaxial layers grown on silicon or other types of wafer substrates. Typically, SiC (vertical) and GaN (lateral) devices are attractive for high-voltage/high-power and medium-voltage/fast switching applications, respectively.

Commercial SiC MOSFETs and GaN HEMTs exhibit very low specific on-resistance and high switching speeds, achieving remarkable energy savings and downsizing of power converters. However, both bulk and interface (surface) defects affect the reliability of these WBG devices. Reduction of these defects with improved material and process quality by applying advanced defect engineering as well as effective screening procedures to sort out devices affected by critical defects are important development targets for reaching the full potential of these WBG devices. In addition, compact and low-inductance package technology should be also developed in parallel to ensure that the capabilities of the semiconductor chip can be fully utilized in the targeted applications.

In addition, the cost/power ratio of WBG power semiconductors is still considerably higher compared with their silicon counterparts. The wafer diameter enlargement, refined crystal boule growth technology and further performance enhancements are effective for achieving a cost/power ratio approaching those of silicon devices, by which large-scale deployment of WBG devices and thereby an energy-wise society can be realized. Regarding vertical GaN, Ga₂O₃, diamond and AlN, materials and basic semiconductor devices are under extensive investigation at the research level.

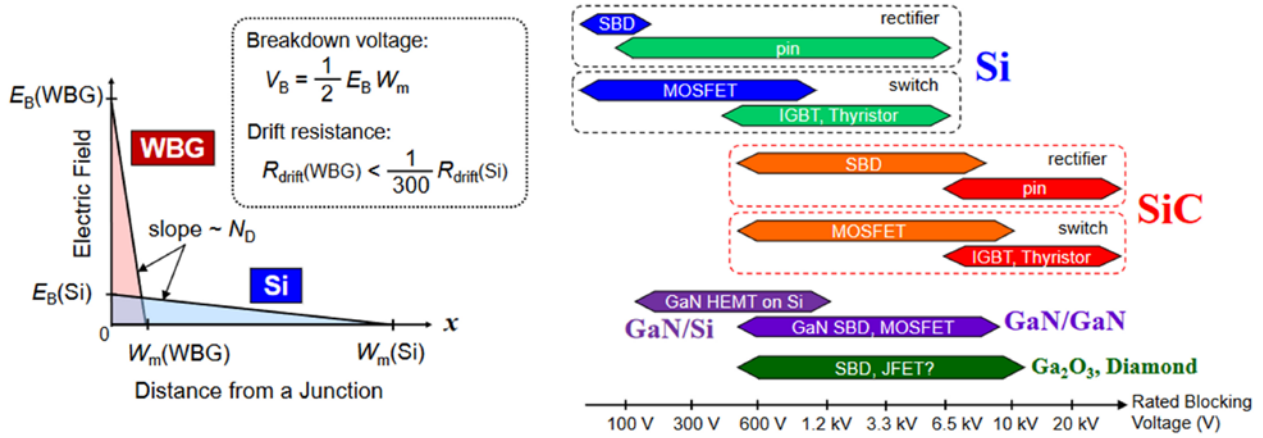

Figure 3-3 | Wide bandgap power semiconductor devices and their range of applicability

3.4.1 SiC semiconductor chip technologies

Despite continued development efforts to further improve silicon IGBT and IGCT performance, fundamental limitations will persist in relation to their bipolar operational mode. These include the built-in potential for silicon bipolar devices, which could be described as the “Achilles heel” of bipolar switches, and the slower switching behaviour compared to unipolar devices. Hence, unipolar SiC devices such as the SiC MOSFETs and SBDs are today considered to be the best options for many power electronics applications with device voltage ratings up to 10 kV. In fact, the SiC MOSFET provides a nearly ideal solution, by having no disadvantage with regard to the above-mentioned bipolar-related drawbacks.

The SiC MOSFET has been considered the SiC device concept of choice when compared to other SiC structures developed in the past two decades, such as the normally-on SiC JFET and the current-driven SiC bipolar junction transistor (BJT). In addition to excellent electrical characteristics, the normally-off device requires a voltage-controlled gate drive like that of the widely adopted silicon IGBT. Another very important feature of the SiC MOSFET is the ability to operate in reverse

conduction or diode mode with attractive electrical performance similar to that in switch mode operation. This is mainly due to the device structure and ease of gate drive implementation during reverse conducting and switching, which thereby results in lower costs by eliminating the need for external SiC diodes. Furthermore, SiC bipolar device concepts such as pin diodes, IGBTs and thyristors suffer from high on-state losses due to an even higher built-in potential in excess of 2 V.

Commercial SiC MOSFETs are available which generate very low conduction (i.e. low specific on-state resistance) and switching losses, while also providing robust switching behaviour [85]. These are based either on planar gate structures, as shown in Figure 3-4 (a), which are available up to the high voltage range [86], or on various trench-gate structures available in the low-to-medium voltage range. The low switching losses and potentially higher operating junction temperatures of SiC MOSFETs will be beneficial for many applications, including those in the higher power range, thus enabling substantial reductions in overall system size and weight due the potential downsizing of the semiconductor, passive components/magnetics and the cooling system.

Many applications will also benefit from SiC MOSFETs compared to silicon devices due to lower conduction losses, especially at low currents, where a large percentage of the losses are dissipated in partial-load or idle conditions (e.g. automotive, urban traction and FACTS). As seen in Figure 3-4 (b), the silicon IGBT presents a built-in voltage due to its particular device structure. This means that even at low currents, there will be a voltage drop across the silicon IGBT terminals, i.e. conduction losses will be higher than in SiC MOSFETs that do not present this effect. However, as the current increases, such as at full load operation or under fault conditions (e.g. short-circuit) the silicon IGBT regains some advantage, as it presents a lower voltage drop across its terminals compared to a SiC MOSFET.

Furthermore, and contrary to the current perception, SiC MOSFETs are also very attractive for modern MMC topologies requiring very low conduction losses under low switching frequencies and nominal or higher load conditions such as in

HVDC. This also applies to “event switching” DC breaker applications requiring very low conduction losses. While silicon bipolar devices will remain limited by the built-in potential, the outlook for further reducing conduction losses for SiC MOSFETs is feasible with increased device area and/or MOSFET technology improvements [87]. One concept under research is based on super junction (SJ) technology. While SJ technology is limited to low voltage silicon MOSFETs rated below 1 000 V, SJ SiC MOSFETs promise much lower conduction losses, especially for higher voltage rated power semiconductors [88]. Based on this concept, very high voltage SiC MOSFETs could be developed with up to 10-15 kV ratings. This longer-term milestone will require further process developments to realize applicable and cost-effective manufacturing methods for SJ devices. In parallel to chip developments, optimized packages have been introduced to enable operation under higher switching and temperature conditions. Other key performance prerequisites will demand

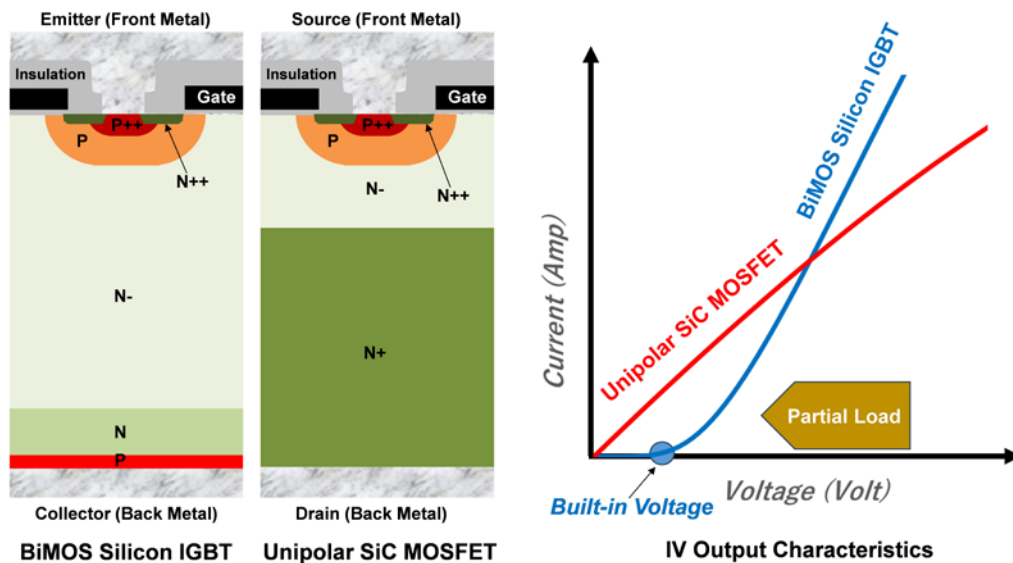

Figure 3-4 | (a) Typical semiconductor device structures (not on scale) for silicon IGBT and SiC MOSFET with similar voltage rating; and (b) I-V plot showing the advantage of SiC MOSFETs under partial load operation

special attention for SiC MOSFETs with respect to the available performance margins related to device fault withstand capability (short circuit and surge current events), device reliability and long-term stability.

Advanced designs, improved processes and continuous progress in material quality, as well as large wafer diameters of up to 200 mm, are key factors to accelerating the introduction and adoption of SiC products in the coming years. The SiC power semiconductor market is predicted to grow from USD 1,1 billion in 2021 to USD 6,3 billion in 2027, with automotive applications constituting the main adopter followed by energy, industrial and transportation applications [12].

3.4.2 GaN semiconductor chip technologies

Discussion regarding the potential of wide bandgap materials for power semiconductors is not complete without addressing the tremendous advancements made on GaN power devices. This trend has been enabled by the lateral HEMT concept. Usually, the GaN and aluminium gallium nitride (AlGaN) semiconductor layers of a GaN HEMT are grown on a low-cost and large wafer diameter silicon substrate. The active part of the HEMT is the two-dimensional electron gas (2DEG), an extremely thin layer of electrons, which develops at a heterojunction between the GaN channel and the AlGaN barrier (see Figure 3-5), featuring an even wider bandgap. The 2DEG provides a very low-resistive path for the majority of charge carriers and leads accordingly to very low conduction losses. So far, lateral HEMTs are limited in their current carrying capability to a few tens of amperes, because their lateral device concept requires large areas for both source and drain current inter-connect on the chip surface. For the same reason higher voltage ratings become very challenging. Unlike for vertical devices, the lateral source-drain separation of GaN HEMT transistor cells increases with higher voltage rating,

thus losing the benefit it offers of a very low area-specific on-state resistance.

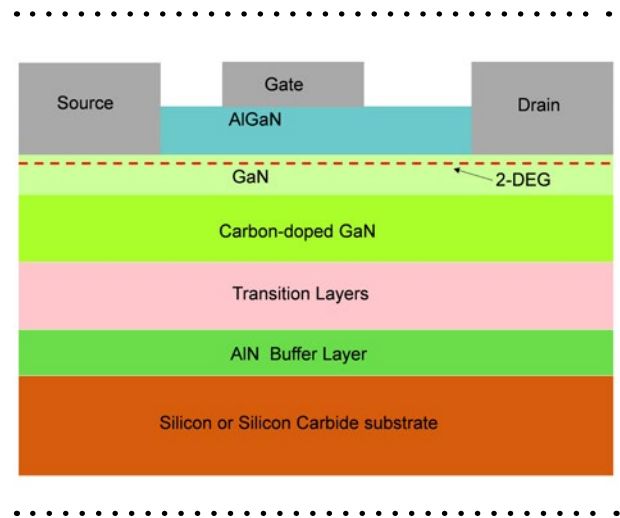

Figure 3-5 | Structural schematic of a basic lateral GaN-HEMT power semiconductor

Furthermore, the GaN-based stack of epitaxial layers must support full voltage also in a vertical direction towards the silicon substrate. The latter especially constitutes a major obstacle for extending voltage capability beyond 1 000 V. Altogether, over the past decade, the lateral GaN HEMT has been developed for power levels of less than 10 kW and voltage ratings up to 650 V. However, typical of lateral devices, the GaN HEMT exhibits very low parasitic capacitive effects with the heterojunction formed on the insulating buffer layers for enabling very fast switching with extremely low switching losses, which in turn allows for very high operating frequencies. Hence, GaN HEMTs can be designed for very high frequency applications in excess of 1 MHz at power levels in the few kilowatts range. Here, strong benefits can be drawn from the lateral device concept and its opportunities for monolithic integration to allow for the needed very low parasitic inductances in the power loop and in the gate-driving loop.

A built-in gate drive functionality is also a good way to combine the GaN HEMT speed opportunities with a robust gate control. Monolithic

integration allows for multiple independent power devices on a single chip, and a fully bidirectional operational mode, which deliver key benefits for many topologies and applications. By substantially lowering the overall losses, while incorporating integration solutions, compact and efficient power electronics systems are realized with the GaN HEMT as the device of choice, especially for the lower power range including server power supplies, laptop and mobile battery chargers, switch mode power supplies, AC adaptors, audio applications and home appliances.

It is important to note that the GaN HEMT is typically a normally-on device, which is a desirable feature for some applications, while undesirable for most others. Through extensive efforts, normally-off type lateral GaN HEMTs have been developed. However, the gate-threshold voltage characteristic of most of them still does not appropriately fit application needs in many cases. The most common concepts are a hybrid cascode configuration (a normally-on high-voltage GaN HEMT in series with a normally-off low voltage silicon MOSFET) or the p-GaN gate concept. Furthermore, continuous efforts are underway to improve the electrical performance and to tackle remaining robustness and reliability issues such as the dynamic on-resistance, limited short circuit withstand time, missing avalanche capability, and difficulty to properly measure the switching losses in a standard double pulse test [89]. Today, many manufactures offer normally-off GaN HEMTs, which are already qualified to automotive standards (e.g. AECQ-101). Market adoption has not yet matched that of SiC power semiconductor devices, but in 2027 power GaN revenues could be more than USD 2 billion [90] [91].

Besides lateral GaN device development, efforts have been undergoing to realize practicable vertical GaN transistor device structures for enhancing current density and voltage blocking capability. However, a number of technical issues remain, such as pinch-off characteristics, current

collapsing or dynamic on-resistance and stability of the gate stacks, which must be further addressed.

3.4.3 Future wide band gap materials

It is enticing to anticipate the next generation of more advanced power semiconductor devices made with other WBG and ultrawide bandgap (UWBG) semiconductors to further accelerate such a technological trend. Among these, Ga_2O_3 , diamond and AlN have attracted the most attention, and medium-size diameter substrates (50-100 mm) are starting to be commercially available for most of these materials. Smart power UWBG devices offer further significant performance enhancement over SiC and GaN power devices, but their large-scale commercialization requires intense infrastructural semiconductor technology development. The key physical and electrical properties of selected WBG and UWBG semiconductors are shown in Figure 3-6. In terms of device structures, generally only unipolar power devices, such as SBDs and power FETs, need to be considered, primarily since many of these are direct bandgap semiconductors, and unipolar devices are showing better performance over bipolar devices.

UWBG semiconductors need to overcome key technological barriers before large-scale manufacturing can commence. The poor thermal conductivity of Ga_2O_3 , for instance, necessitates that it grow on high thermal-conductivity such as SiC and p-type doping, a capacity which is yet to be demonstrated [92]. For diamond, gem desirability may compete too strongly with its electronic applications in terms of cost effectiveness. Besides, both known p and n-type dopants (boron and phosphorus respectively) have energy levels deep in the energy bandgap and are not effective at room-temperature operation. AlN substrate development has been enhanced from its photonic ultraviolet (UV) applications, and its wafer diameter is already at 50 mm, but its known dopants are also quite deep in the energy levels (i.e. require a high activation energy). For the outlook towards

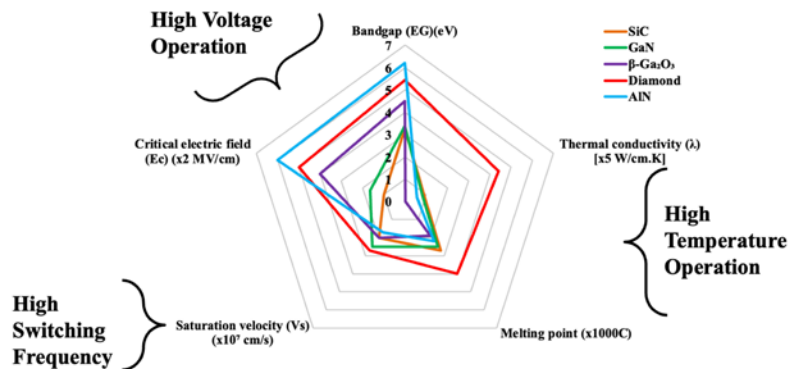

Figure 3-6 | Key physical and electrical properties of WBG and UWBG semiconductors

2030, only SBDs based on UWBG are expected to be commercially available before 2030, due to the above-mentioned technical challenges. In the longer term, it is expected that only unipolar UWBG power devices will be commercially available, and their configuration is the same as silicon or SiC power devices, despite their different internal structures. On the other hand, due to their large bandgaps and higher thermal conductivity, higher operating junction temperatures and higher power density modules will be possible and will lead to higher temperature die attachment materials and incorporation of higher passive elements.

3.5 Power module technologies

Before the power semiconductor chips technologies described in Subsection 3.4 can be used in a real power electronic converter, they have to be encapsulated for providing means for electrical connection, thermal coupling, mechanical assembly and generally protection against environmental impact. Due to their importance, the market for power modules will reach USD 14,8 billion by 2028, with a CAGR of 12,8% from 2022 to 2027 [93]. It has been customary that packaging improvements follow semiconductor chip developments, which could lead to advanced chips being packaged conventionally as a convenient and low-cost approach. But this could also result

in the deterioration of the operational behaviour of new power semiconductor components below what could be achieved with a package adapted to the chip technology. Regarding standardization, it is remarkable that packaging mostly relies on industry common practices, i.e. power semiconductor manufacturers will define new packages. When accepted on the market, other manufacturers often follow suit and provide second source to customers. This way an industry norm is established which in some cases is formally standardized, such as transistor outlines (TO). A vast variety of packages are required and available to cover the whole spectrum of applications and devices where they may be categorized under different platforms. For example, discrete components are typically single or dual switches in non-isolated packages, compared to modules which are isolated from the heat sink and may contain single switches or much more complex configurations. Many industry-typical power modules exist, mostly containing silicon IGBTs, diodes, thyristors or MOSFETs. They cover a broad range of current and voltage ratings to cope with various applications, resulting in considerably different sizes and assembly concepts. In many cases, commonly used circuits such as single switches, phase-legs or three-phase bridges are implemented. As modules are manufactured in volume production, they are suitable for volume

applications, but also more special applications with a low number of pieces can often efficiently use industry accepted typical modules.

In contrast, it may be technically and economically advantageous to develop specific modules which are perfectly adapted to a certain application with sufficiently high volume. Such modules often rely on some packaging platform which is flexible enough to incorporate various chips, circuits, terminal configurations, etc. Furthermore, the option exists to enhance the functionality of a power semiconductor module to a subsystem containing at least part of the required control circuitry, sensors, etc. Such power semiconductor devices are known as intelligent power modules (IPM).

The power semiconductor module technology as outlined above, together with the incorporated semiconductor chips, must efficiently fulfil the requirements imposed by the respective application with its mission profile. This does not mean only that the module makes it possible to exploit the full potential of the chips. The package itself is also mostly decisive regarding component reliability, for example, for chip protection from harsh environmental conditions such as humidity and when exposed to thermal cycles or load cycles. Consequently, appropriate methods to describe the respective requirements of the application are necessary, as well as a suitable qualification of the devices, including accelerated tests. In this way, a proper design-in can ensure that a power semiconductor component can be expected to reach the lifetime required in the application without oversizing or unnecessary expense.

3.5.1 Typical outline of general-purpose industrial power modules

The first power module was introduced in 1975 to host thyristor-type power semiconductors. When IGBTs started to rapidly replace thyristors, most

power modules were based on IGBT/diodes (or MOSFETs for applications with voltage ratings <200 V). In the last 10 years, power modules based on SiC MOSFETs have also been introduced on the market. Today, power module ratings range from 50 A to 3 600 A, and 200 V to 6 500 V.

A typical cross section through a power module is shown in Figure 3-7. Power modules are relatively large as defined by the surface of the semiconductor they host (plus some additional area for the connectors and for routing the control/sensors signals), and by the electrical insulation constraints dictating separation between connectors and package height. Because power modules experience harsh thermal cycling, their materials must be chosen with special care regarding properties such as their coefficient of thermal expansion (CTE) or Young's modulus. In principle, two insulation barriers are required: one at the substrate level, to insulate chips from each other and from the baseplate, and one encapsulant which seals the electrically active parts. Typically, a ceramic (aluminium oxide (Al_2O_3), AlN, silicon nitride (Si_3N_4) with direct copper bonding (DCB) is used as a substrate, as these materials offer both good thermal conductivity and dielectric properties. The encapsulant can be a silicone gel or a resin. Copper and aluminium can be used as an electrical conductor. The baseplate can be copper or an Aluminium-SiC composite (AlSiC) to better match the CTE of AlN substrates. Finally, manufacturing technologies must be selected carefully to ensure reliability, mass production, cost and regulatory compliance, for example, with the European Union's RoHS directive (Restriction of Hazardous Substances in Electrical and Electronic Equipment), especially regarding phase-out of lead.

Reliability and lifetime appear to be the main concerns for power modules, as they may form part of systems that will be operating for 30 years or more. Technologies offering high reliability include Si_3N_4 substrates, silver sintering die

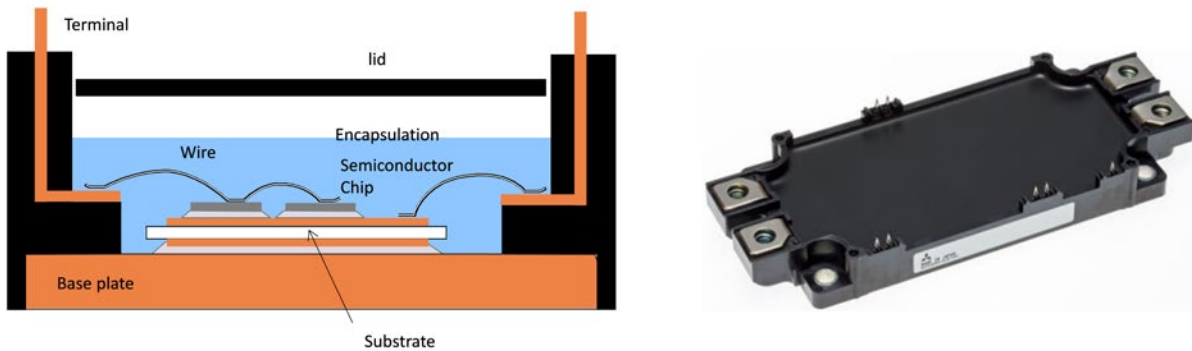

Figure 3-7 | Representative insulated module cross section and standard dual module outline⁶ for low to medium power applications

attach, improved topside interconnects (although none has yet reached a wide acceptance: bond buffer with wire-bonds, sintered/pressed foil, sintered clip, etc.) and resin encapsulation. So far, standardization of power modules has focused on test methods and reliability procedures applied to industry-typical outlines (to allow multi-source purchase). Various standards exist which basically can be applied to test power semiconductor modules. It has however become obvious that some of the standards are too general to achieve reproducible results that are relevant for the application when performing reliability tests with power semiconductor devices. Furthermore, the original Automotive Electronics Council (AEC) standard for automotive semiconductors did not cover power modules, but only discrete devices and ICs, which is why e.g. AQG 324, *Qualification of Power Modules for Use in Power Electronics Converter Units in Motor Vehicles* has been established.

3.5.2 IPM and application-specific power modules

The IPM concept was introduced in the 1980s [94], comprising an integrated dedicated gate driver and protection circuitry along with power semiconductor devices (silicon IGBTs and

diodes). The optimized power module structure provided a clear added performance leap in terms of easing usability in applications and reliability improvement of applied power electronics systems. The total global market for IPM products was estimated at USD 2 billion in 2021 and is expected to reach more than USD 3 billion by 2030. High performance IPMs have been applied in inverter-driven consumer and home appliances due to the advantages explained in Table 3-1. Such IPMs use mounted power semiconductor devices or transfer mould construction and achieve smaller size by using high thermal conductivity insulation sheets.

The inverter-driven appliances adopting IPMs have contributed enormously in terms of energy savings and reduction of GHG, especially CO₂. For example, an estimation shown in Figure 3-8 shows the saved electricity and CO₂ emission reduction achieved cumulatively by high performance IPM-applied residential inverter air conditioners (RAC) installed worldwide since the late 1990s. Recently, further innovations were launched in products:

- direct-fin-attached type power modules providing dramatic improvement in thermal conductivity and system cooling design;
- a highly integrated smart module concept combining almost all functions of an inverter together with its heat sink.

⁶ Source: Mitsubishi Electric

Table 3-1 | Features and benefits of IPM-based consumer and home appliances

Features	Impact
Inverter circuit mounting area reduced by 55%	Lower production costs
20% lower power losses by advanced device and circuitry designs	Quality improvement
80% reduction in the number of components	Higher power conversion efficiency
Reduction of development man-hours and resources	Improved production efficiency
40% improvement in home appliance control board defect rate	Improved development efficiency

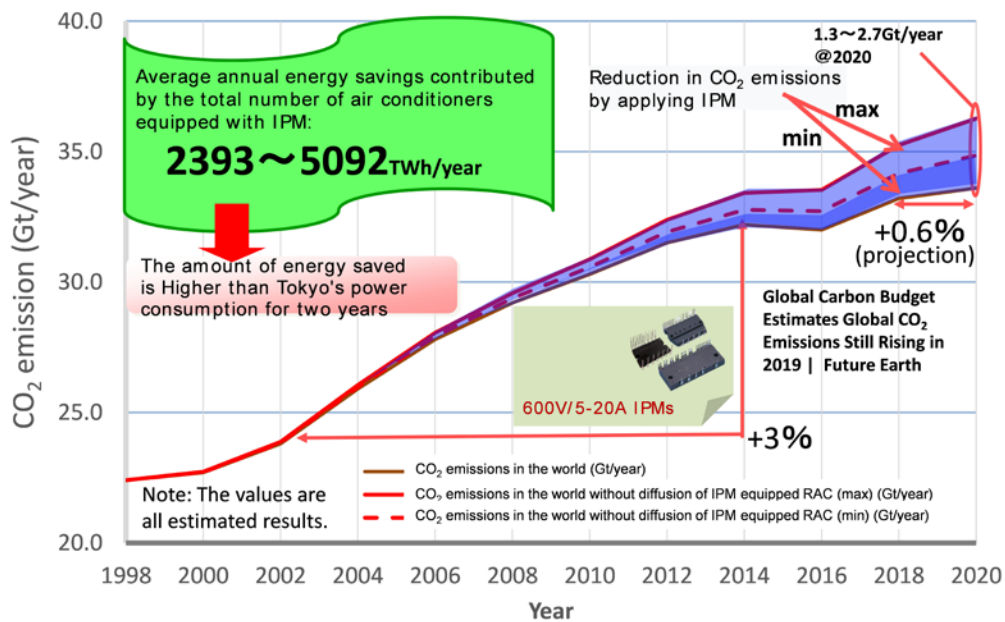

Figure 3-8 | Saved electricity and CO₂ reduction by IPM-applied inverter-driven air conditioners⁷

Note: Simulation was performed by modelling the annual power consumption per residential inverter air conditioner (RAC)

⁷ The following sources were used in the simulation: (1) globalcarbonproject.org; (2) CO₂ emission factor (kg/kWh) is estimated from IEA, World Energy Balances (2019) and other public data; (3) Units billion tons of CO₂ per year (Gt/yr). Source: Mitsubishi Electric

This trend towards integration is expected to reach a higher technological level based on the so-called application-specific approach. Either of the two broadly classified IPM platforms, the classic one and the application-specific one, potentially have many opportunities to evolve further to realize advanced power conversion solutions for an energy-wise society [95].

Integration of refined functionalities using advanced analogue and digital ICs and circuit designs for gate-driving/sensing/feedback-control/signal-interfacing/protection, as well as newer circuit isolation techniques, will combinedly form another frontier of the IPM's evolution in the coming decade and beyond. The 3D-packaging concept capable of embedding power chips and peripherals in a multi-layered well-insulated and thermally managed structural concept is expected to constitute a sustainable and synergic technology base from which to evolve IPMs for the future.

3.5.3 WBG power modules

WBG power semiconductor chips have reached high levels of electrical performance, and although some reliability issues remain, with further improvements expected, the available packaging technology has become one of the most limiting factors. On the one hand, parasitic elements such as stray inductances limit the switching speed and the safe operating area (SOA). On the other hand,

the temperatures allowed in operation are limited by the packaging materials for reaching optimum thermal and mechanical properties that match the expectation of WBG power semiconductors.

In the past few years, improved electrical layout package designs that contain very low stray inductances while accommodating smaller SiC chip sizes have been implemented in the latest generation of power modules which target both silicon and SiC power semiconductors. This has enabled much improved transient waveforms with very low switching losses for applications targeting higher operating switching frequencies. The large volume and weight of a power module must also be reduced for modules designed to accommodate SiC chips in order to meet the applications' needs (higher power density, lower weight, and cost) and to reduce material use. Solutions include baseplate-less modules, resin encapsulation, organic substrates (in which a thin layer of organic insulator replaces the ceramic). As a development trend for SiC MOSFETs packaging, one can observe the development of injection moulded housing based on thick copper conductors (heat spreaders), organic insulation, and epoxy resin encapsulation (see Figure 3-9). All these elements have a CTE matching that of copper (16 ppm/K), whereas previous module concepts targeted the CTE of ceramics (<10 ppm/K), using AlSiC baseplates or silicone gel for compliance.

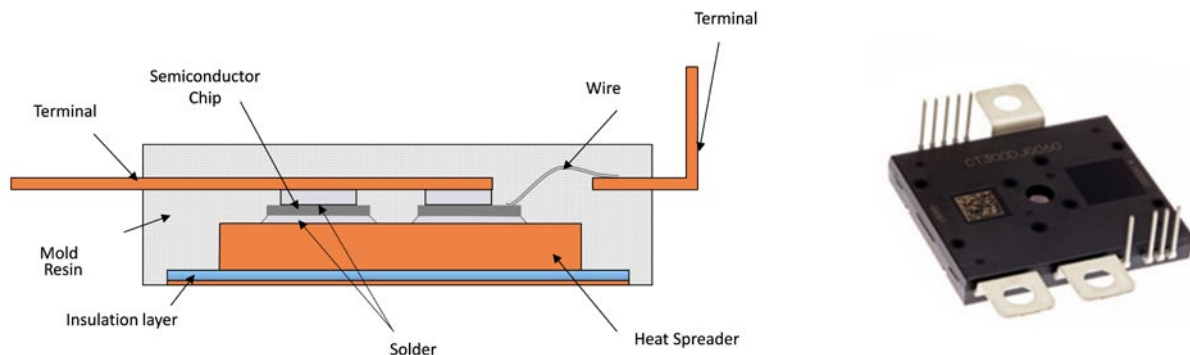

Figure 3-9 | Representative transfer-moulded WBG power module

Higher operating junction temperature operation of WBG power semiconductors (175-200 °C) is often listed as a desirable objective, especially for applications where cooling systems could be simplified to reduce weight/volume. However, this requirement impacts the module design and materials used, and more developments are needed to understand how this can be achieved while simultaneously ensuring satisfying reliability targets. To ensure device stability, the protection of SiC devices needs to be increased through the introduction of improved encapsulation materials, which provide extra protection against harsh environmental conditions such as high humidity and temperature variations. Furthermore, the implementation of SiC chips in IPMs rated from 600 V to 1 200 V and ranging from 10 A to several hundred amperes is now being commercialized. Still, power cycling for SiC MOSFETs presents various open issues which are subject to current research. There is an ongoing need to further develop standardized reliability procedures, especially with regard to power cycling SiC MOSFETs and their dependency on different applications and mission profiles.

3.6 Supply chains that support power semiconductors

An energy-wise society includes frameworks to balance supply and demand for continued market growth. The supply chain for power semiconductor devices, materials, related production/test equipment and associated products tends to be complex, long-ranging and sensitive to disturbance. To balance the supply and demand of semiconductor wafers and other essential materials, sharing of roadmaps and market forecasts among the value chain and recycling and/or re-use of materials will increasingly become the focus of efforts in the future. It must be ensured that serving the power semiconductor industry remains a sustainable business for all companies in the supply chain. The following Subsections

3.6.1 to 3.6.4 outline the critical supply chains for power semiconductor devices with respect to the different types of semiconductor materials (i.e. silicon, SiC and GaN) and the materials and mechanical parts used in power modules.

3.6.1 Silicon power wafers supply

Because of the rapid increase in demand, silicon wafers production and supply volume should be increased. For developments in the IT area, both the scaling law in device size reduction and wafer diameter enlargement have made significant contributions. On the other hand, for power semiconductors, device size reduction developments are mainly limited by thermal management. Therefore, increasing the diameter of semiconductor wafers is essential. For power semiconductor chips, not only the shape and flatness, but also the physical and electrical properties of the wafer are important and should be well controlled. Silicon wafers have been produced by epitaxy (epi wafers) and magnetic-field applied Czochralski (MCZ) processes, which are typically effective in increasing the wafer diameter, and by floating zone (FZ) processes which are effective in providing wafers with high quality material (see Figure 3-10). Because power semiconductor devices need higher quality for their performance, the quality improvement provided by MCZ, and the diameter increase allowed by the FZ method constitute the main issues today. Furthermore, for very high voltage devices in the thousands of volts, which require very high resistivity material, high quality FZ neutron transmutation doping (NTD) wafers are required. Because of the increasingly limited facility/capacity to produce NTD doped wafers, such material might be in short supply in the medium time scale, and this will become a major issue for high voltage components rated above 3 300 V, which also have high strategic importance for applications such as grid systems, renewables, railway traction and industrial drives, as outlined elsewhere in the white paper.

Wafer specifications and requirements depend largely on the power device type and its targeted breakdown voltage. For the lower breakdown voltages <600 V, MCZ and epi wafers are used. For the medium breakdown voltage >2 000 V, FZ wafers are used, and recently MCZ wafers in replacement of FZ wafers. For the higher breakdown voltages >2 000 V, FZ gas-doped and/or NTD wafers are used. In general, in order to adapt to the rapidly increasing demand in all voltage ranges, diameters are now increasing from 200 mm to 300 mm, while maintaining the high quality of the raw material. For the lower voltages, MCZ and epi wafer productivity should be improved. For the medium voltages, FZ wafers will eventually be replaced by MCZ to allow for increased wafer diameters. However, MCZ wafers contain larger amounts of oxygen and carbon impurities than FZ wafers. Therefore, it is essential that for MCZ the oxygen and carbon reduction technologies should be improved and the effects of these light elements on the device performance should be reduced at both material and chip level. For the higher voltage classes, the situation is the same as that with the medium voltage devices. In addition, the availability of NTD facility/capacity is

required ,while at the same time alternative doping methods must be found such as FZ gas-doped technology.

With Silicon wafers for IT, the standards of shape, such as diameter, thickness, etc., are already determined. In addition to the shape definition, physical and electrical quality standards are required for power semiconductor wafers.

- For the lower power devices using epitaxial wafers, standards for the resistivity measurements of epi layers are required.
- For the higher power voltage, particularly bipolar devices such as the silicon IGBTs, light element impurities, such as carbon, oxygen, and nitrogen concentration measurements are required, in particular for measuring lower concentrations of these impurities.
- Currently, minority carrier lifetime, which is used in device design, is not in the specification sheet, but it will come soon. For high power devices, the minority carrier lifetime measurements with raw materials and devices should be standardized, and the relation between starting materials and fabrication processes should be clarified.

Si power wafer diameter

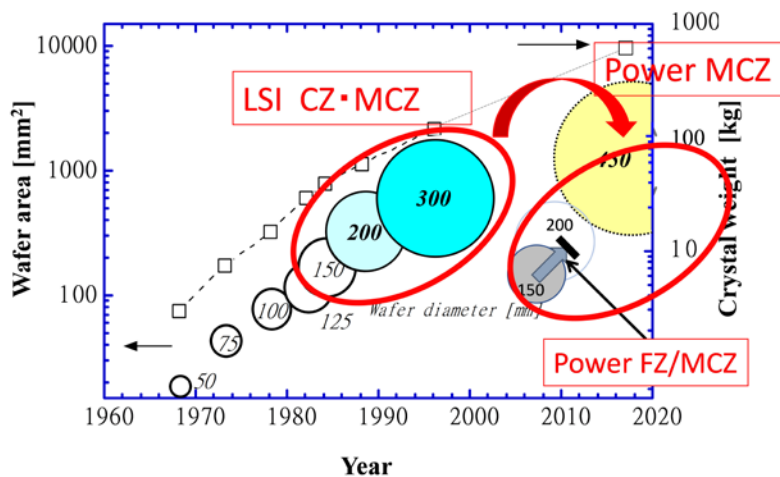

Figure 3-10 | Silicon wafer material developments

3.6.2 SiC power wafers supply

SiC wafers from single crystal material are required for the successful manufacturing of power semiconductor chips. The demand for wafers to cover the SiC market for electric vehicles (traction inverters, on-board chargers) is expected to be the main driver for market growth. The total estimated market for SiC wafers in 2027 to cover the demand across all addressable applications is expected to be around USD 1,4 billion, with a CAGR of 25% from 2021 to 2027 [96]. The addition of a high quality epitaxially grown layer is required on these SiC wafers before power semiconductors can be manufactured. By 2030, the open SiC epitaxy market size is expected to be in the range of USD 1,5 billion (although it is expected that the majority of SiC power semiconductor device manufacturers will internalize the SiC epitaxy processes in order to better control the production costs).

Today, many established suppliers and an increasing number of incumbent entrants can provide 150 mm SiC wafers in prime grade quality and at the required production volumes. One of the reasons for this is that the production process for the SiC wafers is more complex than for silicon wafers, because it requires much higher temperatures and longer growth times (typical characteristics of the standardly used sublimation-based growth processes). Wafers with 150 mm diameter are the standard today, and 200 mm is already entering the market in small volumes and is expected to become the main wafer size by 2030, whereas silicon IGBTs and MOSFETs have already been produced on a 300 mm diameter.

The process of producing SiC wafers is expensive and complex and begins with growing a crystal boule and slicing the boule to obtain thin wafers on which power semiconductors will subsequently be processed. Different types of defects are formed at the initial crystal and epitaxial layer growth step and afterwards at the wafering process which includes slicing, gridding and polishing the wafers. Certain defects present in

the epitaxial wafer can potentially still cause yield issues in device manufacturing and even during operation. However, extensive wafer screening and final testing on processed wafer and package semiconductor device levels are introduced today to eliminate fail-prone semiconductors at an early stage.

New SiC engineered substrates are also entering the market. These substrates have in common that only a very thin SiC single crystal layer is transferred onto a lower cost substrate for power semiconductor processing, or a thin active SiC device layer is transferred after processing and the remaining SiC substrate reused in the production cycle. First tests have already demonstrated very promising results on the device level. It is expected that by 2030 such technologies will contribute to easing the bottlenecks in the SiC material supply chain, help the suppliers transition to 200 mm wafers, and lower the manufacturing cost by reusing the high-quality prime grade SiC substrate multiple times.

In order to gain even broader market adoption of SiC devices, special attention must be given to reducing crystal defect levels. Different kinds of defects impact the performance of SiC power devices in many ways. For example, charge carrier lifetime is an important metric in most electronic devices and defines the extent of conductivity modulation. In SiC wafers, the concentration of defects has been clearly linked to reductions in carrier lifetime. For MOSFET devices where carriers flow in the vicinity of the surface, such as when current flow is modulated by an applied gate voltage, defects associated with the SiC bulk-silicon dioxide SiO_2 interface can determine the level of channel mobility, which is a key parameter for defining the device static and dynamic performance.

Hence, the control of the bulk SiC crystal during physical vapor transport (PVT) and the SiC epi during chemical vapor deposition (CVD) growth is key in order to minimize defect densities and to

ensure proper control of the shape and the surface flatness of the sliced SiC substrates. Other types of extended defects are known to be detrimental to SiC device reliability including micropipes (MP), basal plane dislocations (BPD), threading screw dislocations (TSD) and threading edge dislocations (TED). Micropipes in particular are killer defects which lead to a premature catastrophic device breakdown whereas BPD have an impact on the generation of stacking faults during the SiC epitaxy process, leading to a drift in the forward voltage drop in bipolar devices such as bipolar diodes and transistors. TSD and TED densities impact the reverse leakage current in SBDs. However, step-change improvements in the quality of SiC substrate and epi processes have been achieved in recent years, as typical defect densities in today's best 150 mm n-type SiC substrates are almost negligible. It is important to note that standards for SiC bulk wafers and epitaxial wafers are mandatory in order to drive competition and market adoption of the technology, and already standardization-related work is underway in various organizations such as IEC Technical Committee 47 and the Semiconductor Equipment and Materials Institute (SEMI).

3.6.3 GaN power wafers supply

GaN HEMT structures are built as multiple layers of materials using a metal organic epitaxial deposition technique on silicon substrates with a diameter of up to 300 mm. Typical blocking voltages achieved currently are up to 650 V, with 900 V and even 1 200 V rated GaN power semiconductor devices in development. In the medium term up to 2030, the inherent mismatch of lattice constants and thermal expansion coefficients between GaN and the silicon substrate will constitute a natural limitation to this material in terms of scaling to increasing blocking voltages. The market for GaN power wafers is expected to reach up to USD 115 million by 2027 at a sustained CAGR of about 58% from 2021 to 2027, driven by applications such as

consumer electronics (chargers and Class D audio amplifiers), data centres/telecom, and automotive (OBC) [96]. A similar trend to SiC wafers is present for GaN epitaxial wafers. Vertical integration of GaN on silicon epitaxial technology at IDMs and foundries is a viable strategy to speed up HEMT epitaxy device development cycles and eliminate stacked margins.

3.6.4 Power module materials and parts supply

The market of raw materials for power modules is expected to reach approximately USD 4,1 billion in 2028 at a sustained CAGR of 10% from 2022 to 2028, as shown in Figure 3-11 [93]. However, the COVID-19 pandemic in 2020 and the global context from 2021 have caused serious manufacturing delays and stoppages due to the current raw material shortages in 2023, and this situation is expected to continue for some time in the future.

Packaging materials for electrical products have been regulated for environmental and health hazardous substances for 20 years, such as through the European Union's Regulation on the Registration, Evaluation, Authorisation, and Restriction of Chemicals (REACH) and RoHS. Power modules follow these regulations accordingly. As shown in Table 3-2 [93], power modules include materials such as copper, aluminium, ceramics, engineering plastics and silicone resins, as well as semiconductor chips. These main constituent materials are not listed on regulatory lists such as the EU's Critical Raw Material (CRM) list, as they are also widely used in power converters incorporating these power modules. As the demand for power modules increases, so does the competition for materials used in the power converters. In addition, new package structures and materials are being considered due to the expansion of applications, and securing raw materials is becoming increasingly complex. The underlying technology involves

2022 – 2028 POWER MODULE PACKAGING MARKET FORECAST - SPLIT BY PACKAGING SOLUTION

Source: Status of the Power Module Packaging Industry 2023 report, Yole Intelligence, 2023

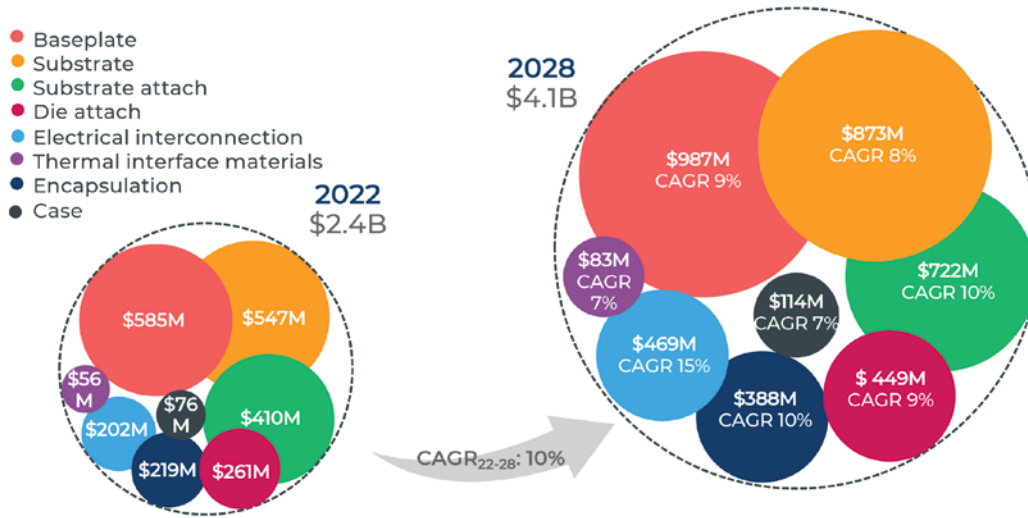

www.yolegroup.com | ©Yole Intelligence 2023

Figure 3-11 | Power module packaging market – split by packaging solution

Table 3-2 | Materials used for manufacturing power modules and their function

Module part	Material	Function
Semiconductor chip	Si, SiC, etc. with Al, Cu, Ag metallization	Conducting and switching current on/off
Silicone gel	Silicone	Protecting chips Electrical insulation
Wire bonds	Al, Al-alloy, Cu	Current flow
Ceramic substrates	Ceramics with Cu, Al	Electrical insulation Current flow Thermal transfer
Solders	Sn-alloy, Ag paste (sintering)	Mechanical joint Current flow Thermal transfer
Base plate	Cu, AlSiC, Ni plating	Thermal transfer Housing
Terminals	Cu, Ni plating	Current flow
Frame (case, cover)	Engineering plastic	Housing Holding the terminals
Thermal interface material	Grease, phase change materials	Thermal transfer

the lifetime design of power modules, and three approaches will be in focus in the next 5-10 years.

- Highly robust design: Technologies such as planar interconnections instead of wire bonds, die bonding of silver sintering instead of solder, resin encapsulation instead of silicone gel and ceramic substrates with higher mechanical strength are being put into practice.
- Highly accurate lifetime estimation: Lifetime models have been provided by fitting experimental values, but models incorporating physical properties of the material (including ageing) are beginning to be considered.
- Condition monitoring: Technology is being introduced to avoid random failures and to detect the age of deterioration and estimate the remaining service life by using various sensors and in-situ monitoring of specific semiconductor device characteristics. For example, the measurement of temperature sensitive electrical parameters (TSEP) at the gate drive level, or direct optical methods providing high time resolution and immunity against electromagnetic interference (EMI) have been introduced to detect the junction temperature of semiconductor chips in power modules during operation [97].

Until now, no relevant standards or specifications on materials for power modules have been issued because commonly used materials have been applied. Today, a more detailed database of materials is needed to improve the accuracy of lifetime models and to monitor the aging behaviour. To make effective use of this database, materials need to be classified by specifications or standards. Based on its lifetime design technology, the possibility of re-using power modules, which until now has been not possible, could be discussed and standards could be set in the long term. For newly deployed materials, a risk assessment is required. It must also be noted that materials currently in use may also become regulated due to various changes in circumstances.

3.7 Gate drivers

Gate drivers constitute the link between the microcontroller units (MCU) and the power semiconductor devices/modules. Their primary task is to convey the gate turn-on and turn-off commands from the MCU to the power semiconductor component. In addition, they often provide features to protect the driven power semiconductor against high voltage spikes during switching transients, short-circuit conditions, etc.

Gate drivers are available in various configurations as ICs or as printed circuit board (PCB) assemblies with or without galvanic isolation between the MCU and power semiconductor depending on application requirements. They are typically designed to provide a generic use in various applications, still without providing standardized approaches. This leads to incompatibilities in the hardware/software interface (HSI) when exchanging or re-using gate drivers in the same or other applications, and lack of optimized performance, protection, diagnostic, monitoring, and/or configuration features. Nonetheless, the market for gate driver ICs is expected to record a respectable CAGR of 8,5% from 2021 to 2027, reaching a total value of USD 2,7 billion by 2027 as shown in Figure 3-12 [98].

Gate drivers have been viewed for a long time as “simple” devices used to interface the MCU with the power semiconductor to be controlled. With the increasing need for more reliable applications operating with higher energy efficiency, the understanding of a gate driver has changed. Still, the utilization of modern and future gate drivers is limited due to the high diversity of interface protocols, legacy inverter infrastructures, limited space in power converters, etc. Therefore, considering the role of a gate driver already from the beginning of the design of a power module, and to a further extent the application, is vital. In addition, harmonizing the HSI will enable shorter development times and cost, and provide the way for more efficient utilization of the driven power semiconductor.

2021-2027 GATE DRIVER IC MARKET DEVELOPMENT

Source : Power Gate Driver IC report, Yole Intelligence, 2022

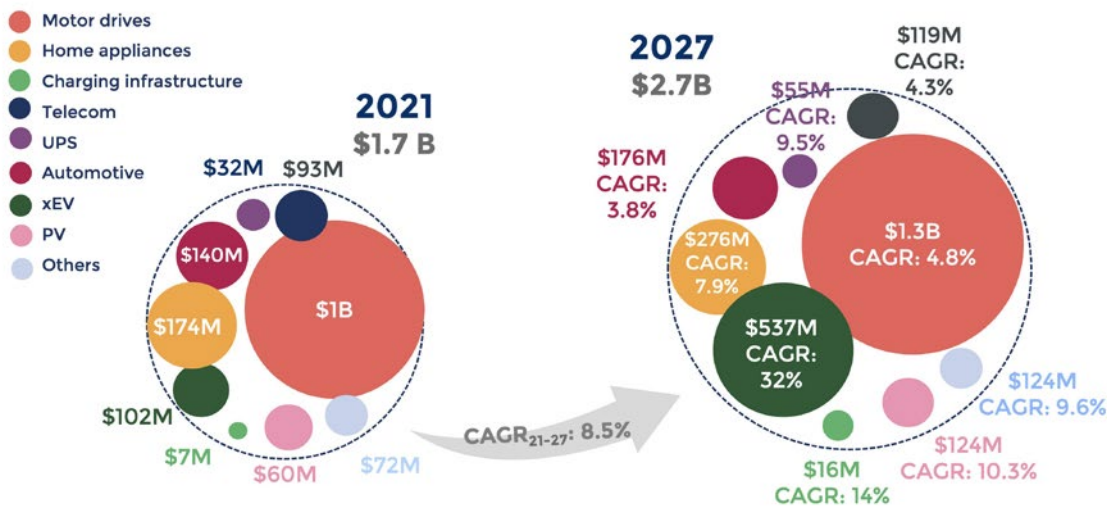

www.yolegroup.com | ©Yole Intelligence 2023

Figure 3-12 | Gate driver IC market development 2021 to 2027

The gate driver can play an important role in improving the energy efficiency and protection of power converters. Enabling gate drivers to dynamically adapt to the requirements of the applications (including the requirements given by the power semiconductor technology such as silicon IGBT, SiC MOSFET, GaN HEMT) provides switching and conduction loss reductions of the driven components. Such adaptation requires on the other hand enhanced knowledge about the specific application conditions, which could be provided by the MCU through the HSI, or the gate driver could determine these conditions on-the-fly by internal/external sensors.

Furthermore, to provide high availability of the application, the gate driver can support (together with the MCU) lifetime prediction measures, which allow adequate maintenance cycles before the application fails. Key enablers for this trend are enhanced diagnostic and monitoring functionalities:

- Harmonization of the HSI: including respecting the different requirements given by the used isolation system (monolithic level shifter, optical, magnetic, or capacitive separation)
- Guideline of diagnostic and monitoring functions based on application and power module requirements: including respecting the requirements for IGBT, SiC MOSFET and GaN HEMT devices such as switching speed, reaction time for protective functions, diagnostic and monitoring cycles, influence of parasitics (e.g. gate loop inductance, commutation loop stray inductance, etc.).

3.8 Life cycle assessment of power semiconductors and power electronics

Life cycle assessment (LCA) is a method of evaluating the environmental impacts of a product or service throughout its life cycle, from

raw material extraction to end-of-life disposal or recycling. LCA can help identify opportunities for improving the environmental performance of a product or service, as well as informing decision-makers and consumers about the environmental implications of their choices. In the case of power semiconductor technology, LCA can help assess the environmental impacts across the device's life cycle stages, as shown in Figure 3-13, such as energy consumption, GHG emissions, water consumption, resource depletion, toxic emissions, and waste generation [99] [100]. For this reason, LCA is of great importance for the formulation of governmental policies. From a purely technological point of view, LCA can help compare different semiconductor technologies or products based on their environmental performance and identify potential trade-offs or synergies among different impact categories [101]. For example, LCA can help evaluate the benefits and drawbacks of using different materials (e.g. Si, SiC, GaN) or processes for semiconductor manufacturing or packaging.

Despite the major importance of power semiconductors for an energy-wise society, they also pose significant environmental impacts across their life cycle stages, particularly during the manufacturing process, which involves complex and energy-intensive steps, such as wafer fabrication, packaging, and testing. The usage phase of semiconductor devices also consumes significant amounts of electricity through losses and generates heat that needs to be dissipated. Finally, the end-of-life phase of power semiconductors involves challenges for recycling or disposing of electronic devices that contain valuable metals and hazardous substances.

A complete LCA requires an intense breakdown analysis of each process involved in power semiconductor manufacturing, including waste of chemical and energy consumption. So far, very few

works exist on power semiconductors featuring industry data [102], which is critical for a reliable analysis.

In summary, LCA of power semiconductors will increasingly become more important for policy decision makers when establishing technology-related environmental targets; and LCA research will assist the industry to select its best environmentally friendly manufacturing processes tailored for specific applications to fulfil such policies. By expanding the scope of LCA to a system level, the environmental impact of different power converter applications can be assessed. It is also possible to develop an eco-design approach for power converters with technologies capable of reducing the environmental impacts. Scenarios involving a circular economy can be established by setting up precise maintenance (with self-diagnostic functions), recycling, and reuse of components in power converters, combined with modularity [103].

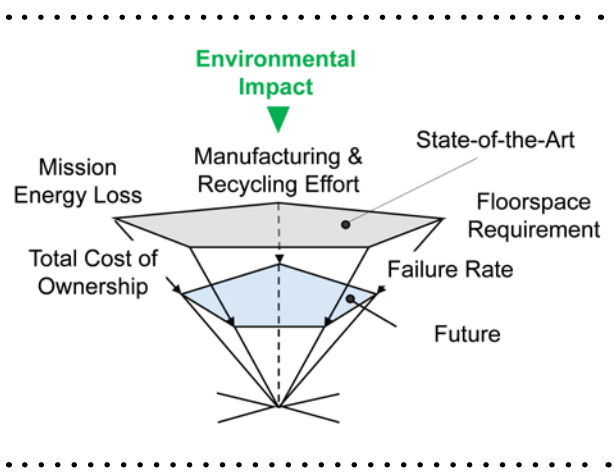

Figure 3-13 | Energy electronics systems performance parameters and trends⁸

⁸ Image from reference [99].

Section 4

Standards needs for power semiconductors for an energy-wise society

Different standard-related activities are needed to support the emergence of the aforementioned newer technologies. Standards should be based on well-proven quantifiable methods and processes and should address commercial needs, while not being defined too early in the technology life cycle.

Standards must accommodate an increasing number of power semiconductor products needed to meet tightening application performance targets and ever-expanding application diversity. Finer gradation in semiconductor product parameters, such as voltage, module variations and increasingly customized or configurable features, is required to achieve faster time to market and shorter design and development cycles for end systems.

Standards must enable the reliable application of power semiconductors with continuity of supply. However, a plethora of specific application rules and guidelines, such as derating across various mission profiles, can lead to increased semiconductor costs due to extensive qualification procedures that also result in longer time to market. An increase in the number of semiconductor products tailored for all of the various applications could also represent a challenge for a semiconductor supplier to manage and for end users seeking to select an appropriate product. Ultimately, this situation could prevent the transition towards an energy-wise society.

Recent activity involving wide bandgap power conversion semiconductor standards early in their technology life cycle has demonstrated that standards can accelerate market growth. Worldwide collaboration has led to harmonization

and rapid creation of new standards. Due to the availability of the standards, more semiconductor suppliers understand evaluation and reliability requirements, and test, reliability and process equipment suppliers understand what is needed from their equipment. The result is faster time to market and increased supply availability. However, current standards do not address the breadth of possible application-specific requirements, nor conquer the pervasiveness of legacy guidelines and derating rules, which may not be applicable to modern semiconductors, especially wide bandgap semiconductors.

The availability of standards which enable market growth and speed, rather than serving as roadblocks and impediments, ultimately constitutes the basis for providing solutions and technology for the energy-wise society. Standards need to enable product diversity and volume. Finding a new way for standards to enable increasing diversity and volume of power semiconductor products and applications represents the biggest and most challenging need. Such a standards methodology needs to amount to more than just a table compilation of mission profiles. In addition, standards need to educate the marketplace to the fact that the more specific the product, including specificity due to its qualification, the greater the issue of continuity and availability of supply. On the other hand, the broader the design and qualification processes, the longer it will take to design and release to production a semiconductor product.

4.1 The present state of affairs

Lack of harmonization of standards could impede the transition to an energy-wise society, as discussed above. Standards may come from a variety of organizations, such as IEC, JEDEC, Underwriters Laboratories (UL), the Automotive Electronics Council (AEC), JEITA, etc., but other stakeholders play an equally important role in the process, for example industry organizations or professional associations and also universities, as shown in Figure 4-1. Only when all involved stakeholders are aligned regarding the scope of the technical regulatory framework does the possibility of reaching a standard become more realistic. Sometimes, to accelerate the process, only a certain number of stakeholders will coordinate to the point of agreeing on industry specifications and guidelines that could later be considered as inputs for the standardization work. One of the main goals of the white paper is to increase the overlap areas between various stakeholders by ensuring increased awareness of the topic and increased coordination.

An additional concern is the somehow limited number of expert resources currently involved in the development of standards for power semiconductor devices. Within IEC Technical Committee 47: Semiconductor devices, 2 of its 21 workgroups focus solely on power semiconductor devices (see Annex A). To increase the number of standards requires more people are involved within those workgroups and the number of projects is increased.

Leveraging all the existing standards or guidelines and educating the community of experts about their availability could alleviate some of the current concerns. As shown in a recent presentation, a field citation ratio analysis of publications demonstrated a higher citation rate for papers citing JC-70 and JEDEC-related publications and articles [104]. This demonstrates the importance that the scientific community, not just the marketplace, places on standards related to wide bandgap power conversion semiconductors. In the marketplace, system level customers are also increasingly interested in new semiconductor standards,

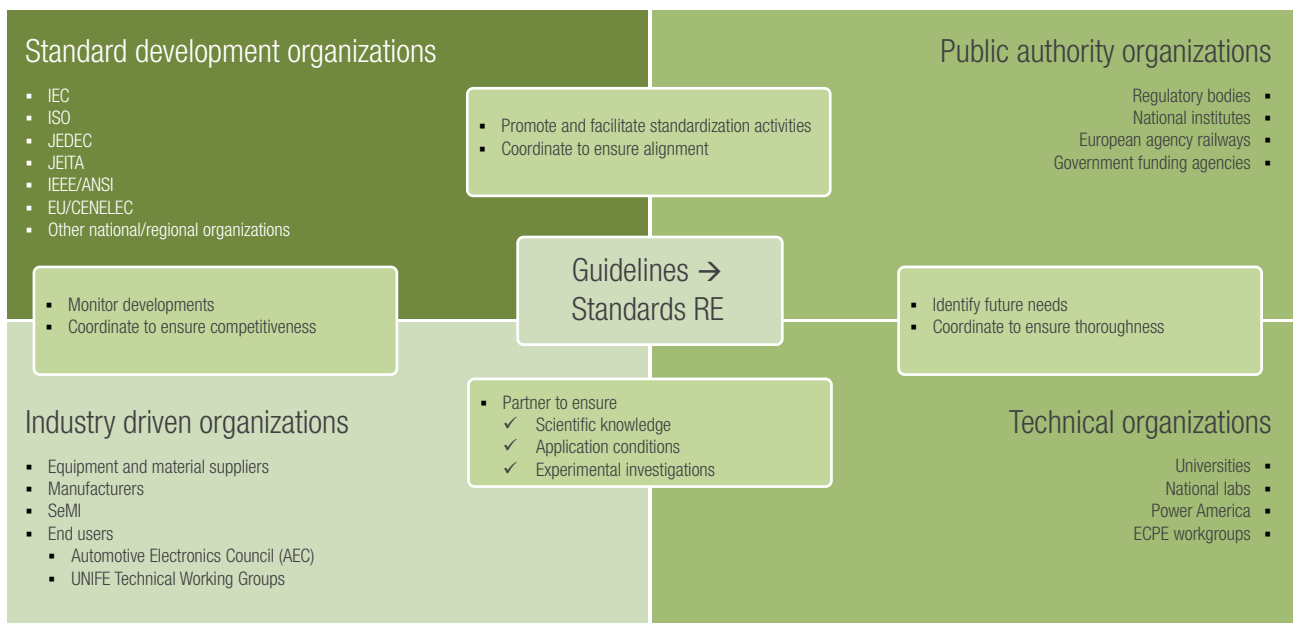

Figure 4-1 | The complex ecosystem of stakeholders involved in standards development with examples for each type of stakeholder

are encouraged to know that standards work is taking place and may even push for standards (i.e. modules) to establish multiple sources and ensure application design compatibility. Existing standards include detailed test methods and qualification/reliability procedures and cover a wide spectrum of topics, from materials to device-related tests. To raise awareness among the community of experts, Annex B contains links to find existing power semiconductor related standards.

4.2 Future standards needs

Whether a technology area is ready for standardization depends on its position in the technology lifetime maturation curve. In order to achieve a first technically justifiable consensus, the use of guidelines instead of standards is strongly recommended for emerging technologies. This approach creates initial acceptance between stakeholders and can speed the emergence of new standards. The focus of future standards should be on aspects such as:

- working around an increasing number of products in the market;
- suitable test methods for new technologies that consider physical effects not encountered in traditional power semiconductor devices;
- avoiding the performance of long-term reliability and qualification procedures by multiple customers, i.e. minimizing the total number of tests across the industry value chain;
- including power/temperature cycles as application related device specifications;
- verification of model parameters for lifetimes tests based on acceleration models;
- considering modelling/design cycles: need for unified device models operating across various circuit simulation platforms, digital twins, and digital data in general (such as internet-based product selection tools, etc.);

- standards being potentially driven by ecosystems/applications rather than measurement methods and qualification procedures.

New standards should aim to achieve as many benefits as possible: support industry cost reduction efforts, reduce time to market, increase market acceptance, foster competition, and enhance the availability of customer choices in terms of suitable suppliers/products. New standards should consider a minimalist approach based on needs: no excessive language or features should be included, otherwise there is a risk of limited adoption and increased costs of compliance.

4.3 Filling the void of power module standards

For cost reasons, power semiconductor modules are rarely hermetic (whereas some integrated circuits are), but are usually made from plastic and do not prevent the intrusion of humidity. Therefore, humidity-driven degradation of the devices is a permanent threat and requires respective qualification tests. In the past, even high voltage devices were tested at a maximum of 100 V, although 80 V may have been more common. Possible reasons behind this value include high leakage of the power devices leading to self-heating and driving the moisture away from the chip, and because the involved electrochemical issues were suspected to saturate anyway.

In recent years a clear acceleration of the above effects by means of increasing voltage has been proven [105] and it is now generally accepted to test power semiconductor devices at 80% of their nominal voltage together with 85% relative humidity and 85 °C. The so-called high humidity, high temperature and reverse bias (H³TRB) with high voltage applied (HV-H³TRB) reliability test procedures were initially developed for rolling stock applications and became a widely accepted industry guideline. Subsequently, this led to

substantial progress being made on the humidity-resistance capability of power semiconductor devices by means of junction termination layout and passivation layer design [106]. Power semiconductor devices could also be tested under H³TRB conditions to less than 80% of their nominal voltage, if limited by the spacing between the lead pins of their layout. Therefore, the test conditions should be clearly defined in the product datasheet.

Although HV-H³TRB provides strongly accelerated testing, its continuous stress does not resemble volatile field conditions, which might lead to issues due to extreme humidity or even condensation compromising the insulation capability or the junction termination not being able to cope with humidity during steep voltage transients. Such conditions must be covered by accelerated testing as well. Furthermore, the most critical conditions and the acceleration might be different from device to device and for a particular degradation mechanism.

A priori, it remains unclear for a particular power semiconductor device, which mechanism is lifetime-limiting, and thus, a standard for reliability stress procedures has to be established, which covers a wide range of stress conditions and is still strongly accelerated. Currently, complex stress scenarios adapted from system level testing are under discussion. Such procedures combine high humidity levels, temperature changes and intermittent switching operation with steep voltage transients but without generating high switching or conduction losses. In some applications, the high humidity levels combined with temperature changes lead to condensation on the external contacts (pins) of power devices and modules. Such conditions also drive package and board assembly solutions that are more expensive to handle these difficult pollution levels.

Technical requirements and performance evaluation standards of power modules in applications need to be formulated. Power cycling has already been a topic for decades, but the data of different power

semiconductor manufacturers are still difficult to compare, and the real application conditions are difficult to fit with the stress conditions. Further guidelines for qualification procedures of new semiconductor chip and module technologies should be adapted for application-specific functional requirements and for new functions, e.g. insulation requirements in traction or cosmic ray withstand capability. Standardization of power cycling curves and application notes on how to use these for an extremely high number of very low ripples, including complex load profiles, would be also required.

The request for standardization of some power module features can be discussed with respect to power module level, but also at a power electronic level (including electrical and mechanical contact interfaces of power semiconductor modules with cooling systems, DC-link capacitors, gate drives, current- and voltage sensors, controllers, etc.) Standardization of power module footprint and/or position of external terminals may be desirable in some, though not in all, industries. Standardization of an entire module layout is relatively unlikely to occur due to the following reasons:

- a paradigm shift in the power semiconductor industry would be needed. Currently, each manufacturer follows slightly different optimization and customization criteria for its power module products. At the same time, the power electronics industry will likely consider established module designs until innovative products have achieved sufficient market acceptance;
- it may limit innovation especially in early stages of a technology life cycle;
- it may retard the deployment of newer technologies in highly demanding/high-volume applications looking for customized solutions, such as automotive.

For power semiconductors used in heating/AC/appliances, the opportunity may exist to further discuss the standardization of IPM platforms defining structural features (footprint, external terminals, insulation, etc.), integrated functionality (digital/analogue/hardware/software, etc.) and input/output interfacing requirements.

4.4 Standards required for WBG materials

Wide bandgap-based power semiconductor devices, mainly those using GaN or SiC as base material, are becoming increasingly present in modern power conversion systems due to their energy, volume, and weight savings potential. Initially, existing standards historically developed for silicon-based power devices have been applied for testing and qualification of related WBG products.

In many cases this approach is justified, primarily if similar failure mechanisms are in place or if stressed reliability aspects (e.g. insulation robustness of power modules) are only partially or indirectly impacted by the actual semiconductor chip technology. However, a couple of obvious factors as well as more than 20 years of field experience are driving the development of responses to address various wide bandgap-specific needs.

These needs can be grouped as follows:

- Material-specific phenomena to be addressed/verified /tested, e.g. dynamic on-resistance effects in GaN HEMTs or bipolar drift effects in SiC MOSFETs.
- Operating mode-specific aspects, e.g. extreme dv/dt slopes in connection with high voltages or the combination of high voltages with high switching frequencies.
- Material-property driven aspects, e.g. operation at approximately 10 times higher internal electric fields, which determine the stability of edge termination and passivation

materials or impact oxide reliability in blocking mode.

- New stressing and testing approaches which address either new degradation phenomena as mentioned above or respectively analyze effects which are negligible in silicon devices but are relevant for WBG, such as threshold voltage hysteresis or threshold voltage drift triggered by switching instead of steady state stress.

These needs were formulated already approximately 10 years ago, leading specific JEDEC working groups to address these WBG-specific aspects. Currently, work is ongoing in those groups as well as in other organizations such as IEC, AEC, the Japan Electronics and Information Technology Industries Association (JEITA), the European Center for Power Electronics (ECPE) with its Automotive Qualification Guideline (AQG), the Semiconductor Equipment and Materials Institute (SEMI) and in various national/local standardization initiatives, and it will become mandatory to continuously screen the technology and the field for new findings falling into the categories mentioned above. On the other hand, duplication of procedures which have been developed for traditional power semiconductor devices and are still applicable should be avoided. Here it might be sufficient to check for acceleration models allowing extrapolation from lab tests to the actual behaviour in the field.

4.5 Standards for meeting future, user-driven changes

The severity of power semiconductor standards for automotive grade products, industrial grade products and consumer grade products differs widely. The specific requirements vary from application to application. Examples of specific requirements are as follows:

- Test items should be more comprehensive, and stress conditions should be higher: many applications in an energy-wise society have long life expectancy and are subject to harsh environmental conditions such as high/low temperatures with rapid temperature changes, high humidity, and severe vibrations during operation. The test items and stress conditions are much more demanding than the requirements of consumer grade power semiconductors.
- Failure criteria should be tightened. In general, various electrical parameters of power semiconductors drift under stress conditions (such as in reliability procedures). The drift of any electrical parameter should be such that at the end of the semiconductor's lifetime the parameter value is still within the min/max values as specified in the datasheet. Some industries, such as automotive, may require tighter power electronic system design rules and therefore will not allow for large drifts in electrical parameters over the lifetime of a car (minimum design life of the car is 15 years). Understanding these requirements and having access to power semiconductor datasheets/specifications that refer to additional limits on such drifts or to extended test methods may be important needs in such industries.

In order to meet the requirements of preserving resources, saving on costs and improving the utilization rate of power semiconductors, when developing standardization work it is necessary to consider the possibility of power semiconductors changing their application requirements and modes in response to different application scenarios in the present and future, so as to supplement and expand the existing product standards for automotive, rail, renewable energy and other applications. One prominent example is in the field of SSCB or electronic fuses, in which power semiconductors are subjected to a completely different mission profile – usually few turn-on/

turn-off events over the lifetime – compared to traditional switched power semiconductor devices experiencing almost continuous turn-on/turn-off events. Although initiatives concerning SSCBs are ongoing both in IEC (IEC 60947-10) and UL (UL489I), both are derived from standards for electromechanical breakers, which are mainly intended for AC applications. A lack of suitable standards is one of the main reasons why there exist neither product standards nor system standards (safety rules, installation rules, etc.) clearly intended for DC applications. This lack is limiting the development of the DC distribution networks business.

Meanwhile, it is necessary to clarify the technical requirements and stress procedures pertinent to power semiconductors under specific application conditions, in order to support the diversified application requirements of power semiconductors. Such new standards to be developed should observe the following guidelines:

- Be based on various application conditions, such as automobiles, rail transit, renewable energy, etc. In the process of developing standards, application condition research should be carried out to establish a standard working condition model or special application working condition model for specific applications. At the same time, testing, verification, and validation must be carried out.
- Provide life cycle assessment models and prediction methods based on specific application conditions. Relevant application conditions should consider the power supply characteristics, load characteristics, climatic environment, electromagnetic environment, mechanical environment, etc. for the application device, with the climatic environment including but not limited to high temperature, high cold, high humidity, high radiation, high temperature difference, dust, rain, salt spray corrosion and other characteristics.

- Be considered to meet the current applications and future expansion applications, and meet the test evaluation needs of power semiconductors in the application of new technology development trends and new application scenarios in the energy-wise society.
 - Cover secondary or potential unintended use, i.e. diversion from originally intended products or applications, although this can result in longer semiconductor product qualification time or cost.
 - Consider the power electronic equipment and system design specifications, including power semiconductors, and present the performance requirements and evaluation methods of the power semiconductors for the applications. Also, standardization to define the energy losses in real operating conditions might have meaning in the future.
- assessment being considered already at the design stage.

A few other aspects could be relevant to future standards. For example, the hardware/software-interface (HSI) of the power electronic converters should be considered for standardization, so that systems from different manufacturers can be easily interchanged and their operation properly coordinated. This type of interoperability will be particularly crucial for the stable operation of power electronics-dominated power grids. The grid codes required for this interoperability must be further developed regarding power grids based exclusively on power converters that do not have an inertia contribution from traditional generators.

Last but not least, sustainability aspects are impacting all technologies and businesses today and will continue to do so in the future, and power semiconductors are no exception. With the large variety of materials and manufacturing processes involved in modern power semiconductor devices, it may be valuable to consider standards that support the recycling of the materials at the end of their operational life, as well as life cycle

Section 5

Conclusions and recommendations

Throughout the previous sections, the white paper has revealed the significant roles that power semiconductors play as the cornerstone for achieving an energy-wise society. Succinctly, an energy-wise society cannot be realized without the next generation of power semiconductors waiting in the wings to be deployed.

The white paper aims to instil a belief in the promise of power semiconductors as the key technology to be pursued and spurred by clean energy investments. Moreover, the white paper also reveals that an enormous and committed effort will be required to realize an energy-wise society that enables the achievement of the net zero vision by 2050. To ensure that an energy-wise society is ultimately attainable, end users, suppliers and regulators must join in aligning their respective efforts, including actions related to balancing the demand and supply of power semiconductors, to cite one underlying and current challenge.

The rewards of alignment, as well as the risks of failing to align efforts, highlight the paramount role of standardization bodies including the IEC and other standards developing organizations (SDOs) for reaching a consensus within the power semiconductor industry.

With this background in mind, the white paper is issuing the following realizable and practical recommendations intended for the key players and stakeholders of our future energy-wise society.

5.1 Recommendations addressed to policy makers and regulators

If society as a whole is to meet its decarbonization and digitalization commitments, the electrification of power grids, industry, transportation and other aspects of daily life needs to accelerate dramatically. The transition to an energy-wise society requires a massive growth of the power semiconductor industry that will support the megatrends of electrification and carbon-free energy generation, but such developments will require an extended period of time and continuous investments. For reference, it can take 3-5 years from the start of designing a new processing facility for power semiconductors to qualifying the first products emerging from this factory.

Strategic support through regulation and subsidies would have positive effects throughout the industry value chain. It is thus imperative to focus on finding and triggering the most effective economic tipping points in as timely a manner as possible. For example, these could be subsidies or other forms of financial assistance to promote:

- the market uptake of more efficient home appliances and air-conditioning units in developing countries;
- regulations requiring higher energy efficiency to increase energy savings in industrial applications and buildings;
- the expansion of fast charger networks for electrical vehicles;
- regulations targeting the more widely spread use of life cycle costs in VRE railway applications to encourage the roll-out of newer

generations of converters with WBG power semiconductors;

- the fostering of strong and dynamic ecosystems that include academia, start-ups and established industry which would go a long way towards accelerating technology developments and their successful and timely deployment in the market.

Support is also needed to accelerate the roll-out of advanced power semiconductors and demonstration projects using such semiconductors, to leverage private investment in R&D for power semiconductors, and to boost overall deployment levels to help reduce the costs of these advanced technologies. A more balanced funding strategy and adequate investments are needed to encourage the development of the full spectrum of the power semiconductor industry across all value chains and materials (silicon and WBG-based), taking into account the short time-driven economic and environmental impacts, in addition to the maturity levels of a technology.

More importantly, the policy makers and regulators must recognize the key role of power semiconductors for an energy-wise society and provide at least a similar level of importance and commitment compared to other semiconductor technologies which also address essential societal challenges.

The accelerated growth in the power semiconductor industry is also engendering a lack of experts, and this will likely require expanded educational programmes targeted at semiconductor engineering/manufacturing (at all levels from high school to academia) and awareness campaigns to attract more engineering talents to this industry.

As power semiconductors require special materials for manufacturing (from high quality single crystal wafers to rare gases and precious metals), policy makers and regulators must also pay close attention to supporting the development of a

robust supply chain, in order to avoid bottleneck situations in the future, which will ultimately disadvantage the transition to an energy-wise society.

5.2 Recommendations addressed to the industry

Industry should continue an engaging, inclusive, and open communication approach, while pursuing a standardization strategy that distinguishes needs at a material, power semiconductor devices and power converter systems level. Such an approach is needed in order to successfully address the complex industry landscape. Robust standards should be industry-driven, and when it comes to power semiconductor modules, clear market incentives should be visible for investing significant time and resources in standards activities to ensure that large and small customers alike are served with power semiconductor products that fit the application requirements in terms of performance (incl. reliability), cost and long-term availability of replacement parts. For example, customers with high volume business may afford customized/ one-off type power semiconductor devices optimized for their applications. Such customers will also reach the price levels they are requesting due to the high volume of purchase. However, many more customers and their applications require smaller volumes of products and will not be able to afford customized power semiconductor devices. Access needs to be ensured for such customers to the right technology, at the right price and to replacement parts over the coming decades. Thus, not only test methods and reliability/qualification procedures should be considered for standards but also as many features of power semiconductor devices as feasible.

The industry needs to transform itself to become more transparent and forward-looking concerning its environmental impacts and recycling goals, as well as more sustainable in the long term.

Additional educational and awareness raising programmes ranging from power semiconductor design to manufacturing technologies are needed in order to inspire new generations to join the industry. This will help alleviate an expected shortage of qualified experts in the coming decades.

5.3 Recommendations addressed to the IEC and other standards developing organizations (SDOs)

Balanced participation and adequate industry engagement is required throughout the standardization process. The IEC Standardization Management Board (SMB) plays a clear role here in initiating the appropriate discussions on standardization strategy and the division of roles and responsibilities among IEC TC 47 and other existing technical committees. It is important for SDOs such as IEC to engage a diverse representation of industry and academia and obtain the appropriate input early and in a balanced manner based on a variety of factors, such as position in the industry value chain (e.g. suppliers of materials, manufacturers of power semiconductor devices, manufacturers of power converter systems, and even end users).

More specific recommendations to the three IEC Boards are included in the white paper, as follows.

For the Standardization Management Board (SMB):

- In keeping with the goals of the IEC Strategic Plan, it is recommended that the SMB consider broad and high-level approaches for realizing an energy-wise, all-electric society through ad hoc group AhG 95: All-electric and connected society, and its successor, as well as new bodies dedicated to expanding and advancing such work.
- It should be further evaluated how to ensure that SMB provides high level management guidance

and focus on the accelerated development of standards for power semiconductor devices, while relying on potential synergies but also differences between the activities of TC 47/ SC 47E/WG 3 (which address standards on discrete power devices and are semiconductor material agnostic) as well as those of TC 47/ WG 8 (that address standards specific to wide bandgap semiconductor devices due to their unique properties or applications).

- It is also recommended that the SMB request TC 47 to establish a task force to formulate additional guidelines or roadmaps for the development of power semiconductor standards through discussions that align device, system, and application level needs. Besides the relevant working groups/ subcommittees with TC 47, this new task force should consider engaging IEC TC 22: Power electronic systems and equipment, TC 121: Switchgear and controlgear and their assemblies for low voltage, and other relevant IEC committees.
- The task force should also proactively coordinate and collaborate with other SDOs (JEDEC, JEITA, UL, etc.) and with industrial and academic forums to produce a comprehensive, robust, and consistent set of standards to serve the global power semiconductor industries. The absence of such coordination will inevitably lead to multiple and competing standards that confuse and fragment the market, burdening suppliers and users with the need to maintain compatibility across multiple formats.
- The task force should leverage already existing coordination and collaboration that exists and that resulted in the formation of JEDEC JC-70 Committee and IEC TC 47/WG 8. The task force should supplement these existing relationships in a manner to increase the productivity and relevance of standards creation.

For the Conformity Assessment Board (CAB):

- It is recommended that CAB/WG 14: Promotion & marketing, consider strengthening its role in the development of power semiconductor device standards by engaging with the SMB SG 14: All-electric and connected society (AECS), (or its successor) and the task force led by TC 47.
- It is further recommended that the CAB establish communication channels with authorities and regulators to actualize global acceptance of the IEC Conformity Assessment Systems being pursued by IEC-registered bodies for power semiconductor device standards.

For the Market Strategy Board (MSB):

- That it continues to investigate market, technological, and social trends and provide input to the SMB and CAB via the inter-board market evaluation form (MEF) touching on noteworthy changes in these areas as they relate to power semiconductor devices.
- That it strengthens knowledge-sharing with organizations that are collecting and analyzing information about the new WBG-based power electronics, coordinating internationally acceptable approaches that promote WBG-based power electronics, and developing greater understanding and action amongst governments and policy makers, such as the Power Conversion Technology Annex Platform (PECTA) part of the International Energy Agency (IEA) Technology collaboration program 4E.
- Work via a permanent scheme of direct collaboration with the SMB and the CAB in order that the three IEC Boards can systematically share knowledge on the quest to an energy-wise society.

Annex A

IEC TC 47 organizational structure

This is the detailed organizational structure of IEC TC 47, which focuses on standards development for semiconductor devices. Just two of its many working groups pursue a special focus on power semiconductor devices, although these

semiconductors play a key role in an energy-wise society. Note that other working groups in TC 47 may produce guidelines relevant for power semiconductors, such as TC 47/WG 2 and TC 47/WG 5 below.

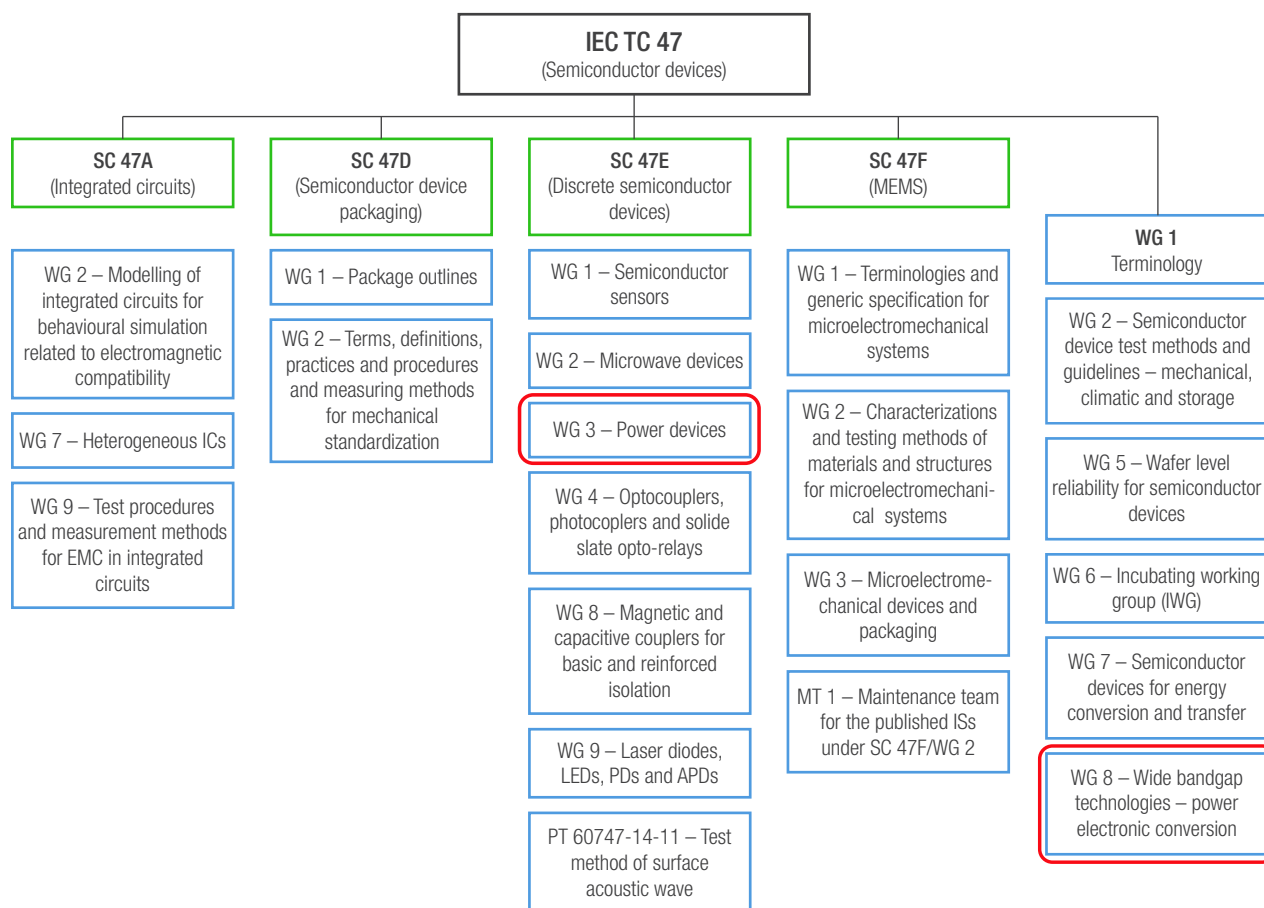

Annex B

List of existing standards or development projects for power semiconductors

At the time of publication, over 25 IEC published or active project documents are relevant for power semiconductors. Even during the writing of the white paper, new documents are published and new projects commenced. Thus, links to obtain the current state of publications and projects is provided below because this is such an active topic area with standards organizations.

B.1 IEC relevant documents and projects

To obtain the current list of IEC documents and projects, perform these following searches. “Working documents” tab lists all the documents currently under development. “Project Files” tab lists all published documents (current stage is PPUB) with a link to the IEC Webstore which allows for document free preview.

- For Silicon Carbide current active projects:
go.iec.ch/2023wptc47carbide

Note this search will pull up both wafer/substrate and device and application documents.

- For Silicon Carbide (or Gallium Nitride on Silicon Carbide) current active projects specifically aimed at wafers or substrates:
go.iec.ch/2023tc47carbidewafer
- For Gallium Nitride (which some documents have as GaN) current active projects:
go.iec.ch/2023wptc47gallium and
go.iec.ch/2023wptc47gan

Note this search will pull up both wafer/substrate and device and application documents.

- For TC 47 (includes WG 8: Wide bandgap) list of publications:

go.iec.ch/2023wptc47publications

Note you can use your browser feature to search the page for Power, GaN, Carbide, etc. to see all the current published documents.

- For SC 47E (includes WG 3: Power discrete) list of publications:

go.iec.ch/2023wpsc47epublications

Note you can use your browser feature to search the page for Power to see all the current published documents.

TC/SC work programmes:

- TC 47: Semiconductor devices,
go.iec.ch/2023wptc47workprogramme
- SC 47E: Discrete semiconductor devices,
go.iec.ch/2023wpsc47eworkprogramme
- TC 91: Electronics assembly technology,
go.iec.ch/2023wptc91workprogramme

Another search method for IEC published documents is to go to the IEC Webstore. Unfortunately, these searches can also pull up non power devices, including standards related to LEDs.

- go.iec.ch/2023wpwebstc47gan
- go.iec.ch/2023wpwebstc47sic

The webstore search go.iec.ch/2023wpwebspowersemiconductor unfortunately is incomplete and not recommended.

B.2 JEDEC JC-70 documents and projects

In addition, multiple guidelines have been created in the JEDEC JC-70 workgroup, with the goal to transfer them also to IEC. Note that JEDEC does not published current projects or work in progress on their website. JEDEC presentations however may include such information.

- JC-70 published documents can be found at:
www.jedec.org/document_search/field_committees/8676

B.3 JEITA documents and projects

In addition, JEITA has documents that are relevant for power semiconductors.

- The JEITA list of documents can be found at:
www.jeita.or.jp/cgi-bin/standard_e/list.cgi?cateid=5&subcateid=34

Some documents are available in English on this site.

Bibliography

- [1] BORDRY, F. and AGUGLIA, D. Definition of Power Converter. *Proceedings of the 2014 CAS-CERN Accelerator School: Power Converters*, vol. 3, 2015.
- [2] OHNO, E. *Introduction to Power Electronics*. Oxford University Press, 1988.
- [3] ZIO, E. Reliability engineering: Old problems and new challenges. *Reliability Engineering & System Safety*, 2009, vol. 94, no. 2, pp. 125-141.
- [4] AMSTADTER, B. L. *Reliability Mathematics: Fundamentals, Practices, Procedures*. McGraw-Hill, 1977.
- [5] IC Insights, "The McClean report 2018: A complete analysis and forecast of the integrated circuit industry", Scottsdale, AZ, pp. 5-11, 2018.
- [6] Omdia, "OmdiaPowerSemiconductorIntelligenceService" [Online]. Available: https://omdia.tech.informa.com/-/media/tech/omdia/brochures/semiconductor-components/power-semiconductor-intelligence-service-product-overview_2023.pdf?rev=5af45532cb9243a4a48017740bbfc58a&hash=B4C5F2587899AC2233D1219404779639. [Accessed: 25 September 2023].
- [7] World Semiconductor Trade Statistics "WSTS Semiconductor Market Forecast Spring 2023" [Online]. Available: <https://www.wsts.org/76/Recent-News-Release>. [Accessed: 25 September 2023].
- [8] Allied Market Research, "Power Management Integrated Circuits Market" [Online]. Available: <https://www.alliedmarketresearch.com/power-management-IC-market>. [Accessed: 25 September 2023].
- [9] International Electrotechnical Commission, "IEC Strategic Plan" [Online]. Available: <https://www.iec.ch/strategic-plan>. [Accessed: 25 September 2023].
- [10] International Energy Agency, "CO₂ Emissions in 2022" March 2023 [Online]. Available: <https://www.iea.org/reports/co2-emissions-in-2022>. [Accessed: 25 September 2023].
- [11] International Electrotechnical Commission, "Zero carbon power system based primarily on renewable energy", IEC White Paper 2022 [Online]. Available: <https://www.iec.ch/basecamp/zero-carbon-power-system-based-primarily-renewable-energy-0>. [Accessed: 25 September 2023].
- [12] Yole Intelligence, "Power SiC 2022" March 2022 [Online]. Available: <https://www.yolegroup.com/product/report/power-sic-2022/>. [Accessed: 25 September 2023].
- [13] GMD Research, "Global Electric Vehicle Power Inverter Market 2021-2031" August 2022 [Online]. Available: <https://www.researchandmarkets.com/reports/5648516/global-electric-vehicle-power-inverter-market#rela3-5574863>. [Accessed: 25 September 2023].
- [14] GMI Insights, "HVDC Converters Market" March 2023 [Online]. Available: <https://www.gminsights.com/industry-analysis/hvdc-converters-market>. [Accessed: 25 September 2023].

Bibliography

- [15] Markets and Markets, "PV Inverter Market" May 2022 [Online]. Available: <https://www.marketsandmarkets.com/Market-Reports/inverter-market-263171818.html>. [Accessed: 25 September 2023].
- [16] International Energy Agency, "Net Zero by 2050" 2021 [Online]. Available: <https://www.iea.org/reports/net-zero-by-2050>. [Accessed: 25 September 2023].
- [17] Hitachi Energy, "HVDC Light® Life Cycle Assessment" [Online]. Available: <https://www.hitachienergy.com/products-and-solutions/hvdc/hvdc-light-life-cycle-assessment>. [Accessed: 25 September 2023].
- [18] PATEL, S. "The Vital Link: How HVDC Is Modernizing the Grid" Power Magazine, June 2022 [Online]. Available: <https://www.powermag.com/the-vital-link-how-hvdc-is-modernizing-the-grid/>. [Accessed: 25 September 2023].
- [19] NISHIOKA, A., ALVAREZ, F. and OMORI, T. Global Rise of HVDC and Its Background. *Hitachi Review*, 2020, vol. 69, no. 4.
- [20] ENKHARDT, S. "Global solar capacity additions hit 268 GW in 2022, says BNEF" PV magazine, December 2022 [Online]. Available: <https://www.pv-magazine.com/2022/12/23/global-solar-capacity-additions-hit-268-gw-in-2022-says-bnef/>. [Accessed: 25 September 2023].
- [21] International Energy Agency, "Tracking Renewables" [Online]. Available: <https://www.iea.org/energy-system/renewables#tracking>. [Accessed: 25 September 2023].
- [22] International Energy Agency, "Tracking Wind Electricity" [Online]. Available: <https://www.iea.org/energy-system/renewables/wind>. [Accessed: 25 September 2023].
- [23] International Energy Agency, "Electrolysers" July 2023 [Online]. Available: <https://www.iea.org/reports/electrolysers>. [Accessed: 25 September 2023].
- [24] AEG, "Power supply solutions for green Hydrogen production" 2023 [Online]. Available: <https://www.aegps.com/en/applications/green-hydrogen/>. [Accessed: 25 September 2023].
- [25] CHEN, M., CHOU, S. F., BLAABJERG, F. and DAVARI P. Overview of Power Electronic Converter Topologies Enabling Large-Scale Hydrogen Production via Water Electrolysis, *Appl. Sci.* vol. 12, 2022.
- [26] Guidehouse Insights, "Direct Current Distribution Network Is Expected to Grow at a Compound Annual Growth Rate of 14% through 2030" 19 January 2022 [Online]. Available: <https://guidehouseinsights.com/news-and-views/direct-current-distribution-network-market-is-expected-to-grow-at-a-compound-annual-growth-rate-of-1>. [Accessed: 25 September 2023].
- [27] FALCONES, S., AYYANAR, R. and MAO, X. A DC-DC multiport-converter-based solid-state transformer integrating distributed generation and storage. *IEEE Trans. Power Electron*, 2013, vol. 28, no. 5, pp. 2192-2203.
- [28] LISERRE, M., PEREZ, M. A., LANGWASSER, M., ROJAS, C. A. and ZHOU, Z. Unlocking the hidden capacity of the electrical grid through smart transformer and smart transmission, *Proceedings of the IEEE*, April 2023, vol. 111, no. 4, pp. 421-437.

- [29] AGOSTINI, F., VEMULAPATI, U., TORRESIN, D., ARNOLD, M., RAHIMO, M., ANTONIAZZI, A., RACITI, L., PESSINA, D. and Suryanarayana, H. 1MW bi-directional DC solid state circuit breaker based on air cooled reverse blocking-IGCT, in *IEEE Electric Ship Technologies Symposium (ESTS)*, Alexandria VA, USA, 2015.
- [30] MEINTZ, A., ROWDEN, B. and BOHN, T., "Charging infrastructure technologies: Development of a multiport > 1 MW charging system for medium- and heavy-duty electric vehicles" June 2020 [Online]. Available: <https://www.nrel.gov/docs/fy20osti/76707.pdf>. [Accessed: 25 September 2023].
- [31] Society of Automotive Engineers, "Megawatt Charging System for Electric Vehicles," December 2021. Currently unavailable for purchase from SAE.
- [32] International Energy Agency, "Electric Vehicles" [Online]. Available: <https://www.iea.org/energy-system/transport/electric-vehicles#tracking>. [Accessed: 25 September 2023].
- [33] International Energy Agency, "Global EV Outlook 2023" 2023 [Online]. Available: <https://www.iea.org/reports/global-ev-outlook-2023>. [Accessed: 25 September 2023].
- [34] WANG, L., QIN, Z., SLANGEN, T., BAUER, P. and VAN WIJK, T. Grid Impact of Electric Vehicle Fast Charging Stations: Trends, Standards, Issues and Mitigation Measures – An Overview. *IEEE Open Journal of Power Electronics*, 2021, vol. 2, pp. 56-74.
- [35] DING, H., HU Z. and SONG, Y. Value of the energy storage system in an electric bus fast charging station. *Appl. Energy*, November 2015, vol. 157, pp. 630-639.
- [36] RIVERA, S., GOETZ, S. M., KOURO, S., LEHN, P. W., PATHMANATHAN, M., BAUER, P. and MASTROMAURO, R. A. Charging Infrastructure and Grid Integration for Electromobility. *Proceedings of the IEEE*, April 2023, vol. 111, no. 4, pp. 371-396.
- [37] TU, H., FENG, H., SRDIC, S. and LUKIC, S. Extreme fast charging of electric vehicles: A technology overview. *IEEE Trans. Transport. Electrific*, December 2019, vol. 5, no. 4, pp. 861-878.
- [38] FOOTE, A. and ONAR, O. C. A review of high-power wireless power transfer, in *IEEE Transportation Electrification Conference and Expo (ITEC)*, Chicago, IL, USA, 2017.
- [39] Wolfspeed, "Implementing Fast DC Chargers with Silicon Carbide MOSFETs" Mouser, February 2022 [Online]. Available: <https://www.mouser.com/blog/implementing-fast-dcchargers-sic-mosfets>. [Accessed: 25 September 2023].
- [40] International Energy Agency, "Grid-scale Storage" [Online]. Available: <https://www.iea.org/energy-system/electricity/grid-scale-storage#tracking>. [Accessed: 25 September 2023].
- [41] CASTELLAZZI, A., GURPINAR, E., WANG, Z., SULIMAN HUSSEIN, A. and GARCIA FERNANDEZ, P. Impact of Wide-Bandgap Technology on Renewable Energy and Smart-Grid Power Conversion Applications Including Storage. *Energies*, 2019, vol. 12, no. 23, p. 4462.
- [42] TIWARI, S., UNDELAND, T., MIDTGÅRD, O. M. and NILSEN, R. SiC MOSFETs for Offshore Wind Applications, in *Journal of Physics: Conference Series, EERA DeepWind'2018, 15th Deep Sea Offshore Wind R&D Conference*, Trondheim, Norway, 2018.

- [43] FARIVAR, G. G., MANALASTAS, W., TAFTI, H. D., CEBALLOS, S., SANCHEZ-RUIZ, A., LOVELL, E. C., KONSTANTINOY, G., TOWNSEND, C. D., SRINIVASAN, M. and POU, J. Grid-Connected Energy Storage Systems: State-of-the-Art and Emerging Technologies. *Proceedings of the IEEE*, 2023, vol. 111, no. 4, pp. 397-420.
- [44] MENG, L., ZAFAR, J., KHADEM, S. K., COLLINSON, A., MURCHIE, K. C., COFFELE, F. and BURT, G. M. Fast Frequency Response From Energy Storage Systems – A Review of Grid Standards, Projects and Technical Issues. *IEEE Transactions on Smart Grid*, 2020, vol. 11, no. 2, pp. 1566-1581.
- [45] BMW Group, “More performance, CO₂-reduced production, significantly lower costs” Sept 2022 [Online]. Available: <https://www.press.bmwgroup.com/global/article/detail/T0403470EN/more-performance-co2-reduced-production-significantly-lower-costs:-bmw-group-to-use-innovative-round-bmw-battery-cells-in-neue-klasse-from-2025?language=en> [2]. [Accessed: 25 September 2023].
- [46] Mercedes-Benz Group, “Mercedes-Benz Cars aims to slash CO₂ emissions by more than 50% by end of this decade” April 2022 [Online]. Available: <https://group.mercedes-benz.com/investors/events/2022-mercedes-benz-group-esg-conference.html>. [Accessed: 25 September 2023].
- [47] HALL, D. and LUTSEY, N. “Effects of battery manufacturing on electric vehicle life-cycle greenhouse gas emissions” February 2018 [Online]. Available: <https://theicct.org/publication/effects-of-battery-manufacturing-on-electric-vehicle-life-cycle-greenhouse-gas-emissions/>. [Accessed: 25 September 2023].
- [48] ROMARE, M. and DAHLLÖF, L. “The Life Cycle Energy Consumption and Greenhouse Gas Emissions from Lithium-Ion Batteries” IVL Svenska Miljöinstitutet, 2017 [Online]. Available: <https://www.energimyndigheten.se/globalassets/forskning--innovation/transporter/c243-the-life-cycle-energy-consumption-and-co2-emissions-from-lithium-ion-batteries-.pdf>. [Accessed: 25 September 2023].
- [49] Boston Consulting Group, “Automotive Industry Semiconductor Outlook” October 2022. [Online]. Available: <https://web-assets.bcg.com/5e/f8/953dc62240ddb4207dd751edda86/tracking-the-next-phase-of-the-automotive-semiconductor-shortage.pdf>. [Accessed: 25 September 2023].
- [50] RAJASHEKARA, K. Present Status and Future Trends in Electric Vehicle Propulsion Technologies. *IEEE Journal of Emerging and Selected Topics in Power Electronics*, 2013, vol. 1, no. 1, pp. 3-10.
- [51] DARYANANI, S. “Reliability and Quality Requirements for SiC and GaN Power Devices in Automotive Applications” Power Electronics News, November 2022 [Online]. Available: <https://www.powerelectronicsnews.com/reliability-and-quality-requirements-for-sic-and-gan-power-devices-in-automotive-applications/>. [Accessed: 25 September 2023].
- [52] CHAKRAVARTHY, B. K. and SREE LAKSHMI, G. Power Savings with all SiC Inverter in Electric Traction applications. *E3S Web of Conferences*, 2019, vol. 87, p. 01014.
- [53] FEDISON, J. “SiC MOSFETs Enable Electric Vehicles with Enhanced Performance” 2019 [Online]. Available: https://www.ieee.li/pdf/viewgraphs/sic_mosfets_enable_electric_vehicles_with_enhanced_performance.pdf. [Accessed: 25 September 2023].
- [54] Semiconductor Today, “Infineon launches first automotive-qualified SiC six-pack power module for EV traction inverters” March 2021 [Online]. Available: https://semiconductor-today.com/news_items/2021/may/infineon-030521.shtml. [Accessed: 25 September 2023].

Bibliography

- [55] G. BUTICCHI, P. WHEELER and D. BOROYEVICH, "The More-Electric Aircraft and Beyond" *Proceedings of the IEEE*, 2023, vol. 111, no. 4, pp. 356-370.
- [56] WHEELER, P. and BOZHKO, S. "The more electric aircraft: Technology and challenges" *IEEE Electrific. Mag.* vol. 2, no. 4, pp. 6-12, 2014.
- [57] Aerospace Technology Institute, "Insight: Electric Power Systems" 2019 [Online]. Available: https://www.ati.org.uk/wp-content/uploads/2021/09/insight_07-electrical-power-systems.pdf. [Accessed: 25 September 2023].
- [58] Global Market Insights, "Low Voltage Drives Market Size" May 2022 [Online]. Available: <https://www.gminsights.com/industry-analysis/low-voltage-drives-market>. [Accessed: 25 September 2023].
- [59] Control Engineering, "Low voltage AC drive unit sales grow thanks to strong Asia market" January 2023 [Online]. Available: <https://www.controleng.com/articles/low-voltage-ac-drive-unit-sales-grow-thanks-to-strong-asia-market/>. [Accessed: 25 September 2023].
- [60] VIRTANEN, E., LANERYD, T., LENDENMANN, H. and NORDMAN, H. Thermal design aspects of subsea transformers, in *Cigre*, Paris, France, 2020.
- [61] Expert Market Research, "Global Arc Welding Equipment Market" [Online]. Available: <https://www.expertmarketresearch.com/reports/arc-welding-equipment-market>. [Accessed: 25 September 2023].
- [62] Markets and Markets, "Medical Power Supply Market" September 2022 [Online]. Available: <https://www.marketsandmarkets.com/Market-Reports/medical-power-supply-market-1208.html>. [Accessed: 25 September 2023].
- [63] International Energy Agency, "The Future of Cooling" Paris, 2018 [Online]. Available: https://iea.blob.core.windows.net/assets/0bb45525-277f-4c9c-8d0c-9c0cb5e7d525/The_Future_of_Cooling.pdf. [Accessed: 25 September 2023].
- [64] International Energy Agency, "Energy intensity of air conditioning units in the Announced Pledges Scenario, 2021-2060 [chart]" Paris, 2021 [Online]. Available: <https://www.iea.org/reports/an-energy-sector-roadmap-to-net-zero-emissions-in-indonesia/executive-summary>
- [65] Statista, "Number of data centers worldwide in 2022, by Country" [Online]. Available: <https://www.statista.com/statistics/1228433/data-centers-worldwide-by-country/>. [Accessed: 25 September 2023].
- [66] Statista, "Number of data centers worldwide in 2015, 2017, and 2021" [Online]. Available: <https://www.statista.com/statistics/500458/worldwide-datacenter-and-it-sites/>. [Accessed: 25 September 2023].
- [67] International Energy Agency, "Data Centres and Data Transmission Networks" 2023 [Online]. Available: <https://www.iea.org/energy-system/buildings/data-centres-and-data-transmission-networks#tracking>. [Accessed: 25 September 2023].
- [68] KORONEN, C. "Demand-response potential of large-scale data centers in Europe 2030" 2018 [Online]. Available: <https://lup.lub.lu.se/luur/download?func=downloadFile&recordId=8943713&fileId=8943716> [Accessed: 25 September 2023].
- [69] LAWRENCE, A. "Data center PUEs flat since 2013" Uptime Institute, April 2020 [Online]. Available: <https://journal.uptimeinstitute.com/data-center-pues-flat-since-2013/>. [Accessed: 25 September 2023].

- [70] SHI, Y., XU, B., WANG, D. and ZHANG, B. Using Battery Storage for Peak Shaving and Frequency Regulation: Joint Optimization for Superlinear Gains, in *IEEE Power & Energy Society General Meeting (PESGM)*, Portland, OR, USA, 2018.
- [71] KORONEN, C., ÅHMAN, M., and NILSSON, L. J. Data centres in future European energy systems—energy efficiency, integration and policy, *Energy Efficiency*, vol. 13, pp. 129-144, 2020.
- [72] SZE, S. M. *Physics of Semiconductor Devices*, 2nd ed. John Wiley and Sons (WIE), 1981.
- [73] IANNUZZO, F., Ed. *Modern Power Electronic Devices: Physics, Applications, and Reliability*, IET Publication, 2020.
- [74] BALIGA, B. J. *Wide Bandgap Semiconductor Power Devices: Materials, Physics, Design and Applications*, Elsevier, 2018.
- [75] MAJUMDAR, G. and TAKATA, I. *Power Devices for Efficient Energy Conversion*, 1st ed. New York: Pan Stanford Publishing, 2018.
- [76] LINDER, S. *Power Semiconductors*, EPFL Press, 2006.
- [77] LUTZ, J., SCHLANGENOTTO, H., SCHEUERMANN, U. and DE DONCKER, R. *Semiconductor Power Devices: Physics, Characteristics, Reliability*, Springer, 2011.
- [78] VOBECKY, J., VEMULAPATI, U., WIKSTRÖM, T., BOKSTEEN, B., DUGAL, F., STIASNY, T. and CORVASCE, C. Recent Progress in Silicon Devices for Ultra-High-Power Applications, in *International Electron Device Meeting (IEDM)*, San Francisco, CA, USA, 2021.
- [79] LADOUX, P., SERBIA, N. and CARROLL, E. On the Potential of IGCTs in HVDC, *IEEE Journal of Emerging and Selected Topics in Power Electronics*, 2015, vol. 3, no. 3, pp. 780-793.
- [80] Verified Market Research, *Global Insulated-Gate Bipolar Transistors (IGBTs) Market Size*. 2022.
- [81] IWAMURO, N. and LASKA, T. IGBT History, State-of-the-Art, and Future Prospects, *IEEE Trans. Electron Devices*, 2017, vol. 64, no. 3, pp. 741-752.
- [82] RAHIMO, M. and CARROLL, E. HV Silicon and SiC Power Semiconductors; Key Components for Sustainable Energy Solutions, in *PCIM Europe 2023; International Exhibition and Conference for Power Electronics, Intelligent Motion, Renewable Energy and Energy Management*, Nuremberg, Germany, 2023.
- [83] TAKAHASHI, H., YAMAMOTO, A., AONO, S. and MINATO, T. 1200V reverse conducting IGBT, in *Proceedings of the 16th International Symposium on Power Semiconductor Devices and ICs*, Kitakyushu, Japan, 2004.
- [84] PALMOUR, J. W. Silicon carbide power device development for industrial markets, in *IEEE International Electron Devices Meeting*, San Francisco, CA, USA, 2014.
- [85] FRIEDRICH, P. SiC MOSFETs, in *Advances in Semiconductor Technologies: Selected Topics Beyond Conventional CMOS*, A. Chen, Ed. Wiley – IEEE Press, 2022.
- [86] IMAIZUMI, M. and MIURA, N. Characteristics of 600, 1 200, and 3 300 V Planar SiC-MOSFETs for Energy Conversion Applications. *IEEE Transactions on Electron Devices*, vol. 62, no. 2, pp. 390-395, 2015.

- [87] RAHIMO, M. Performance Evaluation and Expected Challenges of Silicon Carbide Power MOSFETs for High Voltage Applications, in *Materials Science Forum*.
- [88] BABA, M., TAWARA, T., MORIMOTO, T., HARADA, S., TAKEI, M. and KIMURA, H. Ultra-Low Specific on-Resistance Achieved in 3.3 kV-Class SiC Superjunction MOSFET, in *33rd International Symposium on Power Semiconductor Devices and ICs (ISPSD)*, Nagoya, Japan, 2021.
- [89] UDABE, A., BARAIA-ETXABURU, I. and DIEZ, D. G. Gallium Nitride Power Devices: A State of the Art Review, *IEEE Access*, 2023, vol. 11, pp. 48628-48650.
- [90] Yole Group, "Power GaN 2022" May 2022 [Online]. Available: <https://www.yolegroup.com/product/report/power-gan-2022/>. [Accessed: 25 September 2023].
- [91] DOGMUS, E., CHIU, P. and AYARI, T. "SiC and GaN: an industry driven by different engines" Yole Group, December 2022 [Online]. Available: <https://www.yolegroup.com/strategy-insights/sic-and-gan-an-industry-driven-by-different-engines/>. [Accessed: 25 September 2023].
- [92] ZHANG, H., YUAN, L., TANG, X., HU, J., SUN, J., ZHANG, Y., ZHANG, Y. and JIA, R. Progress of Ultra-Wide Bandgap Ga2O3 Semiconductor Materials in Power MOSFETs, *IEEE Transactions on Power Electronics*, 2020, vol. 35, no. 5, pp. 5157-5179.
- [93] Yole Group, "Status of the Power Module Packaging Industry 2023" January 2023 [Online]. Available: <https://www.yolegroup.com/product/report/status-of-the-power-module-packaging-industry-2023/>. [Accessed: 25 September 2023].
- [94] MAJUMDAR, G., UENISHI, A., YOSHIDA, S., OHSHIMA, S. and ARITA, Y. New Generation High Performance Intelligent Power Module Series, in *Power Conversion*, 1992.
- [95] MAJUMDAR, G., FUKUNAGA, M. and ISE, T. Trends of intelligent power module. *IEEJ Trans Elec Electron Eng*, 2007, vol. 2, pp. 143-153.
- [96] CHIU, P., JAFFAL, A. and DOGMUS, E. "Compound semiconductor substrate market set to double: how are companies competing in this space?" Yole Group, April 2023 [Online]. Available: <https://www.yolegroup.com/strategy-insights/compound-semiconductor-substrate-market-set-to-double-how-are-companies-competing-in-this-space/>. [Accessed: 25 September 2023].
- [97] ZHANG, K., LEDUC, C. and IANNUZZO, F. Comparison of Junction Temperature Measurement Using the TSEP Method and Optical Fiber Method in IGBT Power Modules without Silicone Gel Removal, in *PCIM Europe 2023; International Exhibition and Conference for Power Electronics, Intelligent Motion, Renewable Energy and Energy Management*, Nuremberg, Germany, 2023.
- [98] Yole Group, "Power Gate Driver 2022" May 2022 [Online]. Available: <https://www.yolegroup.com/product/report/power-gate-driver-2022/>. [Accessed: 25 September 2023].
- [99] BOYD, S. B. *Life-Cycle Assessment of Semiconductors*, 1st ed. Springer, 2011.
- [100] KOLAR, J. W., KRISMER, F. and NEE, H. P. What are the "Big CHALLENGES" in Power Electronics?, Nuremberg, Germany: 8th International Conference of Integrated Power Electronics Systems (CIPS), 2014.

- [101] MUSIL, F., HARRINGER, C., HIESMAYR, A. and SCHOENMAYR, D. How Life Cycle Analyses are Influencing Power Electronics Converter Design, in *PCIM Europe 2023; International Exhibition and Conference for Power Electronics, Intelligent Motion, Renewable Energy and Energy Management*, Nuremberg, Germany, 2023.
- [102] SCHELLSCHEIDT, B., RICHTER, J. and LICHT, T. Life-Cycle Assessment for Power Electronics Module Manufacturing, in *22nd European Microelectronics and Packaging Conference & Exhibition (EMPC)*, Pisa, Italy, 2019.
- [103] BAUDAIS, B., BEN AHMED, H., JODIN, G., DEGRENNE N. and LEFEBVRE, S. Life Cycle Assessment of a 150 kW Electronic Power Inverter. *Energies*, 2023, vol. 16, no. 5, p. 2192.
- [104] MCDONALD, T. and BUTLER, S. W. "Wide Bandgap Quality and Reliability Standards: JEDEC Delivers!" Applied Power Electronics Conference (APEC), 2022 [Online]. Available: <https://www.pσμα.com/sites/default/files/uploads/node/7230/IS21.2.pdf>. [Accessed: 25 September 2023].
- [105] ZORN, C. and KAMINSKI, N. Acceleration of temperature humidity bias (THB) testing on IGBT modules by high bias levels, in *27th International Symposium on Power Semiconductor Devices & IC's (ISPSD)*, Hong Kong, China, 2015.
- [106] PETERS, J. H., HANF, M., CLAUSNER, S., ZORN, C. and KAMINSKI, N. Improved HV-H3TRB robustness of a 1700 V IGBT chip set in standard power modules, *Microelectronics Reliability*, November 2021, vol. 126, p. 114211.

Notes

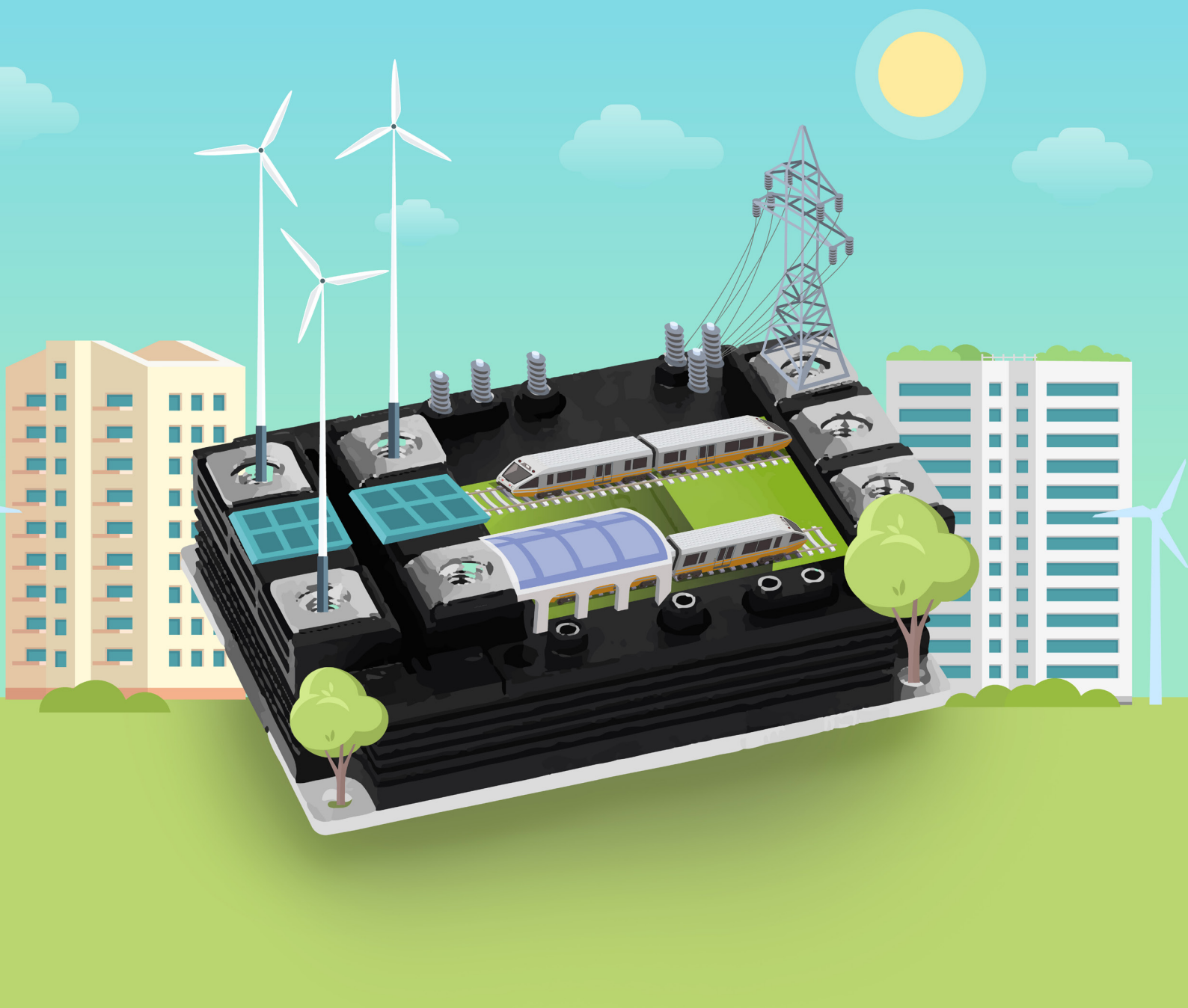

International
Electrotechnical
Commission

ISBN 978-2-8322-7718-8



CHF 50.-

3 rue de Varembé
PO Box 131
CH-1211 Geneva 20
Switzerland

T +41 22 919 0211
info@iec.ch
www.iec.ch

© Registered trademark of the International Electrotechnical Commission. Copyright © IEC, Geneva, Switzerland 2023