



AALBORG UNIVERSITY
DENMARK

Aalborg Universitet

Fault tolerant wind speed estimator used in wind turbine controllers

Odgaard, Peter Fogh; Stoustrup, Jakob

Published in:

8th IFAC Symposium on Fault Detection, Supervision and Safety of Technical Processes

DOI (link to publication from Publisher):

[10.3182/20120829-3-MX-2028.00009](https://doi.org/10.3182/20120829-3-MX-2028.00009)

Publication date:

2012

Document Version

Early version, also known as pre-print

[Link to publication from Aalborg University](#)

Citation for published version (APA):

Odgaard, P. F., & Stoustrup, J. (2012). Fault tolerant wind speed estimator used in wind turbine controllers. In *8th IFAC Symposium on Fault Detection, Supervision and Safety of Technical Processes* (pp. 331-336). Elsevier. <https://doi.org/10.3182/20120829-3-MX-2028.00009>

General rights

Copyright and moral rights for the publications made accessible in the public portal are retained by the authors and/or other copyright owners and it is a condition of accessing publications that users recognise and abide by the legal requirements associated with these rights.

- Users may download and print one copy of any publication from the public portal for the purpose of private study or research.
- You may not further distribute the material or use it for any profit-making activity or commercial gain
- You may freely distribute the URL identifying the publication in the public portal -

Take down policy

If you believe that this document breaches copyright please contact us at vbn@aub.aau.dk providing details, and we will remove access to the work immediately and investigate your claim.

Fault Tolerant Wind Speed Estimator used in Wind Turbine Controllers

Peter Fogh Odgaard * Jakob Stoustrup **

* *kk-electronic a/s, 7430 Ikast, Denmark (Tel: +45 21744963; e-mail: peodg@kk-electronic.com).*

** *Aalborg University, 9220 Aalborg East, Denmark (e-mail: jakob@es.aau.dk)*

Abstract: Advanced control schemes can be used to optimize energy production and cost of energy in modern wind turbines. These control schemes most often rely on wind speed estimations. These designs of wind speed estimators are, however, not designed to be fault tolerant towards faults in the used sensors. In this paper a fault tolerant wind speed estimator is designed based on a set of unknown input observers, each designed to the different sets of non-faulty sensors. Faults in the rotor, generator and wind speed sensors are considered. The designed wind speed estimator is passive tolerant towards faults in the wind speed sensors, and faults in the generator and rotor speed sensors are accommodated by an active fault tolerant observer scheme in which the faults are detected and identified, and the observer corresponding to the non-faulty sensors are used. The potential of the scheme is shown by applying the proposed wind speed estimator to a simulation model of a wind turbine. Notice that since the faults are accommodated in the observer scheme the actual controller do not need to be adjusted or reconfigured to accommodate the sensor faults.

Keywords: Wind Turbines, Wind Speed Estimation, Fault Accommodation, Unknown Input Observer.

1. INTRODUCTION

In the process of minimizing the cost of energy generated by wind turbines, it is of high importance to increase the reliability of these wind turbines, and as well to use more advanced control schemes in order to optimize the energy production while keeping loads on the wind structure as low as possible. These advanced control scheme are among others based on information of the actual wind speed. This is most often obtained by estimates based on a number of measurements from the wind turbine, since the measurement of the wind speed is highly influenced by noise. Clearly such a wind speed estimator should be tolerant towards faults in the used sensors, in order to design the wind turbine control system with a high reliability.

In this perspective fault tolerant control and fault diagnosis of wind turbines are of high interest. In this paper the topic is to design to a wind speed estimator which is tolerant towards faults in the used measurements.

In Odgaard et al. [2011] a wind speed estimator, which is made robust towards uncertainties in the aerodynamic model of the wind turbine, is designed using an unknown input observer. In Odgaard and Stoustrup [2010] an unknown input observer based scheme is used to detect faults in a number of sensors around the drive train in the wind turbine which is relevant for the wind speed estimator.

The topic of the wind speed estimators for wind turbines have been studied extensively some examples are: Oestergaard et al. [2007] and Boukhezzar and Siguerdidjane

[2009]. These wind speed estimators are basically using different measurements from the wind turbine as input to a model based estimator, but none of them is dealing with detecting and accommodating faults in the used measurements.

In Odgaard et al. [2009] a benchmark model for fault detection and isolation and fault tolerant control of wind turbines was proposed. Faults in the rotor and generator speed sensors are included in this benchmark model. A wind speed estimator, however, is not included in the benchmark model control system.

In this paper a wind speed estimator tolerant towards the faults in the benchmark model is designed based on an unknown input observer, (for details on the unknown input observer see Chen and Patton [1999]). The wind speed estimator is designed to be tolerant towards faults in the rotor and generator speed sensors and as well the highly noisy wind speed measurement.

The proposed scheme is tested on the above-mentioned benchmark model. Only faults in the rotor and generator speed sensors are considered from the original benchmark model. These faults are modified and extended with two other combinations of sensor faults and a fault in the wind speed measurement.

In Section 2 the benchmark model of a wind turbine used in this work is presented, followed by the proposed unknown input observer based scheme in Section 3. The proposed scheme is tested in Section 4. A conclusion is drawn in Section 5.

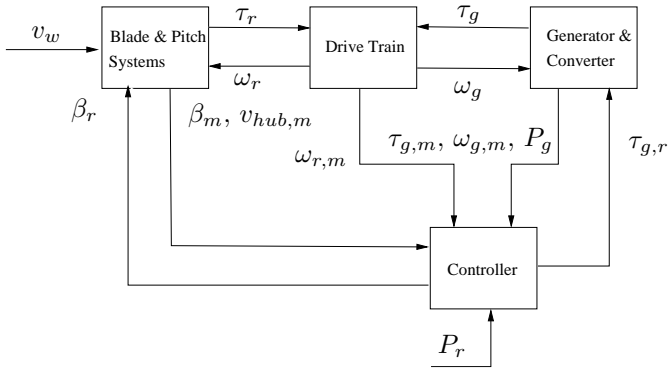

Fig. 1. This figure shows the overall model structure.

2. SYSTEM DESCRIPTION

This paper considers a generic wind turbine of 4.8 MW described in Odgaard et al. [2009]. This turbine is a variable speed three blade pitch controlled turbine, with a front horizontal rotor.

2.1 Wind Turbine Model

The used wind turbine model are from Odgaard et al. [2009], and is not described in details in this paper. The details can be found in the mentioned paper. An overview of the model can be seen in Fig. 1, in which v_w denotes the wind speed, τ_r denotes the rotor torque, ω_r denotes the rotor speed, τ_g denotes the generator torque, ω_g denotes the generator speed, β_r denotes the pitch angle reference, β_m denotes the measured pitch angle, $v_{hub,m}$ denotes the measured wind speed, $\omega_{r,m}$ denotes the measured rotor speed, $\tau_{g,m}$ denotes the measured generator speed, $\omega_{g,m}$ denotes the measured generator speed, P_g denotes the generated power, $\tau_{g,r}$ denotes the torque reference to the converter, and P_r denotes the power reference to the controller.

Each element of the model is shortly described in the following.

Wind Model The wind speed is given by a wind model including mean wind, turbulence, wind shear and tower shadow.

Aerodynamic and Pitch Actuator Model The blade aerodynamics and the pitch actuators are modeled in the Blade and Pitch System model, in which the pitch actuator is modeled as a second order transfer function with constraints. The aerodynamics is modeled by a static mapping from the pitch angle, rotor and wind speeds to the torque acting on the wind turbine rotor.

Drive Train Model The drive train, which is used to increase the speed from rotor to generator, is modeled with a flexible two-mass system. The drive train model includes the inertia of the rotor (which includes blades and the main shaft) and generator.

Generator and Converter Model The converter which controls the generator torque is modeled by a first order system with constraints. This model covers both the electrical behavior of the generator and converter.

Controller The wind turbine operates in principle in 4 Regions: Region 1 in which wind speeds are too low for the wind turbine to operate, Region 2 in which the turbine operates up to a nominal wind speed (partial load), Region 3 between nominal and rated wind speed, where the nominal power can be produced, Region 4 above rated wind speed, where the wind turbine is closed down in order to limit extreme loads on the wind turbine.

The controller is active in Region 2 & 3. In Region 2, in which optimal rotors speed is obtained by using the converter torque as control signal. In Region 3 the rotor speed is kept at a given reference value by pitching the blades, (the converter keeps the power at the reference taking care of fast variations in the speed). In this paper only the second region control is considered.

Sensor Models In addition a number of sensors are modeled as well. These are generator and rotor speed, pitch angles, wind speed, converter torque, electrical power. All the sensors are modeled as the measured variable added with random noise.

3. UNKNOWN INPUT OBSERVER BASED FT OBSERVER

The proposed Unknown Input Observer based Fault Tolerant Observer scheme consists of a bank of observer each designed for the different fault scenarios: No Faults (Observer 1), a fault in one rotor speed sensor (Observer 2), a fault in one generator speed sensor (Observer 3), faults in both rotor speed sensors (Observer 4), faults in both generator speed sensors (Observer 5), a fault in one generator speed sensor and one rotor speed sensor (Observer 6), a fault in the wind speed sensor (Observer 7). These unknown input observer are designed using the scheme presented in Chen and Patton [1999]. These 7 designs cover all faults considered in this paper.

The Fault Tolerant Observer scheme is tolerant to faults in the rotor and generator speed sensors by active selection of the observer corresponding to the healthy set of sensors. Faults in the wind speed sensors are accommodated by a passive fault tolerant design, since the observers in general are tolerant to uncertainties in the wind speed measurements.

The point in using this fault tolerant observer scheme is that the normal controller can be used in the case of faults in the sensors, simply since the fault tolerant observer scheme provides the best estimation of the feedback variables, given a set of healthy sensors.

It is assumed that the model of the wind turbine can be represented by discrete time state space model of the form.

$$\mathbf{x}[n+1] = \mathbf{A}_d \mathbf{x}[n] + \mathbf{B}_d \mathbf{u}[n] + \mathbf{E}_d \mathbf{d}[n] + \xi[n], \quad (1)$$

$$\mathbf{y}_j[n] = \mathbf{C}_{d,j} \mathbf{x}[n] + \eta[n], \quad (2)$$

where $\mathbf{x}[n]$ is the state vector, and

$$\mathbf{u}[n] = \begin{bmatrix} \tau_{g,r}[n] \\ \beta_r[n] \end{bmatrix}, \quad (3)$$

$\mathbf{y}_j[n]$ defines a vector of sensor signals, corresponding to the j th Observer. They are given below and for those

coefficients without a number it indicates that only one of these sensors are healthy.

$$\mathbf{y}_1 = \begin{bmatrix} \omega_{r,m1}[n] \\ \omega_{r,m2}[n] \\ \omega_{g,m1}[n] \\ \omega_{g,m2}[n] \\ v_{hub,m}[n] \end{bmatrix}, \quad (4)$$

$$\mathbf{y}_2 = \begin{bmatrix} \omega_{r,m}[n] \\ \omega_{g,m1}[n] \\ \omega_{g,m2}[n] \\ v_{hub,m}[n] \end{bmatrix}, \quad (5)$$

$$\mathbf{y}_3 = \begin{bmatrix} \omega_{r,m1}[n] \\ \omega_{r,m2}[n] \\ \omega_{g,m}[n] \\ v_{hub,m}[n] \end{bmatrix}, \quad (6)$$

$$\mathbf{y}_4 = \begin{bmatrix} \omega_{g,m1}[n] \\ \omega_{g,m2}[n] \\ v_{hub,m}[n] \end{bmatrix}, \quad (7)$$

$$\mathbf{y}_5 = \begin{bmatrix} \omega_{r,m1}[n] \\ \omega_{r,m2}[n] \\ v_{hub,m}[n] \end{bmatrix}, \quad (8)$$

$$\mathbf{y}_6 = \begin{bmatrix} \omega_{r,m}[n] \\ \omega_{g,m}[n] \\ v_{hub,m}[n] \end{bmatrix}, \quad (9)$$

$$\mathbf{y}_7 = \begin{bmatrix} \omega_{r,m1}[n] \\ \omega_{r,m2}[n] \\ \omega_{g,m1}[n] \\ \omega_{g,m2}[n] \end{bmatrix}. \quad (10)$$

$\mathbf{d}[n]$ is a vector of unknown inputs (which includes the uncertainty of the wind speed), $\xi[n]$ defines the process noise, $\eta[n]$ defines the measurement noise. The discrete time model matrices are given as \mathbf{A}_d , \mathbf{B}_d , \mathbf{E}_d , and $\mathbf{C}_{d,j}$ which denotes the \mathbf{C}_d matrix for the j th observer.

The unknown input observer in the discrete time form is given by (11-12), in this formulation of the observer the subscript index j refers to the observer number.

$$\mathbf{z}[n] = \mathbf{F}_j \mathbf{z}[n-1] + \mathbf{T}_j \mathbf{B}_d \mathbf{u}[n-1] + \mathbf{K}_j \mathbf{y}_j[n-1], \quad (11)$$

$$\hat{\mathbf{x}}[n] = \mathbf{z}[n] + \mathbf{H}_j \mathbf{y}_j[n], \quad (12)$$

where $\mathbf{z}[n]$ is the observer state vector,

The following matrices are computed once.

$$\mathbf{H}_j = \mathbf{E}_d (\mathbf{C}_{d,j} \mathbf{E}_d)^{-1}, \quad (13)$$

$$\mathbf{A}_j^1 = \mathbf{A}_d \mathbf{H}_j \mathbf{C}_{d,j} \mathbf{A}_d, \quad (14)$$

$$\mathbf{T}_j = \mathbf{I}_{3 \times 3} - \mathbf{H}_j \mathbf{C}_d. \quad (15)$$

The matrix $\mathbf{P}_j[0]$ is initialized to zero matrix.

For $n > 0$ the observer matrices are computed by

$$\mathbf{K}_j^1[n] = \mathbf{A}_j^1 \mathbf{P}_j[n-1] \mathbf{C}_{d,j}^T (\mathbf{C}_{d,j} \mathbf{P}_j[n-1] \mathbf{C}_{d,j}^T + \mathbf{R}_j), \quad (16)$$

$$\mathbf{F}_j[n] = \mathbf{A}_d - \mathbf{H}_j \mathbf{C}_{d,j} \mathbf{A}_d - \mathbf{K}_j^1[n] \mathbf{C}_{d,j}, \quad (17)$$

$$\mathbf{P}_j^P[n] = \mathbf{P}_j[n-1] - \mathbf{K}_j^1[n] \mathbf{C}_{d,j} \mathbf{P}_j[n-1] (\mathbf{A}_j^1)^T, \quad (18)$$

$$\mathbf{P}_j[n] = \mathbf{A}_j^1 \mathbf{P}_j^P[n] (\mathbf{A}_j^1)^T + \mathbf{T}_j \mathbf{Q} (\mathbf{T}_j)^T + \mathbf{H}_j \mathbf{R}_j (\mathbf{H}_j)^T, \quad (19)$$

$$\mathbf{K}_j[n] = \mathbf{F}_j[n] \mathbf{H}_j + \mathbf{K}_j^1[n], \quad (20)$$

All observers are computed at each sample but the vectors $\mathbf{x}[n]$ and $\mathbf{z}[n]$ are given as $\mathbf{x}_i[n]$ and $\mathbf{z}_i[n]$ where i corresponds to the Observer number accommodating the detected and isolated faults at sample n .

The FDI scheme from Odgaard and Stoustrup [2010] is used; this scheme is based on unknown input observers. This scheme detects the beginning and end of the faults are detected with a delay below 0.03[s], which is within the requirements given in the benchmark model, see Odgaard et al. [2009]. (This requirement cannot directly be transferred to the evaluation of the performance of this fault tolerant observer scheme, but shows that used FDI scheme is good enough to be used).

3.1 Design Model

The design model is based on the model used in Odgaard et al. [2011].

The wind turbine is modeled by the following dynamic model.

$$J_r \cdot \dot{\omega}_r(t) = \tau_r(t) - K_{dt} \cdot \theta_{\Delta}(t) - (B_{dt} + B_r) \cdot \omega_r(t) + \frac{B_{dt}}{N_g} \cdot \omega_g(t), \quad (21)$$

$$J_g \cdot \dot{\omega}_g(t) = \frac{\eta_{dt} K_{dt}}{N_g} \cdot \theta_{\Delta}(t) + \frac{\eta_{dt} B_{dt}}{N_g} \cdot \omega_r(t) - \left(\frac{\eta_{dt} B_{dt}}{N_g^2} + B_g \right) \cdot \omega_g(t) - \tau_g(t), \quad (22)$$

$$\dot{\theta}_{\Delta}(t) = \omega_r(t) - \frac{1}{N_g} \omega_g(t), \quad (23)$$

where: J_r is the moment of inertia of the low speed shaft, K_{dt} is the torsion stiffness of the drive train, B_{dt} is the torsion damping coefficient of the drive train, B_g is the viscous friction of the generator side shaft, and B_r is the viscous friction of the rotor side shaft, N_g is the gear ratio, J_g is the moment of inertia of the high speed shaft, η_{dt} is the efficiency of the drive train, and $\theta_{\Delta}(t)$ is the torsion angle of the drive train. The fault in terms of lower drive train efficiency is modeled by another parameter η_{dt2} .

where $\tau_r(t)$ is the aero-dynamical (rotor) torque, and it can be expressed as

$$\tau_r(t) = \frac{\rho \cdot A \cdot C_p(\beta(t), \lambda(t)) \cdot v_w(t)^3}{2 \cdot \omega_r(t)}, \quad (24)$$

where $\theta(t)$ is the pitch angle, $\lambda(t)$ is the tip speed ratio, ρ is the density of the air, and A is the swept area of the blades. The variables $\omega_r(t)$, $\omega_g(t)$ and $\tau_{g,r}(t)$ are measurable quantities. The wind speed $v(t)$ is measured as well, but its value is very inaccurate, since it should be the average over the entire swept area, and not a point measurement, and consequently it is estimated in this paper. The measured variables are denoted $\omega_{r,m}(t)$, $\omega_{g,m}(t)$ and $v_{hub,m}(t)$.

If this model is linearized, all changes in $C_p(\theta(t), \lambda(t))$ are replaced by $\Delta C_p(t)$. This notation is also used on other linearized variables, meaning that $\Delta \tau_{aero}(t)$, $\Delta \omega(t)$, and $\Delta v(t)$ are the linearized versions of $\tau_{aero}(t)$, $\omega(t)$ and $v(t)$ respectively. $C_{p,0}$, ω_0 , and v_0 are the point of operation for $C_p(\theta(t), \lambda(t))$, $\omega(t)$ and $v(t)$, respectively.

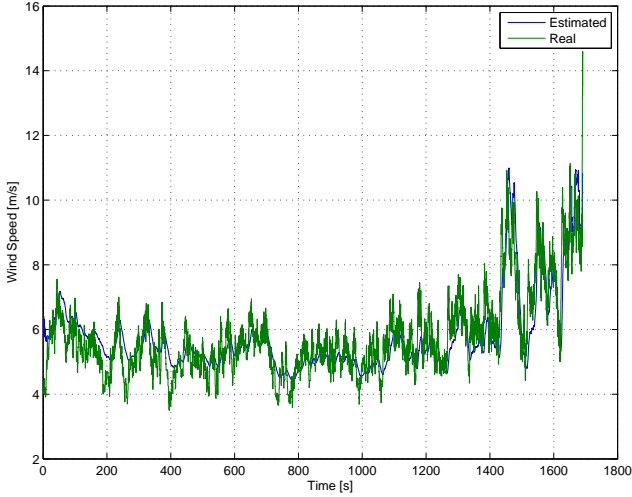

Fig. 2. This figure shows the performance of the Fault Tolerant Wind Speed estimator by comparing the estimate with the actual wind speed.

$$\begin{aligned} \Delta\tau_{\text{aero}}(t) = & -\frac{\rho \cdot A \cdot C_{p,0} \cdot v_0^3}{2 \cdot \omega_{r,0}^2} \Delta\omega_r(t) \\ & + \frac{\rho \cdot A \cdot v_0^3}{2 \cdot \omega_{r,0}} \Delta C_p(t) \\ & + \frac{3 \cdot \rho \cdot A \cdot C_{p,0} \cdot v_0^2}{2 \cdot \omega_{r,0}} \Delta v(t). \end{aligned} \quad (25)$$

In this content the power coefficient (C_p) and the wind speed are assumed to be unknown variables, which vary around a well-known set point. Changes in the C_p -surface would be very slow, meaning that the frequency content of the uncertain part of the C_p -value is in the region close to 0 rad/s. Compared to this, the changes in the wind speed will be located in a region with much higher frequency content, meaning that frequency separation can be assumed. Some DC- adjustment of the wind speed estimate might be necessary, simply by checking for too large values of C_p .

3.1.0.1. Implementation of the scheme The design is based on a discretized model of the design model derived based on the benchmark model. These matrices are \mathbf{A}_d , \mathbf{B}_d and \mathbf{C}_d . In addition three matrices are used in the specific design of the unknown input observer, which are used to tune the observer, these are \mathbf{E}_d , \mathbf{Q} and \mathbf{R} .

4. TEST AND SIMULATIONS

The wind speed sequence from the benchmark model is used. The faults are modified in order to test the different fault scenarios.

First the nominal performance of the wind speed estimator is compared with the actual speed in Fig. 2. The estimated wind speed is compared with the actual wind speed, from which it is seen that the estimated wind speed estimates the wind speed well.

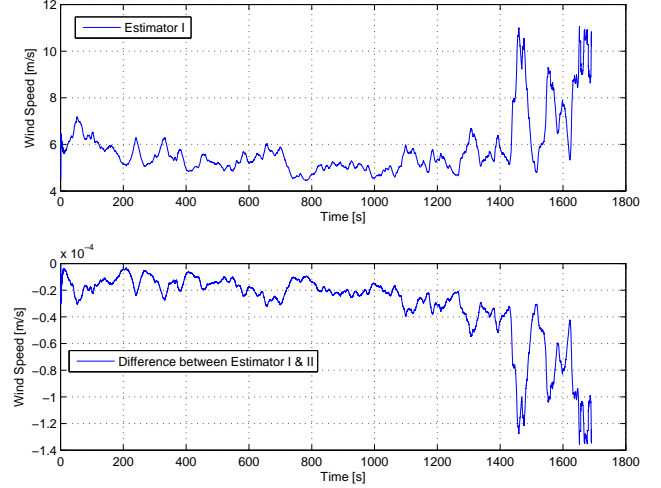

Fig. 3. This figure shows the performance of the Fault Tolerant Wind Speed estimator with and without with the wind speed measurement as input, which shows that the estimator is independent of the measured wind speed, a fault is present in the wind speed sensor in the time interval from 400s to 500s, which both estimates are not effected by.

The estimator is designed to be robust towards uncertainties in the wind speed measurement so the question is if the wind speed measurement, see Odgaard et al. [2011], is actually necessary or if it at all actually contributes to a better wind speed estimate. The wind speed estimate of Observer 1 (with all sensors) and Observer 7 (without wind speed sensor) where a fault is present in terms of an offset added to the wind speed measurement in the time interval 400s-500s, are compared in Fig. 3, which shows that the design itself is passive fault tolerant towards faults in the wind speed measurement, actually the wind speed measurement is not required for the estimator anyway.

The tolerances to the different combinations of rotor and generator speed faults are shown in Figs. 4 - 7. In Fig. 4 faults are present in both generator speed sensors in the time interval 750s-850s, from which it can be seen that using the fault tolerant estimator the variance during the fault is decreased.

In Fig. 5 faults are present in one rotor speed and one generator speed sensor in the time interval 1100s-1200s from which it can be seen that the fault tolerant estimator removes an offset at 0.05-0.1 m/s from the estimated compared with the non-fault tolerant estimator.

Figure 6 shows the result of a fault is present in a generator sensor in the time interval 1250s-1350s, from which it is seen that the fault tolerant estimator decreases the variance during the fault.

Figure 6 shows the performance of the fault tolerant estimator in presence of a fault in a rotor speed sensor, from which it can be seen that the fault tolerant estimator removes a small offset and an oscillation from the wind speed estimate during this fault.

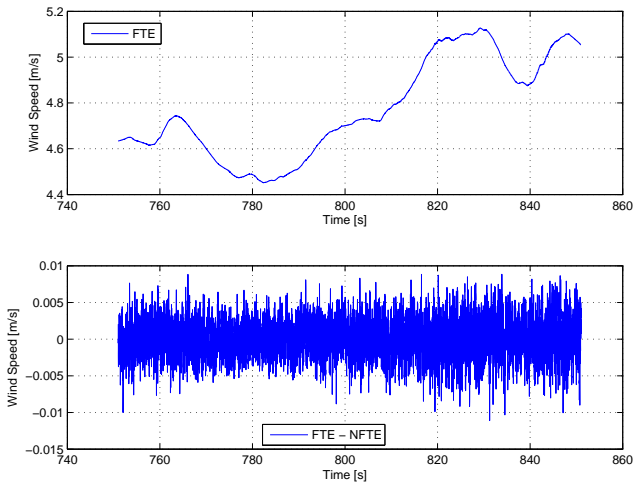

Fig. 4. The Fault Tolerant wind speed estimate compared with a non Fault Tolerant wind speed estimate for the fault present 750s-850s. The upper plot shows (FTE) which is the output of the fault tolerant observer, the lower plot shows the different between FTE and a non fault tolerant observer (NFTE).

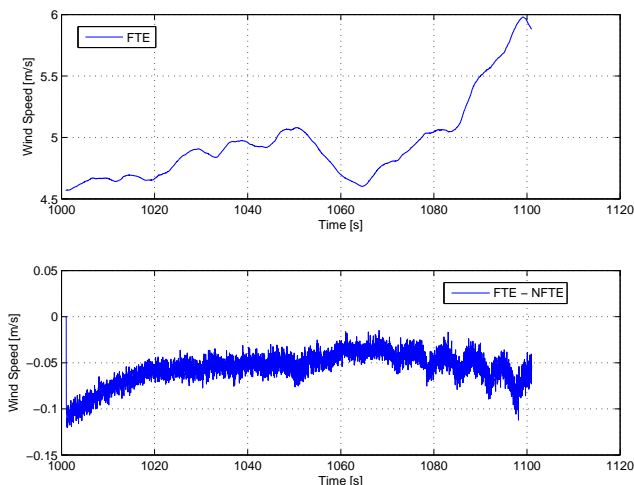

Fig. 5. The Fault Tolerant wind speed estimate compared with a non Fault Tolerant wind speed estimate for the fault present 1100s-1200s. The upper plot shows (FTE) which is the output of the fault tolerant observer, the lower plot shows the different between FTE and a non-fault tolerant observer (NFTE).

5. CONCLUSION

In this paper a fault tolerant wind speed estimator is designed for a wind turbine based on a unknown input observer. The wind speed estimator scheme is made fault tolerant towards faults in a number of relevant sensor signals, among these a noisy wind speed measurement is included. It is seen that the designed estimator is passively fault tolerant towards faults in the wind speed measurement and faults in the other sensors are accommodated based on an active fault tolerant scheme.

REFERENCES

B. Boukhezzar and H. Siguerdidjane. Nonlinear control with wind estimation of a dfig variable speed wind

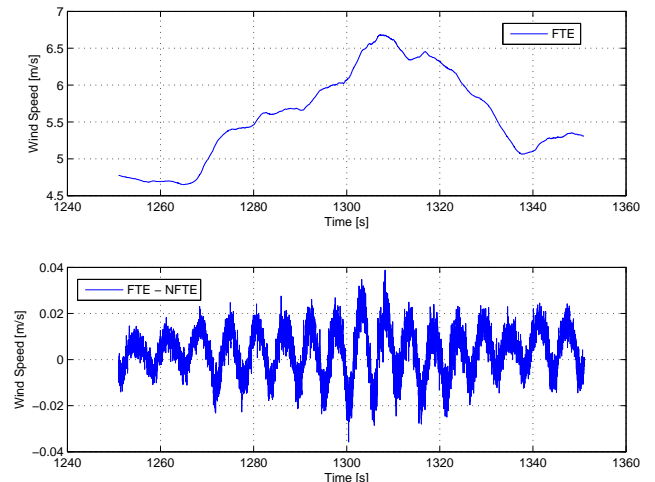

Fig. 6. The Fault Tolerant wind speed estimate compared with a non Fault Tolerant wind speed estimate for the fault present 1250s-1350s. The upper plot shows (FTE) which is the output of the fault tolerant observer, the lower plot shows the different between FTE and a non-fault tolerant observer (NFTE).

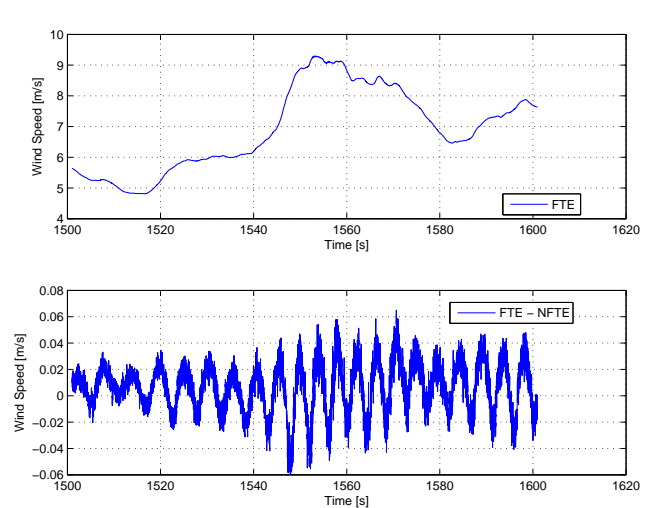

Fig. 7. The Fault Tolerant wind speed estimate compared with a non Fault Tolerant wind speed estimate for the fault present 1500s-1600s. The upper plot shows (FTE) which is the output of the fault tolerant observer, the lower plot shows the different between FTE and a non-fault tolerant observer (NFTE).

turbine for power capture optimization. *Energy Conversion and Management*, 50(4):885–892, April 2009. doi: 10.1016/j.enconman.2009.01.011.

Jie Chen and R. J. Patton. *Robust model-based fault diagnosis for dynamic systems*. Kluwer academic publishers, first edition, 1999.

P.F. Odgaard and J. Stoustrup. Unknown input observer based detection of sensor faults in a wind turbine. In *Proceedings of IEEE Multi-Conference on Systems and Control*, pages 310–315, Yokohama, Japan, September 2010. IEEE.

P.F. Odgaard, J. Stoustrup, and M. Kinnaert. Fault tolerant control of wind turbines a benchmark model. In *Proceedings of the 7th IFAC Symposium on Fault De-*

- tection, Supervision and Safety of Technical Processes*, pages 155–160, Barcelona, Spain, June-July 2009. IFAC. doi: 10.3182/20090630-4-ES-2003.0090.
- P.F. Odgaard, C. Damgaard, and R. Nielsen. Unknown input observer based estimation of wind speed for wind turbines control. In *In the proceedings of IFAC World Congress 2011*, volume 18, pages 1698–1703, Milan, Italy, August 2011. IFAC, IFAC. doi: 10.3182/20110828-6-IT-1002.00085.
- K.Z. Oestergaard, P. Brath, and J. Stoustrup. Estimation of effective wind speed. *Journal of Physics: Conference Series*, 75:1–9, 2007. doi: doi:10.1088/1742-6596/75/1/012082.